

\*

UMASS/AMHERST

\*

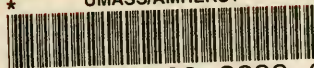

312066 0333 3299 2

LIBRARY

OF THE

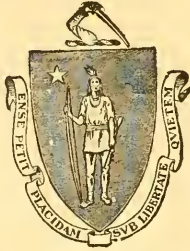

MASSACHUSETTS  
AGRICULTURAL  
COLLEGE

SOURCE











THE  
**British Bee Journal,**

AND BEE-KEEPERS' ADVISER.

EDITED BY

THOS. WM. COWAN, F.G.S., F.L.S., F.R.M.S., &c., AND W. BROUGHTON CARR.

---

VOLUME XXXI.

JANUARY-DECEMBER, 1903.

---

PUBLISHED BY

SIMPKIN, MARSHALL, HAMILTON, KENT, & Co., LIMITED,

23, PATERNOSTER ROW, E.C.

# INDEX.

**NOTES BY THE WAY.** By W. Woodley:—  
 Bee Houses and Store Rooms, 46  
 Bees Shaking Themselves, 293  
 Bee Tent Work, 211  
 Candy Making, 106  
 Dairy Show, 454  
 Driven Bees, 362  
 Frames, 23  
 Hives, 106  
 Honey Confections, 24  
 Honey Harvest, Our Chief, 144  
 Honey Jars, 272, 472, 511  
 Honey, Selling, 493  
 Insurance for Bee-keepers, 293, 416  
 Letting off Steam, 512  
 Making the most of the Season, 334  
 Marketing the Crop, 272  
 New Appliances, 334  
 Out Apiaries, 46  
 Rail Rates per "Goods" for Honey, 74, 106  
 Rearing Queens, 271  
 "Royal" Show, the, 243  
 Sections, Size of, 23  
 Sections, Tall, 106, 211  
 Sections, the Secret of Success, 255  
 Shook Swarms, 46  
 Shows and Showing, 472, 492, 512  
 Standard Frames, Wider, 293  
 Starving Bees, 334  
 Tits and Bees, 24  
 Trophy Class at Honey Shows, 46  
 Trophies of Honey, 2  
 Truant Swarms, 334  
 Wanted, a Frame, 2  
 Wax Extracting, 352  
 Wax Moth, 243, 272  
 Weed Foundation, 255  
 Work for Winter, 374, 416

Frames, Section Frames and Sections, 301  
 Heather Honies, 34  
 Hive, a, "Ne Plus Ultra," 484  
 Hive Roofs, 484  
 Intercommunication in the Hive, 362  
 June Frost, 232  
 Lignifying, 444  
 Loss of Bees in Transit, 383  
 Minor Sources of Honey, 54  
 Miserable May, 292  
 Monarch of the Hive, 14  
 Mother Bee, the, 34  
 Novel Bee-hive, 242  
 On the Hillside, 243  
 "Our Journal," 192  
 Placing Hives, 202  
 Plagiarisms in Ancient Bee Literature, 501  
 Pollination of Plants, 171  
 Queen up the Sleeve, 444  
 Radio Activity in the Bee-hive, 93  
 Rational Bee-culture, 14  
 Reminiscences: Sold!—My First Swarm!—Stung!—the good old Prices, 401, 402  
 Rymer Method, 242  
 Seasonable Notes—Tardy Spring, 201  
 Season, the Past, 484  
 Simple Nuclei Forming, 242  
 Some Interesting Statistics, 113  
 Spring Cleaning, the, 135  
 Strengthening Strong Stocks, 281  
 The Bee Nation, 262  
 They say—What say they?—Let them say, 484  
 Three Months' Imprisonment, 55  
 Ubiquitous Bee, the, 54  
 Wax and Wax Cakes, 484  
 What constitutes real Heather Honey? 74  
 Wintering Statistics, 463  
 Wrath of the Bee, 323

**FOUL BROOD OF BEES.** By F. C. Harrison, Professor of Bacteriology, Ontario Department of Agriculture, Canada:—  
 Aristotle and other Authorities on its Origin, 31  
 Biological Characters, 51  
 Chilled Brood, 43  
 Economic Aspects, 71  
 Experiments on the Use of Drugs for Combating the Disease, 101  
 Geographical Distribution, 43  
 Legislation, 101  
 Organism, the, 44

Remedies, 72, 82, 91  
 Symptoms of the Disease, 42  
 Thermal Relations, 61  
 Toxins, 101  
 See also Dr. Lambotte's Investigations respecting the Microbe of Foul Brood, pages 102, 111, 122  
 Agricultural Hall, Honey Shows at the, 361, 381  
 American Lady Bee-Keepers: A Bee Man's Helpful Family, 157  
 Ants Attacking Hives, 517; Getting Rid of, 268  
 Apiaries, Divided, Insurance Scheme and, 470  
 Apiaries, Out, and Short Stores for Winter, 469  
 Apiary and Fruit Farm, a New, 394  
 Appliances, New, 334; Using Suspected, 277  
 April, Moving Bees in, 137  
 Autumn, Candy Feeding in, 439; Extracting Unsealed Honey in, 407  
 Bee and Honey Shows, 505, 518; Shows Advertised in B. B. J. during 1908, 483; Dealing with Prize Exhibits, 481, 493, a Suggestion, 513  
 Bee and Honey Shows: How to Encourage Entries, 503  
 Bee Book, an Old, 18  
 Bee Candy, Overdosing, 30  
 Bee Culture as an Industry in France, 340; Rational, 14; Taking up, 327  
 Bee Districts within 40 miles of London, 509  
 Bee-Driving, Beginners and, 517; Troubles of, 367  
 Bee Experiences, 427; New Start after Bad Beginning, 439  
 Bee Farming in Canada, a, 387; in Paraguay, 521  
 Bee Food, Medicating, 148, 199, 406; Soluble Phenyle for, 389  
 Bee Forage in Isle of Man, 47  
 Bee Goods, Buying: Careless Packing, 487  
 Bee House Windows, 499  
 Bee Houses and Store Rooms, 46; The Advantages of proper Bee-sheds, 18  
 Bee, Italian, Qualities of, 485  
 Bee Items, Interesting, 496, 507  
*British Bee Journal*: After Thirty Years, 171  
 Bee-Keepers' Association Meetings:—British, 12, 31, 81, 91, 121, 132, 141, 161, 211, 251, 291, 381, 411, 421, 431, 441, 451, 471, 511; Berkshire, 103; Bristol and District, 381; Bristol, Somerset, and South Glou-

cester, 81; Cheshire, Cornwall, 144; Cumberland, 181; Derbyshire, 418; Devon, 41, 341; Driffield, Essex and Suffolk, 104; Glamorgan, 143, 391; Isle of Wight, 372; Hartlepool and District, Henbury, 382; Hereford, 111; Hunts, 292; Kent, Sussex, 134; Lancashire, 332, 342, 351; Leicestershire, 231; Lincolnshire, 161, 291; Northampton, 105, 331; North Norfolk, Northumberland, and ham, 143; Nottingham, 372; Oxfordshire, Ramsey, 332; Shropshire, 341; Staffordshire, Surrey, 191, 391; Wiltshire, 134; Worcester, 51; Yeovil District, 342. See also "Shows."  
 Bee-Keepers and Insurances, 438; Insurance Schemes  
 Bee-Keepers in Conference the Village School, 467, 467, 477  
 Bee-Keepers to Consider An American Project  
 Bee-Keeping, a School, 426  
 Bee-Keeping and masters, 436, 457, 477  
 ing the Children, 436  
 Bee-Keeping for Cottages, 222  
 Bee-Keeping in Canada, Honey and Wax Production and Value of, Growth of the Industry  
 Bee-Keeping in Canada, 403; in Germany, 157; in Norfolk, 487; in the 504  
 Bee-Keeping: Its Educational Influences. By W. H. B.A., B.Sc.:—Introductory, 461; Mental Influences, Moral Gains, 481; Physical Educational Influences, 462  
 Bee-Keeping, Gardens, 366; Moot Points near Newcastle, Location, 38, 43  
 Bee-Keeping: Profits and Low Prices for, 506; Starting, 208  
 Bee-keeper's Queries, 406; Lecture to Children, £ s. d. of, 384; Working and, 383  
 Bee Notes from Australia, from Cheltenham, Ireland, 234; from Africa, 465; from

**AMONG THE BEES.** By D. M. M., Banff:—  
 Ancient Bee Man of Repute, an, 424  
 Autumn, Joining up the Stocks in, 323  
 Bee-keeping in Schools, 221  
 Bee Nation, the, 262  
 Bees and Flowers, 114  
 Bees Interchanging Hives, 202  
 Bees Requeening, 64  
 Bees Run Amuck, 13  
 Drones, 152  
 Egg-laying, Extraordinary, 135  
 Encyclopedic Schoolmasters, 445  
 English Swarms, 281



- As: An Echo Up to Date, 163  
 Paralysis or Foul Brood? 163  
 Sulphur Cure a Success, 163  
 Bees, 163, 407  
 Scout, the, 363  
 Kings, Effect of, 137  
 Wagon, Using up Old, 138  
 Tent Work, About, 196, 212  
 the Mother, 34; the  
 Squeaky, 54  
 Queens and Storing for  
 Winter, 276  
 Queen's Difficulties, a, 396;  
 Troubles of, 306; Various  
 Cases, 410  
 The Novel, 242  
 Alien, introducing Queens  
 from, 288  
 and Brood cast out of  
 the hive, 288  
 and Combs from Skeps to  
 Hives, Transferring,  
 288  
 and Flowers, 127; Beauty  
 Borders and Honey for  
 the, 288  
 Hives and Horses, 143; and  
 the, 207; and Poultry,  
 207; and Preservation of,  
 207; and Red Clover,  
 207; and their Roes, 517  
 and their Ways, 340; Total  
 stinence, 419, 427; Wax  
 Health, 255  
 and a Parting Word for the,  
 419  
 as Teachers, 419  
 at Ajanta Caves, 139  
 at shows, Confining, 68  
 attacking Poultry, 257  
 Balling Queens in Spring,  
 169  
 Busy at an Auction, 169  
 Carniolan, 186  
 Changing in Temper, 129  
 Collapsing in May from  
 want of Food, 183  
 Condemned, how to De-  
 stroy, 27, 77  
 Deserting Hive, 237; after  
 Holiday Robbed, 218; in April,  
 50  
 Deserting Skep in Winter,  
 169  
 Destroying Condemned, 97  
 Driven, 362; Building up  
 skeps from, 347, 398  
 Dwindling in Spring, 215;  
 arising from Starvation, 199;  
 Dying in Spring, 163; in  
 duct after through Unwholesome  
 Swarms, 177  
 Examining a Dead Mouse,  
 397  
 Killing Brood-nest with  
 the Nosey, 277  
 for Transit, Packing: from  
 active Sellers' point of view,  
 Hants for Winter Packing; Pre-  
 packing Queens in "Wells"  
 for, 362  
 from Tiled Roof, Clearing,  
 169  
 Home, a Cornish, 525  
 Hybridising, 179  
 in Attics, Keeping, 208;  
 453; in Church, 449; in Mid-Corn-  
 wall, 355; in Hertfordshire,  
 186; in Ireland, 272; in Ross-  
 of-shire, 466; in Uganda, 80  
 Horn Skeps, Feeding, 519  
 a Bee in Transit, loss of, 394  
 in Wiltshire, 525  
 in Winter, Feeding, 8;  
 preparing for Wintering, 388;  
 serving both Queens in  
 the Hives, 386, 392  
 Leather-Coloured Italian,  
 186  
 Moving, 198, 348; Mum-  
 mified, 169  
 Bees near London, Keeping, 70  
 Bees not Sealing Brood, 158  
 Bees on Cross-Built Combs  
 transferring themselves in  
 August, 357  
 Bees out of Honey-Extracting  
 House, Getting, 158  
 Bees, Poultry *versus*, 348  
 Bees, Queenless and Broodless  
 in April, 175  
 Bees, Requeening, 54  
 Bees Killing off Drones in May,  
 208  
 Bees refusing to enter Sections,  
 293; to work in Sections, 313  
 Bees Robbing in India, 418;  
 Robbing Nuclei, 293  
 Bees run amuck, 13  
 Bees, Selecting the Best, 47  
 Bees Shaking Themselves, 293  
 Bees "Shaking" and "Driving,"  
 97, 118, 129  
 Bees Starving, 334  
 Bees, Stingless, of North and  
 South America, 124  
 Bees Tectotallers are, 457  
 Bees, Temper of, in South  
 Africa, 514  
 Bees, Three months' imprison-  
 ment of, 55  
 Bees, Tits and, 24  
 Bees to Heather, Taking, 274  
 Bees, Transferring, 49, 70, 149,  
 287; from Bucket, 178; to  
 Frame Hives, 43; Transferring  
 Themselves, 89, 263, 267, 343  
 Bees to Transfer Themselves,  
 Allowing, 168, 267  
 Bees Troublesome in Gardens,  
 407  
 Bees under Glass: Experiments  
 in Cornwall, 162  
 Bees uniting of themselves  
 in "Wells" Hives, 59; to  
 Weak Stocks, 317  
 Bees, Vicious, dealing with,  
 317; Getting Rid of, 110  
 Bees, Wintering, 278  
 Beginner, a Young, 365  
 Beginner's Difficulties, a, 297;  
 Experience of 1903, a, 375;  
 Needing Advice, 385; Queries,  
 287, 368, 469  
 Bell Glass Supers, 129  
 Bradford as a Bee District, 137  
 Breakdown, a, 282  
 Breeding, Stimulating, Early:  
 Why Feed Sparingly and  
 Often? 215  
 British Bee Journal Discussions,  
 8; The Bee Journal in the  
 Antipodes, 296  
 British B.K.A. Conference with  
 County Representatives, 411,  
 466, 421; Conversazione, 431,  
 441, 451; see also 1, 31, 81, 91,  
 121, 161, 211, 251, 291, 381, 471  
 British Bee Keepers' Associa-  
 tion Exams, 224; Expert's  
 Report, 19, 12, 12; Conversa-  
 zione, 132, 141, 447, 451  
 British *versus* Foreign Honey,  
 23  
 Brood Combs and Feeding in  
 Spring, 158  
 Brood, Dead, in Combs, 347  
 Brood, Spreading: Its Dangers  
 and Advantages, 233  
 Brood in Surplus Chambers, 397  
 Bucks, North, the Season in, 437  
 Bumble Bees and Lime Bloom,  
 357  
 Call Glass, a B.K.A. for, 38  
 Calluna Vulgaris and Honey, 34  
 Camphor *versus* Foul Brood, 274,  
 284  
 Candy and Artificial Pollen  
 Feeding in February, 79  
 Candy-making, Fermenting  
 Honey for, 449; see also 76,  
 105, 470; Notes on, 483  
 Carbolium as Hive Paint, 235  
 Carbolic Acid, Crude: Use of  
 in Foul Brood, 24, 37  
 Carniolan Bees and Dark  
 Honey, 383  
 Carniolan Queens, 4  
 Cheltenham, a Bee Note from,  
 118  
 China, Beekeeping in, 323  
 Chorley, Honey Show at, 332  
 Christmas, Drones at, 8  
 Clarifying Dark Honey: an  
 interesting Experiment, 393,  
 442  
 Clover, White, Moles and, 203  
 Colonies, Strong, 125; and  
 Management, 115; How to get  
 them at the Right Time,  
 76; the Value of, and how to  
 Secure them, 56, 64, 106, 116;  
 Uniting in Autumn, 163  
 Comb Foundation, Bees Refus-  
 ing, 460; Ordering, 286; Using  
 Old, 49  
 Combs and Bees, Transferring,  
 277  
 Combs and Food from Hive  
 inserted in February, Using,  
 78  
 Combs Cleaned after Extract-  
 ing, 439  
 Combs from Hives in which  
 Bees have Died, Using, 99  
 Combs in Hives, Mis-built, 136;  
 Renewing, 79, 203  
 Combs, Mildewed, Dealing with,  
 417  
 Combs, Old, Danger of Buying,  
 58; Wax from, 49  
 Combs, Replacing Mis-built,  
 157; Store, Rack for, 76  
 Confectioners' and Allied  
 Trades' Exhibition, 361  
 Conference of Bee-keepers and  
 Technical Education, 450; a  
 Village Schoolmaster's Chal-  
 lenge, 448  
 Congress of Beekeepers at  
 Strasburg, 162  
 Conversations with Doolittle:  
 "Balled" Queens, 9; Late-  
 reared Queens, 403; Uni-  
 formity in Hives, &c., 518  
 Cork (Greater) International  
 Exhibition, 1903, 162  
 Cottagers, selling Hives to, on  
 the Easy Payment System,  
 446  
 Crocus yield Honey? Does the,  
 167  
 Curious Case, a, 195  
 Dairy Show, the, 401, 415, 464;  
 a Word on the Awards, 426  
 Dead Brood in Combs, 347  
 Decoy Hives and Decamping  
 Swarms, 306  
 Derbyshire, Bee Notes from,  
 468; the Season in, 336  
 Devon, the Bee Season in, 488  
 Disinfecting Combs and Hives:  
 Formaldehyde and Foul  
 Brood Spores, 226  
 Disinfecting, Sulphur for, 356  
 Doubling and Storing, 207  
 Driven Bees, Building up Stocks  
 from, 389  
 Driving and Uniting Bees, 357  
 Drone Breeding Stocks, Dealing  
 with, 209  
 Drone Brood found in Worker  
 Cells, 183  
 Drone Pupa cast out, 326  
 Drones at Christmas, 8; Keep  
 the Hive Warm, 332; late, 418;  
 late, 429; Trapping, 30  
 Dual B.K. Associations: Advan-  
 tages of Separation, 475  
 Echoes from the Hives, 77  
 Egg Laying Extraordinary, 135  
 Entrances, Size, 485  
 Erica cinerea as a Honey  
 yielder, 34  
 Essex, a good Season in, 313;  
 Agricultural Society: Show at  
 Bishop's Stortford, 241; Notes,  
 107; New Tall Section, 207  
 Expert, the Work of the: What  
 he is expected to do, what he  
 does, what he should do, 296  
 Experts a Jury of, 301; and  
 Foul Brood: Use of Crude  
 Carbolic Acid, 24, 37; Visits  
 and Foul Brood, 75  
 Extracting Unsealed Honey in  
 Autumn, 407  
 Failures, Our, 231, 257; Com-  
 bination Hives, 293  
 Feeding: Rapid and Late Breed-  
 ing, 376  
 Feeders: Rapid *v.* Slow, 327;  
 Stimulatives, 49  
 Fermentation, Preventing, 499  
 Fertile Workers and Queen in  
 same Hive, 69  
 Floor Boards and Frames, fixed,  
 119  
 Formaldehyde, 363, 403; and  
 Foul Brood, 282, 416; and  
 Foul Brood Spores, 243; for  
 Disinfecting Combs, 376; for  
 Fumigating Combs, 354; *ver-*  
*sus* Foul Brood, 336, 344, 354  
 Formalin or Formaldehyde, 241  
 Foul Brood, 101; an American  
 Bee-keeper's Views, 39; and  
 Large Apiaries, 387; an Ex-  
 perience of, 17; an Unusual  
 Case of, 405; Curing, 136;  
 Dealing with, 27, 37, 178, 196,  
 237, 248, 258, 315, 317, 397; Dr.  
 Lambotte and, 122, 131; Dum-  
 my, a, 286, 295, 304, 314; Ex-  
 pert's Visits, and, 75; Helping  
 to Stamp Out, 217; Legisla-  
 tion: The Irish B.K.A. and  
 the Government, 439, Study  
 Swarms and, 356  
 Foundation, Comb-, and Bee-  
 house Windows, 499  
 Frame Cage, How to make a,  
 282  
 Frame Hives and Foul Brood  
 246; Starting Cottagers with,  
 439; Transferring Bees to, 43  
 Frame Question, the, 4, 15, 39,  
 43, 115; Cheap Home-made  
 Hives, 18  
 Frame already in Use, the, 16  
 Frame, Wanted, a, 2, 36  
 Frames, about, 57; Improved,  
 27; the "Standard," 23  
 Frames, Section-frames and  
 Sections, 301  
 Fruit, Sugar, Liquid—What is  
 it? 11, 21  
 Gardeners and Bee-keeping, 356  
 Germany, Bee-keeping in, 15,  
 154  
 Gleanings from Foreign Bee  
 Journals. By Dr. R. Hamlyn  
 Harris, D. Sc., F.R.M.S., &c.,  
 20, 69, 98, 139  
 Gooseberries, Do Bees Injure,  
 119  
 Grace Cell Compressor, the,  
 418  
 Granulation of Honey, 3  
 Groceries and Kindred Trades  
 Exhibition, 351; the Honey  
 Market, 392  
 Guide Book, New Edition of,  
 501  
 Hants, a Bee Note from, 353  
 Hants, South, a Note from, 223  
 Hartlepool and District,  
 B. K. A., 111  
 Heather Honey from Calluna  
 Vulgaris, or Common Ling,  
 103

- Heather Honey and Air Bubbles, 407
- Heather Honey, Sections for, 265, 296; Long Sections for, 266, 303; What constitutes Real, 74; Working for, 264; the Rymer Method, 336, 296
- Heather Honies: *Erica cinerea* and *Calluna vulgaris*, 34
- Heather Prospects, 336
- Heather Re-queening for, the 4
- Heather Sections, Price of, 37
- Heather, sending Hives to, the, 316; Taking Bees to, 274; Transporting to the, 324
- Heather, Varieties of, 364
- Heathers in the Isle of Man, 48
- Herefordshire, The Season in: a good Report, 416
- Herts, a good Season in, 417
- Hillside, On the, 343
- Hive, Intercommunication in the, 362
- Hive, Observatory: Fourth Season's Experience of, 55
- Hive Roofs, Covering for, 507
- Hive, the Monarch of the, 14
- Hive, the Ne Plus Ultra, 506
- Hives, 105; and Frames, 166; attending to, in advance, 58; Body Made, 203; Cheap Home-made, 18, 47, 174; Home-made, 126, 137, 147, 156, 174, 172, 500; Making, 49
- Hives, Cleaning, from Surplus Chambers, 129; for the Heather, preparing, 274; moving, fifty yards in March, 99; moving to Improved Bee Pasturage, 363; Non-Swarming, 197, 459, 500; on Scales, 456; Porous Coverings for, 418; Renewing Combs in, 79; Second-hand, buying, 266; with cross-built combs, 183
- Hives, close-ended Frames in, 509
- Hives, Dealing with Odd-sized, 510
- Hiving Swarms, *New versus Old Methods*, 447
- Ho! Sentinel! 236
- Hone Counties Nature Study Exhibition in 1938, 191
- Homes of the Honey Bee, see Illustrations
- Honey and Increase, Working for: an American Bee-keeper's Method, 405
- Honey at Shows, Grading, 346
- Honey Averages, Disbelief in, 490
- Honey, British *versus* Foreign, 26
- Honey Bee, Lecture to Children on the, 498
- Honey Cakes, Recipes for Making, 517
- Honeycomb Capping, Unknown Larvæ in, 313
- Honey Conditments, &c., 4; Confections, 24
- Honey, Dark, for Feeding Bees, 326
- Honey Dew as Bee Food, 137
- Honey, Does the Crocus Yield? 167
- Honey, Do Flowers Produce? 231
- Honey Exhibits: Their Value and Advantages, 358
- Honey-Extracting House: Getting Bees out of, 153
- Honey-Extracting in the Open, Trouble through, 397
- Honey Extractors, Galvanized Iron and, 308
- Honey, Fermentation of, 505
- Honey for Exhibition, Buying, 312; for Market, Packing, 237; for Showing, Grading, 357
- Honey, Granulation of, 3
- Honey Harvest in West Cornwall, 469
- Honey, Imports of Colonial, 29; Total for the year, 1902, 28, 48; Total Value of, Correspondence relating to, 48, 66
- Honey, Improving Flavour of, 337
- Honey in Lard Buckets, Keeping, 14, 17
- Honey Jars, 27, 511; Small, 315
- Honey Judging; Colour Grading, 345, 354; Judging Quality of, 78; Marketing, 214; Price of, 455, 469, 479, 483, 497, 503, 516; Prices of Foreign, 296
- Honey, Price, Purchase of, 524
- Honey, Railway Rates for, 87, 98, 106; per "Goods" for, 74
- Honey, Removing, Granulated from Shallow Frames, 339
- Honey Samples: Coloured Glasses for Grading Honey, 278
- Honey Season: Buying and Selling Honey Wholesale, 437; the past, in East Yorkshire, 428
- Honey, Selling, 473; Creating a Market, 497; How to get Best Prices, 28
- Honey, Selling: Some Excellent Suggestions to the Beginner, 338
- Honey Showing: Giving Beginners "a Chance," 67
- Honey Shows: Adlington, 351; Agricultural Hall, 361, 381, 401; Bishops Waltham, 311; Bramhall, 372; Buckden Towers, 292; Cardiff, 301; Cartmell, 351; Chew Magna, 331; Chorley, 342; Crystal Palace, 391; Derby, 371; Helsby, 311; Henbury, 332; Kingshorpe, 331; Leicester, 331; Lichfield, 321; Lincoln, 291; Llangollen, 351; Loughborough, 333; Melton Constable, 322; Moorgreen, 372; Nantwich, 323; Old Trafford, 321; Ramsey, 332; Shrewsbury, 341; Swanmore, 311; Swindon, 342; Tavistock, 341; Wallop, 322; Woodstock, 371; Yeovil, 342
- Honey Shows, Trophy Class at, 46
- Honey, Some Minor Sources of, 54; Storing, 308; Theft of, 339; the Uses of, 167; Trophies of, 2; Variation in, 48; Working for Extracted, 236
- Increase, Prevention of, 507
- India, Keeping Bees in, 336
- Insect Life, Photographing, 37
- Insects in Pollen Cells, 119
- Insurance for Bee-keepers, 221, 281, 293, 438, 456; Number of Hives Insured, 449; Insurance Scheme and Divided Apiaries, 470
- Investigations respecting the Microbe of Foul Brood, a Disease of Bees, by Dr. Ul. Lambotte, 102, 111, 122
- International Exhibition for Apiculture at Vienna, 134
- Isle of Man, Bee Storage in the, 47; Heathers in the, 48
- Judging at Honey Shows: a word on, 394
- Judging Honey, Points in, 453
- June Frost, a, 281
- Kent and Sussex, 134
- Kent (East) Notes, Some, 445; Position of the Kent and Sussex B.K.A., 467
- Lady Beginner's First Season, a, 403
- Lady Warwick College, Studley Castle, Warwickshire, 441
- Langdon's Non-Swarming Device, 304
- Lantern Slides for Lectures, 294
- Lard Buckets, Keeping Honey in, 14, 17
- "Larger Frame," that: Its Relation to "Management," 83
- Larvæ, Unknown, in Cappings of Honey Comb, 203
- Letting off Steam, 502, 512
- Lifts for Section Frames, Utilising, 40
- Ligurianising, 444
- Lime Bloom, Bumble Bees and, 357
- Liquid Fruit Sugar—What is it? 11, 21
- Livingstone, Dr., and Bees, 487
- London, Keeping Bees near, 70
- Luxembourg, International Exhibition at, 311
- Management for Beginners, 227
- Manipulations, Unseasonable, 216
- Marriage of Mr. William Herrod, 351
- Mead and Honey Cakes, Recipes for Making, 517
- Mid-Shropshire, a Note from, 66
- "Modern Bee-Keeping": A Book for Cottagers, 191
- Modern Bee-Keeping: Paper read at the Society of Arts, 176
- Moles and White Clover, 203, 224; How Mole Traps are Made, 195, 204, 224, 244
- Monarch of the Hive, the, 14
- Moors, On the, 35
- Mother Bee, the, 34
- Mr. Cowan's Return to England, 201
- Nectar-producing Wall Shrubs, 524
- Newcastle, Bee-Keeping near: A Location Wanted, 38, 48
- Non-Swarming, 86; Non-Swarming Hives and Non-Swarming Chambers, 509
- Northumberland, Season in, 496
- Novelties for 1903: the "Houghton" Ventilating Dummy-board, 89
- Novice's Troubles, a, 367
- Nuclei-Forming, Simple, 242
- Obituary: Death of Mr. William Carr, 253; Mr. C. M. Neabitt, J.P., 127; Mr. T. G. Newman, 151; Mr. David Raftit, 429; Mr. John Walton, 116
- Observatory Hive, the, 272; A Fourth Season's Experience, 55; Bees in, 302; Making an, 159, 238
- Old Combs, Danger of Buying, 58
- Old Year and the New, the, 1, 521
- Out Apiaries, 46
- Outfits for Beginners, 450
- Packing Bees for Transit, 417
- Packing, Careless, 505
- Packing Driven Bees, 449
- Painting Hives with "Carbolineum," 212
- Paraguay, Bee-farming in, 521
- Park Royal, Show at, 251, 261, 271
- Parting Word for the Bees, a, 175
- Passive Resistors, not, 437
- Pertshire, North, the, 95
- in, 399
- Phenely, Soluble, for, 389
- Photographing Insect, 37
- Pollen, Artificial, Feeding, 164
- Pollen Carrying and Queenness, 119
- Pollen Cells, Insects in, 16
- Pollination of Plants, 16
- Poultry *versus* Bees, 345
- Produce, how to Market, 366
- Propolis? do Bees Store the Storage of, 524
- Propolis as a Remedy for Wounds, 187
- Propolis: Its Pronunciation, 21
- Modern Greek, 448
- Pronunciation, a Question, 61
- "Pro," "Prop," or "Propolis"—which? 393; see also, 365, 402
- Queen and Bees, Loss, 25
- May, 216
- Queen and Fertile Worker, Same Hive, 69
- Queen Bee, Handling, 4
- Queen Bees to South Roy, Sending, 465
- Queen Cast Out Dead, 109
- Queen Ceasing to Lay, 149
- Queen Cells, Beginner's Removing, 279; in May, 138; Loss of Swarm, trying to, 243
- Queen Introduction, 16
- Queen, Loss of, in August, in Transferring, 336
- Queen Mating, 265, 271
- Queen Rearing and Cell Cups, 233
- Queen Rearing in America, 356
- Queen Up the Sleeve, 11
- Queenlessness, Pollen, and, 119
- Queenlessness, Suspense, and Uniting, 349
- Queenless Stocks, 315
- Queens, Carniolan, 4
- Queens, Clipped, 498
- Queens, Clipping, and Loss of Swarms, 476
- Queens, Duplicating, 187
- Queens, Falling, and Workers, 259
- Queens, Foreign, 228
- Queens, from Diseases, Utilising, 429
- Queens, Immature, after Swarming, 242
- Queens, Introducing, 419
- Queens, Leaving Hives, Flight, 277
- Queens, Mating, 271, 271
- Queens of Driven Bees, Preserve, 363
- Queens Ovipositing; Rearing by Workers, 273
- Queens to the U.S.A., 159
- Queries, A Lady, 326, 347, see also 106, 237, 245, &c.
- Quilts for Winter, 436, 485
- Radium, or Perpetual Railway Porter's Bee

- Railway Rates for Honey, 87, 108, 106; per "Goods" for Honey, 74
- Rainfall in 1902, 23
- Rain, Rain 1 324
- Ramsay (Isle of Man) Horticultural Society, 332
- Reviews: Bee-Keeper's Guide; Manual of the Apiary, 163; Forty years among the Bees, 248; Bee-keeping for Beginners, 452; The Book of the Honey Bee, 153
- Queening Bees, 54; for the Heather, 4; Hives, 327; Stocks, 79
- Queening, 429; Is it always necessary? 358
- Rheumatism, the Cure for, 213
- Robbing, Dangers of, 90
- Roll Call, the, 243
- Room in Advance of Requirements, Giving, 223
- Rothshire, Bees in, 466
- Royal Agricultural Society: Show at Park Royal, London, 251, 251, 271
- Royal Lancashire Agricultural Society: Show at Manchester, 261; Show at Old Trafford, Manchester, 321
- Royal Show of 1903, the: the Grouping of County Associations, 71
- Royal Show of 1903, the, 161, 264, 243; the "New Department," 96
- Royal Show Fund, 121, 181, 191, 203
- Ryder Method, the, 242, 294, 304, 312, 325; Working for Heather Honey, 264; Rymer Press, the, 233
- Schoolmasters and Bee Keeping, 447, 443, 457
- Schoolmasters, Encyclopædic, 445
- Season, Making the Most of, 334
- Season, the Past, 423
- Season Frames, 183, 301; Utilising "Lifts" for, 40
- Season Honey, Working for,
- Section Rack and Shallow Frame Box, 97, 109
- Section Boxes for "W.B.C." Hives, 217; in Non-Swarming Hives, 499
- Sections, Bees Refusing to Work in, 327; can Shallow Frame Boxes be adapted for Holdings, 59; Dealing with unfinished, 339; Feeding Bees for Competing, 363; Size of,
- Sections, Long, 214, 314; for Heather Honey, 235
- Sections, Tall, by the Rev. R. M. Lamb, 193; Reply by Mr. David Raitt, 212
- Sections, Tall, for Safe Transit, 90; see also 85, 106, 107, 146, 193, 211, 223, 302, 353
- Shallow Frame Boxes: can they be adapted for holding Sections, 69
- Shallow Frames under Brood Nest, 304
- "Shook" Swarms, 26, 46
- "Shook" or "Forced" Swarms, 253
- Shows and Showing, 504, 507, 512; Buying Exhibits, 507; Buying in Prize Exhibits, 513; Dealing with ditto, 512; Mr. Weston's Views, 523
- Shows, Confining Bees at, 63
- Shropshire, Bee - Keeping in, 353; Notes from South, 36
- Skep Apiary in Villa Garden, a, 318
- Skep Hives, Removing, after Transferring, 217
- Skep Honey, Dealing with, 348
- Skep to Frame Hives, Transferring, 186, 293, 459
- Skeps, Removing, after Transferring Bees, 223, 388
- Solar Extractor, the, 108
- Song of the Worker Bee, 50
- South Africa, Bee-keeping in, 329; Bee Notes from, 465
- Space below Frames in Hives, 357
- Spring, Management for Beginners, 247
- "Spring Radiations," 123
- Spring, the Breath of, 76
- Staffs, Brief Report from, 365
- Standard Frame, a Wider, 293
- Stock Headed by Worthless Queens, 227
- Stocks, Building up Strong: a Complaint against Faulty Hives, 133; Buying Diseased, 227; Dealing with Weak, 237; Diseased in June, Dealing with, 248; Drone Breeding, 233; from Driven Bees, Building up, 347; in Autumn, Joining up, 328; Italianising, 207; Ligurianising, 209; Queenless, Dealing with, 315; Re-queening, 79; Strengthening, Strong, 231; Weak: their Value as Auxiliary Boxes, 173
- Store Combs, Racks for, 76
- Store Rooms, Bee Houses and, 46
- Stores for Winter, Weight of, 318
- Suffolk, Good Honey Yield in, 323
- Sugar, Adulterated, 67
- Sulphur for Disinfecting Hives and Appliances, 356
- Super-Clearer, Making a, 138
- Surplus Chambers in November, Moving, 479, 490
- Sussex, the Season in, 354
- Swarm, an Early: the first recorded in 1903, 134; a Profitable, 285
- Swarm Catchers: a Beginner's Experience of them, 427; and Non-Swarming Hives, 179; Practical Value of, 139
- Swarm Chambers, Beginner's and, 316
- Swarm Located in Stone Wall, Destroying, 307
- Swarm Preventing, Bad Methods of, 237
- Swarming, Artificial, and Non-swarming, 266
- Swarming, Artificial, and Queen Raising, 323
- Swarming, Artificial, by Beginners, 329
- Swarming, Dealing with, 223; Deferred, 267, 268; Experiences, 284; Immature Queens Cast out after, 249
- Swarming Incidents, 296, 312, 314, 340
- Swarming, Preventing, 506; Is it Desirable? 345; see also 29, 168, 197, 354, 474; Prevention of when Working for Extracted Honey, 383; Profitable, 446; Troubles, 233; Undesirable, 257; Vagaries and "Hiving" Troubles, 313; for Vagaries, see also 257, 276, 303, 307, 328, 337, 345
- Swarms and Casts, Returning, 279
- Swarms, Artificial Making, 193, 288
- Swarms by Rail: Liability of Railway Companies, 489
- Swarms Clustering outside after Hiving, 337; Decamping, and Comb Honey in Frames, 314; English, 281; Feeding, after Hiving, 258; Joining of Themselves, 233; Loss of, 267; Profitable, 295; Re-queening, 298
- Swarms Decamping in South Africa, 510; Some Practical Experience, 514
- Swarms, Preventing Loss of, 516
- Swarms "Shook" or "Brushed," 38
- Swarms, Stray and Foul Brood, 356; Truant, 324, 334; Uniting, 307
- Swarms when Hiving, Identifying, 406
- Syrup, Boiling, 436; Surplus of, 439
- Teachers, Bees as, 419
- Tectotals, are Bees, 457
- Testimonial to Mr. J. M. Hooker, 23
- Tits and Bees, 24
- Topics, on Various, 523
- Trade Catalogues, 189, 199
- Transferring Bees from Odd-sized Frames to Standards, 325; from Skeps to Frame-hives, 337, 348; from Skeps to Non-swarming Hives, 459
- Transferring Difficulty, a, 58
- Transferring, a Beginner's Troubles in, 376
- Trophies of Honey, 2
- Trophy Class at Honey Shows, 46
- Truro, a Brief Note from, 365
- Uganda, Bees in, 30
- Uniting Bees for Renewing Queens, 526
- Various Topics, on, 523
- Village Schoolmaster and the Beekeepers' Conference, 425
- Wales, Good Honey in, 375
- Wall Shrubs, Nectar Producing, 524
- Wanted, a Frame, 2
- Wanted, a Frame—the Frame already in use, 16
- Wardenshire Notes, 456
- Wax Extracting, 352
- Wax from Old Combs, 49
- Wax Moth, 243; Bees and, 255
- Wax Destroying, 312
- Wax Production in Madagascar, 214
- "W.B.C." Hives, 438; Working the, 470
- "W.B.C." Section Rack, making the, 133
- Weather, the: a Grumble, 255; see also 19, 186, 226, 237, 315, 405
- "Wells" Hives: Artificial Swarming and, 499; Bees Uniting of themselves in, 59
- Winter: Are you ready for the— a Word of Advice, 434; Feeding and Preparing Bees for, 480; Feeding Bees in, 8; Out Apiaries and Short Stores for, 459
- Winter Passages: a Simple Home-Made Device, 477
- Wintering Statistics, 463
- Women's Dress for Bee Work, 346
- Women, Working, and Beekeeping, 338
- Word in Season, a, 341
- Workers, Fertile, and Failing Queens, 259
- Wounds, Propolis as a Remedy for Curing, 187
- Wychwood Forest, Notes from, 449
- Yorkshire Notes, 450

## ILLUSTRATIONS.

## Homes of the Honey Bee"—:

- Apiary of Rev. Thos. Adams, U.F.C.  
Manse, Cumbernauld,  
Scotland, 25
- „ Mr. John Arthars, Studley,  
Warwickshire, 45
- „ Mr. John M. Best, Trewoon,  
St. Austell, Cornwall, 475
- „ Mr. R. C. Blundell,  
"Benhams," Horley,  
Surrey, 335
- „ Mr. Thos. Boston, Barking,  
Essex, 115
- „ Mr. George Dow, St. Mary  
Cray, Kent, 495
- „ Mr. Thos. Evans, Waddes-  
don, Aylesbury, Bucks,  
395
- „ Mr. John Harris, Kelvedon  
Common, Brentwood,  
Essex, 65
- „ Mr. David W. Purdie, Brook-  
hill, Ettrick, Selkirkshire,  
205
- „ Mr. Thos. Richards, Church  
Gresley, Burton-on-Trent,  
Staffs, 515
- „ Mrs. Spencer, Holywell, St.  
Ives, Huntingdonshire, 95

## "Homes of the Honey Bee" (continued—

- Apiary of Mr. W. Ivan R. Sheppard,  
Chewton Mendip, Bath,  
Somerset, 275
- „ Mr. Peter Sutherland,  
Watten, Caitlness, N.B.,  
165
- „ Mr. H. Swift, Churchdown,  
Cheltenham, Gloucester-  
shire, 5
- „ Mr. J. D. Thorburn, Hooton,  
Cheshire, 35
- „ Mr. John Walton, "Honey-  
cott," Weston, 117
- „ Mr. Chas. Wells, Oxendon,  
Market Harborough,  
Northants, 225
- „ Mr. T. I. Weston, Wickham  
Bishops, Essex, 245
- „ Mr. H. Whitmore, Daventry,  
Northants, 355
- „ Mrs. J. Wootton, Widmer-  
pool, Notts, 135
- A Christmas Card from South Africa  
(An Examination), 526
- Beehives with Langdon Non-Swarmer  
attached, 305
- Bees in a Cornish Rabbit-hutch, 525
- Bees in House Roof, 175
- Frame Cage for Introducing Queens, 283

- German House-Apiaries for "Breech-  
loader" Hives, 155
- Heather, Different Varieties of, 364
- Home-made Winter Passage, 477.
- "Hoffman" Frame: its Construction  
shown by Diagrams, 6
- Home-made Hives made from Used  
Boxes, 173
- Honey Jar, a Novel, to hold 1-lb. only,  
278
- "Houghton" Ventilating Dummy-board,  
the, 89
- Mole Traps, 224
- Non-swarmer Device, Mr. H. P. Lang-  
don's, 305
- Rack for Store Combs, 76
- Section Rack and Shallow Frame Box, 63
- "Spring Radiations," 128
- Swarthmore Confining Screen for Forming  
Nuclei, 379
- Swarthmore Mating-box for Setting-out,  
379
- Swarthmore Nursery Cage, 386
- Three Hundred Swarthmore Mating-  
boxes at Work, 387
- Top Bar and Basket, 57
- Unknown Larvæ in Cappings of Honey-  
comb, 203
- Winter Passage, Home-made, 477
- Young Beginner, a, 366

# The British Bee Journal.

No. 1071. Vol. XXXI. N.S. 679.] JANUARY 1, 1903.

[Published Weekly

## THE OLD YEAR AND THE NEW.

Once again does the unfamiliar heading of this JOURNAL make its annual appearance, while we have the unusual coincidence of New Year's Day and the first number of Volume Thirty-one falling on the same date. This by the way; and our first words to readers must be a re-echo of the good old wish for a Happy New Year to all.

For the rest, we only add a brief line of congratulation that the outlook for 1903 is so much more hopeful than that of the year now ended, a wish applicable not only to things of general concern to all Britons, but to bee-keepers in particular. After an exceptionally bad season for all connected with the industry, bee-men are not discouraged. They bear in mind precedents for saying, "The worst bee-season is generally succeeded by the best." And it may be said that it only needs care in preserving the bees still alive in order to give plenty of scope for energy in making the most of the year now beginning to ensure a good and prosperous ending.

Beyond the establishment of an insurance fund for bee-keepers—now happily an accomplished fact—we have no specially important item of progress to report, but good headway has been made in several directions, more particularly with regard to the educational work of the British Bee-keepers' Association. This has developed in a marked degree so far as the number of candidates who have passed the examination for the second and third class certificates is concerned. Twenty-five candidates in the second-class division is a long way ahead of any previous examination. Nor is the increase less remarkable in the third class; so that we have quite a number of duly qualified experts labouring in their respective districts with full knowledge of bee-work

in all its branches. There is cause for congratulation in this which readers will do well to take to heart in the all-round benefit it must afford to the craft in the new year.

## BRITISH BEE-KEEPERS' ASSOCIATION

The monthly meeting of the Council was held on Thursday, the 18th ult., at 105, Jernyn-street, S.W., Mr. T. I. Weston in the chair. There were also present:—Messrs. R. T. Andrews, W. Broughton Carr, W. F. Reid, Ernest Walker, and the Secretary. Letters regretting absence were received from Miss Gayton, Hon. and Rev. H. Bligh, Rev. W. E. Burkitt, Col. Walker, Messrs. W. H. Harris, E. D. Till, and C. N. White.

The minutes of the previous meeting were read and confirmed.

Mr. T. F. Blackwell, 199, Queen's Gate, S.W., was formally elected as a life member of the Association.

The Finance Committee's Report, giving details of receipts and expenditure was duly approved. The Chairman stated that the Worshipful Company of Salters had kindly forwarded a donation of ten guineas to the funds of the Association, and a vote of thanks for this gift was passed.

The Report of the Examiners of papers sent in by twenty-five candidates for second-class certificates was received, and in accordance therewith diplomas were granted to the following nineteen candidates:—

Misses Brenchley, F. E. Bury, C. M. Douglas, C. Dunham-Massey, Jackson, La Mothe, L. Livesey, O. M. Robert, Wimpres, and H. Young; Messrs. L. Bigge-Wither, L. S. Crawshaw, D. Davies, E. Eaton, K. D. Flower, Robert Furse, — Larnder, Geo. A. Shaw, and J. F. Williamson.

Mr. W. Herrod's report upon his work as expert apiarist and lecturer during the past year was received, and it was resolved to ask the Editors of the B.B.J. to include the report in an early issue of that paper.

The draft form of statistics for county returns and experts' visiting sheets were revised, and ordered to be duplicated for circulation amongst the county societies.

The next meeting of the Council is fixed for Thursday, January 15.

## Correspondence.

The Editors do not hold themselves responsible for the opinions expressed by correspondents. No notice will be taken of anonymous communications, and correspondents are requested to write on one side of the paper only and give their real names and addresses, not necessarily for publication, but as a guarantee of good faith. Illustrations should be drawn on separate pieces of paper. We do not undertake to return rejected communications.

Communications relating to the literary department, reports of Associations, Shows, Meetings, Echoes, Queries, Books for Review, &c., must be addressed only to "The Editors of the 'British Bee Journal,' 17, King William-street, Strand, London, W.C." All business communications relating to advertisements, &c., must be addressed to "THE MANAGER, 'British Bee Journal' Office, 17, King William-street, Strand, London, W.C."

\* \* \* In order to facilitate reference, Correspondents, when speaking of any letter or query previously inserted, will oblige by mentioning the number of the letter as well as the page on which it appears.

### NOTES BY THE WAY.

[4994.] A new year and a new volume of B.B.J. starts to-day. What hopes are engendered as we wish all friends a happy and prosperous new year! Our ken of the future is limited to the immediate present, but buoyed by the hope that we shall in a great measure realise these cordially-expressed good wishes, we start anew on the yearly round determined, as far as in us lies, to eclipse all previous efforts, and make the coming year a record one. We have now another year's practical experience to guide us in our work, and have hobnobbed with our brethren in the craft, and have discussed the best methods of procedure, thus adding to the knowledge acquired in practical every-day bee work. Then there has been a "treble X vol. of suggestions," experiences, and the doings of bee-men (aye, and bee-women, too) from which to draw useful inspiration. Surely, then, we are better equipped to-day than we were a year ago? This must add to enthusiasm, and rouse us up to go forward, not only with hope, but with the determination to make Vol. XXXI. go one better than its predecessor.

*Wanted, a Frame.*—This matter is now being well thrashed out, and I hope some good will result from its ventilation. Cannot the B.B.K.A. take the matter into consideration and, with an assortment of standard-sized frames, decide the matter at their next meeting? May be, those who have specimens of "sagged" frames will send them to the secretary in time for the meeting, also specimens of frames and combs to illustrate the various suggested improvements. These would be as convincing as anything. There is, to my mind, one disadvantage in a very thick top-bar, viz., the extra wood takes up the space of a row of cells (sixty-six on each side, or 132 in every frame). This number multiplied by eight or ten, and again multiplied by eight to ten consecutive hatchings of young bees during the breeding season would tend to perceptibly reduce the population of

the hive. In any alteration of the "standard" frame so far as regards strength and width, I should not expect that bee-keepers would rush into the matter, but gradually introduce them into existing stocks; by so doing the expense would be small, no alteration of hives or other fixtures being required.

*Trophies of Honey*—I fear I have not made my ideas clear to readers, and am sorry that the Rev. Donald Moore (who writes on page 514, last week) was not more fortunate in his local show. Many of us have had similar experiences in our local efforts, and, by applying the adage, "If at first you don't succeed, try again," have surmounted the difficulties. At one show to which I gave considerable time, the exhibitors were allowed to pass in as soon as it was open, but because two or three used language more forcible than polite, to the disgust of lady visitors and patrons, the rule was altered, so that exhibitors could not enter the show-ground till 3 p.m. Perhaps the hint may be useful to our Rev. friend. Then, with regard to the use of British honey in cosmetics, beyond modifying my assertion on page 482, by adding the words, "no appreciable quantity," I still—perhaps blindly—adhere to my former assertion. I know that large quantities of honey is to my knowledge used by some firms in the manufacture of honey linctus. One firm, who are makers of "cough syrups" and "drops," &c., use up the respectable quantity of seventy tons yearly, but in these cases only foreign honey is used. In old recipe books (I have one dated 1720) honey was used to a much greater extent; but unless British honey can compete with the foreign article in price there is no chance of our native product being used in manufactured articles. In reply to Mrs. Waller's letter (4990, page 516), I certainly had the case of her "Trophy" exhibit at the Confectioners' Exhibition in my mind. I also had in view the condition of things twenty years ago when men spent time and money lavishly in the attempt to use the native product in making "honey biscuits" and "honey beverages," but neither article took the public fancy and are now forgotten. I will now, if possible, define my meaning. My contention is against these extraneous articles being allowed as part of "honey trophies" at shows. Exhibitors are, as a rule, people of small means to whom the purchase of these multifarious articles are a great hardship, if not beyond their means altogether, and as these articles contain but very little honey, I contend that prizes should be given only for the encouragement and advancement of bee-keeping and the production and disposal of British honey. I also contend that the introduction of elaborate and expensive stands or cases is another bar to the growth of healthy competition, and will, I feel sure, eventually kill the trophy class if persisted in. I hope to say more on this matter in future "Notes" as I have been requested by corre-

spondents to ventilate this "trophy class" question in the interests of the craft and against giving a free advertisement to the foreigner. As already said, I feel certain that the most instructive and interesting class in our honey shows stands a chance of extinction, hence my objection to anything beyond the *products of the hive* being staged in the "trophy class." What say our usual exhibitors at honey shows?—W. WOODLEY, *Bedon, Newbury.*

#### THE GRANULATION OF HONEY.

[4995.] The article on heather honey by Mr. D. Raitt (4983, page 509) tempts me to volunteer the following, hoping that it will throw the necessary light upon the frequently occurring, usually unaccounted-for crystallisation of honey.

Sometimes honey of the same batch, bottled at the same time, behaves differently in the glass jars in which it is stored, and I personally have frequently been asked by well-known apiculturists to attribute a reason for this peculiarity. To any one well versed in the laws of crystallography it is very easily accounted for, and I think a few facts explained on the crystallography of chemicals will materially assist the bee-keeper in digesting the real causes. It is a peculiar fact that a crystal of a pure substance is always of the same composition; by this I mean to say that the elements have combined to form a compound in definite proportions, and, consequently, perfect crystallography is a good test of its chemical purity. I only make use of this point to make clear that honey which is undoubtedly of a peculiarly complex composition, containing, as it does, many sugars. This is, perhaps, gradually brought about from the time it is gathered by the bee from the nectariferous gland of the flower to the completion of its ripening as honey. Possibly when gathered it is of a highly complex nature, but it is certain that it becomes more so as it comes in contact with the acids which are natural to the bee, so that when we speak of the crystallisation of honey we must not be under the impression that honey is an element or simple substance, and that it, as a whole, has become crystallised, but be satisfied that it is composed of a number of sugars, and that one or more of these sugars have become crystallised and lie deposited in a solution of less crystallisable sugars natural to the honey. Thus if we carefully examine under the best of conditions these crystals with the aid of a microscope, we should detect shapes indicative of certain sugars.

The occasional crystallisation of one jar of honey which granulates, while the others remain bright and liquid, is accounted for by the fact that the bottle either contains a small portion of grit, or is slightly rough or irregular in some particular part of the inside, which

lends a starting point of crystallisation to the sugars which are contained in the honey in what we will term a state of super-saturation. An experiment (on crystallisation), using sulphate of soda for the purpose, most beautifully illustrates this theory. If we take a quantity of sulphate of soda, dissolve it in a minimum quantity of hot water, and whilst warm tie over the neck of the vessel in which it is contained a parchment paper and allow it to cool, we can at any moment cause the solution to crystallise by the puncturing of the paper with a needle, or by keeping the bottle air-tight we can retain it in solution form. Again, we can make solutions of chemicals and can manipulate them without any signs of separation, but the introduction of a further small crystal of the same or some other substance will spontaneously cause the crystallisation of the whole, and I feel assured that the granulation of honey can be accelerated by the addition of a very small crystal of the ordinary cane sugar.

Again, our friend Mr. Raitt speaks upon granulation of honey obtained from mixed sources, likewise upon the dry heating of honey to 160 deg. Fahr., and asks for an explanation of these points. I would say that the granulation of honey depends largely upon the sugars of which it is composed. For instance, I have found clover honeys granulate very much quicker than honey from other sources, possibly due to the composition of the sugars or to the quantity of acid contained therein. It is certain that granulation is controlled by the amount of acid it contains, which practically changes the crystallisable sugars into glucose, which is, practically speaking, uncrystallisable, and I think it is quite possible, by the careful heating of honey to the temperature mentioned in Mr. Raitt's letter, together with, perhaps, a little more formic acid, to render honey absolutely uncrystallisable. I have found this so using hydrochloric acid, but as yet have not experimented with formic acid, which should be the acid used, as it is that which is natural to the bee.

I wish it to be clearly understood that I am not advocating the heating of honey with the object of keeping it liquid, as personally I am a great disbeliever in the application of unnecessary heat, as it invariably brings about undesirable changes, and in the above case it is very certain that the composition of the sugars previously mentioned is partly or wholly changed according to the heating and other conditions.

I have purposely not referred to the granulation of honey by exposure to cold, as it is almost an invariable rule that substances become less soluble under its application.

Diverging from the subject, it would be very interesting if the different county associations would collect the different styles of honey jars put up by factors and others to be shown on every possible occasion, and it would

be the means of supplying ideas to the apiculturist, who is unquestionably the man who should benefit by and control this important industry.—H. S. SHORTHOUSE, *December 22.*

### CARNIOLAN QUEENS.

[4996.] I find it very difficult to obtain Carniolan bees here in England, not being able to get a Carniolan queen during the past year. I put myself in communication with one of the best bee-keepers in Austria, and I think I could get queens from him and supply them to those who would wish to have them at a lower price than they are usually sold at in this country. But, not wishing to take any step in this direction without your valuable opinion, I would ask:—1. Would it be better to have only pure Carniolan bees, or to cross the pure queens with Italians, as I have some stocks of the latter? The Carniolan queens being very prolific, I think they would be useful to bee-keepers located in places affected with foul brood, as enabling them to keep their stocks always strong, and as they would be cheaper, they would be at the reach of most bee-keepers. I send my name, &c., while signing myself—HONEY, M. M., *Devon, December 29.*

[The question of selling pure Carniolan or only hybridised queens is one for yourself, because, most of those who ordered queens would state whether the pure race or hybrids were wanted. It would doubtless tend to increase trade to import only pure Carniolans, but rear Carnio-Italian queens for those who desired hybrids.—EDS.]

### HONEY CONDIMENTS, &c.

[4997.] Referring to Mr. Woodley's remarks on page 482 about honey-soap that has never seen honey, and so forth, I quote from a useful little handbook entitled "Toffey and Sweets, How to Make Them." On page 35 is a recipe for honey-drops. I will not spoil the sale of the book by giving the recipe in full, but a paragraph, just the tail end of it, is very instructive and amusing. It says: "You may leave out the honey and flavour with essence of honey and a little acid; likewise use a little saffron to give it a yellow tinge." I warrant the honey-drops so made are not like some the Rev. B. Columban, O.S.B., sent me a week or so ago for a nasty cold my wife was troubled with.—GEORGE ROSE, *Liverpool, December 26.*

### RE-QUEENING FOR THE HEATHER.

[4998] Your correspondent, "Heather Honey" (4979, page 501), is evidently quite convinced of the superiority of second-season queens at the heather. Most likely, in his practice, when a stock is seen to be in a forward condition, it is left to work on the heather, with the old queen at its head, on the "let-well-alone" policy. But in what

condition are the stocks that it is thought desirable to re-queen? Are they on the down grade with a limited amount of brood, and workers exhausted by the labour of gathering the previous crop? In that case success would, indeed, be impossible; with the queen thus handicapped, nothing else might be looked for than the storing of the heather crop in the brood frames. Give the young queen a chance to show what she can do; put her at the head of a strong stock of young, vigorous bees, on nine or ten frames of hatching brood, with combed supers tiered up above, and, if there is heather honey to be had, that stock will get it and put it in the right place.—J. M. E., *Ussie Valley, Cambs, December 29.*

### THE "FRAME" QUESTION.

[4999.] I have read Mr. Edwards' article on page 463, and the discussion that has followed it, with a good deal of interest. Discussing widening and thickening the top bar of the Standard frames is a step in the right direction, and I look forward to interesting results. For width, I think a top-bar  $1\frac{1}{2}$  in. wide (the size recommended by Mr. Edwards) will be found to be about the best. As regards thickness, Mr. Edwards states my views very closely in saying, "he likes  $\frac{3}{8}$ -in. best of all; but realises that the very thick top-bar restricts the comb space too much in a frame of 'Standard' size, and has, as a result, settled on  $\frac{1}{2}$  in." Now what are the advantages aimed at in such a top-bar? Mr. Edwards gives them as (1) "enabling one to have all the frame-tops in the hive in the same plane;" (2) "preventing to a surprising extent the daubing in of propolis;" (3) "almost entirely preventing brace-comb;" and (4) "materially reducing the need for the use of excluder zinc between brood-nest and super." I believe all these to be good points.

Probably the most important advantage to be secured by the use of wide and thick top bars is the prevention of "brace-combs"—*i.e.*, combs built between the top-bars of the frames in the brood-chamber and the bottom bars of the frames or sections in the super. When the wide top-bars are properly spaced there is only about  $\frac{1}{4}$  in. between them, and this, if the top-bar is also thick, has been proved by practical experience to prevent brace-combs and to greatly reduce the necessity for using excluder zinc between the brood-chamber and super.

(Continued on page 6.)

### HOMES OF THE HONEY BEE.

#### THE APIARIES OF OUR READERS.

It is refreshing to have so good a report of the season of 1902 as that sent by Mr. Swift, whose apiary is shown on next page. It also speaks volumes for possibilities of bee-keeping when we learn that the hives seen are all



home-made. A harvest such as he reports in so bad a year as last is a result well worth working for, and we congratulate our friend on his success. For the rest, he says:—

“It is now six years since I commenced bee-keeping, when I bought a stock in an old bar-frame hive. I afterwards purchased several stocks in skeps, all of which swarmed later on, and in this way my apiary rapidly increased in numbers. I then started hive-making, but, like a good many beginners, made the mistake of adopting large hives of the ‘Combination’ type. At last, however, I chanced to read in the B. B. J. an article on ‘The “W. B. C.” Hive: How to Make It,’ and was so pleased with the description and this style of hive that I made six of them at

“The shed on the right is the honey house and where I keep the apiary appliances. A portion of my ‘Doolittle’ solar wax extractor is seen above the roof of one hive. This useful appliance works splendidly in hot weather. I made it from instructions in Root’s ‘A.B.C. of Bee Culture.’ I am at the present time trying the different races of bees. The Carniolans have done well here this season. With regard to prevention of swarming, I have found the non-swarmer chamber below brood-nests quite effective in practice. I have also a splendid stock of pure Italians, the progeny of a queen which I purchased from Mr. F. Sladen. But for comb-honey producing I have never had better capped and filled sections than I ob-



MR. H. SWIFT'S APIARY, CHURCHDOWN, CHELTENHAM, GLOUCESTERSHIRE.

once, and then gradually altered or, in fact, remade the large hives first mentioned to this pattern. I manage to make about a dozen or so every winter, and I now have sixty colonies in my apiary. The figure seen in photo holding a frame of bees is myself, the other figure shown is my friend, Mr. R. Merrett, who is also a bee-keeper and often lends me a helping hand when queen-rearing, making artificial swarms, &c. The trees seen are plum and apple; these give shade in the hot weather, also afford a capital alighting place for swarms. A good specimen of the “Chapman honey-plant” is seen in bloom, also plenty of borage, which I find to be a capital honey-producing plant.

tained from a stock of native bees. The sections seen on the ‘Wells’ hive are some produced by this stock. They were awarded one first prize at a local flower show, also third at Dudley Show.

“I had to go twenty miles to drive the bees from which this stock was built up last autumn, but they were well worth the trouble. I shall breed a few queens from this stock next summer. This season I harvested nearly 1,000 lb. of honey, and twenty swarms from forty stocks, spring count, which is not so bad considering the season. I have sold all my honey, so I am more than satisfied. Hoping the coming year will be a better one for all bee-keepers.”

(Continued from page 4.)

I have for some years been experimenting with the "Hoffman" frame in my apiary. This is probably the most popular kind of frame in America and it has top-bars of the width and thickness recommended by Mr. Edwards. The projecting ears or "lugs" of this frame are very small and short; the frame is usually handled not by these lugs, as are our British frames, but by a portion of the top-bar nearer to the centre of the frame. The "Hoffman" frames are spaced the correct distance from one another by means of their end or side bars, the upper portions of which are widened so that they come into contact with one another for about one-third of the distance from the top (as shown in figure 1, *x*).

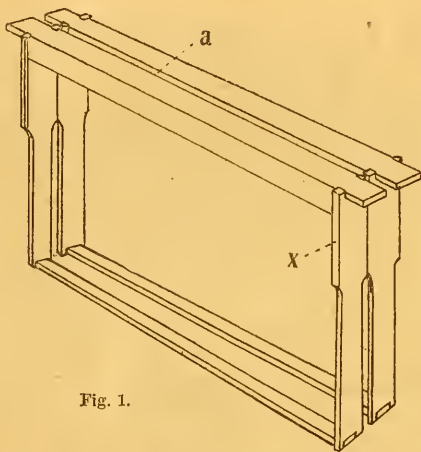

Fig. 1.

Of course the bees glue these long edges of contact together, and after opening the hive it is always necessary to separate each of the frames with an instrument before any work can be done. This I have found to be a great inconvenience, and I much prefer spacing frames by a device like the "W.B.C." metal end to the Hoffman method.

In the hive for the Hoffman frame (the ordinary Langstroth hive) there is a  $\frac{1}{4}$ -in. space in the brood-chamber over the frames. This space is covered with a simple flat roof or "cover" (*k*, figs. 2 and 4), or during the honey-flow with the super. The building of brace-combs being prevented by the wide thick top-bars, this  $\frac{1}{4}$ -in. space over the frames is left perfectly clear by the bees, and either "cover" or super can be simply lifted off the hive without the least trouble; thus no quilts are required, and the top-bars of the frames are clean and free from propolis, which is never the case for long when a quilt is used over the frames. Quilts and wraps are always a troublesome and often an expensive item in the maintenance of a large apiary; the bees are inclined to nibble through them, and they require renewing frequently; they also harbour the wax-moth larvae nearly, if not quite, as much as the saw-cut in the top bars. If quilts could be dis-

persed with it would certainly be a great blessing.

In my opinion, one of the greatest advantages of a thick and wide top-bar would be in the possibility of having clean, unpropolised top-bars, with a bee-space between them and the roof, and the consequent dispensing with quilts.

Anything that reduces propolis greatly facilitates manipulation. The ideal frame in this respect should hang clear by a bee-space

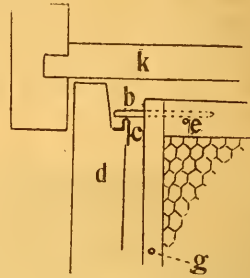

Fig. 2.

of everything above, below, and around it. Such a frame is, of course, an impossibility, but I made and tried some frames in one of my hives last summer, which resembled this ideal more closely than any I had previously seen, and they pleased me so much that I think they are worth describing here

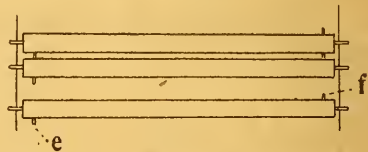

Fig.

(see figs 2, 3, and 4). The frames have thick wide top-bars of the dimensions mentioned above, but they have no "lugs"; two wire nails (*b*), with their heads filed off, driven into the corners of the frame, take the place of the lugs. The nails rest on metal runners (*c*), which are tacked on to grooves on the inside of

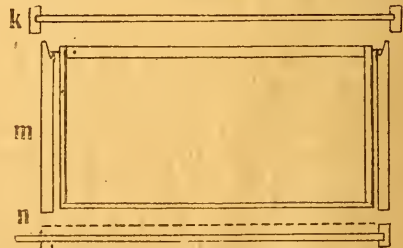

Fig. 4.

the hive wall (*d*). The frame is, of course, supported only by the two nails, which rest on single points in the metal runners; it also swings on these points, and by virtue of its own weight hangs absolutely vertical and parallel to other frames. The nail acts, too, as

end spacer, keeping the frame  $\frac{1}{4}$  in. from the hive side. For spacing between the frames one oval wire nail or staple is driven into one side of the top bar at *e* (figs. 2 and 3), and another into the other side at *f* (fig. 3). Extra oval nails can be driven into the side bars at *g* if desired.

Now, such a frame looks as if it cannot be propolised, and I have found it to be so in practice; indeed, I do not hesitate to say that the hive fitted with these frames was the easiest and pleasantest to operate on of all the hives in my apiary. The method of operating was different to that of other hives. First, I lifted off the cover. Then, after giving a puff of smoke, I slid half the frames (with the dummy, which is made like the frames) *en masse* to one side with the fingers of one hand, while with the other hand I drove several puffs of smoke into the gap thus formed in the centre of the hive. This had the effect of subduing the bees at once, and gave me plenty of room to work and to lift out any comb that I wished to examine, without fear of injuring bees. Manipulating this hive was certainly much easier to me than examining ordinary hives in which I had to gradually tear off the quilt and start shifting the frames (some of which might be a little difficult to move) one by one from one end of the hive till I came to the one I wanted to examine, not caring, if the combs were at all bulged at the top with honey, to risk lifting any out without taking this precaution, for fear of squeezing some bees between the combs.

Another advantage I found in this hive, viz., it was much cheaper to make than an ordinary double-walled hive; there being no long projecting lugs to the top-bars, I was able to construct it of single-thickness wood, and no fittings had to be bought but the two metal runners. (This brings me to a question I should much like to see discussed in the B.B.J.,—viz., whether a simple single-walled hive is not always better than a double-walled one for the practical bee-keeper, with whom cheapness and portability are so important. A single-walled hive is also an advantage in dealing with foul brood.)

Let me now say a word in favour of our present narrow top-bars. These are  $\frac{7}{8}$  in. wide, and when hanging in the hive there is a space of nearly  $\frac{3}{8}$  in. between them. This wide space enables one, on simply turning back the quilt and without moving a frame, to see the bees and combs between each top-bar, and at a glance to ascertain the strength of the bees and whether there is food in the hive. I have even been able in the spring to satisfy myself as to the presence of a fertile queen in the hive through seeing worker brood-cappings between the top-bars without disturbing a frame. Now, none of these things are possible with the wide, thick top-bars. Unless the colony is very strong not a bee is to be seen when the hive is first opened, neither is any comb visible; it is therefore necessary to separate the

frames before anything can be ascertained about the condition of the bees. I do not think that British bee-keepers will like to manipulate frames with wide top-bars unless they are of a kind that can be easily separated by simple lateral movement.

Again, wide top-bar frames, such as I have described, have the serious disadvantage of not being exactly interchangeable with the Standard frame, even if they were of the same dimensions, because they require a differently constructed hive, although a hive made for Standard frames could be made to take them with very little alteration. This being so, it seems to me that should a wide and thick top-bar frame be found desirable it might offer a good opportunity for those who are dissatisfied with the dimensions of the Standard frame to try a wide and thick top-bar frame of the dimensions that they prefer. Personally, I know of no good reason for altering the dimensions of the present Standard frame, but if these had not already been determined I might have wished that it had been made a little larger in the way of increased length. I certainly do not want a deeper frame.

To conclude, it is important to bear in mind that hives in which the bee space in the brood-chamber (or super) is *over*, and *not under*, the frames (or sections) differ in principle from those in which the bee space is under the frames. The former principle, which we might, perhaps, call the "top-space" principle, has scarcely received a trial in England, and it is for hives on this principle that it seems to me that a wide top-bar is most beneficial. Indeed, I doubt if it would be worth while widening the top-bar for hives on the ordinary principle. Merely thickening the top-bar for the purpose of strengthening the frame is a simple matter, and one that I have not dealt with in this article. I must reserve dealing with supers for hives on the "top-space" principle for another contribution.

If we all realised, as I think we must do, the immense advantages that the bee-keepers of Great Britain have gained by the adoption of the British Standard frame it will make us very careful about recommending the adoption of any serious alteration in it. There is, however, nothing to prevent us experimenting with such frames or discussing them, and I know of nothing that is more likely to tend to the advancement of apiculture in this country than friendly, open-minded discussions on this and kindred practical questions by those who have studied them.

#### EXPLANATION OF THE DRAWINGS.

- Fig. 1.—Two self-spacing Hoffman frames.  
 a.— $\frac{1}{4}$ -in. space between the top-bars.  
 x.—Edge of widened portion of end bars.  
 Fig. 2.—Corner of swinging frame with portion of brood-chamber and cover in vertical section.  
 Fig. 3.—Three swinging frames seen from above.  
 Fig. 4.—Swinging frame in hive complete.

December 9.

F. W. L. SLADEN, Dover.

## "BEE JOURNAL" DISCUSSIONS.

[5000] As a couple of bee-keepers who have profited by your valuable JOURNAL, we desire to tender our thanks to its Editors. We look forward every week for it with as much eagerness as when we first began to subscribe five years ago. Many times have we got information from its query column that has saved us asking questions ourselves, while the various subjects that crop up from time to time for discussion are always interesting reading, even if nothing comes of them. One of these was the "Tall Section" controversy. This got so warm as to be almost exciting, and then what wonders it was going to work, how much superior it was to be in appearance to the square shape, and how much more saleable! Again, were not the bees going to fill up the new section at the rate of 100 for eighty of the old-fashioned square ones? I fancy it went so far as to make us think that, if ever there was a bad year for bee-keepers, the new tall section was to remedy the bad luck and be their salvation. In fact, this new section seemed to come in like a "lion." Has it not gone out like a "lamb"? We have been searching the B.B.J. for some records of the results of this new section, but its advocates seem to lie low.

Now the "Standard Frame" is on its trial. What will be the outcome remains to be seen; but whatever it is, we agree with Mr. Lee when he says it must be "interchangeable with the Standard."

The Rev. Donald Moore, on page 498 of last week's B.J., was a bit hard on Mr. Woodley, as he was on all those who are of his opinion—that "no English honey" has ever been used in the manufacture of cosmetics, &c. But those who hold these opinions are hardly so ignorant on these matters as Mr. Moore seems to think. We know that honey is used in these articles, and more besides; but, speaking for we two (I know Mr. W. is well able to take care of himself), we are still of opinion that no English honey is used, as a rule, in the manufacture of these preparations, because cheap foreign honey answers the purpose as well. Of course, in such a case as that of your correspondent L. Waller (4990, page 516) there is no doubt but that English honey was used. But one is led to ask: Does Mr. Waller "manufacture" these things in a large way? If so, it must be the exception that proves the rule.

The past season with us has not been at all good, our average yield has only been 20 lb. per hive for the eighty hives we supered, and we had twenty swarms; not so bad as a good many reports we have read of. Skeppists here have had a very bad time, we have driven a lot, and the average yield would appear to be only about 5 lb. or 6 lb.; in some cases the swarms had starved. We trust 1903 may be a better season for us all.—H. & F. DEVEREUX, *Shillington*.

## Queries and Replies.

[3012.] *Drones at Christmas*.—I have just had what was to me a new experience. In looking round my hives on Christmas morning I noticed a drone at one of the entrances, and came to the conclusion that the stock was queenless. I felt very much troubled in consequence, having introduced to this colony an expensive Italian queen last September, which I received from a well-known and reliable English breeder who makes a speciality of the strain. So as the sun was shining brightly at the time, and the temperature stood at 58 deg. Fahr. steady, I determined to set my mind at rest on the subject. I opened up the hive, and examined frames as quickly as possible, and, to my relief, found the queen on the second frame I took out. I then closed up the hive, and readjusted coverings, the whole operation not extending over five minutes. As I have never opened any of my hives during the winter before, and having read in the "Guide Book" that it is against all good bee-keeping precepts, would you kindly say (1) whether you think I have done the stock any harm? Also (2) can you explain the presence of the drone at this time of the year?—A. L. G., *Ashton-on-Mersey*, December 26.

REPLY.—1. There is no reason to fear any harmful consequences whatever from such an examination as you made. 2. It is possible the drone—if a solitary one—had come from a queenless stock somewhere near, as abnormal or out-of-season drones are not very particular about entering other than their own hives. In any case, so long as the Italian queen is all right, no notice need be taken of the drone incident.

[3013.] *Feeding Bees in Winter*.—I am a bee-keeper owning six stocks, three of which are in frame-hives and three in straw skeps. The latter I neglected to feed in the autumn, although they gave me a very fair return in well-filled sections. I gave these unfed stocks a large cake of soft candy in November, and on looking at them to-day (December 25) I find in two of them the bees have almost emptied a 4-lb. box of candy each. They have also, to my great surprise, built the combs up from the skeps, and filled with comb the space in the box where the candy was. 1. Is this not rather unusual at this time of the year? 2. Am I to infer from this that the bees in these skeps are better off for stores than I imagined? for, unless the bees had food stored besides what I gave, surely they would have eaten the candy and not started comb building? I may say the combs built are of a rather bad colour, and this makes me think they must have worked some old comb up in the building of it. 3. Would you give them more candy to use in this manner, or will it be safe to leave them till spring? I noticed to-day most

of my stocks were busy, and a good number of bees were bringing home both pollen and propolis freely. It rather surprised me to see this, also that they visited the water very frequently. Your advice as to giving more candy or not would be valued.—W. P., *Ringmer, Sussex, December 26.*

REPLY.—1. It is quite a common occurrence for bees to fill up emptied candy-boxes with comb, though we do not often hear of them doing this at Christmas-time. 2. The fact of combs being built as above does not make it certain that stores are plentiful in the skeps, seeing that the bees have been revelling in candy-food for a month past. 3. You should lift the skeps gently, either with or without raising the floorboards, and if they weigh under 20 lb. gross give one more cake of candy to make them quite safe for winter. The fact of the bees working busily in December and visiting the water-troughs indicates prosperity.

## CONVERSATIONS WITH DOOLITTLE.

### "BALLED" QUEENS.

"I came over this evening, Mr. Doolittle, to have a talk with you about queens. Did you ever have one 'balled,' or the word *clustered* might more nearly express it?"

"Yes, I have had the bees 'ball' a queen quite often when I was trying to introduce her. I was often confronted with such things in my early bee-keeping. Have you been having queens 'balled' during the past summer?"

"Yes. It was in this way. I had two swarms come out nearly together. The first had a queen with its wing clipped, and most of the bees had returned when the other swarm issued, the latter having a queen with perfect wings. This swarm clustered and was hived in the usual way, but in half an hour or so the bees began leaving their new domicile and went straggling back to the parent hive. After a little I opened the hive and found a ball of bees nearly as large as a hen's egg on the bottom board, and in this ball of bees was the queen. Why did these bees act in this way?"

"In this question you have touched on a matter rarely if ever spoken of by any one; and yet, if my experience is any criterion to go by, this is something which quite often occurs in natural swarming, for I have had several cases of the kind. I remember two or three cases where I have been kept from leaving home as I intended by this very thing. A swarm would come out near the time I was to go away for some purpose, and I would hive them, thinking I had done a nice thing in a little time; but by the time I would get the horse hitched up, and myself ready to go, the bees would begin to show a commotion, and commence to return to the old hives."

"Do they always return to the old hive when you have such trouble?"

"They always will where the swarm is hived on a new stand; but where the swarm is hived on the returning plan, and the old hive moved away, they will often scatter all over the place, going into other hives only to be killed, or received according to the condition of the colonies where they went."

"What! Will the bees of other colonies kill them sometimes?"

"Yes. And this is more often the case than otherwise, as it is a rare thing that such bees will be accepted by another colony, unless the latter is queenless. A queenless colony will generally accept strange bees, no matter where they come from; and all colonies having queens will almost surely kill all bees which try to enter their hives."

"That accounts for my having a little swarm which I tried to run in with a weak colony to strengthen it, all killed. But what do you think was the reason the bees balled my queen?"

"I have carefully studied the cause of such procedure, and believe it comes about by a few strange bees entering the new hive with the new swarm; and as these bees are strangers to those composing the swarm, the queen is 'balled' for safe keeping till all get acquainted or from some other reason best known to the bees."

"Well, why does the balling of the queen cause the bees to run about and finally straggle off home or enter other hives?"

"As soon as the queen is balled for any reason, the result is very nearly the same as would be the removal of the queen, which, as nearly every bee-keeper knows, means a stampede and general search for her."

"I did not know that such was the case. I have taken away queens from colonies many times, and I never saw any great commotion, as you and others tell about."

"You are talking of removing a queen where there are combs containing honey and brood in the hives. Where there is unsealed brood in any hive the bees know that there can be another queen reared by them, so that such conditions are vastly different from what they are where a swarm is hived in an empty hive, when the loss of the queen means the loss of all the bees in the swarm, unless these bees can get back to the brood in the hive which they left. In this case, failing to find their queen, their only alternative is to go home if they would preserve their existence; for staying where they are, without a queen, means that they go out of existence as a colony, when the bees which make up the present swarm cease to exist, from death by old age or otherwise."

"I had not thought of the thing in that light, but I guess you are right. But they have not lost their queen. She is only in a cluster of bees, and she would thus be were

she in the midst of the swarm. What is the difference?"

"When the queen has her liberty with the swarm she is constantly moving about among the bees, as I have many times seen queens come out on the outside of a clustered swarm, and then crawl in among the bees again, only to come out a few moments later on the opposite side, or in some different place in or on the cluster; but when she is balled she is not only kept from running around among the bees, but the bees seem to lose scent of her as well. And so the majority of them go on a stampede nearly or quite as bad as they would were she taken from them altogether."

"I see; but what can be done—anything, save allowing them to go back?"

"Knowing that the supposed loss of the queen is the cause of the trouble, the only way to remedy the matter is to help them find their queen. This can be done by opening the hive as soon as the bees are seen to become agitated and fly out in the air, and smoking the ball of bees till they release the queen, when a general hum of content will be set up, the bees who have missed 'mother' running about with fanning wings, and those in the air returning to the hive with general rejoicing."

"Is this all that is to be done?"

"This once smoking generally restores quietude with the swarm; but in exceptional cases the bees will reball the queen in a few minutes, when another stampede will occur (unless we are on hand promptly with our smoke), many bees being likely to go home to stay, so that, do the best we can, our swarm is so weakened that they will be of little profit to us during that season."

"But is there no sure way to keep them?"

"To obviate these exceptional cases, I made a few large, flat wire-cloth cages, large enough so that they would cover quite a large part of the tops to the frames of the hive; and when I had smoked the ball of bees till the queen was liberated, she was put in this cage and placed over the frames. As multitudes of bees could now get within touch of the queen, and the whole colony became aware of her presence, the same as though she were among them, no more trouble would occur with the bees, and no other to the apiarist except the liberating of her majesty the next morning. A frame of brood will also hold the bees as a general rule; but as they sometimes ball the queen till she is so injured as to be of no further value, I prefer the cage."—*Gleanings* (American).

#### DEVON BEE-KEEPERS' ASSOCIATION.

The annual meeting will be held in the Guildhall, Exeter, on Friday, January 23, at 3 p.m.—E. E. SCHOLEFIELD, *Hon. Sec.*

At the above meeting Mr. E. E. Scholefield intends to propose the following:—

1. That it is desirable to hold the Annual

Association Honey Show, hitherto held at Exeter, at other important places in the county, and that a Sub-Committee be appointed to determine whether it can be held next year at Plymouth or Barnstaple.

2. That it is desirable that as far as the funds of the Association permit, the travelling expenses of those members of the Council who reside at a distance from Exeter be paid for them, as also of delegates to meetings of the B.B.K.A. in London.

That a Sub-Committee, consisting of the Treasurer and two other members, be appointed with power to decide how far this can be carried out. The result to be published as soon as possible in the Monthly Journal.

#### Notices to Correspondents & Inquirers.

*Letters or queries asking for addresses of manufacturers or correspondents, or where appliances can be purchased, or replies giving such information, can only be inserted as advertisements. The space devoted to letters, queries, and replies is meant for the general good of bee-keepers, and not for advertisements. We wish our Correspondents to bear in mind that, as it is necessary for us to go to press in advance of the date of issue, queries cannot always be replied to in the issue immediately following the receipt of their communications.*

*All queries forwarded will be attended to, and those only of personal interest will be answered in this column.*

\*.\* We beg to acknowledge receipt of many congratulations on past events, together with good wishes for the future, all of which betoken good will on the part of readers, which is fully appreciated and very welcome to us as editors, and not less so in our private capacity.

F. J. R. (Plymouth).—*Frames and Appliance Dealers.*—It is gratifying to hear of your having come across a manufacturer whose methods of quick despatch, and quality of goods, are so satisfactory. At the same time it is quite safe to say that the firm you name is not the only one in the country who deal on satisfactory lines both as to good work and promptness. It would be an advantage if all hives were made of "good yellow pine," but the price of that timber in this country is against its use when prices are "cut" so keenly as at present. Hence it is that some makers find it necessary to get their hives "cut" for them in America where wood is cheap and plentiful. Many thanks for your good wishes.

A. H. (Dunford Bridge).—*Wax Moth.*—The "grub" sent is simply a wax-moth larva. You should keep a sharp look-out for any similar larvæ when examining the stock in question.

"Ivy" (Anerley).—*Bee Candy.*—For a first attempt at candy-making, your sample is very good indeed, and will make very suitable bee-food for winter.

H. R. (Drayton, Norwich).—*Destroying Superfluous Drones.*—We will deal with your query in next issue, as it is not urgent.

## Editorial, Notices, &c.

### LIQUID FRUIT SUGAR—WHAT IS IT ?

After an interval of some years we have a recrudescence of the question which forms the heading as above. This time it is raised because the substance dealt with has, we understand, been brought to the front in a Midland county possessing an active Association with a large membership, and an effort is being made to induce members to use liquid fruit sugar as bee-food. Our opinion having been sought, we think the best reply is to republish the following from a former issue of the B.B.J., which, we think, completely meets the case :—

A question of the first importance, not only to bee-keepers, but to the bee-keeping industry, has arisen from the publication of a letter, in which the Committee of the Lancashire and Cheshire B.K.A. requested our opinion as to the desirability or otherwise of the substance sold under the above name being used for feeding bees. In reply, we gave our views as desired, and hoped the matter would have ended there. We have since, however, been favoured with a communication from the firm in London who have been appointed sole importers of the article, and who naturally resent anything being said tending to depreciate it in the eyes of the persons who are likely to use it as bee-food. But when the firm in question, or their agents, make direct personal application to gentlemen who are bee-keepers and readers of this paper, it becomes our duty to at once take cognisance of the fact, representing as the B.B.J. does, in its widest sense, the bee-industry of the country.

We, therefore, that no injustice may be done on our part, print the letter in full, and give it perhaps more prominence than desired by the writers, in order to state still more forcibly the fatal mistake we consider bee-keepers will make if they give countenance to this so-called liquid fruit sugar in any form or shape whatever.

What has caused American and other foreign honeies (?) to be looked on with such universal suspicion in this country as to be to some extent unsaleable? We say, unhesitatingly, its admixture by unprincipled persons with the substance known as glucose. Good and genuine honey is gathered in America, and is sent over here pure as any honey can be, yet it will take years to undo the prejudice against American honey in this country, because it was proved to be in many cases largely adulterated with glucose.

The following is the letter referred to :—

“LIQUID FRUIT SUGAR.

DEAR SIRS,—Your issue of November 13th contains a reply to the Committee of the Lancashire and Cheshire Bee-keepers' Association,

who write for your opinion regarding the advisability of using *liquid fruit sugar* for feeding bees.

We feel sure you will permit us, in common fairness, to reply to your remarks upon *liquid fruit sugar*, which is, as you suppose, identical with Dr. Follenius' fruit sugar, and of which we have been appointed sole importers for this country.

As you apparently rely upon Dr. de Planta as your authority for the remarks you make, and we think rightly so, we beg to hand herewith an extract from a paper read before the Swiss Bee-keepers' Association by that gentleman, in which he completely retracts all his former views on the subject as quoted by you!

This is what he says, addressing a large meeting of Swiss bee-keepers at Schaffhausen (we forward herewith the printed report in confirmation):—

‘I had the pleasure to receive a few weeks ago a letter from Dr. Follenius, the manufacturer of this fruit sugar, who had read my report in the *Bulletin Bertrand*, in which he had the kindness to correct my erroneous views regarding the composition of his product, fruit sugar. I cannot do better than read to you, with his permission, his letter.’

Here follows the letter, which is of considerable length, but which is to the effect that, firstly, fruit sugar is, like honey, a composition in equal parts of dextrose and levulose, and does *not*, as Dr. de Planta previously stated, consist of levulose only. Secondly, that fruit sugar is therefore honey (dextrose and levulose) without aroma.

Dr. de Planta concludes by saying :—

‘Now, however, since it has been proved that the article produced by Dr. Follenius is invert sugar, it consists of the same substance as honey and nectar. I fully concur with his views, and see no reason why I should not regard fruit sugar as an article eminently suitable for bee-feeding.’

We think we have now disposed of your scientific objections to fruit sugar, but would refer briefly to some of the exceedingly grave charges made by you as editors.

Firstly, as to its being ‘introduced under a false name.’

The reason why this article was called fruit sugar is because the only other suitable term in German is *invert* sugar, which could not be used, as it would then be confounded with glucose. The reason why *we* have retained a very similar title is simply because we wished it to be recognised here as the same article so highly spoken of by Continental authorities, including bee-keepers, wine-growers, preservers, &c.

Secondly, as to your remark that ‘every quack medicine vendor can get his testimonials,’ by which you undoubtedly infer that the testimonials given to the proprietors of fruit sugar are false or worthless, we would simply remark that the testimonials in favour of fruit sugar are *genuine*. They have been

received from generals, mayors, lawyers, professors, doctors, and *editors*, and we need scarcely add that the originals will be gladly shown.

Thirdly, not being bee-keepers ourselves, we do not understand exactly what you mean by 'unlawful purposes' as applied to the feeding of bees, but venture to suggest that it is a highly objectionable term to use under any circumstances whatsoever.

We trust that you will give this letter a prominent place in your Journal, so as to remove any unfavourable impression which may have been formed amongst the readers of your Journal, through your imperfect knowledge of, and unwarranted strictures on, *liquid fruit sugar*.

We send copy of this letter to the Lancashire and Cheshire Bee-keepers' Association for their information.—Yours faithfully, D. A. HUME & Co., 38, *Mincing Lane, London.*"

As a direct reply to the above we would say that, considering the vital importance, not only to bee-keepers, but to the bee-keeping industry in general, it is our duty to make some remarks and point out the dangers incurred by employing a substance which puts temptation in the way of the unscrupulous to use it for improper purposes.

(Conclusion next week.)

## BRITISH BEE-KEEPERS' ASSOCIATION

### EXPERT'S REPORT, 1902.

For the first time during the period of my appointment under you, I have not carried out a tour of inspection and instruction for the Kent and Sussex Bee-keepers' Association in the county of Kent, chiefly owing to circumstances which have been made known to you in a previous letter.

From a honey-producing view the season has been a complete failure in this district. The stocks situated in all three apiaries here have yielded nothing, owing to bad weather just when the limes, "our chief source of surplus," were in bloom. From an educational standpoint, however, it has been a great success, the number of students taking up the practical part of the teaching in greater numbers and more enthusiastically than at any previous time. Two good appointments have been offered to students here, one in Chili, the other in Jamaica. In one case it was impossible for the student to take the appointment through lack of sufficient practical experience to justify a recommendation for the work entailed, viz., management of 500 colonies; while the other recommendation was refused for reasons which it is unnecessary for me to detail here. Two old students are doing well at apiculture in the West Indies, one in Canada, and one in Holland.

Four women students are taking bee-keeping as part of their curriculum in the schools and colleges where they hold teaching appointments in this country.

The lectures as per your agreement with the college authorities have been given regularly through the summer and autumn, all students, without exception, attending the same. Under the supervision of W. H. Harris, Esq., B.Sc., I have given a course of practical demonstrations at the Lady Warwick Hotel, Reading, throughout the summer and autumn.

The number of students presenting themselves for examination at Swanley both in third and second class examinations has increased, in the former thirty students and four outsiders against twenty-five last year, all students obtaining a "pass"; for the second class, twelve sat this year as against two in 1901. At Lady Warwick's ten students and one outsider presented themselves, all the students being successful.

Your apiary and garden has been kept in good order, neat and attractive throughout the summer. You are indebted for its splendid display of flowers to Mr. L. McNeill Stewart, of Campbelltown, who bore the cost of purchasing seeds. It has been visited by a number of people, both English and foreign, during the summer, those understanding apiculture remarking on the excellent object-lesson in being able to see hives and other appliances of all modern types in actual use.

The "British," "College," and "Students'" apiaries respectively had a clean bill of health, not only in the spring, but also this autumn, not a single outbreak of the disease has occurred since the drastic measures taken when I first took up the appointment. This, gentlemen, I trust will give you satisfaction.

One new hive from Mr. Dixon, of Leeds, has been put into position, but not stocked, as it arrived too late.

A hive and stock of bees was also given by Mr. Hooker. This upon arrival was found to be queenless and very weak. Before the weather was fit to unite, or a queen could be obtained, the bees died, and as the combs consisted chiefly of drone cells, and were very old and irregular, they were burnt. The hive (an "Alexandra") shall be renovated, painted, and put in position in due course.

The Caucasian queens sent from Russia have done fairly well. Two died off in the winter, so there are three left. As producers of comb honey, the pure bees are an utter failure, the cappings over the honey being dark, ribbed with an excess of wax, and in every case badly "greased." Until properly understood, they are rather difficult to manipulate. It was found that a very little smoke must be used; if the proper amount is exceeded, they become angry, fly from the combs, and inflict very vicious stings, mostly drawing blood. If properly subdued, not a single bee will fly—they cling motionless to the comb, and seem to squat like a hare or rabbit on its seat. After much trouble, on account of weather and other causes, I have been able to secure three queens from the pure stocks



which have been fertilised by black drones, so that all being well I shall be able to report upon their work at the end of next season. One great failing of the pure race is their propensity to rob. This they will do with impunity in any kind of weather, and so persistent are they that it is a very difficult matter to get them to cease robbing when once they have commenced.

With regard to "Edwards" swarm-catcher I had for trial, unfortunately the stock upon which it was placed did not attempt to swarm, but brace combs were built from the bottom bar of frames to floor-board at the back of the brood chamber. The "Brice" catcher after four years trial has been found to be a success, catching swarms whenever they have attempted to issue. It is easy to fix without lifting up brood chamber and equally as easy to remove. Its only drawback is that a certain amount of pollen is lost by the pellets being scraped from the legs of the workers as they pass through the excluder.

The show of the R.A.S.E. at Carlisle was attended by me, assistance given in unpacking, staging, and repacking exhibits.

I also gave four lectures each day when the weather permitted, a great number of questions being put to me at the close of each lecture. I also gave a special demonstration to the Maharaja of Kolhapur, which evidently interested him. Bees in frame hive and skeps were taken from your apiary for the use of candidates who presented themselves for examination, also for use in the demonstrations.

Other shows attended were Kent and Sussex Annual at the Crystal Palace; Bristol Association Annual at Clutton; Lincs. Association Annual at Boston; Newark Agricultural Show, for the Notts Association; Feltham and Edmonston, for the Middlesex Association; Oxshott, for the British; Riverhead and St. Mary Cray, for Kent and Sussex B.K.A. At the Agricultural Hall, Islington, I attended and took charge, on your behalf, of the honey department at the Grocers' and Confectioners' Exhibitions, and at the Dairy Show. I was present every day of each show, and also for a day or two previously to the show, and after its close.

At both the College and Lady Warwick Hostel examinations I was present and rendered what assistance I could to your examiners. I have also visited the apiaries of several of your members, examined stocks, and given advice and help.

Though the season has been such a dismal failure, the bees here have been prevented from visiting the jam factory of Messrs. Woods, by constantly supplying them with food in slow feeders, so the disastrous loss of bees which occurred when the apiary was first established has been avoided.

Your stocks both in frame hives and skeps have been securely and warmly packed for the winter. Candy has been given to each and plenty of quilts. The roofs have also been secured against the possible chance of

being blown off by means of the "cord, stake, and brick" method."

Trusting my labours of the past season may meet with your approval.—I am, Gentlemen,  
Your obedient servant,

W. HERROD.

North Bank, Hextable.

December 1, 1902.

## Correspondence.

*The Editors do not hold themselves responsible for the opinions expressed by correspondents. No notice will be taken of anonymous communications, and correspondents are requested to write on one side of the paper only and give their real names and addresses, not necessarily for publication, but as a guarantee of good faith. Illustrations should be drawn on separate pieces of paper. We do not undertake to return rejected communications.*

### AMONG THE BEES.

[5001.] *Exit "Comments."*—In starting the new volume for 1903 it has been thought advisable to alter the heading under which my contributions shall in future appear. Many of the subjects hitherto dealt with could only by a stretch of the imagination be described as "comments," and little attempt was ever made to treat only "current topics." So the heading, being rather a misnomer, has been dropped; and that used for some time in the *Record* has been adopted here also. It is wide enough to include all topics connected with the craft.

*Bees Run Amuck.*—Quite recently I have dealt with the stinging powers of the bee, and thought I had pretty well exhausted the subject; but, seemingly, some readers think I have not, and at least one deems me densely ignorant on the whole subject. I may refer any interested to what I have written on "The Sting of the Bee," "The Wrathful Bee," "Bee Government," "The Irate Bee," "Vicious Bees," and "Can a Bogie Man Work a Miracle?" I return to the subject now to deal with some criticisms of what I have written. In Mr. J. Herrod's reference, on page 483, to my last-named article, he courteously mentions one or two instances in his experience where bees had turned waspish when being manipulated, to show me that bees can sting indiscriminately at times. Curiously, he will find in the concurrent number of the *Record* that I give two instances identically similar to his, one from my own experience, and one from that of another bee-keeper. This will show him I was cognisant of the fact he kindly draws my attention to. Yet I adhere to every word of my former statement. The apparent contradiction (if there is such) is accounted for by the fact that he and I in my article were writing about bees under two different sets of circumstances. In the one case the bees were dealing with animate creation, in the other with inanimate. Further, in the one case the bees were being attacked, in the other they were being left

severely alone. The two cases are, therefore, wide as the poles asunder.

Another correspondent, Mr. Tom Abbott [4992], waxes wrath and accuses me of seeking to cloak "my want of knowledge as to fact." Then he assures your readers that *he* is a "bee-keeper of observation and experience," inferentially insinuating that I am not. Where did his boasted observation come in when he asserted that I "question the veracity" and "cast some doubt upon the truthfulness of Mr. Sole," when, at the time, I expressly stated that I had "no desire to question the *bona fides* of Mr. Sole's statement?" This makes me more than half inclined to question his vaunted powers of "observation." Further, would Mr. Abbott again read my article and take note of the qualifying words, "rarely" and "voluntarily," and then he will surely acknowledge that he and I are not so very far apart in our "experience," for he says, "Bees are cautious as a rule. The fury is the exception." That is almost a verbatim copy of what I wrote and a replica of my own experience. I never, however, asserted that bees cannot work themselves into a passion and run amuck, for I know they can. If my friend, Mr. Abbott, will kindly refer to what I wrote on "Bee Government," page 393, he will see that I distinctly state that bees attacked *may* become a "set of raging demons," when fighting for house and home. My article now under discussion had no reference to an attack on their domicile.

Why expect the impossible from bees? If their hearth is being violated, can we in reason look for cool calculation, calm reflection, and a resultant gentle treatment on their part, who receive none? When man is provoked (proud in an intellect and reasoning powers far above the bees) does he always give the gentle answer which turneth away wrath? Does he not rather, too often, allow his passion to run away with his judgment and discretion? Not to instance the Malay who *runs amuck*, stabbing, maiming, and even slaying his fellow men, do we not every day, in our larger cities, witness men doing deeds which consign them to a felon's cell? This ability to sting, and willingness to do it, even at the sacrifice of its own life, is one of the finest traits in insect existences, and one which should fill bee-men with wonder and admiration rather than alarm and resentment. I still hold this opinion, that rarely does a bee voluntarily sting other than a vulnerable part of a man, even when in a passion, and, further, hold that *very* rarely indeed does it use its sting on inanimate matter.

*The Monarch of the Hive!*—Ancient writers ascribed wonderful powers in administration and government to the presiding genius of the hive, whom they designated king. Even so late as the time of Shakespeare this belief prevailed, for he writes, "They have a king and officers of sorts," and further mentions the "seal royal of their

emperor." Later, when the proper function and duties of the mother-bee became better known, they gave her the title of queen, but still ascribed fabulous powers to her. Now, in these utilitarian days, she is recognised only as the parent of all the other bees in the hive. She has been deposed from the seat of a monarch, and is viewed only as an egg-laying machine. Still, I maintain, she is the only single bond that unites the 60,000 bees, more or less, found in a well-regulated hive; and, while she is there, her mere presence, or some spirit—impalpable but all present, pervading the whole atmosphere of the dark interior, and governing, regulating, and superintending the wonderful domestic economy—controls, arranges, and directs every movement in the intricate mazes of those streets and galleries of art forming that wonder of perfection, a modern bar-frame hive. Without her presence confusion prevails, order gives place to chaos, and the bees fail to take delight in work hitherto the chief desire of their being. Sadness and depression take the place of gladness and mirth. But only for a time! For that spirit already referred to teaches them that extinction need not follow, and directs them so that they select one of these tiny eggs deposited by the departed queen and *create* a successor to become a new bond of union.

*Rational Bee-culture.*—Readers just beginning bee-keeping should read, mark, and inwardly digest the following from Dzierzon:—"The way to carry on bee-keeping rationally is to be armed by a thorough knowledge of the entire nature of bees, and to treat the stocks so that there is derived from them surely and continuously the greatest advantages which can be obtained under the prevailing conditions of yield and weather. The bee-keeper who has not learned better just lets the bees do as they like, and if he has anything to do about his hives does it after the manner of his father and grandfather before him. It is otherwise with the rational bee-keeper. He conducts his business systematically, interposing on the economy of the bees, at one time stimulating, at another time checking, and having for everything he does a *reason why*."—D. M. M., *Banff*.

#### KEEPING HONEY IN LARD BUCKETS.

[5002.] In your issue of December 25 I notice a query on page 518 on keeping honey in lard buckets. Now, as a bee-keeper of old standing, I should like to say a word or two on the above. I have kept bees all my life, and have used lard buckets for storing my honey in, and sent it to all parts in them without having the honey spoiled or a single complaint from any of my customers. I find lard buckets are most useful for the purpose, and the cheapest and handiest articles that a bee-keeper can have for his honey if properly

cleaned. I pen these few lines thinking they might be serviceable for bee-keepers to know my method of cleaning, which is as follows:—Wash them well inside and out with hot water made strong with common washing soda. Next, have a copper about three parts full of clean soft water, to which add  $\frac{1}{2}$  lb. common soda; insert the buckets in the copper, and let them boil for half an hour; then take them out, and allow them to dry. By this method of cleaning there is neither smell nor taste about the honey, as the buckets are as clean and white as new sections. If your correspondent will adopt this method of cleaning lard buckets, his honey will keep in good condition, besides being sweet and clean for table use.

I have also been very interested with the correspondence of the few past months in the B.B.J. regarding the bad season of 1902. Now I am a mid-Yorkshire bee-keeper, having the management of about 100 hives of bees. These hives are treated in a radius of about fifteen miles, and I have found the several stocks vary very much in honey-storing, some having done remarkably well, while others have done badly. From one hive I extracted 93 lb. of good honey, and others have not yielded a single pound. I fear, Mr. Editor, I am making my letter too long, but I have one very interesting note in my diary respecting queen-rearing particularly, which I will send you for publication when the season comes round for ascertaining if a queen hatched last October is fertile or not. I should have made the point clear by examining for eggs, but cold weather set in, and I dare not open the hive. If the queen proves fertile, the method I adopted in raising a queen so late will, no doubt, be very useful to other bee-keepers with queenless stocks so late on in season.—A LOVER OF BEES, *Snaitth, R.S.O., December 29.*

### THE FRAME QUESTION.

[5003.] Referring to the letter on frames (page 504 in B.J. of December 18), may I say to friend Edwards, "A Happy New Year to you. I hope you spent a jolly Christmas, while enjoying a cut off the breast of that turkey."

Now, as you have thought fit to make an attack on my "83A frame," in the closing par. of your letter, I feel constrained to say a few words on the same, and also about the frame you advocate as your own. To begin with, then, let me say I refrained from saying anything personal about your frame in my letter on page 473, but took the view that there were manufacturers enterprising enough to make your special frame if they could see a chance of sale for them. But it is hardly probable that any one would care to make a special frame which has not been tried, especially as every year many different kinds of frames are being recommended, of which a

great proportion had already been tested, and "found wanting," before the present standard frame was adopted.

I beg also to differ from your remarks in B.B.J. of November 20 (page 463), implying that manufacturers were not sufficiently progressive. My experience of appliance-makers—who are, I am glad to say, nearly all personally known to me—is that they are progressive enough to go ahead if they see a good thing, and are ready to take it up without being asked twice.

Not having even seen one of your frames, I am a bit handicapped in forming an opinion, but the first thing that occurs to me is that it will be far too heavy and clumsy; besides, so much timber in a frame is quite unnecessary for the purpose the frame is intended for. On the other hand, with regard to the standard frame, there must be some millions of them in existence which have stood the very severe test of many years' use. Now, I ask, do you think your frame would stand such a test and come out as well as the standard frame has done?

You say my "83A frame" is to be "paid off," *i.e.*, has to "go" from your apiary. Well, if you do not like them clear them out. There are, however, to my knowledge, a great many bee-men (who know a few things about bee-keeping, too), who will have no other frame than the "83A" in their apiaries. It is much stronger than a dove-tailed frame as the top-bar is not weakened by dovetailing. Nor have I yet seen a single one of these frames "sag" in the middle, though myself handling a big quantity of them every year and with regard to brace-combs, I am glad to say I am very seldom troubled with them.—E. H. TAYLOR, *Welwyn, Herts.*

### BEE-KEEPING IN GERMANY.

[5004.] An English bee-keeper travelling through Germany would in vain look for an apiary where the hives were all singly set out as in his country, and he would no doubt be surprised to see the many and various kinds of hives fitted with different sizes of frames in use. He would also hear the numerous arguments for and against the various forms, arguments which one who has the true interests of the craft at heart may well wish were fewer and less severe, and that the energy thus wasted might be usefully employed for the good of all in other directions.

In Germany the hives are all put into house-apiaries, the shape and size of which varies according to the form of the hive used, and whether to be worked from above or rear. This latter style is by far the most numerous at present, though the former is no doubt gaining ground. For hives operated from above, the bee-house usually contains one tier of hives only, and in the case of those who are willing to sacrifice convenience for the sake of economy, the light is usually deficient. For this type of

hive special form of house—or pavilion—has been designed, which allows the bees to fly in three, or even all four, directions of the compass. The windows are just above the body of the hive, and the entire width of each side of the house is provided with a stand for placing hives upon. They are usually nice in design, but considerably more expensive than the old-fashioned bee-houses for hives worked from the rear.

For hives to be operated on from the rear in the last-named way (often called breechloaders) the bee-houses usually have two, and in rare instances three, tiers one above the other. The bees fly mostly to the south, and the windows are on the opposite of the house to that on which the hives stand. These bee-houses are often made roomy enough to be used as an extracting-house and for holding all appliances and implements, together with hives and frames not in use. Most of them are frame-buildings built of wood, sometimes double-walled, but seldom of masonry. Some are (all should be) models of order and cleanliness.

The most compact and economical, as well as attractive and proportionally cheapest, of all the bee-houses for the "breechloading" type of hive is the pavilion for sixty or more colonies of bees. The hives themselves constitute the walls, four and more hives (constructed in one piece) standing side by side. The front and two sides are double-walled and filled with non-conducting material; the top and bottom are of boards about  $1\frac{1}{2}$  in. thick; the interior being divided off by a division-board which must be about  $1\frac{1}{4}$  in. thick, as the frames run in grooves and thus weaken the division-board from both sides. Two—and sometimes three—of these "multihives" are placed one above the other upon a foundation of masonry, and thus form one side of the pavilion; the other two walls of the "multihives" being at right angles to the first complete three sides, while the fourth side has in it the entrance. In a small house there will only be room for the entrance-door on one side, but in the larger ones hives are placed on one or both sides of the door, unless it is preferred to use one side for tiers of drawers for holding implements and appliances not in use. Sometimes there is a row of drawers on the foundation, and the top of these form a stand for the hives, thus rendering it easier to work them than when the hives are near the ground. The four sides as outlined above do not touch each other—there is a free space of 6 in. by 10 in. left in each corner for the windows, the latter being as high as the sides of the bee-house. The windows are pivoted in the centre between the base and ceiling, so they readily turn either to the right or left on their long axis, and thus allow for the escape of bees which gather on the windows during operations. A neat flat roof, in which provision is made for ventilation, and the pavilion is finished, and the cost is little, if any, more than that of single hives for outside use, while

a good pavilion looks quite pretty in a garden or park.

It is also claimed for bee-tight house apiaries of this type that when honey is scarce one may work without danger of "robbing," and work may be got through that would be impracticable at times on account of the weather where colonies are set up singly in the open air.—J. A. HEBERLEY, *Settin, Bavaria, December 29.*

(To be continued.)

## WANTED! A FRAME.

THE FRAME ALREADY IN USE.

[5005.] I have read with much interest the discussion on this subject. I quite agree with Mr. Edwards, that a top-bar  $\frac{1}{4}$  in. by  $\frac{3}{8}$  in. is not strong enough, but I consider that  $1\frac{1}{8}$  in. by  $\frac{5}{8}$  in. is going to quite the other extreme; anyway, so thick a top-bar will not do for me seeing that I would rather have comb and honey instead of so much wood. This thick top-bar also considerably reduces the number of cells, as the extra  $\frac{1}{4}$  in. would mean two rows of cells less, about sixty-two on each side or something like 124 in each frame.

In an experience extending over twenty years, I have tried frames of all widths and thicknesses, and the one that has "come to stay" with me has a top-bar 1 in. full, in width, by  $\frac{3}{8}$  in. thick; the ends of the top-bar being reduced or cut down to  $\frac{7}{8}$  in. by  $\frac{3}{8}$  in. in order to take the ordinary "W.B.C." ends. They have also a saw-cut on under side to receive the comb foundation. I find that these bars keep quite straight and entirely prevent brace-combs. A top-bar of this size is, in my opinion, the best for all purposes; one advantage over a wider bar being that it allows the bee-keeper to get a peep down between the frames and ascertain the strength of the bees, quantity of food in the hive, &c.

With a wider top-bar this cannot be done without removing the frames. I had some frames made a few years ago with thick top-bars and with grooved side-bars, but after trial I did not like them, the grooves being an intolerable nuisance, seeing that they have to be cleaned after use, before fixing fresh foundation. This was such a task that these frames were quickly consigned to the lumber room.

In future I intend to use none other than the 1 in. by  $\frac{3}{8}$  in. top-bar, and have combs in these frames as perfect as I think they can or need to be.

If you would like to see one of these frames, Mr. Editor, I will send it along, and will tell you where they are made in Devon, the maker also turning out lock-cornered (or dovetailed) hives, &c.

I had some new "W. B. C." hives made six years ago, and fitted with these frames, which I find is all that I require in this way. I work my hives with a box of shallow

brood-frames above the brood chamber. These shallow frames are also made with 1-in. top bars. Then I work either  $1\frac{1}{2}$  in. shallow frames fitted with wide "W. B. C." ends; or sections (when required) on top of these. I never use queen excluders. In the above way of working I am never troubled with swarming, although I have over fifty hives. I may say that I go in for bee-keeping for profit, not only as a hobby.

I take it that the frame Mr. Edwards recommends (4981, pages 504 and 505) is the same that I see in the catalogue of the A. I. Root Company, of Medino, Ohio, and is doubtless manufactured by them; but I cannot see the use of such a wide and thick top-bar. In so small a frame as the "Standard" all we want is a bar stout enough to keep straight, and wide enough to prevent brace-combs, and I say that 1 in. by  $\frac{3}{4}$  in. will fulfil these requirements. I should like to see the opinion of others on the subject.—N. DEVON, *January 4*.

#### MY EXPERIENCE OF FOUL BROOD.

[5006.] I have read with considerable interest the opinions of your various correspondents on the subject of "foul brood," and, having been troubled with this pest for the past three seasons, an account of my experience may be of general interest to readers.

In the early spring of 1900 I noticed that my hives did not get on as usual, so, as the county expert—Mr. J. Palmer—was giving an outdoor demonstration at Easter near at hand, I invited him to examine my hives.

You can imagine my dismay when he declared them affected with foul brood, and advised me to destroy the lot—hives, bees, and all belonging to them—as being the only sure way of getting rid of the pest. This advice I should have carried out entirely had not some of my neighbours, who were in the same trouble, been unwilling to destroy theirs. However, I got some naphthaline and naphthol beta from the B.B.J. Office and used them according to directions. I also destroyed everything about the hives, and carefully disinfected the hives themselves with a strong solution of carbolic. In some instances I used a painter's spirit-lamp. That year's work was, of course, a failure, although the bees seemed much better in autumn.

The spring of 1901 seemed full of promise, until, about Easter, things began to go wrong again, and I fully made up my mind to "destroy the lot." Just then, however, an expert called, and told me I should be rid of it by persevering in the treatment. My hopes went up with a jump, only to go down again by finding at end of season that very little honey had been stored.

The early spring of 1902 (April 22) saw most of my hives boiling over with bees, and my hopes seemed about to be realised. You can imagine my chagrin at the beginning of

June to find the hives practically rotten with the disease. It was then too late in the season to destroy the bees and begin afresh, but I resolved to do so when the honey-flow ceased. This I did, and went through thirteen hives, destroying all quilts, comb, and all else save the woodwork. These I disinfected in a steam disinfector. During the summer I had made arrangements for a good number of driven bees (about forty lots), so that now I have ten hives doing well, fed entirely on sugar syrup and candy, and on new combs built from foundation.

When destroying the hives, I remembered one that I thought might be all right, as the bees had been placed in a clean hive on frames of foundation and removed to another garden, and fed on medicated syrup. Upon examination, however, I found nearly all the brood infected; so it shared the same fate as the others. Perhaps some one will say, "Why all this long rigmarole?" But my only answer is, "Don't dally with this scourge. The moment it is found destroy the hives containing it entirely without pity."

I tried conscientiously for three seasons to get rid of it without destruction, with the result mentioned. Should it ever again appear in my hives all those affected will be burned, for I am now convinced there is no reliable cure. I have proved Mr. Palmer's advice to be correct. I shall still continue to use preventives, but certainly make no attempt to cure by their use, being convinced that, no matter how populous the bees in a hive are, it will do no good if affected with foul brood, as the bees get exceedingly languid, but vicious when handled.

There is one source of infection which to my mind is not fully recognised—viz., wasps. These prowl from one hive to another, and carry infection wherever they go.

The Editors promised a year or two ago to investigate this matter when I sent them a queen-wasp, which came out of a nest near my hives, and I have been watching for the result ever since. I have no doubt in my own mind that wasps suffer from foul brood as well as bees, having seen dead and rotten brood in more than one nest. How, then, can bees be cured and protected when wasps invade everywhere?—E. W., *Bridgnorth, Salop, Dec. 29*.

[It is to be regretted that Mr. Palmer's advice was not followed in the first instance. Regarding wasps and foul brood, we have had no reliable confirmation of the theory that wasps suffered from that disease.—EDS.]

#### KEEPING HONEY IN LARD TUBS.

[5007.] On reading over query 3011 (page 518) and also your editorial reply, my wife exclaimed "Yes"—and she is a successful experimenter in such matters—"and the next best thing he could do with that honey would be to make it into mead. Much of the ill-

flavour would be worked off in fermentation, and the remainder could be disguised with a few cloves, ginger, spice, or what not, according to taste.—H. L., *Bexley Heath*.

### THE FRAME QUESTION.

#### CHEAP HOME-MADE HIVES.

[5008.] In the face of so much severe criticism, I fear I am, perhaps, taking a bold step, in speaking up for the heavily abused "Standard frame," and were I not fully convinced, that many of the so called faults are those of the individuals using them, I should have hesitated in giving my own views.

We are told that the frames "sag," but that I contend is the fault of bad "wiring"; anyway mine do not, and I therefore send you particulars of my method, for which I claim several advantages as follows:—

We will suppose an ordinary "Standard" frame is knocked together and laid flat on the work-bench. I drive wire gimppins (not cut nails, as these often split the wood) at the four corners of side-bars; next, with a very fine bradawl, bore holes ( $1\frac{1}{2}$  in. from top and bottom) in side-bars of frame (these four holes we will call A, B, C, D). Then on upper face of the side bars drive two more gimppins, leaving their heads projecting about  $\frac{1}{16}$  in. (these pins we call E, F).

In "wiring," the end of wire is inserted at D, carried through A, twisted twice round the projecting head of "pin" E, which is then driven home; the other end taken up outside, is poked through C, carried through B, pulled tight, and fastened round the projecting head of "pin" F in like manner. The wire, so fixed, is thus so beautifully tight that you could play a tune on the strings, and it also materially strengthens the frame.

The foundation is next inserted in the saw-cut, and a large bradawl, with a V cut in the end and heated in a lamp, drawn up and down each wire. You then have your frame complete, beautifully neat, and without fear of foundation falling, if the quality is right.

I have some hundreds of these in use, standard and shallow, and not one has ever given way in any shape or form; and, with proper care and cleanliness, I do not suffer from wax moth.

I even transgress still further by using what are sometimes called "those abominations," metal ends, and intend to continue in my own benighted fashion instead of constantly grumbling, until some one is found with sufficient brains to invent a real improvement.

Your correspondent "Basswood," speaks (on page 518) of hives which cost 3s. each. I have four hives I made in 1900, out of 1 in. timber, to take ten "Standard" and twenty shallow-frames (or two racks of sections in lieu of latter) with stand and floorboard, extra super, and top to match, which when painted three coats, they cost me the sum of 2s. 7d. each! If any of your readers care for particulars, I

shall be pleased to furnish them later on. I send my name, &c., while signing myself—"HOLLYWOOD," *Birmingham, December 29.*

### OLD BEE BOOK.

[5009.] I have a copy of Thorley's well-known "Treatise on Bees" that wants the title page, so that I cannot determine the edition or the date of issue. It is not one of the first four editions, viz., those of 1744, 1765, 1772, 1774, and it has an appendix consisting of extracts from a book called the "Natural History of Bees," published in 1744, although the source of the extracts is not fully acknowledged. None of the above-named editions contains this appendix. I shall be much obliged if any one who possesses or may know of this edition will give me particulars.—H. J. O. WALKER (Lieut.-Colonel), *Lee Ford, Budleigh Salterton, January 5.*

### BEE-HOUSES.

Whenever I have seen illustrated the different kinds of shed used by many bee-keepers I have always strained my eyes to see if it was possible for me to gain or glean a new improvement, but mostly without avail. Your Arizona sketches show the apiarists of that hot country appreciate shade for bees *and hives* at its true value; but, having no rain to contend with, their shelters are put up on a cheap rough-and-ready plan. Some Californians, too, use sheds, evidently with good results. Cuba uses the thatch-shed very largely; but it would seem a somewhat dangerous edifice, as incendiarism is all too common in some West Indian islands. But for really neat and attractive sheds we must look to Europe, though the one illustrated in *Gleanings*, belonging to Mr. Jenkins, of Wetumpka, Ala., is neatness itself, and there are probably more such in the United States; in fact, I know of several myself.

It does seem to me, however, that bee-keepers have not quite caught on to all the advantages of a proper bee-shed, while others probably dismiss it altogether as being too expensive.

Very few practical bee-keepers nowadays will dispute the value of shade for bees, though some do; but they are mostly situated far north, where old Sol is not so fierce.

There are not many who realise the value of a shed as a protection from the wet; but hives will last a great deal longer under a cover of some sort—indeed, it becomes quite unnecessary to paint them. In point of fact, it would be a waste of money to do so. But how many stop to consider the value of shade to the apiarist himself? And how much pleasanter it is to work under a cover in the broiling days of summer, just when the good bee-master is at his busiest! With a shed, the tropical bee-master is independent of the

services of that master of the tropics, the black-skinned man. Under a shed the hives are closer together than in the open—a great labour-saving invention, though it is objected to by many. Not only that, but a shed is cheaper in many ways. For my part, I believe an apiary in the open is the more costly of the two; for in a shed, shade-boards, paint, and bottom-boards are unnecessary, to say nothing of the added years the hives will last under a shed.

So far as I have noted in illustrations, none have adopted the no-bottom board idea; but it can be done very nicely by simply making a shelf for the hives to rest on, tacking down the requisite half-inch strips to raise the hives the necessary space to provide an entrance. Now that hive-material is getting up in price this is worth considering. A further reduction can be made in the hives by using thinner material— $\frac{1}{2}$  in. instead of  $\frac{3}{4}$  in. The top can be made of the cheapest material in the lumber trade, and still be superior to an expensive cover out in the open. It pays to have the shed properly constructed; for example, the hive-shelves should be perfectly level, as being a preventive of badly shaped combs.

With regard to the shelves, it is well to have them high enough to avoid stooping when lifting heavy supers, or when examining brood-chambers. This is no small matter, I can assure you. Some raise their hives high enough (2 ft.) to keep toads from devouring the bees; but small-meshed wire netting, 18 in. high, is sufficient if tacked around the outside of the shed. Ants may be kept away by the use of soft pitch daubed at the foot of the supporting posts.

What is the cost? Fifty or sixty cents per hive, according to locality. The cost in the open is about a dollar, thus:—Hive-stands, 25 c.; cover (shade-board), 43 c.; bottom-board, 32 c.; paint, 10 c.; total, 1 dol. 10 c.

For fifty hives a shed 60 ft. long and 8 ft. wide is required. The aisle is 4 ft. wide, and the hive shelves take 2 ft. on each side. The shed is preferably run due north and south, which allows the early morning sun to strike the hives on the east side, and the setting sun-beams on the western side. This has the tendency to keep the hives dry. At the same time, the bees are effectually shaded during the midday heat, and thus the bee-keeper is master of the situation.

If any one doubts the value of a shed let him try a few colonies under the shade of a tree, and watch the difference in the behaviour of the bees under the two plans. The shed can, of course, be modified to suit varying conditions; and in cool localities it would be easy to make a sort of cellar of it. Where cool nights stop the comb-builders at their work, shutters can be applied so as to retain the heat of day over the night. The shutters could be readily arranged to be opened at sunrise by a clock.

There is no doubt in my mind that bees in

the cool nights of northern latitudes consume considerable quantities of stores in maintaining the necessary temperature of the brood nest. Of course, double-walled hives obviate this to some extent.

One very nice advantage of a bee shed is the immunity it gives from stings. Even visitors may pass up and down between the rows, without veils, and yet receive no souvenirs. But the main advantage is the great relief it affords the apiarist himself. He is protected from the sun and rain (so are his tools); lifting is reduced to a minimum, and work can be done which would probably be deferred in an open apiary. For lady apiarists a shed is a *sine quâ non*. For the tropics it is indispensable. — W. K. MORRISON in *Gleanings* (American).

## WEATHER REPORT.

WESTBOURNE, SUSSEX.

December, 1902.

Rainfall, 1.73 in.	Sunless days, 12.
Heaviest fall, .41, on 1st.	Below average, 9 hours.
Rain fell on 13 days.	Mean maximum, 45°.
Below average, 1.17 in.	Mean minimum, 35.5°.
Maximum temperature, 54° on 18th.	Mean temperature, 40.2°.
Minimum temperature, 21° on 7th.	Above average, 1.9°.
Minimum on grass, 17°, on 7th.	Maximum barometer, 30.63° on 23rd.
Frosty nights, 11.	Minimum barometer, 29.10° on 30th.
Sunshine, 51.6 hours.	
Brightest day, 2nd, 5.6 hours.	

L. B. BIRKETT.

## WEATHER REPORT

FOR THE YEAR 1902.

Rainfall, 26.55 in.	Sunshine, 1,599.4 hours.
Heaviest fall 1.24 on August 18.	Brightest day, June 26, 15.5 hours.
Rain fell on 172 days (average 170).	Sunless days, 69 (average 61.6).
Below average, 2.13 in.	Below average, 273.3 hours.
Maximum temperature, 82° on July 15.	Mean temperature, 48.1°.
Minimum temperature, 19° on February 16.	Above average, 0.4°.
Minimum on grass, 7° on February 16.	Maximum barometer, 30.98° on June 15.
Frosty nights, 61 (above average 0.6)	Minimum barometer 29.10° on December 30.

L. B. BIRKETT.

Westbourne, Sussex.

## GLEANINGS FROM FOREIGN BEE JOURNALS.

BY DR. R. HAMLYN-HARRIS, D.S.C., F.R.M.S., F.Z.S.,  
F.E.S., ETC.

*L'Apiculteur*.—There are several varieties of bees in Madagascar. The ordinary black bee is seen there, but the oftenest met with is *Apis unicolor*, a black bee a little smaller than *Apis mellifica*.

*Apis Indica*, the smallest bee known, has also been found.

There is also a bee with a brown body covered with a yellow down, called by the natives "Tantety."

These varieties are not all equally easy to domesticate, as many are apt to forsake their hives and return to their wild state. Some kinds are very aggressive, and the natives are much afraid of them.

The hives are usually simple trunks of trees hollowed out, or earthen cylinders 60 to 75 centimeters high. In one province the hives, which are hung in the trees, are of wood and barrel-shaped.

As a general rule the natives eat the honey taken from the wild bees, still in some provinces there are numbers of hives. The honey varies with the district, that of the eastern provinces is the best, some is rather bitter tasted, sometimes even acrid. The wild bees' honey is generally brown or red in colour, but that from domesticated stocks has a fine golden tinge. In the north of the island there is a poisonous honey, several plants are accused of yielding injurious nectar. The natives have noticed that ants never eat deleterious honey, and regard therefore the presence of this insect as a sure indication of the wholesomeness of the store. The honey produced in Madagascar is all consumed on the island. There are no exports.

*Revue Internationale d'Apiculture*.—A writer from Moscow, in Russia, gives his experience on the use of honey-dew mixed with honey as a winter food. All the colonies near the forests collected honey-dew from the trees for quite a month, and all the honey was mixed with it largely. The bees all succumbed during the winter. The nearest neighbours lost 335 colonies, only retaining twenty hives, and those in a very exhausted state. The writer only kept one hive out of thirty-two.

*The Same*.—In Calabria (Italy) swarms are induced to settle according to the wish of the operator by the use of lemon leaves or rind, or water perfumed strongly with the same. The bees become perfectly docile, and allow themselves to be hived without any difficulty.

*Bienenwirtschaftliches Central Blatt* (from the *Preussischer Bienenzeitung*).—A Swiss bee-keeper came to the conclusion that a thunder-storm seriously hinders the work of the bees; he noticed also that thundery weather completely stopped their honey gathering. The same facts have been observed in other parts,

Bees-keepers on the great heaths in North Germany found that thunderstorms with heavy rain were less injurious, the worst that could happen was that the flowers were "washed out" and would yield no immediate harvest; whereas, in case of lightning without rain the flowers are rendered incapable of yielding nectar—this is especially feared when the buckwheat and heather are in bloom.

## Notices to Correspondents & Inquirers.

All queries forwarded will be attended to, and those only of personal interest will be answered in this column.

A. W. C. (Staffs) and others.—*Names and Addresses of Correspondents*.—We do not, as a rule, furnish names, &c., of correspondents whose contributions appear under a *nom de plume*, unless with consent of writers. This restriction is obviously necessary, in view of the trouble it might cause to persons who have neither time nor inclination to engage in private correspondence. On the other hand, where consent is given, we willingly address and forward stamped envelopes when sent, as we have done in the instance under notice.

"BALLYMENOCH" (Belfast).—*Renewing Combs*.—It is best to renew combs or replace defective ones gradually, *i.e.*, two or three each year. The most suitable time to start is early spring, or when the number of bees in hives warrants the extension of brood-nests known as "spreading brood." In doing this remove an outside comb, and part the frames on which the bees are clustered, to afford room for inserting a frame (fitted with full sheet of foundation) in place of the one removed. A week later, if weather keeps warm, the operation may be repeated, but we do not advise renewing more than three combs in a single season, and care must be taken to remove no old combs containing brood.

E. W. B. (Guildford).—*Suspected Combs in "Wells" Hives. False Alarms*.—While it is always best to err on the safe side when dealing with foul brood, we cannot help regretting that you did not delay destruction of the suspected combs till our reply was received. As a matter of fact, the sample of comb (beautifully packed for inspection) is perfectly free from disease, the cells containing nothing worse than fresh pollen, suitable for immediate use. The comb (wired and flat as a board) being only a season old makes us sorry to know you have destroyed them, and we may also say it is morally certain that the bulk of the bees have not died, as suspected, but have "gone over" to other compartments of the hive.

\* \* Some Letters and Queries are unavoidably held over till next week.



## Editorial, Notices, &c.

### LIQUID FRUIT SUGAR—WHAT IS IT ?

(Concluded from page 12)

Those of our readers who are chemists will know the chemical difference between the various sugars, but for those who are not an explanation is necessary.

Fruit sugar is called *levulose*, and grape sugar *dextrose*, both belonging to the glucose group, and are represented by the symbols  $C_6H_{12}O_6$ .

A mixture of levulose and dextrose is understood by chemists to be *glucose*.

Cane sugar, boiled with dilute acids, is split into equal parts of dextrose and levulose, *i.e.*, converted into glucose. The mixture of the two is called *invert sugar*. From this it will be seen that invert sugar and glucose are synonymous terms.

There is, however, another substance in commerce which goes by the name of glucose, and it is manufactured from corn starch in the United States and potato starch in Germany, by boiling it with dilute sulphuric acid, and removing the excess of the acid with chalk. If in this treatment the transformation is not complete the product is an impure glucose, and consists of a mixture of dextrose, maltose, and dextrine. Now, in order to arrive at what this substance sold by the name of fruit sugar really was, the following correspondence has passed between ourselves and Messrs. Hume & Co. :—

“DEAR SIRS,—Referring to liquid fruit sugar, this is in reality invert sugar—glucose. What is the difference between it and glucose?—Yours truly, T. W. COWAN.”

“DEAR SIR,—Referring to your letter of yesterday's date, *glucose*, as generally understood, is made from starch (potatoes, maize, &c.), and is composed of dextrose, maltose, and dextrine; but *inverted sugar* is a mixture of dextrose and levulose, that is to say, practically the same sugar as found in fruits.—Yours faithfully, D. A. HUME & Co.”

“DEAR SIRS,—I do not think you quite understand my question of the 8th inst. I did not ask about the composition of ‘glucose as generally understood,’ but about *glucose per se*.

*Glucose* is a mixture of levulose (fruit sugar) and dextrose (grape sugar).

*Inverted sugar* is glucose, being a similar mixture to levulose and dextrose.

You say *liquid fruit sugar* is a mixture of levulose and dextrose, and is therefore *inverted sugar*. What is, therefore, the difference between your *inverted sugar* and *glucose*?—Yours truly, T. W. COWAN.”

“DEAR SIR,—Replying to your letter of the 10th inst. *Inverted sugar*, which is sometimes called glucose, is a mixture of levulose and dextrose, and that is the nature of our

liquid fruit sugar. Glucose—sugar made from starch by treatment with sulphuric acid—has an entirely different composition, being a mixture of dextrose, maltose, and dextrine, and would, of course, be of no use for feeding bees.—Yours faithfully, D. A. HUME & Co.”

From the above letters it will be seen that this fruit sugar is not levulose only, as its name would imply, but is in reality *glucose*. Pure it may be, and thus differing from commercial glucose, but still glucose.

We have read the whole of the article sent with the above letter, and from it we gather that Dr. de Planta was deceived by the name, and that this substance is not *fruit sugar* at all, but *invert sugar*, or, in other words, *glucose*. The quotations as given are quite correct translations, but the whole of Dr. de Planta's statements are not given. Being too long, we cannot give the translation of the whole, but Dr. de Planta says that in making his remarks he was deceived by the name of *fruit sugar*, which implied that one-half of invert sugar (dextrose, or grape sugar) was artificially removed, for fruit sugar is only one-half of the combination called invert sugar. Further, Dr. de Planta says: “The proper name for this product of Follenius is ‘invert sugar.’ Probably they have not adopted this name because it is unpopular.”

Messrs. Hume & Co. say that the term “invert sugar” “could not be used, as it would then be confounded with glucose.” But it is “glucose,” and their own letters show it to be nothing more or less; therefore, we contend that we were perfectly justified in stating that this preparation had been introduced under a *false name*. The agents themselves say that the name was adopted so that it should not be confounded with glucose. We accept this explanation, but think it would have been better had they called it by its proper name.

Dr. de Planta gives us a clue to the reason when he says it is probably because glucose is unpopular. Glucose is, and has been, the enemy of bee-keepers, and every honest bee-keeper is bound, for his own protection, to make war against it. All the adulteration of honey has been carried out by means of glucose, and it is this competition of glucose with genuine honey that has brought the commercial prices down so low.

In his article Dr. de Planta further says that although composed the same as invert sugar, of equal parts of levulose and dextrose, they may not have the same physiological action in this combination. For although the carbohydrates and albumen have the same composition, yet physiologically they act differently. Dr. de Planta is therefore very cautious in recommending this substance, and only does so subject to the future experience of bee-keepers. We have gone thus far into the scientific part to show that the substance called “liquid fruit sugar” is not fruit sugar at all, but a mixture of fruit and grape sugar, and that it may possibly not have the same

physiological action as a mixture of levulose and dextrose, as is found in honey. However, this aspect of the question is not of so great importance to the bee-keeping industry as the one we shall allude to later on.

Dr. Follenius says because this so-called fruit sugar is like honey, a composition in equal parts of dextrose and levulose, that fruit sugar is therefore honey without aroma. We most emphatically deny this, and claim that the aroma is one of the principal constituents of honey, and that no compound without the aroma can be honey. The aroma is derived from the essential oils in the plants from which the nectar is extracted, every different plant imparting its peculiar aroma. Robbed of this honey becomes nothing better than glucose, and can no longer be called honey. Then there is formic acid, which should not be omitted when speaking of its composition, besides saccharine substances peculiar to honey. Liquid fruit sugar is therefore not honey.

Objection is taken to our saying that "every quack medicine vendor can get his testimonials," and the statement is made that by this we undoubtedly infer that the testimonials are false or worthless. We are sorry Messrs. Hume & Co. have interpreted us in this way, for we did not wish to infer anything of the kind; but what we wish to be understood is that we attach no importance or value to testimonials. We have not the slightest doubt that the testimonials in favour of fruit sugar, like those in favour of patent medicines and appliances, are perfectly genuine, and express the *bonâ-fide* opinions of the writers, who honestly believe that they have in effect been cured by them when really the cure ought to be attributed to some other cause, and not to the remedies taken. We know several such instances amongst our own acquaintances, so that although testimonials may be genuine, and be received from such respectabilities as "generals, mayors, lawyers, professors, doctors, and editors," we do not attach much value to them. We will give an example. Some years ago we heard of the revolution the invention of Körbs was about to create in bee-keeping. This one-sided foundation was taken up largely by bee-keepers in Germany. Testimonials as to its value to bee-keepers poured in on all sides. Editors of bee journals were carried away by the flood, and even such an experienced bee-keeper as M. Gravenhorst, whose knowledge of bee-keeping no one can doubt, very strongly recommended it. The whole thing has turned out a complete *fiasco*! How about the testimonials in this case? Must we suppose that they were false, or that those whom we considered always as respectable authorities were deceiving? No, certainly not; but we take the more charitable view, and believe that, although the testimonials are worthless, the writers really believed what they were stating—erroneously, as it was subsequently proved.

We now come to the last objection urged against our mentioning "unlawful purposes" as applied to feeding bees. We would here refer to Dr. de Planta's paper sent to us, in which he makes a second reservation as to the facility for adulteration which this product of Dr. Follenius offers. He did not enter fully into this question; but it is one that concerns bee-keepers, and we feel bound to do so. We have stated that *glucose* has been the enemy of bee-keeping. At one time this country was flooded with so-called American honey; this, as was proved by analysis, consisted generally of nothing but glucose. The British Bee-keepers' Association, recognising the injury that was being done not only to bee-keepers generally, but to the public also, commenced a war against these adulterations, and was the means of destroying the trade in false honey. The introduction of this so-called fruit sugar opens the door for its use in adulteration, and if it is countenanced by Bee Associations the same battle will have to be fought over again. But it would be much more serious than formerly, because from its impurities commercial glucose was much more easy to detect. Then, again, it is putting a temptation in the way of unscrupulous persons, not only to mix it with honey, but also to allow it to be mixed with honey by the bees. The practice of feeding bees with sugar-syrup for the purpose of making comb-honey has been stopped, such syrup-fed comb being easy to detect; but the use of this substance would be much more difficult to detect, and would make fraud only too easy. It has been generally thought that granulation was a guarantee of the purity of honey, but this substance granulates, therefore this test would be useless. These are what we call "unlawful purposes," and bee-keepers know perfectly well what we mean when we use these words. We have to protect the interests of bee-keepers and to put them on their guard against using substances that are likely to injure the industry.

The public is already, from a want of knowledge, only too ready to believe in adulteration; therefore bee-keepers cannot be too particular in avoiding the introduction of any artificial products that could be used for adulteration. We have pointed out that in pure cane sugar we have everything the bees require. The conversion of the sugar costs the bees nothing. In this artificial product there is 25 per cent. of water and only 75.07 per cent. of sugar, and this sugar is not fruit sugar but glucose. We consider beet-root sugar not suitable for bees under any circumstances, and cannot recommend a substance manufactured from beet-root sugar as one suitable to replace cane sugar. Had we room, we should like to translate and reproduce an article from the *Revue Internationale*, which points out what would be the result of the introduction of this substance into the apiary, and cautions bee-keepers that if they are anxious for the reputation of their honey,

never to purchase any of this syrup, or allow it to be introduced into their apiaries. We do not mind under what name glucose may be introduced, we shall feel bound to caution bee-keepers of the great danger they may incur by its introduction into their apiaries, and thus to protect the interests of bee-keeping.

British honey has hitherto made for itself a reputation for being what it purports to be, viz., honey—some good, some bad, some indifferent, but *honey*, genuine as gathered by the bee from natural sources; but once let us countenance the use of glucose in any shape or form for feeding bees, and we may bid good-bye to bee-keeping. In our opinion it would surely and certainly destroy the confidence of consumers in the purity and genuineness of the product, and so far from using it as a table luxury they would give it as wide a berth as is now given to much of the foreign stuff so nearly unsaleable here. The gentlemen who would force this "liquid fruit sugar" into notice as good for feeding bees, not being bee-keepers themselves, do not see the harm they will do the pursuit, otherwise, we charitably presume, they would spare us. *We* do see the danger, and we trust that our readers will see it too.

#### THE TESTIMONIAL TO MR. J. M. HOOKER.

We have received for publication the following letter:—

4,422, Chestnut-street,  
Philadelphia, Pa., U.S.A.  
December 30, 1902.

DEAR MR. BROUGHTON CARR,—I shall be much obliged to you if you will insert in the BEE JOURNAL this my heartfelt thanks to my old friends and bee-keepers for the honour they have done me in sending the very handsome testimonial and illuminated address on my leaving the dear old country.

Those who have attached their signatures to the same will, I trust, accept this acknowledgment of my sincere gratitude for their kind wishes and appreciation of my endeavours to advance the bee-keeping industry in Great Britain.

To me practical bee-keeping has been a great source of pleasure. It has brought me into contact with many whom I can still look upon as dear friends, while many, alas, have passed away, and among those with whom I co-operated in the initiation of the British Bee-keepers' Association only the Hon. and Rev. H. Bligh is left.

I also take this opportunity of expressing my thanks to the Council of the B.B.K.A. for the uniform kindness received at their hands during the many years I was a member of that body, and I bear willing testimony to the cheerful way in which they have given their

valuable time with the anxious desire for the advancement of bee-culture.

With the best wishes for the health and happiness of all my kind friends, and for the success of bee-keeping,—Believe me, yours sincerely,  
JOHN M. HOOKER.

## Correspondence.

*The Editors do not hold themselves responsible for the opinions expressed by correspondents. No notice will be taken of anonymous communications, and correspondents are requested to write on one side of the paper only and give their real names and addresses, not necessarily for publication, but as a guarantee of good faith. Illustrations should be drawn on separate pieces of paper. We do not undertake to return rejected communications.*

#### NOTES BY THE WAY.

[5010.] *Frames.*—The discussion on frames still continues, though I fear we shall by a large majority still stand by the "Standard" as it was and is. The ventilation of ideas may, however, lead the few to adopt a wider top-bar, which also will certainly be a stronger bar, even if the same thickness as the present "Standard." For myself I have a few hives with the ordinary "Standard" with metal (tin) ends, and where there is a "knot" in wood about the centre of top-bar it generally sags at this point. I use, and like, Abbott's pattern of top-bar, which, although of "Standard" size, never "sags" with weight of combs. The "hook" (all the bee-space is on one side) forms a capital handle to hold the frame by; this may be a minor point with many, possibly because they have never enjoyed the pleasure of handling this pattern. There are no "ends" to slip off and let the frame fall or drop off and get lost in the grass. The frames with wide top-bars I have in use contain decidedly better shaped combs, though the narrower openings are (as two or three of our friends say) an impediment to a casual glance at the patches of brood; but with the long or "combination" style of hive this is of little importance as the dummy is easily moved back a little so that the combs may be divided for view or manipulation. I have in use ten-frame hives, twin hives, "Sandringham" hives and several single-walled hives holding only nine frames, but for an all-round hive for winter as well as summer use I still stand by the "Combination." Possibly the fact that my apiaries are mainly run for section-honey may influence my selection as best adapted—in my opinion—for its production.

*Size of Sections.*—Messrs. Devereux refer (on page 8) to the discussion some time ago on tall versus square section. I expect the majority of comb-honey producers still use the old 4½ in. by 4¼ in section, rather than go to a big expense for new racks and dividers. I have only worked a few tall sections and my customers do not like them; in fact, I have had to include them in "clearance lots" to get rid

of them as third grade quality. My own experience, therefore, is not an incentive to produce them another season.

*Tits and Bees.*—I notice the tits are busy among the hives again since we have had the frosty weather, driven here by stress of hunger, though I cannot say they are welcome—not even on Christmas Day. We have had a mild, wet spell of weather, but not a good, warm, sunny day such as the bees enjoy when they get a good cleansing flight. It is now some time since there has been any general flight in my apiaries.

*Honey Confections.*—Mr. Rose has sent me a few "honeydrops" made by the Rev. B. Colman. There is a full honey-flavour to them, almost as though it was a small lump of heather honey. The thought struck me as we sampled them that, providing there is very little demand for heather honey, here would be an outlet for a considerable quantity. A gentleman at Reading some years back used to make some excellent "honeydrops" and tablets, and when kept in tins would be dry and nice many months after making, but I understood from their foreman that honey was a very difficult article to deal with in boiling along with sugar. This was, I believe, the main difficulty with honey biscuits.—W. WOODLEY, *Beedon, Newbury.*

## EXPERTS AND FOUL BROOD.

### USE OF CRUDE CARBOLIC ACID.

[5011.] Referring to the letter "Notes from the Lake District," page 453, I would further reply to your correspondent, "Heather Honey" (4979), that it is a fact that the carbolised cells do become clean, and are used again for brood raising, in which he agrees, but adds his belief that every bee which has assisted in the work of clearing out these cells will have been destroyed, and gives his idea that the carbolic will evaporate, is imaginary.

Exactly how the carbolic disappears, and how soon, is an interesting question, therefore I ask will "Heather Honey" kindly make some experiments towards deciding it, and give the results? Some one with an observatory hive might also do so.

We have had a great amount of disease to deal with, but there are no grounds for believing that any harm has resulted to any stock from the treatment in consequence, and we had come to the conclusion that the carbolic evaporated. This leads me to ask, will some careful bee-keepers in the county note these cells in future, and our expert will do the same. For myself, I cannot think it likely that a bee would go near to carbolic, and much less touch it, whilst still retaining burning or strong smelling properties. (What do our Editors think?) Might the carbolic crystallize, and thus in a dry state be cleared out without injury to the bees that touch it, against which the nature of

the bee's external covering (chitine) to its claws might give protection. In conclusion, I will illustrate by quoting two cases:—In 1901, our expert—and I was with him at the time—came across a stock with brood rotten with disease, and owing to circumstances it was impossible to disinfect the hive in our usual way; so, after burning quilts of brood-nest and scorching as best he could the inside of hive at the bonfire, the bees were run back into the hive on new frames and foundation. In June of 1902 this stock was found to have six diseased cells, *propolised over*, which our expert carbolised. Three months afterwards this stock was re-examined for sale purposes, and the brood was found to be all healthy, and there was no trace of the carbolised cells.

Our expert, before he left home, carbolised six cells of healthy brood in one of his stocks, and on return from his tour found these cells with pellets of propolis for coverings. I asked him if the carbolic was still liquid when he removed the capping? He replied, "No, the cells looked clean." Then I said, "Was it crystallised?" "No, he could not detect any crystals; the cells looked clean, and as such that he thought bees would use." "Did it smell?" "No," and on examining next time, "could not tell which were the cells that had been treated."

The above are two ways in which the bees have been found to manage these cells, and our experience is that, in the majority of cases, the bees will propolise them over, and leave them so, unless the bee-keeper uncaps them himself (and not "invariably clean them out," as "H. H." finds). Probably, in the instances that "Heather Honey" names, more than twelve cells were treated, in which case the bees would leave the hive on account of the smell, or possibly the carbolic was dripped about. The few odd cells of disease found in a stock that made a new brood-nest the season previous are probably the last remains of disease, which the carbolic "dropper" destroys in a neat and simple way, and is thus more destructful of brood than cutting out the infected cells, which necessitates much live healthy brood being also cut through, and is a messy job, that may attract robber bees, or then, again, destroying the whole brood-nest for the sake of these few cells?—G. M. SAUNDERS, *Hon. Secretary Cumberland B.K.A., Keswick.*

(Correspondence continued on page 26.)

## HOMES OF THE HONEY BEE.

### THE APIARIES OF OUR READERS.

The picture of the Rev. Mr. Adams's beegarden shown on next page suffers somewhat in appearance, being enlarged from a very small photo. It is, however, typical of the present wintry weather, and welcome as a Home of the Honey Bee occupied by a B.B.J. reader now departing to a new field of clerical labour in Jamaica. We trust our

rev. friend will carry with him his old interest in the bees and impart of his knowledge regarding modern methods of bee-keeping to the people among whom his future lot is being cast. Of himself he writes:—

“Hearty thanks for honouring me and mine with a place amongst your ‘Homes of the Honey Bee’; but as our present far-reaching ‘fitting’ preparations—as you know, we are leaving this country for Jamaica—are pressing hard upon us, any ‘notes’ from me must, I fear, bear the impress of haste. The birth of my practical interest in bees dates back about a dozen years or so, owing to the gift of an old straw skep stock from a veteran bee-keeper in a neighbouring parish, the carriage

of a standard-frame hive out of any old boxes lying about for any poor bee-keeper who knew practically nothing about bar-frames. And it might surprise your readers if you could tell them how many such districts still exist in Scotland. But when I could back up my innovations with intimations from my own experience of such harvests as 60 lb., 80 lb., 100 lb., and sometimes even 112 lb. of honey in one season from one of my stocks of bees so housed, the old ‘straw’ prejudices of such friends were thrown to the winds, and when saying good-bye for the holiday season, there were frequent ardent invitations to come back again and spend my holiday in the same fashion.



THE REV. THOS. ADAMS'S APIARY, U.F.C. MANSE, CUMBERNAULD, SCOTLAND.

from which place to my own cost me 5s. From the very first, however, I never felt satisfied with such hidden hermaphroditism. That mystery was deep enough without adding to it the secrecy of an old straw skep. Accordingly, I started and made a double-walled frame-hive to take the ‘Standard’ frame, and bought a ‘swarm’ for 15s., and I put it into the newly-made hive. Thus the outcome of my first year’s experience was unproductive both in money and honey, yet the income was great in the twofold sense of a more intelligent interest in real apiary work, and in a new recreation in appliance work. Consequently, one of my special enjoyments when on a holiday to the North or West Highlands—at coast or country—was the making

“I have never kept more than a dozen, and never less than two stocks, at one time, and so far I have not once been afflicted with foul brood, as I took a pride in keeping my hives clean and tidy both inside and outside of them. I think when a bee-keeper lacks such pride he should seriously consider his ways, and correct them as soon as possible. Sometimes I have taken a few stocks long distances by road and rail to the heather, but I am sorry to say always at a loss, and so for the last few years I have contented myself with the flow from the clover, the one chief source in this district. I have tried the usual 1-lb. and 2-lb. sections, but I find that the shallow-bar frames, divided equally into two parts by two adjoining pieces of wood in the centre, are

taken to far more readily by the bees, and when the two parts are (easily) sawn asunder, they are just about the same weight as the 1-lb. section, and as readily disposed of to the purchaser. This contrivance I regard as one of the special helps to the large 'takes' which I have sometimes had, another special help being large air-spaces in the bottom of hive, with sliding doors to be moved according to the temperature, while top and sides are packed as securely as possible. The 'commercial frame,' too, has found a place in my apiary, and did well enough except for two rather serious drawbacks—its over-weightiness for pleasant manipulation, and its unsuitability for interchanging with the 'Standard' frame hive.

"I have tried almost all the non-swarming plans, but find, on the whole, that while exercising all reasonable care, it is well to let the bees have their own natural way of swarming, storing, and even 'stinging.' For in regard to the last mentioned—stinging—the novice should be plainly told that it is part of the price which every worthy bee-keeper has to pay for any success he may have beyond the common measure; and in the end it is the surest way of getting above that ever-present difficulty of bee-keeping. Fear of stings, fewer sections; the more stings the more strong to stand them.

"A prominent feature in my apiary is the 'bee-house,' but it was made too small, 6 ft. by 4 ft., to be of much service for holding bees, and therefore I have used it almost entirely for storing appliances. And I think the ideal apiary is where each stock of bees is under its own separate roof.

"Many a pleasing as well as perplexing experience I could relate, but my space and time are exhausted, and therefore I close by wishing you and all your readers 'A Happy Honey-New-Year.'"

#### CORRESPONDENCE.

(Continued from page 24.)

#### BRITISH VERSUS FOREIGN HONEY.

[5012.] In your issue of January 1, page 8, Messrs. H. & F. Devereux express the opinion that "no English honey is used, as a rule, in the manufacture of confections, &c., because cheap foreign honey answers the purpose as well." I agree with your correspondents—and others who have written on the same subject—that in most cases this is but too true. But the following incident will show how much confidence can be put in the productions of those who use this cheap foreign honey. "One evening," says one of my French friends, M. Godon, President of the Association of Bee-keepers of Bourgogne (Burgundy), "I entered a store in Paris; the store-house was large, but in so obscure a part of the premises that at first I was almost unable to see anybody. On going nearer, however, I saw

*employés* working on top of rather high tables; they were manipulating a kind of white substance, and around them were barrels of various sizes. The largest of these casks was stood on the ground between two tables, and the others were suspended above it. One of the *employés* came near me, and, judging by his perplexed countenance, as also by the marked obscurity of the place where the work was being done, I thought that some unfair business was going on. I, therefore, said to him: 'What are you doing there in the midst of all these barrels?' He answered without hesitation or with any malicious tone: 'We are making honey.'"

It is easy to understand why such honey (?) is cheap. My friend M. Godon adds that he "has tasted it in many big hotels on the Continent, and, as far as he could judge, it was an indigestible composition, made with glucose, molasses, foreign honey, perhaps even flour, the whole aromatised with good and genuine honey." Now, I would ask, what is understood by "foreign honey"? Is it honey made by men or by bees? We know that bees have been appointed by the Creator to gather the delicious and wholesome nectar we call honey; and such foreign honey as is gathered by bees cannot be objected to, but may be used without suspicion of dishonesty. But the concoction referred to above should not be called honey at all. The fact that foreign honey is so much cheaper than the home product naturally gives rise to suspicion. Considering that the expenses connected with importing and commission on selling here, I ask: How could it be offered at 3d. or 4d. per lb.?

About three years ago our Rev. Procurator bought 50 lb. of foreign honey from London for the purpose of making hydromel, but the aroma and the strength of the beverage when made was quite different to what I make now with my own honey. The conclusion of all this, to my mind, is that a manufacturer of honey-drops or anything in the form of honey sweets or confections, if he is an honest man, ought to use the foreign honey with great reserve, and assure himself that what he uses is genuine honey, otherwise the articles manufactured would, instead of being a wholesome thing, contributing to better health, may be a very hurtful one.—B. COLOMBAN, O.S.B., *Buckfastleigh, Devon.*

#### NOTES AND COMMENTS.

[5013.] "*Shook*" Swarms.—Mr. W. Woodley, in his "Notes by the Way" of December 18 (page 504), refers to what appears to be some new "dodge" found out by the Americans, which will, they say, enable them to "prevent natural swarming and increase the honey crop," among other good things.

It would be interesting to have some more particulars regarding the above, if Mr. Woodley can give them?

It is, however, rather humiliating that we

should have to look to America for progress in this line, but then, as this country is finding out, the "Yankee" is aiming at the foremost place with everything, just because he is free from the conservatism which prompts the "Britisher" to look with suspicion on anything "new." Methods which have proved successful in the past must, of course, be adhered to until something better is found, but that "something" cannot be found, unless it is sought for. If our honey flow is short there is all the more need for making the most of it, and that can only be done by bringing every stock in the apiary up to the level of the present "best."

*Improved Frames.*—Mr. Edwards (4981, page 504), claims to have discovered a really good frame, with the wedge and grooved side-bar, by means of which foundation can be securely fixed without the trouble of "wiring." I have all along used the "broad-shouldered" frame, and, in 1899, when getting a supply from a dealer, I pointed out the advantages of grooved side-bars, and asked him to send me frames so fitted, along with sheet foundation out to suit. I thought the idea would be useful; but he thought otherwise, and paid not the slightest attention to my request.

*Honey Jars.*—That is rather a good idea (on page 509) from "Blairgowrie" re putting up honey in glass "tumblers." Mr. Raitt has anticipated a want, no doubt. Honey would sell better if placed in vessels that would be useful in a home when emptied. If they could be supplied in different sizes up to 1 lb. capacity they ought to have a good sale, as they would have the additional advantage of being cheaper than the screw-top jars.—J. M. E., *Ussie Valley, N.B., January 10.*

[Regarding what are in America sometimes called "shook" and at others "brushed" swarms, our correspondent may take it from us that whenever anything new—or what we deem to be of real value to bee-keeping as practised in this country—appears in American bee journals, it is reproduced in our pages. This being so, we have so far given no particulars of what "J. M. E." terms some "new dodge" because we fail to see any improvement in, or much, if any, practical difference between, the "new dodge" and the well-tried methods of making artificial swarms practised in this country for many years past. Our American friends "shake" or "brush" bees (with queen) from combs and run them into a beeless hive, thus making up a "swarm." We might suggest our friend, John H. Howard, giving us in print his rough and ready plan of securing the same object as told to us several years ago. It was, we think, "one better" than any way we have heard of getting a "shook swarm."—Eds.]

#### DEALING WITH FOUL BROOD.

[5014.] I have read with feelings of compassion the different phases of the struggle

against foul brood described by your correspondent "E. W." in your issue of January 8 (5006, page 17). I quite endorse the view of the county expert who advised him to "destroy the lot, hives, bees, and all belongings." In the case in question there was nothing else to be done, as nearly all the brood was rotten. I heartily wish our friend more success with his newly acquired lot. He seems to be in the same bee trouble as myself, surrounded by neighbours more or less ignorant and careless. Under such conditions, then, his bees may ere long be again infected with diseased hives so close at hand; I think, therefore, he would not profit by the total destruction plan, if he destroys each time the pest enters in his apiary. Then, in the concluding part of his letter, he uses unnecessarily discouraging discouraging words when he says, "The moment foul brood is found, destroy the hives containing it entirely without pity." I think this view should be at once discarded, seeing that it would be of no avail for bee-keepers to destroy their bees, except in bad cases, as long as they have no power to destroy the bees of neighbours, no matter how badly the latter may be. I say, therefore, what good is there in advice which says, "burn everything" at the least appearance of foul brood? Very few bee-keepers would undertake to destroy off-hand thirty or forty stocks of bees only slightly affected, not to mention how very few would have the means of building up their apiaries again. "E. W." purchased "forty lots" of supposed healthy bees. But he may be pretty sure that they will contract the disease again unless the conditions are altered with regard to his neighbour's bees, and we may be sure he does not propose to burn them every year. Therefore the best thing to do under the circumstances is to prevent the bacilli of foul brood developing. I know by personal experience that foul brood, if dealt with in the incipient or earlier stage, can be stopped. During the first years of my bee-keeping I had foul brood, too, in my apiary, and at the present time my bees are in excellent health and condition. I had to burn one hive only. Foul brood being so prevalent in every county in England there is not much hope of destroying it entirely. But I am confident we can do much to prevent its ravages. Were this not so it would be better to give up bee-keeping altogether. Dampness of the climate is one of the main causes of foul brood being so common in this country, and there is nothing more unwholesome for bees than a damp hive. This being the case, I do not think that liquid syrup-food is suitable for bees to hive upon in winter, especially when given in the autumn as it usually is. It brings into the hive a lot of watery stuff which the bees take readily, as they will anything sweet, but this is no proof of its being wholesome. If syrup is given them the excess of moisture as to be got rid of, while, if the syrup is

thick, it is liable to granulate in the cells. Besides syrup-food excites the bees to leave the hive, and while out they start foraging about weak hives for food, which leads to "robbing," and, with diseased stocks near at hand, the inevitable result follows, which we all know of.

I have reflected much on the best preventives against foul brood, and, after having studied the question in German, French, and English Text-Books and periodicals, I find that nearly all reliable authorities declare this disease—when in the virulent form—to be incurable. The question, therefore, is what can we do to prevent foul brood from reducing vitality or crushing down the natural strength of the bees, so as to make them unable to resist infection. Could we not find some means of making bees and queens strong and more robust, thus not only the laying power of the queen but enabling the workers to resist infection and increase in numbers instead of becoming weak stocks easily liable to infection. In the end I came to the following conclusions:—

1. *Food* is the main factor, as having so great an influence on the health of every living thing. Food, moreover, properly and carefully made, for its quality depends as much on making as on the material used. Take bread, for instance. One baker uses good flour and makes bad bread, while another uses the same flour and makes excellent bread. So it is with bee-food. We often think that everything sweet will do for bees, which is a mistake, and I owe it to my avoiding this mistake and taking candy that my bees are in good condition and free from disease. To my mind candy is the best food, yet there is candy and candy, and between bad and good candy there is all the difference in the world.

2. The second factor in preserving the health of our bees is to carefully observe what is recommended by the different "Guide Books." They have been written by men who had in mind only the good of bee-keepers and bee-keeping. Every spring I thoroughly wash all my hives with boiling water, with phenyle solution added. Naphthaline is always present in my hives. Cleanness and dryness are of considerable importance in the inside of hives.

3. I also think it a good thing to introduce new blood regularly among our bees, as this tends to strengthen their condition. As for wasps, I think your correspondent, "E. W.," would not have to trouble himself about them, if his bees are strong.—B. COLOMBAN, O.S.B., *Devon, January 10.*

#### HONEY IMPORTS.

The value of honey imported into the United Kingdom during the month of December, 1902, was £279.—*From a return furnished to the BRITISH BEE JOURNAL by the Statistical Office, H.M. Customs.*

#### TOTAL HONEY IMPORTS

FOR THE YEAR 1902.

Month	value
January	£724
February	247
March	2,598
April	4,431
May	3,622
June	4,294
July	5,553
August	3,179
September	803
October	625
November	761
December	279

Total value ... £27,116

#### RAINFALL IN 1902.

At *Buttermere*, in the County of *Wilts*;  
Rain gauge:—Diameter of funnel, 5 in.;  
height of top—above ground, 3 ft. 6 in.; above  
sea level, 847 ft. :—

Month.	Total		Greatest Fall in		Number of Days on which '01 or more fell.
	Depth.		Twenty-four Hours.	Date.	
	Inches.	Depth.		Date.	
January	0.89	0.26	15th	15th	9
February	1.96	0.33	23rd	23rd	11
March	2.29	0.86	14th	14th	12
April	1.81	0.40	22nd	22nd	13
May	2.84	0.56	17th	17th	15
June	4.13	1.02	13th	13th	18
July	1.19	0.26	22nd	22nd	9
August	4.23	0.53	18th	18th	22
September	0.96	0.32	2nd	2nd	9
October	1.76	0.44	17th	17th	14
November	4.39	1.29	25th	25th	16
December	2.08	0.46	17th	17th	12
Total	28.76				166

Average for seven years 29.72. — W. E. BURKITT.—*Buttermere Rectory, Hungerford.*

#### SELLING HONEY.

HOW TO GET BEST PRICES.

The following paper by Mr. J. F. McIntyre—one of the largest honey producers in California—was read at the Convention of American Bee-keepers, held at Denver last autumn:—

"The statement that 'to him that hath shall be given,' &c., still holds good, only it should be made plainer. To him that hath money shall be given a high price for his produce, and from him that hath not money his produce shall be taken at a very low price, is the saying up-to-date. I believe that this law is as inexorable as Fate, when the words 'at wholesale' govern what is said. A poor bee-keeper could peddle his honey, selling directly to consumers who do not know his weakness, at a good price, but the large producer cannot do this; his honey must pass through several hands before reaching the consumer, and the price is governed by the market.

"It is said, 'All things come to him who



can wait.' Ah! there is the rub. How can a man wait who has hungry mouths to fill, and interest gnawing at his vitals?

"I have before me San Francisco's Prices Current of July 4, 1902. Under Honey it says, 'Buyers and sellers are too far apart in their ideas of values for much trading.' Do you know what that means? It means that those having honey to sell now in California can wait. If there was one man who could not wait the buyers would get his honey at the present low price.

"I do not know a single neighbour bee-keeper that has his last year's honey crop now on hand; they have all sold at a low price to speculators. Only a small portion of their honey has reached the consumer; the balance is in the hands of strong men who bought at a low price and are holding for a high price.

"At our conventions this is often asked, 'What are we going to do with the small producer who is too weak to hold his honey, and breaks the market?' I always look at the questioner to see if he wants to kill the small producer, let the speculators eat him up, or organise him. The question has never been answered to the satisfaction of every one present, but nearly all seem to feel as if the man had done wrong by selling so cheap.

"The big-hearted man, with the love of humanity thrilling in his breast, gets up and says, 'We really must organise these poor fellows so they will be able to hold their honey for a better price.' The stoic gets up and asks, 'How much longer one hundred of them would hold out than one, if they were all in the same fix, and must have money?' The dealers would laugh at such a weak corner on honey as that, and wait a very short time until it went to pieces. The 'bulls' must have real strength; bellowing and pawing the dust does not scare the 'bears' very much, so the organisation fails to make its corner effective, the officers are blamed, and things are in worse shape than they were before.

"Is there no hope, then, for the man who is too weak to hold his crop? Yes, there is still hope. The citrus fruit-growers have done much to solve the problem. Their product was perishable, and could not be held, no matter how much money they had. Their business got into such bad shape that they were receiving expense bills instead of returns for car-loads of oranges shipped East. They had to do something or quit the business, and they did it. They organised to sell their fruit and get honest returns. They placed agents, under bonds, in every large city in the United States. These agents kept the head office in Los Angeles posted. Eleven million dollars worth is now consigned to these agents annually, and honest returns are made to the producer, and the acreage of citrus fruits has doubled instead of declining.

"This organisation, known as the Southern California Fruit Exchange, has become so successful that the members have all become

co-operative cranks, and now propose to give other producers, who are too weak to maintain agencies of their own, the benefit of their agencies to sell their products.

"The weak bee-keepers in this 'neck of the woods' may now organise and market their honey at any time of the year through these agencies. The producers are finding out that the consumers are paying a good price for all the honey they use. The speculator, who is always a 'bear' to the producer and a 'bull' to the consumer, has over-reached himself, and the bee-keepers now have an avenue through which they may market their honey without letting it pass through his hands."

## PRESS CUTTINGS.

### IMPORTS OF COLONIAL HONEY.

The Victorian bee-keepers, according to Mr. Sinclair, place a much too high estimate upon the opportunities offered by the English market to their honey exports. Apropos of a letter that recently appeared in *The Leader* from Mr. R. Reuhne, of the Victorian Apiarists' Association, I asked Mr. Sinclair to state the results of inquiries made by him within the last few months in several parts of the country, and as to the market demand for honey and the general prospects of the trade. "To begin with," he replied, "it is a mistake to suppose, as some of the Victorian growers evidently do, that there is a 'ring' in the trade. Honey is imported into England from several countries, and landed at several ports. There is no scarcity; on the contrary, the tendency is always towards a glut. No combination has ever been attempted in my experience, or thought of. There is no incentive to it, nor would it be practicable. All that was made clear to me in the course of my numerous provincial visits. There is very little opening in this country for Victorian honey—at all events, for anything like a large trade—for the simple reason that the people do not care much for honey. They do not absorb even their own honey, though they hold it superior to any other. And then the prices which it is necessary to charge are against the development of the trade. People, especially the working classes, will not pay 4d. to 8d. per lb. for honey when they can get a large variety of jams and marmalades for much lower prices, and the finest cane syrup for 2d. per lb."—*The Melbourne Age*, November 22, 1902.

## Queries and Replies.

[301±] *Preventing Swarming.*—I would be obliged for a reply in next issue of the B.B.J. to the following questions:—1. Can swarming be effectually prevented by placing a piece of queen-excluder zinc on inside of flight-hole, as well as preventing robbing by wasps? 2. Can

shallow-frames be used for breeding purposes in addition to the deeper frames? If not, what is the objection to their use? 3. Is it not colder for the bees in winter to have the frames hanging at right angles to flight-hole?—J. C. M. (R.I.C.), *Ballymena, Co. Antrim, January 9.*

REPLY.—1. Covering the hive doorway with queen-excluder zinc must perforce prevent swarming after a fashion, because, so long as the queen is kept a prisoner, the bees after swarming out will return to the hive. But the plan, after full trial years ago, was voted a failure. It led to mischief of many kinds, and sometimes to disaster in the colony, so we advise leaving that method severely alone. It will not even prevent "robbing" by wasps. 2. Yes; they are so used by some bee-keepers. 3. Whether it be colder or not, the advantages of hanging frames at right angles to hive front are, to our mind, so obvious that the drawback you name—which we do not admit—is trifling by comparison.

[3015.] *Trapping Drones*.—1. Wishing to destroy every drone from one of my hives next summer, can I do this by fixing a drone-trap at entrance on a fine, sunny day, and if so, how long would it take to secure the end in view? Also, would it be a serious obstruction to the workers meantime? 2. I also wish to secure extra drones for the fertilisation of several young queens from a special hive located in another district. Would it be any advantage to give this hive a frame of drone-foundation? 3. How many days ought this to be done in advance of queen-cell formation? I shall feel much obliged if you will kindly answer in your excellent B.B.J.—H. R., *Drayton, Norwich.*

REPLY.—1. A drone-trap of good make will rid you of undesirable drones if fixed and emptied each time the trap needs it. The time it will take to clear out all drones cannot be fixed by any one, but the best preventive is to limit drone-comb in the hive by removing all but a very few cells. 2 and 3. To be successful in securing the maturing of queens by selected drones you should consult a "Guide Book" on queen rearing; very full particulars will there be found for proceeding on the best lines.

### Notices to Correspondents & Inquirers.

Letters or queries asking for addresses of manufacturers or correspondents, or where appliances can be purchased, or replies giving such information, can only be inserted as advertisements. The space devoted to letters, queries, and replies is meant for the general good of bee-keepers, and not for advertisements. We wish our Correspondents to bear in mind that, as it is necessary for us to go to press in advance of the date of issue, queries cannot always be replied to in the issue immediately following the receipt of their communications.

All queries forwarded will be attended to, and those only of personal interest will be answered in this column.

\*\* E. A. H. (Chester) writes as follows:—"I see a discussion in your paper re heather honey. In one of the letters 'D. M. M.,

*Banff*, makes the assertion that Mr. Quayle, of Glenmay, Isle of Man, obtains a large amount of thin honey from the bell heather (*E. cinerea*). I know the district spoken of very well, and think there is no doubt whatever that much of Mr. Quayle's honey is from the wild mountain sage which grows so abundantly thereabouts. It is of the same family as the one that gives us the beautiful Californian honey."

E. B. (Birch Vale, Stockport).—*Keeping Bees for Wax-production*.—This question has been asked with some degree of possibility that it might be done in countries where honey of inferior quality is plentiful and almost unsaleable, but in this country it would not pay at all, to say nothing of its practicability, which we doubt.

F. V. HADLOW (Sussex).—*Honeycomb Designs*.—Thank you very much for sending photo of your "bees' work." The print is hardly sharp enough for a tone-block, but if it can be reproduced nicely we will publish it in an early issue.

A BEGINNER (New Brompton).—*Bee flowers*.

—1. The only flowers a bee-keeper, especially one located in Kent—the "garden of England"—needs to grow for his bees are a bed of crocus or such early flowers as yield pollen before the natural supply begins. Many beginners are surprised at their bees failing to work on flowers planted for them near the hives. As a matter of fact, the bees find more and better forage in the fields and hedgerows at a distance. On the other hand, a good-sized bed of mignonette or of borage will be eagerly worked by your own bees if the bed is large enough to keep up a supply of nectar. 2. Asters and stocks are not among the best of bee-flowers; hence the failure to see bees on them.

I. E. W. (Leicester).—*Varieties of Bees*.—

Both specimens sent are the common brown bee of this country. Thanks for your appreciation of B.B.J. Referring to error in initials, please notify the first one when writing, because printers cannot tell the difference in MS between "I" and "J."

(Mrs.) P. DEAR (Wilts).—*Mead for Show-bench*.—The usual restriction in show-schedules is to stage mead in clear white-glass bottles, the style of bottle being simply a matter for the exhibitor's own judgment or taste.

D. H. F. (Alton).—*Bee-candy*.—Sample needs a little more boiling; it is too "watery," while the grain is a bit rough through insufficient boiling. It only needs attention to above points to make it a good candy.

J. S. (Bristol).—*Improvements in Frames*.—We will be very pleased to submit the sample frames sent to the Council of the B.B.K.A. at the first opportunity, in compliance with your request. Meantime we may say a word regarding it next week.

## Editorial, Notices, &c.

### BRITISH BEE-KEEPERS' ASSOCIATION

The monthly meeting of the Council was held at 105, Jermyn-street, S.W., on Thursday, January 15, the Vice-Chairman, Mr. T. I. Weston, occupying the chair. There were also present Mr. W. Broughton Carr and the Secretary. Letters of regret at enforced absence were received from Miss Gayton, Rev. W. E. Burkitt, Col. Walker, Messrs. W. H. Harris, E. Walker, and F. B. White.

In consequence of the small attendance—attributable to severe weather—it was decided to transact only the formal business, and to adjourn all other matters to a future meeting.

The minutes of the previous meeting were read and confirmed.

The following new members were elected, viz., Mr. H. J. Barrett, 16, Borough High-street, S.E.; Mr. C. H. Boccock, Ashley Apiaries, Newmarket; Mr. John Knight, 24, Gertrude-street, King's-road, Chelsea, S.W.; Mr. Thos. Head, 46, Prospect-terrace, Nunery-fields, Canterbury.

The Finance Committee's report was received and, together with recommendations as to payments, duly approved.

It was resolved to hold the first-class examination in May, as usual.

The Secretary reported that Mr. E. Drory, of 19, Kitschiner Strasse, Berlin, had kindly contributed, through Colonel Walker, to the Association's library the French work on bees by Della Rocca, "Traité Complet sur les Abeilles" (3 vols.), and a vote of thanks was accorded to the donor for his gift.

After dealing with other correspondence requiring attention, the meeting terminated.

The next meeting of the Council is fixed for Thursday, February 19.

### FOUL BROOD OF BEES.

A valuable contribution to the permanent and authoritative literature dealing with the question of foul brood among bees was recently published in a Belgian paper, and is now being translated by our Senior Editor for publication in the BRITISH BEE JOURNAL. In view, however, of the importance of the subject, and the advisability of dealing with it in the most thorough manner, we intend to preface the translation mentioned above by reprinting the paper on "Foul Brood of Bees," by F. C. Harrison, B.S.A., Professor of Bacteriology to the Ontario Department of Agriculture, Canada. This course will not only be advantageous as a whole, but as frequent references to Professor Harrison's paper are made by the Belgian scientist in the article we are translating, it becomes necessary to adopt the order of publication proposed.

The completion of the whole subject will

occupy several issues of the B.B.J., and we trust bee-keepers will realise the need for preserving so valuable a contribution to the foul-brood question by preserving the papers for future reference.

#### Bulletin 112.

*Agricultural College and Experimental Farm, Toronto.*

#### FOUL BROOD OF BEES.

*By F. C. Harrison, Professor of Bacteriology.*

In all probability the first definite reference to foul brood is by Aristotle (1), who mentions an inertness which seizes the bees, and causes a bad smell in the hive. He also suggests that bees are liable to become diseased when the flowers on which they work are attacked by blight. Bee dysentery causes a bad odour as well as foul brood; but in the former disease the spotting and consequent smell are usually outside the hive.

Columella (2) mentions a bee pestilence and an annual distemper which seizes the bees in spring. Pliny (3) writes of a disease of bees, but as he uses the same term as Aristotle, he has probably copied it from the latter author.

Schirach (4) in 1769 was the first writer to name the disease "Foul Brood." He says that "it is dangerous and a most destructive disorder to the bees, a genuine plague when the complaint has reached a certain stage. The cause can be attributed to two sources—1. The putrid (or tainted) food with which the bees feed the larvæ for lack of having better. 2. By the mistake of the queen bee in misplacing the larvæ in their cells head upside down. In this position the young bee, unable to get out of its prison, dies and rots away." Further, Schirach clearly distinguishes between foul brood and chilled brood, and mentions the fact that 'putrefaction follows the death of the brood from frost, but in this case "it is only an accident and not a disease."

The remedy Schirach recommended was to remove all diseased combs from the infected hives and to keep the bees fasting for two days, after which they are furnished with other cakes of wax, and a suitable remedy given, "as a little hot water mixed with honey, nutmeg, and saffron, or a syrup composed of equal parts of sugar and wine, seasoned with nutmeg." Thus, as Cowan (5) remarks, "we had given us nearly 130 years ago a method of cure almost identical with what is by some claimed as new to-day."

Tessier (6), about the same time as Schirach, says that when the larvæ die in their cells it causes an infection in the hive which makes the bees sick. It is then necessary to

(1) *Historia Animalium*, Book ix, ch. 27.

(2) *De Re Rustica*, Book ix, ch. 13.

(3) *Natural History*, Book xi, ch. 19, A.D. 79.

(4) *Histoire des Abeilles*, ch. iii., p. 56, La Haye, 1771.

(5) *Journal of the Royal Agricultural Society*, Vol. vi, part iv, 1895.

(6) *L'Encyclopédie Méthodique*, Abeille, p. 32, 1765.

drive away or sometimes move the bees from the hive, and to take care to fumigate the infected hive if it is going to be used again. It is necessary, in order to avoid the same inconvenience, to take out the parts of the comb that may be moulded by reason of the dampness. Duchet (7), who wrote on bees in 1771, does not mention any disease that can be certified as foul brood, but he describes bee dysentery.

Della Rocca (8), Vicaire-Général of Syra, an island in the Levant, relates with much detail the history of an epidemic of foul brood which caused great destruction in the island during the years 1777 to 1780. Della Rocca describes very minutely the symptoms, destruction, and mistakes that were made in attempting to combat the disease. "The disease," he says, "manifests its presence by defects in the combs filled with brood, and which only contain a putrid mass; instead of the bee pupæ there is only rottenness in the cells, which, however, being capped, always preserve a healthy appearance. If these cells are broken open, a blackish liquid flows out, which spreads the infection through the hive. This disease only manifests itself in cells which contain a nearly mature larva or a capped one. The bees themselves remain in good health and work with the same activity, but their numbers decrease daily. This disease, however, is not so general in a hive but that a small portion escaped; some new bees emerged, but in too small numbers to supply the daily losses. Thus a hive attacked by this scourge will perish from scarcity of population. At first it was not noticed that this disease was epidemic, and the hives emptied by death of the bees were filled with fresh swarms, and these contracted the same disease and perished. Yet another mistake was made. The remains of the hives that were lost were taken into the streets of the town to expose them to the sun in order to extract all the wax, and the bees from the neighbourhood sucked up the honey, caught the disease, and communicated it to other hives, and all, without exception, perished in a short time. The epidemic, having reached the island, spread everywhere, and the mortality among the bees was general, either from eating infected honey or from stopping up the infected combs, or from the bees nourishing their brood on infected honey." Della Rocca criticises Schirach's statement regarding the misplacement of the larvæ by the queen as a cause of the disease, because "everybody knows that the queen has nothing else to do but deposit eggs. These are then cared for and nourished by the bees, and when the larva is nearly ready to change into the pupa the bees close the cell, and every position which is given the larva depends on their good pleasure and not on the queen's." Della Rocca himself thinks that "some pestilential

blight had without doubt corrupted the quality of the honey and the dust from the anthers," and recommends "burning everything without pity, as there is no other resource when the disease is well established, as the pest is without doubt the most terrible in the natural history of bees."

Neither Wildman (9), Keys (10), Woolridge, Needham (11), Rhein, Reaumur (12), nor other authors about the same time (latter end of the eighteenth century) mention this disease.

Bevan (13) names the disease "Pestilence," and also quotes Schirach's name "Foul Brood," and says regarding it that the "pestilence has been attributed to the residence of dead larvæ in the cells, from a careless deposition of ova by the queen . . . it has also been attributed to cold and bad nursing—that is, feeding with unwholesome food."

Nothing further of note appears in bee literature till the year 1860, when Dr. Leuckhart (14) writes that he was formerly of the opinion that foul brood was caused by the same fungus (*Panhistophyton ovatum*) which is noticed in a disease of the silkworm, but now, after observation and experiment, is quite certain that the disease is caused by neither vegetable nor animal parasite. He also notes that the term "foul brood" is applied to a number of diseases affecting bees.

Molitor Mühlfeld (15) recognises two forms, one contagious and the other not contagious, and thinks that the only cause of contagious foul brood is a fly (*Ichneumon apium mellificarium*) which lays its eggs on the young larvæ of the bee.

A discovery of note was Preuss's (16) in 1868. He contradicts Mühlfeld's statement about the fly, and states that foul brood cells can be detected by the sunken cap. With a microscope magnifying 600 diameters he found small dustlike bodies with a diameter of  $\frac{1}{100}$  mm. belonging to the genus *Cryptococcus* (Kützigg), and called the specific form *alvearis*, likened it to the fermentation fungus (*Cryptococcus fermentum*), and thought that the last germ gained access to the young bee and changed to *Cryptococcus alvearis*. He notices that many experts lay the cause of the disease to fermenting food, but the larvæ are easily contaminated by the fermentation fungus which is always present in the air. He also mentions the enormous rapidity with which the fungus multiplies, and gives an elaborate calculation of the number that might be found in a cell containing a diseased larva.

As might have been expected, Preuss's

(9) Treatise on the Management of Bees, London, 1796.

(10) Ancient Bee-Masters Farewell, London, 1796.

(11) Brussels Memoirs, Vol. ii, 1780.

(12) Mémoires pour Servir à l'Histoire Naturelle des Insectes, T. V., p. 1734.

(13) The Honey Bee, London, 1827.

(14) Bienen Zeitung, Eichstädt, 1860, p. 232.

(15) Bienen Zeitung, Eichstädt, 1863, p. 95.

(16) Bienen Zeitung, 1863, p. 225.

(7) Culture des Abeilles, p. 315, Vevey, 1771.

(8) Traité Complet sur les Abeilles, Vol. iii, page 261, Paris, 1790.

statement aroused considerable discussion at the meeting of German bee-keepers a short while after the publication of his paper.

Vogel (17) expressed doubt as to whether *C. alvaris* was the real cause of foul brood, or only a consequence of the disease, but, on the whole, agreed with Preuss.

Wiegand (17) agreed with Preuss's theory, and in giving his experience said that the disease was introduced into his apiary through honey brought from a distance.

Pollman (17) believed that the disease was introduced by feeding honey from Havanna, where, when extracting the honey, both brood and honey comb were mashed up and the honey pressed out.

Dr. Leuckhart (17) agreed with those who thought the disease due to a fungus, but discredited the supposition that it was the same as the fermentation fungus mentioned by Preuss, and rather thought it was related to the silkworm fungus, and that most of the brood diseases ending in death were called "foul brood" while they were really something else. He believed that the fungus was present in the eggs of the queen when laid.

Geilen (17) believed that the disease came from the putrefying remains of animal bodies upon which the bees alighted.

Mühlfeld (18) again in 1869, presented his former views, and also those of Preuss's, and gave directions for maintaining the health of bees. He recommended the boiling of the honey, and a use of carbolic acid in the strength of 1:100 or permanganate of potash 1:300 as disinfectants.

Lambrecht (19) thought that foul brood was caused by the fermentation of the bee bread.

Hallier (19) considered it no specific disease, but thought it was probably produced by different fungi.

Cornallia (20) proved contrary to the above, and found a fungus, which he thought developed foul brood. He called it *Cryptococcus alvearis*, and used carbolic acid, potassium permang., and lime water as disinfectants.

Fisher (21) advanced a new foul brood theory in 1871, which somewhat follows the view of Liebeg regarding the silkworm disease and plant diseases. According to this theory, the predisposing cause was insufficient nourishment, especially short stores for winter and spring. Shortage of pollen supply was the next cause. Fisher tried to prove his views by the practical experience of bee-keepers, and explained that the first result of repeated and continued feeding was an increase in the production of bees; and a consequent disproportion between brood and brood feeders arose, which should be looked upon as another cause of foul brood. The disease, he said, might be lessened or exterminated by applying

means to reduce the production of brood, as the removing of the queen and the area which the brood occupied. Foul brood is probably the cause of a quantitative dearth of nourishment and a consequent degeneration of the bees. The appearance of fungous growths was only a secondary matter.

Schonfeld (22) infected several hives with foul brood, and when it had fully developed he took a comb of the rotten brood to the Physiological Institute at Breslau, and had it submitted to a microscopical examination by Drs. Cohn and Eidam (23). This examination showed that in every dead larva, and in each foul broody cell, whether the contents were yet white and fluid or brown, tenacious, andropy, there were to be found long oval bodies, which Preuss called "micro-cocci." "Close to and among them, Cohn was the first to find, with the most powerful of the five microscopes that were used, a countless number of slender pale rods, joined together, and which he at once identified as bacteria of the genus *Bacillus*. The length of a single rod was about 6 micromillimetres, but many of them were two and three jointed, so that these foul brood bacteria microscopically resembled the anthrax bacteria, though, of course, they were different physiologically and in the manner in which they acted as ferments."

It is not surprising, when we remember the state of bacteriological knowledge in 1870, that Preuss should have mistaken micro-cocci for the spores of a bacillus. In 1885, Cheshire and W. Cheyne (23) confirmed Cohn's conclusions, and demonstrated that the disease, foul brood, was caused by a bacillus to which they gave the name of *Bacillus alvei*; and they worked out the following requirements of the causal relation of this bacillus to the disease, usually spoken of as Koch's rules:—

1. Constant association of this germ (*B. alvei*) with the disease in the larvæ of bees.
2. Isolation of the germ from the diseased larvæ, and study of the same in pure cultures on various media.
3. Production of the characteristic symptoms of the disease by inoculation of pure cultures.
4. Discovery of the same germ in the re-infected larvæ. Re-isolation and growth on various media, comparable to that previously isolated.

The infection brought about by Cheshire was accomplished by spraying a particular part of the comb with a culture of *B. alvei* in milk. This part, and no other, became affected with foul brood. Adult bees were also infected by feeding them with these cultivated bacilli. The experiments of Cheshire and Cheyne convinced every one, and since that date *B. alvei* has been generally regarded as the causal agent in the production of this disease.

Dickel (24) wrote in 1888 that several

(17) Bienen Zeitung, Nos. 21 and 23.

(18) Bienen Zeitung, 1869, No. 3.

(19) Bienen Zeitung, 1870, No. 2.

(20) Bienen Zeitung, 1870, No. 5.

(21) Bienen Zeitung, 1871, pp. 105-125.

(22) Bienen Zeitung, 1874, pp. 201 and 261.

(23) Journal of the Royal Microscopical Society, 1885, p. 381.

(24) Bienen Zeitung, 1888, p. 24.

species of bacilli were able to produce foul brood. There was one form of the disease which affected the unsealed brood, and another which affected the sealed brood; and even a third, a mixed form, which seemed to be most malignant.

Klamann (25) supported Dickel's researches, but stated that it was not necessary to count more than two kinds of the disease, as there were certainly several other microbes which contributed to the ruin of the hive. Klamann stated that he found seven, and was persuaded that he would be able to isolate an even greater number of bacteria from the diseased larvae. It seemed to him certain that *B. alvei* was the most virulent, and that this germ alone was to be considered the cause of foul brood.

(To be continued.)

## Correspondence.

### AMONG THE BEES.

[5015] *The Mother Bee*.—Almost the whole success, and, indeed, existence of bees may be said to centre in the queen—or mother bee—heading the stock; as it is entirely on her egg-laying powers that they have to depend for increase; and, therefore, according to the measure of her prolificness the colony will prosper. Her powers as an egg-layer are often truly marvellous, for a first class queen, heading a strong colony, can lay about 2,000 or 3,000 eggs a day in the height of the season, and keep this up for several of the summer months at the rate of 60,000 a month. A good queen may lay 1,000,000 eggs during her life. But far too many fail to approach even half of these numbers, and this simple fact should give force and point to the contention so often reiterated in our pages that so much of the success and prosperity of a colony depends on the queen heading them.

Seeing, then, how much of ultimate success or failure centres on the queen-bee, it becomes every one who wishes to be an up-to-date bee-keeper to see that this all-important member of every colony is of the best. Any accident happening to the queen, and in a few months the stock dies out. If she is suffering from any physical defect or deformity, the same goal is reached, though the process may be lengthened. If she is of an inferior type, her fecundity does not keep pace with the exhausting "tear and wear," especially during the busy season of the year, when every month or so sees a complete renewal of bee-life—though in the season of repose this may extend over six or eight months. Queens, too, wear out with hard work, and are at their best during their first two seasons, after which they begin to fail, particularly where any

stimulative feeding has helped to exhaust their laying powers prematurely. It has, therefore, become recognised as one of the most important rules in modern bee-keeping that only young queens should be kept, and many advanced bee-men make it a point to renew them after their second season. Any one who has had experience of the admirable work performed by a really good first-class queen, and has seen the excellent results her progeny has secured at the end of the honey season, will never again content himself with inferior queens. Frequently it pays well in the north to secure one or more southern queens during a season, the infusion of new blood adding fresh energy and vitality to the home strain. But under modern management the veriest tyro can raise as many queens as he may require with little trouble, and at no expense, from eggs laid by the best and most prolific mother-bees of his own stocks.

*Heather Hovies*.—*Erica cinerea* and *Calluna vulgaris*.—In regard to the letter of "J. L." in B.J. of December 11 (4975, page 499), I think it is universally recognised that in such locations as "Chat Moss" any heath, of whatever variety, is as a rule quite guiltless of secreting nectar; and I would be prepared to affirm that every bell or floret, if examined and tested, would be "as dry as a whistle." *Calluna vulgaris* does at times, in very favourable years, yield a small percentage of weak, watery nectar, bearing little resemblance to true heather honey, on low situations. But bees very rarely indeed waste their energies in hunting after dribblets of such poor stuff, when they know they can load up quickly amid the rich and abundant purple bloom, which their powerful compound eyes show them lies spread before their keen vision on the higher hills. There are the true foraging haunts of the bees to be found, and it is only when they attain an altitude of something like 1,000 ft. above sea level that they secure the genuine nectar which ultimately becomes really good heather honey. Curiously, Mr. Lancelot Quayle supplies confirmatory evidence of this in his interesting contribution on page 498 of same issue, where he states that *Calluna vulgaris* does not yield much honey on the (comparatively) low grounds near his home. I have to thank Mr. Quayle for so kindly responding to my appeal in regard to his *Erica* honey. His contribution is a valuable one, and supplies just the information I desired. He is right in saying that environment (embracing attitude, soil, climate, exposure, shelter, &c.) tells largely on the full development of plant or animal. It tells too, in an important way, not only on the amount of honey a plant may yield, but also the quality of the finished product. Another feature which affects the character of honey is its *purity*. That may be a new point, but it deserves special notice. I have been astonished

(Continued on opposite page.)

## HOMES OF THE HONEY BEE.

THE APIARIES OF OUR READERS.

Mr. Thorburn, whose small apiary is shown below, sent the photo mainly to show the comb-building by a swarm in the open high up in the picture. As he encloses a few interesting notes regarding his bee-keeping we add them as under:—

“The object of interest in the photograph herewith is the four combs, distinct pieces, two of them 10 in. in length, built high up in an apple tree. A small swarm came out of

one of my hives and settled in this apple tree. It was shaken into a skep within twenty minutes of its settling, and was put in a hive the same evening, but proved to be without a queen. The comb was not noticed for ten days after the swarm was taken, and all the bees had then left it. My theory is that the queen was left behind on the branch, and that the few bees remaining with her built the comb, probably the same day, or the day after the swarming. Anyhow, it seemed to me somewhat out of the common, and consequently I asked my friend Mr. John Isaacson to photograph it, which he did.

“As to my small apiary, shown in the picture, there is nothing special to tell about it. Without being by any means an expert, and having occasionally to get the help of a neighbour with younger eyes to find the queen in a hive for me, I have kept bees with fair success for a good many years. Three hives are as many as I care to look after, but in trying always to have at least two in strong condition I cannot avoid at times having four on their stands. For instance, in

June last year I had three hives all promising well, but about the beginning of July I found one of them had lost its queen. There being newly-laid eggs in the cells, however, it was evident the bees had raised a new queen. This hive will be strong before going into winter retirement, but will give no super honey this season. I had to put the small swarm above referred to in a fresh hive, as I could not tell which hive it had issued from; but it was useless to leave it there permanently—especially without a queen—so I shook the bees into the hive containing the newly-

raised queen, thus reducing my hives speedily to the normal number of three again.

“The other two hives have given me about 80 lb.—my average in previous years being only 70 lb. to 80 lb.—partly in sections and partly in shallow frames; but, curiously enough, while one has sealed over both the sections and shallow-frames, the other—although filling them quite as early—has scarcely completed the sealing of any of its sections or frames.

“We have all the usual bee-flowers in our garden—which I need not recapitulate, as they have been mentioned more than once in

your paper during the past year—but it seems to be the opinion of many bee-experts that garden flowers make but a small proportion of the weight of honey stored, which they estimate to be gathered mainly from fruit blossom, sycamore, clover, and the lime.”

(Continued from opposite page.)

at the quality and flavour of honey produced in certain, to all appearance, excellent heather districts. It was far too dark, and the taste so harsh and unpalatable that it did away



MR. J. D. THORBURN'S APIARY, HOOTON, CHESHIRE.

with all desire for a further acquaintance with its merits—or rather demerits. Perhaps it may be such poor stuff as I have in my recollection which made Mr. Raitt, of Blairgowrie, write on page 509, to say he was glad to see the end of it. As, in my experience, it was only found where pines were abundant, I am led to ask, can it be that the pure honey had been blended—by the bees of course—with any exudation from these fir trees? The subject is worthy of investigation, and perhaps some one near heather and a pine forest can supply reliable information. Another point deserving elucidation is: Does tall, strong, rank heather, especially when it grows in the shade of trees, supply a poor, thin, pale, watery, inconsistent class of honey? I vote with the ayes.—D. M. M., *Banff*.

#### NOTES FROM SOUTH SHROPSHIRE.

[5016.] I am sending a few bee notes from this district on past season. The bees came through winter of 1901-2 with a fair supply of stores up to May 1; after that date they required continual attention until the third week in June. I practised my usual method of outside feeding, giving the bees over forty gallons of thin medicated syrup, made chiefly from honeydew collected two years ago. The main honey-flow of 1902 lasted about a fortnight, and some of my best stocks filled three racks of sections, while others did nothing. Indeed, they seemed to get weaker for a time owing to scarcity of brood at commencement of honey-flow. Strange to say, my standard frame hives were almost a complete failure. I do not think I had 20 lb. of run honey from the best of them, though all hives had same treatment—being fed from the outside. I had a fair amount for the season from the bulk of my large frame hives; the three best stocks filled three racks each of completed sections. Heather honey was a poor lot, I did not get one completed section. I only had one swarm from over fifty hives, and that was from the only skep I have. Skeps in this district were very poor. I “took up” five skeps for my nearest bee-keeping neighbour, and 10 lb. to 12 lb. would be the total weight of honey he would have from them. Of course, they were the lightest. I believe our rainfall was much above the average here.

I have read the discussion on frames with much interest. I myself prefer the thicker top-bar, which, of course, lessens comb-space in a small frame; but I think a sagging top-bar would also do the same, to say nothing of other inconveniences. I have never yet seen a hive with all top-bars straight when they have been  $\frac{3}{8}$  in. thick and saw-cut through for fixing foundation, which is, to my mind, the worst method that was ever brought out for the purpose. I have tried most plans of “fixing,” including wiring on different methods. I now fix all my foundation, both in brood and shallow frames, with wax only—

no cuts or grooves. I may also say I have never had a slip or breakdown since the “weed” foundation was brought out. Some may object on account of the extra time it takes, but that is a mistake. It can be managed just as quick, if not quicker, than any other method I know of. Besides, just see the difference when cutting out old combs? No wire hooks to cut against, or grooves to clean out. The wax for fixing you have again. I may mention my top-bars are the Simmins pattern,  $\frac{7}{8}$  in. square, a 16 in. by 10 in. frame making foundation more liable to slip if extra weight and size would do it. I use no “metal ends” or any distance keepers whatever, and when hiving swarms on full sheets I close the frames up pretty close together for the first twenty-four hours after hiving. If I have supers to put on swarm, I hive on “guide strips” only.

A wax-smelter can be made with two small self-opening tins that will just fit one inside each other, for water and wax, and a small, flat, metal-bound brush and a lamp stove, and there is your rig-out at a small cost, using wiring board for guide.

I intend to try the wider top-bar, as I think that would be a step in the right direction. I should like also to say I find the  $\frac{1}{2}$ -in. top-bar “standard” size (uncut) to keep perfectly straight and a wider frame of same thickness would be sure to keep straight.—PHIL JONES, *Church Stretton, January 19.*

#### THE “FRAME” QUESTION.

[5017.] In the second part of his article (4999, page 4) your correspondent, Mr. Sladen, describes a frame having no “lugs,” but supported by two wire nails driven into the corners of the frame. I can say I have used a frame on this principle for many years, and still continue to use it. It was invented by a clerical friend of my own, who was secretary of the Association of Bee-keepers of Bourgogne (Burgundy), and the inventor of a hive which is much used and esteemed in France. This frame, so highly praised by Mr. Sladen, has certainly many advantages; but it also has its inconveniences, especially for transferring hives from one place to another, seeing that the frame is supported in the hive by two nails only, and on the least movement the frame is always swinging, which exposes the bees and queen to the risk of being crushed. I have determined to adopt the “Standard” frame only in my apiary, as I consider this frame is the right one for all purposes, provided the saw-cut is omitted.—B. COLOMBAN, O.S.B., *Buckfastleigh, Devon.*

#### WANTED, A FRAME.

[5018.] A standard frame, with  $\frac{1}{4}$ -in. bottom-bars, saw-cut in top-bars, and wired as enclosed sketch, sags next to nothing during a reasonable time (three or four years); when renewal or rewiring may be necessary,



with the saw-cuts puttied, wax-moth has no foothold there. Ventilating hives, by raising them off the floorboards, and leaving them raised at night, is probably the cause of much wax-moth trouble. The wire, as shown in sketch, runs through small bradawl holes, numbered 1 to 12, as shown, the ends being turned into similar holes, and plugged with wood. At 1 and 7 the wire runs through the saw-cut. No bent nails or staples are required.—F. C., *Hants.*

[We do not doubt that a frame "wired" and dealt with as described above will do all that is claimed for it; but it is open to question whether bee-keepers, as a rule, will go to the trouble of boring so many as ten or more holes in a frame and wire so thoroughly as our correspondent shows in sketch sent. We have received several sketches kindly sent by readers, illustrating various methods of wiring, and different shapes of top-bar; but, while fairly good in their way, there is hardly sufficient originality in methods of wiring or appreciable improvement on frames already in use to warrant the expense of having blocks engraved from sketches. It simply shows that a good bee-keeper who troubles to exercise his intelligence can overcome by methods, either devised by himself or adapted from others, any real defect in bee-management he wishes to remedy, and in this way we may, without offence, agree to differ on the question of whose plan is best.—EDS.]

#### DEALING WITH FOUL BROOD.

[5019.] While I have much pleasure in reading from week to week letters of experience and queries sent you by brother bee-keepers, I am often astonished at their seeming disregard to the need of first taking a glance through the "Bee-keepers' Guide Book," as I am sure they often would find replies to their queries therein. No doubt I should myself have worried you in the same way unless I had this capital text-book on hand. But there is one correspondent, viz., Mr. E. W., Bridgnorth, Salop (5006, page 17) from whom I entirely differ when he declares that "there is no reliable cure for foul brood." I am sure that there is if the instructions in the "Guide Book" are faithfully carried out by experienced bee-keepers possessing intelligence; and, if not too far gone, it can be got rid of. I know it entails arduous labour to overcome it, besides the medical treatment, in thoroughly disinfecting hives inside and out—in fact, what one does should be done well, and thoroughly well in every item, otherwise it may be only labour lost.

There is one very important thing which is recommended in the "Guide Book," but often overlooked, and that is in giving each hive a young, healthy queen. This not only helps in curing foul brood, but, I think, it ensures an absolutely certain cure.

Looking, then, at the whole question in the light of my own experience, I am as sure as it is possible to be, that a man, if he has not the "Guide Book," is a pigmy in bee-keeping, for, with its contents at hand, a boy becomes a giant by comparison, so far as bees are concerned.

Another thing I would like to draw attention to, viz., how careful one should be in buying driven bees for building up or strengthening stocks. Foul brood is found to be more prolific in skeps than in frame-hives, but not so easily noticed.—I enclose name, &c., when signing myself "STINGLESS," *Luton, Beds, January 13.*

#### EXPERTS AND FOUL BROOD.

##### USE OF "CRUDE" CARBOLIC ACID.

[5020.] Referring to my letter (5011, page 24), the words, "so, after burning quilts of brood-nest," should read, "so, after burning brood-nest, quilts, &c." Also, "and is thus more destructful of brood," should read, "and is this more destructful of brood."

I have used the word "crude," as it was used in letters to which mine were replies, and is intended to mean "full strength" carbolitic acid, which is a more correct description. Calvert's No. 5 can hardly be called crude, and his No. 4 is still more refined. I buy it in the crystal form, adding 10 of water to 90 of carbolitic, which is, I think, the strongest solution, and in the most refined form, that can be made, it can also be used in stronger solutions than the less refined for washing the hands, owing to the absence of oily impurities which aggravate the burning, so that the quality used is worth nothing, in treating cells, as it may make a difference in time to disappear.—G. M. SAUNDERS, *Hon. Sec., Cumberland B.K.A., Keswick.*

#### PRICE OF HEATHER SECTIONS.

##### PHOTOGRAPHING INSECT LIFE.

[5021.] It may interest B.B.J. readers to know that 1-lb. sections of heather honey have fetched as much as 2s. and 2s. 3d. each in Princes-street, Edinburgh, this season. I also send a cutting from the *Daily Telegraph*, which may be interesting as an incentive for amateur photographers who are also bee-keepers. It reads as follows:—

"One of the most charming happenings ever photographed by natural history camerists is the birth of a butterfly. Mr. Fred Enock was the photographer, and his pictures appear in the first number of *Animal Life*. He depicts the whole event from the stage when the larva has slung itself by a silken girdle to a twig until the butterfly, fully developed, is poised on a leaf about to make the first trial of its wings. Mr. Enock notes that in seven minutes from the time that the chrysalis first split the butterfly was fully developed, and

from the moment that the skin opened until the new-born beauty was poised on the empty shell it emerged so quickly that exposures of a hundredth of a second only were given. The photographs are excellent, considering the difficulty of the subject."

—W. Y., *Moffat, N.B., January 13.*

#### A B.K.A. FOR CAITHNESS, N.B.

[5022.] Away in the far north here there has been formed a Bee-keepers' Association for the county of Caithness.

I shall esteem it a great favour if some of my brother bee-keepers further south would be kindly pleased to forward me a copy of constitution and rules of their own bee associations for our guidance.

Begging the insertion of the above in the B.B.J., and trusting to the goodness and *esprit de corps* of our southern friends for help in the direction named.—PETER SUTHERLAND, Hon. Sec., *West Watten School House, Caithness, N.B., January 17.*

#### BEE-KEEPING NEAR NEWCASTLE.

WANTED, A LOCATION.

[5023.] I should be much obliged if any of your readers living in the neighbourhood of Newcastle-on-Tyne would afford information in your columns with regard to the best locality near that town for bees. Having been compelled by business needs to give up bee-keeping for a time, as I could never stay long in one place, I am a stranger to this neighbourhood. Being now, however, more permanently settled, I am anxious to get a few hives together again, and should therefore be glad to learn of a really good place for the bees, if possible, within about twelve miles of this town, and accessible to heather, that is to say, within easy driving distance for the heather season. Any information on this subject would be welcome.—INQUIRER, *Newcastle-on-Tyne, January 18.*

#### "SHOOK" OR "BRUSHED" SWARMS.

Our footnote on page 27 has led to a further inquiry on the subject, and we, in consequence, insert the following article from "Gleanings," written by an American bee-keeper of repute, according to which it will be seen how much, or how little, difference there is between the new idea (?) and the ordinary method of making artificial swarms so long in use in this country, and we may leave our readers to choose between the old and the "new" plan. The writer referred to says:—

"I have for a number of years practised shaking bees off their combs at the approach of the honey-flow (white clover with me), and I must say the plan is all right. It practically cures the swarming fever for that

season; in fact, it is as good a cure as swarming itself. But there are several things to be taken into consideration when practising the plan. First, we ought to wait until queen-cells are under way; for if we do not, such a colony may not swarm nor offer to. We are so much ahead in saving labour, although it can be done if the hive is very populous; but we must observe very carefully the following:—

Second, we must cause the bees to fill themselves with honey. This is important.

This is my method of making these so-called 'shook' swarms. For instance, if a colony is examined, and we find queen-cells started, a hive is prepared with starters. About six frames is the number I use; sometimes five, but never more than seven. Now, find the queen, and set the frame she is on to one side. Before this the colony should be smoked and handled somewhat roughly so the bees will be filled with honey, as Mr. Stachelhausen says. In fact, Gravenhorst, in *Gleanings*, some twelve or fifteen years ago, laid special stress on this point. Now place a queen-excluding honey-board on the new hive, and a super with foundation only. Leave the partly-filled super on the old hive for a day or two. This saves pollen in the sections until the queen commences to lay in the new comb built from the starters in the brood-chamber. Then the unfinished super from each hive can be placed on top of the super on the new hive, so that now your new hive contains the swarm and two supers. But, to go back to the shaking of the bees.

Take a newspaper and spread it down in front of the entrance of the new hive, for you will, in shaking the bees off, shake a lot of their honey on to the mass of bees in front of the hive; and if it is dirty in front of the hive many bees will be so daubed up as to perish, so I use a paper. Shake most of the bees off the frames close to the entrance. Use a little smoke so that they will run in quickly and clean themselves of the honey in the hive. Now take the frame the queen is on, pick her off with the fingers, or take a piece of grass and scrape her off the comb close down to the entrance, and see that she goes into the hive. I do not know why it is, but queens seem to find it harder to get into the hive with these 'shook' swarms than at any other time. If there is a hole or anything else in sight that they can crawl under, besides in at the entrance, they seem to be bound to do it.

The editor speaks about shaking all the bees from the combs. This, for my locality, would be bad advice on account of loss in brood; still, if some of the youngest brood were lost it would not be much of a loss at this time of the year. I now place the old hive and combs on top of the swarm, and in ten days the bees are again shaken down in front of the swarm. They can be shaken clean now, and combs of sealed brood can be given to nuclei, or used elsewhere, as one wishes.

The beauty of the whole thing is, we have the swarming problem under our thumb. Look over the hives once a week. If a colony shows no queen-cells it is safe for another week. If the bees have them under way, shake them, and there you have it.

Speaking about having brood up to the top-bar depends somewhat on the combs. All know, perhaps, that the queen would rather lay in an old black comb than in one that has no cocoons. Now if, during fruit-bloom, we see a colony with an inch or so of honey under the top-bar, that comb is usually lighter-coloured than the lower part, which may be black. The bees and queen get in the habit of having brood in the black portion and honey in the light one. Now, if the honey be all uncapped it won't help matters much; but if, say, one comb in the centre is scratched, the queen is quite likely to fill most of the cells with eggs, when in a few days another comb is treated the same way and put in the centre, when the queen will lay in empty cells. We can thus get the queen to keep gradually on the up grade so far as egg-laying is concerned, and brood right under the top bars, and the bees will rush for the supers when the white flow comes. The very meanest colony to get into the supers is the one with an inch or so of sealed honey under the top bars, and the time to cure that is during fruit-bloom, as above."

## FOUL BROOD.

AN AMERICAN BEE-KEEPER'S VIEWS.

He started out by saying that pickled, chilled, or starved brood, when dried, never sticks to the sides of the cell, but is loose, and is easily carried out by the bees. Foul brood, when dried down to a mere black scale, is always so immovably fastened to the sides of the cell that no known medical treatment can ever get it off. This black scale will hold the disease germ for years. In one instance an apiary was found to have foul brood. No explanation of the cause could be given until it was found that some old combs had been used which had been in a foul-brood apiary eight years before, and which had been stored away in a barn since that time. The cells were examined, and in many of them was found the peculiar black scale of the long dried brood. Honey or pollen stored in cells having this dried diseased brood will contain the foul-brood germ; and when fed to the growing larvæ it spreads the disease. In the case of robber bees, the germs are carried throughout the apiary. Hence foul brood is contagious because of carelessness.

No degree of ropiness of the diseased brood can be given, because it depends entirely upon the season and age of the brood. In cool weather the mass will be cooled and thickened; therefore, the ropiness depends also upon the weather.

In visiting a supposed foul-brood apiary, look first at the weaker colonies, because they will be the ones infected first. There may be no odour about the hive; but by taking out a frame the sunken cappings may be seen, the brown ropy mass of diseased brood, or perhaps only the flattened scale of very dark colour. When the odour is present it resembles that of an old unused gluepot.

To cure, shake the bees into empty bodies; screen the entrances and let them starve for about forty-eight hours so that every particle of diseased honey may be consumed. Next give them full sheets of foundation. When the hives are screened, place them in a cool place and give the bees a little water. Generally it is just as well to narrow down the entrance instead of screening it.

A queen from a foul-brood colony, if sent through the mails, will not infect the colony to which she is introduced if the mailing-case is burned and the accompanying bees killed.

Foul-brood germs do not float in the air, but are carried by robber bees.

Honey from a diseased colony is safe for people to use, though not desirable. If it is thoroughly boiled and boiled long enough, it will be safe to feed back to bees. Just bringing the surface to a boil will not answer. This rule, however, is not safe for the average person to follow. Better err on the safe side and not feed back any such honey.

Foundation made from old diseased comb is perfectly safe for bees.

In most cases the hive-bodies need not be disinfected, because the germ is in the honey and not on the surface of the hive-bodies. Generally frames have so much of the infected honey daubed upon them that it does not pay to save them. It seemed a pity to drop this subject so soon, but the subject of organisation was yet to be considered.—N. E. FRANCE in *Gleanings* (American).

## Queries and Replies.

[3016.] *Overdosing Bee-Candy*.—Will you kindly give me your opinion on the enclosed sample of candy? I made it by the recipe given in "Guide Book," following the instructions as closely as possible, except, thoughtlessly, put the quantity, viz., "one tablespoonful" of naphthol beta solution into 6 lb. of sugar, whereas that is the quantity of solution for 10 lb. of sugar. I therefore ask—1. Will it do the bees any injury? 2. And is it made properly? 3. When would you recommend putting on the candy? The "Guide Book" gives the end of March for liquid food, but nothing is said about candy. Am I right in presuming that candy might be put on earlier? —JOHN GEDGE, *Penryn, January 15*.

REPLY.—1. Candy sent is quite unfit for use as bee-food, owing to overdose of naphthol beta. The recipe in "Guide Book" must

be accurately followed, as regards correct quantities, or, as in most medical formulas or recipes, an intended remedy may become a veritable poison by overdosing. 2. The sample is rather overboiled, and, consequently, too hard for the bees' use. It is also a little coarse in grain, through not being stirred long enough to give it the smooth, buttery grain of good soft candy. 3. Soft candy is essentially a winter bee-food, and may be given at any time between October and March. For the other months of the year syrup food is most suitable.

[3017.] *Utilising "Lifts" for Section-frames.*—1. Can you suggest a plan by which I can use the hanging-frames (belonging to a "W.B.C." box of sections) in my inner 6-in. shallow-frame lifts? I want to utilise the "lifts" for either shallow-frames or the section-frames in "W.B.C." hives. 2. I read in B.B.J. that someone advocates the use of 2 lb. golden-syrup tins for slow feeding. Could you kindly give the plan again in B.B.J., so that it would be in time for early slow feeding? 3. In buying cane sugar from grocers, how shall I know that I get cane sugar?—J. R., *Hull*.

REPLY.—1. The only way of utilising "lifts" as proposed is to insert loose side-pieces of the necessary width to take a shallow-frame. We do not quite see, however, how you can use the hanging-frames—made to take 1-lb. sections—as frames for storing honey in, as they are unsuitable for that purpose. 2. We will send the JOURNAL containing directions asked for in return for 1½d. in stamps. 3. There is no way of ensuring that pure cane sugar is supplied beyond relying on the veracity of your grocer.

### Notices to Correspondents & Inquirers.

*Letters or queries asking for addresses of manufacturers or correspondents, or where appliances can be purchased, or replies giving such information, can only be inserted as advertisements. The space devoted to letters, queries, and replies is meant for the general good of beekeepers, and not for advertisements. We wish our Correspondents to bear in mind that, as it is necessary for us to go to press in advance of the date of issue, queries cannot always be replied to in the issue immediately following the receipt of their communications.*

*All queries forwarded will be attended to, and those only of personal interest will be answered in this column.*

*\*\* Special Notice to Correspondents and Subscribers.*—It will greatly tend to assist us in the new year if correspondents will kindly attend to the instructions printed on inside page of cover with regard to addressing communications properly, *i.e.*, to "Editors" or "Manager" respectively, as the case may be, and write all letters for print on *one side of paper only*. Business letters should also be written on separate sheets from those intended for Editors.

We also ask subscribers to note that, as names and addresses are now printed and the

"coloured wrapper" formerly used for notifying overdue subscriptions is now discarded, a couple of *blue-pencil marks* on the postal cover indicates subscriptions in arrear. These marks will be continued on every issue till the arrearage is cleared off.

By attending to the above much misunderstanding and possible friction will be avoided.

*\*\* Cheap Home-made Hives.*—We have received several requests to address and forward letters to our correspondent who, under the *nom de plume* of "Hollywood, Birmingham," writes on the subject of "Cheap Home-made Hives" (5008, page 18). As "Hollywood" kindly offered to furnish particulars of his method of making the hives described should there be any expressed desire for the same, we have conveyed this wish to the proper quarter, and hope to receive details for publication in an early issue.

B. HOLLICK (Wilts), J. BENTON (Cheshire), A BEGINNER (Chesterfield), and others.—*Cheap Home-made Hives.*—See editorial notice above. In reply to other query of the last named, "A Beginner" will find details for hive making in the "Guide Book" (pages 30 to 42).

W. Y. (Moffat, N.B.).—*Hive Making.*—We have no knowledge of the hive referred to in Press cutting sent.

J. S. (Bristol).—*Improvements in Frames.*—Reference to the meeting of the B.B.K.A. Council meeting on page 31 will explain why your sample frames were not shown to the Council as promised last week.

E. B. (Stockport).—*Work on Bee-farms.*—The best way of offering your services to "beekeepers requiring help in the busy season" is to advertise in our pages. As your main object is to gain experience, and not wages only, it is probable that such help as is offered might be accepted.

J. R. (Middlesex).—*Experts' Certificates.*—Intending candidates must write to the Secretary of the B.B.K.A., Mr. Edwin H. Young, 12, Hanover-square, London, who alone is empowered to deal with these matters.

F. L. (Llangollen).—*Home-made Hives and Wiring Frames.*—See reply to "F. C., Hants" (5018, page 36).

### Honey Sample.

B. FLOWERS (Herts).—The sample received is excellent in all points, flavour, colour, consistency, and condition being very good. If kept in its present bright condition till the early show season, it will stand a good chance of winning on the show-bench in class for liquid extracted honey of 1902.

*\* Some Letters and Queries are unavoidably held over till next week.*

## Editorial, Notices, &c.

### DEVON BEE-KEEPERS' ASSOCIATION.

#### ANNUAL MEETING.

The fifth annual general meeting of the Devon B.K.A. was held at the Guildhall, Exeter, on January 23, the President of the Association, the Right Hon. Sir J. Kennaway, Bart., M.P., in the chair. There was a fair attendance. The Hon. Sec., Mr. E. E. Scholefield, read the Report of the Council. It recorded another year of successful work, the most important being the visiting tour made last spring by six experts, covering about half the county. Towards the expense of this the Devon County Council contributed £80, and had expressed itself as being well pleased with the result. It was intended during the current year to complete the visitation of the county by experts under the renewal grant of the County Council. The bee-tent provided by that Council in 1899 attended the "Bath and West" and various other shows during the summer.

Four out of five candidates successfully passed their examination for third class experts certificates, and two out of three for second class.

The financial statement showed a deficit of only £1 6s. 2d., which, considering the work done, would be considered very satisfactory. During the past year 100 new members had joined the Association, making the present total number 295.

The President, in moving the adoption of the report and accounts, congratulated the Association on the gradually increasing interest shown in its work as evinced by the number of new members as well as by the list of private subscriptions. He dwelt in some detail on the moral advantages that must accrue to those who take up bee-keeping as a pursuit, and observed that all who took an interest in the prosperity of the country must necessarily approve of an industry that tended to arrest the present unfortunate depopulation of rural districts. He himself was disposed to think highly of the methods employed by the D.B.K.A., especially of the expert tours and the dissemination of suitable literature, and he could not for a moment believe that the County Council would hesitate to renew their grant in aid of them.

Colonel Walker, in seconding the motion, remarked that, considering the season, Devonshire had not done badly in the matter of honey, and that there was this advantage in a short crop, that it became easy to dispose of it. There had been as usual during the past year a great deal of foreign honey imported. Great Britain stood alone in allowing such an import to come in free. The United States imposed a duty of 1s. per imperial gallon; Belgium, 3d. per lb. on natural honey, and

2½d. on artificial; Germany, 2d. per lb. on natural and artificial honey alike; and so on through many other countries. It was worth while to pause for a moment over these Continental duties. If the two last named countries were so anxious to protect the home production of their "artificial" honey, what became of the produce? Did they joyfully consume it themselves, or was it just possible that this delightful compound figured in the £27,116 paid last year for honey imported into the United Kingdom, and had taken its place on the breakfast tables of a too confiding British public? He (the speaker) had his own opinion. There was more to be thought of when buying honey than the bottle and a gaudy label, and it would be a good thing for British bee-keepers if the public could be got to realise the suggestion.

Passing to the financial position, he was glad to be able to state that although there had been a difficulty in inducing the County Council to include the cost of issuing the *Bee-keepers' Record* and local monthly leaflet to cottager members in the grant for literature, but it had been for the present year, at all events, overcome. The Council of the D.B.K.A. had not failed to urge that the matter was one of vital interest, as every cottager member was a financial loss to the Association. On the other hand, it was out of the question to think of distributing literature broadcast, and obviously the best course was to assist those who had showed a disposition to help themselves.

The motion was carried unanimously. Sir John Kennaway was re-elected President by acclamation. Messrs. Scholefield and Farrant were re-elected hon. Secretary and hon. Treasurer, and the Council were elected and re-elected.

Mr. Scholefield then moved the two resolutions officially notified on page 10 of B.B.J., January 1, and both were carried unanimously, as were also votes of thanks to the auditor, to the Mayor of Exeter for granting the use of the Guildhall during the past year, and to Sir John Kennaway for presiding.

The meeting then became informal, and various matters of interest and plans for the coming season were discussed by Messrs. Ellis, Catford, Gosse, Parish, Squire, and others present.—E. E. SCHOLEFIELD, Hon. Sec., *Chudleigh, S. Devon.*

### DERBYSHIRE E.K.A.

#### ANNUAL MEETING.

The twenty-second annual general meeting of the Derbyshire B.K.A. was held at the Welcome Dining Rooms, Derby on January 24, J. L. P. Barber, Esq., Chairman; R. Giles, Esq., Vice-Chairman.

There was a large attendance of members, about forty being present. The minutes of the last general meeting were read by the hon. Secretary and confirmed. The hon.

Secretary presented the annual report and balance-sheet, which showed a move in the right direction, a deficit at the commencement being turned into a credit balance at the end of the year. A vote of thanks to the County Council and Agricultural Society for their liberal grants was passed. A motion by Mr. Pearman to exclude members from showing whose bees were outside the county boundary was defeated, it being decided to admit all within a two-mile radius of the county border, as heretofore. The election of officers was proceeded with, most of them being re-elected.

There were three nominations for the post of hon. Secretary—Messrs. F. Walker, H. Hill, and R. H. Coltman—the voting resulting in four votes for Mr. Walker, five for Mr. Hill, and fifteen for Mr. Coltman.

Mr. Coltman was thereupon declared elected.

The hon. Secretary regretted having to report the death of one of their old members, and one who had taken the duties of expert for a number of years, viz., Mr. W. Handby, of Hasland, and he (the hon. Secretary) was requested to write the relatives of the deceased gentleman and offer them the condolences of the meeting in their great trial.

Several items of business were ordered to stand over to the next committee meeting.

The Trophy Challenge Cup (presented by J. L. P. Barber, Esq.) having been won for the third time in succession by Mr. J. Stone, it was decided to allow Mr. Stone to retain the cup on his undertaking to give a similar cup for the same purpose.

Medals won by exhibitors during the last season having been presented, a vote of thanks to the Chairman brought the meeting to a close.—R. H. COLTMAN, Hon. Sec., *Burton-on-Trent*.

## FOUL BROOD OF BEES.

By F. C. Harrison, Professor of Bacteriology.

(Continued from page 34.)

### SYMPTOMS OF THE DISEASE.

The disease principally affects the larvæ. In a healthy comb the young larvæ lie at the bottom of the cells curled up in the shape of the letter C, and in colour are of a pure pearly whiteness, plump in appearance, with full skin. If examined when the disease is just developing, the affected larvæ are usually found to have changed their position. They are no longer curled up, but lie extended in the cell, or move about unnaturally. The bees themselves may at this time or subsequently, show symptoms of the disease by a kind of inertness or inactivity which seizes them. As the disease progresses, the young larvæ lose their plump appearance, become flabby and die. Then a process of decomposition begins, which is shown by their yellowish appearance. This yellow colour turns brown, and if touched

with a pin or needle at this time or later, a portion of the putrid mass may be pulled out in a long, ropy, tenacious string, due "to the chitinous aerating sacs and tracheæ which do not undergo decomposition at all; and these remaining cause the peculiarity referred to" (26). This ropy mass gradually dries down to the bottom of the cell, leaving nothing but a brown scale which adheres to the wax.

As a rule, the bees do not remove larvæ dead from this disease. Instead, they become quite inactive, lose their desire to fly, are often seen fanning at the entrance of the hive, which, in many cases, emits a bad smell. A phase of the disease, which some authors have described as being a different form, is that in which the larvæ die after the cells have been capped over. These cappings become darker in colour than those of the healthy brood; then become indented or sunken, and lastly, become perforated with irregular holes. By putting a needle into any of these cells the same ropy mass, before described, may be drawn out. If an examination is made from the juice of the larvæ at different stages of the disease, the bacillus may be detected; but spores do not form till after death has occurred. The ropy mass contains large numbers of spores, as does also the dry scale.

According to Cheshire (26), the bees themselves become diseased. In a number of cases he obtained the bacillus from the blood of bees from infected hives. Hilbert's examination in 1875 led him to declare that the mature bees in infected hives were liable to be affected. Some writers contradict the statement that the bees themselves are affected by the disease; but they lose sight of the fact that the bees do not die in the hive, but leave it some time before death occurs.

The queen may become infected. Cheshire (26) demonstrated the presence of bacilli in the ovary of a queen; but he did not make cultures therefrom. W. G. Smith (27) reported that a queen sent to Cheshire and examined by him contained *B. alvei* in both of her ovaries. McKenzie (28) examined five queens from infected hives and succeeded in obtaining bacilli from the ovaries of three. He thinks that their presence there is accidental, as in the case of a queen from a badly diseased hive he was unable to find the bacillus, whilst in a six weeks' old queen from a hive in which there were only a few diseased cells, he succeeded in finding it. A queen sent by T. A. Govau (29) to Cowan, the Editor of the BRITISH BEE JOURNAL, was examined, and *B. alvei* was found in the ovaries. F. F. Ward (30) removed a queen from a diseased hive and placed her in a strong, healthy stock,

(26) Bees and Bee-keeping, London, 1885, Vol. ii, p. 546.

(27) British Bee Journal, London, 1886, Vol. xiv, p. 325.

(28) Ontario Agricultural College Report, Toronto, 1893.

(29) British Bee Journal, Vol. xxiii, p. 434.

(30) British Bee Journal, 1887, p. 396.

"which speedily became a mass of corruption." This operation was subsequently repeated with a like result.

I have also myself examined seven queens from diseased hives, and in three cases have had no difficulty in finding the bacillus, and have obtained typical cultures therefrom. The method of examination employed has been the same as that used by McKenzie. The upper surface of the bee is sterilized and cut longitudinally, and all the internal organs, except the ovaries, are removed. The surface of the ovaries is then sterilized and a hot needle plunged into the centre and allowed to stay there until it is cold, when it is withdrawn and used to inoculate agar cultures. According to Cheshire (26) the bacilli are found in the eggs. In one examination he says he counted nine bacilli from a half-developed egg taken from the ovary of a queen. McKenzie (28) thinks that this statement requires confirmation, as he was not able to find any infected eggs.

I have myself examined a very large number of eggs at various times. In these examinations three different methods were employed:—

1. The eggs were taken from the cells in which they were laid with sterilized forceps, and washed in corrosive sublimate, 1:500 crushed and placed on agar plates. In many cases typical growths of *B. alvei* developed from eggs thus treated, but as it might be maintained that the eggs were laid in cells previously infected with *B. alvei*, and that the momentary immersion in corrosive sublimate failed to kill all the spores that were upon the exterior, the next lot of eggs
2. Were crushed between cover glasses, a small portion transferred into agar, and the remainder on the cover glass stained by Gram's method. In several instances the bacillus was found in the crushed egg, and in every case the cultural test confirmed the microscopical examination. Again, as this method also might be criticised for the reasons above stated,
3. Eggs were imbedded in paraffin, and serial sections made and stained by Gram's method. No cultural tests were made, but in a few eggs of several hundreds sectioned a bacillus corresponding in its morphological characteristics to *B. alvei* was found. All the eggs examined were taken from hives more or less affected with the disease.

In view of these facts I am of the opinion that the eggs of bees from diseased hives may in some instances be infected.

#### CHILLED BROOD.

Chilled brood is sometimes mistaken for foul brood, but the appearance of the former is very different from that of the latter. In the case of chilled brood the larvæ turns grey. Afterwards the colour darkens, and in the final stages of decomposition it becomes black. No ropiness develops.

A number of writers in various bee periodicals have mistaken chilled brood for foul

brood, or they have stated that chilled brood turns to foul brood; but Schirach, as long ago as 1769, clearly distinguished between the two, and McKenzie (28) also performed several experiments in refutation of the statement that if chilled brood is allowed to putrefy foul brood may arise *de novo*. He endeavoured to isolate *B. alvei* from chilled brood, but without success. Again, he killed perfectly healthy brood by chilling, and infected some of the cells from a pure culture *B. alvei*. The chilled brood were allowed to putrefy in a moist chamber for several months, and examined with the same results, viz.:— That in the cells in which *B. alvei* was placed it was to be found, but not in any others. I have also performed similar experiments, and they fully confirm McKenzie's contention. So far *B. alvei* has not been isolated from chilled brood in any stage of decomposition. Canestrini (31) described a case which was in all probability chilled brood, and not an infectious malady; but his inoculation experiments failed to establish the pathogenicity of the bacillus, which morphologically resembled *B. megatherium*.

#### GEOGRAPHICAL DISTRIBUTION.

It has been thought that the disease varies in different countries, that foul brood as it occurs in England is different from foul brood in America; but as no bacteriological evidence has been produced in support of the contention, it is not necessary to argue the question. I have examined diseased larvæ from Canada, from Europe (France, Switzerland, Austria, Germany, Italy, and England), Cuba, and thirteen States of the Union, ranging from New York to California, and from Michigan to Florida, and have succeeded in isolating *B. alvei* from all of them. It is true that some of the cultures show certain differences, but they have not been sufficiently pronounced to constitute even a well marked variety of the species. The pathogenicity of the bacillus no doubt varies in different countries; of that we have abundant evidence, and the possible explanation is given by Bertrand, who thinks that where bees have been kept for many years the disease has existed for a long time and remains in an endemic state; but there has been produced in these countries a race of bees which have acquired a relative immunity, which considerably diminishes the effects of the disease, and enables apiculturists to treat it more easily. In new countries into which the disease has been introduced it rages with great virulence, and remedies giving good results in the older countries are worthless in the new. As an example of this statement we have the different methods of treatment used in Canada and in Europe.

Bertrand (32) reports the disease as being

(31) Atti della Società Veneto-Triestina di Scienza Naturali, Padova, 1891.

(32) Bulletin d'Apiculture de la Suisse Romande, 1886, p. 123.

present in every country in Europe. Benton (33) says that he has never met with the disease during the six years he has kept bees in the Orient. Della Rocca (8) describes a terrible epidemic in the Levant in 1780. Bovill (34) says that he has never seen it in Cyprus. In Africa, Feuillebois (35) reports it in Algeria, and Bochaty (81) in Tunis. In Australia it is present in all the colonies, and especially so in New South Wales (36) and South Australia (37). Brickwell (38) reports that New Zealand is full of the disease.

#### THE ORGANISM.

*Bacillus Alvei*, Cheshire and W. Cheyne, 1885, from the larvæ of bees suffering from the disease known as foul-brood, la loque (Fr.) and faul brut (Ger.).

*Morphological Characteristics.*—In form the organism is a slender bacillus, with ends slightly pointed and rounded. "In the larval juices it is about  $\frac{1}{1000}$  of an inch in length and  $\frac{1}{2000}$  in breadth. On agar the bacilli vary considerably in size, averaging  $\frac{1}{2500}$  inch, some as small as  $\frac{1}{10000}$  inch, and others as large as  $\frac{1}{5000}$  inch. When they have attained the latter size, division of the rod seems to begin. They are always somewhat pointed at their ends. Their average breadth is  $\frac{1}{3000}$  inch, ranging from  $\frac{1}{35000}$  to  $\frac{1}{25000}$  inch (23). Klamann (25) states that a clear space often appears in bacilli with pointed ends. From agar cultures twenty-four hours old, at 37 deg. C., the bacilli average 4  $\mu$  in length and 1.0  $\mu$  in breadth. On gelatine cultures, grown at 22 deg. C., they are somewhat shorter. They grow singly, but occasionally form chains of various length.

*Stains.*—With the ordinary aniline stains the bacilli colour rather badly—Eisenberg (39) and Klamann (25). The best stains are mythelene blue and meyth violet. The bacilli accept Gram's stain, but the spores are not coloured by it. I find the most satisfactory stain is methyl violet.

*Capsule.*—No capsule has been demonstrated by Welch's method.

*Flagella.*—The bacilli are actively motile and possess a single flagellum at one pole. The motility of the bacillus is quite pronounced in fresh cultures obtained from bouillon, agar, and gelatine. The flagella stain by Pitfield's, Loeffler's, and Von Ermegen's method.

*Spore Formation.*—Spores are formed by the bacillus, and are large oval bodies averaging in length  $\frac{1}{15000}$  in., and in breadth  $\frac{1}{33000}$  in. On agar the spores are arranged in long rows, side by side, and are greater in diameter than the cells from which they are derived. The

earliest appearance of spore formation takes place in forty-one hours, at 36 deg. C. (Cheyne), but in some cases it is even sooner. The spores are formed in the centre of the rod, and the formation occurs as follows: The rod begins to swell and become spindle-shaped. Occasionally the swelling is more marked at one end than in the centre. The spindle-shape increases in size, and the centre of the swelling gradually ceases to take the stain. The capsule of the spore is apparently formed within the rod, and is not merely the outer part of the rod. In three or four hours the rod is seen to have almost or completely disappeared, although parts of the faint outline of the ordinary bacillus may be noticed.

*Germination of Spores.*—Under favourable conditions the beginning of the germination of the spores takes place in about three hours. The spore loses its oval shape, becomes elongated, and is soon seen to burst through the spore capsule. It then presents the appearance of a short rod, with a pale envelope embracing one end. The rod gradually leaves the spore capsule, and then goes on multiplying as a full-grown bacillus. According to Eisenberg (39), the spores are decolourised by the tubercle bacilli stain, but preparations may be obtained by using the Ziehl-Neilsen stain and alcohol for decolourisation. The spores also stain by the method of Neisser.

*Polymorphism.*—Variations in size and shape may be brought about by growth in acid media, or in media containing different sugars. These variations occur also in the same culture, subjected to exactly similar conditions of growth.

*Involution Forms.*—Abnormal forms are especially abundant when the bacillus is grown on blood serum; peculiar Y-like forms and clubbed shapes are of common occurrence, and relatively few spores are found.

(To be continued.)

## HOMES OF THE HONEY BEE.

THE APIARIES OF OUR READERS.

In Mr. Arthars (whose apiary appears on next page) we have still another tradesman who makes a "paying hobby" of his bees, and when we read of his being able to keep his apiary free from disease, it goes without saying that he is a bee-keeper of the reliable class. No doubt many old readers of the B.B.J. will, along with ourselves, be pleased to see in the illustration the figure of a well-known and respected bee-man of the older school in Mr. Hiam. Of himself Mr. Arthars writes:—

"I began bee-keeping about fourteen years ago by purchasing a frame-hive stocked with bees at a local sale, and still retain the same hive occupied by the descendants of the same bees. I was fortunate in having as friend a good bee-keeper, in the person of Mr. Jas. Hiam, Astwood Bank (seen in the photo standing on my left), who initiated me in the workings of the hive and its tenants. Since

(33) Bulletin d'Apiculture, 1886, No. 4.

(34) Nicosia, Cyprus, personal communication.

(35) Revue Internationale d'Apiculture, Vol. xv, p. 68.

(36) New South Wales Gazette, Sydney, 1894, p. 265.

(37) Journal of Industry and Agriculture of South Australia, Adelaide, 1897, p. 341.

(38) British Bee Journal, 1890, p. 486.

(39) Bakteriologische Diagnostik, Hamburg, 1891, p. 295.



That day my interest in bee-craft has increased in ratio to the better knowledge gained by study and experience of 'the bees' and their wonderful work. I then began to make my own hives, one of which (the legless one standing on a box) is seen in picture. Since then, however, I have altered the construction considerably. My apiary is situated in the corner of an orchard belonging to a farmer friend, and is located about a mile from the village. It originally consisted of three hives (bought from a former tenant on leaving), but, as some of the surplus-honey finds its way on to the farmer's table, he offers no objection to the gradual increase in the number of stocks on his land. I also have another apiary of the same size about half a mile nearer home,

better results than others, notably the one on my extreme left, which was tenanted on June 20 by a large swarm, put on ten standard frames fitted with full sheets of foundation (wired). Eight days afterwards the bees were 'hanging out' for want of room; so I gave a rack of shallow frames, with 'wide ends,' most of which frames were filled in six days; they were well filled, too, some of the combs weighing  $5\frac{1}{4}$  lb. By the end of the season this swarm gave me a total of over 70 lb. surplus-honey, which secured for me the first prize at our Warwick Show for 'Best display of honey taken from one hive.' Although I have, since starting bee-keeping, bought and sold a good many stocks, no case of foul-brood has, so far, appeared in my apiary. It may be



MR. JOHN ARTHARS' APIARY, STUDLEY, WARWICKSHIRE.

and these two apiaries, together with the management of about thirty stocks belonging to less experienced members of our local bee-club, find me plenty of work during the busy season to fill up my spare time. Among these outside jobs falling to the willing bee-man, one often hears (not seldom when at dinner on Sunday) the old cry, 'Come and help us; my bees have swarmed!' But, never being happier than when at work among the little labourers, I am not long in answering to the call.

"With regard to the past season's honey crop, I may say it has, generally speaking, been a failure in this village, but owing to the favourable situation of my apiary I had a fair crop of surplus. Some hives, however, gave far

owing to this frequent change of blood that I have been free from this pest among my bees; at the same time, I am very particular in keeping all hives and appliances as clean as possible. I also leave the bees with a full supply of natural stores at the end of season, and pack them down well for winter; in fact, I make them as comfortable as possible, and I find they well repay all the care bestowed upon them.

"In conclusion, I should like to add a word of praise in favour of the B.B.J., which is to me always full of interest, while I regard it as being as good an instructor as any guide-book I have yet read. Wishing to our editors and all readers the 'Compliments of the season, and a better harvest in 1903.'"

## Correspondence.

The Editors do not hold themselves responsible for the opinions expressed by correspondents. No notice will be taken of anonymous communications, and correspondents are requested to write on one side of the paper only and give their real names and addresses, not necessarily for publication, but as a guarantee of good faith. Illustrations should be drawn on separate pieces of paper. We do not undertake to return rejected communications.

Communications relating to the literary department, reports of Associations, Shows, Meetings, Echoes, Queries, Books for Review, &c., must be addressed only to "The Editors of the British Bee Journal," 17, King William-street, Strand, London, W.C." All business communications relating to advertisements, &c., must be addressed to "THE MANAGER, 'British Bee Journal' Office, 17, King William-street, Strand, London, W.C."

\* \* \* In order to facilitate reference, Correspondents, when speaking of any letter or query previously inserted, will oblige by mentioning the number of the letter as well as the page on which it appears.

### NOTES BY THE WAY.

[5024.] In this part of Wessex our bees are badly in want of a bright warm day to give them the opportunity of a general "turn-out" or cleansing flight. The last time such a chance occurred was on Boxing Day, now over a month ago, and though a few bees have once or twice since ventured forth, I quite expect that unless the much needed opportunity occurs soon our bees will become uneasy from long detention, and where they have been wintered on late gathered food only partially sealed over, we shall see the effects in more or less fouled hives.

*Out-Apiaries.*—These may be established at any time if the new location is one or two miles distant from the home-apiary, but if less than a mile away it is well to do so during the winter months. As only practical men, who have a business view in adding to their output of bee-produce, would think of establishing an out-apiary, I would counsel such as do so to have a thorough look round the new district before finally deciding. One needs to get some reliable forecast of the probable return per hive ere embarking on such an undertaking. Many bee-keepers are of such a speculative nature, so to speak, that they often push forward with a new scheme before counting the cost, and the result is not seldom making a failure of what might with more care and caution have proved a remunerative concern. The first thing to consider is the amount of good bee-forage available from the "honey-flow" point of view. To ascertain this a weekly visit during the months of May, June, and July—aye, and in August—is desirable, or a few colonies, set down on the new location as a trial, would give the novice a better idea of probable results than he would get otherwise if notes are made of his weekly visits to see how surplus is coming in, and the quality of the honey. This would give a good insight into the resources of the districts during the season—in the spring for building up stocks, in the summer for the

main honey-flow, and in early autumn for the supply of winter stores. Some districts are good for bees all through the year, while others have an extra good short-flow and inflow for a few weeks, and very little surplus either before or afterwards. Such locations as these are not worth thinking about. The cost of building up in spring and feeding up for winter takes the gilt off the short-flow, even where it is extra good. Such a location is only useful for "migratory bee-keeping," and this is not often profitable in this country, owing, in a measure, to the difficulty of securing a suitable place on which to place a few hives for a short period. I have given rather a long "note" on this subject by request.

*Shook Swarms.*—Our Editors quoted an article from an American journal last week so that "J. M. E." and others can gain a fair insight into how and why the so-called shook swarms are made. Generally speaking, our principal honey-harvest is of too short duration for the method to come into general use here. After reading a good deal of what has been said on the subject I would, myself, rather allow the few stocks which may swarm (with good management the percentage is not large) and hive the swarm into a makeshift or space hive on "starters" rather than place a sheet of excluder zinc over frames and give them the supers from the hive from which the swarm came, then remove the parent hive a short distance away (or even turn the entrance in an opposite direction only) the swarm will work as only new natural swarms can, and you will get nearly all the flying bees from the old hive to increase the swarm.

*Bee Houses and Store Rooms.*—A remark made by Rev. Mr. Adams (on page 26) brings to my mind an article in the *American Bee Journal* some time in the eighties. The writer wished to impress on his reader's memories, which he certainly did on mine, that when you have planned your bee-house or store, always make a point of building it just as big again as the plan.

4. *Trophy Class at Honey Shows.*—I am surprised that no one among our usual exhibitors in these classes, except Mr. Seymour, has made any observation on these classes. The latter (in his note on page 464 of B.J., of November 20 last) asks that bee-keepers should be advised at an early date if observatory hives would form an integral part of honey trophies in the future? No doubt, from the tenor of his query, Mr. Seymour would like to know in time so that he may be able to make or procure an observatory hive for his trophies next season. If this be so, we have here an up-to-date humane bee-keeper ready to emulate the questionable humanity of those other professed up-to-date bee-keepers (in fact, I ought to say progressives) who last season indulged in this obviously inhuman cruelty to a small

colony of bees. I expect to hear that only so many really dead bees were counted out of the prison-house on their return, as a proof that the imprisonment was not so very destructive to bee life. The craftily-constructed prison allowed these poor worried-to-death bees to drop out of sight, so that visitors should not know of the holocaust, or be disgusted at the last throes of the wearied and dying bees! After these twenty years is the British Bee-keepers' Association—whose headquarters are located in Jermyn-street, that centre of humane kindness to animals—going to allow such things to be done in their name, and under their auspices? Surely they will extend to the industrious little bees the same measure of kindness that the R.S.P.C.A. does to mammalian animals, and never again allow such inhuman treatment to which some poor bees were subjected at the shows at Agricultural Hall in 1902. I beg to thank Dr. Hamlyn-Harris for his hearty support in a recent number of B.J.—W. WOODLEY, *Beeton, Newbury.*

#### BEE-FORAGE IN THE ISLE OF MAN.

[5025.] I was surprised to read the communication of "E. A. H., Chester," in the B.B.J. of January 15 (page 30). Your correspondent expresses the opinion that "much of Mr. Quayle's honey is gathered from the wild mountain sage which grows abundantly about Glenmay." He also states that this wild sage also belongs to the same family as the plant which produces the "beautiful Californian honey."

The Californian plant is a true sage (*Salvia*) the specific name of which I do not know, nor can I find in Root's "A. B. C. of Bee Culture." There are only two species of sage indigenous to the British Isles, viz., *Salvia verbenacea* and *S. pratensis*, neither of which grows in the Isle of Man, so far as I can learn.

The plant he refers to will, I think, be found upon investigation to be the wood sage (*Teucrium scorodonia*); it is true it belongs to the same family as the sage, but it is not a sage.

I am led to make these remarks because of being told two or three years ago by an expert that he had seen quantities of the white mountain sage of California in Cheshire, and that we ought to have it amongst our Cumberland mountains. Being sceptical on the point I asked him if he saw one to point it out to me. He then pointed out the *Teucrium* referred to above, and gravely assured me it was the white mountain sage of California, which it certainly is not, as "E. A. H." will see if he compares a plant with the figure in Root's "A. B. C."

Further, it will not do to assume that because a plant belongs to the same family as another which is a good honey flower that it is also a good one. *Azalea pontica*, *Kalmia latifolia*, and *Rhododendron ponticum* all

produce poisonous honey, yet they belong to the same family as *Calluna vulgaris*, which produces our celebrated heather honey.—JOHN VICARS, *Cumberland, January 26.*

#### SELECTING THE BEST BEES.

[5026.] It has frequently occurred to me that if the opinions of your readers generally as to the best race of bees to keep were obtained and scheduled, the statement would prove of great value to bee-keepers in general, and especially to beginners, who have the difficult task of deciding whether to keep native bees, Italians, Carniolans, or hybrids.

As Secretary for the Harrow district to the Middlesex Bee-keepers' Association, I come across a good many bee-keepers in the course of the year, and it is interesting to hear the different views held as to the good and bad points of the various races; but I think you will grant that a summary of the opinions of your readers in general would prove both interesting and instructive.

If you approve of my suggestion—namely, that your readers be invited to reply to the undermentioned questions—I will gladly schedule the answers and forward the result to you for publication. Replies can be sent to me on postcards, and the number should be given with each answer.

Which have you found to be—

1. The best bees for gathering?
2. The quietest bees?
3. The most vicious bees?
4. The best bees for sealing sections?
5. The most prolific bees?
6. The best "all-round" bees?

—J. B. LAMB, *Rathgowry, Harrow View, Harrow, January 24.*

#### CHEAP HOME-MADE HIVES.

[5027.] Concluding that the information your correspondents seek is regarding the timber used in constructing the four hives mentioned, I send you the following details:—1. Three bacon boxes which held long, "singid sides" of bacon—the boards being over 40 in. long—cut two lengths each. Cost of each, 10d. 2. Three full-sized Ceylon tea-chests, used for roofs and internal fittings. Cost of each, 6d. 3. Four Swiss milk cases; these made the plinths, &c. Cost of each, 3d.

The boxes were all carefully taken to pieces, nails straightened and used again, the cost being thus 1s. 3s. per hive; paint and putty, 1s. 4d.—Total, 2s. 7d.

I may have that part of my apiary photographed later on, and if you care to give it a place in your B.B.J. picture gallery, will send one.—HOLLYWOOD, *Birmingham, January 24.*

[We shall be specially pleased to have photo as showing the "cheap home-made hives" referred to.—Eds.]

## HEATHERS IN THE ISLE OF MAN.

[5028.] I am afraid that your correspondent, "D. M. M., Banff," in writing of "Heather Honies" on page 34, misinterprets a former letter of mine (*vide* B.B.J. of December 11, page 498).

He quotes me as having said that the *Calluna vulgaris* (or common ling) does not yield much honey on the "low grounds" near my home, and goes on apparently to infer that the reason for this is that my locality is comparable with such places as "Chat Moss," near Manchester, in being low-lying and swampy ground. As a matter of fact, the locality I referred to in my letter where *Erica cinerea* and *Calluna vulgaris* grow together in great profusion extends from 700 ft. to 1,200 ft. above sea-level, and is not by any means swampy land. The peculiarity which I wished to point out was, that whilst *Erica cinerea* yielded excellent honey in great quantity, yet my bees did not gather any appreciable quantity of honey from the *Calluna vulgaris* growing in the very same locality, although I pointed out that it was visited by innumerable wild bees, and presumably for honey, and when I did get any honey from the *Calluna vulgaris* it had the common characteristic of being very hard to extract. — LANCELOT QUAYLE, *Glenmay, Isle of Man, January 23.*

## THE FRAME QUESTION.

[5029.] I beg to add a word on the frame referred to on page 15 (5003). I have used a large number of the "83 A frames" every year since they were first brought into use, and in my opinion it is an excellent frame for bee-keepers who have other business to attend to besides bee-keeping, as they save a lot of time in fixing foundations. I may also mention, by way of showing what others think, that I have already fifty stocks of bees sold and booked for next April delivery, and over forty of them are ordered to be on the "83 A frames." This shows that whatever may be the frame of the future, the "83 A frame" is with many bee-keepers the frame for 1903.—W. W. PRYOR, *Breach Wood Green, Herts.*

## BEE-KEEPING NEAR NEWCASTLE.

[5030.] In reply to "Inquirer, Newcastle-on-Tyne," who writes on page 38 of B.J. for January 22, I beg to say that, if he happens to know the road to Sunnyside, near Gateshead, I should be very pleased to give him an afternoon for viewing this district. There is plenty of forage for bees here, within a quarter of a mile from where my own hives stand. Near by are two orchards, and plenty of clover and some heather, which latter is no good. There are not many bees kept about—only three or four hives—so there we have plenty of room for more. Hoping the district will

suit, as it is only four or five miles from Newcastle, I send my address, and beg to sign myself—A BEE ENTHUSIAST.

## HONEY IMPORTS.

[5031.] Referring to the Total Honey Imports for the Year 1902, published in B.J. of January 15 (page 28), I have never seen any mention in your pages of the value of honey exported from the United Kingdom. I would also ask:—Is the £27,116 mentioned the wholesale value (in bulk) or the retail price? 1. If in bulk, what might be the approximate price paid for it by the British public? 2. If retail, what would be an average price? It seems to me it would be anywhere between 2d. and 8d. per lb. I would also like to know how much of the "imported" honey is "exported" as "British"? After twice passing our Custom House would it become British?—QUERIST, *Kent, January 26.*

[We would be very pleased to supply readers with answers to our correspondent's questions, but his queries can hardly be meant seriously, seeing that the information asked for is unobtainable.—EDS.]

## Queries and Replies.

[3018.] *Transferring Bees to Frame Hive.*—Having obtained from a friend in the autumn a stock of bees in a small wooden box containing combs and honey gathered by the bees last summer, I am anxious as to their supply of food for the remainder of winter. So far as I can see, the bees are fairly strong in numbers at present, and I shall be glad to know—1. When you advise transferring to a frame hive? and 2. Shall I give candy now, or as soon as transferred? Thanking you in anticipation of an early reply, I enclose name, &c., for reference, while signing myself ANXIOUS, *Hardwick, January 22.*

REPLY.—1. Pre-supposing that you will follow the plan of allowing the bees to transfer themselves—as is strongly recommended—the best time for operating is early in April, or so soon as the bees begin to need room in spring. 2. If the bees are short of food, soft bee-candy should be given at once. The only way of judging as to stores is to either turn the box bottom up, and, after driving the bees to top of combs by a puff or two of smoke, see if sealed combs are visible, or estimating weight of honey by lifting box, and allowing for bees, box, &c.

[3019.] *Variation in Honey.*—I bought a frame-hive and bees from a neighbour last spring. I have learned a great deal from your valuable journal, as well as from the "Guide Book," but I feel my knowledge of bee

management to be both scant and crude yet. I took only 9 lb. of honey in 1902, but hope to do better this year. I am now asking you to tell me the quality of the honey in each of the accompanying tins. No. 1, in the small round tin, is from my own hive. No. 2, in the larger oval tin (marked Colman's Mustard), is some I bought. I am wondering why such a difference exists between them. Thanking you in anticipation.—D. R., *Stoke-on-Trent, January 23.*

REPLY.—The failure to secure surplus honey last year was not confined to beginners only; many good bee-keepers having fared even worse than yourself. The two samples of honey sent are of only fair quality. No. 1 (from your bees) is clear and bright—"medium" in colour; no pronounced flavour, but very thick, so dense, indeed, that it does not leave the tin when the latter is reversed. It is a very ripe, well-conditioned honey of medium quality. No. 2 (granulated) is coarse in grain, with no particular flavour, and was not so ripe when extracted as your own sample. We class it as about third grade. The most marked difference between the two samples is that No. 1 is liquid, while No. 2 has become solid through granulation.

[3020.] *Hive Making.*—I am going to make a few hives, ready for the coming season, I am rather vague about the difference between the "W.B.C." and the ordinary ten-frame hive, I wish to work for sections, and would, therefore, ask what form of hive you would advise? We have no heater. I notice your correspondents in "Homes of the Honey Bee" do not, as a rule, say what kind of hive is used, though some mention the "W.B.C."—R. B. D., *Great Missenden, Bucks.*

REPLY.—The difference between the hive mentioned and what you term an ordinary frame hive is not very easy to define unless we know what "ordinary frame hive" you have in mind. The best plan, we think, will be for you to compare the "W. B. C." with other hives illustrated in the "Guide Book." Or if you possess the catalogue of any well-known appliance maker you could see and compare the various types of hives shown.

[3021.] *Wax from Old Combs.*—1. If I put in 1 lb. of brood foundation, what weight of that wax should I expect to extract in two, three, or four years, when renewing comb? 2. Has formalin ever been tested to fumigate combs or hives filled with spores of foul brood?—I. R., *Middlesex, January 24.*

REPLY.—1. The weight of wax obtainable from old brood-combs depends so entirely upon the condition of the combs themselves when melted down that it is practically impossible to even give an approximate estimate of the result. We have repeatedly seen old brood-combs that would yield so small a weight of wax as to make them worthless for melting down. If the bee-keeper bears in

mind that every year a comb is used by bees for brood-rearing the amount of wax left becomes smaller, it only needs intelligent examination of old combs to decide whether they be melted down for wax or burnt. 2. Formalin has not, to our knowledge, been tested for the purpose mentioned, and we should have no faith whatever in its effects so far as destroying the spores of foul brood.

[3022.] *Transferring Bees.*—An answer to the following questions in the next issue of the *B. B. J.* will oblige:—1. I have a stock of bees in a straw skep which I should like to transfer into a frame-hive, and should like to know which of the two following ways you think would be best: 1. To set the skep on top of frames and put a cloth between with a central hole cut in 3 in. square, through which the bees could work down; or 2. By placing the skep in an inverted position below the frame-hive, allowing a passage through an opening in a temporary floor; 3. How long should the skep remain; and 4. Would the bees be likely to swarm this season?—H. C., *Farnborough, Hants.*

REPLY.—1. We much prefer this method to any other that has, so far, been devised for transferring bees from skeps to frame-hives. The question of using a square of American leather-cloth, with hole in centre, or dispensing with any covering for frame-tops of lower line, depends on the condition of the stock to be transferred and the date of operating. If the weather is warm and the bees are strong in numbers, the cloth may with advantage be dispensed with; otherwise the precaution against lowering the warmth of the upper hive by use of cloth is best. 2. This plan is troublesome and uncertain, so much so that, although advocated some years ago, it has, after trial, fallen into use. 3. Skep may remain till end of season if desired, or it may be removed when free from brood. 4. Transferring as above lessens the chance of swarming somewhat.

[3023.] *Using Old Comb Foundation—Stimulative Feeders.*—Kindly oblige me with replies to the following in next *B. B. J.*:—1. Is it needful to refresh foundation left over last year in hot water before using this season? If so, how hot should the water be? I presume a minute or two is long enough to immerse the wax? 2. Judging from a reply of yours last week to Query 3016 (page 39), I believe you prefer liquid food to candy for spring stimulating, to commence, say, March 1. Is it so? 3. For cleaning frame-hive, will naphthol beta do better than carbolic, as the latter leaves such a smell after it? 4. Please give me the name of a good stimulative feeder.—F. J., *Mountmellick, January 24.*

REPLY.—1. If the foundation has become hard and brittle, it is well to warm it before using; whether by dipping in warm water or warming in front of fire is for the bee-keeper's own choice. The object is simply to soften

the wax and remove the "floury" appearance (similar to the "bloom" on grapes) before giving it to the bees. 2. Liquid food is more suitable than candy in spring when bees are flying daily. 3. Naphthol beta is of no use whatever in cleaning frame-hives. Where do you get this idea from? 4. The "Raynor" is as good a feeder for "stimulating" as any we know of.

### SONG OF THE WORKER BEE.

It is the Morn!

Now launch we forth!

On glittering pinion fare forth to the morning,

Drink the morning air.

Hey! For the sport in the morning clear!

Ho! For the joy of the youngest here!

Hey! Ho! We dance and we sing,  
Youth is our mentor and joyous our fling.

It is the Morn!

\* \* \*

It is the Noon!

Now swiftly wing!

To many a flow'ret rare take we our message,

Then the treasure share.

Hey! For the toil of the worker bee!

Ho! For the duty of toiler free!

Hey! Ho! No need to exhort,  
Work is our pleasure and toil is our sport.

It is the Noon!

\* \* \*

It is the Night!

Now slow return!

Our falt'ring pinions tear-worn by the burden,

Soon they cease to bear.

Hey! For the rest of the worker old!

Ho! For the cluster away from cold!

Heigho! We rest 'an we may,  
Brief is our respite. Soon ended our day.

It is the Night!

L. S. CRAWSHAW.

### "BEE-KEEPERS TO CONSOLIDATE."

AN AMERICAN PROJECT.

The following article from a newspaper published at Los Angeles, California, will be read with interest by British bee-keepers as showing how our brethren in the craft do things in America. It is headed "Bee-keepers to Consolidate," and reads as under:—

"Los Angeles, December 20.—The bee-keepers of California will form a stock company to do business as a corporation under a single head, with capitalisation of 25,000 dols. Twenty of the largest bee-men in the State have pledged themselves to further the project, and to maintain the price set or fixed by the proposed California National Association.

"This association announces that it will fix and maintain a reasonable standard price, and will use a trademark and seal for the prevention of adulteration. Further it will buy and

sell bees, honey, and wax, and will manufacture and sell supplies.

"A Committee of bee-men composed of W. H. Brodbeck, of this city, G. D. Emerson, Santa Ana, and L. E. Mercer, H. Mendelsohn, and J. F. McIntyre, of Ventura, has been in session, perfecting the details of the project and a preliminary organisation has been formed. It is proposed to have a central warehouse in Los Angeles, and to make this city the principal shipping point. The final idea of the new corporation is to affiliate with the National Association, and to perfect a solid, substantial organisation.

"A meeting of the bee-keepers of the State has been called for January 20 at the Los Angeles Chamber of Commerce. At that time the new charter will be in readiness and stock will be issued. The new association proposes to control the entire output of the State, either by membership or purchase."

### Notices to Correspondents & Inquirers.

All queries forwarded will be attended to, and those of personal interest will be answered in this column.

L. B. W. (Kent).—*Books on British Bees.*—

A good and reliable text-book on British bees by W. E. Shuckard is published by Lovell Reeve, & Co., Henrietta-street, Covent Garden, W.C. It is illustrated by nearly one hundred finely-executed steel engravings of British bees coloured by hand. The author entitles it "British Bees: an Introduction to the Study of the Natural History and Economy of the Bees Indigenous to the British Isles," and so far as it goes the work is very complete.

J. WEBB (Somerset).—*Preserving Queens.*—

1. The only way of preserving queens during winter is to let them remain in the weak colonies they are now at the head of, and utilise them for other stocks in spring if worth preserving. 2. When drones are found in hives at Christmas it is a fairly safe sign of queenlessness.

J. COPELAND (Darlington).—*Old Manuscript Bee-book.*—

Much obliged for sending on the interesting MSS.—nearly 100 years old. We will take an early opportunity of perusing it, and write you further on the subject.

### Honey Sample.

"GRIPPAT" (Bucks).—Sample of granulated honey is good in flavour and colour; it is also fairly smooth in grain at present, but some larger granules are found as the honey dissolves in the mouth as if it had been mixed.

\* \* \* ERRATA.—Through a printer's error in letter on "Experts and Foul Brood" last week (page 37), the fourth line from end reads: "The quality used is worth nothing" instead of "is worth noting." This, as will be seen, quite reverses the sense of the line, and we regret the error.

## Editorial Notices, &c.

### WORCESTERSHIRE B.K.A.

#### ANNUAL MEETING.

The annual general meeting of this association was held at the Guildhall, Worcester, on January 31.

There was a fair attendance, including Mr. Geo. Cook, who presided, Sir A. F. Godson, M.B., Rev. E. Davenport, Dr. Walpole Simmons, Miss Digby, Messrs. Hooper, Price, Haywood, W. H. Higley, Moreton, Huband, Richings, Barnard, L. Higley, Matthews, Crook, Hunt, Phillips, and others. Apologies were received from the Rev. J. B. Wilson, Mr. A. Baldwin, M.P., and a few more.

The Secretary read the report of the Committee, which stated that there was a net increase of forty-three in the number of members. Mr. C. H. Haynes had again won the silver medal at the annual show, Mr. E. A. Millward the bronze medal, and Mr. A. R. Moreton the certificate. Third-class experts' certificates had been gained by Messrs. Carnell, Crook, and Price. In the absence of the Treasurer, the Secretary also read the statement of accounts, which showed a balance in hand of nearly £4.

Lord Coventry was re-elected President, and the Vice-Presidents, officers, and Committee were reappointed.

A proposal to make all subscribers eligible to serve on the Committee was ruled to be out of order, as due notice had not been given.

The consideration of the possibility of forming a county scheme of insurance against loss from foul brood was referred to the Committee.

In the evening there was a conversazione at the Guildhall, when Dr. Walpole Simmons took the chair. Mr. H. S. Shorthouse gave a vigorous address on various matters of importance in bee-keeping. His remarks on the rearing, packing, and introduction of queens, and on the cure of foul brood by the bees themselves by means of a natural disinfectant, were especially interesting.—JOHN P. PHILLIPS, Hon. Sec.

### FOUL BROOD OF BEES.

By F. C. Harrison, Professor of Bacteriology.

(Continued from page 44)

#### BIOLOGICAL CHARACTERS.

*Bouillon*.—"In meat infusion at the temperature of the body they grow rapidly, causing muddiness and, after a few days, a slight but not tenacious scum" (23). In bouillon, with a reaction of  $\times \cdot 08$  (57), at 37 deg. C., there is a slight turbidity in fourteen hours, especially noticeable when the tube is shaken. In twenty-four hours the liquid is uniformly turbid, with a very fine

sediment. In forty-eight hours the turbidity increases and a pellicle commences to form. Reaction of the culture at this time,  $+ \cdot 07$ . After ninety-six hours the broth is clear, with a pellicle, white, rather massive, and somewhat tenacious; there is also much sediment. Reaction, after ten days' growth, neutral.

*Glycerine Bouillon*.—Media with original reaction of  $+ \cdot 08$ . At 37 deg. C. the bouillon becomes slightly turbid in twelve hours, and quite turbid in twenty-four, with a fine, whitish pellicle on surface, which does not extend to the sides of the tube. If the culture is shaken, the pellicle deposits in flaky masses. The reaction is  $+ 1 \cdot 2$ . In thirty-six hours the turbidity clears, leaving the media bright, with a smooth, thin, tenacious, and white pellicle on the surface. In many cases the pellicle becomes very wrinkled and greasy-looking. At the end of eight days the reaction is  $+ 2 \cdot 2$ , and the bouillon is several shades darker in colour, but quite clear. The reaction after fourteen days' growth is  $+ 4 \cdot 2$ . At 22 deg. C. the same changes occur, but growth is slower. The bacilli are relatively less numerous than in bouillon, and are slightly shorter and thicker.

*Glucose Bouillon*.—With a reaction of  $+ 2 \cdot 0$ , at 37 deg. C., the broth is more turbid than plain bouillon after fourteen hours' growth; and in twenty-four hours the sediment is heavy, and turbidity very marked, but no pellicle. In forty-eight hours the media is opaque and cloudy, and the pellicle is beginning to form. In ninety-six hours the broth is less cloudy, but the sediment is heavier, and a white, thick pellicle is formed. It is often wrinkled, but not quite so much so as that on the glycerine broth. Reaction of broth after ten days' growth,  $+ 4 \cdot 6$ . The bacilli are occasionally clubbed and Y-like forms may occur. They average  $5\mu$  in length, and may be slightly curved.

*Lactose Bouillon*.—With a reaction of  $+ 1 \cdot 06$ , at 37 deg. C., the growth resembles that of plain bouillon for the first twenty-four hours; but at the end of forty-eight hours it is more turbid. In ninety-six hours a tenacious pellicle forms, less massive than that on glucose broth. Reaction after 10 days' growth,  $+ 2 \cdot 4$ . The bacilli average  $3 \cdot 5\mu$  in length.

*Saccharose Bouillon*.—With a reaction of  $+ 1 \cdot 0$ , at 37 deg. C., the turbidity and sediment are heavier than any of the other bouillons. In forty-eight hours the broth is quite opaque and whitish looking. A heavy sediment is then present, and pellicle formation is just beginning. In ninety-six hours the cloudiness is about the same, but there is an increase of sediment, and the pellicle is thin and membranous. Reaction of media after ten days' growth,  $+ 4 \cdot 04$ . The bacilli average  $5\mu$  in length.

*Gelatine Plates*.—At 22 deg. C. in twenty-four to thirty-six hours the colonies are small, round, oval, or lozenge-shaped, with peculiar projections or shoots from one end of the

colony, giving it a pear-shaped or tadpole-like appearance, according to the amount of development of the projection. In many cases several of these outgrowths occur from different portions of the colony. By placing a cover glass on the surface of the gelatine and using objective 7, the bacilli may be seen moving around and around the colony and to and fro along the projections. At the end of forty-eight hours the colonies are larger. Fine processes or projections are shooting out into the gelatine in all directions, forming peculiar figures in circles or club-line forms. "It is impossible," says Cheyne, "to give a proper idea of the appearance of the growth. The forms assumed are the most beautifully shaped I have ever seen; but they are very numerous, always retaining the tendency to form curves and circles." After a time the gelatine is liquefied, and the beautiful appearance of the colony is destroyed by the liquefaction of the gelatine.

These peculiar shaped colonies are most typical when the germ is taken from the diseased larvæ. After prolonged cultivation on various kinds of media there is a tendency for the colonies to become round, and the peculiar branching forms are not seen in such numbers. The composition of the gelatine also seems to make a difference in the appearance of the colonies. In gelatine containing 12 per cent. gelatine the processes are not so long. The same effect may be brought about by using more peptone in the composition of the media.

*Gelatine Tubes.*—In stick cultures at 20 deg. C. growth occurs all along the line of puncture. On the surface delicate branching or ramifying growth occurs in three days. These outgrowths soon run together, and the gelatine is liquefied, first around the line of puncture, and in five days extends over the whole surface. The growth in the depth of the gelatine occurs as a whitish streak all along the needle track; and from this numerous shoots and growths branch out into the gelatine in all directions, giving a haziness to the appearance of the gelatine, which then begins to liquefy. If the inoculation is a heavy one the shoots are coarse, and may have club-shaped extremities, and from these swollen ends fresh shoots may start. Cheyne obtained the most characteristic growth in gelatine containing 3 per cent. of peptone, as well as 10 per cent. gelatine. The whole tube is liquefied in from 2-4 weeks' growth. The liquid becomes yellowish in colour, and gives off a peculiar odour. Klamann states that in gelatine acidified with lactic acid, the growth is slow, and long threads are formed.

*Gelatine Streak Cultures.*—In gelatine streak cultures the appearance is very similar to what one sees in stick cultures. The bacilli first grow along the line of inoculation, and then throw out shoots into the surrounding gelatine, producing the appearance noted in

the stick culture. The bacilli move to and fro along the channels of liquefied gelatine.

*Agar Plates.*—On agar plates at 37 deg. C., the colonies at the end of eight hours are small and burr-like, with spines protruding in all directions, giving the colony the appearance of a sea-urchin. In some cases the projections are from one side or end. At the end of twelve hours the colonies have well-defined projections, visible to the naked eye. The colonies in the depths of the agar are more spiny, the processes being much shorter. On agar plates, streaked with a light inoculation, most beautiful forms occur. The growth of the bacilli spreads over the surface and branches repeatedly, giving the appearance of seaweed. This appearance is distinctively characteristic, and as the growth is very rapid, this method commends itself for making a quick diagnosis of the presence of the bacillus in larvæ supposed to be diseased.

*Potato Cultures.*—On potatoes the growth differs considerably, according to the reaction and age of the potato. Sometimes a brownish wrinkled growth forms, which gives off a peculiar odour; at other times a dryish yellow layer appears. "The bacilli grow very slowly indeed at 20 deg. C." (Cheyne, 23). Even at 37 deg. C. they grow slowly.

*Milk.*—In milk at 37 deg. C., coagulation of the casein occurs in three days. The milk becomes yellowish, and gives off a characteristic odour. After several weeks' growth the curd is digested, and a whey-like fluid remains.

*Blood Serum.*—On blood serum at 37 deg. C., the growth is rather slow, and polymorphic forms are common. "Very long filaments are formed" (23). These long forms may be from five to ten times as long as the average bacillus growing on gelatine, and consist of single cells. The filaments are often wavy or twisted, and of unequal thickness. The extremities of the long, bent rods are often clubbed, and Y-forms are numerous. Spores are formed very sparingly, and the blood serum is liquefied.

*Synthetic Media (Uchinsky).*—In Uchinsky's medium no growth occurs; but if the medium is neutralised, good growth ensues. The bacilli occur in threads, and a pellicle is formed.

*Dunham's Solution.*—The bacilli are small when grown in this solution. No threads form, but there is a slight indol reaction after nine days' growth.

*Relation to Free Oxygen.*—Cheyne states that the germs grow most rapidly on the surface of agar, and arrange themselves side by side; and they produce spores in this position after a few days' growth. Eisenberg (39) says nothing under the head of "aerobiosis." Howard (40) writes that "It grows best under anaerobic conditions; is a facultative aerobe; grows under the mica plate; and in the



presence of oxygen the growth is slight and slow." Howard also states that under anaerobic conditions it emits a foul odour resembling that of foul brood. It will be thus seen that Cheyne and Howard do not agree on this point. The former author also says that the characteristic odour is given off under aerobic conditions, whilst Howard states that this smell is emitted under anaerobic conditions. Further, Cheyne states that the bacilli grow with great rapidity on the surface of agar, whereas Howard obtains his best growth under the mica plate, which does not give complete anaerobiosis. Howard's conclusions are thus at variance with Cheyne's, and my own results fully corroborate those of the latter author.

Howard states that the vitality of the spores of *B. alvei* is destroyed when exposed to atmospheric air from twenty-four to thirty-six hours. In making his experiments he took sterilised roak-dust and mixed it with the dry foul-brood masses from several cells which were previously dissolved in distilled water. The mixture was worked dry, and spread on sheets of paper, and trial cultures were made immediately and at intervals of every twelve hours for three days; and according to his results no growth occurred after thirty-six hours. In giving these results, Howard does not state whether he exposed the spores to sunlight or diffused light; nor does he mention the age of the dry foul brood masses, which he used from several cells. These are points of considerable importance, for as every one knows the disinfecting power of direct sunlight is much greater than diffused light, and the vitality of the spores from foul brood masses of different ages varies considerably. This, I may add, has been clearly shown by some of my experiments, subsequently described. In my experiments, the spores obtained from a pure culture on the surface of agar were spread on cover glasses and placed in a glass chamber, so arranged that a current of air was constantly circulating over them. This chamber was exposed to the ordinary light of a room with six large windows, and a cover glass was taken out every twenty-four hours and tested, to see if the spores would grow. This experiment was continued for one month, and at the end of that time the spores still germinated rapidly. In another experiment, spores spread on cover glasses were exposed to a very diffused light, simulating as far as possible the amount of light which would enter a hive. Cover glasses were taken out from time to time and transferred to agar, in order to ascertain if the spores were alive or not. The experiment was begun two years and four months ago, and from the last cover glass taken and placed upon the surface of an agar plate a copious and typical growth of *B. alvei* was obtained. Further, thin strips of filter-paper, plunged into a bouillon culture and allowed to dry, were threaded on a wire suspended in

a wire basket and so exposed that the air could freely circulate around them in the ordinary light of a room. Trial cultures were made at intervals, and at the expiration of six months the spores from the paper germinated when the strips were placed on the surface of agar.

Again, a drop of bouillon containing spores was placed in a sterile tube and allowed to dry; and at the expiration of 124 hours (thirty-six of which were in sunlight at a temperature varying from 30 deg. to 37 deg. C.) sterile bouillon was added. The tubes were then placed in the incubator, and in less than twenty-four hours a good growth of the germs had taken place.

From these experiments it will be seen that the results are directly at variance with Howard's statement, as they go to show that the vitality of the spores of *B. alvei* is not destroyed by exposure to atmospheric air, with or without sunlight, for even a much longer time than twenty-four to thirty-six hours.

With regard to the aerobiosis of this bacillus, good growth has been obtained in an atmosphere of hydrogen by Novy's method. Buchner's method also gave good results. The growths in the various media are very similar to those produced under aerobic conditions, but with this difference, that the surface growths are, as a rule, whiter in the hydrogen atmosphere. In illuminating gas (water gas) no growth occurred; but the spores were not destroyed by the action of the gas; for when the gas was let out of the Novy jar good growth ensued on all cultures. In acetylene gas a restricted growth occurred. In fermentation tubes, growth occurred both in the open and in the closed arm of the tubes. No gas was formed; the bouillon in the closed arm was uniformly turbid. Thus *B. alvei* is a facultative anaerobe.

*Production of Alkali.*—In ordinary bouillon a slight amount of ammonia is formed. Control bouillon did not give the Nessler test. In glycerine and the sugar bouillons, there is no trace of ammonia. Cheyne's cultures are faintly alkaline, both before and after inoculation in meat infusion. Klamann states that ammonia is produced.

*Acids Formed.*—A varying amount of acid is formed. All the sugar bouillons give an acid reaction.

*Formation of Pigment.*—On potatoes a yellowish growth is produced; on all other media the surface growth is white.

*Development of Odours.*—Cheyne states that gelatine cultures give off an odour of stale, but not ammoniacal, urine, or what may be better described as a shrimpy smell; and this peculiar odour has been found by Cheshire to be distinctive of diseased larvæ. Klamann and Howard both state that a peculiar odour resembling that of the diseased larvæ may be noticed in artificial cultures.

*The Effects of Desiccation.*—I have already

noticed, under the head of "Relation to Free Oxygen," that the spores of *B. alvei* have considerable vitality in withstanding desiccation. My experiments prove conclusively that the spores are extremely hard to kill by desiccation, and in this respect resemble those of anthrax, which are known to resist thorough desiccation for a number of years. One experiment which showed this characteristic was as follows: An agar plate completely covered with a typical growth of *B. alvei* was allowed to dry out completely, and was left exposed to the ordinary light of the room for seven months, and at the end of that time a portion of the film was scraped off with a knife, placed on suitable medium and incubated, with the result that a typical growth immediately ensued.

Spores on cover glasses were exposed to September sunlight (latitude 43) for varying periods of time, and growth occurred after four, six, and seven hours' exposure. The age of the spores varied from five days to eighteen months; and spores three months old were not killed by seven hours' exposure.

(To be continued.)

## Correspondence.

*The Editors do not hold themselves responsible for the opinions expressed by correspondents. No notice will be taken of anonymous communications, and correspondents are requested to write on one side of the paper only and give their real names and addresses, not necessarily for publication, but as a guarantee of good faith. Illustrations should be drawn on separate pieces of paper. We do not undertake to return rejected communications.*

*\* \* \* In order to facilitate reference, Correspondents, when speaking of any letter or query previously inserted, will oblige by mentioning the number of the letter as well as the page on which it appears.*

### AMONG THE BEES.

[5032.] *Bees Re-Queening.*—A thought strikes me in casting my mind's eye back over some experiences I had last season, and I will endeavour to embody it shortly in this paragraph. During the summer many colonies which failed to swarm owing to the wretched weather made preparations for it time and again; and several of them deposed their old queens and reared young ones to supersede them, but these virgins, owing to the inclement season, failed to meet the drone. I know that many other colonies re-queened themselves pretty late in the season, when it was practically impossible to count with any confidence on these virgins obtaining a nuptial flight. Where these hives were winter packed without any brood being seen, or without an examination to certify that the stock was headed by a fertile mother, an eye should be kept on that colony in early spring to see how it behaves; and on the very earliest opportunity every hive should be examined, to place the matter

beyond the possibility of a doubt. In too many cases, I feel morally certain, large numbers of colonies will be found dead, or so depleted as to be worthless, from having passed the winter under the presidency of a mother incapable of laying worker eggs. Already I hear of casts, and even swarms and stocks, extinct, or progressing to extinction. Their original weakness, coupled with the defective breeding owing to the wretched season and want of natural stores, will account for several of these; but I understand many skeps are showing evidence that the combs were never bred in.

*The Ubiquitous Bee.*—Three further examples of its ubiquity came under my notice lately. On reading Bret Harte's description of his visit to Stoke Pogis, where the poet Gray is buried, and which is the scene of his "Elegy in a Country Churchyard," I found the following, which I reproduce without note or comment:—"It was a perfect day. A few bees were humming around the tomb, as if they were chanting the Elegy, and were half drunken with its sweets." In the Glasgow Necropolis one lingerer of many mourners recounts that he saw three bees light on, and suck honey from, some flowers in a wreath left on the new-made grave.

Thomas Aird, whose centenary was celebrated at Dumfries last summer, was a Border poet and a great lover of Nature. He had the rare gift of sucking out of the country its inmost soul and making it speak. Wandering in those lovely glens and dales, or by the mystic Eildon's Three, he seemed to become aware of "divine footsteps and the aroma of some beautiful bodily presence." He often saw and heard the bees on his lonely walks; and, in "A Summer's Day," he saw them in a churchyard gathering sweets from flowers planted on a grave, and sings,

"Bloom, then, ye little flowers, and sweetly smell,  
Draw up the heart's dust in your flushing hues  
And odorous breath, and give it to the bees."

Think of it, my friends! The "heart's dust" being changed into fair flowers, and the bees sucking out their essence in the shape of nature's sweetest and most delicious aromatic nectar.

*Some Minor Sources.*—The Chapman honey plant created quite a furore at one time, and there was a prospect of a great boom in its propagation, but little is now heard of it. Borage has often been deservedly praised as an excellent honey-yielding flower, but is seldom grown in quantity. Field mustard, where plentiful, makes bees hum on any field where it grows. Sometimes it candies almost as soon as it is gathered. Fruit blossom yields some of the most exquisitely flavoured honey capable of being produced. The sycamore or plane, when grown near hives, enables colonies to build up rapidly in the early part of the season. A field of beans yields copiously at times, though its produce is not a high class honey, being rank, and considered by some to

be highly unpalatable. In America, a few of the minor sources are Cleome, a Rocky Mountain bee plant, which in its native habitat "furnishes large quantities of honey." Better has been recorded of another Cleome—the spider plant. It bears on each floret a drop of liquid, distinctly seen by the naked eye, and so large that three successive bees can load up from its "sparkling ambrosia" and yet leave some nectar behind. One more of these marvellously yielding plants must suffice at present. The willow-herb was highly praised at a Bee Convention in Michigan. Mr. Hutchinson styled it the whitest and sweetest honey he had ever tasted." The high quality of the honey, its unfailing supply from year to year, as it follows right after clover and basswood and blooms from then until frost make it one of the most valuable honey plants known. Our willows, at long intervals, yield copiously, but we must wish fervently we had such sources as several of those I have quoted as being too common in America.

*Three Months' Imprisonment.*—Weather has been consistently wintry from the early days of November, and so my bees have been kept closely confined to their hives without once, so far as I am aware, enjoying a single free flight. It is devoutly to be wished that a few mild days may intervene to allow them an outing before they are again confined for another long spell. This species of semi-hibernation must mean a great conservatism of stores; but as bees do not go entirely to sleep like the common house fly, the queen wasps, and the humble bees, too long a period of lethargy may not be an unmixed blessing.—D. M. M., *Banff*.

## AN OBSERVATORY HIVE.

### MY FOURTH SEASON'S EXPERIENCE.

[5033.] Owing to my absence abroad during the most important part of the season, my report of last year's observations must be fragmentary. In order to carry out my intention of experimenting with Carniolans I had ordered a queen of that variety from an Austrian dealer. She arrived last August mutilated in the right fore leg, and another sent to replace her came to hand minus the right hind toe. These accidents happen, I believe, from the dealer pushing home the little slide that closes the travelling box before the queen has moved forward to join her fellow captives. There being no chance of getting a third Carniolan queen in time I started the season with a strong colony of blacks; they proved the most disappointing bees I ever had to deal with.

In order to ascertain in what way the cells would be built, I placed, as an experiment, a perfectly plain sheet of wax, full frame size, in the hive, together with drawn-out combs, frames with ordinary foundation, and one comb from which the greater part had been removed, leaving a large vacant space in the

middle. The plain sheet remained unworked throughout the season, and nothing was done to replace the comb removed, a very unusual omission in the case of a strong colony. A plain sheet inserted in one of my outdoor hives has given good results that I hope to follow up.

Shortly after my departure, in May, a third queen arrived from Carniola. The colony had begun to make preparations for swarming, but my son removed the black queen and caged the new one on the top of the hive. Unfortunately, the method adopted allowed of the bees worrying her in the cage, and she died on the second day; and the next day, on their old queen being restored to them, they promptly killed her too.

I returned in time to find a young queen newly hatched. She showed unusual timidity in leaving the hive, lingering in the entrance and taking very short flights, and it was more than fourteen days before she was at length mated, as I concluded from seeing her trailing a dried-up thread-like appendage behind her. But she did not lay, and to cheer up the dwindling colony I fed liberally and flooded the passage-way with honey-syrup. This had a curious effect. The bees divided into two parties, as far removed from each other as was possible, and the party that kept the queen frequently "balled" her. No work was done; no eggs were laid; and after waiting about twenty days more, I turned out all the remaining inhabitants into a small supering skep well supplied with stores, in the hope of being able to ascertain whether the queen would lay in the ensuing spring. It has been stated before now, on apparently good proof, that a queen may mate a second time even after a fairly long interval and prove a good laying mother. That might have happened with this queen, or she might after all have laid on the first impregnation; it would have been interesting to follow out, but unfortunately the little colony has not survived the winter, having been robbed, I am inclined to believe, without my noticing it.

Last year I suggested that bee-keepers should decide from their own observations whether bees clean their antennæ with the opposite fore leg, as asserted in the guide books, or whether each antennæ is cleaned by the leg nearest to it, and if any one has acted on my suggestion I hope he will give his experience. I have again devoted much attention to the cleaning operation, and I feel convinced that it is carried out on the nearest side.

I have on previous occasions called attention to the fact that bees may often be seen turning round repeatedly and shaking themselves like a dog just out of the water, and that when this ceases for a moment other bees rush in upon them, retiring again rapidly when the bee again begins to shake himself. The operation seems to constitute a kind of game, which I have called *chiveying*. I have sug-

gested that as this shaking was generally done by a bee carrying pollen loads or who had recently deposited pollen, it is probably due to a wish to clear the spiracles from pollen that may be inconveniencing their action. I have no fresh solution to offer, but in the course of my study of ancient bee literature I have been pleased to find that Aristotle noted the curious habit some 2,200 years ago. In Book IX, chap. 40, of his "History of Animals," he tells us:—"Bees also, climbing along flowers, gather wax with their fore feet with great agility. Afterwards they wipe the wax off these feet and transfer it to the middle feet, and from thence to the curvatures of the two hind feet, and thus laden they fly away. . . . They gather from flowers of one species. . . . But when they arrive at the hive they shake themselves, and three or four bees follow each of them." For wax we should of course read pollen.

The renowned physiologist and surgeon, John Hunter, who kept an observatory hive, also noticed the habit, and mentions it in his "Observations on Bees," published in the "Transactions of the Royal Society" in 1792, when he made known the way in which wax is produced in the scale pockets of the bees. He seems not to have been aware that his discovery was not original. "We very often see," writes Hunter, "some of the bees wagging their belly, as if tickled, running round, and to and fro, for only a little way, followed by one or two other bees as if examining them. I conceived that they were probably shaking off the scales of wax, and that the others were ready upon the watch to catch them, but I could not absolutely determine what they did."

I prefer my own explanation to that of Hunter, but join in admitting that I could not absolutely determine. It is pleasant to reflect that such an apparently unimportant habit has not escaped the attention of these great observers. It should serve as an encouragement to us who humbly follow them, and at the same time as a reminder how careful we should be to read up our subject thoroughly before we begin to fancy that we have discovered anything new.—H. J. O. WALKER (Lieut.-Col.), *Leeford, Budleigh Salterton, January 31.*

## THE VALUE OF STRONG COLONIES.

### HOW TO SECURE THEM.

[5034.] About this time last year there was some discussion in your pages as to how strong colonies could be secured, but notwithstanding its importance, the subject was dropped rather abruptly, leaving those interested in a state of uncertainty as to whether such desirable colonies could be ensured by the adoption of a "nail keg" as a hive, or by using a larger frame than the "Standard." I hope I am not narrow-minded myself, but it is not likely that any of my stocks will be transferred, to "nail

kegs," though I do mean to give a fair trial to the large frames, for it seems obvious to my mind that they have an advantage over the "Standard" in bringing stocks safely from the end of one season to the beginning of the next.

We cannot, however, get away from the fact that the heaviest crops of honey, and best average "takes" of surplus, in this country have been secured by working with the "Standard" frame, and so long as this is the case we must admit that our management rather than our frame is at fault.

What we should, therefore, do is bring all stocks up to the level of the "first-rate" ones—of those that give the heavy surplus—because what is possible with a few colonies in any apiary should be possible with all.

The colony that yields the large surplus most certainly went into winter quarters in the right condition, with plentiful stores and a large population of young bees. No "spring dwindling" occurs with this colony, the workers being mainly young bees do not die off in early spring, leaving thousands of immature bees to die for want of warmth. Nor is the queen at any time compelled to stop laying through shortage of stores; consequently, when the honey-flow begins the hive is overflowing with bees and supers are taken to at once. There is no trouble with swarming, the queen has already not only done her utmost; she has quite enough work before her in laying eggs to re-occupy the cells, vacated as they are by the fast hatching brood. Need we wonder, then, that this ideal stock goes ahead of all others in honey gathering, in view of the fact that it has been brood rearing, and working at the utmost pitch *before* the season opened, while with the others it began *after* the good time had passed by. We want all our queens to go and do likewise, it is our own fault if they do not. It is altogether a matter of autumn preparation, of proper winter-packing, and this packing is to be neither cork-dust nor chaff, but, as the late Mr. William Raitt always insisted, *bees*. I will go further and say that, in the fall, every colony should be reinforced not only with bees but with stores and brood as well.

It may be said that we do not want swarms. We generally get them, however, all the same, but to secure the best results we must anticipate the swarming impulse by dividing before the season opens, and the increase thus made is not to be used for bolstering up "weaklings," but is to be given back to the parent stock in the fall, and by this means putting it in the right condition for ensuring "safe wintering" and the avoidance of "spring dwindling." We have been told *ad nauseam* that the secret of success is to have strong colonies ready at the right time to gather in the honey. Why is it that the "authorities," who are continually harping on this subject, do not tell us *how* to get such strong colonies? Probably for the excellent reason that they

cannot. That being the case, bee-keepers should try to find it out for themselves.

It is said that "All things come to those who wait," and no doubt if we wait long enough this mystery of the apiary will at length be solved, but for my part I do not like the idea of waiting for anything that is likely to be got hold of sooner by being hunted up.

We surely are not all satisfied with the "let well alone" policy, or with relying on the achievements of the past. It would be futile to imagine that the methods of the nineteenth cannot be improved upon in this the twentieth century.

Reform will come, and the sooner the better. It will not necessarily take the form of a different frame, but of a better system of managing the one we have.—J. M. U., *Ussie Valley, N.B., January 30.*

[It will hardly be claimed by our correspondent that "the value of strong colonies" has either been ignored or under-estimated by the "authorities," who, he says "are continually harping on this subject," whoever they may be. Nor has there been any laxity in telling "how to get such colonies," or in showing that can be done. But however this may be, we are glad to publish the plainly-expressed method of our friend, "J. M. U.," by means of which the desired end may be attained, and will be very pleased to record results after being practically tested by readers.

The secret of why some colonies in every apiary will far outstrip others, no matter how we try to *equalise* results, is one that has puzzled bee-men—including ourselves ever since we began bee-keeping, and in a great measure it remains a secret still.—Eds.]

#### ABOUT FRAMES.

[5035] As a contribution to the discussion on frames, allow me to say that I have used several makes of "Standard" frames (outside dimensions) with "W.B.C." ends, and except that a  $\frac{3}{8}$ -in. top bar does "sag" occasionally have no complaint against it; but think that a  $\frac{1}{2}$ -in. top bar (reduced to  $\frac{3}{8}$  in. thickness at ends),  $\frac{5}{16}$ -in. side bars, and  $\frac{1}{16}$ -in. bottom bars, respectively, a decided improvement. I have not known the tenon-jointed kind to break at the mortices. The greatest strain on a beam is at its centre, but if the wood used is poor and cheap of course it may break anywhere. I do not have brace-combs, nor have I, to my knowledge, had a wax-moth in my apiary; but I must give details as to method used, as under other circumstances the effect might not be same. I use light brood foundation—namely, nine sheets to the lb.—finding that to use it heavier was just a waste of wax, the bees leaving a heavy mid-rib, and I wire with four horizontal parallel wires, as advised by Root, which throws some

of the weight on to the side bars, and thus relieves the top-bar from sagging. This straight wiring is much quicker to embed, and should not be too tight, as a little downward give is an advantage, should the foundation stretch when a swarm is put on it, in hot weather; otherwise it might buckle, not that I have ever known it to do so. I use 18 in. by 18 in. excluders and hanging section-racks, and do not find that the excluders disincline the bees to come up, but I never put supers on until the flow has started, and can handle "hangers" and shallow-frames more quickly, feeling confident that the queen is down below. Mr. Edwards mentioned that he thought his apiary was the only one with "W.B.C." hives that had no plinths; mine have none, being on the James Lee & Son "Waterproof cover" principle, nor do I have porches. In reference to what he says as to the wax-moth, and slotted top-bars, I always drive two oval wire nails to secure foundation, so that both halves of top-bar must stand level. The remedy for the careless bee-keeper one may come across is to *alter the bee-keeper*, not the top bar, as nothing will answer in the hands of such. I use American cloth quilts, and always have naphthaline in the hives, which probably accounts for the total absence of wax-moth. I make woven-wire baskets for the naphthaline, one of which is hung on the top bar of an outer frame in each brood-nest, as in sketch. The naphthaline needs adding to every fortnight or three weeks in hot weather, one has only to lift a corner of the quilt to see, and give, when more is needed, and the evaporation is better there than on the floor-board, where it is difficult to see, and is often turned out or propolised over by the

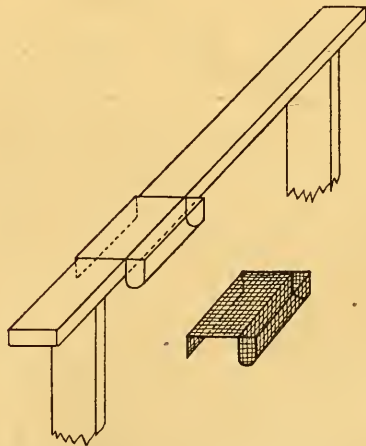

bees. The baskets are easy to make, but, if any one requires, I shall be pleased to give the manner. The rough sketch explains them.

About twice a year they need passing through the flame of a spirit lamp or boiling with soap to remove the propolis. I find no drawback to the top-bar slot in the way of

cleaning when required; the frames are just immersed for a minute, rack and all, into a boiling solution (2 lb. soft soap, a handful carbonate of potash, six buckets of water), and shallow-frames come out like new. A screw-driver in the slot withdraws the pointed ends of nails used to fix foundation, and small pliers, inserted in the slot, push back the head of nail. I also immerse my hives in the same way, when they come out clean, no scrubbing being necessary. An objection to fixing foundations with molten wax is that the wax used by some bee-keepers might contain disease germs.

Not being able to readily note the appearance of a stock at a glance, on removing quilt, would be to me an objection against wide top-bars, as would also the propolis together of close-ended and half close-ended frames be a draw-back from my view, as I like a brood-frame to detach and freely slide on the rebates, and use vaseline for the purpose. The Hoffman type of frames have a point in their favour for those who carry their stocks to the heather, &c., as they pack very firmly together sideways. I am inclined to try full closed-ended shallow-frames in supers.

I would suggest to those who hanker after larger frames to go in for longer stock-boxes, and have more frames, as Mr. Woodley does, or have two stock-boxes, one over the other, removing one to form nuclei, &c., before the honey flow, as advocated by our expert, Mr. Gray.

A point worth considering in the Standard frame is the neat way in which they pack together, like a box, when stored away, foundation ready for use, with "metal ends" removed.—G. M. SAUNDERS, *Keswick*.

## Queries and Replies.

[3024] *Danger of Buying Old Combs.*—Last spring I bought some old combs, put them into an empty hive, and hived a swarm on them. I have since noticed that some cells contain foul brood. Although the bees are weak in numbers they have a large amount of sealed stores, besides some candy which I put on in the autumn. As only a few of the frames appear to be infected, and I do not think that any brood has become diseased since I bought the combs, I ask:—1. Would it be any good my destroying those frames which are infected and leaving the others? 2. If it is necessary to destroy frames and bees would the honey be of any use? 3. And would the candy now on the hive be infected? I may mention that I have four other hives standing near at hand. I enclose my name, signing myself—MERTON, *Caterham, Surrey, February 1.*

REPLY.—Before replying to queries we strongly advise our correspondent to read up

the subject of foul brood, or make himself acquainted with the nature of the disease; otherwise a brief line of reply to the questions enumerated will not suffice to secure his bees from infection. For the rest, we reply:—1. So long as a single cell of foul brood remains in the hive the bees will be liable to an outbreak any day, but as the stock is now weak the bees are not worth saving. 2. The honey is quite fit for table use, but not for bee-food. 3. We should not care to use the candy for any stock but the one to which it was given.

[3025.] *Attending to Hives in Advance.*—Would you kindly advise me in your next issue of the B.J. what I had better do in regard to "spring feeding" of my bees (fourteen hives)? I shall be leaving home for three months in the early part of March, and there is no one I can ask to feed them with syrup or do anything in the way of putting on the supers and adding the extra frames. 1. Could I commence feeding at the end of this month, and then place supers and frames in the week before leaving? 2. There is one hive affected with foul brood. What could I do with that? I thought of getting the bees off the combs and placing them in a new hive with full sheets of foundation and as many spare frames as possible. 3. What is the best way of starving bees? Would it do to place them in a bag, or can I take away all frames and shut up the hive for three days? I wanted to put all the bees in repainted hives this season. 4. Would it be safe to transfer them (on a warm day) the first week in March? 5. How can I disinfect the foul-broody hives which is almost a new one? 6. What could I do with some over-medicated soft candy? Would it melt down again and serve for the spring feeding?—REDLAR, *Lymington, Jan. 31.*

REPLY.—1. A 2-lb. cake of well-made soft candy, given the second week in March, will tide the bees over till natural stores come in, unless the hives are badly off now. 2. If the bees are to be left entirely uncared for during the spring months, we advise destruction of the diseased colony, and so avoid risk to the other stocks. 3. On no account treat the affected stock as proposed. By getting them off combs and starving them in March, it would simply mean failure and worse. 4. Why not paint the hives without disturbing the bees at all? It would save trouble, and answer well. 5. You will find full directions in "Guide Book," which we think you already possess. 6. Yes; but it is a rather troublesome job, and it must not be allowed to over-medicate the syrup.

[3026.] *A Transferring Difficulty.*—Some time ago an old bee-keeper located in this district died, and I bought from the widow a bar-frame hive, with bees in it; also a box containing a stock of bees. (The bee-man referred to used boxes instead of skeps.) Regarding the frame-hive I bought, the bees have so fastened the frames together with

brace-combs that it is impossible to remove them; consequently I have decided to let them remain, and allow the bees to swarm. But after getting the first and second swarms I am at a loss what to do. I should like to save the bees and combs of the parent stock, but the hive has a fixed bottom, so that I cannot follow the plan of putting it on top of another hive for the bees to transfer themselves. I therefore ask:—1. If an empty straw skep is put on top of frames after the second swarm has come off, would the bees go up in skep? If they would do this after they had started building combs, and partly filled them with brood, I could remove the skep as a new stock, and keep them over the winter for swarming the following spring. I then could clean out the frame-hive and fit it properly up with new frames. 2. With regard to the stock in box, the latter has, as already said, a fixed bottom. But there is a square hole on top, so that a super could be set above it. I could, therefore, put a skep on box as super, and remove the same when full. I want to avoid killing the bees, and should be pleased if you would instruct me how and what to do through your valuable paper, to which I have been a subscriber for about a year, and I find it a great help and very interesting. I enclose name, &c., while I sign myself—L., *Bideford, North Devon, February 2.*

REPLY.—1. No; after swarming twice the bees would probably not enter the skep at all, and they would certainly build no comb therein this year. 2. The stock may be supered as proposed, if you care to keep it as a box-hive.

[3027.] *Can Shallow - Frame Boxes be Adapted for Holding Sections?*—Referring to my query (3017, page 40), I fear you have not quite understood my question. I wished to know if it was not possible to use the shallow-frame boxes—as sent out by dealers—for the “W. B. C.” section-racks with hanging frames for comb honey. I have plenty of shallow-frame boxes, but they are about  $\frac{3}{4}$  in. too deep for the proper beeway required below the section when put on body-box. Will it not be possible to have a  $\frac{3}{4}$ -in. board with long slots made to fit inside super, something like the Rymer honey-board? This would be less expensive and take up less room in stowing away for winter. And further, if the top of the slots were bevelled back in wedge-shape, there would not be the difficulty to the bees clearing out their dead through the passages as they have through the excluder zinc.

Might I ask your readers in this out-of-the-way corner of Yorkshire if they could not manage to have an expert to visit this district as early as advisable in the coming spring, so that, if any stocks are found dead, maybe from foul brood, steps may be taken to eradicate the risk of infecting healthy colonies, and pay according to the number of stocks examined? I know a few who would gladly

fall in with the idea, especially if all apiaries found clear of disease should have a certificate to that effect given by the expert. It would be interesting to know what our bee-friend, the Rev. Mr. Lamb, thinks of this idea, and if the Holderness B.K.A. is taking any steps towards it?—J. R., *Keyingham, Hull, February 2.*

REPLY.—The only thing really needed to make the shallow-frame box usable as a section-rack of the “W. B. C.” type, is to make the bottom of hanging-frame of the required thickness to leave a  $\frac{3}{8}$ -in. bee-space between it and the brood-nest. The slotted board would also serve the end in view, but we should prefer only two long slots (one on each side), and make no attempt to restrict the width of slots to excluder-zinc size.

[3028.] *Bees Uniting of Themselves in “Wells” Hives.*—I happen to possess a colony of bees in a “Wells” hive which I got some time ago. I am feeding them with candy, a hole being cut through the quilts in the centre of the top of frames. Somehow in getting the hive home, the candy-box got slightly moved, and when I looked at it last Saturday I noticed that all the bees of both compartments had got all together in one side of the hive. I presume that in this case there will only be one queen left now. I therefore ask:—1. What do you advise me to do? In another of my hives I find that the frames in the brood-nest are spaced irregularly, in some places there is 2 in. space between the frames and in others they are close together. The bees have also built the combs and braced all together between the larger spaces. 2. How am I to arrange these frames correctly? Is it advisable to take some of these out and put in full frames of worker foundation as soon as the bees begin to fly? 3. In another hive I have twice seen the larva of the wax-moth. What treatment do you advise for this? I suppose it is nothing so serious as foul brood. I intend when the first mild week-end comes to take the frames out and look them over. Will this harm them?—A. H., *Sheffield, Jan. 28.*

REPLY.—1. Allow the bees to remain as they are. 2. If there are a few straight combs in the hive, you may get the bees to work similar ones as proposed by using frames properly spaced with metal ends. 3. Kill the larva whenever seen. If the bees are strong, they will keep the moth down.

## Echoes from the Hives.

*Rye, Sussex, January 29.*—After a spell of rough and cold weather the bees have been almost dormant; to-day, however, the weather has been fine and warm, and the bees have taken advantage of it by having a grand “cleansing flight.” They came out of the hives in thousands. An old skeppist shook his head. “Ah!” said he, “I don’t like it;

it's too soon for so many bees to be about." He then went off into a rambling statement as to what "his father used to say," so I let him have his way in feeling "sorry for the bees," while I was only too pleased to think they had been enjoying themselves. Of course, I know this livening-up tells on the store-cupboard, but that can be seen to by the bee-keeper, and the expense will be a mere nothing compared with the sight I witnessed to-day, and by knowing they are all safe and sound.—HENRY CLARKE.

### WEATHER REPORT.

WESTBOURNE, SUSSEX.

January, 1903.

Rainfall, 2.35 in.	Sunless days, 14.
Heaviest fall, .72, on 4th.	Below average, 12.2 hours.
Rain fell on 22 days.	Mean maximum, 44.5°.
Above average, .29 in.	Mean minimum, 35.8°.
Maximum temperature, 54°, on 5th.	Mean temperature, 40.1°.
Minimum temperature, 24°, on 16th.	Above average, 3.6°.
Minimum on grass, 17°, on 15th.	Maximum barometer, 30.59, on 14th.
Frosty nights, 10.	Minimum barometer, 29.44°, on 7th.
Sunshine, 56.1 hours.	
Brightest day, 28th, 5.7 hours.	

L. B. BIRKETT.

### Notices to Correspondents & Inquirers.

Letters or queries asking for addresses of manufacturers or correspondents, or where appliances can be purchased, or replies giving such information, can only be inserted as advertisements. The space devoted to letters, queries, and replies is meant for the general good of bee-keepers, and not for advertisements. We wish our Correspondents to bear in mind that, as it is necessary for us to go to press in advance of the date of issue, queries cannot always be replied to in the issue immediately following the receipt of their communications.

All queries forwarded will be attended to, and those only of personal interest will be answered in this column.

"HAVERSTOCK" (Northwich).—*Discussion on Foul Brood.*—It can serve no good purpose to occupy space in criticising the varying opinions expressed on the cure, or failure to cure, foul brood, as the case may be, in the hands of different bee-keepers. One man tries and fails; another tries and succeeds. We are glad in one case and sorry in the other, and may take each "experience" for what it is worth. But when our correspondent sends a series of "important questions," which, he says, "might be discussed with profit," at a time when a large portion of our space every week is occupied by portions of a valuable treatise on the whole subject, we think our friend "Haverstock" will agree that Professor Harrison's views on foul brood will suffice for the present.

S. J. HUDDLE (Kent).—*Bees Flying in Frosty Weather.*—Under normal conditions bees seldom leave their hives in frosty weather. It happens at times, however, that during a bright sunny day in winter, if the sun's rays bear directly on the hive entrance, the bees will be tempted forth, and, no doubt, some are chilled by the cold and never return. The only remedy is to fix up a temporary screen to shade the entrance as you propose.

"INQUIRER" (Newcastle-on-Tyne).—*Bee-keeping near Newcastle.*—Your letter has been forwarded to the writer of 5030 (page 48) as requested. Mr. Jas. Waddell, Hon. Sec. of the County B.K.A., also writes to say he "will be pleased to afford all information and give assistance if required by addressing him at 'Wooler, Northumberland.'"

J. S. BOREHAM (Wickham Market).—1. *Hiving Driven Bees on Combs from Diseased Stocks.*—It is a fatal mistake to hive bees on ready-built combs in which a few cells are found to be affected with foul brood. The "few cells" clearly indicate a diseased stock, and it only needs time to develop the mischief in the new colony hived on them. 2. *Unseasonable Transferring.*—This is also a mistake. Nor, indeed, can we quite make out what is the position when you write in mid-winter (February 2): "I have lately bought several pails of bees"; then go on to say: "One lot I transferred to a new hive a fortnight ago." Surely the "pails" of bees cannot be driven lots! Anyway, we are not surprised to find the bees troubled with dysentery when they are fed up on syrup in January. This is, in every sense, unseasonable manipulating, and we fear it points to trouble ahead with regard to your bee-keeping.

AMATEUR (Pitlochry).—*Painting Bee-feeders.*—No harm can follow if the paint is dry before using. All wooden feeders are painted at the joints with white lead or paint to make them water-tight.

"WELLS" (Yorks).—*Using the "Wells" Hive for Clover and Heather Districts.*—The suitability of the "Wells" hive for such a locality as you hail from (Skelton-in-Cleveland) might, we think, be judged by its results in the hands of a capable bee-man like Mr. J. Rymer, of Levisham, near Pickering, whose experience has been fully recorded in our pages; but, as a matter of fact, the double-queen (or "Wells") system depends for success largely on the bee-keeper himself, as has been fully demonstrated many times over by correspondents of the B.B.J.

ACONITE (Epsom).—*Hiving Swarms on Old Combs.*—If the hive from which the combs and food were taken was free from disease, the combs and food may be used for a swarm, as desired, without risk.



## Editorial, Notices, &c.

### NOTTINGHAMSHIRE B.K.A. ANNUAL MEETING.

The annual general meeting of the Nottinghamshire Bee-keepers' Association was held on Saturday, February 7, in the People's Hall, Heathcote-street. In the unavoidable absence of the President, Viscount St. Vincent, the chair was occupied by Mr. W. S. Ellis, Vice-President. There was a large attendance, amongst those present being Miss Bingham, Messrs. P. Scattergood, A. G. Pugh, S. W. Marriott, W. Herrod, R. Mackender, T. Manchester, G. Smithurst, G. E. Skelhorn, J. Gray, R. Turner, T. Randall, and Geo. Hayes, Secretary.

The balance-sheet for the past year was adopted. It showed that the receipts amounted to £99 3s. 11d. (including £42 7s. 4d. from the Notts. County Council), and £33 5s. 6d. in subscriptions. The expenses were met within 16s. 21., this being the amount of the deficit on the year.

The Secretary presented his annual report, which showed the membership had slightly increased in 1902, and that the adverse balance on the year's working was only 16s. 21., an improvement on the previous year, if a small one. The annual show for 1902 was again held in connection with the Moorgreen Agricultural and Horticultural Societies in September last, and was a great success. A show was also held at Southwell, as in previous years, and some splendid honey was staged. The Notts County Council had increased their grant to £50, and lectures have been given at Newark, Mansfield, Kirkby, Cotgrave, Sutton-in-Ashfield, Kingston, Welbeck, Sitton Bonnington, Clarbrough, and Moorgreen. Lantern lectures are also being given at Rdwinstowe, Collingham, Besthorpe, Farnsfield, Bawtry, and Thoroton. The Nottingham City Council had also renewed their grant, which enables the association to continue its educational work as before. The insurance scheme was now in full working order, and some members had taken advantage of it. Of two candidates for the 3rd class Experts' Certificate, one passed, viz., Mr. Horace Mackender, of Newark. During the spring 174 bee-keepers had been visited. These owned 595 stocks in frames and 115 in skeps. Of these stocks 467 were examined, but only twenty-one were found affected with "foul brood." Attention was called to the fact that the British Bee-keepers' Association had adopted a system of grouping the various counties for competition at the "Royal," and other London shows. This offered a favourable chance to members of winning the prizes offered.

The election of officers resulted unanimously as follows:—President, Viscount St. Vincent; committee, Messrs. T. N. Harrison,

S. W. Marriott, A. G. Pugh, T. Randall, G. E. Skelhorn, G. Smithurst, W. Swann, J. C. Wadsworth, F. Chastaney, together with the hon. secretaries and experts. Messrs. A. G. Pugh, and G. Hayes were appointed delegates to the meetings of the British Bee-keepers' Association. Mr. Geo. Hayes was re-elected secretary and treasurer.

After tea, the presentation of prizes, medals and certificates was gone through. Mr. W. Herrod then gave a ten minutes' talk on "The Growth, Progress, and Uses of the British Bee-keepers' Association's Apiary," following this with other instructive discourses on "Foul Brood," and "College Life." These "bee-talks" were varied by an interesting miscellaneous programme, consisting of music, readings, &c., contributed by Miss Mabel Smith, Mr. W. Cartledge-White, Mr. Mackender, Mr. E. Spray, Mr. Skelhorn, and Mr. Wadsworth.—(Communicated.)

### FOUL BROOD OF BEES.

By F. C. Harrison, Professor of Bacteriology.

(Continued from page 54.)

#### THERMAL RELATIONS.

*Maximum for Growth.*—The maximum for growth is about 47 deg. C. At 44 deg. C. good growth occurs; but at 50 deg. C. growth ceases. Experiments on maximum for growth were performed on germs isolated from a number of different places, and little or no difference was noticed in their behaviour when incubated at the temperatures mentioned.

*Optimum for Growth.*—The optimum for growth is about 37.5 deg. C. for all media except gelatine. This has been determined by Cheyne and Eisenberg (39). On gelatine the best results are, of course, obtained from higher temperatures; but as 10 per cent. gelatine melts at about 24 deg. C., 22 deg. C. cannot be exceeded.

*Minimum for Growth.*—Cheyne says that the bacilli do not grow below 16 deg. C. I have, however, occasionally obtained growth at 14 deg. C. on the surface of agar; but it has been extremely slow. The spores will not germinate at this temperature. No difference, under this head, is apparent in germs obtained from different countries.

*Thermal Death Point.*—This is a very important matter, because in the heating of wax and honey from colonies suffering from foul brood it is necessary to know the temperature that will destroy spores, and thus prevent the infection of other bees; and unfortunately a considerable discrepancy exists in the results of experiments to determine the thermal death point of the bacillus, accounted for in part by the different methods used by different investigators.

McKenzie (28) found the thermal death point by suspending silk threads saturated in

a beef broth culture of *B. alvei* containing spores. The threads were allowed to dry, and introduced into melted wax, and left therein for a definite time, at a fixed temperature. At the end of that time, the thread was introduced into melted agar and thoroughly shaken so as to separate the wax from the threads. The cultures thus made were rapidly cooled, and the tubes placed in the incubator at 37 deg. C. The following are his results:—

At 100 deg. C. for $\frac{1}{4}$ of an hour—growth			
" " $\frac{1}{2}$ " "	"	"	"
" " 1 hour "	"	"	"
" " $1\frac{1}{2}$ hours "	"	"	"
" " 2 " "	"	"	"
" " $3\frac{1}{2}$ " "	"	"	no growth.
At 90 deg. C. for $\frac{1}{2}$ hour—growth.			
" " 1 " "	"	"	"
" " 2 hours "	"	"	"
" " 3 " "	"	"	no growth.
" " 4 " "	"	"	"

A temperature of 50 deg. C. did not destroy the spores in twenty-four hours. These experiments were repeated with the same results, which results were criticised by Corneil (28), who claimed that the heat to which the bacteria were exposed in melted wax was not moist but dry heat, and consequently that the wax had to be heated to a high temperature and for a long time in order to destroy the spores. According to the testimony of two prominent foundation-makers, the wax during the refining and purifying process reaches a temperature of quite or nearly 100 deg. C. for a short time. During the sheeting, however, it does not reach a temperature much above the melting-point, say, 79 deg. C. Two other foundation-makers, Dadant and Hunt (41), state that, in refining, the wax is heated for some time to 100 deg. C., and is kept liquid for twenty-four hours; so McKenzie thinks that if these temperatures are reached in the making, there is little danger of foul brood from comb foundation, as the specific gravity of bacteria in the melted wax is so great that throughout the process of manufacture the bacteria tend to fall to the bottom. Sternberg (42) states that the spores require for their destruction a temperature of 100 deg. C. for four minutes (determined in 1887); but there is no statement as to the age of the spores. In Howard's experiments (40) tubes of liquid gelatine containing spores of *B. alvei* were placed in an open vessel of boiling-water and allowed to remain therein for a definite time—"in all probability the water did not reach boiling point"—and trial cultures were made at stated intervals, with the following results:—

After 15 minutes—growth.			
" 30 " "	"	"	"
" 45 " "	"	"	"
" 50 " "	"	"	no growth.
" 60 " "	"	"	"

His trial cultures were on potato and gelatine; but no statement is made regarding the age of the spores, where they were from, or the temperature at which they were incubated. It is, however, evident that they were not given the most favourable conditions for growth.

I have myself performed the following experiments on the thermal death-point of the spores:—

*Method.*—Test tubes containing bouillon were placed in boiling-water. Three loopfuls of culture were introduced into each of the tubes; and tubes, withdrawn from the boiling-water at stated intervals, were cooled and incubated.

*Results.*—1. Spores from a seven months old culture in bouillon were killed at a temperature of 100 deg. in one hour and twenty minutes.

2. Spores from a two and a half months old culture on agar were killed in two hours and a half.

3. Spores from agar nine days old—slight growth after two hours and forty-five minutes; no growth after three hours.

4. Spores fourteen days old and twenty-one days old—in each case after two hours' boiling, one of the duplicate tubes formed a growth; another after two and a half hours, whilst the remainder had no growth. All were killed in three hours.

I used also fine capillary glass tubes. A suspension of the spores in water was drawn up into sterile tubes, which were then sealed at both ends. The tubes were placed in boiling water and withdrawn at stated intervals. The contents of the tubes were then introduced into agar, which was incubated at 37 deg. C.; and great care was taken to have a suspension of the spores by filtering them through a glass wool.

The results were: With a temperature of 98 deg. C. (about the boiling point in this locality), spores from a seven days old culture on agar were killed in two and three-quarter hours; and spores from agar nine days old were killed in three hours.

Another experiment was made to determine the thermal death point in honey. The honey was of two kinds, clover and buckwheat. The former had a specific gravity of 1.042 at 60 deg. C. and contained 0.057 per cent. of formic acid, while the latter had a specific gravity of 1.040 at 60 deg. C. and contained 0.170 per cent. of formic acid. The spores used were from agar three weeks old, and three methods were followed:—

1. Silk threads with dry spores thereon. 2. Test tubes containing honey with a heavy inoculation of spores. 3. Capillary tubes containing a suspension of spores in distilled water. The spores used were not filtered through sterile glass wool, as it seemed desirable to imitate as far as possible the con-

(41) American Bee Journal, 1891, p. 470

(42) Manual of Bacteriology, New York, 1893, p. 478.

ditions met with in infected honey. The following are the results:—

1. *Silk threads with dried spores, from an agar culture two weeks old.*

Time.	Temperature. Deg. C.	Result.
15 minutes .....	115	... growth.
30 " .....	113	... "
45 " .....	115	... "
60 " .....	113	... "
1 hour 15 minutes	114	... "
1 " 30 "	115	... "
1 " 45 "	115	... "
2 hours .....	114	... "
2 " 15 minutes	116	... "
2 " 30 "	115	... "
2 " 46 "	115	... no growth.

2. *Tubes containing honey and spores mixed together.*

30 minutes .....	115	... growth.
45 " .....	114	... "
60 " .....	114	... "
1 hour 15 minutes	114	... "
1 " 30 "	114	... "
1 " 45 "	115	... "
2 hours .....	115	... growth.
2 " 15 minutes	116	... "
2 " 30 "	115	... no growth.
2 " 45 "	115	... "

3. *Capillary tubes with spores in distilled water.*

30 minutes .....	114	... growth.
1 hour .....	114	... "
1 hour 30 minutes	114	... "
2 hours .....	114	... "
2 hours 15 minutes	115	... "
2 " 30 "	115	... "
2 " 45 "	115	... no growth.

The temperatures were taken in a large vessel containing 10 lb. of boiling honey. The experiment was repeated, using buckwheat honey instead of clover, and with like results.

*Relation to Light.*—A few experiments were made to ascertain the behaviour of spores towards light. Cover glasses, spread with spores and dried, were exposed to bright sunlight during the month of February. The exposure was in the open air and the glasses were on black tile. The temperature varied from 12 deg. C. to 22 deg. C. After exposure, the glasses were placed film side downwards on agar plates, and then incubated at 37 deg. C.

*Results.*—3 hours' sunlight; abundant growth in sixteen hours.

6 hours' sunlight; abundant growth in sixteen hours.

9 hours' sunlight; abundant growth in sixteen hours.

These experiments were repeated in September, when the outside temperature varied from 24 deg. C. to 30 deg. C., with the result that there was growth after four, six, and seven hours' exposure.

Agar plates exposed after inoculation showed great differences. For instance, spores twenty-one days old were killed by five hours' exposure, whilst plates made the day after with spores two months and twenty-one days

old, required seven hours' exposure. Spores ten days old showed no growth after five hours' exposure; and spores five days old no growth after six hours' exposure. From a large number of determinations, the average length of exposure necessary to kill spores within the above range of temperature was found to be five hours.

*Vitality on Various Media.*—The cultures seen to live longer on agar than in liquid media. The vitality of old gelatine and bouillon cultures seems to be lessened by the products of the bacilli growing in these media. The spores taken from these sources have also decreased resisting power.

*Effect of Growth on Reaction of Media.*—Ordinary bouillon becomes slightly more alkaline as growth proceeds, the presence of ammonia being detected by Nessler's reagent; but control bouillon does not give the reaction. In bouillon, with the addition of glycerine and various sugars, the acidity of the media is increased, but more in the case of glucose broth than in any other. In these experiments accurate titration was made with phenolphthalein as indicator. Cheyne tried the reaction, "making the infusions faintly alkaline, and after the growth of this organism in it, it is faintly alkaline."

*Sensitiveness to Antiseptics and Germicides.*—This subject is taken up in connection with the chemical remedies used for the disease.

*Pathogenesis.*—Besides being pathogenic to the larvæ of bees, Cheyne has inoculated two mice and one rabbit with spore-bearing cultivations without effect. "Half a syringeful of a spore-bearing cultivation injected into the dorsal subcutaneous tissue of each of two mice resulted in the death of one of them in twenty-three hours, while the other seemed unaffected. In the case of the mouse which died, the seat of injection and the neighbouring cellular tissue was found to be very œdematous; but no microscopic changes were apparent in the internal organs. Numerous bacilli were found in the œdematous liquid, as also a number of spores which had sprouted; and there were likewise a few bacilli in the blood taken from the heart. This was proved by cultivation as well as by microscopic examination. On examining sections of various organs no morbid changes were found, and only a few bacilli were seen in the blood-vessels. A syringeful of the same culture was injected into a guinea-pig, and the animal died six days later, with extensive necrosis of the muscular tissue and skin; and cheesy-looking patches were distributed through it, but there was no true pus. On making sections of the necrosed tissue, numerous bacilli, apparently *B. alvei*, were seen; but there were also other bacilli and micrococci. No micro-organisms were seen in the internal organs. It thus remains questionable whether the necrosis was due to *B. alvei* or not, more especially as I have since injected three guinea-pigs subcutaneously with spore-bearing cultivation, but without effect.

"The effect of feeding flies with material containing spores results in death of the flies, and bacilli were found in its juices as shown by the microscopic examination and cultivation. Cockroaches were not killed" (28).

Fly-blow larvæ fed for three days on spores were not killed. With regard to the prevalence of the disease amongst wild bees, very little can be found on this subject in bee literature, but a correspondent of the BRITISH BEE JOURNAL (43) found the disease among wild bee larvæ in a tree, recognising it by the smell from the entrance and also from the appearance of the brood in the combs. The correspondent remarks that this tree had probably in former years been the cause of a great deal of trouble to neighbouring bee-keepers. In all probability the disease is present among the various varieties of wild bees and wasps. Knight (54) mentions an epidemic among wasps in 1807; Kirby and Spence (55) another in 1815; and Bevan (13) one in 1824; but in none of these cases was any positive evidence given to show the epidemic was foul brood.

(To be continued.)

## Correspondence.

*The Editors do not hold themselves responsible for the opinions expressed by correspondents. No notice will be taken of anonymous communications, and correspondents are requested to write on one side of the paper only and give their real names and addresses, not necessarily for publication, but as a guarantee of good faith. Illustrations should be drawn on separate pieces of paper. We do not undertake to return rejected communications.*

### HOW TO SECURE STRONG COLONIES.

[5036.] Another year's experience has proved to me more clearly than ever the truth of what I wrote on this subject in your pages about a year ago. That the secret of having our bees strong at the *right* time depends more upon the condition of the queen than upon any other one thing connected with bee-keeping. The reason why some colonies in an apiary outstrip others is because (providing all have equal treatment) the queens in the strong colonies are hardy, vigorous, and prolific; they are capable of depositing 3,000 or 4,000 eggs every day for a month previous to the honey-harvest, and until we bee-keepers realise the vast importance of every colony of bees possessing such queens, we shall not obtain the utmost amount of surplus we ought to secure from every colony in the apiary.

But if we wish to get the best results there must also be good management. By this I do not mean a lot of needless opening of the hives and examining them, just to see how they are going on—the less bees are interfered with the better. Each time a hive is opened make a thorough examination, and carefully make a note of their condition, and so avoid

any further needless disturbance for a time. To my own mind, the secret of successful management in bee-keeping, as in anything else, depends upon doing the right thing at the right time—just when it wants doing. To know when to do a certain thing, and the best way, requires good judgment, the result of experience and careful observation. It is certainly not obvious to me how the use of a larger frame than the "Standard" has any advantage in ensuring strong colonies.

Do I rightly understand your correspondent, "J. M. U." (5034, page 56), to advise the dividing of strong stocks, in anticipation of their swarming, to secure the best results? I should not expect to get any surplus by the adoption of this plan. I should rather take the bees and brood from the "weaklings," and make the strong even stronger. If my experience proves anything, it is the wisdom of concentrating our forces just before the honey-flow, that is the time to add bees and brood; and, if increase is desired, divide immediately after the honey harvest, giving a young prolific queen with two or three frame nuclei to each half, when, with gently feeding for a few weeks, they will generally be in good condition for wintering.

It does not by any means follow because a colony is very strong in the autumn, or even early spring, that they will continue to be the best; frequently the reverse is the case. An apparently weak colony in the spring, containing three or four frames of young bees, and headed by a prolific queen, will often outstrip their more populous neighbour of a month or two ago; and why, because in the one case the queen had exhausted herself by the labours of egg-producing the previous season, and the bees and owner have neglected to provide a vigorous successor at the right time. Many bee-keepers do not think of re-queening until a colony becomes weak, and I have heard it asserted by some so-called authorities that the bees will re-queen themselves better than if interfered with by man. That they will sometimes supersede their old queen I do not deny, and perhaps oftener than we imagine, but we cannot rely upon their doing so at the right time, viz., at the end of the honey harvest. When bees are allowed to re-queen on the let-alone plan it frequently happens that the old queen fails early in the season, just when she ought to be laying her very best, consequently that stock gathers but little or no surplus that year. At the risk of repetition, I must state that no one can expect strong colonies who fails to see that each is provided with a tested prolific young queen early in the autumn—the earlier the better—and let all young bees be hatched and take a few good flights before the approach of cold weather. If this were always done I venture to say we should hear less of spring dwindling, and consequently weak colonies.—J. G., Barwell, Hinckley, February 7.

(Correspondence continued on page 66.)

### HOMES OF THE HONEY BEE.

THE APIARIES OF OUR READERS.

In Mr. Harris we have one more of that useful class of gardeners who are successful bee-keepers. There are, unfortunately, too many gardeners who have a dislike to bees, and take no pains to conceal it. Not only so, but many try to prejudice their employers against bee-keeping, and thus, maybe, cause the loss of influential assistance to County Associations, where a directly opposite result might be reached with the help of a gardener who is a bee-man. Mr. Harris' notes speak for themselves in pointing the "moral" we would enforce.

"My first experience of bee-keeping occurred some five years ago. I was working in the gardens of Weald Hall at the time when a

that I shall not readily forget. The swarm took possession of a big hole in the trunk of an old walnut tree. There was a starlings' nest containing young birds in the tree at the time, and I had to get the bees out in handfuls. It was a very tough job, and during the operation I had about seventy-five stings in my hands and arms. However, I managed to secure the swarm, and moreover I hardly felt any ill effects from the stings.

"The success of this exploit brought me another offer of a stock of bees if I cared to take them away. These were at Park Farm, Doddinghurst, and I not only secured the bees and combs, but they wintered well, and I took two first prizes, one second, and a first-class certificate at Romford with produce from them last year.



MR. JOHN HARRIS' APIARY, KELVEDON COMMON, BRENTWOOD, ESSEX.

stray swarm settled near the lawn close to which I was engaged with my work. Not having bee appliances about the place, I got an old box and hived the swarm in it. I then asked the squire, my employer, if he cared to keep the swarm, but he told me to take the bees myself and do well by them. Very pleased with my luck, I got the bees home. This happened in July, but I left them in the box till September, at which time a lady made me a present of a frame-hive, into which I drove the bees, and with care and attention they did well the following year.

"As I have said, this happened about five years ago, and I have since increased my apiary to twenty-four colonies. During my second year's bee-keeping I had an experience in taking a stray swarm of bees from a tree

"In 1901 I took another stock of bees from the roof of an inn at Kelvedon Common, where they had been located for twenty-two years. This time I took 75 lb. of honey from the roof, which was handed over to the occupiers, while I got the bees for myself, and this lot also did well, and I took several prizes with their produce. I also removed a stock from Pump Farm, Kelvedon, along with 84 lb. of honey. This lot had been in the roof for sixteen years.

"With regard to my experience in honey-production and marketing the produce, I may say my wife takes an equal interest in the bees with myself, and she can hive swarms if I happen not to be at hand. We have a good sale both for sections and extracted honey. All badly-filled sections are sorted out, and

honey extracted from them. The well-filled sections have a good sale; indeed, I never have any left on hand, and I could now sell more if I had them.

"My good wife does all the extracting and jarring of the liquid honey. She also keeps a watchful eye on the hives during swarming time, so that we have no runaway swarms. In this way she is my "better half," for my work as gardener takes me a mile away from home.

"Last winter I made two frame-hives myself. I also made a hive-stand, and on this fixed up a novel outer-case for a hive from an oak grape-barrel. The hive was placed within the barrel and packed all round very snug with cork-dust, and I then covered the outside of the barrel with virgin cork. It makes a nice hive and has been much admired by all who have seen it.

"I pack my frame-hives in autumn with chaff and put each of my skeps in a box, then fill the vacant spaces with chaff and make loose chaff-pillows for the top. I find this plan keeps the bees warm all winter. The pillows also help to keep supers warm in the working season.

"In early summer I always take care to have drinking troughs near the hives: these are old soup plates partly filled with small stones, and when kept supplied with clean water it keeps the bees from visiting ditches where the water is less clean. This assists in keeping the bees healthy when they need so much water in spring.

"Last year I had six swarms, of which I sold two. My swarms are united to weak stocks, so that I may make the latter strong and thus able to resist 'robbing.'

"If readers can gain some little help from my experience I am amply repaid for writing it."

### CORRESPONDENCE.

(Continued from page 64.)

#### A NOTE FROM MID-SHROPSHIRE.

[5037.] Your correspondent Mr. Phil Jones has written concerning the doings of the bees in the south of our county (5016, page 36). It may interest some of your readers to know how things went in the centre of Salop. I think we have done quite as well as most bee-keepers, and much better than some did in 1902. In common with others, the season was short, but there was no mistake about the quantity and quality so long as it lasted. I cannot profess to know what might have happened under favourable circumstances, but for all the season was so short, several hives had on three and four crates, chiefly shallow-frames, all splendidly sealed. Most of the bees were crowded on twelve "Standard" frames as brood-nest when the flow came, or else ten "Standards" and ten shallows above for breeding; and once again I experienced that the larger brood-nest gave the larger surplus. Most of the largest bee-keepers in Shropshire say that ten "Standard" frames

are not sufficient to keep their queens going. Phil Jones told us this in the BEE JOURNAL two weeks ago, and he has said so more than once, that his best results are always from the larger brood-nest. I think that a cramped brood-nest has a lot to do with second, third, and fourth rate comb-honey. Anyhow, I cannot help thinking that much of my own success last year was due to the fact that for some weeks previous to the flow the queens had had the run of twelve "Standard" frames. I did not work much for comb-honey. The previous year I worked largely 5-in. sections. They were a big success with me, but last year the sections were practically excluded from the show-bench, so I did not put on so many. Those I did put on were splendidly finished. I am bound to say "I like it." The bees work them well, they look well, and sell well, and yet the tall section is doomed, and that through no fault of its own. But for two reasons—1. It only has one chance to ten for 4½ on the show bench. 2. Bee-keepers are very slow to adopt anything new, and therefore will not produce it. At Shrewsbury there were only two exhibitors who entered tall sections, and of course we cannot expect show committees to insert classes where there is such a poor response in entries. I may say that at the above show we had a grand lot of honey, both comb and extracted. We had also the pleasure of the company of our esteemed Editor, Mr. W. Broughton Carr, who acted in the capacity of judge. Personally, I was pleased to receive several awards at his hands, including British Bee-keepers' silver medal for twenty-four 4½ × 4½ sections, and yet in the midst of our plenty I could but feel for those really "good and practical" bee-men farther north, from whom I held letters saying they had not one ounce of surplus. Once again, I say, Shropshire has much to be grateful for. Leaving last year and coming to 1903, there are signs of early flowers. I see to-day crocuses, wall-flowers, and whiterock. May it prove a good year for all, and may those friends who shared so badly last year have more than a double share as a reward for their resignation and patience.—JAS. CLAY, February 7.

#### HONEY IMPORTS.

[5038] Your correspondent, "Querist" (5031, page 48), asks whether the total value (£27,116) of the honey imported during the year 1902, as published in the B.B.J., represents the wholesale or the retail value. As an old reader of the BEE JOURNAL, I have always understood that the sums quoted in B.B.J., monthly, as the value of honey imports were the wholesale value in bulk. When making inquiries upon this subject a few years ago I found that a good deal of this imported honey is sold by auction at the place of landing, and that the prices obtained for it by the ton were anywhere between 2d. and 3d. per lb.

On the other hand, the price at which imported honey sells retail is about the same as the retail price of second-grade British honey, or from 6d. to 8d. per lb. A rough estimate may therefore be arrived at of the retail value of £27,116 worth of honey referred to above.

The most noticeable thing about this imported honey is the attractive way in which it is placed on our markets. Indeed, the nice way in which it is placed before consumers might be a useful object-lesson to many of our British bee-keepers. As imported honey often looks far better than it really is, new consumers of honey are deceived. But it is pleasing to know that those who use honey regularly fully appreciate the superior quality of good British honey. Only last week I received an order from one of my customers, and being sold out, I had to buy in order to supply him. The honey was fairly good in a general sense, but for one who seeks a first-class article the flavour had been spoilt by bad handling on the part of the bee-keeper. My customer complained that the honey was not equal to my usual quality, and, of course, an explanation followed.

I recently had some communication with one of the largest manufacturing chemists in this country, who stocks as much as sixty or seventy tons of honey at a time, and he tells me that the honey used in his business is "mostly Colonial." "This," he adds, "answers our purpose, and is cheaper than British honey." The point that our bee-keepers should bear in mind is that the persons whose custom we seek appreciate the high quality of the best British honey for table use. It is possible that foreign or Colonial honey may be more useful for some special purposes even than fine grade British, as some imported honey is strongly flavoured from various wild trees and herbs, as is some of our honey gathered near the end of the season.

*Adulterated Sugar.*—To show what is going on in the dry sugar line, I am sending the Editors a cutting from a London weekly newspaper of recent date, recording the fact that three London grocers were convicted and fined the other day for selling adulterated sugar. This adulteration took a form that has been known for some time, viz, colouring common white sugar-crystals with an organic dye to represent "Demerara" sugar. To this I would add a word on another stuff that cannot but be injurious to both bees and bee-keepers. Our Editors dealt very fully with a subject of great importance to bee-keepers in the B.B.J. of January 8 and 15. I refer to the "Liquid Fruit Sugar" of Dr. Follenius. The results likely to follow upon the use of this substance in an apiary are clear enough. I think we may regard this stuff as "a wolf in sheep's clothing."

Bee-keepers in out-of-the-way places often have difficulty in getting suitable sugar for

bee-food. The village shopkeeper sometimes deals in genuine cane sugar, but it is unrefined, and quite unsuitable for bee-food. Where trouble arises in this way two or more bee-keepers should combine and get the genuine article, to the advantage of all concerned. It is not only important to use the best materials, but it is equally important that the food be properly prepared, or the advantage may be lost. It should also be borne in mind that it is sometimes possible to prepare better bee-food made from sugar than the natural food gathered by the bees. I refer to honey gathered from mustard and the like, which often granulates so quickly that it is unsuitable for food for bees in winter.—*W. LOVEDAY, Hatfield Heath, Harlow, Essex, February 5.*

## SHOWING HONEY.

### GIVING BEGINNERS "A CHANCE."

[5039.] I have read with much interest what has been said in your valuable B.B.J. on the question of showing honey. I am a novice at exhibiting, and during last season I made twenty-three entries in all, at eight shows, and my total awards were one 1st, six 2nd, four 3rd, and two "h.c." The prize money amounted to £3 3s. 6d., with bronze medal of the B.B.K.A., value 7s. 6d., making a total value of £3 11s. Against this my outlay in entry-fees and expenses sending honey to shows amounted to £2 5s. 8½d., leaving a balance of £1 5s. 3½d.

I also noticed some time ago that a well-known exhibitor quoted one instance in your pages in which he tried to prove that prize-winning meant loss to him. But he omitted to mention the upwards of thirty prizes he has been awarded at shows during the season of 1902. I have no wish to find fault with the rules of our big shows, not having had sufficient experience, but I attended most of the important shows held during the last two years, and, as a result, I should much like to see one improvement in prize schedules, viz, classes for novices who have never gained a first prize at the said show or shows. It would give the enthusiastic beginner "a chance." I have often heard my own bee-friends say, "What's the use of making entries and going to trouble and expense to stage an exhibit at the big shows? \*\*\*\* is sure to take the prize." We hear the same remark at all our big shows, and its truth is proved, for the same well-known names are always to the front, and they are mostly dealers in honey.

There is another point I wish to make a remark on with regard to the recent change of "grouping" counties. I am a member of two County Associations, and my bees are located in both! As the two counties are in two different groups, I therefore ask: Which group am I entitled to show with, or can

I exhibit in both groups?—A NOVICE IN EXHIBITING.

[Without speaking officially, we may say it is obviously open for a member of two County Associations to consider himself entitled to show his produce in the county group in which it is respectively gathered.—EDS.]

### SECTION-RACK AND SHALLOW-FRAME BOX.

[5040.] Referring to the respective queries of your correspondent "J. R." (3017, page 40, and 3027, page 59), I enclose sketches of a combined "W.B.C." section-rack and shallow-frame box, which may supply the solution he



Fig. 1.

requires:—A (Fig. 1) shows a partial section and end view of box containing shallow-frames. B (Fig. 2) is a section and end view of three of these boxes tiered, showing the "fit"

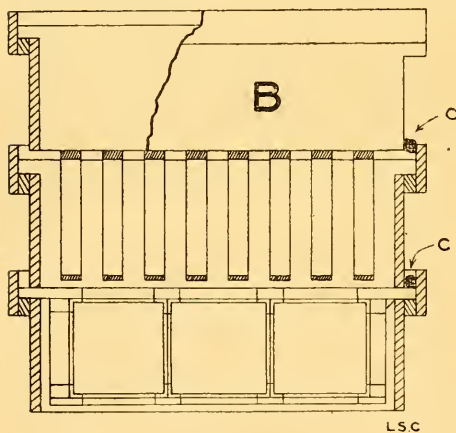

Fig. 2.

when containing either frames or sections. It will be noted that the shallow-frames run in the opposite direction to the section frames.

The objections to a telescope rack of this description would seem to be propolisation and cost. To prevent the former from making these boxes inseparable, sufficient room is shown around the boxes to permit of their being easily twisted apart.

The border-room being the same all round, with frames of the same length of top-bar, a cord—preferably soaked in some soft wax—is to be used as packing, the space allowing this to "tuck in" to place. This cord is shown in section at C. C.

The cost, without frames, would be slightly

more than an ordinary shallow-frame box, but if one of our big appliance-makers found a demand for a double-purpose box of this kind, the difference need not be more than a few pence.

The arrangement shown is free from the objection to two sizes of "W.B.C." frames, as mentioned in your reply on page 59.—L. S. CRAWSHAW, *Ilkley, February 9.*

### CONFINING BEES AT SHOWS.

[5041.] I do not often feel constrained to trouble your columns, but I must express my great pleasure in seeing scientific and practical bee-keepers like Dr. Hamlyn-Harris and Mr. W. Woodley putting in a timely word for the unhappy bees seen in the "prison-house" at our shows. What possible good, I ask, can result from exhibiting confined bees? Some will say it rouses up the curious sightseers with a view of inducing them to take an interest in bee-keeping (I call it bee-killing), and thus extend the business. But if men cannot be incited to take up the hobby without having to inflict unnecessary cruelty on the bees, then let us have fewer bee-keepers, with some amount of humanity and common-sense.

Whilst on this subject, I might also ask, To what use, for what purpose, and for what good is "bee-driving" at exhibitions? I cannot make out what good it does. Is it done for the same reason as showing bees suffocating in glass houses?

It is very discomfoting to any one having a spark of feeling to see bees after being "driven," some flying off, others clinging to the tent netting. Homeless! Lost!

I was under the impression that modern bee-keepers were taught that the frame-hive system is the best to adopt; therefore, why the perpetual bee-driving "at shows"? Of course, it may be useful to know how to drive bees, but why should it be the chief attraction at so many bee-demonstrations at the expense of suffering and loss of many bees?

Referring to the question put to you *re* "Honey Imports," by "Querist," on page 48, may I say: Exporters and importers of produce have to declare to the shipowner or agent the quantity and value of the goods. This is "manifested" and supplied to the Government. The quantity of honey imported could possibly be obtained in conjunction with the value. Then the rate per lb. could be ascertained. As to the "value" declared by exporters, there is no fixed rule adopted in giving the value, although the practice among many is to give the f.c. or "first cost" value. Anyway, if the quantity imported was given along with the value it would be instructing.

The monthly import and export statistics, published for the Government in *Trade and Navigation*, do not enumerate honey separately, but this must be included in "unenumerated." One would think that when



such articles as glucose and flowers are given, that a column would be given for honey. It must be too small an item.—W. B. WEST.

### GLEANINGS FROM FOREIGN BEE JOURNALS.

BY R. HAMLYN-HARRIS, D.S.C., F.E.S., F.R.M.S., F.Z.S., ETC.

*L'Apiculture.—Bees in the French Colonies, Madagascar.*—In parts where but little honey is yielded, the natives do not trouble to collect the wax; elsewhere they collect it, but do not know how to prepare it, while in some provinces the wax is of good quality. That taken from the hives is of a fine yellow colour, but that from wild nests is of a brownish-green, full of impurities. Prices vary from 8d. to 2s. 6d. a kilo. (2 lb.).

Wax is exported from Tamatave, packed generally in bags plaited either of rush or rafia grass; 29,229 kilo. were exported in the first six months of 1899. This mostly to the French ports, as well as to Hamburg and London.

*Mayotte.*—Here there are three varieties of bees; one inhabits the trunks of trees, another hangs its nest from their branches, the third may choose either of these habits. The two first are easily domesticated. The native hives are boxes or hollow tree trunks; but of these there are but few, and the yield of honey and wax from them is small. The honey taken from the wild bees is either of a bright red or yellow colour. To procure it the natives smoke out the bees. Honey and wax are used on the island, but none exported.

*La Réunion.*—The bee most often met with in this island is *Apis unicolor*, but *A. ligustica* and *A. mellifica*, with hybrids of the various races, are also found. The hives are mostly hollow trunks or boxes, from 3 ft. to 4 ft. 6 in. in length. Latterly the bar-frame hive has been introduced, but there are but few of these as yet. To people a hive, the natives take a wild queen, with combs of honey and brood, and place her in the hive. The flora is rich and varied, and the honey often white and transparent. The greenish honey extracted by the bees from the plant *Weinmannia tinctora* is, however, especially fine. Maize yields an agreeable honey, but very dark in colour.

In the French Sudan a black bee is found, smaller than the European variety. These bees live in parts of the forests near villages or running water. The desert character of other parts prevents their settling down elsewhere. The natives make round straw hives, which they suspend from the trees, for safety from robbers and bush fires. The honey is liquid, and brown in colour. It is all consumed locally. The wax is sometimes white or yellow, but more often brown.

*Bienenwirtschaftliches Centrablatt* — In Switzerland, where the bee-keepers are very

careful what queens they rear, the experiment has been made of sending combs with eggs, to enable them to rear reliable queens.

*The Same.—Influence of the Wind on the Honey Harvest.*—It has been supposed that the direction of the wind greatly affected the amount of honey gathered. This does not, however, seem true in all climates or with all plants. The westerly wind did not prevent an abundant yield from sloe bushes, and one hive weighed its highest by a north-east wind.

*Revue Internationale d'Apiculture.*—At St. Paul-Lacoste (Gard). Last summer some persons tried to take the honey of an apiary in this neighbourhood. The thieves placed a sulphur match at the entrance and suffocated the bees; they then took the honey, which they placed in two buckets. They forgot, however, that the bees were not all in the hive. Those which had been gathering honey in returning home to find such a desolation, began to make a great fuss, which attracted the inhabitants of other hives, and in a moment the thieves were surrounded by a multitude of furious insects. They were compelled to take to flight, and abandoned not only their spoil, but also the buckets and other things, which it is hoped may lead to their identification.

*The Same.*—An old horse, who had been nearly useless from rheumatism, was left near a garden during breakfast time in the month of July. Suddenly a considerable noise attracted our attention; the bees of the neighbouring apiary were attacking the poor horse, which was vainly contending against them. After we had delivered him from his assailants he recovered easily from the stings, and since that time he has been completely cured of his rheumatism.

## Queries and Replies.

[3029.] *Queen and Fertile Workers in Same Hive.*—At the beginning of May, 1902, in one of my hives the bees requeened themselves, but, owing to bad weather, the young queen was a long time in mating and starting to lay. I saw the bees cast the old queen out and was sorry, for the previous season she headed the largest swarm I have ever seen. I was also fortunate to see the young queen leave the hive on a mating trip; the sun was shining brightly, but there was a strong wind blowing which caused her to return at once and re-enter the hive. When at last she began to lay I found out the hive also contained a laying worker, as some of the cells had in them more than one egg which developed into undersized drones, which were raised in worker-cells in patches of from six to twelve. These were cast out before they had fully developed, and this continued throughout the summer. After I had fed the stock up in September I examined the hive and found three combs a mass of worker

brood, but there was no reappearance of the small drones; therefore, I thought the trouble was over, and I packed them up for winter. They were in good condition as regards bees and food, but on Sunday, January 25, I noticed they were casting out drone larvæ, and this week they are doing the same with small drones as before. (I enclose a few for your inspection.) What I would like to know is—1. Why do they tolerate this laying worker? and (2) how is the latter distinguished from the other workers in the hive?—C. Y., *Dunham Massey, Cheshire, February 9.*

REPLY.—1. The reason why bees, at times, do certain uncommon things is beyond human ken; the only certainty in your case is that the laying worker will be got rid of ere long without any effort on your part. 2. There are no visible means of picking out a laying worker from the ordinary bees.

[3030.] *Transferring Bees.*—Many thanks for answer to my inquiry on transferring (3026, page 58), JOURNAL, February 5. May I venture to ask you one more question on the matter? Providing we have a fairly good bee-season this summer, I shall be able to take two frames from brood-chamber of each hive (surplus). This will mean ten surplus frames of honey. Could I drive the bees out of "box" mentioned, and also from frame-hive, and put them on these surplus frames in a clean hive? If so, I would put five frames in each of two hives, and drive the bees from frame-hive in one, and drive from box in the other. I do not like keeping the bees in the old bar-frame hive, and also box, another winter. My wish is to give them a good, clean, warm home.—L., *Bideford, N. Devon, February 9.*

REPLY.—You could do as proposed, but as the simplest and best plan to follow with regard to the "box," we should—after subduing the bees—prise off all or part of the bottom, and set it above the top-bars of frame-hive, and allow the bees to transfer themselves below. Then allow the "box" to remain on as a super, for removal as surplus honey at end of harvest. The frame-hive would probably yield a better result by being dealt with in the same manner as the "box," viz., preparing your new hive with frames fitted with full sheets of foundation, and setting the cross-built combs (now in brood-nest of old frame-hive) above the new one in April. By so doing, no brood would be sacrificed, no time lost in brood-rearing, and the old combs would be filled with honey for removal as surplus at end of season.

[3031.] *Keeping Bees near London.*—I have become greatly interested in bees of late, and should like your opinion whether it would be worth my while to go in for one or two hives of bees in the suburbs of London. I do not expect to make any profit, but should like to be successful with them. The only uncertainty in my mind is whether they would

be able to get enough fodder. The district is fairly open, and there are allotments close by.—LAX, *Kensal-rise, W.*

REPLY.—Not being personally familiar with Kensal-rise, we cannot say anything of its bee-forage; and not much value can be attached to allotment gardens for honey plants. Perhaps some readers who know the place may give their views of it for bee-keeping.

## Echoes from the Hives.

*Hatfield Heath, Harlow, February 9.*—Until to-day my bees had not had a good cleansing flight for two months. Now they are having a regular "outing," and pollen is being carried into nearly all the hives. The pollen is apparently from the snowdrop and from hazel catkins. I had occasion to take a quiet look into one of my hives on a mild day six weeks ago, and found then a centre comb nicely filled with brood. I have since noticed bees from other hives fetching water. To the experienced bee-keeper and the novice alike the sight of the first pollen carrying always gives pleasure.—W. LOVEDAY.

*Ashley Apiaries, Newmarket, February 9.*—A grand day; temperature—in the shade at 2 p.m., 53 deg. Fahr.; in the sun, 64 deg. The bees, turning out in their thousands, have enjoyed the first really good cleansing flight since they were packed down for winter. All stocks not obviously weak have started breeding in good earnest. The water troughs to-day are thronged, and early croci, winter aconites, and snowdrops are being diligently worked for pollen.—C. H. B.

## Notices to Correspondents & Inquirers.

All queries forwarded will be attended to, and those only of personal interest will be answered in this column.

\* \* *Expert Help Wanted.*—Referring to Query No. 3026, page 58, Mr. John Brown, Polyphant, Launceston, Expert of the Cornwall B.K.A., writes us to say:—"The Devon Association has allocated the Bideford District to me; therefore your correspondent had better take advantage of my tour and visit to that town. I shall commence in the last week of April next and finish on May 4. This being so, 'L., Bideford,' had better keep a look-out at the time, or communicate with me by post."

J. N. (Doddington).—*Honey Samples.*—The sample sent is of good quality, and might bring the price you name at present rates for good honey. We will put sample before a dealer if a chance offers.

H. J. P. (Colchester).—*How Frames should Hang in Hives.*—This is a moot point among bee-keepers, but we think a large majority agree with ourselves that the most suitable way is at right angles to entrance.

## Editorial, Notices, &c.

### THE "ROYAL" SHOW OF 1903.

#### THE GROUPING OF COUNTY ASSOCIATIONS.

On page iii. of our advertisement columns this week appears the full prize list for the bee-keeping section of the sixty-fourth annual exhibition of the Royal Agricultural Society of England. The announcement is notable as being the first exhibition held in the permanent show-yard of the Society near London, and also as initiating a new departure in connection with the prizes offered for honey.

For many years past it has been the rule for the B.B.K.A. to offer three prizes in each of ten classes for honey, all of which were open to the bee-keepers of the United Kingdom. In this way an exhibitor, wherever located, within the given limit, by making a single entry in each class—or ten in all—could compete for thirty prizes, and had the bee-men of the whole kingdom to contend with; but under the new rule of grouping the counties, and allocating one class to Wales and one to Scotland, the individual exhibitor by making four single entries—*i.e.*, one in each class—competes for twelve prizes with only competitors from his own particular "group" of counties to contend against.

It will thus be seen that a long-felt grievance is removed, and those upon whom this grievance pressed not hardly will, we hope, appreciate the change. It is a well-meant effort to meet the expressed wishes of the county representatives who, at the recent conference, emphasised the fact that certain counties where the bee-forage yielded only medium coloured honey had no chance—on the show bench—against districts where only light-coloured honey is produced. In effect, then, the change is simply an extension of the principle of "grading honey" by means of separate classes introduced a few years ago.

But the fact must not be overlooked that the change involves a serious extending of the prize list, and a corresponding increase in the already heavy burden on the finances of the B.B.K.A., and it is, we trust, not too much to hope that the increase in entries will in some measure recoup the parent association for the extra outlay, an outlay borne entirely in the best interests of its affiliated associations. It needs only a glance at the prize list to show how the new rules work out; especially with regard to doing away with the need of staging only honey of the current year. Henceforward it is "honey of any year."

It may, therefore, be safely left to the Executive Committeemen of the respective associations to rouse up their number in order to make the next "Royal" Show a memorable one for the industry.

### FOUL BROOD OF BEES.

By F. C. Harrison, Professor of Bacteriology.

(Continued from page 64.)

#### ECONOMIC ASPECTS.

*Losses.*—Della Rocca (loc. cit.) in 1790 stated that the whole of the bees in the Island of Syra were carried away during 1777 to 1780 by the disease. Dzierzon (46) relates his losses from the disease. In 1868 he lost his entire apiary of 500 colonies from it. In Switzerland the disease, at times, is extremely bad. Bertrand's apiaries have suffered severely, and the German papers make constant reference to its devastation. In England, Cowan (4) thinks that the "only visible hindrance to the rapid expansion of the bee industry is the prevalence of this pestilential disease, which is so rapidly spreading over the country as to make bee-keeping a hazardous occupation;" and again (47), "So rapidly has foul brood spread by contagion that in one season, unless precautions are taken, a whole neighbourhood may become seriously infected, and the chances of successful bee-keeping seriously imperilled, if not utterly destroyed."

The committee on the Bee-keeping Industry and Foul Brood in the United Kingdom report that the destruction of stock by foul brood, and the discouragement arising therefrom, is one of the two influences that retard the development of the bee industry.

In the United States serious harm has been done, but no definite statistics can be cited. The disease causes great losses, and several States have enacted laws for the prevention of the disease, making it a legal offence for a person to keep in his apiary a colony of bees affected with foul brood.

In Canada, the Ontario Foul Brood Inspector (56) reports in the years 1890-1892 inclusive 622 apiaries inspected and 2,395 cases; in the years 1893-1898, 527 apiaries inspected and the disease present in 212, or about 40 per cent.

In New Zealand and Australia the disease is looked upon as being very widespread. It will thus be seen that, wherever bees are kept, serious losses are caused annually by this disease.

*Natural Method of Infection.*—With regard to the natural methods of infection, a good deal depends on the natural predisposition of the bees to disease and the state of health of the colony. Weak, sickly, or badly nourished bees are, as a rule, the most susceptible. We must also remember that germs themselves vary in their ability to produce disease. As in diphtheria, we may get a light or severe type of the disease; so also in foul brood, we may have a light or a severe attack; but the facts demonstrating the variability of this

(44) Foul Brood: Its Cause and Cure, Trenton, N.J., 1895.

(45) Gleanings in Bee Culture, 1896, Vol. xxiv, p. 853.

(46) Bienen Zeitung, Nordlingen, 1860.

(47) British Bee-keepers' Guide Book, London, 14th Edition.

capacity are not well known; I have, however, noticed that after prolonged cultivation of *B. alvei*, in which more than thirty transfers have been made, and the bacteria with spores have been given to bees in syrup, the virulence of the germ has seemed to be considerably impaired. In one case the colony experimented with was rather weak, was confined to the hive all day, and allowed flight only in the evening, and the spores were given in large quantities in syrup every day; nevertheless it was several weeks before the disease established itself, and then only in a light form. So we may have mild or severe epidemics and the liability to take the disease may be increased by chilling the bees, or otherwise unfavourably modifying their metabolism; and in all such cases, they succumb more easily to the disease than when in a normal, healthy condition.

With regard to the manner in which the disease is carried from hive to hive, Cheshire (26) thinks that the larvae are most usually affected by the antennæ of the nurse bees, and also that the tramp of the bees frequently detaches numbers of spores, which fly about in the air and settle here and there, often where they take effect. I think that in comparison with other diseases which are air-borne there is usually not very much danger from this cause in the case of *B. alvei*. The spores are generally found in very sticky surroundings, which, even if dry, serve to fix and keep them *in situ*. Cheshire also states that he has not found the bacillus from honey or pollen in infected hives. This statement, however, is directly contradicted by the experience of practical bee-keepers and others. I have myself repeatedly found *B. alvei* in capped honey cells, and in the pollen masses found in diseased hives, the examination in the former case having been made by removing the capping with sterilised forceps and plunging a heated platinum needle into it and then putting the needle into melted agar, from which plates were poured, cooled and incubated.

Probably the chief method of carrying the disease from one hive to another is by the bees from healthy hives robbing colonies that have become weak and diseased. In such cases the robbers carry with them the germs of the disease. There is likely nothing to be feared from using wax foundation from the regular makers; for, as we have already stated, the wax, in the process of making, is subjected to a temperature sufficiently high to kill any spores that may be present.

I may add that I found spores of *B. alvei* in two samples of wax sent me by R. F. Holtermann, of the *Canadian Bee Journal*, but both samples were from hives which were very badly infected with the disease.

In 1897, about 10 lb. of wax was infected with large numbers of spores grown upon agar. The wax was cut up into small pieces and heated at a low temperature, only just

sufficient to melt it; and as McKenzie (28) had shown that the spores settled to the bottom, the wax was vigorously stirred from the time the spores were added until it had set again. The wax thus infected was sent to Holtermann for foundation-making. He manufactured it by the usual process of melting and gave the foundation made from it to bees, and no foul brood developed in the colony supplied with it during the years 1897 and 1898. The probability is that the spores are fixed in the wax, and are thus unable to infect the bees.

Healthy bees may pick up spores of *B. alvei* from flowers previously visited by diseased bees. Wasps, which are noted robbers, may also carry the disease, and thus infect a locality.

The very large traffic in bees and bee-keeping supplies where agriculture is carried on probably favours the spread of the disease. In fact, many instances are cited in bee journals of infection carried from one locality to another by the importation of bees and bee supplies.

Persons manipulating diseased hives and then examining healthy ones may be the means of spreading the disease. The practice of using a knife for cutting out diseased comb, and then using the same knife for work amongst healthy comb (which I have seen done) is by no means wise, as the spores may thus be transferred from diseased to healthy hives. Cowan (4) observes that beekeepers who have not succeeded with their bees in consequence of foul brood have been known to sell by auction hives in which the bees have died. In such cases the purchasers are usually beginners who have no idea of the danger they are incurring.

*Conditions Favouring the Spread of the Disease.*—Besides the weak or badly-nourished condition in which bees may be, and lack of other hygienic conditions which favours the spread of this disease, great humidity in winter is said to be favourable, and probably great heat is also conducive (45).

*Predisposition of Varieties.*—No definite statements can be made as to the predisposition of various races to this disease. Quinby (49) says that black bees are more subject to foul brood than Italians. Aspinall (51) also affirms that common bees are more liable to the disease than Italians, but De Layens (47) states that Italians are more easily infected than black bees. (See also page 71.)

#### REMEDIES.

Three remedies have been tried:—

1. Stamping out.
2. Starvation.
3. Treatment by chemicals:—(a) By feeding chemicals in food; (b) by putting certain chemical substances into the hive and allowing them to evaporate at the temperature of the hive. This latter method may be regarded as rather preventive than curative.

1. *Stamping-out Method.*—By the stamping-out method all affected bees, combs, and frames are destroyed, and the hives thoroughly disinfected. Cowan (4) thinks that if foul brood were under Government inspection, and all cases promptly dealt with by destruction, the disease could be stamped out. The British Bee-keepers' Association has asked the Board of Agriculture to secure legislation on this line, because it thinks that in this way the trouble would be removed, and the industry would receive an impetus which would benefit bee-keepers, farmers, and fruit growers.

The earliest advocate of this system was Della Rocca (18), who maintained "in extreme cases it was necessary to burn everything without pity, as there was no other resource." Since Della Rocca's time this method has been frequently resorted to in severe cases that would not yield to treatment, either by starvation or by the use of chemicals; but to have any lasting effect it would have to be universally carried out, and would involve the difficult question of compensation.

2. *Starvation Methods.*—The starvation method was first proposed by Schirach (3), who advised that the combs be removed, and bees allowed to fast during two days, and then be placed upon clean new comb, and fed on a syrup prepared with a little hot water mixed with honey, nutmeg, and saffron.

Since Schirach's time different modifications of this method have been made, and it has been largely used in the United States and Canada, whilst in Europe treatment by medicated syrups has been more in vogue. In 1879 L. C. Root (58) gave his approval to this method, but he advised that the bees be confined in a cool, dark place for twenty-four hours in order that all the honey which they carried with them might be consumed, and that the bees be then put into a hive filled with healthy comb or foundation, and the condemned hive scalded with boiling water and thoroughly scraped. At a later date McEvoy (44), the Ontario provincial foul brood inspector, introduced another modification, and has himself described his method as follows:—"In the honey season, when the bees are gathering freely, remove the combs in the evening, and shake the bees into their own hives. Give them frames with comb foundation starters on, and let them build comb for four days. The bees will make the starters into comb during the four days, and store the diseased honey in them which they took with them from the old comb. Then in the evening of the fourth day take out the new combs and give them comb foundation to work out, and then the cure will be complete. By this method of treatment all the diseased honey is removed from the bees before the full sheets of foundation are worked out. All the old foul-brood combs must be burned or made into wax after they are removed from the hives, and all the new combs made out of

the starters during the four days must be burned or made into wax, on account of the diseased honey that would be stored in them.

"All the curing or treating of diseased colonies should be done in the evening, so as not to have any robbing done, or cause any of the bees from the diseased colonies to mix and go with bees of sound colonies. By doing all the work in the evening it gives the bees a chance to settle down nicely before morning, and then there is no confusion or trouble.

"This same method of curing colonies of foul brood can be carried on at any time from May to October, when the bees are not gathering any honey, by feeding plenty of maple syrup in the evenings to take the place of the honey flow.

"It will set the bees robbing, and spread the disease, to work with foul-broody colonies in warm days, when bees are not gathering honey, and for that reason all work must be done in the evenings, when no bees are flying.

"Where the diseased colonies are weak in bees, put the bees in two, three, or four together, so as to get a good-sized swarm to start the cure with, as it does not pay to spend time fussing with little weak colonies.

"When the bees are not gathering honey, any apiary can be cured of foul-brood by removing the diseased combs in the evening, and giving the bees frames with comb-foundation starters on. Then, also, in the evening feed the bees plenty of sugar syrup, and they will draw out the foundation and store the diseased honey which they took with them from the old combs; in the fourth evening remove the new combs made out of the starters and give the bees full sheets of comb foundation and feed plenty of sugar syrup each evening until every colony is in first-class order.

"Make the syrup out of granulated sugar, and put 1 lb. of water to every 2 lb. of sugar, and then bring it to a boil. As previously stated, all the old combs must be burned or made into wax when removed from the hives, and so must all the new combs made during the four days.

"The empty hives that had foul-brood in them do not need any disinfectant in any way. I have handled many hundreds of colonies in the Province of Ontario, and cured them of foul-brood without getting a single hive scalded or disinfected in any way, and these colonies are cured right in the same old hives."

McEvoy positively states that "No colony can be cured of foul-brood by the use of any drug. All the old combs must be removed from every diseased colony and the hive got away from the bees before brood rearing is commenced in the new clean combs."

Howard (40) is most emphatically opposed to the drug treatment. "I regard," says he, "the use of any and all drugs in the treatment of foul-brood as a useless waste of time and material, wholly ineffectual, inviting ruin and total loss of bees. Any method which has not

for its object the entire removal of all infectious material beyond the reach of both bees and brood will prove detrimental and destructive and surely encourage the recurrence of the disease."

A. I. Root (45) says that "The starvation plan in connection with burning the combs and frames and boiling the hives has worked best in treating foul-brood. It never re-appeared after such treatment, though it did in all cases where the hives were not boiled, thus confirming the theory or fact of spores."

These two authors, therefore, go further than McEvoy in both advising the disinfection of the hives.

McEvoy (56), however, admits that his method as described above cannot be used for every case. His reports frequently refer to burned colonies; and he acknowledges that his methods do not always cure. In 1890 he used the expression, "600 cases of foul-brood and over 360 cured"; and again in a subsequent report, after mentioning the number of cases, he added the words, "mostly cured."

In a personal communication, M. Bertrand, of Nyon, Switzerland, states that he does not believe in, and will not recommend in his periodical (*Revue Internationale d'Apiculture*), the starvation method as used in America.

(To be continued.)

---

## Correspondence.

---

*The Editors do not hold themselves responsible for the opinions expressed by correspondents. No notice will be taken of anonymous communications, and correspondents are requested to write on one side of the paper only and give their real names and addresses, not necessarily for publication, but as a guarantee of good faith. Illustrations should be drawn on separate pieces of paper. We do not undertake to return rejected communications.*

---

### NOTES BY THE WAY.

[5042.] We have had over a fortnight of mild weather, but not much sun. But when Old Sol did pour forth his glorious rays over a week ago, the bees came out by tens of thousands, and the spotted condition of the roofs of hives at sunset told how great was the need of a cleansing flight. I had already provided a supply of water in the usual places, and the tea-leaves and floating corks were soon covered with bees. I find when the bees have located the water troughs they rarely go far afield to ponds or brooks. A very large majority of the hives appeared far stronger in bees than I expected, as breeding practically ceased earlier than usual last season, and the consequent loss of late-bred bees usually expected at that period of the year would be apparent now; but the contrary is the case in my own apiary. I received two or three letters last week from widely-distant places, saying that bees had had good cleansing-flights, and possibly your pages may record

others. Anyway, such chances are much to be wished for by the owners of bees.

*Rail Rates per "Goods" for Honey.*—For several years past I have been supplied by the Great Western Railway with books of consignment notes (numbered "2,853," as sample sent) for honey and other goods at company's risk, and about a month back our carrier brought me a supply of consignment notes for honey headed "For goods to be carried at reduced rates at owner's risk." I would not use these notes at first, preferring the consignment note I had been using previously. But our carrier then informed me that the Great Western Railway would not accept the goods unless the last form of consignment notes supplied was used. I at once wrote calling the stationmaster's attention to the fact that, although I had sent honey at "reduced rates at owner's risk," I found the same charges made as when sent at company's risk last year. His reply was, "I beg to inform you that railway companies generally, owing to the liability to damage, have adopted a regulation by which honey in the comb in sections in cases is conveyed at the owner's risk only, the rate remaining the same as heretofore."

This is surely a unique instance of railway companies trying to throttle a small, growing, minor industry. I feel sure that few bee-keepers would object to sending honey at "owner's risk," if conveyed at reduced rate; but to charge the same rate as when the companies take risk of damage is manifestly unfair. I therefore say that we bee-keepers and our Bee-keepers' Associations must be up and doing. Concerted action will, no doubt, obtain fair treatment for us, and it is to be hoped that the B.B.K.A. will tackle this question, and confer with the proper authorities with regard to it. Small consignments of honey per "pass. train" are still sent at reduced rates at "owner's risk." But we want honey carried per goods train at reduced rate if owners are to take all risk of damage during transit. I send copies of respective "Consignment Notes" for editorial inspection.

The late spell of mild weather has started growth in the flower-gardens, and in the woods the buds are bursting. I trust we shall not get a long continuance of abnormal weather, and then a set-back after vegetation has started; if so, our fruit-buds will be at the mercy of the finches and frosts. Food for bees should still be good soft candy or honey. It is too early to give them sugar-syrup.—  
W. WOODLEY, *Beedon, Newbury.*

---

### AMONG THE BEES.

WHAT CONSTITUTES REAL HEATHER HONEY.

[5043.] I recur to this subject because it is of more than mere *personal* interest. I regret that anything written by me should make Mr. Quayle (5028) fancy that I could for a moment conceive it possible to make a comparison—

unless in the way of contrast—between the dreary and uninteresting region of Chat Moss and the ideal “bee paradise” surrounding his lovely Glenmay. Familiar as I am with the works of one who has given this “Pearl of the Deep” an immortal name in the pages of literature, and remembering his vivid description of its fair scenery, his graphic delineation of its picturesque charms, and his idealistic pictures of its many beauties, I could not imagine so disrespectful a comparison being made by the veriest tyro. Then have we not had several contributions to our own papers giving almost ecstatic descriptions of its loveliness? The latest visitor pictures it as “A bee district second to none; a land flowing with milk and honey.” This gentleman, Mr. Leonard S. Crawshaw, was kind enough to send me, some time ago, a sample of Glenmay Erica honey (admittedly, with a slight blend of clover), which I at once classed as “a very good honey on all points,” *i.e.*, viewing it by itself, and on its own merits. One who knows honey well described it as “excellent in many ways, but *not* our Calluna honey.” A very high authority classes it as a “very mild-flavoured heather honey.” Mr. David Raitt, Blairgowrie, writing of Erica honey from Mona’s Isle—but not from Glenmay—says, “The bell heather yields a honey we Scotch people consider *not in it* with the real heather.” As he handles very large quantities of honey yearly, he should know. Mr. Quayle refers us, on page 498, to a verdict given by our Junior Editor in B.B.J. of August 24, 1899. I take no exception to the description of Erica honey there given, but I wholly and utterly disagree with the comparison made with the Scotch product. At the time, on reading the preference expressed, I wondered that heather men did not furnish up their claymores, dirks, and targes and make a raid on the *sanctum* at 17, King William-street! Seriously, however, the opinion prevails in our Northern Kingdom that this sentiment is put in practice, and that an altogether wrong estimate prevails in the South as to what constitutes an ideal sample of true heather honey, and to this cause must be attributed the paucity of Highland heather honey exhibits at the great shows in London. Mr. Broughton Carr very kindly sent me a sample of English heather honey, but, placed alongside of ours, it is not in the running. In a class for heather honey the colour and consistency of Erica should rule it out of court alongside a tolerable sample of that from Calluna, even though in several other points it might show to advantage.

Let me illustrate! We have had a learned discussion going on lately in the London Press on whisky. Without going into technicalities or subdivisions, we have three classes of spirits known to the trade, *viz.*, pure malt, raw grain, and a blend of the two. The first named has certain distinctive features of its own, and, while each “brand”

has its distinguishing point well known to the initiated, this high-class whisky has merits clearly marking it as the best. Many excellent judges, however, I am told show a distinct preference for certain blends, which seem to suit their palates better, and some seasoned toppers set even the raw-grain concoction before any others. Now, supposing a competition of all these kinds, it would be manifestly unfair to assign either of the two last classes first place as the best on exhibition because the taste happened to suit a delicate palate. “Real Glenlivet” is not for a moment to be compared to such a compound as that from potatoes, beet, &c. That would be setting (to take an extreme case) glucose on an equality with pure nectar gathered and manufactured into honey by the bees. I am not sorry that this opportunity has arisen, as we may be enabled by discussion to decide definitely what goes to constitute real heather honey. Heather men should, therefore, come forward and give us their verdict on the question. I am not desirous of having Erica honey decried, and have no desire to say one word derogatory to the merit of any honey whatever; but I am anxious to have our best honey assigned a true position, that its reputation should not be disparaged, and that it should not be made to take a second place when it stands *facile princeps*.

I am surprised at the statement that hive bees neglect Calluna heather for Erica heath at an altitude of from 700 to 1,200 ft. It is so diametrically opposed to all I have hitherto seen, heard, or read, that I should like to learn if the same anomaly has been observed in any particular district on the mainland. When the heather blooms here bees visit no other plant, unless the few who are gathering pollen. Although we have considerable stretches of both kinds of Ericas all over the Highlands, they are but small islands in the midst of an ocean of *Calluna vulgaris*, mere specks dotted here and there on the surface of a vast continent of purple bloom of the true heather.—D. M. M., *Banff*.

#### EXPERTS' VISITS AND FOUL BROOD.

[5044.] In reply to friend “J. R.,” who asks for my views on page 59, I would say that until a law is passed for inspecting all bee-hives, foul brood can hardly be got rid of. There are some bee-keepers who object to a visit from an expert, and would never dream of paying any one to examine their stocks. Still, much can be done by means of association. Some great men think that the twentieth century will be marked by gigantic associations for the furtherance of various objects. Should this be the case, Holderness and its different branches of apiculture will have to wake up or be left hopelessly in the rear. In the meantime, the E.R.B.K.A. will welcome all who value mutual help; our meetings are held on the first Saturday in

each month, at 2.30 p.m., at the Young People's Christian and Literary Institute, George-street, Hull, and we are open to discuss all matters connected with apiculture.

Two other answers may, I think, be given to the question, "Can shallow-frame boxes be adapted for holding sections?" If "W.B.C." frames for  $4\frac{1}{4}$  in. by  $4\frac{1}{4}$  in. sections are used, the simplest and most satisfactory plan would be to reduce the depth of the shallow-frame box by  $\frac{3}{4}$  in.; the bees will not take to the super so readily if there is a thick board between it and the brood nest. Or the boxes could be used to hang the tall sections side by side with shallow frames (see page 66, 2nd col.).—RICHD. M. LAMB, *Burton Pidsea, Hull, February 14.*

### RACK FOR STORE COMBS.

[5045.] The enclosed sketch is of a frame-rack which differs somewhat in the manner of its use from that recently described in a former issue of B.B.J. in that the combs are accessible for examination or removal singly. The sectional sketch, which does not show the whole of the rack, but merely the method of its use, gives two of the tiers of frames, one of

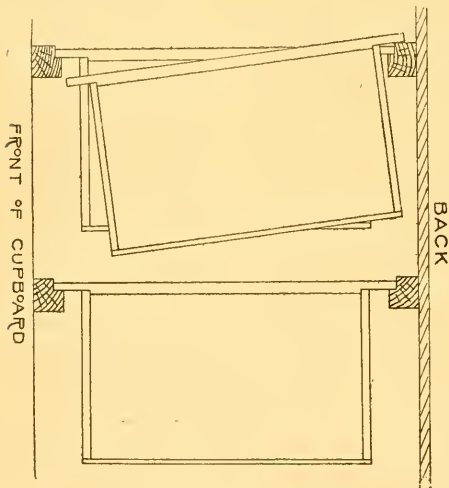

Rack for Store-Combs.

the upper combs being shown in the position of removal.

The *modus operandi* is to raise the back "lug" of the required frame, grasping the end bar, slide the frame backward until the front lug drops clear of the bar, when the frame is pulled forward and out. This is really little more than one motion in practice. Room is allowed between the tiers for a supporting hand.

In my own case I have utilised a deep cupboard, or to be quite precise, an old wardrobe, but most of the existing racks might be operated upon this principle with very slight

alteration, as there seems to be little question as to the advantage of the ability to select the required comb at a glance, and to remove the desired frame alone.—L. S. CRAWSHAW, *Ilkley, February 3.*

### THE BREATH OF SPRING.

#### CANDY-MAKING.

[5046.] The breath of spring may be detected just now in the air, and our little friends in the hive soon become aware of the fact; the stir and activity in front of their dwelling tell us that they are ready and eager for the work of another season. My hives are situated at an altitude of 600 ft. above sea-level. One consequence of this is that the early flowers are later in appearing with us than with those on a lower level. Winter aconite is only just beginning to yield pollen. The crocus has only just appeared in flower, and will have nothing for the bees yet awhile. Catkins of the wych-hazel are plentiful, but I must confess I rarely have seen bees inspecting them. The last few days have given good opportunity for cleaning flights, of which the bees have not been slow to avail themselves. There has also been a good deal of business transacted in the undertaker's line. I generally find very few dead bees in my hives at the spring cleaning. A peep under the quilts a few days ago revealed some shortness of stores. Those who are at all doubtful about the condition of their stocks in regard to food should assure themselves without delay. A cake of properly-made candy may save a stock which would otherwise perish. But here let me emphasise that it must be "properly made." I lost a stock once through giving candy in which the sugar crystals had not completely dissolved, and which could not, therefore, be used by the bees. I always use best lump sugar for this purpose, but find it requires constant stirring and braying in the pan *while it is getting hot*, otherwise it will boil before the crystals dissolve, and so will set like a brick when cold through over-boiling. When I read of the apparently easy way in which some of the brethren make their candy, I say to myself, "They don't use Tate's No. 1." I wish I knew what they do use.—W. H., *Brilley, Herefordshire.*

### STRONG COLONIES.

#### HOW TO GET THEM AT THE RIGHT TIME.

[5047.] The bee-keeper whose employment takes him away from home from morning till night cannot have much time to devote to his bees; his system of management, therefore, must not involve incessant attention. He desires the best results with the least manipulation, and still avoid swarming. To obtain these results the hive must be warm and dry in winter, cool in summer, and contain sufficient stores to last till natural supplies come in.



Now, a hive built on the "W. B. C." plan is the one he should make, and by reading the letter on "Cheap Home-made Hives" (5027, page 47) the matter of cost need not trouble him.

Our Junior Editor ("W. B. C."), in replying to query on the number of frames his hive should contain, says: "Our preference is for ten standard frames and a dummy in each hive, but in dealing with some races of bees it will, no doubt, be useful to use eleven frames." With regard to size there is a difference of opinion, even among the very best beekeepers, for we find that Mr. Doolittle prefers the "Gallup frame" (11½ in. by 11½ in.).

Mr. Dadant stands by what, I believe, is the largest frame in use, viz., the American "Quinby" (18½ in. by 11½ in.). Mr. C. N. Abbott tried to have recognised as the standard a frame about 16 in. by 10 in. But Mr. H. Neve, in B.B.J. of December 25 (1902, page 516), says:—"As to the size of our 'Standard' frame, to depart from that now would be disastrous to the bee-keeping industry."

A friend of mine was recently told by a Cheshire gentleman that the latter had lost twenty colonies this winter, although he took no honey from them. This is what I should call a "disaster." Had these stocks been on "Quinby," or "Langstroth," or "Gallup," or on the 16 in. by 10 in. frame, the disaster, I feel sure, would have been avoided. And I say the same of the hundreds of stocks that died of starvation during the bad season of last year, for with a large frame there is always a larger balance of stores in hand.

In early spring there is also more scope for a young prolific queen "capable of depositing 3,000 or 4,000 eggs every day for a month previous to the honey harvest" your correspondent "J. G." talks about (5036, page 64).

But if "J. G." has his "W. B. C." hive and his ten standard frames, the capacity of the hive will be about 50,000 cells. Deduct from that 15,000 cells for stores of honey and pollen, and he will have 35,000 cells. If the queen lays 4,000 eggs a day, all the cells will be full in nine days; or, if 3,000 eggs a day, then in twelve days. Now this is where the large frame comes in, as there would be plenty of stores to feed the vast number of larvæ and plenty of room for the queen to continue her laying. And when the days come for gathering there will be no stream leading to other hives like that winged river of honey, pouring into the large hive with the large frames.—J. D., *Pendle Forest, February 16.*

#### HOW TO DESTROY CONDEMNED BEES.

[5048.] I think it may be of interest to beekeepers generally to know of a quick and sure way of killing bees (that is if it is not already known), if suffering from foul brood.

I have tried it on three or four occasions,

and found it answer at once in every single instance; and I am sure it is quicker and far more merciful than the ordinary sulphur treatment. My method is as follows, viz., at night securely close the entrance and block same thoroughly with a piece of wood. Then take a pint or two-pint can with a spout fitted with a rose, making the holes in the rose fairly large first; then fill with ordinary paraffin. When quite dark, go to condemned stock, lift back edge of quilt, and sprinkle the frame-tops thoroughly with the paraffin when gradually drawing back the quilt. Replace quilts, and in five minutes every bee will be found *dead!* From observation, it seems to me the paraffin must in some way choke the bees by entering the breathing pores, as the bees are found still clinging to the frames, not fallen in a heap. I may mention, the experiment may be tried by putting a bee on the window and spraying with paraffin; it instantly dies.—E. H. T., *Dorking.*

#### HONEY IMPORTS.

The value of honey imported into the United Kingdom during the month of January, 1903, was £928.—*From a return furnished to the BRITISH BEE JOURNAL by the Statistical Office, H.M. Customs.*

#### Echoes from the Hives.

*Tothill, Alford, February 5.*—Bees have had a splendid fly this morning, and were working on aconites, which are like a bed of gold, and carrying in large pellets of pollen. I took the advantage of the fine morning and had a look under the quilts of several stocks. I found stores getting very short in all of them, but the bees seemed fairly strong, and there was no signs of dysentery, all the alighting boards being perfectly clean. I attribute this to the dryness of my hives, all of them being covered with Willesden paper.—R. GODSON.

*Burton Pidsea, East Yorks, February 14.*—What remarkable weather we are having! In the East Riding there has scarcely been any rain for three weeks, so the news from Scotland that there had been seventy hours continuous downpour, and that it was twenty years since the rivers had been so flooded, appeared strange. Yesterday (February 13), like the people in London, the bees here were exulting in a glorious spring day. I took advantage of this opportunity and examined my apiary. I am glad to say all forty-eight stocks answered well to the roll call. I was agreeably surprised to find that half of them were covering from seven to eight frames, and all except three or four had food sufficient for five or six weeks, when I intend to commence stimulative feeding. I also noticed but one

leaky roof. With the exception of one severe week in December and another in January this winter has been most open and mild. We were, therefore, surprised to hear of our Highland friends' anxiety about close confinement. We were rather afraid either that the stores might run short, or that their unseasonable activity might shorten the lives of the old bees before they could nurse the next generation, or if the open weather had encouraged breeding there might be danger of much chilled brood later. Should severe weather now come my hope is in double walls, plenty of quilts, and narrow entrances. But unless the wind changes shortly to north or north-east, and remains there for some time, I am inclined to believe that we shall see the earliest spring on record. The vegetation here is very forward. The corn, grasses, and clover look as they generally do in April, proving that there is some warmth in the ground. The wind has now for some time been in the south-west, and no doubt has helped to keep the icebergs at a distance from our coasts, and probably the seas around us are warmer than usual, and we are feeling the effects of the late volcanic action in the West Indies, through the Gulf Stream. If so we can hardly expect any trying weather, unless it be in the shape of fogs and cloudy days.—  
RICHARD M. LAMB.

*Nunnery Fields, Canterbury, February 11.*—My eleven hives have all got safely through the winter so far, and to-day every stock had a good cleansing-flight, while the bees were carrying in pollen fast. The sun was quite warm, and so far as the outside appearance, every colony is all right, but shall not disturb them yet for some time to come, as they have plenty of food. Hoping we shall all have a better year.—T. H.

*Amlwch, Anglesea, February 12.*—My six hives have come out well. The lovely weather we had yesterday brought thousands of them out to enjoy themselves. I gave each of the hives 2 lb. cake of candy.—  
CYMRAES.

## Queries and Replies.

[3032.] *Using Combs and Food from Hive Deserted in February.*—Last spring I allowed a skep of bees to transfer themselves to frame-hive, as directed in "Guide Book." They appeared to go on all right, and when packed down for winter were in very good condition, with plenty of bees and abundance of stores. To-day (February 14) being fine and warm, and seeing the hive was very quiet, I examined it, and found only a score or so of dead bees, among them the queen. The combs weighed 16 lb., one or two of them being rather mouldy along the bottom. Now, I should be glad of a little advice through the B.B.J. 1. Can

you tell me the cause of bees deserting hive, and what could have become of them? 2. Can I give the stored combs to other hives for the bees to clean out, with the idea of using them again? It seems a pity to destroy the frames, which are nearly new, or the food they contain. I am sending a small sample cut from the worst comb for your inspection. I have kept bees for five years, and had the "Guide Book" twelve months. I have also taken the B.B.J. two years, and picked up the little knowledge I possess by watching the different queries week by week. I may add that I examined the deserted hive on Boxing Day, which was fine and warm. It was then crowded with bees.—F. A. C., *Harwarden, Chester, February 14.*

REPLY.—1. There is no sure way of judging from a distance—and from description—why bees sometimes desert their hives. The probable cause, in your case, is that your examination on "Boxing Day" has had something to do with the bees deserting their own queen and joining some other of your colonies. It is certain the bulk of the bees seen on December 26 have done this. 2. The bit of comb sent contained a cell (one only) in which we found a tiny, but very distinct, trace of foul brood. So you must deal with combs and contents in view of the fact. To use either combs or food as proposed would be to court disaster to your whole apiary.

[3033.] *Judging Quality of Honey.*—I have been a subscriber to the JOURNAL about two years, and find it both interesting and instructive. I am sending two samples of honey for your opinion as to quality. Though only a beginner in bee-keeping, I find it extremely fascinating, and am curious to know which of the two samples is best in quality. From an expert's point of view No. 1 was gathered early last season, No. 2 later on, and, I presume, will be heather honey. I have at present only two colonies of bees, as these are as many as I can manage yet. I am, however, trying to gain useful experience from these, hoping to go more thoroughly into the craft when I have more leisure. Being anxious for my bees not to swarm last season, I used a fifteen-frame hive, with non-swarmer chamber underneath; but, alas! the bees did nothing else but swarm—four swarms in all—and that, too, just at the only time when there was any honey to be had. The result was very little surplus honey to take away. Thus, you will see, though possessing only two stocks, I had plenty of experience in swarming. In the end one colony was found to be queenless after swarming was done with. However, I resolved to give the bees a new queen, and managed to introduce an Italian one successfully. Both colonies are now in a flourishing condition, and I am looking forward to the coming season with great pleasure. I must apologise for writing at such length, as I only intended asking about the quality of the

honey, which I now thank you in anticipation for your opinion upon through the columns of the B.B.J.—OFFA, *Shropshire, February 13.*

REPLY.—No 1 (from mixed sources) is good in colour, very fair in flavour, but there is no pronounced "character" about it. It is too thin for keeping well, though not being thoroughly ripe when taken off the hive. No. 2 is mainly from heather, but has a good portion of flower honey in it, as shown by the granulation. The flavour is good, and save for slight signs of incipient fermentation, it is a good table honey. Much better than No. 1.

[3034.] *Re-queening Stocks.*—As a beginner in bee-keeping I hope you will excuse me troubling you on the following points:—I have ordered a queen from a well-known raiser, and intended re-queening one of my stocks early in spring; but he is unable to deliver queens before the end of May. By that time I will, no doubt, be able to tell how present queen is shaping, and if doing well, I would like to utilise her without unduly weakening the stock. I therefore thought of proceeding as follows:—Take two frames with bees and queen from hive to be re-queened about midday, and form a nucleus, putting two frames of foundation in place of the combs removed. Then introduce new queen in the evening. 1. Do you think this plan likely to succeed? I may say that I do not expect to do much with the nucleus thus formed. I only want to utilise the queen now heading the stock, as I have an objection to destroying her if doing well. 2. If the stock is doing fairly well, it ought to be ready for supering by the time I get the new queen. If so, how long ought I to allow them to build-out new combs from the two frames of foundation, and get them partly filled with eggs, &c., before putting on supers? Or would it be better to confine them to the eight frames and super at once? Thanking you in advance for replies.—G. G., *Walton, near Liverpool, February 14.*

REPLY.—1. If a nucleus colony is formed at end of May merely to preserve the removed queen, you should only remove one frame of brood with queen and two combs containing food, together with as many young nurse-bees as will completely cover the brood-comb, and wrap warmly to preserve the warmth. 2. Do not fix any time for "allowing bees to build new combs and fill them with eggs." The time occupied depends on how the colony gets on after introducing the new queen. The same may be said of the time for putting on supers; be guided by the weather and condition of the bees. If room is needed, and honey is coming in, give supers, but not otherwise.

[3035.] *Candy and Artificial Pollen Feeding in February.*—1. Will you please say in your next issue whether 2 lb. of candy given now will carry bees on until April, even

supposing they had no food, or but very little, left? 2. Also kindly say whether there is any harm in giving flour as artificial pollen to bees now? I have given mine some during this last week, and they have worked hard at it, taking it in quite as large quantities as they sometimes do in March.—W. W. W., *Wolverhampton, February 14.*

REPLY.—Give the 2-lb. cake of candy now, and examine in a month; then renew if required. 2 No harm if natural pollen is not to be had, but do not overload the brood-combs with too much flour if the bees can gather pollen freely from the fields.

[3036] *Queen Cast out Dead.*—I have enclosed herewith a queen bee which I found on the ground in front of one of my hives today. I take it that she was the reigning queen of the hive, which consequently is now queenless. I suppose there is nothing that I can do to save the stock; a queen cannot be had at this season. I have other two stocks which appear to be all right. You will no doubt notice that the queen is an Italian, and I think I have read sometime in the B.B.J. that one of the "faults" of Italian bees is queenlessness in the spring, as in my case. Well, we do not always take the advice so kindly given to us, so I suppose one has to learn from experience. And for myself I shall in future keep nothing but the old-fashioned English black, as you have so often advocated. A reply in B.B.J. will oblige.—"DISGUSTED," *Northumberland, February, 11.*

REPLY.—We are not aware if the so-called "faults" of Italian bees include "queenlessness in the spring," but it is well known that unseasonable manipulating in spring sometimes causes the death of queens. Can this be the cause of your own loss? In any case, however, we think our advertisement columns show that fertile queens may be purchased at the present time.

[3037.] *Renewing Combs in Hives.*—I have over fifty hives, and many of the combs need renewing. I find, however, that foundation fixed in the ordinary way "sags" a good deal, many combs being uneven, and in consequence they are ill-suited for extracting. 1. This being so, I intend to try "wiring" the foundation in frames, and will be very thankful for full particulars of the best way of doing it. 2. Also please state what is the best sort of foundation for the purpose, for ensuring even, strong combs for extracting and for transit to the moors. Is "Weed" foundation to be recommended for the purpose? 3. Should I use cane sugar for spring feeding in preference to beet? 4. Is the latter detrimental, and in what way can the one be distinguished from the other? I may mention that I think cane sugar is not generally sold in shops in provincial towns.—F. P., *co. Kerry, February 4.*

REPLY.—1. By writing for the catalogue of

any of our leading appliance dealers you will get illustrations of "wiring frames." 2. "Weed" foundation is good for all purposes, and if "wired" the "medium" weight is quite strong enough for your purpose. 3. Yes. 4. Beet sugar is unsuitable for bee-food because of the injurious chemicals used in some processes of manufacture. There is no ready means of distinguishing beet sugar from that of the sugar-cane.

## BEEES IN UGANDA.

EXTRACTS FROM *The Uganda Protectorate.*

BY SIR HARRY JOHNSTON.

"Honey bees exist over the greater part of the Protectorate, and in many districts are partially domesticated by the natives, to whom honey is an important article of diet. The wax of these bees would certainly form an article of export."

*The Masai.*—"Honey is eaten by every one who can get it. By mixing a little water with the honey an intoxicating mead is made, which is much drunk by the old men."

"Honey is a most important article of diet of all the Nandi-speaking people. In some districts they semi-domesticate the wild bees by plaining bark cylinders on trees for them to build on."

*Bantu Negroes.*—"Apiculture is carried on by most of the Kavirondo, who take great trouble about housing their bees. In districts where trees are scarce, the hives (which are cylinders of wood or bark) are placed on the roofs of the huts. The flavour of the honey is often spoilt through a custom of boiling it, which is done (amongst other reasons) to extract the wax mixed up in the honey."

"Wild honey bees are presumably present throughout the Protectorate. There are many large, solitary, carpenter bees, one or two specimens of which produce really handsome insects. There is one, a very large bee of this 'solitary' kind, which is abundantly met with in the well-wooded regions of the Protectorate where there are plenty of flowers. The creature is nearly the size of the smallest bird, and its body is covered all over with a golden plush. Wasps of many kinds are met with, but though they are armed with powerful stings, they very seldom take the offensive. The mason wasp makes itself rather a nuisance if one lives in a house, because it is constantly making clay nests on the backs of one's books or wall ornaments, and stuffing them with moribund grubs and caterpillars. In addition to this habit, the mason wasp, when he, or, rather, she, visits your dwelling, makes such a fidgety booming and buzzing, that you are compelled to take notice of her proceedings, and flick her with napkins and handkerchiefs."

## Notices to Correspondents & Inquirers.

All queries forwarded will be attended to, and the only of personal interest will be answered in this column.

L. YEO (Cornwall).—*Lantern Slides on Bee-Keeping.*—Slides may be hired from the B.B.K.A. on application to the secretary, Mr. Edwin H. Young, 12, Hanover-square, London. Members of County Associations can hire them at reduced rates.

T. SMITH (Coventry).—*The "W. B. C." Hive.*—The two numbers of the B.B.J. containing directions for making above may be had post free for 2½d. in stamps.

"PERPLEXED" (Bucks).—*Ordering Appliances.*—For the two hives now being made you should order, say, two dozen brood-frames, and the same number of shallow-frames for extracting. Also about 3 lb. of brood-foundation, this being suitable for both brood and combs for extracting.

H. DUBOIS (co. Dublin).—*Sunflowers for Bees.*—Though not usually included in lists of honey-plants, the sunflower (especially the large variety) affords an abundance of pollen, and bees work on the bloom freely in autumn, but it yields very little honey.

E. E. S. (Sutton Coldfield).—*Moving Bees in Spring.*—There need be no fear of difficulty or loss of bees in moving the hive twelve miles away at any season of the year. It will need you to keep a careful eye on the brood-combs during April and May, and if, as stated, the bees were "out very strong" on a recent fine day, it augurs well for their being in a fair way of overcoming the threatened trouble by using remedies as before.

CANDY (Bristol).—*Bee Candy.*—Your sample has not been sufficiently boiled, nor has it been stirred long enough when cooling, consequently the grain is rather coarse, and it will become hard in course of a week or two. There is also a perceptible flavour that reminds us of the "pear-drops" sold in sweet shops. Has this been added by yourself?

### *Suspected Combs.*

CYM. (Anglesea).—The comb sent is very badly affected with foul-brood of old standing. Endeavour by all means to get your friend to destroy all frames and combs of the hive in which the bees have died off, and disinfect the hive itself. Your own stocks may become affected if the bees chance to get at the diseased combs.

S. S. (Devon).—Are we to understand that the experienced bee-keeper you name cut the sample himself from the suspected comb? We ask this because of sample being enveloped in cotton wool, which, by adhering to the comb, made it very unsuitable for examination. We could see no trace of disease in the larvae—sealed or unsealed—the latter being normal and quite healthy. Send another sample, in a used mustard-tin. Do not crush comb, and keep it free from cotton wool as packing.

## Editorial, Notices, &c.

### BRITISH BEEKEEPERS' ASSOCIATION.

The monthly meeting of the Council was held at 105, Jermyn-street, S.W., on Thursday, the 19th inst., Mr. T. I. Weston occupying the chair. There were also present Miss Gayton, Colonel Walker, Messrs. R. T. Andrews, W. Broughton Carr, H. G. Morris, W. F. Reid, E. D. Till, F. B. White, and the Secretary.

Letters apologising for inability to attend were read from the Hon. and Rev. Henry Bligh, Major Fair, and Mr. W. H. Harris.

The minutes of the previous meeting were read and adopted.

Mr. G. F. Bennett, The Lodge, Sarnesfield-court, Weobley, was elected a member of the Association.

The Finance Committee's report, presented by the Chairman, gave details of receipts and expenditure to date. Several accounts were brought forward for payment, and the balance-sheet for 1902 submitted and discussed. The report was approved.

A number of letters upon various matters were read, and the Secretary instructed in regard to replies thereto.

Nominations of Judges to officiate at the forthcoming "Royal" Show were made for approval by the R.A.S.E.

The Chairman stated that the British Consul at Liège had been good enough to send him a copy of the "Extraits des Annales de l'Institut Pasteur, September, 1902, Recherches sur le Microbe de la Logue." The gift was thankfully acknowledged by the Council.

A large number of suggestions, received from various County Associations, in regard to the proposed forms of "County Returns" and "Instructions to Experts," were then considered, and the papers, as amended, were ordered to be put into type before final adoption.

Mr. Reid suggested the advisability of preparing a circular for issue to the Technical Instruction Committee of County Councils directing attention to the work of the Society, and the provision of Certified Experts in Bee-keeping. The suggestion was approved.

A question was raised in regard to the affiliation of Foreign and Colonial B.K. Associations with the Central Society, but nothing was decided.

It was resolved to hold the annual general meeting of members on Thursday, March 19, followed by a *Conversazione* as usual.

### STAFFORDSHIRE B.K.A.

#### ANNUAL MEETING.

The annual meeting of the above association was, by the kindness of the County Technical Committee, held in the Lecture Hall of the Technical School, Stafford, on January 31.

Mr. A. H. Heath, M.P. (President of the Association) presided over a capital attendance, including Mr. W. G. Bagnall (Vice-President), Mr. F. E. Kitchenor (Chairman of the C.C. Technical Instruction Committee), Rev. A. R. Alsop, Colonel Mort, Messrs. E. Clowes, J. R. Critchlow, J. Stubbs, E. W. Turnor (Auditor), the Rev. G. C. Bruton (Hon. Secretary and Treasurer), and Mr. R. Cock (expert).

The Hon. Secretary read the annual report and statement of accounts for the year, which showed that forty-nine new members had joined, bringing the total membership to 195. The accounts showed a total income from all sources of £53 15s. 2d. Subscriptions brought in £39 11s. 6d, the largest income from this source since 1888, whilst the sum of £11 0s. 2d. was handed over to the association by Mr. John Stubbs, Rickerscote, as the result of the entertainment arranged and managed by him. The association owed a debt of gratitude to Mr. Stubbs for his kindness and trouble. The expenditure had amounted to £42 18s. 2d., leaving a balance in favour of the association of £10 17s., compared with a deficit the previous year of £14 0s. 7d. A new departure was made in the work of the association last year. By the kindness of the County Technical Instruction Committee, a honey show was held in their buildings at Stafford on October 4.

No prizes were awarded, but certificates of the 1st or 2nd class were offered for all exhibits sent in. Forty-two lots were staged, thirty-four of which obtained a 1st class. The County Council undertook to defray all expenses, including those of the judge, the Rev. E. Charley. Sympathetic mention was made of the death of the Rev. J. F. Buckler, Rector of Bidston.

Mr. Heath, in expressing the pleasure he felt in coming amongst his old bee-keeping friends, said he was pleased to find the Association in such a flourishing condition after an existence of twenty years.

Mr. Cock read his annual report, which showed he had visited 141 bee-keepers, and inspected 141 straw skeps and 747 frame-hives.

Mr. A. H. Heath was re-elected President, and Mr. Bagnall Vice-President.

The committee and officers were re-elected with one or two additions.—(*Communicated.*)

### BRISTOL, SOM., AND S. GLOS. B.K.A.

#### ANNUAL MEETING.

The annual meeting of the above Association was held at the Occidental Café, Bristol, on February 7. There were a good number of bee-keepers present, including several ladies.

After partaking of light refreshments, Mr. S. Jordan was voted to the chair, and in opening the business of the meeting referred to the pleasant summer meeting of members at the "Home," Long Ashton, when about seventy

members attended and spent a most enjoyable day, for which they owed a debt of gratitude to Miss H. Dawe for her efforts in promoting the pleasures of the outing.

The Hon. Secretary, Mr. James Brown, then read the fourteenth annual report, according to which, after a year's active work and giving liberal prizes at the annual show, they had a balance in hand of £11 4s. 7d. and no liabilities. It also went on to state that the annual show held in connection with the Clutton Horticultural Society was a great success, notwithstanding the poor bee-season of 1902. Mr. W. Herrod, Expert of the B.B.K.A., judged the exhibits, and also gave lectures and demonstrations in the bee-tent. Owing to the regrettable illness of the Hon. Secretary, the work of managing the show devolved upon Messrs. Jordan and Jolly, and R. Brown, jun., to whose untiring efforts much of the success was due.

The report was adopted, and thanks accorded to the retiring officers. The President and Vice-President were re-elected. The following gentlemen were appointed on the Committee:—Messrs. S. Jordan, W. J. Belston, Jas. Brown, E. S. A. Gough, C. Harris, N. F. Jolly, G. W. Kirby, W. P. Morris, Brewer, Tattem, Lockwood, Leat, and Barwell, together with Mrs. Waller and Mrs. Carpenter.

Mr. Jas. Brown was appointed Secretary and Treasurer, with Mr. J. W. Leat as Assistant Secretary.

During the evening several matters relating to marketing honey and preparing it for sale were discussed, and Mr. J. W. Leat gave an address on "Frames."

The meeting concluded with the presentation of silver and bronze medals, and certificates of merit were distributed to members who had assisted in the promotion of bee-keeping.—(Communicated.)

## FOUL BROOD OF BEES.

By F. C. Harrison, Professor of Bacteriology.

(Continued from page 74.)

REMEDIES (continued).

3. *Treatment by Chemicals.*—In the treatment of bees by chemicals, we assume that such substances as are used are employed as antiseptics, and that their efficiency is due to the fact that they destroy the bacillus or prevent the germination of the spores, and thus bring about an internal disinfection; but we must remember that many of the substances used are more poisonous in their effects upon the cells of the bee than upon *B. alvei*. As is well known, quinine is frequently used as a specific for malaria; and in such cases the cure is effected by the intervention of the body cell. The effectiveness of the remedy is due to the fact that it acts as a stimulus and exalts the natural forces of the body.

Whether the drugs used in the treatment of

foul brood act antiseptically or by stimulating the cells of the bee and making them more active to ward off the disease, is a matter of doubt; but it must be admitted that certain drugs do seem to effect a cure, and some of them are regarded as specifics by practical bee-keepers.

In taking up the different methods of chemical treatment, I shall, as far as possible, describe them in the chronological order.

(1) *Carbolic Acid.*—Carbolic acid was first proposed by Butlerow (52), who recommended 1 part of acid to 600 of syrup, this proportion being the limit in which one can give the remedy to bees. Cech (53), in a work published in 1877, also recommended carbolic acid.

The Cheshire treatment (26) consists in using a treatment containing half a decilitre of carbolic acid in a litre of water, thoroughly shaking it up until the acid is entirely dissolved, and using half a decilitre of this in a litre of syrup. In this treatment it is also necessary to reduce the infected stock to the number of frames it can use, and if the queen is diseased to destroy her and substitute a healthy one. The syrup is given by pouring it into the empty cells of the brood nest.

This method of treatment has been frequently reported to be successful; but there have been many failures, perhaps partly owing to the fact that it is difficult to get the bees to take the medicated syrup.

*Experiments on the Antiseptic Value of Carbolic Acid.*—According to McKenzie (28), 2 per cent. carbolic acid does not kill the spores in six days. One per 500 of the acid prevented the germination of the spores, but when taken out of the solution and placed in ordinary beef broth it gave luxuriant growth. Hence McKenzie thinks that the explanation of the value of carbolated syrup in the treatment of foul brood consists in preventing the germination of the spores. The bee journals refer to numerous instances in which feeding carbolated syrup produced an improvement in diseased stock; but as soon as the treatment stopped, the disease broke out afresh.

(2) *Salicylic Acid.*—The salicylic acid treatment was first used by Hilbert in 1876. The following is the method of use:—

Solution of Hilbert No. 1—Pure salicylic acid, 12½ grams; alcohol, 100 grams.

Solution of Hilbert No. 2.—200 drops of solution No. 1 (about 5 grams), in 200 grams of distilled water or rain water.

Fumigation.—1 gram or 2 grams of the pure acid for fumigation.

Syrup.—From 200 drops to 240 drops of solution No. 1 (or about 5 grams to 6 grams) in a litre of syrup, well mixed before the syrup cools.

As soon as the disease is noticed the hive is

(48) Nyon, 1886, p. 121.

(49) Bee-keeping, New York, 1885, p. 217.

(50) Bulletin d'Apiculture, 1882, p. 219.

disinfected and the syrup fed ; and this treatment is also used for other colonies as a preventive treatment. The fumigation is accomplished in a kind of tin lantern furnished with a small alcohol lamp, suspended over which is a small movable trough for placing the acid in. The flame of the lamp is regulated in such a manner that the acid is liquefied and slowly evaporated without burning. Too great heat will decompose it and render it ineffective. The fumes of the acid spread through the hive in the form of a white vapour. Whilst the fumigation is in progress the entrance-boards and all parts that can be disinfected are washed with No. 2 solution. Fumigation and washing are repeated every four or five days until a cure is effected. The diseased colonies receive, every second evening, 1-6 of a litre of acid syrup ; and it is wise to give the same treatment to the neighbouring hives. A cure is usually effected in three or four weeks. If later, it is generally regarded as a sign that the queen is diseased, in which case it would be well to replace her. Occasionally the queens die during the treatment ; but this is not frequent.

This treatment was very successful in diseased hives belonging to Bertrand (59). All the hives that were treated, were cured. Cowan (60), who has also used Hilbert's treatment with some slight modifications, has had the same success ; and such is his confidence in the treatment that he does not fear to introduce into his apiary foul brood colonies for treatment. Some have found the treatment ineffective ; but Bertrand thinks (59) that in all such cases there has been something lacking in the work, some precautions overlooked or neglected.

*Experiments on the Antiseptic Value of Salicylic Acid.*—Salicylic acid agar was made containing 5 grams of 12½ per cent. solution of salicylic acid in one litre of agar. Petrie plates were made from this and streaked on the surface with *B. alvei*. At the same time control cultures on ordinary agar were made. The results were abundant growth on the control plates and good growth (but somewhat less than on the control plates) on the salicylic acid agar.

*Salicylic Acid Vapour.*—One gram of the acid was evaporated in our laboratory according to the directions given by Bertrand (59), in a box about the same size as a hive. Agar plates streaked with spores of *B. alvei* were left in different parts of the box during the fumigation for ten minutes. The plates were then taken out, the covers put on and the plates incubated at 37 deg. C. for forty-eight hours.

*Results.*—Fumigated plates—no growth.

Control plates—abundant growth.

From these experiments it will be seen that

the vapour of salicylic acid acts antiseptically, and that the feeding of the acid in the syrup, in the proportions specified, probably acts as a stimulant to the bees, enabling them to withstand or throw off the disease.

(3) *Camphor.*—Ossipow (61) was the first to use camphor as a curative ; and Bertrand (59) describes the use of it as follows :—“There is,” says he, “placed upon the bottom board of the hive, enveloped in a piece of muslin, a piece of camphor about the size of a walnut, which is replaced when it has evaporated. The presence of the camphor permits the bees to clean out the cells containing dead larvæ and stop the development of the disease. So long as a hive contains some of the substance foul brood will not develop, at least according to our experience and to that of several other bee-keepers. The first thing to do then, when one doubts the state of health of a colony, is to employ the Ossipow remedy before proceeding to more radical means. One can administer camphor in food by dissolving it in its own weight of alcohol.”

*Experiments on the Antiseptic Value of Camphor.*—Sloped agar in tubes was inoculated with one loopful of spores of *B. alvei*, and a crystal of camphor about the size of a large pea was dropped into the tube. The tubes were then capped with tinfoil paper and kept at 22 deg. C. and 37 deg. C.; and control cultures were made at the same time. At 22 deg. C., after two days, there was good growth in the camphor tube. At 37 deg. C., after two days, compared with the control tube, the camphor tube showed slight restriction of growth, the extra heat having evaporated the camphor more quickly.

Another series was made by using agar Petri plates streaked with two loopfuls of spores. In each plate was placed a portion of camphor about the size of a large pea ; and the plates were incubated at 37 deg. C. In twenty-four hours there was good growth ; but close to the lump of camphor growth was slightly inhibited.

Thus camphor in the quantity in which it might be kept in a hive has no antiseptic effect, the amount used in the experiments being far larger than would be used in a hive. This, substance, therefore, if it has the effect mentioned by those who have used it, must act as a stimulant, strengthening the bees to overcome the disease.

(4) *Thyme.*—Klempin (62) has used

(54) Philosophical Transactions of the Royal Society, 1807, p. 243.

(55) Introduction to Entomology, 1828, Vol. ii, p. 111.

(56) Reports of the Bee-keepers' Association for the Province of Ontario, Toronto, 1890-1898.

(57) Journal American Public Health Association, Vol. xxiii., 1898.

(58) Quinby's New Bee-keeping, p. 213, New York, 1879.

(59) Conduite du Rucher, 8th Edition, Nyon, 1895.

(60) British Bee Journal, Vol. 12, p. 128.

(61) Travaux de la Société Economique Impériale, St. Petersburg, 1884.

(62) L'Apicoltore, Milano, 1885, p. 302 (Report by Prof. Gratsi).

(1) Revue Internationale d'Apiculture, 1897, p. 9.

(2) Bienen Zeitung, 1874, p. 176.

(3) Phenol, Thymol, and Salicylsäure als Heilmittel der Brut Pest der Bienen, 1877.

branches of dry thyme with success, burning them in the smoker for disinfecting his hives; but their effect, like that of camphor, is not radical, and bee-keepers are not all in accord as to their efficacy.

(5) In connection with thyme *thymol* may be mentioned. Zehetmayr (63) has recommended the use of thymol, and has made a little machine by which he steams the bees with this substance. If a little of it is placed in a hive it will prevent infection, because bees from uninfected hives will not come near it; they object to the smell until they become accustomed to it. Blow (63) thinks it very valuable, and Jones (65) remarks that, even in great dilution, it prevents the growth of the germ; but Cowan criticises its use, because it is disagreeable to bees, and if used in sufficient quantity, acts as a poison, and, therefore, cannot be good in food.

*Experiments on the Antiseptic Value of Thymol.*—Crystals of thymol were placed in test tubes of sloped agar in our laboratory and inoculated with one loopful of spores of *B. alvei*. These were capped with tin foil paper and incubated at 22 deg. and 37 deg. C.

*Result.*—Control tubes—abundant growth.

Thymol tube at 22 deg. C.—slight growth.

” ” 37 deg. C.—very slight growth.

Agar plates, poured and streaked with two loopfuls of spores of *B. alvei*, were used in another experiment; and a piece of thymol the size of a large pea was placed in each plate. The plates were incubated at 37 deg., along with control plates, with the following results:—

Twenty-four hours, control plate—abundant growth.

Twenty-four hours, thymol plates—good growth, but close to the lump, no growth.

Hence we conclude that this substance has a very slight antiseptic effect.

(6) *Carbolic Acid and Tar.*—These substances were first used by Schreuter (66) and they are applied as follows:—“A piece of felt wool is placed in a small box and soaked with a mixture of carbolic acid and Norwegian tar in equal proportions. The cover of the hive is slightly raised, in order to permit of the evaporation of the carbolic acid. The box is left upon the platform of the hive beneath the brood, and remains there permanently. The dose can be renewed as often as required. The addition of tar to the acid is for the purpose of making evaporation take place more slowly.” This remedy has not been used to a very great extent. Borel (67) reports success with it; but others have not had the same results, and it is probable that it should be used only as a preventive.

*Experiments on the Antiseptic Value of Carbolic Acid and Tar.*—Four drops of the mixture placed on blotting paper and inserted in a Petri dish containing agar streaked with spores, inhibited growth, from which we see that the mixture is antiseptic.

(7) *Creolin or Phenyle.*—Creolin has been recommended by Cowan (68) and has been used with success by other apiculturists.

*Recipes.*—Solution No. 1.—For sprinkling, disinfecting, &c., half a teaspoonful of soluble creolin in a litre of water.

Solution No. 2.—For washing hives, platforms, &c., two teaspoonfuls of soluble creolin to a litre of water.

Solution No. 3.—For feeding, a quarter of a teaspoonful of soluble creolin in a litre of syrup.

The water of the syrup ought always to be poured upon the top of the creolin, and thoroughly mixed with it, and the mixture should be well shaken before using.

*Use.*—Prepare a hive and a proper floorboard, which has been washed with solution No. 2. Then, after having taken out the comb from the infected hive, shake off the bees, and sprinkle the comb with solution No. 1. Take out all superfluous comb, and spray it with solution No. 2, and extract the honey from it. The honey can then be boiled, and if it is used for feeding the bees, it can be diluted and phenol added in the proportion of one-quarter to a teaspoonful to a litre of the diluted honey. The combs are then put back, and the bees fed with medicated syrup. If the bees take the syrup, the dose can be gradually increased, but we must be careful not to give more than one teaspoonful to a litre of syrup. If the bees refuse to touch it, which is not at all improbable, if they have access to other food, pour the medicated syrup upon the neighbouring combs, when the bees will quickly become habituated to it, and afterwards will take it in the ordinary manner. The vapour of creolin also acts as a disinfectant. A small phial of concentrated creolin may be placed in a corner of the hive, and lightly stopped with a cotton plug; and the lower part of the cotton being in contact with the liquid, capillarity will take place and draw up the creolin, and the heat of the hive will produce the necessary evaporation. A piece of blotting-paper can be used by saturating it with creolin, and placing it upon the floorboard or in a box covered with perforated zinc, so that the bees will not come into contact with the disinfectant.

Creolin is neither poisonous nor corrosive for man, but in strong doses it kills insects. Consequently, it is necessary not to give greater strengths than those mentioned above. In the use of this remedy it is necessary to stimulate the production of brood by feeding liberally with medicated syrup; if the disease does not yield to this treatment, the queen should be removed.

(63) *British Bee Journal*, Vol. 12, p. 60.

(64) *Ibid.*, p. 129.

(65) *Foul-brood: Its Management and Cure*, Beeton, Canada, 1886.

(66) *Bienen Zeitung*, Dec, 1887.

(67) *Revue Internationale d'Apiculture*, 1888, p. 156.

(68) *Revue Internationale d'Apiculture*, 1889, p. 139.



*Experiments on the Antiseptic Value of Creolin.*—(a) Sloped agar.—Each tube inoculated with one loopful of spores, was plugged with cotton-wool saturated with creolin, and then capped with lead foil. Tubes were kept at 22 deg. C. and 37 deg. C.

*Result.*—After four days at 22 deg. C., no growth, except beneath the condensation water in the tubes. After four days at 37 deg. C., no growth.

At the end of this time new cotton plugs were inserted into the tubes in the place of the creolin ones, and the cultures again incubated, when good growth ensued in twenty-four hours.

(b) Agar plates were made and streaked with two loopfuls of spores. In each plate was placed a square inch of thick blotting-paper, with four drops of creolin on it. The plates were kept in the incubator at 37 deg. C., and removed in forty-eight hours, when very slight growth was manifest. On removal of the creolin and further incubation of the plates, good growth was obtained. Control plates gave copious growth. These experiments were repeated with only one drop of creolin.

*Result.*—After twenty-four hours, abundant growth. With two drops of creolin, the growth was restricted to the inoculation track after forty-eight hours at 37 deg. C.

(c) In addition to the above experiments, agar was made containing the same proportion of disinfectant as was used in feeding the bees of diseased hives; 15 c.c. of this agar was taken for making a plate culture, and several plates were streaked with two loopfuls of spores, and incubated at 37 deg. C.

Strength of agar, 2 c.c. creolin to 1 litre of water—i.e., about half a teaspoonful to a quart.

*Results.*—Creolin agar, four tests—no growths.

Control agar, abundant growth. This antiseptic in the strength used by Cowan for feeding purposes would prevent the germination of the spores; and if there was a large amount evaporating in the hive a slight antiseptic result would take place.

(To be continued.)

## Correspondence.

*The Editors do not hold themselves responsible for the opinions expressed by correspondents. No notice will be taken of anonymous communications, and correspondents are requested to write on one side of the paper only and give their real names and addresses, not necessarily for publication, but as a guarantee of good faith. Illustrations should be drawn on separate pieces of paper. We do not undertake to return rejected communications.*

### TALL SECTIONS.

[5049.] Let me assure all who, like Messrs. Devereux Bros. (5000, page 8), took an interest in the section controversy two winters ago, that, after experiments made during the last two

seasons, my enthusiasm for the 5 in. section has risen rather than abated. In 1901 the honey flow was so steady, and the nectar of such good consistency, that the square sections were taken to and worked fairly satisfactorily; still the tall sections gave better results. I supered 300 of each kind and took off all that were marketable, 250 square and 270 tall. But as I advocated a change, chiefly on account of our fickle climate, the results of the last season were specially interesting, and they were such as to deepen my conviction that for commercial purposes the tall sections were decidedly preferable. I had intended to try 500 of each, but soon after I had put on 300 of each, and before I had the others ready, so many stocks showed signs of distress from want of room that I was afraid the whole apiary would catch a swarming fever, and at once gave them more room. The honey flow soon after ceased, and I secured 120 square and 185 tall saleable sections.

*On the Moors.*—The conditions here were not such as to enable me to make a fair comparison. In 1901 my bees missed some fine days on the heather early in August, because the clover was still yielding here, and I had very few worked-out sections to give them. Last year I had a nice number of worked-out sections. I took the bees to Goathland, near Whitby, on August 15, just when the heather was beginning to bloom, but got no completed sections. Some who went to the moors earlier took off a few good ones, containing a mixture from blackberry, bell-heather, and ling; but these were not a tithe of the sections they put on. For the coming season I hope to have ready 500 old and 1,000 new sections, a good proportion of which I can, no doubt, try on the heather.

Some of your readers appear to be surprised that the tall sections had not come more to the front already. Why? Is it because they think the argument in their favour was so strong and conclusive? If they had considered that prejudice, cost, vested interests, uncertainty as to the exact size and manner of working—all were against a change, they would have given more time for trial. Many, moreover, are inclined to act on "Let well alone," and stand still, when wisdom dictates "Festina lente" (Hasten slowly). This latter motto points, perhaps to a characteristic of the British in comparison with the Americans. In machinery and appliances we do not give up the old for the new so hurriedly, but most of our countrymen, I believe, are constantly looking out for improvements, and when they perceive a decided advantage in anything new adopt it.

Now with respect to sections, may I entreat the committees of at least our important shows to give all bee-keepers the opportunity of comparing the old and new, in other words, to give the new fair play. Last season I received schedules from the secretaries of most of the shows. My intention was to

enter my best sets of both square and tall sections side by side in a good many shows. I was, however, greatly disappointed to find that some of the schedules allowed only the  $4\frac{1}{4}$  in. by  $4\frac{1}{4}$  in. section to be exhibited. As this has never been made the standard section I cannot see any good reason for thus shutting the door upon all change and perhaps improvement. In classes for extracted honey the bottles are not restricted to one shape or one size. What objection can there be to have a simple rule for sections, that they must be 1 lb. weight? Feeling, however, that the matter is too important to be left where it is, I appeal to a wider circle than the show-bench. It closely concerns thousands of bee-keepers. I would then ask them to weigh well the following lines of thought, and then, perhaps, they will agree with me that the matter is too important to be left where it is.

If the  $4\frac{1}{4}$  in. by  $4\frac{1}{4}$  in. section was so perfect as some imagine, why did not the B.B.K.A. make it the "Standard" section? They were asked to do so a few years ago. Why did they decline? Because, no doubt, many felt there was considerable room for improvement. Admitting that a few persons here and there have been fairly successful in producing the old sections both for show and market, I ask, Why have hundreds of bee-keepers given up raising honey-comb for extracted honey? I have heard dozens make this resolution to change, and, no doubt, others in other districts can say the same. Why? Because they have been disheartened by their failures with the present section, especially after seeing what the bees could do in the shallow-frames. Again, why have others adopted all kinds of make-shifts to secure honey-comb?—some in poor seasons selling heather honey in shallow-frames—the Rev. T. Adams (*see* B.J., January 15) dividing shallow-frames equally into two parts by two adjoining pieces of wood in the centre. I myself, before using the shallow-frame, divided the Standard frame horizontally. Why? Because, especially in moderate seasons, these were helps to larger "takes" of honeycomb than could be got by the square section.

Now, let us look at the market. It is surprising in how many towns and villages sections unfit for consumption are displayed for sale. It was but last autumn that I drew the attention of a leading grocer in a fashionable seaside resort to an eyesore in his smart window, namely, a dirty unfinished section. His reply was what I expected—the bee-keeper could not supply him with anything better. I thereupon asked him to walk across the street and notice the quality of the new section, for some of which a grocer was paying 1s. each, wholesale, and selling for 1s. 3d. or 1s. 6d. Why, then, after all the work of lectures, experts, shows, associations, is a second or third-class stuff offered in hundreds of windows in every county? Because a

section quite unsuited to our climate blocks the way.

How any bee-keeper of ordinary intelligence, knowing what a thing of delicacy and beauty a piece of nicely and freshly finished honey-comb is, can dare to present what is now frequently presented to the public, is to my mind utterly shameful; nor can I understand the man who observes the superiority of work in shallow-frames in comparison with that in the old sections, and is not filled with inspiration and determination to level up. In this matter, as well as in others, I heartily re-echo Mr. Woodley: "We must still go forward, still aspire to do better than ever before."

Above all, if our progress is to be steady we must carefully test each step we are asked to take. There is good authority for so doing. In his "History of the Criminal Law," Sir James FitzJames Stephens places on record the matured judgment of the Judicial Bench that no kind of evidence needs more the test of cross-examination than that of experts.

The above was written more than a week ago. I would add that it was with pleasure I read Mr. Clay's experience with the tall section on page 66 of this week's JOURNAL. What more do we want than "the bees work them well, they look well, and sell well?" only one thing, that the bee-keepers generally may learn their true value by a fair trial. To bring this about may appear an up-hill task, but there is no reason for desponding. Truth will prevail.—RICHARD M. LAMB, *Burton Pilsca, February 14.*

#### NON-SWARMING.

[5050.] I was disappointed on reading the extract from *Gleanings* (on page 39) regarding the "shook swarm" idea, and must say that if American bee-men are jubilant over it they must be very easily pleased. What we want is a method that will enable us to prevent swarming, and at the same time help to keep our stocks in the best average condition. Mr. Rymer, by extending the brood-nest to twenty frames, has succeeded in putting a stop to swarming, but his method, though excellent for his own district, is unsuitable for general adoption. There can be no doubt that a good queen is cramped with a brood-nest of only ten standard frames, and a number of bee-men seem to realise this, for we now hear proposals made to extend the brood-nest *while honey is coming in* by giving a box of shallow-frames either above or below the standard frames. For myself, however, let me say, I am opposed to any such practice; indeed, when we think it over, the idea of extending the brood-nest during the honey-flow seems almost absurd. At that time honey-storing and not brood-rearing should be the object aimed at; we cannot have excessive brood-production and a heavy surplus of honey; the two do not go together.

In my opinion, the main thing in preventing

swarming is to give the queen unlimited breeding room, but this must be done before the season opens, and here everything depends on autumn preparation. If, at the end of the preceding season, the stock was packed down for winter in good condition, there should be little difficulty in getting the brood-nest extended to twenty Standard frames before the main honey-flow begins. We then divide, shifting the brood-box and ten frames to a makeshift hive standing beside the other, and run in a newly-mated queen after the usual interval. Some might be inclined to super both stocks, but I should say that the parent stock only is to be supered, while the bees taken away with the removed frames should be chiefly nurses, newly-hatched workers. Consequently, the population of the working stock will be largely made up of field-workers. The new colony is to be worked for bees, and its surplus population—at intervals—is removed and run into the parent, or working, colony, thus keeping the latter up to full strength while the honey-flow lasts. At the end of season the old queen can be destroyed, and the two lots united by placing one brood-box above the other.

The management of the new colony must be quite different from that of the parent stock. In the one we want to encourage what must be avoided in the other—*i.e.*, excessive brood-rearing. The old queen having had breeding-room to the extent of twenty frames, the chief cause of swarming is removed, but it would still be unsafe to let the bees feel cramped for want of room, and here the non-swarming hive is useful. But in this matter dealers have unanimously gone astray. I don't know why, but they will persist in placing the non-swarming chamber *under* the entrance? Now, if these hives are to be really useful the empty space must be *between* the brood-nest and entrance. I find no difficulty in converting a "W. B. C." hive into a non-swarm, and without altering the floor-board or anything else; the brood-box is simply raised 6 in. above entrance and supers can be slipped under from behind. The empty space is left between stock and entrance during winter, and in spring the brood-box is brought down to floorboard.

Drone-rearing is also a fruitful cause of swarming. We want drones raised in only the very best stocks, but the bees of other hives do not see matters in that light; so they each proceed to rear a liberal number of worse than useless (see Maeterlinck for adjectives) drones. We have got to recognise the fact that it is part of the queen's duty to lay a certain number of drone-eggs, and that we cannot prevent her doing so, whether by using full sheets of foundation or any other means; we can, however, certainly take care that these eggs do not produce drones.

I remember reading in your columns, some time ago, a letter from some genius telling how, early in the season, he gave a frame of drone-

comb in the centre of brood-nest, and, when filled up by the queen, it was removed and the eggs washed out under a jet of water. This idea was certainly novel, and at least worthy of a trial. But, probably because it was new, some busybody at once threw cold water on the scheme, in an epistle the gist of which was that the whole proceeding was against Nature. Of course it is, and so is the super-clearer, comb-foundation, and the extractor—in fact, almost everything connected with modern bee-keeping is against Nature's methods; and if we wish to get back to these methods, our stocks must be domiciled in hollow trees, and worked on the "let 'em alone" plan.

The system of management I have outlined is in several respects quite different from any other, and will, of course, be condemned by those who are pleased to imagine that present-day methods cannot be improved upon. If these wiseacres are right, bee-keeping must be very different from every other business, for we have abundant proof in connection with every branch of industry of the fact that there can be no standing still, and that the industry which does not go forward will most certainly go back.

Judging by what appears in your columns, there is an increasing number of bee-men who refuse to believe that our present management cannot be improved upon, and among these "progressives" I think Mr. W. Woodley may be included. In one of his contributions he gave it as his opinion that very little progress had been made for the last ten or fifteen years; and, in another, asked for the starting of a discussion on the best means of bringing our stocks to the pink of perfection at the right time. The discussion has not come off yet; we can have it now if those who possess helpful ideas will send them along that they may be discussed, and, if thought useful, put to a practical trial during the coming season.—J. M. U., *Ussie Valley, N.B., February 19.*

#### RAILWAY RATES FOR HONEY.

[5051.] Mr. W. Woodley writes, on page 74 last week, of a regulation adopted by the several railway companies with regard to carriage of honey in the comb as something new. I referred to this decision in your paper when it was brought to my notice by our station-master about a year ago, and I have no doubt that the backward step in question has been caused by the careless way in which some bee-keepers send comb-honey by rail, and then immediately make a claim if it is damaged. Inexperienced novices also, unaccustomed to packing, unknowingly contribute to this sort of thing; but it does not take an experienced railway official long to find out whether comb-honey has been properly packed or not. For myself, I must say that I have seen instances of such grossly careless packing as to cause me no surprise at

the step taken by the railway companies to avoid responsibility for such carelessness on the part of customers.

In this way we have lost the confidence of the rail carriers, and instead of crying over the matter let us devote our energies to an effort for regaining what we have lost. What is to my mind more important, is to show that bee-keeping is, individually and collectively, a pursuit that may be of some importance to our railway companies, and worthy of more favourable consideration.

Owing to the greater risk of damage, and the time occupied in transit, I never send comb-honey by "goods." In saying this, I do not overlook the fact that I don't deal in such large consignments as Mr. Woodley, but it only needs to watch the operation of "shunting" to make one feel that the effect must be more than risky to comb-honey. Why even live cattle are sometimes thrown into a heap in the trucks during "shunting." For the present, then, we can only send comb-honey by rail as honey, labelled as such, and add "with care." Send at reduced rate, because if damaged we get nothing. When it is fully realised that bee-keepers who chiefly produce comb-honey have to rely almost entirely upon good packing for the safe conveyance of their produce, they will perforce look to their method, and want of method, in packing honey. Though the alteration referred to above inflicts some hardship upon a few of our best bee-keepers, I regard it as one of those misfortunes from which good will follow.—W. LOVEDAY, *Hatfield Heath, Harlow.*

### THAT "LARGER FRAME."

#### ITS RELATION TO "MANAGEMENT."

[5052.] Your correspondent "J. D." (5047, page 76) appears to argue from two points of view for a frame larger than the "Association standard" size: (1) better wintering; (2) larger harvests. I am not quite sure that this is the argument, as his inclusion of a frame with smaller *available* wintering area than the "standard," viz., the "Gallup," in the list of those which would have saved the colonies to which he refers on page 77 renders his meaning doubtful. But, supposing this the case, and taking the points mentioned in order, I ask with regard to the first point, i.e., better wintering: Is it not likely that the colonies which perished had some stores left, and would, therefore, not have starved, had they been able to reach them; in other words, had they been properly packed up for winter?

If the bees died from starvation, is it likely that the owner would have managed any better with a larger frame? "No stores in winter," arguing either ignorance or neglect. On the other hand, if there were no stores in the brood-nest at end of the season, it might be that the colonies had been too weak to gather, possibly owing to inferior queens.

How would a larger frame have improved this?

Again, if the queens were first-class, they may have crowded the stores into the supers. But as we are told none was taken away, either none was gathered, or it was taken down again by the bees in autumn. Where a good queen has done her best, and there are no stores left in the brood-combs, prompt attention can supply the remedy. Feeding *done early* provides better stores than autumn honey. But is it not far better to be in a position to give to a colony sealed combs of early honey, or of sealed syrup stored by an auxiliary colony during the summer itself? And would not any decent colony winter well, with two or three well sealed "standard" combs? And might not these be ensured under any "decent" management?

Referring to the second point, I would ask, is "J. D." sure of his "larger harvest?" He asserts that "with a large frame there is always a balance of stores in hand." May not this mean at times less in the supers? Perhaps; perhaps not. But, at any rate, the matter would be quite beyond the control of the "bee-keeper who has not much time to devote to his bees" (page 76). If this individual had a larger frame, he would be compelled to suffer it under all circumstances, including the varying qualities of seasons and queens, whereas it is possible that were he able to reduce the size of his frame when desired, he might be better off.

On a "par" with the virtue of the queen, the *crux* of the matter would seem to lie with the "management."

There are good and bad queens; there is also good and bad management. The good queen may be crowded in a standard brood-nest; but how often do we find queens that lay 4,000 eggs a day? And are they not most likely to be found under the good management. A really good queen under good management may require a larger brood-nest; a larger frame.

A *moderately* good queen may perhaps do better with a standard brood-nest even under the better management. But under poor, or even ordinary, management, how many bee-keepers would get a surplus from the large frame? In other words, is it so well adapted as the "standard" to the requirements of bee-keepers who do not possess, possibly do not know of, better queens than their village strain produces?

Suppose we grant, for the sake of the argument, that under good management, a larger frame might be an advantage. What is the likely proportion of such good management? And would not this mean one frame for the expert, and another for the tyro? And do all experts agree, even now, as to the desirable size? Would a larger frame suit so well the *comb honey* producer and the queen breeder?

I must myself own to a "sneaking regard" for the 16 in. by 10 in. (which has such a warm

advocate in Mr. Simmins), but only for a first-class extracted honey district.

We will grant, however, that the large brood-nest at the right time will give the most surplus. Is there not a moment when it may be advantageous to reduce the brood-nest? And is it not an advantage to retain the full surface area under the super? Or to put it in another way:—

Is not the present solution of the whole difficulty to be found in the use of an additional tier of shallow brood-frames, with the advantage that stores may be placed either above or below the brood rest with stimulative purpose? A plan which has many advantages which are not within the present scope. Will not this meet the requirements of J.D.?

It is possible that I may be rushing with clumsy foot where older experts would tread lightly, but has J.D. tried the larger frame himself in his own district with his own colonies, and does he find a marked difference in results? If so, it seems to me that his letter would have been of more value, had he given figures instead of mere theoretical deductions, for whilst allowing the beauty of his closing simile, this can hardly be admitted as proof.—L. S. CRAWSHAW, *Ikley, February 21.*

### NOVELTIES FOR 1903.

THE "HOUGHTON" VENTILATING DUMMY-BOARD (patent applied for).

Regarding this the inventor says:—

"I herewith enclose illustrations of a dummy-board designed to act as a ventilator. Bee-keepers generally have long known that an undercurrent of air will retard, if not stop, swarming; also that good ventilation is imperative as a preventive against foul brood. I have designed my dummy for this purpose, and submit the idea

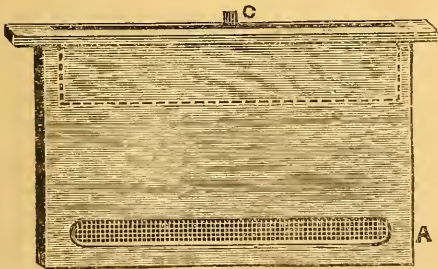

Fig. 1.

to the craft, through the medium of our invaluable B.B.J.

The dummy-board (fig. 2) is made hollow as shown. In the front (the side to be placed facing the frames) of the board at the base there is an aperture, which is covered with wire gauze (A, fig. 1).

In the reverse side is a similar aperture, but at the top, and this is also covered with wire gauze. (B, fig. 3.)

This aperture B is fitted with an adjustable slide C, which works inside the board. This slide when closed entirely covers the aperture, and when withdrawn allows a free current of air to pass through the board, as shown in fig. 2.



Fig. 2.

By the insertion of my dummy in the hive and withdrawing the slide (which will then lay over the quilts, being hinged for that purpose), we encourage a circulation of air along the floorboard and through the aperture B, thus supplying the brood-chamber with fresh air, with an absence of cold draughts among the combs. The advantage of this is obvious during the earlier summer months, when we have warm sunny days followed by cold and frosty nights. Also by opening the ventilator during the daytime and closing it at night, we overcome the difficulty attending the use of the 8½-in. dummy-board.

I feel sure there are many bee-keepers who

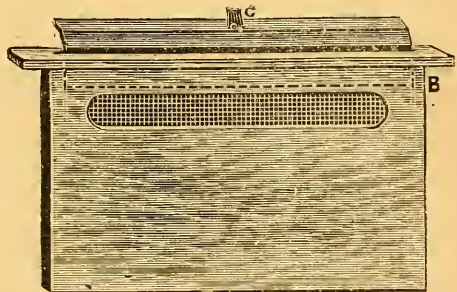

Fig. 3.

have suffered for the want of an efficient means whereby they can keep their bees healthy and their hives cool during the summer months. Should any of your readers be interested in my idea, I should be pleased to supply them with any further particulars they may require.

## Queries and Replies.

[3038.] *Bees Transferring Themselves.*—I have a swarm of bees in an old cheese-box given me by a friend last spring. I removed it to my garden, and put it above top-bars of set of frames fitted with comb foundation. Will you kindly give me your advice if it's safe for me to remove the cheese-box now, as I should much prefer having bees in a frame-hive? I believe the stock is pretty strong, but the bulk of the bees are in the cheese-box and are carrying in pollen on fine days. A reply will oblige.—H. P., *Dolgelly, February 19.*

REPLY.—It is unfortunate that you have allowed breeding to start in cheese-box before

removing it, but to make the best of present conditions examine the box and see to what extent breeding has progressed. If there is much brood we advise deferring removal till the brood-nest is again transferred to the frame-hive below, then take off the box and its contents. If, however, there is but little brood, and the box does not contain the bulk of the food-stores, drive the bees and queen from it and run them into the frame-hive the first fine warm day, and either sacrifice the sealed brood in the combs or cut out the combs and tie them into a frame in the usual way; then hang this frame in the lower hive till brood hatches out.

[3039] *Dangers of Robbing.*—I have kept bees for fifteen years, but do not understand much about foul brood, though I have the "Guide Book," and take in BEE JOURNAL regularly; and it is a great help, for I often find just the very thing in that I want to know in your answers to questions. I manage my own bees as a rule, and drive all the weak lots in autumn; but as I only got two swarms last year from seven hives I thought it best to leave them to take their chance. I have five frame hives and three skeps now, having destroyed one that I am writing about. I knew this skep was a weak lot, but they had got plenty of food in autumn, and I have kept candy cake on all my hives. I do not know what made them start "robbing," but they began on this skep one day last week. So I closed the entrance, and moved it away from the other hives; but on examining it three days later I found only a small group of bees huddled together (about a handful), but they were all alive, and no dead bees in the hive. I did not find a queen bee. Will you please say if comb sent is diseased, as I feel very anxious about it? I have destroyed the bees.—C. H., *Herts.*

REPLY.—We regret to say the comb sent is badly affected with foul brood, and, in consequence, the probability is that some of your healthy stocks will be affected. A careful look-out must therefore be kept on all hatching brood. Nothing can be done now beyond using preventives in the usual way.

[3040.] *Tall Sections for Safe Transit.*—Last year I tried the new tall sections, and was very pleased with them. I thought the bees were much quicker in getting up into them than into the square  $4\frac{1}{4}$  in. by  $4\frac{1}{4}$  in. ones. But before continuing the experiment this summer, I should be glad to know whether, when filled, they travel equally well with the old square ones? The few I sent by post arrived with the comb broken quite away from the wood. As I am not aware of having had any such mishap before, I write to ask if you could kindly say whether other people have found the same difficulty, or whether my experience was accidental?—E. C., *Devon.*

REPLY.—There is no possible reason why

the "tall" section should be more liable to breakage in transit than the square one; nor have we had any reports to the contrary.

### Notices to Correspondents & Inquirers.

All queries forwarded will be attended to, and those only of personal interest will be answered in this column.

E. C. R. W. (Salisbury).—*Open Classes at "Royal" Shows.*—Reference to prize schedule in to-day's issue shows that the omission of counties in Classes 391 to 394 was a printer's error, which is now put right. Referring to your wish for a few "open classes," it is too late now to consider any alteration for this year, but you might bring the suggestion before the Council of the B.B.K.A. in time for next year's show.

ENQUIRER (Essex).—*Medicating Bee-Candy.*—You will notice that the error has been already corrected in print. The quantity of cream of tartar is a teaspoonful not "tablespoon." The overdosed candy may be utilised in making syrup-food in spring, bearing in mind the proportion of "cream of tartar" it contains.

T. H. KABER (Kirkby Stephen).—*Honey Sample.*—As a granulated honey your sample is of good quality for table use.

R. DAVIES (S. Wales).—*Assisting Local Shows.*—While cordially wishing success to any effort in the promotion of honey classes at your local shows, we cannot promise financial help by offering prizes. To give help in one case would mean doing it in all, and this is obviously out of the question. 2. We have no doubt that there are Beekeepers' Associations in South Wales who would willingly advise you with regard to arranging details of your proposed honey show.

#### *Suspected Combs.*

J. P. (Wallingford).—*Cleaning Suspected Combs.*—1. Should it be quite certain there is no foul brood in the combs, it will do no harm to use them, if only slightly spotted with symptoms of dysentery. 2. We should not advise any attempt to clean combs badly spotted and from a stock that has died of dysentery. Melt them down for wax, as being more safe, and really more economical in the end.

J. T. (Kent)—1. We regret to say comb sent is badly affected with foul brood, and advise total destruction of the whole contents of the hive which the bees have deserted. 2. The probability is that the bees have formed on to one of your other stocks, so it will need watchfulness to see that no infection results.

\* \* \* *Some Letters and Queries are unavoidably held over till next week.*

## Editorial, Notices, &c.

### BRITISH BEE-KEEPERS' ASSOCIATION

It may be well to remind our readers of the annual meeting of the B.B.K.A., which takes place at 105, Jermyn-st., W., on Thursday, the 19th inst., and as the Report for the year 1902 will be presented, members present will have full opportunity for making remarks thereon prior to its adoption. Another item of interest will be the *Conversazione*, which follows the business part of the proceedings, after a short interval for light refreshments.

Members of all Bee-keepers' Associations are cordially invited, for friendly discussion and the interchange of ideas on such objects of interest connected with bee-keeping as may be brought forward for inspection. The business of the annual meeting concludes about 5.30, and the *Conversazione* opens as usual at 6 p.m.

### FOUL BROOD OF BEES.

By F. C. Harrison, Professor of Bacteriology.

(Continued from page 85)

REMEDIES (continued).

(8) *Eucalyptus*.—This substance was introduced by Beauverd (69). A small tin box, with a cover pierced with small holes, is placed upon the floor board of the diseased hive, and filled with essence of eucalyptus. The colony receives every four or five days a litre of syrup containing a teaspoonful of tincture of eucalyptus (oil eucalyptus, 1; alcohol, 9). Then from time to time some drops of the same tincture are dropped into the hive. Auberson, who was the metayer of Bertrand's aviary, and was managing his own higher up the mountains, cured a number of colonies by means of this method. He finds that there is a great difference in the effect produced by the remedy. In some cases, the effect follows the remedy quickly; in others, the effect is slower. Sometimes more than a year passes without resulting in a complete cure. When the disease is of long standing, the remedy must be proportionate to the gravity of the evil. When there are only a few diseased cells, Auberson simply pours some drops of the essence along the back wall of the hive. He renews the dose every eight days; and in six weeks, sometimes sooner, the colony is cured. In cases where the hive is badly affected, he takes a clean hive and floor board and impregnates the interior, floor board, and division board with eucalyptus, and then transfers combs, brood, and bees to the new hive. He leaves the foul-brood colonies their rotten combs, as this is the only handy means of disinfecting them. Three weeks later, during which he has twice poured

eucalyptus on the floor board, he examines the new brood. If it exists in healthy patches he simply pours a few drops of the essence on the floor board until the cure is complete. If, however, the fresh brood still disclose some diseased spots, the queen is killed and replaced by another, and every fifteen days the essence is spread on the floor board until the cure is completed. If the colony is very weak, he strengthens it by the addition of bees and healthy brood. If he has to feed a diseased hive, he never fails to put the essence in the syrup.

Besides these well authenticated cases of cure by the essence of eucalyptus, there are a number of others, and the method has been extensively used in Europe. The great drawback to the use of this remedy is that it is liable to cause robbing.

*Experiments on the Antiseptic Value of Eucalyptus.*—(a) Eucalyptus oil. The cotton plug of a spore-inoculated sloped agar tube was saturated with the oil, and incubated at 37 deg. C. In eighty-four hours there was no growth, but a fresh plug being inserted good growth occurred in twenty-four hours.

(b) Agar plates inoculated with spores and containing four drops of eucalyptus on a piece of blotting paper were incubated at 37 deg. C. No growth formed, but when the eucalyptus was removed good growth immediately ensued. On plates containing two drops the growth was restricted to the inoculation track, but when the oil was removed abundant growth took place. On plates containing one drop on blotting paper there was abundant growth in twenty-four hours.

(c) Eucalyptus agar was made by using a teaspoonful (4 c.c.) of tincture of eucalyptus to a litre of agar. Six plates were made with eucalyptus agar, each plate inoculated with spores, with the result that the growth on the medicated agar was only slightly less than that on the control agar. The medicated agar smelt slightly, but characteristically, of eucalyptus oil.

A Queensland (Australia) correspondent of the BRITISH BEE JOURNAL (71) is of the opinion that no foul brood exists among bees in that country. The reason of this is that the honey that goes into the combs is largely gathered from the eucalyptus, the medicinal qualities of which combat foulness in all forms. This statement, however, is not reliable, inasmuch as foul brood is known to be prevalent in Queensland.

(9) *Naphthol Beta*.—Naphthol beta was first used as a remedy by Lortet (72). The treatment is as follows:—

The drug is administered in the food, in the proportion of one-third of a gram to a litre. This one-third of a gram is at first dissolved in a little alcohol, as it is extremely insoluble in water. Afterwards it is mixed

(70) Revue Internationale d'Apiculture, 1891, p. 240.

(71) British Bee Journal, Vol. xxiii., p. 402.

(72) Revue Internationale d'Apiculture, 1890, p. 50.

in a litre of water, and this liquid is used for making the syrup. In England the usage is to dissolve the naphthol in the sugar, the proportion being about forty to fifty centigrammes to a kilo of sugar. It is, however, better to dissolve it in alcohol. Lortet thinks that external treatment by means of fumigation or spraying is helpful, as these methods contribute largely to the disinfection of hives, comb, &c. ; but as he believes that it is always the digestive canal of the nurse bee which is infected and that it is by the act of feeding that the adult bee infects the digestive canal of the larvae, therefore all efforts should be directed to the digestive canal of the worker bees, and the treatment ought to be internal and as energetic as possible. He states that when administered in the proportion of 0.33 gram per 1,000 of liquid it prevents all fermentation and decomposition and other changes caused by microbes. He further maintains that in addition to the use of this preparation first-rate hygienic conditions are necessary in order to give the bees vitality and recuperative power, which play an important part in enabling living organisms to resist the inroads of virulent microbes.

McKenzie found that (28) a beef broth containing one per thousand of naphthol beta prevented spores of *B. alvei* from germinating, and consequently had an equal value with one per 500 of carbolic acid.

This remedy has been widely used and with considerable success.

*Experiments on the Antiseptic Value of Naphthol Beta.*—Naphthol beta agar was made in our laboratory the same strength as that recommended by Lortet for feeding, that is 0.33 gram naphthol beta to one litre of agar. Eight tests were made in Petri dishes, inoculated with spores of *B. alvei*, and in no case did growth result; from which we learn that a dilution of one-third of the solution used by McKenzie completely inhibited growth. Naphthol beta agar containing 0.165 gram of the drug to a litre of agar was also tried, and the result of a number of tests was that some growth took place on the medicated plates and abundant growth on the control plates.

From these experiments, also those of Lortet and McKenzie, it will be seen that naphthol beta has a strong antiseptic action.

(10) *Naphthaline.*—This substance is regarded as a preventive rather than as a curative, although there are cases known in which it has effected a cure of diseased hives. A small quantity of the drug is placed on the floor-board of the hive, a crystal about 2 cm. in diameter as far from the entrance of the hive as possible. The evaporation is rapid and with very strong odour. Hence, if too much used, the brood will be deserted by the workers and death of the bees may take place. As soon as the dose has evaporated it is renewed.

As a preventive, naphthaline has been very

favourably reported upon by a number of writers; and Cowan (73) states that he inspected very thoroughly a hive belonging to Merney which had been cured by this substance.

*Experiments.*—In our laboratory, crystals of naphthaline, about the size of a large pea, were put into test tubes containing sloped agar, inoculated with one loopful of spores, capped with tin foil paper and kept at 22 deg. and 37 deg. C.

*Results.*—After forty-eight hours, good growth in all tubes. Inoculated agar plates containing a crystal of naphthaline likewise gave good growth in twenty-four hours at 37 deg. C., as did also the control tubes and plates. Hence, we conclude that naphthaline has no antiseptic power; and we are forced to look upon its use rather doubtfully. It may, perhaps, act as a stimulant.

(11) *Formic Acid.*—This substance was first suggested by Dennler in 1885 (74), but he did not ascertain the strength in which it could be used. Sproule (75) states that since the year 1882 he had successfully treated foul brood with formic acid. He was the first apiculturist to use the remedy and give the treatment. The solution used is pure acid, 10 parts; water, 90 parts; and the treatment is as follows:—

A part of the comb is taken from the hive and as many bees as possible are shaken from the diseased comb; and then two or three empty combs are used, into one of the sides of which 100 grams of the solution are poured, while it is held inclined so as to allow the liquid to run into the cells and stay there. These combs are placed on each side of the brood, the side containing the solution next the brood. Eight or ten days after an inspection is made; and if there is no cure, the dose is renewed and continued every week until the cure is complete, which is often after the first treatment. In fact, the disease rarely resists the second or third application. To hasten the cure, this remedy can be given in the food of the bees—a teaspoonful to a litre of syrup.

*Experiments.*—Formic acid probably has an important role to play in the keeping properties of honey. As long ago as 1878, formic acid was found in honey; and Muhlenhoff (76) observed that when honey is not intended for immediate use, the bee deposits in each cell a drop of formic acid, secreted by the venom glands and then seals the cell. Erlenmeyer (77) says that formic acid of the strength of 1 205 gr. to a thousand parts of water was antiseptic. Planta (78) refutes Muhlenhoff's idea that 100 grams of sealed honey contains

(73) Revue Internationale d'Apiculture, 1891, p. 165.

(74) Elsassisch Lothringische Bienen Zuechter, Nov. No., 1885.

(75) Bee Keepers' Record, 1889, June No., "Gleanings," 1890, p. 506.

(76) Eichstadt Bienen Zeitung, 1884, No. 6.

(77) Séance de l'Académie des Sciences de Munich, Feb. 6, 1875.

(78) Schweizerische Bienen Zeitung, 1893, p. 136.



0186 grams of 22 per cent. formic acid. "One hundred grams is the capacity of 165 worker cells, but the smallest droplet of venom contains at least 0.254 grams of formic acid, which would make for 165 cells, 4.1910 grams; that is to say, 200 times more than there is in reality." This opinion is, however, contrary to one expressed before by the same writer, in the year 1884 (79).

Formic acid seems to help bees to ward off the disease, especially when we supply it to them ready made; and that found in certain kinds of honey has probably an antiseptic effect. Two samples of clover honey and two samples of buckwheat honey were analysed in our chemical laboratory with the following results:—

1. Buckwheat honey, 0.15 grains of formic acid in 100 grains of honey.

2. Buckwheat honey, 0.17 grains of formic acid in 100 grains of honey.

1. Clover honey, 0.0579 grains of formic acid in 100 grains of honey.

2. Clover honey, 0.057 grains of formic acid in 100 grains of honey.

Formic acid agar was then made containing the same proportion of formic acid as was found in the first sample of buckwheat honey, and weaker formic acid agar containing the same percentage of formic acid as was present in the first sample of clover honey; and spores placed upon the stronger formic agar did not germinate, while on the weaker formic agar the germination was only slightly retarded; and after the weaker agar was two days in the incubator, there was a large growth. Spores transferred from the strong formic agar (after being in contact with it for six days in the incubator) failed to grow on the weaker formic agar within two days; but after four days in the incubator they grew abundantly. The culture growing on the weaker formic agar was then transferred to the strong formic agar, to ascertain whether the germ could be accustomed to more unnatural food by previous cultivation on the weak formic agar. This transfer was, however, unsuccessful.

The germs used in these tests were isolated from samples of diseased comb from Ontario, Austria, and Florida, U.S.A.

Formic acid bouillon was also made containing .15 per cent. of formic acid; and spores kept in this broth for eight months continued to germinate when transplanted to suitable material.

Formic acid was likewise made in the same proportion as suggested by Bertrand (59); that is, formic acid 10, water 90; and a teaspoonful of this mixture to a litre of syrup; but instead of syrup, agar was used. Fifteen c.c. of this acid agar was poured into each Petri plate, and the surface inoculated with spores.

Results: On 14 plates, no growth.

On 2 plates, very restricted growth, limited to one-eighth of an inch of the needle track (60 hours).

On control plates, abundant growth.

From these investigations, viz., the analysis of the honey, the experiments based thereon, and the tests with agar made in the proportion suggested by Bertrand, we would note three things: (1) That the amount of formic acid recommended by Bertrand for the cure of foul brood is almost identical with the amount found in buckwheat honey; (2) that formic acid is a good antiseptic; (3) that the formic acid in buckwheat honey may possibly tend more or less to ward off foul brood.

We may add that our analysis, showing a larger proportion of formic acid in buckwheat honey than in clover honey, is an interesting explanation of a fact well known among practical bee-keepers, viz., that the sting of bees when working on buckwheat is much more irritant than when working on clover.

In conclusion under this head, we may say that formic acid has given good results when used in the treatment of foul brood; and it is in a sense a natural remedy, being manufactured to some extent by the bees themselves.

(12) *Other substances used for treating this disease.*—Among other substances that have been used for treating this disease are sulphuric acid, sul-faminol, various modifications of substances already mentioned, and some recommended in the McLean method (80), the Muth method, and others; but these have not had so wide application as those referred to in the preceding paragraphs.

(Conclusion next week.)

## Correspondence.

*The Editors do not hold themselves responsible for the opinions expressed by correspondents. No notice will be taken of anonymous communications, and correspondents are requested to write on one side of the paper only and give their real names and addresses, not necessarily for publication, but as a guarantee of good faith. Illustrations should be drawn on separate pieces of paper. We do not undertake to return rejected communications.*

\*.\* *In order to facilitate reference, Correspondents, when speaking of any letter or query previously inserted, will oblige by mentioning the number of the letter as well as the page on which it appears.*

### AMONG THE BEES.

#### RADIO-ACTIVITY IN THE BEE-HIVE.

[5053.] Waves of different degrees of force and intensity pervade and permeate the atmosphere. Our surroundings are full of wonderful rays of all kinds striking our globe, and affecting us and every atom thereon. Sound waves enable us to converse with friends hundreds of miles away almost as familiarly as if they were in the same room. Magnetic currents allow us to put a girdle round the globe in forty minutes," and flash news from all parts of the world. Marconi's

(79) Schweizerische Bienen Zeitung, 1884, p. 89.

(80) Report of the Department of Agriculture, Washington, 1816, p. 584.

great electro-magnetic waves enable him to transmit messages all over the universe, independent of the old, but soon to be superseded, electric wire. Nature is all a-quiver with light-waves, heat-waves, and sound-waves, which permeate all space. Many of these are (or are in process of being) bridled and controlled, and made subservient to the service of man. Great forces these are, yet so under the control and guidance of their master that they become his willing servants, and toil and spin for him untiringly. Then we have Rays of all kinds being discovered—Cathode Rays, Röntgen Rays, Niewenglowski Rays, Becquerel Rays; and out of these last is evolved the subject I have taken in hand to-day. This (RADIO-ACTIVITY) is a new force or energy, indistinctly understood as yet, but pregnant of much marvel-working in future. Its originating source no man knows, though probably it has existed from the first of time, slumbering until now; but, once discovered, never again to disappear—for these rays are a property of matter which is indestructible. The source from which we obtain them is a substance whose natural property it is not only to emit, but also to manufacture them. Not only so, but it has the ability to transmit this power and activity to surrounding bodies, and the kind of substance exposed to its action is almost a matter of indifference, as it acts on *everything*, and these objects acquire from it a Radio-activity of their own. Though this is not eternal in its abiding power as in the generating substance, yet it is sufficient in strength and intensity to make it persist for many hours with a power capable of exerting a new and intense energy and added activity, a powerful vitality, a new and additional force.

Fancy a small atom of this energising vitality introduced to the dark interior of a beehive, and acting powerfully on several thousands of naturally busy and active insects already overbrimming with energy, shedding a glory hitherto unknown on the precincts of the domestic hearth, covering each insect in a halo, and conveying to each a part of its own Radio-activity, energising and vitalising them with a power of motion, speed, and life, an activity, alertness, and force hitherto undreamt of. What zeal and earnestness of purpose, what untiring power of labour, what an added force of character they would acquire, and what noble deeds and endeavours this energy would urge them on to. Brood-raising would progress at an accelerated speed, as their powers would be greatly augmented, being doubled or quadrupled at least. The queen would be energised into almost fabulous egg-laying powers, each larva would be intensified in all its vital parts from the moment of hatching, and, no doubt, it would acquire new powers and capabilities in building and developing each cell of its body, so as to evolve a more complete and perfect insect from the resultant pupa, which would break

its covering earlier, and at the same time more mature, being immediately able to begin fighting life's battles.

Every one of the 60,000 bees in a well-regulated hive would be a new centre of generated Radio-activity, endowed with its own share of this magic working force. Its alertness of motion and locomotion would be intensified and glorified by the potency of the added energy, while its skill in flight would be multiplied many fold, and its added powers of endurance and ability to withstand fatigue would make it almost independent of all climatic influences. Think of it my enthusiastic bee-keeping brethren, how such a marvellous increase of activity would magnify and multiply the bees' already astonishing industry, enabling it almost to annihilate time and practically bridge over space. Think how the vitalising force would help it to overcome present difficulties, enabling it to forage when it pleased, to load up at a vastly accelerated rate of speed, with increased storing capacity, and with an ability to carry much heavier loads of nectar on each journey. It would all be a question for the bee-master (what a high-sounding title!), as whenever he placed the almost infinitesimal atom of the potent Radium in the hive, the bees would become his willing slaves and *must* obey his will, until he chooses to withdraw it, and thereby calm and soothe them into rest and non-activity.

All past methods, schemes, inventions, and improvements must sink into insignificance compared with this new and grand discovery, which, if carried out successfully, will revolutionise bee-keeping. No patent is to be applied for, and no provisional protection is to keep this wonderful revelation one single day from all apiarists. All can have the right to experiment with this wonderful boon and blessing free, gratis, and for nothing!—  
D M. M., *Banff*.

(Correspondence continued on page 96.)

## HOMES OF THE HONEY BEE.

### THE APIARIES OF OUR READERS.

Mrs. Spencer—whose apiary is shown on next page—is in every sense a lady bee-keeper of the best type; one whose enthusiasm is supplemented by the intelligence necessary for success, and without which enthusiasm counts for nothing. It was our good fortune to meet Mrs. Spencer last autumn at a honey show of the Hunts B K A., of which Association she is a warm supporter, and it needs only a talk about "the bees" to realise in her the possession of the natural aptitude which wins prizes at shows and makes bee-keeping profitable.

In response to our own expressed wish to include Mrs. Spencer's apiary in our beegarden pictures, we have been favoured by the permission of the eminent photographer, Mr. Chas. Reid Wishaw, N.B., to reproduce the

photo seen, and for the rest we need add nothing to the interesting "Notes" written at our request as follows:—

"The story of my bees is a short one, and does not possess much incident. It begins much as fairy tales usually end—'They all got married, and lived happy ever after,' which, being interpreted, means that the queen bees' honeymoon over, they set up housekeeping, and all went well. Mistakes, of course, on my part have occurred at intervals. The intervals seem now to be of longer duration than when I first undertook the management of my apiary three years ago, and I feel that I am outgrowing my novitiate. This apiary was started in 1894 by one of my sons, now in

Somehow, one of my stocks had contracted a cross with a Ligurian strain, and so vicious did they prove that Mr. Brown recommended me to get rid of them. I did not, however, do so, and, strange to say, they during last year developed an almost perfectly angelic temperament, besides which they have proved most industrious.

"The first year, with my apiary 'on my back,' was a sad one. Oh! the silly mistakes I made, too silly to record; and, oh! the stings I got, so that deep within my heart grew the thought, 'Shall I be able to go on with my bees, or must I give them up?' This thought I nipped in the bud, and the outer world never guessed that the seeds of doubt



MRS. SPENCER'S APIARY, HOLYWELL, ST. IVES HUNTINGDONSHIRE.

South Africa, who went away in 1899, when I took it over. It consisted of seven stocks: I had assisted him continually, and so had gathered a few grains of knowledge, but I have since found out that to assist without any burden of responsibility is quite a different matter from having the whole apiary 'on my own back.' My back would probably have broken had it not been for the willing helpfulness of Mr. R. Brown, of Somersham, who would fly here, so to speak, almost as quickly as one of his own bees to aid me in any difficulty. Once I feared I should tire his patience, so very troublesome was I; not only so, but my naughty bees *went* for him, and gave him 'what for' more than once.

had ever germinated, for in its place there grew another and a greater one—enthusiasm.

"If any one were to ask me the question, 'How to start an apiary?' or, 'How to manage the honey bee?' I should give them this recipe:—'Take four parts of enthusiasm, add one part of common-sense, one part of perseverance, one part of courage; mix well in the mortar of time, and bottle for use, applying, as occasion may require, with the brush of patience.' With such a mixture one must, I think, succeed.

"Although my success is small compared to that of many another apiarist, I have succeeded in the past, and, as a proof of this, I may state that my bees pay. In 1901, with only

ten stocks, and one of those a straw skep, I was £11 richer in my pocket, and quite eleven times better in my health. The 'health' I consider ample recompense for my time, and so the £11 is clear profit; this, too, with only fairly good management, for I see plenty of room for improvement.

"I got as much honey in 1902 as I had in the previous year, which, in such a season as we all experienced last year, tells me that my management has improved, or I should have fared as my neighbours have, which is badly, many of them having only a few pounds of surplus honey.

"Just now I am having a slight attack of 'show fever,' for in the course of the year I have taken first prize for extracted honey gathered in 1902; second prize for sections, 1902; third prize for extracted honey, 1902; third prize for sections, 1902. Another year I may do better or I may do worse, 'I cannot be positive which.'

"I will not end my story without giving the reason for the name of my apiary, 'St. Oswald's,' which has brought forth many an inquisitorial remark. I have read that Oswald, King of Northumbria (*d.* 642), allotted and gave a portion of ground here on which to build a church, and endowed the same with lands. This fact is being gradually lost sight of, but 'as it was told to me in truth, I tell it so to you.' I reverence our ancient traditions, and in honour of that of this old and interesting village of Holywell I have christened my apiary St. Oswald's. May the name awaken in this present age the desire to possess the same virtues which he possessed, the most important being to benefit his fellow-men, and a persevering energy to overcome difficulties and hew down obstacles."

### CORRESPONDENCE.

(Continued from page 94.)

#### THE "ROYAL" SHOW OF 1903.

##### THE "NEW DEPARTURE."

[5054.] Now that the country has been divided into sections, or groups of counties, and prizes allotted to each section, it is to be hoped that the advantages and encouragement this new departure is intended to bestow will not be marred at the outset by those who have in your pages been termed "prize-hunters." That this is not unlikely to happen, a recent letter in the B.B.J. (5039, page 67) plainly shows. The writer—"A Beginner," he styles himself—with eleven prizes out of twenty-three entries last season to his credit, inserts a query as to whether he could exhibit in two groups, showing distinctly that it is not this novice's intention to stop at the twenty-three entries in future, nor to confine himself to one group, if possible. I was, indeed, surprised, on reading your footnote, to see that you did not at once, though unofficially, put your editorial foot—pen I mean

—down with a crash on the intending culprit; and respecting your remark as to "showing the produce in the county group in which it is gathered" if the stocks mentioned are only just over the border, the produce, it strikes me, will be a blend of two county groups; but perhaps the "gathered" you mentioned refers to the bee keeper's part of the work, and not to the bees part. In this case I enter my protest at once, and state distinctly that if the above departure is to succeed, and the "long felt grievance" you mentioned in your editorial last week, removed, exhibitors must be confined to the district in which they reside.

Some valuable and very appropriate remarks were made by our Editors a few weeks ago about removing a temptation out of the way of bee-keepers with regard to another matter then under notice—viz., invert sugar feeding. And if bee-keepers are to be allowed to exhibit out of the district in which they live, then what about the temptation to the noted winners of the present day—appliance dealers, honey merchants, &c., included—whose position enables them to obtain samples of honey not obtainable everywhere, to dot a hive or two in the apiaries of their customers all over the country, and get the honey—jars or sections—mixed with their best accidentally for show purposes when they arrive at headquarters? Also, what would a Welsh, Scotch, or Irish visitor to the "Royal" think, knowing that the country had been divided into groups, if he saw the prizes for these divisions awarded to London or Berkshire bee-men?

To further illustrate my point: A noted Berkshire prize-winner need only place a hive of bees into his neighbouring counties of Oxford and Wilts to enable him to exhibit in three county divisions.

It is apparent that if the B.B.K.A. council do not immediately pass a rule, confining the prizes to *residents* in the different districts, they may abandon, once for all, their otherwise excellent effort to encourage the bee-keeping fraternity as a whole.

Finally, in the interests of the new movement, let me appeal to those experts and advanced bee-keepers, whose names figure in nearly every prize-list that appears in the columns of the B.B.J., to be content with furthering the best interests of apiculture in their own districts, and if, as appears to be the case with the writer of the letter referred to above, they have a subscription to spare, pray send it up to the offices of the B.B.K.A., to enable the Council to remove that heavy burden on their finances, and increase the prizes in each division to three cash prizes instead of two, as at present, and thereby merit the thanks and approbation of ardent members of the B.B.K.A. like—BRIDGEFIELD, *Wales*.

[On the other side, and as a question of equity, would it not be somewhat hard for a

bee-keeper who subscribes to two County Associations, and has an apiary in each, not to be allowed to compete in both?—EDS.]

### “SHOWING” AND “DRIVING” BEES.

[5055.] I beg to thank your correspondent, “W. B. West” (5041, page 68), for his well-meant and kindly expressed notes on “confining bees at shows,” in which he makes an appeal to all true bee-keepers on behalf of what he terms the “unhappy bees.” But “every cloud has its silver lining,” and thus a gleam of light appears around his somewhat too dark view of the case.

From time to time in the pages of the B.B.J. various bee-keepers have written with regard to showing, dealing with observatory hives, and also on demonstrations in bee tents, where “bee-driving” is, of course, a main feature.

One instance, reported on page 399 last year, is the account of hundreds of children from various East End schools in London passing before an observatory hive, and having same explained by Miss Hall, curator of the Stepney Borough Museum. Another is a grateful letter from one who had witnessed Mr. W. Herrod driving bees at the Royal Show, Cardiff, in 1901. At the “Royal” shows held annually there is a class for observatory hives, but those shown there could not by any stretch of the imagination be called “bee-killers.” Mr. Dixon’s hive, in particular, was well ventilated, partly shaded, and the bees were flying all the time.

I may also say, with regard to the bees which were “driven” by Mr. W. Herrod in the bee tent, these bees could not be labelled either “homeless” or “lost,” having been placed on stands not more than 20 yds. from the tent three days previous to the first driving operation. Nor should we lose sight of the valuable object lesson which both of these features provide.

Notice also the crowd of interested spectators around the driving tent, even while there are other admittedly more popular attractions, such as horse-leaping, &c., going on in the large ring close at hand. The crowd, by seeing the lecturer handling bees, are shown how they may keep bees as a domesticated insect in their gardens, and not now be either deterred or appalled by the thought of stings. Surely such demonstrations deserve our support, at least till better methods are found to replace those of the present day.

Rural depopulation is now becoming a serious matter, and calls for the fullest attention; and, although bee-keeping will not keep a person in the country, it is surely one means towards that end, and should we not avail ourselves of such means as are at hand?

I am not overlooking the kindly spirit in which Mr. West’s notes are written, because, like myself, he has passed the elementary

stage of bee-keeping. Yet we must look ahead, and consider the thousands who are commencing, or who may be awaiting the opportunity to do so.

Times out of number we see questions from beginners in the pages of our JOURNAL, and we wonder at the unwearied patience and tact displayed by the Editors when replying to same.

Observatory hives at shows and “driving” in the bee tent are undoubtedly given deserved prominence as elementary lessons in bee-keeping, and although there appears to be a species of more or less of cruelty in them yet it is in a great degree imaginary, and certainly far less cruel than many of our fashionable and popular pastimes, such as racing, hunting, shooting, fishing, and others.—JAS. WADDELL, *Expert, B.B.K.A., Wooler, Northumberland.*

### DESTROYING CONDEMNED BEES.

[5056.] Referring to the method of destroying condemned bees detailed by your correspondent, “E. H. T.” on page 77 of BRITISH BEE JOURNAL February 19, I think my own plan is a very simple one, and is not so “messy” as using paraffin. Any way, I find it easy, quick, and effective to proceed as follows:—Take an ordinary bee-smoker and fill with brown paper in the usual way; have ready also a teaspoonful of powdered sulphur. In the evening of the day on which you operate close the entrance of the condemned stock to about 1 in.; get the paper in smoker well alight, then take off the top, after pouring in the sulphur, and vigorously puff the fumes in at the hive entrance. Then close the doorway; a loud hum will be heard, followed by complete silence and the stillness of death! for all is over; the bees will be dead!—F. J. G., *Sidmouth, February 21.*

### SECTION-RACK AND SHALLOW- FRAME BOX.

[5057.] As a further reply to your correspondent, “J. R.,” whose letters are dealt with on page 68, I would advise him to cut his shallow-frame boxes down by running a pencil line all round,  $\frac{3}{4}$  in. from the bottom, sawing off near, and planing to the line. He then has a “W. B. C.” section-rack for  $4\frac{1}{2}$  in. by  $4\frac{1}{2}$  in. sections. Then make an “eke” or frame  $\frac{3}{4}$  in. deep, two sides of which frame are  $1\frac{5}{8}$  in., and the other sides  $\frac{3}{4}$  in. wide, and of an inside width the same as the rack.

Attach the eke to the rack with ordinary screws, placed  $16\frac{1}{2}$  in. apart, through the wider sides. He will then have a shallow-frame box. (Is not this part of the original “W. B. C.” rack, will our Junior Editor kindly say?) The reason for the special dimensions given for screw-holes is to enable one to add any “eke” to any rack.

I use the above entirely, and its advantages

are:—1. No need to decide how many section-racks or how many shallow-frame boxes will be required. 2. Used without the "eke" it will take  $4\frac{1}{4}$  in. by  $4\frac{1}{4}$  in. sections, and at the same time  $4\frac{3}{4}$  in. shallow frames (these being easily reduced) fitted with section foundation, and placed, say, four on each side of four hanging-frames, for sections will be found to answer well for the heather flow. 3. Used with the eke it will take ordinary shallow frames, and at the same time the 5 in. by 4 in. sections in hangers, as the Rev. R. M. Lamb suggests. So the one rack answers all purposes.—GEORGE M. SAUNDERS, *Keswick, February 23.*

[The plan of using a frame below the "W. B. C." section-rack in order to permit the use of the latter for shallow-frames has been illustrated in Mr. W. P. Meadows' catalogue for a year or two past.—ED.]

#### RAILWAY RATES FOR HONEY.

[5058.] Before bee-keepers and associations are "up and doing," as Mr. Woodley puts it on page 74, regarding this question, I should like to ask where the gain will come in by raising the whip at railway companies on a question of carrier's risk? We all know that the rates per goods train are classified according to value, risk in transit, &c., &c., of the goods carried, and at present honey in tins, casks, &c., is classed "third class," and comb honey, which requires the greatest care in handling, is classed "fourth class," only one point higher, and the railway companies, after, no doubt, having to pay heavy claims for damage to comb-honey, resulting generally through bad packing on the part of the sender, have sheltered themselves by only carrying at "owner's risk." A very sensible idea, too, for who would send comb honey by a shunting, bumping, goods train, and expect it to reach consignee in perfect condition. Before we commence to tackle railway companies on this question, let us consider what we alone as bee-keepers at present enjoy at the hands of the railway companies; I mean the great privilege of sending honey exhibits to shows at half ordinary parcel rates at owner's risk. Compare this with the poultry, pigeon, rabbit, cheese, butter, cream, or horticultural exhibitors, who, although willing to have his often heavy exhibit carried at O.R., must pay full ordinary parcel rate, often a penny per lb., in each direction, the half-parcel rate only applying for conveyance of their goods went sent "For consumption." Mr. Woodley would do well to dot up his carriage charges on exhibits to shows during 1903, and add 100 per cent. to make up the difference if he was put on an equal footing as regards rates, with other exhibitors, and when he has to pay them in reality, he could then talk and write of unique instances of railway companies throttling a small growing industry.

I enclose my card, but beg to sign myself—  
X. Y. Z., *Yorks, February 28.*

#### GLEANINGS FROM FOREIGN BEE PAPERS.

BY R. HAMLYN-HARRIS, D.S.C., F.E.S., F.Z.S.,  
F.R.M.S., A.P.S., ETC.

*Bienenwirtschaftliches Centralblatt.*—Propolis is the name given to a preparation extracted from propolis, which is said to have become one of the most important means for the cure of wounds, sores, &c.

Any person having once tried it will testify to its value, and to the efficacy of its power to heal. It is neither poisonous, nor sharp and biting in application, and it is produced from propolis only, by dry distillation, having a not unpleasant smell, slightly resinous and oily.

Propolis has been the means of healing old wounds of ten years' standing, and if promptly applied to fresh injuries it entirely prevents blood-poisoning. It is, therefore, a very useful home remedy against wounds and insect stings, and therefore especially to be recommended to bee-keepers, as if the hands are well rubbed with it before manipulating, the operator is safe from stings.

*The Same.*—A correspondent of the *Revue d'Apiculture* remarks that through the introduction of a new queen belonging to a good-tempered race of bees, even the workers from the old queen become gentler and less desirous to sting. An American bee-keeper corroborates this statement, and says he had several times had vicious colonies whose queens he had replaced by those of a more manageable race, and he found that after two or three weeks the whole population of the hive seemed quite gentle and amiable. Had the presence of the new queen changed the character of the working bees?

*The Same.*—An experiment made in the autumn of 1898 with three colonies of bees proves that no brood can be reared without pollen. Honey alone, sugar and honey, and sugar syrup enabled the hives to pass the winter successfully, but in the early spring great restlessness showed itself, which, however, entirely ceased after a comb full of flour had been given them. The next day eggs were visible in each hive.

*L'Apiculteur.*—An easy way of detecting queenlessness in a hive is said to be—if drones are still found late in the year—to take some of these and crush gently one by one. If they contain no trace of food the hive has a queen, but otherwise it is queenless, as the bees only feed the drones during swarming time, or in case of orphanage. The receipt is simple and worth trying.

*Rucher Belge.*—A perfect flower is composed of, first, the exterior envelope or calyx, sometimes only a tube, sometimes separate

leaflets called sepals. Second, an interior envelope or corolla, generally more or less brilliant in colour, and which, like the calyx, is formed either of a tube or of separate leaflets called petals. Third, one or more stamens, consisting of a stem surmounted by an anther, in which pollen is produced. Fourth, the pistil or ovary in the centre of the flower, which contains one or more grains. The pistil is made up of a stalk or style and a stigma which receives the pollen for the fertilisation of the flower.

Nectar is distilled by various parts of the flower. The difference of amount is often great in the flowers of one and the same variety, as, for instance, in the ranunculus family. The nectar glands are found on the calyx in some peonies, on the petals in the buttercup and hellebore, and on the stamens in the rose campion, on the ovary, as in the marigold.

The scent and the nectar attract the bees to the flowers. They are even said to distinguish colours.

Nectar accumulates slowly in the flowers, and depends on the temperature and on the time of the day. It is deeper in the calyx at some time than at others.

The pollen of the plants lodges in the hairs of their hind legs, as in a brush.

Few plants of the *Ranunculaceæ* are visited—clematis for pollen, hellebore and larkspur for their nectar. To reach the nectar of the larkspur the bee has to work in the space between the upper and lower petals. The stamens and pistil are placed below this space, and as the former become mature they rise successively, and their anthers pass across the space, so that the trunk of the bee, in searching for honey, must come in contact with them and receive their pollen.

Three varieties of reseda are visited, both for honey and pollen.

Violets are visited by the bee, which coming in contact with the stigma causes it to open and shed its contents on the head of the insect. The sepals of the flowers of the lime tree distil nectar, which is easily accessible to the bee; the flowers being pendant are protected from rain.

It may be remarked that some flowers close during rainfall, which prevents their honey and pollen from being washed out. The black alder has flowers disposed in bunches of two or three. In working these the bee touches the stamens with one side of her trunk and the pistil with the other. Red clover is not worked by the hive bee as a rule, but hybrid clover and white clover are much visited, and afford excellent bee pasture both as to honey and pollen. Sainfoin, vetches, melilotus are also much visited. The cherry and plum tree are rich in pollen and nectar, and the bees help in their fructification, as also of the raspberry and blackberry. The apple tree and hawthorn yield nectar. The stigma arrives at maturity before the anther.

## Queries and Replies.

[3038.] *Moving Hives Fifty Yards in March.*—I have a few hives of bees in a small garden belonging to the house, and I wish to move them to a more suitable place about fifty yards off. Between the garden and the proposed new location there is an oak fence and a thick plantation. Moving the hives by small stages would be impossible, and it would not be worth while taking the hives to a distance for a few weeks and making the change when returning them. This leads me to ask: Can I, before the season begins, make the change by one direct move, without serious loss of bees?—SUBURBIA, Hendon, March 2.

REPLY.—Some loss of bees is sure to follow a move of only fifty yards in March. The loss may, however, be minimised if the appearances of the hive-fronts are altered temporarily—say, by placing a branch of a tree across the flight-board, so as to check free flight somewhat, and cause the bees to notice the change as they take wing. Every day's delay now will tend to increase the mischief, therefore the sooner the hives are moved the better.

[3039.] *Bee-keeping in Canada.*—I write on behalf of three good bee-keepers and myself who are off to Canada this spring to take up farming. We are going right up country, thirty miles from Winnipeg. Can you tell us if we shall find wild bees, and so get them to hives? Or is it possible to buy stocks out there? I have sixteen stocks now, mostly pure Italian, and would like to take one with me, but I suppose that is impossible. Thanking you for all the good your valuable JOURNAL has been to us.—T. L., Barnett, N., February 19.

REPLY.—It would be worse than foolish to trouble about taking bees to Canada, when everything required in up-to-date bee-keeping can be had at reasonable rates on the spot. If you care to read about the prospects of bee-farming in Manitoba and the condition of the honey market at Winnipeg, we will be very pleased to lend you our file copy of the *Canadian Bee Journal* for November last, in which appears some interesting and useful "Notes" regarding bees and honey in the above-named province, and particularly about Winnipeg as a honey market.

[3040.] *Using Combs from Hives in which Bees have Died.*—On examining my hives the other day, I found the bees in two of them had died, and as there were very few, I put it down to queenlessness. What honey was left in the combs the other bees had carried off; and as none of the combs are very old, I thought they could be utilised for swarms; but wishing to run no risk of foul brood, I enclose a sample of comb from each hive for

your inspection. Will you kindly inform me if it would be safe to use these for swarms. I may say I am a bee-keeper of several years' experience, and have never yet had foul brood in my apiary.—W. P., *Hants, February 24.*

REPLY.—There is no trace of any brood in either sample. The cells contain nothing worse than pollen, some of it being mouldy or mildewed.

[3041.] *Bee-keeping in Canada.*—1. Can you tell me whether in the North-West Provinces of Canada, that are being boomed so at the present time, bee-keeping is carried on, or could be carried on, or if the winter is too severe to permit of it? 2. I think I have seen some reference made in the B.B.J. to a Canadian bee-paper. Can you give me the name, price, and where it can be obtained? Kindly reply in B.B.J. to W. H., *Berks.*

REPLY.—1. See reply to "T. L.," p. 99. 2. The *Canadian Bee Journal* is published monthly by Goold, Shapley, & Muir, co. Brantford, Ontario. The price is 1 dol. per annum.

### Notices to Correspondents & Inquirers.

All queries forwarded will be attended to, and those only of personal interest will be answered in this column.

"JIM" (Ipswich).—*Hive Making for Beginners.*—1. As one who is only "thinking of starting bee-keeping" and asking our help, we strongly advise reading up the subject before beginning to make your own hives; otherwise it is pretty certain that much of your time and money will be wasted. 2. We have no knowledge of the "working drawings" of the hive referred to as appearing in *Work*, but if the *inside measure* with which you are acquainted is adhered to, the double-walls and the outside dimensions, generally, of hives, are matters for the bee-keeper himself to adopt as his preference or his pocket may dictate. 3. With copies of B.B.J. as written for, and presumably, also, a copy of *Work* available, the best course will be to "pay your money and take your choice," as the saying goes. Our own opinion as to "which is the best hive to use" is so well known that it goes without saying where our preference lies; therefore, please take our opinion for what it is worth, and no doubt your own intelligence will guide you aright in selecting.

GOREYITE (Jersey).—*Variation in Granulation of Honey.*—The respective samples of 1900 and two following years' honey are from the same source, the difference in granulation being probably due to the climatic conditions under which each year's produce was gathered. The quality is poor in colour and rank in flavour, but all the samples are well ripened and of good consistency. They would do well for making honey cakes or sweetmeats, owing to the strong flavour. We congratulate our

venerable correspondent on his continued interest in the "bees," and send best wishes for his seventy-sixth birthday this month. The promised "photo of his apiary and self" will be welcome for our "Homes of the Honey Bee."

A. YOUNG HAND (Abergele).—*Weights of Merchandise.*—1. Avoirdupois weight (16 oz. to 1 lb.) is used for all merchandise sold by weight, troy weight being only used for the precious metals and precious stones. The chemist, therefore, stands on the same footing as your grocer in the matter of buying either beeswax or honey from you. 2. Give the bees a 2-lb. cake of soft candy now, and when this has been consumed it will be time to start syrup feeding. The candy may last three weeks or a month. When leaving home in April you might give a 2-lb. jar of syrup if food is short.

C. J. CALVERT (Bath).—*Shows to Come.*—A nominal charge of 2s. 6d. is made for notice of honey exhibitions in our "Shows to Come" column. This covers cost of continuous insertion until the show takes place.

W. J. H. (Norfolk).—*Quality of Honey.*—Sample sent is not a good honey for table use. It is rank in flavour and coarse in grain. Having been supplied eleven months ago to your customer it is very late in the day to complain of its quality now, as it shows signs of fermentation, and may have been kept in an unsuitable place to cause the deterioration.

REN (Smarden).—*Shallow-Frames for the Show Bench.*—It is immaterial whether drone-cell or worker-cell foundation is used for these. The points are to have the combs attached to the wood on all sides, and as few unsealed cells as may be. The comb-capping should be even and of good colour, and also project slightly beyond the frame for convenience of uncapping.

F. T. (Wolverhampton).—*American Bacon-boxes for Hive Making.*—1. In view of the difficulty of ensuring dryness in wood saturated with salt, we should prefer to use other material. 2. Salt would have no injurious effect on bees.

A. T. WEST (Yorks).—*Observatory Hives.*—Our recollection of the working drawings for making an observatory hive to which you refer is not favourable to their use, in view of what are known as really good and effective hives for the intended purpose.

D. H. F. (Alton).—*Bee Candy.*—Your sample is very good for present use, but it lacks the smoothness of grain found in *fondant* sugars (such as are seen in chocolate creams), that keeps the candy soft and "buttery" for a long time.

\*.\* Some Letters and Queries are unavoidably held over till next week.



## Editorial, Notices, &c.

### FOUL BROOD.

The conclusion of Professor Harrison's valuable paper on "Foul Brood of Bees"—begun on page 31—appears below; and, as mentioned in our issue of January 22 last, our Senior Editor, Mr. Cowan, has translated an almost equally important paper on "The Microbe of Foul Brood" by Dr. Ul. Lambotte; we publish the first portion thereof on next page. When completed, the whole will form a comprehensive and reliable compendium of the whole subject. In view of the absurd theories put forth at times by, no doubt, well-meaning persons whose mere surface-knowledge is at times more mischievous and harmful than entire ignorance, it will be a relief for those desirous of gaining really useful knowledge on this *bête noir* of bee-keeping to have within easy reach so authoritative and reliable a contribution to the literature on the subject for reference.

### FOUL BROOD OF BEES.

By F. C. Harrison, Professor of Bacteriology.

(Concluded from page 93.)

#### EXPERIMENTS ON THE USE OF DRUGS FOR COMBATING THE DISEASE.

I have already mentioned that, in one of my experiments, I endeavoured to find out if the virulence of the germ was attenuated by prolonged culture in artificial media, with the result that considerable attenuation occurred after a large number of transfers; and in the following experiments I have endeavoured to meet any objections that might be made as to the virulence of my cultures, by isolating *B. alvei* from a badly diseased hive and then growing at once sufficient spores for the purposes of the experiment. Thus but three transfers from a diseased larva were made; and all the spores used in the following experiments were obtained in this manner:

Two small hives, each containing strong healthy swarms, were selected and placed side by side.

Hive A was given spores of *B. alvei* in syrup containing one-third of a gramme of naphthol B. to a litre of syrup.

Hive B was given spores of *B. alvei* in syrup containing from 1.6 to 1.8 cc. formic acid to a litre of syrup.

The spores given were scraped from the surface of an agar slope culture, put into 10 cc. of sterile water, and well shaken in order to obtain a good suspension of spores. The water and spores were poured into medicated syrup and the mixture thoroughly stirred. It was then given to the bees, and was readily accepted. This procedure was continued four days a week for three weeks, and at the end of

this time each hive had received the whole of the growth from twelve sloped agar tubes. During the feeding period the combs containing the brood were carefully examined, but none of the usual symptoms of the disease appeared, although cultures were obtained from different parts of the hives and from the digestive tract of the workers. At the end of three weeks the medicated syrup was discontinued for a week. Then ordinary syrup containing spores was given, and at the end of ten days typical symptoms began to be noticed, and after sixteen days the disease was well established. Both hives, so far as I was able to judge, were the same—no disease to be seen in either whilst medicated syrup was fed, but infection manifest in both soon after the formic acid and naphthol B. were discontinued. This experiment goes to prove the benefit of feeding with syrup a substance which is antiseptic and which hinders the germination of the spores. It also confirms Lortet's opinion that the digestive canal of the nurse-bee is alone infected. I have never been able to obtain Cheshire's results, viz., the isolation of the bacillus from the blood of the worker, but I have frequently found it in the digestive canal of bees from diseased colonies.

From the results of the above experiments I conclude that in certain cases the use of chemicals is beneficial, but I would not say that other measures, such as starvation and stamping out, should be abandoned as unnecessary or useless. Some of the drugs used are of very little, if any, value; but others, such as formic acid and naphthol B., are undoubtedly very useful. In some cases, especially those in which the disease is very virulent, it may be advisable to resort to more drastic measures.

#### TOXINS.

I endeavoured to find out whether or not the feeding of toxin (filtrate from a two weeks old culture of *B. alvei* in saccharose bouillon) mixed in syrup would enable healthy bees to withstand the disease. Small amounts of this filtrate were given in syrup to a healthy colony every other day for three weeks. The amount of filtrate fed was gradually increased, but as the amount got larger the bees refused to take it, so it had to be poured over the combs. At the end of three weeks spores of *B. alvei*, freshly isolated, were fed, and symptoms of the disease followed about fourteen days later. So the toxin had little or no effect, but further experiments are being made.

#### LEGISLATION.

In the United States, six States have laws for the suppression of foul brood among bees. These are New York, Wisconsin, Michigan, Utah, Colorado, and California. In Canada, the Province of Ontario has enacted a foul brood law. In Europe Mecklenburg also has a law.

These statutes differ a good deal from one another, and some of them are so drafted that evasion of the law is easy. The best are pro

bably those of Wisconsin and Ontario, and the principal points in these acts are as follows :—

1. The appointment of an inspector.
2. The inspection of all apiaries reported as diseased, and the duty of the inspector, if satisfied that the disease is present, to give full instructions as to treatment.
3. The enactment requiring the inspector, who is sole judge, to make a second visit to all diseased apiaries, and, if need be, burn all colonies and combs that he may find uncured.
4. Various penalties (fines, and in default, imprisonment) for—
  - (a) Selling or giving away diseased colonies or infected appliances.
  - (b) Selling bees after treatment, or exposing infected appliances.
  - (c) Obstructing the inspector.
5. Persons who are aware of the disease, either in their own apiary or elsewhere, are to notify at once the proper authorities, and in default of so doing shall, on conviction, be liable to a fine and costs.
6. The inspector of apiaries to make an annual report, which shall include a statement of the number of colonies destroyed by his order, the localities where found, and the amount paid to him for his services.

(S1) Revue Internationale d'Apiculture, 1900. No. 9.

## INVESTIGATIONS RESPECTING THE MICROBE OF FOUL BROOD.

A DISEASE OF BEES.

By Dr. Ul. Lambotte.

Made in the Laboratory of the Institute of Pathology and Bacteriology of the University of Liège, Belgium. Published in September, 1902, in the *Annales de l'Institut Pasteur*.

Like silkworms, whose maladies were the objects of Pasteur's special studies, other working insects, such as bees, are subject to various diseases, of which the most dreaded by bee-keepers is foul brood.

This malady has been known for centuries, and, according to F. C. Harrison,\* who has published the most complete bibliography of foul brood that we possess, the great bee-keepers of ancient times, even at that remote period, dreaded this veritable pest of apiaries.

Nearly all bee-keepers now know how to recognise foul brood, which by preference attacks the larvæ during their development. In a hive it is easy to know cells containing diseased larvæ by their darker cappings, depressed in the centre, and often pierced by a small hole, due, some think, to the escape of gas generated by the diseased larvæ. On removing the capping, instead of a beautiful live, pearly-white larva, one finds a flabby, yellow, or yellowish-brown, mass, and, at a

more advanced stage of the disease, even nearly black. This ailing larva is sticky, ropy, and discharges a nauseous specific odour of foul brood. The ravages of this disease in hives may be very considerable.

Under the most favourable circumstances, when the bees are very vigorous, they may pull down the cells containing the diseased larvæ and clean them, removing the morbid products. They then rebuild new cells, and the disease appears to be arrested. But if it is in a virulent stage, and the bees not very vigorous, they are seen at the entrance of the hive in an uneasy condition, thoroughly depressed, and they very soon give up foraging. According to bee-keepers, the disease can spread from hive to hive, and from one locality to another. It is hardly necessary to allude to the great loss entailed by an outbreak of foul brood, the mortality of the brood resulting in the depopulation of the hive, the queen not being able to find room for egg laying.

It is generally supposed that foul brood is due to a particular specific bacillus, which was for the first time in 1885 the object of real scientific study. It was Watson-Cheyne and Cheshire who found in the diseased larvæ bacilli which they isolated, cultivated, and to which they gave the name of *Bacillus alvei*.\* They recognised that this microbe produced spores almost as large as the rods. *Bacillus alvei* is easily cultivated on gelatine, agar, blood serum, milk, potatoes, &c.

This microbe was soon accepted by all bee-keepers as the cause of foul brood, and it is now considered as a distinctly specific pathogenic bacillus, attacking the larvæ only after having been brought from outside into the hive by a veritable external infection, in the same way that the bacillus of plague and cholera affects human beings.

Foul brood still continues to occupy the attention of bee-keepers, and to form the subject of discussion in their journals and meetings, which shows that the work of Watson-Cheyne and Cheshire is far from having settled a number of points relative to the etiology of this disease. Many observed facts in relation to epidemics of foul brood breaking out without any infection being in the vicinity, do not receive a satisfactory solution in admitting the absolute specificness of *Bacillus alvei*.

In the year 1900 the "Société d'Apiculture du Bassin de la Meuse" asked the Belgian Minister of Agriculture for an appropriation of a sum of money for the purpose of a fresh investigation of foul brood in the bacteriological institute of the University of Liège. This allowance was generously granted, and the director of this institute, M. Malvoz, empowered us to make the special researches that were deemed necessary.

\* "The Foul Brood of Bees: *Bacillus Alvei*." *Centralblatt für Bacteriologie*, 1900. Pages 241 and 513. (Second Part).

\* "The Pathogenic History under Cultivation of a New Bacillus (*B. alvei*)," *Journal of the Royal Microscopical Society*, 1885.

The material for study, thanks to the appeals made by bee-keepers in their special journals, was soon at our disposal. We received a number of combs containing foul brood from different and most varied regions of the country.

A simple microscopic examination of diseased larvæ made us acquainted with the spores described by Watson-Cheyne and Cheshire. It sufficed to spread a small particle of the liquefying larva on to an object-glass, to dry and stain it with fuchsine or methyl-violet, then wash it in a stream of water, to find in what remained ovoid spores frequently three, four, five, and six together, attached parallelly to each other in greater or fewer numbers. This rapid method of staining colours only the outside case of the spore, the contents of which remain unstained. Most frequently the spores are the only microbial elements found in such preparations, and the bacilli described as *Bacillus alvei* are rare. Moreover, the common microbes which usually infest dead bodies (*bacillus*, *bacterium*, and *micrococcus*), are generally absent. We were very much astonished at this, for we expected to find, in such a putrid mass of foul brood larvæ as was contained in these combs, which had been removed from their hives for several days, the whole series of microbes that are usually present in all decomposing organic substances.

There should, therefore, be substances among the component parts of the diseased larvæ, which prevent the development of putrefactive micro-organisms. Such really exist, for if a platinum needle be plunged into a diseased larva, and tubes of gelatine, agar, or sterilised bouillon are inoculated with it, these media remain sterile, just as though an antiseptic, preventing the germination of the spores of foul brood as well as the common microbes, had been added to the culture.

This observation did not escape the notice of Watson-Cheyne and Cheshire, who say that quite fresh diseased larvæ must be used for cultures, for according to them, an exposure to the air for two or three days is sufficient to kill the spores. This, however, is opposed to the well-known properties of microbe spores, whose vitality is not impaired by being exposed to adverse influences for many years.

We have never succeeded in obtaining cultures of the microbe, even by plunging a platinum needle into fresh diseased larvæ. It is only by previously washing the foul brood products in a large quantity of sterilised bouillon that one succeeds in inducing the spores to germinate in the cultures and to multiply. Without doubt the diseased larvæ contain substances which act as real antiseptics towards the spores.

It is necessary to dilute the spores in a large excess of liquid, to counteract the restraining action of these substances. Products belonging to the formic acid group have been found in hives, and it is probably to the presence of

these substances that must be attributed the difficulty experienced in cultivating the spores.

The bacilli produced in the culture media by the germination of these spores are large motile rods, with rounded ends, from 3 to 5  $\mu$  long. They accept Gram's stain. M. van Ermengem's method of colouring flagella shows the bacilli surrounded by an envelope from which project ten, twelve, or fifteen long flexible flagellæ.

The spores formed after a certain time are those described by Watson-Cheyne. The rods swell considerably where the spore forms, and, just as at their disappearance, the bacilli are frequently joined together parallelly, the spores remain grouped in the same manner.

The microbe grows well on gelatine and the usual laboratory media. On gelatine plates deep colonies having few characteristics, are seen after one or two days, as well as surface colonies. These latter are fine pellicles of irregular outlines, exhibiting—under the microscope—wrinkles, which apparently correspond to folds in the colony. This pellicle soon liquefies in the centre; the colony dissolves, and disappears through the liquid. In sterilised milk cultures first coagulation occurs, then a portion of the curd is re-dissolved. On potatoes a greyish wrinkled growth is formed. Blood serum is rapidly liquefied.

(To be continued.)

## BERKSHIRE B.K.A.

### ANNUAL MEETING.

The annual meeting of the above Association was held at the Abbey Hall on the 21st prox. Mr. A. L. Cooper presided, and among those present were Messrs. F. B. Parfitt, A. D. Woodley, W. Woodley, Edwards, Stoneham, Blatch, Flood, Johnson, Seymour, Gibbs, Buckle, Camden, D. W. Bishop Ackerman (Hon. Secretary), &c.

The 23rd annual report detailed the various headings under which the County Council grant of £50 had been expended in 1902, including bee-van tour, expert visits, and lectures with bee-tent at flower-shows at Twyford, Shefford, Crowthorne, Wargrave, Earley, Tilehurst, Shinfield, Wallingford, Boxford, and Reading. The Royal Counties' Agricultural show being held at Reading, the Committee decided to make as good a honey show in connection therewith as possible. They applied for and received a grant of £15 from the Society, and £25 from the Local Committee. Prizes amounting to upwards of £25 were offered, with the result that more than 150 entries were received. The judge, Mr. W. Broughton Carr, reported very favourably of the show. The arrangements were all that could be desired. Mr. D. W. Bishop Ackerman, who is a host in himself, was not only everywhere as hon. secretary, but also assisted the judge in the classes where he him-

self was not an exhibitor. Demonstrations and lectures were given in the bee-tent at intervals by the expert, Mr. H. Edwards. The financial result of the show was a profit of £8 13s. 6d., a part of which sum was expended in giving prizes for honey at the Reading Horticultural Show. Forty-five entries were made, and some very fine honey well shown. The show was quite a success.

In connection with the Royal Counties' Show, two candidates passed the third-class examination, and at the autumn examination for second class, one candidate was successful. In July ten candidates from the Lady Warwick hostel obtained third-class passes. The improvement in the finances of the Association has continued, resulting from economical management; so that after supplying all members, cottagers included, with the *Record* monthly, purchasing additional appliances for use, and new stock of honey labels there is a handsome credit balance in hand. The Committee have been promised a renewal of the grant from the County Council, which they purpose expending in a van tour in South Berks; spring expert tours in North and East Berks; and sending the expert and tent to flower shows. In conclusion thanks were accorded to Messrs. Sutton & Sons, to Mr. F. Cooksey for acting as Honorary Auditor, and to the local secretaries for their valuable services.

The balance-sheet showed a balance in hand of £29 15s. 3d.

The Windsor District reported a large number of members, and further stated that the financial statement of affairs was good. The van had visited several places in the district, under the direction of the Technical Education Committee of the County Council. There is a balance in hand of £4 16s. 11d.

Mr. Cooper was re-elected Chairman of the Council, which was also reappointed, Mr. F. Cooksey being added. Mr. Parfitt was elected vice-chairman. The vice-presidents were re-elected *en bloc*. Mr. John Simonds will again officiate as treasurer, and Mr. F. Cooksey was once more chosen hon. auditor. Mr. Bishop Ackerman was re-elected hon. sec. Messrs. Ackerman and W. Woodley were appointed to represent the Association at the meetings of the B.B.K.A.

Votes of thanks to Messrs. Sutton & Sons for the use of the hall and to the chairman closed the meeting.—(Communicated.)

#### ESSEX AND SUFFOLK B.K.A.

##### ANNUAL MEETING.

The above Association held its annual meeting at the Devonshire Hotel, London, on Friday, March 6, Mr. J. Chesson in the chair. Owing to the county of Suffolk being affiliated to the Essex B.K.A., it was necessary to re-name the association.

Referring to the Report of the year's work,

it will be seen that the association increases in membership, while its work is extended further afield, giving to bee-keepers in Suffolk the numerous advantages of membership, including expert advice and assistance at honey shows on bee matters, which the local adviser or secretary will always be pleased to give when applied to. The Committee also hope that those interested in organising horticultural shows will communicate with the secretary and arrange to include classes for honey, to which prizes and certificates will be given, also for the use of the bee-tent for lectures and demonstrations in bee-keeping.

During the year eighty-two new members have been enrolled, including about thirty from Suffolk.

The experts' spring tour commenced on April 2, ending on June 25. The autumn visits were paid between August 7 and October 28. The total number of visits was 726, and a total of 4,350 stocks examined.

Foul brood and wax-moth are reported less prevalent than in the previous season.

The prizes given for best managed apiaries were awarded as follows:—1st, R. Oxborrow, Kirby-le-Soken; 2nd, F. Booton, Barking; 3rd, C. Lodge, High Easter.

This competition gets keener each year, and marked improvement in the condition of the apiaries is conspicuous. The winning apiaries were neat and very artistically arranged.

The association continues to show a favourable cash balance in hand.

The report and balance-sheet were unanimously adopted.

The Countess of Warwick was re-elected President and Vice-presidents were appointed.

The following members were elected on the committee for 1903:—Messrs. G. R. Alder, J. Chesson, Bruce Cook, Dr. Elliott, A. H. Deardon, A. W. Salmon, O. Puck, T. I. Weston, F. G. Kimber, and T. M. White.

Messrs. Tufnell, O. Puck, and W. J. Sheppard were re-elected treasurer, auditor, and secretary in the order named, along with Mr. W. A. Withycombe expert and collector.—W. J. SHEPPARD, Hon. Sec., *Chingford*, March 7.

#### CHESHIRE B.K.A.

##### ANNUAL MEETING.

The annual meeting of this Association was held in Chester, on Monday, March 2. The Rev. T. J. Evans presided over an attendance which included the Revs. E. Charley and E. A. Hutton, Messrs. E. P. Hinde, Chas. A. Miller, F. Lynch, T. D. Schofield, F. Hewitt, G. Lambert, H. Potts, Wm. Johnson, Wm. Cartwright, Job Astbury, W. H. Forde, John A. Bally, Arthur P. Smith (Assistant Secretary), &c. The report and balance-sheet as presented were adopted. The President (the Duke of Westminster), the Vice-Presidents, and the Committee, with the addition of

Messrs. W. Cartwright and J. Astbury, were re-elected. The following appointments were also made:—Treasurer, Mr. T. D. Schofield; Secretary, the Rev. E. Charley; Auditor, Mr. J. Tonge; Librarian, Mr. F. H. Taylor; Lecturers, Rev. T. J. Evans and Mr. F. H. Taylor; Representatives to the B.B.K.A., Rev. E. Charley and Mr. T. D. Schofield. The thanks of the Association were accorded to the Technical Committee of the County Council for providing lectures and demonstrations, and to the judges and stewards of the Hyde and Bebington shows for their valuable services. A vote of condolence with the family of the late chairman, the Rev. J. F. Buckler, was passed in silence.

The report stated that Messrs. J. Gray, H. Edwards, and E. Venables had been engaged as experts in 1902 for various periods; 378 bee-keepers, owning 1,607 frame-hives and 167 skeps had been visited. Seventy-seven stocks had been found to be affected with foul brood.

The Association had had the care of the honey departments of the Cheshire Agricultural Society's Show at Hyde, when the entries were only forty-nine in number, and of the Birkenhead and Wirral Agricultural Society's Show at Bebington, where the entries reached 120 in number and most of the exhibits were of excellent quality. Silver and bronze medals had been offered at Helsley, Barnton, Market Drayton, Bebington, and Altrincham Shows.

Two members had gained third-class experts' certificates, and one had been successful in the second-class examinations. Fifty members had joined in the British Bee-keepers' Association insurance scheme.

Deep regret was expressed at the death of the Rev. J. F. Buckler, whose great interest in bee-keeping had been of long standing, and whose valuable services as an active member of the Lancashire and Cheshire B.K.A. for fifteen years have been highly appreciated, as chairman of the Cheshire B.K.A., in the formation of which he had taken a prominent part, and as an able judge at many shows within and beyond the limits of the two counties with which he was immediately connected.

At a subsequent meeting of the Committee, the Rev. T. J. Evans was elected chairman, Mr. E. P. Hinde being nominated by him as vice-chairman.—E. CHARLEY, *Hon. Sec., Ince Vicarage.*

#### NORTHANTS B.K.A.

##### ANNUAL MEETING.

The twentieth annual meeting of the above Association was held on Saturday, February 28, in All Saints' Schools, Northampton. Mr. W. L. Bird presided, and amongst those present were Messrs. Pilgrim, Manning, Old, James Buckby, Collins, and James Adams. Messrs. Mosley, Winterton, Burnett, and

several others sent apologies for non-attendance. The report, read by the Secretary, stated that the past honey season was, generally speaking, a poor one, but some large takes were reported in Northants, one member harvesting half a ton from fifteen hives, all of which was sold before the close of the year, and 2 cwt. more was demanded. The committee congratulated those members who exhibited honey and secured prizes at the large shows in London.

The total receipts from all sources during the year amounted to £51 13s. 10d., and the expenditure £43 8s. 1d., leaving a balance of £8 5s. 9d. in favour of the Association. The report and balance-sheet were approved and passed. The following officials were elected for 1903:—Lord Effingham, Earl Spencer, Mr. R. B. Loder, J.P., Mr. S. G. Stopford Sackville, M.P., Right Hon. C. R. Spencer, M.P., the Lady Knightley, Mr. E. P. Monckton, Mr. H. Labouchere, M.P.; hon. steward, Mr. W. T. Munn; hon. treasurer, Mr. G. E. Atkins; hon. district secretaries and committee, Messrs. J. R. Truss, W. Manning, C. Cox, J. Francis, J. Perry, H. Collins, O. Orland, G. Page, W. Winterton, F. J. Old, and J. Bubb; and R. Hefford hon. secretary. Votes of thanks were passed to the retiring president, Mr. R. B. Loder, and Kingsthorpe Horticultural Society.—(*Communicated.*)

## Correspondence.

*The Editors do not hold themselves responsible for the opinions expressed by correspondents. No notice will be taken of anonymous communications, and correspondents are requested to write on one side of the paper only and give their real names and addresses, not necessarily for publication, but as a guarantee of good faith. Illustrations should be drawn on separate pieces of paper. We do not undertake to return rejected communications.*

#### NOTES BY THE WAY.

[5059.] March has opened rough and wet—not a particle of "March dust" to date of writing (9th) in this district. Grass crops look promising owing to the mild weather we had in February. Let us hope the Rev. R. M. Lamb will be right in his forecast of our "seeing the earliest spring on record"; this, with fine weather in June and July, will help to make this a record season. We have not begun giving artificial pollen yet in my own apiaries owing to the weather; all stocks except one answer to the roll-call, so that my winter losses are less than 1 per cent., but possibly some stocks need uniting in April or May.

*Candy Making.*—In replying to the request of "W. H. Briller," (on page 76), for bee-keepers to say what sugar they use in candy-making, I always use pure Demerara sugar, and the bees consume the candy before stores in the hive; I also use the same kind of sugar

for syrup-making. The product of the sugar-cane apparently does not require chemicals to convert it into sugar, as do the juices of the beet. In making I use 3 lb. sugar for  $\frac{1}{2}$  pint water for candy. My copper saucepan boils off 21 lb. of sugar and  $1\frac{3}{4}$  pints of water and  $1\frac{1}{2}$  teaspoonfuls cream of tartar. I always use boiling water, as the sugar melts quicker. I allow it to boil eight or ten minutes; then stand the saucepan in a pan or bath of cold water and stir *well* till it cools to a creamy consistency; then pour into moulds, first placing a piece of paper in each.

*Hives.*—I may be allowed to remind your correspondent, "J. D." (5047, page 76), that with a "Combination" hive he will have the elasticity of brood-nest required by extra prolific queens and extra combs or full sheets of foundation can be added as the growth of the brood-nest requires enlargement. Some of my largest "takes" have been from twelve-frame hives, and these large hive colonies very rarely swarm under my management. I always leave the twelve frames in the hives during the winter. Indeed, I have discarded the plan of removing combs when packing for winter, because of the pollen getting so mouldy, and, in consequence, the bees have to clean it out instead of using it for food. I find bees winter as well on the full number of frames as on five or six. Then with the "Combination" hive the enlargement can be gradual, but with a nine or ten frame square brood-nest the enlargement must be obtained by giving another over or under, thus making the nest twice its previous size. Having no "axe to grind" in this matter, I only give my experiences for what they are worth.

*Tall Sections.*—The Rev. R. M. Lamb is still enthusiastic over the tall section, and if it can be proved that we should increase our output by using them instead of the  $4\frac{1}{4}$  in. by  $4\frac{1}{4}$  in. section I would say go forward—*via* the tall section—to increased wealth, but in my opinion this remains to be proved. During the twenty odd years in which I have worked for sections, either the 2 lb., 1 lb., or  $\frac{3}{4}$  lb. size, I have never had any trouble in getting bees to work them. If tall sections are in competition with the square, possibly the judges may perhaps be conservative in their opinions or, maybe, they are ultra progressive and thus biased towards the new thing. I consider that where funds allow it will be advisable, in fairness, to have classes for both sizes of sections. This would, in my opinion, induce a larger number of bee-keepers to give the tall section a trial, and we should get a more general opinion as to the merits or otherwise of respective sections.

*Rail Rates for Honey.*—Referring to the remarks of friend Loveday (5051, page 87), the "G. E." was before our "G. W." Railway in altering the cost of carriage for honey, but, as regards risk for damage, I opine Mr. Loveday is right in his surmise *re* the cause of railway companies repudiating the risk.

Many years ago I remarked to some bee-keepers (who boasted of having got full value and the damaged honey in the bargain) that the thing would be carried too far, and the railways would decline to accept carriage of honey. My only contention in this matter is against our being charged highest rate for "goods" and no redress for damage. If honey was scheduled on the lower scale, and accepted at "owner's risk," we should not complain. For small lots of honey the "Pass."-rate at owner's risk is useful, no doubt, and for long distances cheaper than by "goods"; but for lots of six dozen up to five gross the latter rate is cheaper and safer. But parcels by passenger train are sometimes tumbled, thrown from platform to platform, as I saw it done last week. Fortunately, the "parcels" were not honey.—W. WOODLEY, *Beedon, Newbury.*

#### VALUE OF STRONG COLONIES.

[5060] There seems to have been a letter on the above subject in B.J. of February 12. Having missed that number, I do not know what was said by the writer of 5036 (page 64), but there appears to be some truth in the remarks of "J. D." (5047, page 77). I have myself been very favourably impressed with the work done by a colony transferred from a skep to "Quinby" frames during last season. This stock kept in excellent condition all through the season, and on taking a glance at it the other day I found it still very strong, far ahead of those on Standard frames. I expect to have some trouble in getting stocks on the latter up to working pitch in time for the white clover flow, as during the dearth last August breeding was almost at a standstill; the result being that no young bees were winter-packed, except those reared from eggs laid during the few days of heather-flow in September.

The stock on Quinby frames, however, kept on brood-rearing without a check, as with the larger frame there was always a reserve of stores on hand while other stocks were starving. The large frame would, therefore, appear to be superior; but, on the other hand, can it be said by the users of them that as heavy crops of honey can be secured with their large frames as have been got by working with the Standard frame?

In working for sections the best results are obtained by using a brood-nest contracted to ten Standard frames; but with such a limited brood-nest still further reduced, and workers exhausted by the storage of a heavy crop, the colony is placed at a serious disadvantage for wintering, and, unless strengthened by the addition of new blood, the splendid stock of the one season will more than likely be only third-rate the next. For instance, take the case of the average colony that swarms about the middle of the honey-flow. The swarm is, as usual, hived on new frames, on the old stand, its brood-nest being shifted

aside. At end of season the swarm will probably have its brood-frames heavily stored with honey, while the old stock with young queen will have been busy brood-rearing, so that it is strong in bees, but short of stores. If left alone, neither of these stocks would be ready for the next season's honey-gathering without spring feeding; the one would require feeding to encourage brood-rearing, the other to prevent it dying of starvation. But if the two are united by placing one brood-box above the other, the heaviest going on top, we have a really strong colony that will be ready for the next season's flow without any spring "nursing." Worked in this way, the Standard would share the advantage possessed by the large frame of having during spring a large reserve of stores, and that without cramping the queen for breeding room; and, by removing one brood-box before supering, we have brood-rearing confined to the limit that is found to go best with the securing of a heavy surplus.

I quite agree with Mr. Loveday that spring feeding is a practice that should be done away with; but, under present conditions, "stimulating" is a necessary evil. The effect of heavy autumn feeding would be to fill up the space that would otherwise be utilised in the production of an early batch of young bees. The colony that is to be independent of spring feeding must be closed down for winter with a large population of young bees clustered on a fair extent of empty comb, with plenty of sealed stores above.

The large frame offers all these advantages; the Standard frame, as usually worked, does not.—J. M. U., *Ussie Valley (Cononbridge), March 6.*

#### SOME ESSEX NOTES.

[5061.] *Tall Sections.*—The Rev. R. M. Lamb (5049, page 85), in his efforts to assure your readers that the 5-in. section is superior to the square, or  $4\frac{1}{2}$  in. by  $4\frac{1}{2}$  in., section, quotes the late Sir James FitzJames Stephen. Now, having had the pleasure of listening to the summing up of evidence in several cases by this able judge, I believe that, had Mr. Lamb been pleading before him as he does in the B.B.J., the learned judge referred to would have promptly arrested the advocate, and said, "Do you expect the jury to believe you, Mr. Lamb?" and adding, "I am considering the fact that bee-keepers generally have used the section which you abuse so much for twenty years past, and have evidently found it a great improvement upon the methods in use for obtaining comb-honey previous to the adoption of the 1-lb. section!" But to return to the subject, *i.e.*—What is the most generally useful 1-lb. section? This question is quite as interesting to me as to any other bee-keeper, and I am always on the look-out for the most useful appliances for advancing every branch of bee-keeping; but if, as it appears from Mr. Lamb's letter, he has so little else

to advance in favour of a change beyond his comparisons of the tall section and the produce of dirty and untidy bee-keepers, I think he is rather retarding his cause than advancing it. One has only to read the account of the make-shift way of producing comb-honey adopted by the Rev. T. Adams, and referred to by Mr. Lamb, in order to find that there is practically no connection between this and the 1-lb. section. The same applies to the "dirty sections" referred to in Mr. Lamb's letter. Surely there is no sort of analogy between the shape of a receptacle for comb-honey and the dirty habits of a bee-keeper? A bee-keeper who thinks to save a few pence by again using sections which have already been filled and emptied by customers—a man who would do this must be habitually unclean in his bee-work, and will not improve by having a section of different shape put into his hands.

Mr. Lamb goes as far as to say that hundreds of bee-keepers have given up producing comb-honey owing to the  $4\frac{1}{2}$  square section being so unsatisfactory. I just remember the first introduction of the 1-lb. section, and it has stood the test of the length of my bee-keeping experience, so I have yet to find most of the defects laid to its charge by your correspondent. In fact, I have never found any difficulty in getting bees to work satisfactorily in any super given them if sufficient honey was coming in to induce the bees to need surplus-room, whatever the shape of the super might be. Numerous complaints are made every season that bees will not go into sections, but I have never yet examined a hive without being able to find a good cause for their refusal. Most often it is because there are not bees enough to occupy a super of any sort. Mr. Lamb even quotes Mr. W. Woodley to advance his theory, though that able bee-keeper has already expressed himself as being unable at present to adopt the new section, the advantages of it not appearing to him to justify the necessary expenditure. As to why second or third-class honey is offered for sale in hundreds of windows in every county, as stated by your correspondent, surely it is not the fault of the section used? Anyway, one's imagination must be stretched considerably for us to either accept or make such a statement. Even if we could discover the perfect section I think it would be unwise for the B.B.K.A. to adopt any size whatever as a "standard." A uniform or standard frame for the body of hives is necessary, but in the matter of supers I think producers should be left to cater for their customers; and I believe this is the way that the B.B.K.A. regarded the matter when the 1-lb. section was brought out.

Mr. Lamb writes of his "lost opportunity of testing the tall section at the heather in 1901." I quite expected that he would take advantage of the principal shows last year—the Dairy Show for one—to demonstrate the superiority of the new section. This, I think,

was an opportunity second only to that of 1901, lost. Had a display of these tall sections been made at an important show, Mr. Lamb might well have hoped to convince the whole flock of bee-keepers. I well know that a large exhibit cannot be set up without considerable expense, but if we wish to convince the public, trouble and expense must be given second place. I suggest to Mr. Lamb, as a means of advertising the tall sections, that he offer to the secretary of each county show this year a complete rack of these sections to be awarded with the first prize for sections—W. LOVEDAY, *Hatfield Heath, Harlow.*

### HEATHER HONEY

FROM CALLUNA VULGARIS, OR COMMON LING.

[5062.] Honey gathered from the above certainly stands "second to none" in the opinion of most bee-keepers in the northern counties of England and of Scotland. Some time ago, your correspondent, "D. M. M., *Banff*," termed it the "Glorious Heather Honey," a description which was rather sarcastically, I fancy, referred to by Mr. W. Woodley in his "Notes by the Way." This and other similar small details we read of all tend to emphasise "D. M. M.'s" remarks in B.B.J. (5043, page 74), that "an altogether wrong estimate prevails in the south as to what constitutes an ideal sample of true heather honey." Some southern bee-keepers are of the opinion that good heather honey is too strong and pungent, while many northern bee-keepers hold that any other than heather honey is insipid and tasteless. Such opinions, however, go to extremes, because all good honey, from whatever source it is gathered, obviously must have qualities which secure its favour with consumers. That from sainfoin has its good points, clover goes one *better*, but real heather honey we in the north consider *best* of all. Therefore I should also like to see it "assigned a true position." It is not easy for any one man to define certain points without reflecting somewhat on the opinion of others, but the heather honey referred to by Mr. Lancelot Quayle is evidently not what we term real heather honey. Combs of the latter may be uncapped and revolved in the extractor from morn till night, but no liquid honey would be extracted therefrom. A comb of it laid on a plate may be cut through in any direction, like cheese, without the honey running from the cells.

As the extractor is useless for heather honey, it is necessary to remove from the combs by means of a honey-press, but unfortunately the process of pressing causes more or less air-bubbles to appear throughout the honey, and this detracts from its appearance when in glass jars. I hope that this question may be thoroughly discussed, and prove to be of real assistance to some of those who act as judges at honey shows. At the same time, I

think the paucity of exhibits of Highland heather honey at shows mentioned by "D. M. M." on page 19 is very regrettable, for it is quietly, but surely, putting a stop to the headway which heather honey would undoubtedly make at our great shows. If moormen would only take advantage of the chances offered by sending their exhibits to compete for the prizes for heather honey would expand instead of being reduced. Fancy, in a good year like 1901 there were at one big show over forty exhibits staged for 1-lb. sections of honey other than heather, and only two of heather honey! Can we wonder at the promoters of such exhibitions reducing the prizes for heather honey? In conclusion, I think the current year will prove a good one, and also that exhibits at shows may be correspondingly good.—JAS. WADDELL, *Wooler, Hon. Sec. N. and D. B.K.A.*

### QUEEN INTRODUCTION.

[5063.] In the current number of the *Bee-keepers' Review* (American) is printed an advance chapter from a new book, "The Queen Bee," by T. K. Massie. This deals with queen introduction, and a method by which the queen is released at once, and the colony is never left queenless. Thinking it might possess interest for British bee-keepers I have condensed the chapter in question as follows:—The new queen is placed, with two combs of hatching brood, and as many very young bees as can be obtained from the colony to which she is to be introduced, in an upper story over the colony, a special board between. After twenty-four hours a one-bee-way is given through the side of the board, and after the upper queen has begun to lay, in from three to seven days the board and the old queen are removed. The rest of the lower combs, freed from bees, are then exchanged for empty frames, and are placed in the upper story with the new queen and her small colony, a single sheet of newspaper pierced by a few pencil-made holes separating the stories, in the upper one of which is now the whole of the brood combs and the laying queen and her bees. In the lower the whole of the now queenless and broodless bees, gradually transfer themselves back to their own brood, then remove the newspaper.

This is, of course, a very brief synopsis of the chapter given, and there appears to me to be something of value here, whilst the method is perhaps a little more elaborate than is necessary.

Constant success with the direct method enables one to callously leave, without fear, a new queen to her fate, but bee-keepers with nerves may purchase peace of mind, in addition to the undoubted gain in the continuity of the laying by the queens, at, however, the expense of some extra work.

If I might, I would suggest, instead of the board, the use of a sheet of wire gauze and



perhaps a very thin quilt over, between the two stories, to ensure the necessary heat, and then at introduction treat the upper colony as a nucleus and introduce directly to the lower colony, as there should be no more difficulty in uniting than with bees of a compound hive.—L. S. CRAWSHAW, *Ilkley*.

SECTION RACK AND SHALLOW FRAME BOX.

[5064.] As my sketch was not reproduced along with the description given on page 97, I think the details for making the "eke" referred to are not quite clear. I therefore append the following:—

Cut two pieces of wood of a length equal to the inside width (across section flanges) of rack, and  $1\frac{3}{8}$  in. wide by  $\frac{3}{4}$  in. deep; then cut two pieces  $17\frac{3}{4}$  in. long by  $\frac{3}{8}$  in. wide by  $\frac{3}{4}$  in. deep. Nail these latter against the ends of the former, with two long wire nails at each corner. Drill a  $\frac{3}{16}$  in. hole *exactly* in the centre of each of the wide end-pieces, to take screws for attaching to rack.

In reference to Editorial footnote which follows my letter, I may say that Messrs. James Lee & Son supplied me with some of these "ekes" about seven years ago; perhaps Messrs. Lee will say who are the originators?

In reply to the request made by "D. M. M., Banff" (on page 76), that "heather men" should express an opinion on the question of bees neglecting *Calluna* for *Erica cinerea* in the Isle of Man, I may say that, as far as the mainland of Cumberland is concerned, the honey-flow from *Erica cinerea* is in July, while the *Calluna vulgaris* yields in August and September. Therefore, what *Erica* might be in bloom during the time the *Calluna* yield is on would not, I think, cause the bees to neglect the *Calluna*.—GEORGE M. SAUNDERS, *Keswick, March 7*.

Echoes from the Hives.

*Dunmow, February 26*.—My twenty colonies are, I hope, in good condition. I have yet made no other examination than to see whether the candy-cake needs renewing. One day last week the bees were flying in great numbers from every hive. I put naphthaline at the back of each hive recently. Would you advise flour-candy when they need any more? [Yes.—EDS.] And would 2 lb. cake last till they gather food for themselves?—F. E. B.

*Dowthwaite, Keswick, March 9*.—After spring-like weather, which advanced vegetation far too much to be safe, we have had samples of all weathers—hail, sleet, frost, and gales. One of the latter moved my honey-

house bodily, without injury, 2 ft., weighing about a ton. A glasshouse, not far from me, was lifted on to the top of another glasshouse, and neither was much hurt. My hives are fixed in a way impossible to move, or would have gone far and wide. The bees have only had one real fly all through the winter.—GEORGE M. SAUNDERS.

WEATHER REPORT.

WESTBOURNE, SUSSEX.

February, 1903.

Rainfall, 1.71 in.  
Heaviest fall, .62, on 27th.  
Rain fell on 13 days.  
Below average, .22 in.  
Sunshine, 72.9 hours.  
Brightest day, 18th, 8.4 hours.  
Sunless days, 12.  
Below average, 19.4 hours.  
Maximum temperature, 54°, on 20th.  
Minimum temperature, 26°, on 18th.

Minimum on grass, 21°, on 18th.  
Frosty nights, 3.  
Mean maximum, 48.4°.  
Mean minimum, 39.2°.  
Mean temperature, 43.8°.  
Above average, 6.5°.  
Maximum barometer, 30.75°, on 10th.  
Minimum barometer, 29.40°, on 28th.

L. B. BIRKETT.

Queries and Replies.

[3042.] *Queen Cast Out in March*.—Having found a queen alive outside one of my hives, I made an examination, and have reasons to believe that the bees have requeneed themselves. I enclose the queen and a few live workers from the hive for inspection, and if you will kindly let me know through the JOURNAL if she is of any use. I think it must be rather unusual, as there was plenty of sealed brood. This is my first year of bee-keeping, so feel rather anxious about it. I have ordered another queen.—W. W., *Croydon, March 6*.

REPLY.—The queen and four worker bees were all dead when received. The queen has the appearance of a virgin, so that if—as you suppose—the old or parent queen has been deposed by the bees, the one sent might be one of two or more queens raised. An inspection of the combs should therefore be made to ensure the stocks being queenless before introducing a purchased queen.

[3043.] *A Beginner's Queries*.—As a beginner, will you kindly enlighten me in one or two queries? I have two stocks of bees, and on February 6, I gave each of them a cake of candy with which I mixed some pea meal,

according to the "Guide Book" instructions. The next few days saw the bees very busy carrying in water, and on looking at the hives ten days later, I found one had eaten their cake, about 1½ lb., so I gave them another one. I intend feeding with syrup at the beginning of April. 1. How many holes in the feeder should I give the bees access to? 2. Is the fact of the bees carrying in water a sure sign of breeding having commenced. 3. What is the object of the honey board? Would the bees fill the space between the excluder zinc and the tops of frames with brace-combs unless this was used? 4. Is a honey board preferable to placing excluder zinc and section-rack directly on frames? I have been greatly instructed by your valuable paper for some months, and look forward eagerly to each issue, as I always find something instructive in the queries. I enclose name and address while signing myself DILIGENCE, Birmingham, March 7.

REPLY.—1. If the bees are short of food allow five or six holes; indeed, for a week free access may be given to all holes. Then reduce to four or five holes for continuous supply. Give the syrup warm at first. 2. No; the bees require water to liquefy the candy given. Plentiful pollen-carrying is a much more reliable sign of brood-rearing. 3. The honey-board provides bee-space above frame tops or below supers. 4. No; it is mainly used in America, where methods of management are somewhat different from ours.

[3044.] *Getting Rid of Vicious Bees.*—I shall be obliged if you will answer the following queries in the BEE JOURNAL:—1. I have a hive of hybrid Italians much too vicious to be pleasant. I wish to destroy the queen. Would it do to remove her, and then join up this stock with that of the next hive—hybrid Carniolans? And if so, what would be the best time to do it? 2. Last year my bees increased so much that I had to put two or three hives in front of the normal row, there being some palings between the two rows. May I move the back row without danger of any bees losing themselves?—F. T., Liverpool, March 7.

REPLY.—1. If sufficiently experienced in uniting bees to do it well, the two colonies may be joined as stated; otherwise it is a risky operation, and may easily end badly. An easier and more profitable method of requeening would be to allow the stock to swarm, and return the swarm, destroying the old queen as the bees run in to the parent hive. You would thus retain the two stocks, and when the bees swarm again (as they are almost certain to do eight or ten days later), the queen-cells may be removed and the swarm returned on the evening of same day. 2. Unless the hives are moved gradually a few feet at a time every few days, there is certain to be some loss of bee life in moving them as stated.

### Notices to Correspondents & Inquirers.

All queries forwarded will be attended to, and those only of personal interest will be answered in this column.

G. W. J. (Cornwall).—*Transferring Bees from Skep to Frame-hive.*—"The best way" is to set the skep above the top-bars of frame-hive and allow the bees to transfer themselves and the brood-nest below when more room is required for brood-rearing. This will be about mid-April if the stock is doing well. The full details of the operation are too lengthy for this column, but may be read in the "Guide Book" in chapter on "Transferring Bees."

H. BOWREY (Reading).—*Medicating Bee Food.*—If the "directions for use" printed on label are carefully followed no account need be taken of the "pungent vapour" you refer to.

H. POTTER (Kent).—*Bees and Rheumatism.*—It is an established fact that the formic acid contained in the poison of the bee's sting is beneficial in cases of rheumatism, many bee-keepers having testified to their improved condition with regard to that ailment after being stung a good many times. Your own is a case in point, and we are glad to hear that taking to bee-keeping has been of such value as to make you, "bless the buzzy bees that brought such great relief."

J. A. HEBBERLEY (Baden, Germany).—*"Homes of the Honey Bee."*—Photos of your bee-house apiary received with thanks. We shall be very pleased to include same in our bee-garden pictures, for which tone blocks are now being engraved.

A BEGINNER (Huddersfield).—*Moving Bees.*—You had better move the hives at once. When the bees start flying daily a quarter of a mile change of location would cause an appreciable loss of bee-life.

NOVICE.—*Sugar for Bee Food.*—If the sample is guaranteed pure cane sugar it is all right for spring use; but Demerara yellow crystals are not so suitable as refined white crystals for autumn food. The objection to raw or unrefined cane-sugar for bee food is that it contains the molasses, or treacle, which is well known as a laxative, and thus liable to cause dysentery if bees are not strong and vigorous. Please send full address when writing to us.

M. F. (Shere, Guildford).—*Dead Bees Carried Out in February.*—There is very little cause for alarm in dead bees being cast out of hives in the early spring months, unless the number is excessive, in which case an examination must be made on the first fine day. From details given we think you may be fairly certain that the trouble is only slight.

\*.\* Several Reports of Shows and Queries are in print and will appear in our next issue.

## Editorial, Notices, &c.

### HEREFORDSHIRE B.K.A.

#### ANNUAL MEETING.

The annual meeting of the Herefordshire Bee-Keepers' Association was held at Clarence House, Hereford, on March 4, Sir James Rankin, M.P. (president), in the chair. Among those present were the Revs. F. S. Stooke-Vaughan and W. Head, Mrs. Glinn, Mrs. Boycott, Messrs. Alfred Watkins, W. Tomkins, R. Grindrod, J. Helme, W. Matthey and James G. Godwin (hon. secretary and treasurer).

The secretary produced the balance-sheet, which showed a small sum on the credit side, with no debts beyond some trifling ones incurred since December last. The honey fair was held in September, and, considering the adverse nature of the season, a very creditable display of bee produce was staged. The prize exhibits were very good all round. The cost of the honey fair, based on the 1902 schedule, was £15 9s., and towards this about 25s. was received for selling spaces.

In moving the adoption of the report and balance-sheet, Mr. Watkins said it was exceedingly creditable to their hon. secretary that, in view of the smallness of their income, he had kept them out of debt up to the end of December. The trouble with the association's finance was that it had become very small, and it was difficult to divide the subscriptions among the objects they desired to gain. Last year the subscriptions were about £25, while this year they could hardly expect more than, he thought, £20. The honey fair represented a minimum outlay of £10, and accordingly little money was left to carry on their work. When it was found that an expert's services could not be provided for, members of the association, feeling they got no benefit, naturally dropped out.

The report and balance-sheet were approved and carried.

Later on Mr. Watkins said his idea of the honey-fair was that it had been an educational institution to bee-keepers with regard to marketing their honey properly. The taking of a grant from the Technical Instruction Committee had, he thought, been detrimental to the association, because the latter wanted to be an independent body and to be free in their actions.

The Chairman said he could readily understand that dropping the honey-fair would be a considerable drawback to cottagers. He thought they should devote attention to keeping up the fair, but not give prizes.

Eventually it was decided that the honey fair be continued, but that no prizes be offered, and that the expert's spring visits be resumed, using, where possible, the services of local qualified experts.

On the motion of Mr. Grindrod there was a

rider added that it be an instruction to the committee that they may dispense with the holding of the honey fair if in their discretion they consider the number of entries not sufficiently numerous to justify its taking place.

The election of officers followed, and Sir James Rankin was re-elected President, Mr. J. G. Godwin, Secretary and Treasurer, and Mr. Joseph Thomas, Auditor.

The meeting closed with a vote of thanks to the Chairman for presiding.—JAMES G. GODWIN, *Hon. Secretary.*

### HARTLEPOOLS AND DISTRICT B.K.A.

#### ANNUAL MEETING.

The annual meeting of the above Association was held in the All Saints' Schools, Stranton, West Hartlepool, on February 25.

The Rev. J. Bennett, M.A., presided over a good attendance.

The report and statement of accounts for 1902, read by the Hon. Secretary, showed a slight deficit on the year's working. The Association having affiliated with the Northumberland and Durham B.K.A., the apiaries of members were visited by the expert, Mr. Waddell, who discovered "foul brood" in several hives. With a view to the stamping out of the disease, a committee comprising the following gentlemen, Messrs. Earnshaw, Pittinger, Pratt, Milne, and Ironside, were empowered to visit all hives in the district during the ensuing season.

The President (Sir Christopher Furness, M.P.), and Vice-Presidents (Rev. J. Bennett, M.A., Rev. W. W. Morrison, D. Duncannon, Esq., and Chas. Robinson, Esq.), and Hon. Secretary (Mr. Wm. F. Burkill) were unanimously re-elected.

A vote of thanks to the Chairman concluded the meeting.—(*Communicated.*)

### INVESTIGATIONS RESPECTING THE MICROBE OF FOUL BROOD.

#### A DISEASE OF BEES.

By Dr. Ul. Lambotte.

*Made in the Laboratory of the Institute of Pathology and Bacteriology of the University of Liège, Belgium. Published in September, 1902, in the Annales de l'Institut Pasteur.*

(Continued from page 103.)

In pursuing our studies of the character of this microbe in the different culture media, we were soon struck by the great resemblance which this *bacillus alvei* of foul brood has to a microbe well known in bacteriological laboratories—namely, *bacillus mesentericus vulgaris*. There were the same microscopic characteristics, the same spores, the same flagellæ, the same development in gelatine. In the collection of the Bacteriological Institute we already had a typical *bacillus mesentericus*, but in order to complete the comparative

study, we asked M. Binot, of the Pasteur Institute in Paris, for specimens of the various bacilli of the mesentericus type. We then proceeded to compare the several cultures of all these microbes, and we are absolutely certain that *Bacillus alvei*, which is considered by bee-keepers as a specific microbe, is only a variety of a very common germ, *Bacillus mesentericus vulgaris*, which is spread very widely, it being found particularly on vegetables. *Bacillus alvei* does not differentiate itself from *Bacillus mesentericus*, either on agar, potato, gelatine in tubes or on plates, in bouillon, blood serum or milk. It must be noted that we did not work with only a single *Bacillus alvei* isolated from a diseased larva, but with a number of specimens derived from different apiaries infected with foul brood, and coming from different parts of the country. In every case the bacilli issuing from the spores have shown the characteristics of *Bacillus mesentericus*. Moreover, the description given by Watson-Cheyne and Cheshire is that of *Bacillus mesentericus*. When the work of these observers appeared (1885) *Bacillus mesentericus* was not well known, and it is, therefore, not surprising that a very common microbe should have been taken for a specific one.

The identity is specially remarkable in such media as milk, and the crumb of bread. Both with *Bacillus alvei* and *Bacillus mesentericus vulgaris* in tube cultures of milk coagulation of the casein first takes place, then this is partially liquefied. The liquid then separates into three layers—an upper layer, consisting of a sort of slimy and ropy cream, full of bacilli; a non-slimy middle layer; and a lower layer, formed of undissolved casein. There is an unpleasant urinous odour. On moistened sterilised crumb of bread, in Erlenmeyer flasks, both microbes grow very well, and, strange to say, the bread becomes ropy, just like the diseased larvæ.

This question of the identity of the microbe being settled, how are we to represent the pathogenesis of foul brood? There is no doubt but that the disease is due to *Bacillus mesentericus*, this microbe being the only one found in diseased larvæ, and these are ropy, just like certain culture-media (moistened bread crumb in particular) infected with either *Bacillus mesentericus* or *Bacillus alvei*. The disease of bees is, therefore, not due to a special microbe, observed only towards the end of the epidemic of foul brood (similar to what happens in human beings in plague, cholera, &c.), but to the swarming in the bodies of the larvæ, of a very common germ extensively scattered on external substances, and acquiring at a certain moment, for one cause or another, the qualities of a pathogenic microbe. Similar changes are frequent in human pathology. In a normal condition our mucous membranes are the receptacles generally for common innocuous microbes, such as *Staphylococcus*, *Bacterium coli*, *Streptococcus*,

&c., which in some cases become pathogenic and cause illness, without our being able to determine what produces this virulence. The malignity of these micro-parasites may even become so great that, evacuated by the patient, they can become a source of danger to healthy beings, and, although there may not be any apparent predisposition, the microbes are able to produce in them an infectious or contagious disease.

One must admit that *Bacillus mesentericus* acts in the same way towards bee larvæ as *Streptococcus*, *Bacterium coli*, and other micro-parasites do in normal man. In fact, we have found *Bacillus alvei* in healthy bees and larvæ, only the number of germs in them is smaller than in a diseased larva. When cultures are made from healthy bees and larvæ, the ordinary microbes adhering to the mucous membranes of the higher animals in a healthy condition (*Bacillum coli*, *Streptococcus*, &c.) are never found. However, we find in such cultures *Bacillus mesentericus* and *Bacillus subtilis*—species having highly resistant spores, and widely spread, particularly on the surface of vegetables.

Why, then, does *Bacillus mesentericus* at a certain time commence in a hive full of larvæ to multiply in their tissues, and produce all the symptoms known as foul brood? One has to admit that the larvæ must have been in an abnormal condition, which had modified the physiological resistance of their tissues, to microbes habitually surrounding them and appearing in their digestive tubes. *Bacillus mesentericus*, however, is known to be a delinquent in this respect. It causes ropiness in bread. In certain conditions not well understood, of abnormal fermentation or of the bad keeping qualities of bread, the dough is seen to assume a particularly ropy appearance.

Professor Laurent, of Gembloux, has studied this bread disease, and has described a bacillus as the causal agent, which he has called bacterium of bread fermentation (3). The question was taken up by others, and to-day it is recognised that the microbe is none other than *Bacillus mesentericus*. Vincent in his remarkable work has shown that it was possible to transform saprophytic microbes, notably *Bacillus mesentericus*, into pathogenic ones, and to produce with their aid experimental diseases analogous to those produced by usual infectious agents (4).

The fact that these common and ubiquitous microbes are capable of becoming the producing agents of serious maladies, was first propounded by Pasteur, in his study of the silkworm disease which presents so many points of similarity to the one which we are studying. Pasteur had noticed that silkworms could become diseased not only when they were attacked by specific germs, but also

(3) Bulletin de l'Académie Royale de Belgique, 3e série, 1885.

(4) Vincent. Sur les Aptitudes Pathogènes des Microbes Saprophytes. Annales Pasteur, 1898, No. 12.

when badly kept and nourished, their tissues no longer offer resistance to the invasion of common bacilli infesting their digestive tube. It is then what Pasteur called *maladie de la flacherie*, quite different from that produced by the specific germs. This disease has not been studied since Pasteur's time, but we think if the investigation were again taken up, with the present knowledge it would no doubt be found that at least one of the forms of this malady would be traced to microbes of the mesentericus family.

However difficult it may be to realise the natural conditions of infection experimentally, we have tried to produce foul-brood artificially by means of *bacillus mesentericus* and *bacillus alvei*.

At the Institute we were able to carry out our experiments upon a hive to a satisfactory conclusion with the advice of enlightened bee-keepers of the "Société du Bassin de la Meuse" (MM. Pirotte, Strauven, and Soir).

When there were live larvæ in our prosperous colony, we killed some of them by simply pricking, and then surrounded them in their cells by a few drops of emulsion of an agar culture of *acillus mesentericus*. The comb thus treated was replaced in the hive. In three days the bees had already completely emptied the cells of the killed larvæ, and there was no trace of either larvæ or emulsion. The experiments in trying to produce foul-brood in this way, have always failed.

But, if instead of cultivating *bacillus mesentericus* on ordinary nutritive agar, it is cultivated in a special medium prepared with larvæ, quite different results are obtained. A large number of larvæ are collected, mashed, or triturated, and a nutritive bouillon is made with them according to the ordinary laboratory formula. *Mesentericus* grows abundantly in this bouillon, as well as in agar, or gelatine, prepared with this larval bouillon. After a series of cultivations, a special race of *bacillus mesentericus* is obtained. With further cultivations of this, the experiments for reproducing foul-brood in a healthy hive are again commenced.

On the first trial carried out under similar conditions to those described, after a few days one finds that several of the infected cells have not been cleaned out. Their contents are greyish and ropy, similar to those of cells of foul brood. Capped cells have small perforations, just as in foul brood. The only difference between the brood artificially infected and that of a hive suffering from foul brood is that in the former there are fewer affected cells. About a fifth of the cells infected this way with *bacillus mesentericus* had foul brood, the others were cleaned and their contents were removed by the bees.

Under the microscope, the ropy contents of the cells, show a bacillus similar to *bacillus alvei* of Watson-Cheyne. Some days later,

spores characteristic of *bacillus alvei* and *bacillus mesentericus* are abundant.

This positive experience was obtained towards the end of summer, at a time when the vitality of the colony was considerably reduced, and when the queen had nearly ceased laying.

The fortunate results contained by our inoculation must be attributed partly to the modification of *bacillus mesentericus* cultivated in larvæ bouillon, and partly because the trials to produce foul brood were made at a time of the year when the activity of the colony had very much declined. This last circumstance is probably the most important. In fact, a prosperous hive in excellent condition at the beginning of the year, inoculated at different times with *bacillus mesentericus*, derived from a culture of larvæ bouillon, in every instance failed to produce foul brood.

(Conclusion next week.)

## Correspondence.

The Editors do not hold themselves responsible for the opinions expressed by correspondents. No notice will be taken of anonymous communications, and correspondents are requested to write on one side of the paper only and give their real names and addresses, not necessarily for publication, but as a guarantee of good faith. Illustrations should be drawn on separate pieces of paper. We do not undertake to return rejected communications.

\* \* \* In order to facilitate reference, Correspondents, when speaking of any letter or query previously inserted, will oblige by mentioning the number of the letter as well as the page on which it appears.

## AMONG THE BEES.

### SOME INTERESTING STATISTICS.

[5065.] The statistics on bee-keeping in Ireland, contained in the Report of the Department of Agriculture for Ireland, form interesting reading and supply food for some meditation. The first thought that strikes me on glancing them over, is that they clearly mark progress all along the line. Thus the total honey yield in 1901 equals 718,218 lb., whereas in 1891 it was only 253,561 lb., showing an increase of 464,659 lb. This advance is no sudden spurt, because we find, for instance, that the average for the first three years was only about 230,000 lb. against an average of about 700,000 lb. for the last three years of the period, or fully three times as much surplus honey in the latter period as in the former.

The produce from skeps has not kept pace with the increase from bar frame-hives, having little more than doubled, whereas that from the latter has increased to about three and a half times what it was ten years before. The total from the two classes of hives ran a race neck and neck in 1891, but by 1901, surplus from movable combs show almost double that from all other hives. Run honey has fully doubled its total, but section honey has more

than trebled. Surplus from skeps shows a little over 15 lb. each, that from bar frame-hives over 25 lb., the general average being almost 22 lb. Movable combs in 1901 gave 46,000 lb. surplus. For the four years, 1891-2 3-4, they only gave 50,000 lb., so that last year all but totalled the four years' yield. In regard to swarming, perhaps, no true deductions can be drawn, but as far as figures go, 97 per cent. of the skeps swarmed, while, in the case of bar-frames, they show only 64 per cent. Loss by deaths during winter shows about 11 per cent., and a difference of about 3 per cent. being in favour of bar-frames.

The question of wax I own puzzles me a little. How can one county produce this asset at the rate of only about 3½ lb. out of 100 hives, and another yield over 100 lb. wax from a like number of stocks? How, for instance, can Mayo from 797 hives turn out 954 lb. of wax, and Sligo, its neighbour, only yield 47 lb. wax from 855 hives? Mayo seems to excel in wax rendering, for when compared with the three better honey-yielding counties—Cork, 68,500 lb. (772 lb. wax); Donegal, 59,000 lb. (240 lb. wax); Galway, 52,000 lb. (323 lb. wax)—she gives 945 lb. wax to 23,000 lb. honey. Here, again, is another test. Mayo gives a wax cake, as we have seen, of 954 lb., Galway 323 lb., Kerry 393 lb., and Donegal 240 lb., all three combined yield just the same size cake, 956 lb., yet Mayo gives only 23,000 lb. surplus honey, whereas the other three counties total 161,000 lb., or just *seven* times as many pounds. Mayo must possess a large number of Mr. Wells's, and the other three counties a still larger number of bee-keepers who set little value on wax, for with over 7,000 hives they just equal her total, which she obtains from only 800 hives.

*Some Scotch Statistics.*—No machinery exists in either England or Scotland capable of making any safe calculation of the number of hives or of surplus honey derived from them each year. A friend lately asked me as a favour to supply him with an estimate on these two points, giving my ideas, as near as I could approximate, and I gave him 120,000 hives and a corresponding total in sovereigns as the value of honey procured from them. Of course, it is only a guess, but I should like a few opinions on the subject from other bee-keepers as to how their figures might coincide with mine. This is how I proceeded. Reasoning from the known to the unknown, I began to erect my superstructure on the basis that 200 hives were to be found in our parish, and, keeping round numbers, multiplied them by twenty parishes, again multiplying these by thirty counties, I obtained a total of 120,000. Of course many parishes possess more than 200 hives, but I know many others have not half that number. Again, many counties are much larger than ours, but many are also smaller, and, from personal knowledge, I can

vouch that some large counties possess fewer hives, so we have a kind of general levelling up, with the result named.

Counting our surplus all over at about 24 lb. per hive, and the price as, say, 10d. per lb., which is about a fair average, we obtain a clear profit of £1 from each hive. Here, again, many may hold that the average yield should have been higher, and the price also; but I do not think so. Many hives give 50 lb. up to 100 lb. of surplus, at least, in good years, but how many give no surplus.

*Bees and Flowers.*—A very close link binds the two in an interdependence which makes the very existence of the one hang on the other. Without the pollen and nectar of the flower the bee would cease to exist, and, as surely, without the pollination of the flowers by the bee they would fail to properly propagate and uphold their species. A deterioration or decadence would inevitably take place, sinking the flower to a lower degree of perfection, if not, indeed, bringing about its extinction. Without further carrying out this line of thought, let us see at present how admirably the one is adapted in several ways to assist the duties and increase the well-being of the other. Many flowers have a *lip* on which the bee rests when it is sucking the honey from the nectaries. Indeed, Nature has planted that lip exactly where it proves of most service, for, being situated exactly in front of the thorax of the flower, it forms an admirable vantage ground from which, curiously right before its eyes, it can behold the gay bands and streaks of the honey guide converge and concentrate on a point which shows the creature, without any search where the honey gland is situated with, its hidden store of nectar, showing the flower is ready and willing to have the sac rifled of its precious sweet. Here is a point of departure for an intelligent study of the relation between flowers and bees. Systematic botany should not, at least at first, be a primary aim, as far more readers will take a kindly interest in it if iteschews cast-iron science and clothes the study of flowers with a living realism, and adapts the knowledge to features in flowers or plants which have an abiding fascination beyond the mere naming or classification of species or genera.

The close connection of the flower and the bee, if carefully observed, will add to the interest we take in both. The admirable manner in which the insect aids pollination, and the almost *intelligent* way the flower assists the bee in collecting nectar and beebread are really marvels, and yet they are often so plain and manifest that he who runs may read.

I should like several of our observant contributors who have leisure to watch the pollen gathering going on to study any peculiar points as carefully as possible, and give us the fruits of their observation during the coming spring.

—D. M. M., *Banff*.

THE FRAME QUESTION.

[5066.] The subject of the suitability or otherwise of the "Standard" frame for filling its intended purpose was under brisk discussion a few weeks back, and, with your permission, I will advert to it. Some of your correspondents appeared to have made a "dead set" against the "Standard" frame, some going to extremes in condemnation of it.

It may be remembered that your correspondent Mr. H. Edwards, who started the discussion, took up the rôle of the "comic man" (on page 505 of B.B.J. of December 18), in trying to be funny at the expense of myself and others. I do not complain, but prefer leaving the (turkey) "bone-picking" to bee-keeping humourists. It is not in my line. All the same, the frame question is—like "the poor"—always with us, and the "Standard" still holds the field.

We want the "Standard frame," but there is, I think, a general feeling that it should have a stronger top-bar. I myself approve, in principle, the frame brought to notice by Mr. Edwards, and have since had an opportunity of examining one; but the conclusion I arrive at is that a frame with a top bar  $1\frac{1}{2}$  in. wide and  $\frac{5}{8}$  in. thick, is quite unnecessary, and causes needless waste of space inside the frame that might be usefully occupied by brood or honey. Other objections may be found in the greatly increased distance between brood-combs and supers, which is one of the most important things we have to consider, particularly at the beginning and towards the close of a season. All experienced beekeepers know how difficult it is to get bees to occupy supers, in both the early and late seasons, if the nights are cold, and if we nearly double the present distance between brood-combs and supers, the difficulty is, of course, proportionally increased. Besides, an unnecessarily thick and heavy top-bar and side bars must be proportionally weaker at the shoulder than the frame now in general use is.

I have been using a frame with  $1\frac{1}{8}$  in. by  $\frac{3}{8}$  in. top-bar, and as it effectually gives the required strength I can see no necessity for a thicker top-bar. On the other hand, out of the thousands of  $\frac{3}{8}$  in. by  $\frac{5}{8}$  in. top-bars that I have handled very few, indeed, showed any sign of "sagging," and among these few three cases occurred in my own hives, and the cause in each instance was either a crack or a knot in the top-bar. Manufacturers should be more careful than they sometimes are in the choice of wood frames, for I have seen frames made from wood which had already begun to decay. If a parcel of standard frames is obtained from each of the known makers, probably not more than one or two in the whole would be found exactly alike, though in outside dimensions all of "standard" size. Nearly every maker has his own pet frame which, in his view, is superior to anything else upon the market.

Though a stronger top-bar may have its advantages in certain branches of bee-keeping, such as dealing in stocks of bees for sale on their combs, yet for ordinary bee-keeping the "Standard," as laid down by the B.B.K.A., is, in my opinion, the same useful frame now as when first introduced many years ago, and there is no occasion for novices to worry their brains over the frame question, but simply to ask for "Standard" frames when ordering. With regard to the "saw cut" in top-bar, I only ask that novices may be able to get the "saw cut" when they ask for or want it. Then, after some experience, they will decide for themselves as to its merits or otherwise, while old hands can get what they prefer.—W. LOVEDAY, *Hatfield Heath, Harlow.*

STRONG COLONIES AND MANAGEMENT.

[5067.] I found out that last year "management" was especially necessary in order to secure strong colonies at the right time. It is long since we had a more tantalising season. At one period it promised to make a glorious record. We had around us here several large fields of beans and clover; the latter was, indeed, so abundant and luxuriant that some farmers remarked that they had seen nothing equal to it for twenty years. My forty stocks were also splendidly fit, and they did their very best during the three weeks of honey flow—one on beans and two on clover—thoroughly maintaining their title to the symbol of industry. In fact, at one time they almost got out of hand, and it looked as if they were going to put at his wits' end one who had tried to be a bee-master for thirty years. In spite, however, of the short season, the result was fairly good—about  $\frac{1}{2}$  ton of super honey, to which was added another  $\frac{1}{4}$  ton by lightening thirty stocks which went to the moors.

Now as to *management*. Of late years I have changed my method of winter and spring management. I used formerly to allow each colony 30 lb. or more of food for the winter, and never thought of feeding in the spring. Now my plan is to see that each stock has 14 to 20 lb. of food in October—to give in January or February a cake of candy—to feed with warm, thick syrup on a mild day after the middle of March, and a fortnight later commence slow stimulative feeding, which is continued for a month. This plan of working would not, of course, suit those who cannot give time and attention to their apiary in the spring. But it has answered well with me. I consider there are two or three important advantages in it. I observed years ago, when I used skeps, that those of medium weight gave the best results in the spring, probably because there was plenty of room for egg-laying. In this respect it seemed that the heaviest hives, especially if the combs were old and pollen-clogged, were hopelessly handi-

capped, and in a large apiary their condition was made worse if their tenants had a chance of robbing on the sly. Again, I found that the bees which wintered on a medium quantity of food in a compact position—say, six or eight frames—got through the severest part of the winter better than other stocks on 10 or 12 frames. These latter sometimes perished because, having eaten all the honey in the frames on which they were clustered, they were unable, owing to the severity of the weather, to reach other frames. But last year I was more than ever convinced of the importance of careful feeding in the spring; it just gave that stimulation which was needed in a cold, sunless time. To this I attribute my success in having forty out of forty-five colonies ready to tackle the beans; whilst about a month later a friend, who also lives in Holderness, and had placed his stocks into winter quarters with a generous supply of food, found only fifteen out of three dozen ready for the clover, so that the principle of letting well alone did not pay in his case last spring.—R. M. LAMB, *Burton Pidsea, March 14.*

#### VALUE OF STRONG COLONIES.

[5068.] I was very much impressed with the letter of J. M. U. (5,060), in your issue of March 12, on the value of strong colonies. His remarks coincide so exactly with my own views on this matter. It may, therefore, interest him to know that the very plans he suggests in the third and fourth paragraphs have been proved beyond doubt to have a tendency to bringing colonies out in strong condition without any spring feeding whatever. I cannot speak personally on the uniting of swarms and old stock at the end of the season, as the last swarm of bees I had was in 1894. I have rather lost touch with this matter but have no hesitation in saying it would be exactly as "J. M. U." says.

Some time ago I took a decided objection to the caging of queens when requeening my stocks. From previous observations I concluded it could be done in a much easier way by a sort of direct introduction, and in consequence I arranged my queen-rearing hives to meet my ideas, not thinking at the time that my plan would prove to be of such value in bringing stocks up to splendid condition the following spring. At first I attributed this "condition" to the queens, thinking they were much better than the others, but soon discovered that my idea was wrong, and that it was not the queens but the way the hives were prepared at the end of the season before that brought such good results. Briefly, then, I did exactly as "J. M. U." says (except that I was placing a nucleus on the top of a stock that had not swarmed). I first took out the parent queen of the old stock, and next day set the young queen, with bees and hive, on the top without anything

between the two lots. The hives were then treated according to circumstances. If I could remove sufficient combs from the lower chamber to meet the wants of the young queen and her bees I did so when packing down for winter; if not, the hive stood as it was, after being covered down in this position for winter, the combs were arranged during the following spring. As already said, this was done with a view to ease in requeening, but it turned out to be such a good method for securing strong stocks in the following spring, that I never think of requeening in any other way. Practically then, the method referred to above is beneficial in two ways, viz., easy introduction of queens, and helps to secure strong colonies at the proper time without spring stimulation, and this must be of great advantage to every bee-keeper, and is a step in the right direction towards success.—J. RYMER, *Levisham, Yorks.*

(Correspondence continued on page 118.)

#### Obituary.

##### JOHN WALTON.

With very deep regret we have to announce the death of Mr. John Walton, who passed away on the 7th inst. at "Honey Cott," Weston, where for over forty years past he resided. A typical bee-man of the best type, our old and valued friend retained his enthusiasm for the craft to the end of his life, and if of late years he was content to leave the more strenuous part of the work to younger hands, it may be truly said that he bore his share—and bore it well—of the labour that has rendered modern bee-keeping what it is to-day. Proud of being classed as a "bonâ-fide cottager" in the days when the dividing line for exhibition was more marked than now, he was one of the first subscribers to the BRITISH BEE JOURNAL when it started on its career as a monthly at 10s. 6d. per annum, or 10½d. per number, and up to the last it is safe to say he read every issue with undiminished interest, and never missed paying his yearly subscription in advance.

But this was only one feature of his thoroughness, for he made a success of honey producing and marketing, on the show-bench, in bee-driving competitions, and in supplying swarms for many years past he showed that bee-keeping, intelligently carried out, was worth following as a pleasant home-hobby and of adding materially to the income of a working man.

Our personal acquaintance with him began at the honey and bee show held at Preston over twenty-one years ago, during the historic festival of the Ancient Guild Merchant of that town, and from then to now our friendship was unmarred by a single jarring note of word or act. Nor shall we ever forget the visit to Honey Cott, along with our Senior Editor, during the week of the "Royal" Show,



held at Warwick in 1892. Of this visit we wrote at the time when describing his "Home of the Honey Bee" in a former issue as follows:—"Starting from our headquarters at Leamington Spa on a fine day in the 'show' week, we drove four or five miles through a beautiful part of Warwickshire before reaching Honey Cott. And a very pretty little 'cot' it is; nicely retired—just far enough

how many of God's best gifts are available in a humble home with such occupants as John Walton and his good wife."

A recent letter, from his son tells that, after recovering from his illness of last year, he felt a recurrence of his old trouble, viz., gastritis, a few days ago, and kept his bed, when on the 7th a sudden sharp pang of pain caused heart failure, and he passed peacefully away.



JOHN WALTON.  
Born June 10, 1831. Died March 7, 1903.

away from the main road to suit the owner of a goodly stock of bee-hives—and surrounded by all that makes a 'model' for an English cottager's home. The front, facing south, is covered by a large plum-tree, loaded with fruit when we saw it. Flowers, fruit, and vegetables grow in abundance in the good-sized and well-kept garden facing the cottage. Indeed, the neatness, scrupulous cleanness, and order prevailing everywhere, inside and out, made it quite delightful to contemplate

In sincerely sympathising with the bereaved family we add a closing line from his son's letter:—"You, who knew him, will have recognised his perseverance and industry in all that concerns bee-keeping. We who mourn him nearest can look back upon a model of a life of strenuous earnestness, of uprightness and integrity, and certainly of him the Master shall say:

"Well done, good and faithful servant. Enter thou into the joy of thy Lord."

## CORRESPONDENCE.

*(Continued from page 116.)*

## "SHOWING" AND "DRIVING" BEES.

[5069.] The remarks of your correspondent Mr. Waddell (5055, page 97) on "showing" and "driving" bees are, to my mind, well-timed and to the point, and those engaged in teaching bee-keeping cannot well help appreciating them. If it be so cruel as some people imagine to confine bees in an observatory hive, or to "drive" them in the bee-tent, then I am a great sinner myself. Being exposed to the light, as much as the confinement, no doubt worries the bees, but this can hardly be called "cruelty." Any way, I was one of the exhibitors at the Warwick Show last year on whom Dr. Hamlyn-Harris passed his strictures; and the heat, contrary to expectation, was certainly very trying under canvas, and my hive a little too crowded with bees under the circumstances; but, when the distress of the bees was noticed, they were promptly put in a cooler place, and more ventilation given to them. The result was that, after four days' confinement, there were not more than a score of dead bees, and after their return to the hive the stock was raising brood till the end of October without stimulation; moreover, the colony has come through the past winter well. This is the nearest approach to cruelty my bees have ever suffered through being "shown," and I have had bees for a week at a time on exhibition—in a Unicomb hive—as early as March and as late as November at bazaars or flower shows. Indeed, with proper care I have never found the colony suffer; but, on the contrary, it has in every instance stimulated the bees, and put them in the front of those left undisturbed. As to the utility of showing live bees, it only needs that one should engage in teaching to find out how much one can do with a few bees "on show," and how little without them.

The same may be said with regard to "driving," for, if done with proper care the bees are none the worse for it. I have driven skeps of bees at many scores of flower-shows, &c., and in most instances have arranged for the use of a stock in skep from an apiary in the neighbourhood. Where this has not been possible I have taken my own; and the damage done, if any, has been to the combs on a very hot day, practically the whole of the bees will enter the skep if left in a prominent place in the tent for half an hour after using. If this be cruelty then it must also be cruel to drive smoke into the hive, or apply carbolic acid "just to see how the bees are getting on," or to take away their surplus honey, &c.

"Never kill a bee" is the motto I sometimes enlarge upon, but one begins to wonder if it would not be more humane to put an end to "condemned" bees by a momentary application of sulphur fumes than to put them through the "cruel" process of "driving" or "bumping" and "uniting," in addition, per-

haps, to a long confinement in bag or box while travelling by road or rail to their new location.

While advocating the use of observatory hives and "driving" demonstrations by competent persons I am not defending the "driving competitions" that sometimes take place. These exhibitions are most unedifying to the public when, as often happens, the bees are liberated from two or three skeps one after the other. Maybe a competitor trying his "prentice" hand at the job, and "bungling" it badly. Then with broken combs and leaking honey there are "mad bees" along with commotion and worse. Under these circumstances I am sorry for the bees.—GEO. FRANKLIN, *Kenilworth, March 14.*

## A BEE-NOTE FROM CHELTENHAM.

[5070.] Though late, I send a short note of my bee-doings. I started the season of 1902 with three frame-hives, and increased to eight by making three artificial swarms and built up two stocks from driven bees (got for the trouble of driving). I finished selling my honey about Christmas, my total sales for the year being 116 sections sold for £4 6s. 8d. This is nearly 9d. per lb., and, apart from a liberal quantity for our home consumption, which has been considerable, as we are lovers of honey. Early in February I gave candy to three lots, and this seemed to upset the bees a little, but as it was fine and warm, I thought it must be useful for the bees as a cleansing flight, but there were a few dead bees at all entrances in the evening, while at my oldest stock there was a lot of yellow specking, which showed the want of a good flight. Do you advise putting swarms on old combs in skeps, as I have some by me?

Thanking you for past favours, and wishing editors and readers a good season in 1903.—C. R. H., *Cheltenham, Glos.*

## Echoes from the Hives.

*Torrington St. Clements, Norfolk, March 16.*  
—My last year's honey-take was 225 lb., as against 534 lb. in 1901. I have had a hurried glance through the hives, and find very little brood yet, although there are a good number of young bees in a few stocks; but stores are getting low in some cases, so feeding will have to be resorted to. I notice liquid honey in some hives, so it may be that the few plums and peaches in flower have yielded a little; but the bees are very busy carrying in pollen from the numerous bulbous flowers cultivated here so largely for market. My violet bees seem to have an especial attraction; the bees visit every flower. Maybe a small amount of nectar is secreted by these sweet spring flowers. We have just formed a horticultural society, with prizes for all varieties of pro-

duce, and, of course, we have classes for honey; and a novel prize, open to all, is offered for the best essay on "How to market our produce," the prize being £2.—W. J. B.

## Queries and Replies.

[3045.] *Insects in Pollen-cells.*—By this post I forward for inspection a piece cut from a comb that has been stored this winter in a spare hive. You will see by specimen that the comb is useless, being pollen-clogged, but the questions I wish to ask are: 1. What are the little insects with which comb is covered? 2. Are these insects hurtful to the bees? I have several other good, clean combs, which, having pollen in a few cells, are also infested with these insects (I notice that they invariably cluster over the pollen-filled cells, and apparently come from them only). 3. Would it harm the bees to put these combs (not nearly so bad as specimen) back in the hive this spring, and will the bees get rid of the insects? 4. How can I keep clear of the pests, which give me great trouble by seizing on to combs put by in which there is any pollen? The comb from which specimen is cut has a fair amount of honey in the upper cells. 5. What would be the best way to utilise this? I propose cutting away the offending portion and giving that containing honey, after uncapping, to the bees at once and before stimulating with syrup. 6. Is this right? Trusting you will satisfy me on these points, and thanking you for kindness past and to come.—"CHE TIENE PECCHIE,"  
*Dublin, March 11.*

REPLY.—1. To bee-keepers the insect is known as the pollen-mite, and is very common in pollen-cells, where it generates spontaneously, as the cheese-mite does in cheese. 2. They are never found on combs that are well covered by bees, nor does any actual harm come to the bees because of them. 3. A strong stock will soon rid themselves of the "mites." 3, 4. There is no better way of prevention than keeping all stocks strong and leaving the pests to be dealt with by the bees themselves. 5. Spray the pollen-cells with a solution of soluble phenyle before returning it to the hive.

[3046] *Pollen-carrying and Queenlessness.*—Kindly give replies to the following in your paper, of which I am a regular and interested reader:—1. Is the carrying in of pollen by bees a sure sign of existence of queen and brood? 2. The end comb in a hive contains some mildewed pollen. Should this be taken away, or will bees safely clean it? 3. My bees are seen in great numbers on the cabbages in garden apparently foraging, and in the inner recesses of the cabbages I often find many dead. What is the forage, and whence

the dead bees? 4. Do you consider the queen-excluder to have any disadvantages to counter-balance its advantages?—ENQUIRER, *Suffolk, March 16.*

REPLY.—1. If the bees are working with energy and carrying pollen freely, it may be fairly assumed that breeding is going on, but only examination of brood will make certain the presence of a fertile queen. 2. The bees will remove the mildew in course of time, but if comb is in bad condition, and many cells contain hard, useless, and mouldy pollen, we should remove the frame and have a new comb built. 3. There is no "forage" for bees in a growing cabbage. May be they are getting water from the leaves after rain. Regarding the dead bees found, they may have been dropped where found when being carried out of the hives by the survivors. 4. The use of excluder-zinc is a matter of preference. The great majority of bee-keepers use it, especially when working for section honey, but some practical bee-men prefer the risk of spoiled sections to any bar to a free entrance into surplus-chambers. Personally we use it for sections, but not below shallow frames for extracting.

[3047.] *Fixed Floor-boards and Frames.*—One of my hives (bought last autumn) is very old, and the frames are all fixed and immovable. I tried to get them out with a screw-driver, but completely failed, for they would not move. I want to unite the bees to a weak stock which I think is queenless. Will you, therefore, please tell me how I can get the bees out? Both hives, I may say, have fixed floor-boards. I have taken the JOURNAL for nearly two years, but have not read of how to do a job like this.—G. H. C., *Winchester.*

REPLY.—If, as stated, the frames are immovable, the only course would be to fix a box—as best you can—and get the bees out by rapping the hive-sides, as in ordinary skep-driving. We may say, however, that the driving and uniting of two stocks now in hives with "fixed floor-boards" and immovable frames is a job which needs an experienced hand to carry it through. Moreover, it is impossible for us to give clear directions in print for such a task, seeing that we have to judge of the work and the operator from a distance.

[3048.] 1. *Do Bees Injure Gooseberries?*—Will you please inform me whether bees can injure gooseberries at any time or in any condition of the fruit? In close proximity to my apiary several gooseberry growers of the prize-taking varieties have gardens, and they assert that much of their fruit last year was injured through attacks made by bees. They are threatening legal measures to compel me to move my bees further afield. 2. *Keeping Bees near the Highway.*—Also, is there a legally fixed distance from a highway that bees must be kept? 3. *Insurance of Bee-hives.*—Will you also

please say where I can obtain forms for the insurance of hives? If you have them at the B.B.J. office, please send me six for distribution amongst bee-keepers in this neighbourhood. Myself and others have frequently applied to the County Council Expert for the forms and particulars; we cannot get either from him. I send name and address, not for publication.—“BEES,” *Stone, March 14.*

REPLY.—1. Bees do no damage to gooseberry trees, either when blooming or carrying fruit. On the contrary, it has been proved that a gooseberry plantation will yield an enormously increased crop of fruit in places where bee-hives are numerous. 2. No legal distance is fixed; the only thing is to avoid placing hives so near to public highways or thoroughfares as to cause risk of harm from stings to passers-by, and thus become a public nuisance. 3. See reply to “Coniston,” *Bristol.*

#### HONEY IMPORTS.

The value of honey imported into the United Kingdom during the month of February, 1903, was £706.—*From a return furnished to the BRITISH BEE JOURNAL by the Statistical Office, H.M. Customs.*

#### Notices to Correspondents & Inquirers.

All queries forwarded will be attended to, and those only of personal interest will be answered in this column.

C. E. S. (Sutton Coldfield).—*Making Flour-candy.*—Sample sent is too dry and “crumbly” for the bees’ use in brood-rearing. It would need to be given at a time when the bees could get a plentiful supply of water outside. You have either added more than the prescribed quantity of pea-flour, or the mixture was too thick when stirring the latter in. Try again and use no more than 1 lb. of flour to 6 lb. of sugar. Pea-flour absorbs more water than wheat-flour.

W. GRIFFITHS (Staffs).—*Trapping the “Miller Moth.”*—Without knowing whether the “Miller Moth” mentioned in the old book referred to is the true wax-moth (*Galleria cereana*), it is fairly certain that the method recommended in “Dr. Harvey’s Great Book of Secrets” is not deemed of any value by American bee-keepers, or we should know all about it from the many bee-papers published in the U.S.A.

“ACONITE” (Epsom).—*Working for Comb Honey.*—We last year published the article on “Working for Comb Honey,” as detailed by G. W. Stephenson in the *American Bee Journal*, in order to afford British bee-keepers a chance of trying the plan if so disposed. Since you ask our personal view, however, we cannot say the method is at all suitable for an inexperienced bee-keeper, and especially a lady, because of the frequent manipulation involved. By all means

try the plan if you feel capable of carrying it out; but our advice, under all the circumstances, is “don’t.” Leave such methods to experienced hands of the sterner (and stronger) sex.

JAS. G. CROWN (Truro).—*Races of Bees.*—We can afford no information with regard to the bees named.

CONISTON (Bristol).—*Insurance for Bee-keepers.*—If a member of the County B.K.A. the Hon Sec. will inform you as to insurance; otherwise write to Mr. E. H. Young, Sec., B.B.K.A., 12, Hanover-square, London.

(MRS.) I. C. (Berks).—*Starting Bee-keeping.*—By joining the Berkshire B.K.A. you would be assisted in making a start with every advantage to yourself. Write to the Hon. Sec., Mr. D. W. Bishop-Ackerman, 131, King’s-road, Reading.

BALLYMENOCH (Co. Down).—*Long Sections.*—If by “two flats folded to form one long section instead of dividing into three,” you simply have a shallow frame of comb honey. On the other hand, as all sections are made across the Atlantic, it would be very difficult to get your idea carried out, even if a 3-lb. section was suitable for the market, which we doubt.

HARRY CLARKE (Coventry).—*Bacon Boxes for Hive-making.*—Much obliged for photo, from which we are having a tone-block engraved, and will send you proof when ready.

S. F. H. (Sevenoaks).—*Colonial Honey for Bee-Food.*—Your sample of half liquid honey was so unfit for inspection through mess and leakage that it was put away for the time being. It is partly granulated, and has set up fermentation, so we only advise its being used for bees by boiling with water for syrup-food, if at all.

SUBURBIA (Hendon).—*Granulated Honey for Bee-Food.*—In utilising your “good honey of 1902,” simply reduce by boiling water to the usual consistency of syrup for bee-food.

#### Suspected Combs.

*Special Notice to correspondents sending queries on “Foul brood.”*

We urgently request that all letters sent with samples of suspected comb be put outside the box or tin containing the sample. Also that no more than a couple of square inches of comb be sent, taking care to neither crush the comb nor probe the cells before despatching.

In urgent cases (and where possible) we undertake to “wire” replies as to F.B. if six stamps are sent to cover cost of telegram. All letters to be addressed W. Broughton Carr, not “Manager.”

WEST CORK (Bandon).—*Suspected Comb.*—There is foul brood of old standing in sample sent.

H. V. F. (Dublin).—Comb contains nothing worse than pollen.

“PUZZLED ONE” (Tooting).—No disease in comb, but the fact of there being plenty of drone larvæ in worker cells indicates an unmated queen.

\*.\* Some Letters and Queries are unavoidably held over till next week.

## Editorial, Notices, &c.

### BRITISH BEE-KEEPERS' ASSOCIATION

The annual general meeting of members was held at 105, Jermyn-street, S.W., on Thursday, March 19, the chair being occupied by Mr. T. I. Weston, Vice-chairman of the Council. Among those present were Lieut.-Col. H. J. O. Walker, Major Fair, Rev. W. E. Burkitt, Dr. T. S. Elliot, Messrs. W. Bishop-Ackerman, R. T. Andrews, L. Belsham, T. Bevan, R. Brown, W. Broughton Carr, W. H. Harris, L. Illingworth, W. P. Meadows, W. F. Reid, E. D. Till, Ernest Walker, F. B. White, and the Secretary.

The report of the Council for the year 1902 was presented by the Chairman, who referred with satisfaction to the marked advance which had taken place in most departments of the Association's work during the period under review. Reference was made to the insurance scheme recently inaugurated by the Society, and the heavy demands made upon the Board of Examiners of candidates for diplomas. The most unsatisfactory feature was undoubtedly the lack of regular annual subscribers, Mr. Weston making a special point of urging upon the older members the duty and necessity of introducing new subscribers to enable the Society to maintain its position, meet its obligations, and enlarge its scope and sphere of work. The report was discussed by several of those present. Mr. Till suggested the advisability of making a special appeal to persons outside the known bee-keeping world with the object of securing additional supporters, and on his motion, seconded by Colonel Walker, the report was unanimously adopted.

Mr. T. Bevan moved, and Mr. R. Brown seconded, a vote of thanks to the retiring Council and officers. Carried *nem. con.*

It was resolved on the motion of Mr. Weston, seconded by Mr. D. W. Bishop-Ackerman, that a vote of thanks be accorded to the Royal Society for the Prevention of Cruelty to Animals, for the gratuitous use of their board-room for committee and other meetings.

The Chairman also moved, and Mr. Reid seconded, the re-election of the following officers for the ensuing year: President, the Baroness Burdett-Coutts; vice-presidents, Sir James Whitehead, Bart., and the Presidents of affiliated County Associations; hon. members and corresponding members, as in 1902, with the addition of Mr. F. C. Harrison, of Toronto,

as hon. member of the Association, in recognition of his work on behalf of bee-keeping; treasurer, Mr. Henry Jonas; hon. auditor, Mr. J. Willard; analyst, Mr. Otto Hehner.

The following were re-elected as members of the Council with the addition of Mr. D. W. Bishop-Ackerman:—Hon. and Rev. Henry Bligh, G. H. Morrell, M.P., Lieut.-Col. H. J. O. Walker, Major Fair, Miss M. L. Gayton, Dr. T. S. Elliot, Messrs. R. T. Andrews, R. C. Blundell, Thos. W. Cowan, W. Broughton Carr, W. H. Harris, H. Jonas, H. G. Morris, O. Puck, W. F. Reid, P. Scattergood, W. J. Sheppard, E. D. Till, E. Walker, T. I. Weston, and C. N. White.

The Secretary reminded the members that the Society had considerably enlarged the Prize Schedule for Honey at the forthcoming "Royal" Show, and that subscriptions would be welcomed in aid of the fund to cover the additional expenses incurred thereby. In response, a number of donations were handed in, or promised, and a list of these amounts appears on another page.

A special resolution of thanks to the editors of the B.B.J., along with Messrs. Jas. Lee & Son and Mr. W. P. Meadows, was unanimously passed on the motion of Mr. Till, seconded by Colonel Walker, for the stand made by them in a recent case in the interests of honest exhibiting at shows.

A vote of thanks to the Vice-chairman for presiding terminated the proceedings.

The annual general meeting of members was followed by a meeting of the Council for the election of officers and other formal business. Mr. T. W. Cowan was unanimously elected as Chairman of the Council, Mr. T. I. Weston being similarly voted to the Vice-chairmanship.

It was resolved to hold Council meetings on the third Wednesday of each month (except August), at 4 p.m.

The following fixtures were also decided upon, viz., First Class Examination, Wednesday, May 20; Second Class Examination, November 13 and 14.

The business of the annual meeting was (after light refreshments) followed by a *conversazione* of members, which will be reported next week.

The Secretary of the British Bee-keepers Association desires to announce the fact that the books provided by the Association for use of experts on tour will be ready for issue in a few days. He will be glad to hear from county secretaries as to their requirements. The books are got up in handy form, and will each contain space for records relating to 100 visits. Price 1s. each, post free.

#### "ROYAL SHOW" FUND.

Special fund for meeting the cost of additional prizes, and other expenses in connection

with the forthcoming "Royal" Show, London, June 23 to 27, 1903.

The following amounts have been already paid or promised:—

	£	s.	d.
Thos. W. Cowan .....	2	2	0
T. I. Weston .....	1	1	0
Col. Walker.....	1	1	0
BRITISH BEE JOURNAL ...	1	1	0
E. D. Till.....	0	10	0
W. F. Reid .....	0	10	0
Dr. T. S. Elliot .....	0	5	0
Major Fair .....	0	5	0
Per Secretary .....	10	0	0

£16 15 0

## INVESTIGATIONS RESPECTING THE MICROBE OF FOUL BROOD.

A DISEASE OF BEES.

By Dr. Ul. Lambotte.

Made in the Laboratory of the Institute of Pathology and Bacteriology of the University of Liège, Belgium. Published in September, 1902, in the *Annales de l'Institut Pasteur*.

(Concluded from page 113.)

### CONCLUSION. (\*)

1. The *bacillus alvei* described by Watson-Cheyne and Cheshire as the specific agent of foul brood of bees, is none other than a variety of a common microbe, widely spread in nature, *bacillus mesentericus vulgaris*.

2. *Bacillus mesentericus* may be found in healthy hives in the cells of combs, as well as in the intestines of the bees.

3. *Bacillus mesentericus* produces by its pullulation the destruction of the larval tissues characteristic of foul brood.

These data, based upon results of experiments must be taken into consideration by bee-keepers.

Indeed, when foul brood appears in a hive one can, *a priori*, exclude the idea of the introduction of the bacillus from outside, either by worker bees coming in contact with others from a diseased hive, or by wax from such a hive containing spores being used in making foundations.

The bee-keeper must not always look for external causes of the disease in his bees and accuse his neighbour for the disasters that he observes in his own hives. Like the silkworm disease, foul brood must often result from unhealthy conditions, which, it is true, are not at present well understood, but no doubt they relate to nutrition and the hygiene of the hive and its inhabitants.

Therefore before all things (and it is not only to diseases of bees that this truth applies) hygiene and the great attention it exacts should be the study of the bee-keeper.

Certainly in the event of foul brood he

must neutralise the centre of infection. The well known great resistance of the spores of *bacillus mesentericus* to chemical agents, such as formalin, corrosive sublimate, carbolic acid, and the usual disinfectants in general, will make him reject all these substances as having only illusive effects, and adopt the only efficient method, that of destroying by fire, the infected hives.

Foul brood, however, will not disappear from the apiary even if all the spores in the diseased larvæ have been destroyed if he does not rigorously observe the hygienic laws of bee-keeping. *Bacillus mesentericus* is so widely scattered in Nature that it will again invade the larvæ if these delicate inhabitants of the hive are not placed under conditions that are normal and which are indispensable for their development.

### DR. LAMBOTTE AND FOUL BROOD.

The publication in previous issues, beginning on January 22 last, of Professor Harrison's exhaustive paper on "Foul Brood of Bees," followed by the subsequent investigations of Dr. Lambotte on the subject, being now concluded, we are, fortunately, able to complete the series of papers by printing below a further article by Professor Harrison, in which Dr. Lambotte's conclusions are criticised and in some degree controverted, so that the whole will put readers in possession of all that, so far, can be said on the important questions raised by the doctor in his theory with regard to *Bacillus mesentericus vulgaris*—[Eds. B.B.J.]

I have read with much interest Dr. Lambotte's paper which appeared in the "Annales de l'Institut Pasteur," on the identity of *B. mesentericus vulgaris* with *B. alvei* (Cheshire and W. Cheyne), but I cannot say that I am convinced either by his experiments or arguments. True, there are resemblances between the two bacteria, and at the time I commenced my work on this subject of foul brood, I had a conversation with Dr. McKenzie, Professor of Pathology, University of Toronto, who had previously done work on this subject under the auspices of the Ontario Bee-keepers' Association. I asked his permission to go on with the work, which he readily granted, and told me that he would like me to let alone the relationship of this bacillus to others, as *mesentericus* and *protens*, to which I consented.

In criticism of Dr. Lambotte's paper, made without antipathy or prejudice, I may say that the information he gives as to the morphology and biology of the bacillus with which he worked is too meagre and too insufficient for any one to decide positively as to the identity of his bacillus. I will elaborate on this point later.

I quite agree with Dr. Lambotte on the difficulty of obtaining cultures from dead larvæ, even when a microscopical examination shows many spores present. I have already

(\*) The principal conclusions of this memoir were in 1900 presented to the Congress of Bee-keepers of Dinant (Belgium).

pointed out the strong antiseptic qualities of honey, due to the formic acid present, which gives us a very probable explanation of this phenomenon.

I have not had the time to undertake personally a comparison of the two organisms, but permit me to describe briefly the morphological and biological characters of *B. mesentericus* as described by various writers, *B. alvei* of Cheshire and Watson-Cheyne, and the *B. mesentericus vulgaris* of Dr. Lambotte.

<i>B. mesentericus vulgaris.</i> Flügge.	<i>B. mesentericus (vulgaris?)</i> Dr. Lambotte.	<i>B. alvei.</i> Cheshire & W. Cheyne.
---	---	---

**Morphology.**

Small thick rods (Eisenberg).	Large motile rods with rounded ends, 3-5 μ.	Slender bacillus, pointed ends, average 3.5 μ.
Small thick rods (Novy).		

**Size.**

Thick bacillus. 1.2 - 3.5 μ (Sternberg). Ends almost square, 1.2 - 3.5 x .9 μ (Miquel & Cambier). .75 - 3.3 x .75 μ (Pammell). 1.2 - 4 μ (Eckles).	4.0 μ long (F. C. H.).
---	------------------------

**Motility Flagella.**

Motile, numerous flagella.	10 - 15 flagella.	Single polar flagella (Cowan).
----------------------------	-------------------	--------------------------------

**Stains.**

Stain easily.	No statement.	Colour badly (Eisenberg, Cheshire & W. Cheyne, Klamann, Harrison).
---------------	---------------	--

**Spores.**

Large, median, round spores; rods not swollen at sporulation.	No definite statement. "Like those described by W. Cheyne."	Spores wider than the rods; rods spindle-shaped at sporulation.
---	---	---

**Spores Germination.**

Equatorial germination.	No statement.	Polar germination.
-------------------------	---------------	--------------------

**Bouillon.**

Diffused growth wrinkled pellicle.	No statement.	Turbid, sediment, and pellicle. Turbidity clears in ninety-six hours.
------------------------------------	---------------	---

**Gelatine Plates.**

Yellowish white, slightly granular, irregular borders, liquefies rapidly and extensively, older colonies opaque, membrane in centre of liquefied cup of gelatine.	Deep colonies not characteristic; surface colonies; thin membrane with irregular colonies, showing under the microscope wavy streaks, appearing to correspond with the existence of wrinkles (folds) in the colony.	Round with fine processes and projections shooting out in all directions, forming figures in circles and club-like forms. "The forms assumed are the most beautiful - shaped I have ever seen." (Cheyne).
---	---	---

**Gelatine Stick.**

Funnel-shaped, liquefaction, thin greyish, folded scum forms on top. Liquefies rapidly.	No statement.	Arborescent, delicate, branching outgrowths on surface, and from line of puncture. Liquefaction complete in 2-4 weeks.
---	---------------	--

**Agar.**

Dull white or greyish, folded wrinkled growth.	No statement.	White spreading moist growth.
--	---------------	-------------------------------

**Milk.**

Coagulated with subsequent digestion, wrinkled film on surface (Slimy, Flügge, Pammell, Chester).	Coagulated, then a part of the coagulum dissolves.	Coagulated in 3 days, yellowish with odour. Curd digested after several weeks.
---	--	--

**Potato.**

Characteristic growth, thick white, markedly folded and wrinkled, growth tenacious or sticky. Colour variously described.	A greyish layer, scalloped. ("Festonnée.")	Growth varies, dry yellow layer to brownish and slightly wrinkled. Odour.
---	--	---

**Blood Serum.**

Liquefies, grows well at room temperature (Eckles).	Rapidly liquefied.	At 37 deg., growth is rather slow and very long filaments form. Clubbed and Y-forms common. Spores sparingly formed. Liquefaction.
---	--------------------	--

**Indol.**

No Indol (Chester, Horrocks).	No statement.	Slight Indol.
-------------------------------	---------------	---------------

**Aerobiosis.**

Aerobic. No growth under mica plate.	No statement.	Facultative anaerobe. Growth in hydrogen.
No growth in closed arm of Smith tube (Eckles).		Growth in closed arm of Smith tube.

**Gas Production.**

Some authors do not mention gas production. Pammell found gas in lactose and saccharose, but none in glucose.	No statement.	No gas in glucose, saccharose or lactose.
---	---------------	---

**Thermal Relations.**

Grows at ordinary as well as higher temperature (Novy, Eisenberg).	No statement.	Optimum 37.5 C. Maximum 47.0. Minimum 16.0.
--	---------------	---

**Death Point.**

Various. 1 hour at 100 (Pammell). 10 hours or more (Novy).	No statement.	3 hours at 100 deg. C.
--	---------------	------------------------

The above description of *mesentericus* (Flügge) is taken from the works of Migula, Sternberg, Novy, Eckles, Horrocks, Eisenberg, Lehmann and Neumann, Miquel and Cambier, and Pammell; but it is well to remember that there are many types of *mesentericus* in this group, and closely allied to it we have *B. mesentericus fuscus*, *B. mesentericus ruber*, *B. subsilis*, *B. liodermus*, *B. mycoides*, *B. ramosus*, *B. megatherium*, all showing greater resemblance to *vulgaris* than does *B. alvei* (Cheshire and W. Cheyne).

A brief glance at the above table shows that there are important and wide differences between Dr. Lambotte's isolated germ and *B. alvei*. The morphological differences are important, *mesentericus* is a stumper bacillus than *alvei*, and the fact that spore formation is so different in the two species is quite sufficient to make them different species, as is also the method of spore germination. The gelatine cultures are also entirely different.

Hence, I am forced to believe that Dr. Lambotte started out on his experiment, not

with *B. alvei*, but with *B. mesentericus vulgatus*, and hence all his experiments are misleading.

Dr. Lambotte's experiments with *vulgatus* cultivated in bee larvæ bouillon are not convincing, as the larvæ were killed by pricking, surrounded with a culture of *B. m. vulgatus*, and naturally putrefaction would set in when *vulgatus* was thus introduced. Theropy or viscous character of cultures of *vulgatus* is well known, and we would expect this phenomenon.

Although *B. m. vulgatus* is one of the most ubiquitous bacteria, and is present in most soils, whether European, American, or Australian, I have never heard of foul brood being indigenous. All cases in new countries (especially is this the case with Canada and Australia) may be traced to infection from bees, or bee-keeping supplies brought from countries or localities where foul brood was prevalent. If Dr. Lambotte's contention that *B. m. vulgatus* and *B. alvei* are the same is true, we should naturally expect to find cases of foul brood occurring spontaneously in countries which have never imported bees or supplies from infected places.

As a matter of fact, we know that the chief method of carrying the disease from one hive to another is by bees from healthy hives robbing colonies that have become weak and diseased, and the traffic in bees and bee-keeping supplies probably favours the spread of the disease.—F. C. HARRISON.

#### BIBLIOGRAPHY.

- Chester—Manual of Determinative Bacteriology, 1901.  
 Horrocks—Bacterial Examination of Water, 1901.  
 Sternberg—Manual of Bacteriology, 1892.  
 Eisenberg—Bakteriologische Diagnostik, 1891.  
 Eekles—Centr. f. Bakt. II., 1898, p. 730.  
 Pammell—Centr. f. Bakt. II., 1896, p. 632.  
 Miquel & Cambier—Traité de Bactériologie, 1902.  
 Migula—System der Bakterien, 1900.  
 Cornil & Babes—Les Bacteries.  
 Novy—Laboratory Work in Bacteriology, 1899.  
 Flügge—Die Mikroorganismen.  
 Lehmann & Neumann—Atlas and Essentials of Bacteriology.  
 Cowan—Journal Royal Agr. Soc., Vol. VI., Part IV., 1896.

## LANCASHIRE B.K.A.

### ANNUAL MEETING.

The annual meeting of this Association was held in the Scientific Society's rooms at Preston on Saturday, the 28th proximo. Mr. W. H. Johnson presided, and amongst those present were Messrs. R. Tyrer, A. M. Fielding, T. Ormesher, J. Dickinson, Jas. Sutton, H. Berkeley Score, J. H. Walmsley, P. Shackleton, W. Lloyd, Geo. Rose, W. A. Cook, J. F. Williamson, and others. The report and balance-sheet as presented were adopted. Sir Alfred Jones was elected President, and the Vice-Presidents were re-elected, as were also the Committee, with the additions of Messrs. R. Tyrer, J. Dickinson, and H. Berkeley Score.

The following re-appointments were also made:—Treasurer and Librarian, Mr. F. H.

Taylor; Secretary, Mr. J. F. Williamson; Lecturers, Messrs. F. H. Taylor and J. F. Williamson; Auditor, Mr. Alfred Wood.

The thanks of the Association were accorded to the Technical Committee of the County Council for providing lectures at the Royal Lancashire Agricultural Show, also to the Committee and officers of the Association and local Hon. Secretaries.

During the year 66 new members have joined the Association.

The experts' tour was conducted by Messrs. H. Edwards, F. H. Taylor, J. F. Williamson, J. H. Walmsley, Collinge, Forrester, and T. Ormesher. More than 300 members were visited, owning amongst them 1,317 frame-hives and 88 skeps, which were found generally in a satisfactory condition. Foul brood was reported in several instances, principally in the northern part of the county, but this shows a great reduction to previous years, and it is hoped will be quite cleared from the county in the course of another year or so.

Four members had gained third-class experts' certificates, and one had been successful in the second-class examination.

At a subsequent meeting of the Committee Mr. George Rose was elected Chairman and Mr. George Roberts Vice-Chairman.

Later in the evening the members re-assembled to hear read a paper on the "Structure and Anatomy of the Bee," illustrated by diagrams and with microscopes, by a member of the Preston Scientific Society. The reader was assisted by several other members with the use of microscopes. The paper was well prepared and delivered, and the microscopic slides were very good and most interesting. After the paper there was a general discussion on the subject of bee-keeping, and the Secretary replied to such questions as were asked. The proceedings were brought to a close by a hearty vote of thanks to the members of the Scientific Society for the paper and the gratuitous use of their room.—J. F. WILLIAMSON, Secretary, Fleetwood, Lancs.

## Correspondence.

The Editors do not hold themselves responsible for the opinions expressed by correspondents. No notice will be taken of anonymous communications, and correspondents are requested to write on one side of the paper only and give their real names and addresses, not necessarily for publication, but as a guarantee of good faith. Illustrations should be drawn on separate pieces of paper. We do not undertake to return rejected communications.

### THE STINGLESS BEES OF NORTH AND SOUTH AMERICA.

[5071.] In "Gleanings" in *Bee Culture* for November 1 (pages 904-905), Mr. W. K. Morrison writes on "Stingless and other Bees," advocating domestication of the so-called stingless bees of Mexico. I am at a



loss to understand why the Editor goes so far as to add a footnote to the effect that "This is the most interesting and valuable article we have ever had on stingless bees." It is so generally recognised as a fact that the species of the genera *Melipona* and *Trigona* are vastly inferior to *Apis mellifica* that one cannot but be surprised at any one suggesting domestication. I should therefore like to make a few remarks in your pages on the subject of Mr. Morrison's paper, and hope that our friends in America may see them.

The stingless bees represent various species of wild bees of North and South America, and are indigenous to these parts, whereas *Apis mellifica* is not. *Melipona* belonging to the *Apidae* (*Hymenoptera*) are small, squat bees with varied colours. They lay their eggs on combs placed horizontally—combs in a single tier, mouth downwards.

Both honey and pollen is stored in large, irregular cells of wax to be found in the proximity of the brood-nest. This alone makes the idea of domestication ridiculous, and induces the question: If *Melipona* and *Trigona* were of any use as honey and wax producing species, why was *Apis mellifica* ever introduced into those parts where the former abound? Yet we find that *Apis mellifica* has to some extent displaced the stingless bees, and has maintained itself wherever introduced, especially in civilised countries—not only so, but it has yielded for the bee-keeper and others rich harvests of honey. It has also increased to no small degree the fauna of those parts, living in some parts of America in a wild state, side by side with the native bees. I therefore ask:—

What advantage would accrue from the introduction of such a species?

Mr. Morrison says, "There can be no standing still," but any move such as he suggests would undoubtedly be a retrograde step. Again, as to the quality of honey. What sort of stuff does our American friend think of placing on the market? Or does he deem this stuff worthy of another name, viz., "*Melipona*"? Surely no man in his senses would dream of buying the latter if he could buy pure and good honey, such as we are accustomed to. And how does he imagine that this stuff is going to keep without the necessary proportion of formic acid, or some equally good preservative; and if it is not honey—as he wishes to point out—why introduce the species at all? Then, as to beeswax, we are told that the wax secreted by these bees is not as useful as ordinary beeswax, and that *Apis mellifica* is cultivated for the purpose of getting beeswax. He suggests the name of "*Cerise*" for this local product. The above facts alone suffice to show the utter absurdity of giving a thought to these bees in the direction advocated as a forward movement.

Should "*Melipona*" be introduced for purposes of domestication, then we shall simply possess a bee which admittedly gives us

nothing worth comparing to the advantages obtained from the honey bee.

Unless where really necessary it is always undesirable to add to the confusion of names and the word, "*Melipona*," for the honey of wild bees is undesirable and confusing, especially when we realise that we have in modern times suited our ideas to our own conception of what honey ought to be rather than to the nectar of flowers, which is the original meaning of the word as used from the earliest times, irrespective of the kind of bee producing it. Ancient records show that the earliest cultivated bee was closely allied to, if not actually *A. mellifica* itself.

The name "*Cerise*" is also suggested for the wax, and there is less objection to the introduction of names for certain kinds of wax.

In commerce there are various kinds of made-up or manufactured wax which bear special names. Nothing in the world, however, will alter the fact that this product of the bee, whether it is made by one kind of bee or another, will remain beeswax in the ordinary sense of the word.—R. HAMLYN-HARRIS, D.Sc., F.R.M.S., F.Z.S., F.E.S., &c.

#### STRONG COLONIES.

[5072.] Your correspondent ("J. G.," 5036, page 64), is very decided in maintaining that the securing of strong colonies depends upon the queen alone, and this teaching might lead the unwary to believe that success would be merely a matter of inserting "*Doolittle*" queens; but I think the experienced bee-man knows better.

The best queen in the apiary may be selected young ones raised from her and inserted at the right time, which is, of course, the end of season, or, in heather districts, before moving, but the widely different results in the following season will completely disprove the idea that the queen alone is responsible for the success or otherwise of the colony.

The queens may all be equally prolific, but it is only those that are enabled to display their powers at the right time that will have their colonies ready to make the most of the harvest.

"J. G." finds fault with me for suggesting autumn uniting as an important step in the securing of strong colonies at the right time. He himself recommends uniting just before the flow commences. But how are the bees and combs of brood to be got?

Evidently, by dividing at the end of the previous season. If "J. G." is in the habit of dividing at end of season, his bees will in spring be in just the condition he seems to prefer, i.e., covering three or four combs. I can believe that, by means of "stimulating," and spring-juggling à la *Doolittle*, such colonies might be made strong in time for the honey-flow, and I can assure "J. G." that he is quite right in saying he could expect no surplus by dividing such colonies. The

modera bee-keeper wants to have his stock ready for the harvest without any spring "nursing," and this is only possible with correct autumn preparation.

The methods generally recommended are uniting with driven bees, or with nuclei made by dividing other stocks, but I think that the best results are to be had by making each colony self supporting, and this can be done by taking full advantage of the queen's prolificness. It is well known that when extracted honey is desired, the "doubling" system is an almost certain preventive of swarming. And if this be so, why not when working for comb honey? I ask because the apiarist is aware than an extension of the brood-nest during the honey-flow would prove unfavourable to his hopes of a heavy surplus.

But if we can manage the "doubling" business before the honey-flow comes on, then contract to ten frames—an empty chamber with "starters" taking the place of the removed brood box, the colony is put in a position to make the most of the harvest, and by giving back the removed portion when the honey-flow ends, we lay the foundation of a successful season in the following year.!

The securing of strong colonies is not the greatest difficulty; at some period of its existence almost every colony in the apiary has been really strong, the trouble is to keep them in that desirable condition. If this is to be done, the insertion of a young prolific queen at the end of season is not alone sufficient, we must also see that she is placed in a position to be able to do her utmost at the right time.—J. M. E., *Ussie Valley, N.B.*

#### "SHOWING" AND "DRIVING" BEES.

[5073.] Referring to the recent correspondence in the B.B.J. on the cruelty of "showing" and "driving" bees, I note there is one aspect of the case not yet touched upon, but of which my own case must be typical. I am a novice now of nearly one year's standing, having last May purchased a swarm in skep and covered with a cheese box. After consulting all the available literature, I decided to leave the bees where they were till end of September and then "drive" them, and during the whole summer was in more or less dread of what would happen when the time for operating arrived. I was determined to go through with it come what might, but feared lest I should lose the whole lot through mismanaging the job, or, worse still, so infuriate the bees as to set them on the warpath against all the children up and down our road. To have any such fear may sound very comic or even silly to the veteran expert, but to be a bit nervous is very natural to the unaided novice, and it is for such that exhibitions of bee-driving and "management" are expressly intended. Having noticed in one of your July issues that a bee demonstration was to be given about five miles from my place at

Chingford, I made a point of attending, and saw the bees driven from a skep. The impression on my mind was very profound. To see the demonstrator go to the skep, puff in at the entrance about three whiffs of smoke (I should have given thirty), then offer a few moments explanation, after which three or four "pats" with his hand on each side of the hive (I should have shaken the bees and skep as if sifting cinders); then another word or two of explanation, after which the full skep was turned up-side down, an empty skep fixed above the full one, another few taps, and the bees started running up; all done so quick, so quiet, so deliberate, and without a bit of fear. Moreover, in trying to find the queen, he stroked and handled the bees like shrimps!—bees hung from his eyebrows, walked round his ears, and dozens of them crawled over his clothes; yet he was as unperturbed as may be. After this practical demonstration of bee-handling I no longer feared the evil day, but yearned for the time to come when I could try my 'prentice hand at bee-driving, and when the time did come, I am certain that my complete success was owing to that display in the bee-tent. I was sorry at the time when the demonstrator failed to find the queen, because, so far, I have not seen a living black queen; but, on the other hand, it proved to me a valuable object-lesson, because I now realise that if an expert can miss the queen, it would be madness for me to pronounce a hive queenless because of failing to find her. No doubt, many novices are led, from book reading, to expect to see a giant bee in the queen, instead of an insect very slightly larger than the worker, as some queens are.

I have somewhat minutely described the impressions produced on myself in watching the process of "driving," purposely because "old hands" cannot realise a novice's first idea of handling bees, wherein he has visions of clouds of angry bees, stings galore, swollen hands and head, followed by days of agony in bed. This fear soon passes, no doubt, and I can myself now venture an amused smile at beginners fearing to put on their boxes of candy without a veil and gloves or a deluge of hot smoke to aid them in their work.—SUBURBIA, *Walthamstow, March 19.*

#### HOME-MADE HIVES.

[5074.] Since I got your reply to my queries regarding "Hive-making for Beginners" on page 100 of B.J. for March 5, I have been staying with a friend who is an enthusiast on bee-keeping, and who also makes his own hives. When I told him I intended making a start with bees and had got some used boxes which I proposed to use up in making some hives my friend said "Don't!" Then he added: "Old boxes will cause bad language whenever you come across a nail!" He further said, "I'll show you a trick worth two

of that," and, in the end, he took me to a saw-mill and proceeded as follows:—He selected a board of red deal (free from knots) 12 ft. long, 9 in. wide, and 1 in. thick, and had a piece cut off it 2 ft. long; this piece was cut into four strips about  $2\frac{1}{2}$  full wide. The remaining 10 ft. was sawn in two halves, thus giving 20 ft. of 9 in. by  $\frac{7}{16}$  in. of clean board. The cost of wood and sawing was 2s. I then had material for making a hive 18 in. square, *i. e.*, 9 ft. will make the body-box with double walls on two sides, one of the four strips mentioned as  $2\frac{1}{2}$  in. wide, goes between the double walls, the space being packed with straw, two more of the  $2\frac{1}{2}$  in. strips are for nailing the floorboard to, and 9 ft. of board cut down to 6 in. wide makes a "lift" with  $5\frac{1}{2}$  in. inside walls—the latter being movable. The strips cut off in reducing board form the plinths, while the remainder of the 9-in. stuff makes the floorboard, and for a further outlay of 9d. for more new wood I can have a roof all of new wood. We can then make an alighting board from the lid of an old box and use other parts of latter for stay-pieces under the floorboard to keep it from warping.

We thus get a hive at an outlay of 2s. 9d. for wood; paint and nails, 8d.; sand paper, 2d.; total, 3s. 7d.

The wood is rubbed down with coarse sand-paper. I shall make two or three dummies for use, and, of course, buy my frames and foundation from a dealer, but I am going to "get my stable ready before I buy my horse," and hope to make a good start with the bees.

Since writing above I came upon a strong lot of bees in a wall of a farm which I took. I am only in my infancy on bee management, but I hope one day to know all.—"JIM," Ipswich, March 19.

#### BEE NOTES FROM SOUTH WALES.

AN "ECHO" UP TO DATE.

[5075.] So far this season our bees have had very few days in which they could venture far from the apiary, and though the strongest stocks make the most of every shining hour to carry in supplies of fresh pollen, the majority appear in only a half-awake condition, which I believe would be still worse if a good sized cake of warm candy had not been given them in the closing days of February. A glance under the quilts of thirteen of my hives to-day (21st) disclosed every stage of development, from the empty celled and diminutive cluster to the fully stored ten-frame covered stock. One stock of beautifully marked bees, the descendants of a stray swarm that entered my apiary a few years ago, is in excellent condition. The heat experienced on placing my hand between the layers of quilts prepared me at once for the splendid sight the removal of the quilts exposed to view. I had noted their extraordinary energy last season when the rest seemed to have lost heart at the thoroughly bad season they were having. It is my present intention to reserve this stock for

queen-raising this year. Another stock, that, from its present appearance, I anticipate will give a good account of itself if the coming season proves a good one, was wintered with a sheet of celluloid placed on top of frames without first removing the brace combs; and from the number of bees that can now be seen through it, clustering on tops of frames or passing backwards and forwards over them, I guess they must have had an ideal winter-passage, and this accounts largely for their present advanced condition. Who will say, then, that brace-combs and  $\frac{3}{4}$  in. top bars are altogether bad?

Unless the weather changes soon for the better, we shall not have our usual early taste of March honey from the willow, for which our district here is noted, but perhaps before these few lines appear the apiary will be once more alive with busy bees tumbling over each other into the hives with loads of yellow pollen, and heralding the prospects of a record season to—H. S., Llandeibie, Carmarthenshire, March 21.

#### BEEES AND FLOWERS.

[5076.] In last issue your contributor, "D. M. M.," in his remarks on "Bees and Flowers" (page 114), mentions several most interesting points, and I, with others of your readers, would like further information on the following questions:—1. Has the deterioration of flowers by the absence of bees or insects been experimented on, and if so, with what result? 2. Is there any experiment recorded tending to prove that the lip on which the bee rests when it visits these irregular flowers is the result of irritation in that particular part of the flower, caused by insect visits? 3. Have we any knowledge, beyond the experiments of Lord Avebury, that bees observe and prefer certain colours? The subject of insects and flowers is of so great an interest that I trust "D. M. M." or others of your readers will give us the benefit of their study and observation.—H. SHERWOOD, Grantham, March 23.

#### OBITUARY.

DEATH OF C. M. NESBITT, ESQ., J.P.

It is with very great regret that I announce the death of C. M. Nesbitt, Esq., J.P., late treasurer of the Lincs. B.K.A., which occurred suddenly at his residence in Louth on March 18. Mr. Nesbitt was treasurer of our Association from 1889 until the close of last year, when he resigned on account of failing health. He took great interest in bee-keeping and the work of the Association, himself a vice-president and also a bee-keeper, until he became too infirm to attend to his bees, they being located some distance from his residence. He has been a true friend to our cause, and has done a great deal to help the success of our Association in Lincs.—R. GODSON, Tothill, Alford.

## "SPRING RADIATIONS."

(With apologies to "D. M. M.," Banff, vide B.B.J., page 93.)



Victim, (loq.) :—Shade of Swammerdam! Must have left that Radium in all winter!!

Friend "D. M. M."

You say a pinch of "radium" dropped gently in a hive,  
 Will make its apic contents very, *very* much alive,  
 Will make the bees more vigorous, more strong upon the wing;  
 But you quite forgot to tell us *how much harder they would sting!*

This modern tree of knowledge is beyond the wildest dream,  
 But an overdose of "radium" might upset our little scheme;  
 And if the strength developed with the powers of the head,  
 These very "twencent" bees might take to *keeping us instead.*

But stay! Perhaps the remedy will cure its own disease.  
 We yet may take advantage of this luxury and ease—  
 Against its disadvantage it must be its own palladium,  
 For when we go to tend our bees *we'll rub ourselves with Radium.*

L. S. CRAWSHAW.

## Queries and Replies.

[3049] *Clearing Bees from Surplus Chambers.*—My hive roofs are fitted with bee-house escapes—1. Can I dispense with super-clearer by putting a cloth under the super to be removed, letting the bees escape from the roof? 2. Referring to fumigation by salicylic acid vapour, mentioned on page 83, are the bees exposed to the fumes or only the combs? 3. Would not this be a better plan than using sulphur to disinfect spare combs.—J. R., *Middlesex.*

REPLY.—1. Yes, but you would find true economy in investing a couple of shillings on a good super-clearer, in the saving of trouble and risk of worse mishaps. 2. *Fumigation by Salicylic Acid*—This needs an appliance (costing 10s. 6d.) which is placed at the hive-entrance, and the fumes—diffused by the aid of a spirit-lamp—permeate the whole hive, bees and combs. 3. No. The “fumigator” referred to is only used for the purpose of curing foul brood.

[3050] *Bell-Glass Supers*—I have two nice skeps of bees (besides nine stocks in frame hives) and am wishing to try my luck at working bell-glasses on the skeps. But I do not know the best way to ensure success, and should be thankful for a little advice on the subject from some of your correspondents who have used bell-glasses. I have been a subscriber to both papers for many years and could not get on at all without them. I want a bell-glass of honey for our flower-show in the summer. Thanking you in anticipation, —“DRONE BEE,” *Norfolk.*

REPLY.—After selecting your bell-glasses, provide a very thin board on which the glass will stand above a centre-hole to correspond with the feed-hole in skep. The glass will have a ventilating tube of perforated zinc through its centre, and on this tube is fixed a piece of ready-built comb to give the bees a start at comb-building. Cover the glass warmly by means of a “cozy,” such as is used over a teapot, and pack with warm material to allow no escape of heat from the brood-nest of skep other than what ascends into the bell-glass. If honey is coming in and bees are strong, they will soon take possession and fill the glass.

[3051] *Bees Changing in Temper.*—Would you kindly inform me in query column as to what breed the bees belong to which I forward? The originals I purchased as a swarm in 1901, and the vendor described them as English bees, which I am inclined to believe was correct, but I feel sure the queen was a cross-bred one, for the bees soon showed a difference in markings and temper. Last year, although a very bad season, they gave me a 10 lb. swarm and 9½ lb. of surplus honey. In 1901, however, they stung my

seven Wyandotte cockerels, five months old, of which three died in less than two hours; their heads resembled thistles from the stings. I must admit I had been trying to force a frame in a place it did not come from. Thanking you for your trouble.—R. H. C., *Southport, March 19.*

REPLY.—Bees sent are hybrids though not a first-cross; they have distinct traces of Carniolan blood, which may account for their quieter disposition last year, so it is a fortunate change for the better.

[3052.] *Queen-Cell in March.*—On looking through my hives this afternoon I found the bees had come through the winter well, and there were patches of sealed brood on three or four frames. In one hive, however, I noticed an empty queen-cell on a frame, with a fair amount of sealed brood in the middle of it; and on the other side a lengthened-out worker-cell which evidently contained a drone larva sealed, and in the same stage of development as the worker-brood around it. I also noticed some young larvæ, but could not examine the combs very thoroughly, as a strong wind was blowing at the time. I therefore ask, Is there anything wrong about this, and what does it indicate? The hives are strong in bees.—S. G. S., *Beddington, March 21.*

REPLY.—The single sealed drone-larva in worker-cell is a slightly suspicious sign of something wrong, particularly if the empty queen-cell on same comb is a recently-built one. You had therefore better examine the combs again for further developments of queen-cells, and also of more drone larvæ in worker-cells, before assuming that the queen is either failing or being superseded by the bees themselves.

## Echoes from the Hives.

*Chichester, March 19.*—We are not having good bee weather here in the South at present. Stores in hives are getting short, and pollen coming in slowly. Bee-keepers must be on the alert, for this is the time when bees will require attention with regard to stores. My losses this winter have been about 10 per cent. of the whole. I also deeply regret that we bee-keepers have to bear a great loss in the death of our old friend John Walton, who was always ready to send an “Echo” to B.B.J. I remember, “ever since the time I first started bee-keeping in 1886,” reading with pleasure the useful “Echoes” from his pen, and may all bee-keepers echo a note of sympathy to those near and dear to him.—JOHN DANIELS.

*Burghwallis, Doncaster, March 21.*—Everything betokens a very early spring, and were it not for the large amount of wind (cold and otherwise) that we are having, I think bee-keepers in this part of Yorks would begin to throw aside their lethargy, and rouse once

more the enthusiasm which has been smouldering so long. As I write the sun shines brightly, and the bees are dancing merrily round the hive entrances, or coming home laden with the pollen which is now so plentiful. The crocus is now at its best. Wood anemones are in full bloom in sheltered spots, violets on every bank and hedge-side filling the air with their lovely perfume; and what is more to bee-men, the willow palm is in full bloom too, and the bees are revelling in its wealth of golden pollen and hurrying home as dusty as millers, only to start again for another load. Nor are the water-troughs neglected, for you can always find a few bees busy water carrying. The pear and the plum-trees are just bursting forth into a mass of whiteness, and I notice one sycamore-tree has several branches in full leaf, and I naturally wonder how long it will be before the bloom will appear, and then for the hum of the bees.

I am afraid stocks will not open out very strong this spring. I have not overhauled mine yet, but I expect a few lots will want uniting as the queens stopped breeding very early with us, and little late honey was gathered, in fact, last season was the worst I have known, and sugar-feeding has been and is still the rule. The bees have been keen on robbing wherever there has been a chance, and noticing one hive I found they had cleared all out but the queen, the bees evidently having gone with the robbers. So I thought they had better take her, too, and I ran her in at the thieves' entrance. I have watched daily since, to see if she was thrown out, but have not found her. So I concluded they were queenless and had accepted her, as she would probably have the same scent with being so often in contact with the rogues. I am afraid my echo has grown far too long, so I will conclude, hoping for a rousing good time this year for all.—H. F. G.

[Cordial thanks for your box of spring blooms, accompanying your "Echo." They afforded a "whiff" of perfume that makes us Londoners excusably envious of the primrose and violet-laden banks and hedge-rows of Yorkshire in springtime.—EDS.]

### Notices to Correspondents & Inquirers.

All queries forwarded will be attended to, and those only of personal interest will be answered in this column.

L. N. (Sussex).—*Using Naphthaline in Hives.*—Two of the balls—split in halves—is the proper quantity, and the pieces must, of course, be placed *inside* the brood-nest furthest away from entrance. To put it between outer case and hive would be of no use whatever.

W. S. (Blackpool).—*Best District for Bees.*—There is no district—or even county—in England that can be named as "the best for bees." Moreover, it will need more than "some little knowledge" which you now possess

before bee-keeping alone could be relied on as a means of income. The best course would be to try and obtain employment at a small wage with an experienced man, who combines honey-production with some other trade, and thus see how you like the prospect of success. There are good bee-districts in several counties, among them Cambs, Hants, Berks, Essex, Surrey, Sussex, and Kent, &c., in the South, and in the North where the pasture lands yield white clover and the moors are also available for a heather crop.

S. R. (Newcastle-on-Tyne).—*Reporting Meetings of Bee-keepers.*—We are very pleased to hear of the effort to ensure co-operation among the bee-keepers of your locality in combatting foul brood, and hope the County Council will assist as proposed. The meeting, however, hardly possessed sufficient interest for general readers for us to find room for report just now. Let us know if your effort is successful, and we will be glad to publish your good fortune. Meantime, space is only available for reports of annual meetings of associations.

A. HEMSLEY (Tonbridge Wells).—*Transferring Bees on Frames.*—There will be no difficulty or risk of damage if the frames in home-made hives are of standard size. The new hive must be set on the old stand with entrance in same position as before. The difference in shape of hive will cause no loss of bees.

F. W. M. (Ventnor).—*Wax-cake Picked Up at Sea.*—1. There is not a particle of beeswax in sample. It is merely coloured ceresine wax, worth about 2d. per lb. 2. The honey sent is good in colour—for a "medium" coloured sample—and consistency, but in flavour and aroma it is only of fair quality.

H. C. W. B. (Kent).—*Transferring Frames to "W. B. C." Hive.*—If frames in old hive are of "Standard" size they will transferred to and fit the new one in a few minutes, with no harm whatever to brood or bees, if done on a warm day. No need to wait for swarm, if transferring is preferred.

#### Suspected Combs.

SISS (Cranbrook).—The bit of old and black drone comb sent had three sealed drone-cells, all the rest being entirely empty, as were also the sealed cells. All trace of the dead larvæ had dried up and disappeared long ago. The sample, therefore, gave us no help in judging with regard to cells containing brood in other combs now in hive either hatching out or dead in cells.

NOVICE (Kent).—Comb contains foul brood in very pronounced form. The combs and frames should be burnt, but if the hive is worth saving, it may be used again after thoroughly disinfecting it.

T. R. (Maentwrog).—No disease in comb. Cells contain a small quantity of dead brood, which is "chilled" only.

## Editorial, Notices, &c.

### DR. LAMBOTTE AND FOUL BROOD.

The following article by our Senior Editor comes opportunely as a reply to the expressed desire of the Chairman at the *Conversazione* of the B.B.K.A. to have Mr. Cowan's views on the subject under discussion.—[W. B. C.]

We almost feel that some apology is due to our readers for devoting so much space recently to foul brood, but our excuse is its importance to bee-keepers. The short notices of Dr. Lambotte's investigations on foul brood in various papers, often incorrectly interpreted, have in some quarters created quite a scare, some even thinking that the end of bee-keeping was in sight. We have received numerous letters on the subject, and have therefore thought it desirable to translate Dr. Lambotte's paper, and to present his views to our readers. We have also considered it advisable that Professor Harrison's paper should appear, as we consider it far the more important of the two, showing as it does careful, painstaking work and observation, and we recommend its careful study to all our readers.

An examination of Dr. Lambotte's paper will at once convince the unprejudiced mind that there is very little to be alarmed about. It is quite true that Dr. Lambotte says *bacillus alvei* and *bacillus mesentericus vulgaris* are one and the same, and that all previous investigators have made a mistake, but it is not necessarily true because he says so. Probably *vulgatus*—the name originally given to this bacillus by Flügge—is meant, and *vularis* is merely a misprint. A careful perusal of the paper will show that the doctor assumes a great deal, and does not prove his case satisfactorily. He says the two bacilli have the same shape and size, and behave in the same way when cultivated. There is very little in this, for on examining the criticisms appearing on page 122, to which we wish especially to draw the attention of our readers, Professor Harrison therein goes carefully into a comparison of these germs, and it will be seen that the morphological differences between the two bacilli are very important, and quite sufficient to make them two species, more particularly as spore formation is so different. That the products of both have a ropy and viscous character does not necessarily make them identical, and even if they were they might be produced by different bacilli. Much importance is given to an assumption that the harmless *B. mesentericus* can be, under certain conditions, made to produce disease, and upon this hypothesis—not generally accepted—Dr. Lambotte bases all his conclusions. He is unfortunate in his illustration, for he does not prove that "flacherie" in silkworms is not produced by a specific germ, but only thinks that "if the investi-

gation were again taken up with the present knowledge it would be found that at least one of the forms of this malady would be traced to microbes of the mesentericus family." There is not a shadow of evidence in support of this theory, or that mesentericus has anything to do with the disease, and even if it did it would prove nothing in regard to foul brood. We certainly cannot understand Dr. Lambotte trying to maintain his theory in the face of his experiments. He failed entirely to produce foul brood with a cultivation of *B. mesentericus* spread over the brood. Some of the larvæ were killed and surrounded with infecting material, but after three days the bees had cleaned out the cells, and there was no further damage. Although this experiment was repeated a number of times, it failed in every instance to produce the disease. We know perfectly well from long experience that such an experiment with *B. alvei* would have produced foul brood in a virulent form in the strongest hive. Having failed, Dr. Lambotte tried a bouillon made with bee larvæ for his cultivations; but here, again, the results are misleading, for his larvæ were killed by pricking, and surrounded, as Professor Harrison points out, with a culture of *B. mesentericus vulgaris*, and it is natural to expect putrefaction would take place under such conditions. This bouillon may have produced symptoms similar to foul-brood in some of the larvæ, still it might not have been the disease. We do not believe it was, for if a fifth only of the infected larvæ became diseased, foul-brood in a virulent form would, undoubtedly, have invaded that colony in a very short time, from which it would not have recovered so easily. Because both bacilli have the same effect upon blood serum, Dr. Lambotte considers as conclusive evidence of their identity. The two may act similarly in the way of agglutination, but they are different for all that, otherwise there would have been no such difficulty in producing foul-brood with *B. mesentericus* as was encountered.

Again, we cannot accept Dr. Lambotte's conclusion that, because certain germs are found in the tissues or surrounding the digestive tubes, that they were necessarily the causal agents of such disease. Koch introduced four postulates generally accepted by bacteriologists, and until each of the four has been fulfilled the causal agency of the disease must be considered *sub judice*. These postulates are:—

1. The organism must be demonstrated in the circulation or tissues of the diseased animal.
2. The organism thus demonstrated must be cultivated in artificial media outside the body, and successive generations of a *pure culture* of that organism must be obtained.
3. Such pure cultures must, when introduced into a healthy and susceptible animal, produce the specific disease.
4. The organism must be found and isolated

from the circulation or tissues of the inoculated animal.

It is quite evident that Dr. Lambotte has not fulfilled these four postulates, whereas other investigators have done so with *B. alvei*.

*Bacillus mesentericus* is found almost everywhere, and were it the cause of foul brood we should also hear of this disease wherever bees were kept, but there are many districts where foul brood has not been known to exist, and in every case of an outbreak where investigation has been made, it was found that it had existed there before or had been by some means introduced.

Unfortunately Dr. Lambotte is a pessimist and holds out no hope for the bee-keeper, as the spores of the disease are always present; and, although recommending burning he says even that will not stamp out the disease, which will develop when the bees are subjected to unhealthy conditions.

Without going more deeply into the matter it need only be said that we cannot accept Dr. Lambotte's explanation, knowing as we do how rapidly foul brood spreads even when hives are in the best condition. On the other hand, we also know that when certain means are employed the disease can be got rid of, so that with the present knowledge available we need only follow out the practices usually advocated in order to obtain the best results.

## BRITISH BEE-KEEPERS' ASSOCIATION

### CONVERSAZIONE.

(Continued from page 121.)

The members reassembled at six o'clock for the *conversazione*, among those present being Col. H. J. O. Walker, Major Fair, Dr. T. S. Elliot, Messrs. R. T. Andrews, D. W. Bishop-Ackerman, T. Bevan, R. Bevan, F. J. Berison, L. Belsham, W. Broughton Carr, L. S. Crawshaw, A. Aitken Crawshaw, D. H. Darrant, Wilfrid Gutch, W. H. Harris, Will. Hampton, L. Illingworth, Henry Jonas, E. D. Till, Walter F. Reid, M. Sole, Thos. I. Weston, F. B. White, Mr. and Mrs. Ernest Walker, &c., &c.

Col. Walker was unanimously invited to preside, and opened the proceedings by asking Mr. T. I. Weston to address the meeting on the subject of Dr. Lambotte's recent investigations regarding foul brood.

Mr. Weston regretted very much that, owing to a sore throat, he was unable to read the paper on this theme which he had prepared and intended to place before them. He had named it "Foul Brood, in conjunction with the recent discoveries made by Professor Lambotte, of Liège." The Editors of the BRITISH BEE JOURNAL had earned the thanks of all bee-keepers for republishing in full the researches made at Toronto by Professor

Harrison, and from the time of its issue to the present this book had been the standard work on the subject, but it did not clear up the difficulty in accounting for the presence of foul brood in districts where it had been previously unknown. This fact induced the bee-keepers of Belgium to approach the Belgian Government with a view to further investigation into the matter, and the result of the elaborate researches undertaken was that discoveries had been made which were embodied in the pamphlet before him, published by the Institut Pasteur of Paris. He was glad to know that Mr. Cowan had translated Dr. Lambotte's paper, and that it would appear in the columns of the B. J. It had not been undertaken by those who had no experience in bacteriological research. Therefore the conclusions arrived at must carry very great weight. In the course of their experiments they found that *bacillus alvei* in its growth resembled *bacillus mesentericus*. This was one of the most common of bacilli, and could be found in pretty nearly all vegetable matter. It therefore became possible for bees to carry it into their hives from anywhere; but in its ordinary state this was not a pathogenic or disease-producing bacillus.

In his further observations the speaker gave some interesting quotations from Dr. Lambotte's paper, which need not be repeated, as Mr. Cowan's translation appeared in our issues of March 12, 19, and 26. In concluding his interesting remarks, Mr. Weston said:—It is apparent from all these circumstances that it may not require the disease to be carried into a hive from outside, but that *bacillus alvei*, or foul brood, may result from bad conditions, such as bad state of the hive, and that the ordinary bacillus carried in may produce the disease in time. He thought it should go forth from that meeting that bee-keepers must look more to the necessity of preserving a healthy condition of their apiaries than anything else as a preventive of foul brood.

Mr. W. H. Harris thought the theory propounded by Dr. Lambotte was a most alarming one. It reminded him of the anti-vaccinationist theory to the effect that if we could only have good sanitary conditions small-pox would never be prevalent in this country. It was a most disquieting thought that from the surface of fruits, vegetables, &c., this *bacillus mesentericus* could be conveyed into hives and converted into *bacillus alvei*, and he hoped the B.B.K.A. would not give an *imprimatur* to such a theory until it had been established beyond dispute, otherwise they would be taking a retrograde step. He understood that the most advanced scientists who had so far, prior to Dr. Lambotte, experimented, had established the fact that *bacillus alvei* was a distinct germ. Where microscopic examination was open to so much doubt and difficulty in distinguishing the difference between bacillus of one sort and another, he thought bee-keepers



should be most cautious as to how they endorsed the opinions of Dr. Lambotte, who said in effect, "Keep your bees healthy and you will have no foul brood." If the meeting adopted that idea it would be doing what some of the most dangerous bee-keepers had been saying and doing for the last twenty years.

Mr. Reid wished to support all Mr. Harris had said, but there was one point in that gentleman's speech to which he would refer. It should be emphasised that Professor Lambotte did not rely on the microscope for identifying the organism, but on culture experiments. It was quite impossible to identify unicellular organisms by the microscope alone. Bacteriologists identified these organisms by means of culture. The Professor said that where the *bacillus mesentericus* after this cultivation was inoculated into various substances, the characteristic smell of foul brood resulted, and the viscous condition was produced, which is a marked feature of the disease. Even brood treated in that way became viscous. He knew of no other organism that would do that. Many bacilli liquefy the medium in which they are grown so rapidly, that this property has been utilised as a means of classification.

Professor Lambotte stated that even bread became viscous when inoculated with the bacillus.

The attenuation of a bacillus completely altered its action. The most terrible disease of small-pox was at one time treated by inoculation. The organism which produced small-pox was used in an attenuated form to combat it. The more advanced of our grand-parents inoculated from small-pox which had passed through different individuals till it became so attenuated that it did not produce any evil results. There was evidence to show that nearly every disease could be attenuated in that way. The diphtheritic anti-toxin became so attenuated that its use caused no injury to the animal. Some diseases were absolutely fatal to savage races. The ordinary cold from which everybody suffered, for instance, had completely destroyed certain savage races; but by degrees that disease had become so attenuated as to completely alter its action on the people of this country. On the same grounds it was possible that the bees might be rendered immune to foul brood; but how that might best be done it was difficult to say at present. Dr. Lambotte admitted that he did not succeed in inoculating the brood in the hive with the *bacillus mesentericus*. His experiments failed to produce foul brood from the uncultivated bacillus. These germs required a certain definite medium to live in. They were very delicate in their food, also with regard to temperature and light—in fact, it was very difficult to hit on the exact medium for the growth of an organism. The professor had not yet succeeded in providing the final link required to complete the chain of proof. Foul brood, it used to be said, was

generated by certain conditions that made bees unhealthy, such as cold, damp weather, and bad nourishment. There may be nothing in that theory, though it agrees with Professor Lambotte's conclusions drawn from a different chain of reasoning. The following experiment which he had carried out threw some light on this subject. Take a hive affected with foul brood in a bad state, cut it in half with a divider containing queen excluder, and thus confine the queen to one part of the hive. It would be found that the bees cleared out the whole of that half from which the queen was excluded. Reverse the operation and all would become clean. He did not recommend bee-keepers to deal with foul brood in that way, but to destroy the disease germs with disinfection and fire. We saw nothing in Professor Lambotte's revelations to cause them to abandon their present methods of fighting this scourge of foul brood. The Report had been published by the Institut Pasteur, which in itself was a proof of its high scientific value, and there was no doubt Dr. Lambotte was one of the highest authorities on the subject. The experiments shed a new light on the conditions which must be systematically watched in hives, and at the same time suggested no relaxation of the caution hitherto observed. Obviously it would be most foolish to relax the precautions against diphtheria, because scientists knew how to cure it now. Mr. Weston had done good service at much personal discomfort in bringing the matter forward.

Mr. Till begged to be excused for interrupting the discussion for two or three minutes by inviting the audience to congratulate themselves on the presence of a member who, in the dark days of Ladysmith and Kimberley, volunteered and served throughout the whole of the campaign. Mr. Wilfred Gutch (who sat beside him) was a captain of the Yorkshire Hussars, and was compelled to leave immediately to catch a train. He (Mr. Till) would like to say, on behalf of the meeting, that they felt thankful to God that their comrade had been preserved in health and strength to return after rendering good service to his country (loud cheers).

Mr. Gutch, in reply, acknowledged the unexpected compliment before hurrying from the meeting, and said he had done no more than his duty.

Mr. Till remarked that Dr. Lambotte did not appear to have found the bacillus in the blood of the bee; contrary, he believed to the experience of previous investigators.

The Chairman thought that Mr. Cheshire was the only experimenter who had found it there.

Mr. Reid thought there was no justification for the statement that the bacillus had been found in the blood of the bee. Mr. Cheshire relied only on microscopical examination, by which means he might possibly have observed bacilli which appeared to be the same.

The Chairman would not be so presumptuous as to set his opinion against Mr. Cheshire's, but he thought there was considerable doubt as to the accuracy of that gentleman's conclusion on this point. On the general subject he did not share the apprehensions of Mr. Harris. They must rely on the criticism which he hoped would come from the publication of Dr. Lambotte's report. He looked forward to hearing what Mr. Cowan would say on the subject; in the meantime they must look after their own hives as carefully as ever. The one thing established by these investigations was that by cultivating a bacillus it could be rendered more harmful. That seemed to show that the pathogenic power of the bacillus was not great in the ordinary way. If Professor Lambotte was able to develop an ordinary bacillus into a foul brood bacillus, possibly he might develop it into a typhoid bacillus, and then there would be misery all round (laughter). His (the speaker's) view was that bee-keepers must wait for further light before altering their usual course of action in this matter.

*(Continued next week.)*

#### INTERNATIONAL EXHIBITION

FOR APICULTURE, VIENNA, APRIL 4-26, 1903.

This exhibition will be opened on April 4, 1903, judging takes place on April 7, and the prizes will be distributed publicly on April 12.

Numerous prizes are offered, including State certificates, silver and bronze State medals, along with many valuable prizes given by the Emperor and his family, numerous money prizes, silver cups and services, also a number of medals from Corporations, the Exhibition Committee, and objects presented by exhibitors.

A general meeting of bee-keepers will be held at 9 a.m. on April 13, when papers will be read by various experts, among whom Dr. Dzierzon may be mentioned.

From April 14 to 19, various receptions and excursions have been planned and special arrangements made for the entertainment of visitors coming from a distance.

Most European States will be officially represented, also America and Palestine. Many prominent bee-keepers have announced their intention to be present, and the Exhibition Committee cordially invite all bee-keepers to visit the exhibition and take part in the meetings.

#### WARWICKSHIRE B.K.A.

##### ANNUAL MEETING.

The annual meeting of the above Association was held at the Grand Hotel, Birmingham, on March 26. The Rev. T. W. Downing presided, and among those present were: Major Deykin, Mr. A. H. Foster, Mr. and

Mrs. Baxter, Mr. and Mrs. Young, Mr. and Mrs. Beaumont, Mrs. Bower, Messrs. C. H. Saunders, J. Burbidge, McMichael, M. Pollack, Walters, Swain, Baker, Dalman, Corbett, Hodgson, J. Noble Bower (hon. secretary), J. R. Ingerthorp (assistant secretary), and G. Franklin (expert). The Chairman, in moving the adoption of the report, congratulated the Association upon the excellent work which it had carried out not only during last year, but during many years previously. The society had shown that bee-keeping could be carried on at a profit, and small farmers and cottagers might with advantage keep bees. The resolution was carried unanimously, and the election of officers then took place. Lord Leigh was re-elected President, and the Vice-Presidents were re-elected, Mr. F. E. Muntz taking the place of Sir Arthur Hodgson, deceased. Messrs. J. Noble Bower, J. R. Ingerthorp, and G. Franklin were re-appointed hon. secretary, assistant secretary, and expert respectively, Mr. A. H. Foster and Mr. J. Lawrence Hawkes being re-chosen as hon. treasurer and hon. auditor respectively, and a committee was subsequently appointed. A lecture, entitled "The Bee Community," illustrated by lantern views, was afterwards delivered by Mr. G. Franklin, and listened to with evident interest by the large audience present.—(Communicated)

#### KENT AND SUSSEX B.K.A.

##### ANNUAL MEETING.

The annual meeting of this Association was held at the office of the BRITISH BEE JOURNAL on March 18, Mr. E. D. Till presiding. Among those present were General Sir Stanley Edwardes, Mr. R. C. Powell, Mr. Beale, Mr. W. Broughton Carr, and Mr. H. W. Brice.

The report and statement of accounts were read and adopted, the Chairman pointing out that, although their very successful show at the Crystal Palace had entailed no burden on the ordinary income—owing to the liberal way in which many members had contributed to the prize fund—there was, nevertheless, no diminution of the old adverse balance; indeed, it had somewhat increased, owing mainly to arrears in the payment of some of the annual subscriptions in 1902. Sir Stanley Edwardes raised the question of County Council help, seeing that bee-keeping associations did technical education work. It was explained that though help was accorded to many other county associations, the Kent County Council, though spending as much as £275 this year on bee-keeping instruction, afforded no assistance whatever to the Association. Sir Stanley Edwardes advocated the continued use of the Association honey labels, which he had found of service.

Mr. H. W. Brice regretted that his business no longer allowed him to devote the necessary

time to the secretarial duties, and he was reluctantly compelled to place his resignation in the hands of the Council. He expressed the hope that a successor would be appointed as soon as possible; but, in the meantime, he would attend to the correspondence and collection of subscriptions. Great regret was expressed that Mr. Brice could no longer continue the work, after so many years of zealous service; moreover, it was not easy for the Council to find a suitable successor for the secretarial post.

## Correspondence.

*The Editors do not hold themselves responsible for the opinions expressed by correspondents. No notice will be taken of anonymous communications, and correspondents are requested to write on one side of the paper only and give their real names and addresses, not necessarily for publication, but as a guarantee of good faith. Illustrations should be drawn on separate pieces of paper. We do not undertake to return rejected communications.*

*Communications relating to the literary department, reports of Associations, Shows, Meetings, Echoes, Queries, Books for Review, &c., must be addressed only to "The Editors of the 'British Bee Journal,' 17, King William-street, Strand, London, W.C." All business communications relating to advertisements, &c., must be addressed to "THE MANAGER, 'British Bee Journal' Office, 17, King William-street, Strand, London, W.C."*

### AMONG THE BEES.

#### EGG-LAYING EXTRAORDINARY.

[5077.] We are often astonished at the number of eggs some of our most prolific queens lay in a given time. Place a frame of foundation, in the height of the season, in the centre of a populous stock, and, on examining it in about forty-eight hours, you will find it one mass of eggs, numbering, probably, more than five thousand. In course of a year, a queen may lay, possibly, about a quarter of a million eggs, and, counting her own eggs and that of queens from swarms she has sent out, she may (perhaps) produce one million eggs in a year! But this number, though an extreme estimate, sinks into insignificance when compared with certain others of the class Insecta. One single fly may have as many as 25,000,000 descendants in a single season, and the female termite, or white ant, lays at the rate of sixty eggs a minute, its laying powers being greater than that of any other creature in the world.

We have no opportunity of verifying this personally, as these insects are not found in our country, being residents of warmer climes, and found principally in the tropics. In their communities are to be found five classes—male, females, workers, neuters and soldiers—but the three last named are simply undeveloped females. Only the perfect females lay eggs. When engaged in this pastime her abdomen becomes dilated to an extraordinary degree, so as to exceed the rest of the body about two thousand times, and she is then about one thousand times heavier than the male insect. The best authority says, "Her

fecundity is prodigious; she is supposed to lay more than 31,000,000 eggs in a year." How does that compare with the single million one of our first-class queens may lay during her life time?

"As Others See Us."—A German wrote (several years ago, however):—"In all other countries bee-keeping is at the present date almost from beginning to end a mere plaything and fancy, which, instead of bringing in money, causes money, and often a good deal of it, to be expended." My acquaintance with the German Stander, Lager, Double Lager, Pavilion, Bogenstulper, and other hives left the impression that they were ages behind us in apiculture, but I must revise my opinion after perusing the foregoing sentence. In scientific bee studies I acknowledge that they are far ahead of our scientists, and we are very largely indebted to them for our knowledge of bee anatomy. Any one glancing over the "list of books" consulted in the writing of the "Honey Bee" must acknowledge that in patient research Germany holds an easy first.

*The Spring Cleaning.*—This annual event is about due, and in all cases should be overtaken before the end of the month. So long ago as the time of Mahomet it must have been observed by bee-keepers, as one of the rules he gives for those keeping hives is, "That everything about the hives must be kept clean." We who work under modern methods can go a step further than the ancients could possibly do, as their hives did not admit of the thorough overhaul which is one of the best features of the bar-frame hive. We can, in particular, investigate the hive interior and to a great extent put right anything we see wrong. In the way of renewing and replacing comb we are at a very great advantage. We can fully observe the capacity of each queen, and depose any showing failing powers. If food is running out, it is a simple matter to supply it.

The cleaning up of floor board is an obvious duty at this season. But our chief advantage is the facility this examination gives us of observing and checking or eliminating any signs of disease. Here is what I would most seriously impress on all as a sacred duty this season. Combs should all be glanced over, every doubtful cell closely examined, and any looking at all suspicious tested to confirm whether they show disease or not. Undoubtedly this season is one which, for several reasons, will be apt to give our arch enemy the foothold it needs to get itself firmly established. All should carefully study the very exhaustive articles our Editors have been so good as to favour us with. In my opinion they form an epoch in bee-keeping, as we have now such a knowledge of the disease and the numerous forms of treatment that we can eradicate the pest. I am so much of an optimist that I take a hopeful view of the matter. Knowledge in

every other line of life gives a power to overcome. Here, thanks to the Editors, it is supplied to us gratis. It is for us to apply it in an intelligent way and victory is certain to follow. Alas! there are reservations to this rosy view for, while a hotbed and hatcher of the disease exists over the hedge in the neighbouring garden, all our best endeavours may go for naught.

*Strong Colonies.*—One might think from the tone of some recent communication that these were a new discovery, and that benighted bee-keepers in the past were talking and working in a region of dark obscurity. They seem to be oblivious of the fact that you and your contributors have been preaching the same doctrine ever since the advent of the BRITISH BEE JOURNAL. Recently, when reading one of those works now set down as ancient literature, a work dating back over 200 years, I was much impressed by the writer's reiterated enunciation of this point. He impressed emphatically on his readers that the true secret of success was having all colonies "lustie and strong."—D. M. M., *Banff*.

ERRATA.—In "Statistics" (page 114, fifth and sixth lines from top) the weight of surplus should be 460,000 and 500,000 respectively, a 0 having in each case been dropped by printer. In line twenty-five the word "better" should read *premier*.—D. M. M.

### CURING FOUL BROOD.

[5078.] Do you think that it would be possible for your Association to recommend to the British Bee-keepers' Association the offering of a remunerative prize for a simple and effective remedy for foul brood?

Without such a remedy, it seems to me that the bee-industry can never thoroughly prosper, but with it, it would be a grand success; and I fancy that if our experts could be induced to go a step or two further and make a few more experiments, such a remedy might be found. As a reason for thinking so, let me say:—Six years ago I discovered foul brood in my hives here. Two or three were badly affected, and I completely destroyed them; but others had only slight traces; many cells were plainly affected, but only in the earlier stages of the disease. It seemed a pity to destroy these stocks, and so I powdered a quantity of naphthaline and carefully but plentifully sprinkled it into every suspicious cell in every frame. The result was surprising. A great number of the newly-hatched bees seemed to be overpowered by the naphthaline, and went reeling, as if they were intoxicated, out of the hives, and the hives seemed for a time to be denuded of young bees and brood; but the old bees seemed unaffected, and very soon brood appeared again of a pearly white, and I had no sign of the disease again for two or three years.

It seemed to me from this that by some

other and modified application of naphthaline, or, if it could possibly be found some other substance which would not so affect the young bees, the disease, in its initial stages, might be really cured. The time, I may mention, was in the month of June, and a valuable part of the honey harvest was, unfortunately, lost.—D. A. D., *Farrington, March 27*.

[The above communication was forwarded to us by the hon. sec. of a county B.K.A. with a request that we should insert it, with the object of inviting discussion on the subject. We have no objection to do so, without feeling very hopeful of the desired panacea being secured.—Eds.]

### MIS-BUILT COMBS IN HIVES.

[5079.] About three weeks ago a friend of mine, who knows nothing about bees, bought a hive and stock (?) of bees from a neighbour, whose place is about a quarter of a mile from his own. He asked me to examine his hive and advise him what to do. The weather then being wet, cold, and windy, I would not make a real examination, but merely lifted a corner of the quilt. That was enough to show me there was a scarcity of food and of bees. I therefore advised my friend to give syrup continuously, add more quilts, and to reduce the width of entrance.

Last Sunday, the weather being warm and bright, and my own bees flying as "on a summer's day," I made a further examination. Result: ten frames, of which four were drawn out comb, and small clusters on three of them; two frames next cluster, with foundation broken down, bulged and joined together, and four frames with untouched foundation; practically no food. Having no candy, I put about half-a-pint of warm syrup in drawn-out comb, placed this against cluster on one side, and one frame of foundation on the other. I removed all the other frames and contracted brood-chamber with dummy boards on either side. I then packed the space between these and the outer walls with paper, put on a feeder with *all holes open*, and packed on all quilts procurable. The bees were bringing in pollen. I did not search for queen, so as to avoid disturbing the bees more than necessary.

Now, Sir, I shall be much obliged if you will tell me (1) did I act properly? and, if not, (2) where I was wrong? Also (3) what more can I do to help those poor bees?

As regards my own bees, I have six fairly strong stocks, well provided with food. I am giving them stimulating syrup, and find they each take down a bottleful from one hole in two days. (4) How long should I continue to give them syrup? I have no spare hives or floor-boards. (5) How soon would it be safe for me to clean out the winter's mess?—LOVERSALL, *Cobham, Surrey, March 27*.

[1, 2, and 3. Yes, quite properly. With four frames of correctly drawn-out comb it will

not be difficult to get the full complement built out between these by inserting the frames of foundation one at a time later on. 4. Give syrup until natural food is plentiful. 5. On the first fine day that comes.—EDS.]

### HOME-MADE HIVES.

[5080.] May I ask the favour of a few lines on the above? In last week's issue (page 126) your correspondent "Jim, Ipswich," gives us his ideas with regard to the manufacture of a home-made hive. Being myself a beginner of one year's experience, and a joiner by trade, and therefore constructing my own hives, I was rather amused with the idea of constructing a hive with material  $\frac{7}{8}$  in. thick. I think it will be quite plain to most people that either severe cold or excessive heat would penetrate such a thin casing very easily, and I cannot imagine how "Jim" intends to fix the angles of his hive. And so I ask, will he "tongue-and-groove" or "rabbet" the same, as mentioned in "British Bee-keeper's Guide Book," p. 34, or if he intends to have a "butt joint"? If the latter, how could he nail together a box  $\frac{3}{4}$ -in. thickness without splitting the wood of same? He will also notice on page 35 the thickness recommended for outer casing is 1 in. A reference to the illustrated catalogue of some bee-appliance manufacturer of repute would I fancy, alter his views, for "Jim" will fail to find any hive made of such thin substandard material. The construction of a bee-hive is most important, and before "Jim" thinks of scrambling a hive up together in the very cheapest way possible, he would do well to give a little consideration for the comfort and warmth of the bees. Your correspondent gives the particulars of construction of his hive (if I may so call it) to B.B.J. readers as costing only the small sum of 3s. 7d. May I be allowed to say, for the information of "Jim" and others, that I make my floor-boards of  $\frac{3}{4}$  in. stuff; outer casing,  $\frac{3}{4}$  in. finish, tongued and grooved angles, and well glued at the same time; and I hope our friend will not be shocked when I say the wood alone for floor-boards, body-box, deep lift, and roof, together with section rack, costs me more than double 3s. 7d. In reference to your reply on hive-making for beginners, on page 100, I have looked it up, but failed to see that "Jim" could be encouraged in any way to make such a hive as he proposes. The advice you gave him (which I thought sound and reasonable) was to "pay his money and make his choice," as there are plenty of hives on the market to suit all pockets. The reason for my troubling you with this reply is because many inexperienced people might feel dissatisfied with the price they have to pay for their hives. I have therefore endeavoured to show the price our friend "Jim" gives us is misleading, if a good, serviceable hive is required.—W. D., Aldershot.

## Queries and Replies.

[3053.] *Bradford as a Bee District—Effect of Bee-stings.*—As a subscriber to your paper, I am venturing the first time to ask a question or two. I commenced bee-keeping last June by purchasing a swarm, which got on remarkably well, considering the season. My first question is:—What chance is there for bee-keeping about here, located as we are about 1,200 ft. above sea level? A few young men like myself have caught the bee-fever, but we are always much put out by the same tale of, "It's too cold about here to keep bees; you should go down south." Seeing that we hear always the same tale, I should like to ask—1. Is there any truth in it? I do not fear a sting, by any means, but the effect on me is remarkable. I have had only two stings so far, both on my hands, but they puffed up and swelled to a great extent each time. I am not a total abstainer—in fact, I take a little beer every day (but only a little); yet I would ask—2. Would that little have the effect of making me swell so much when stung? If so, I rather dread to think what I should look like if stung half a dozen times on the face!—H. B., near Bradford, Yorks, March 24.

REPLY.—1. In the absence of any personal knowledge of your district as a bee locality, it may be safely said that bees do well at a higher altitude than yours, and further north too. 2. Without contending for total abstinence on the part of bee-men, we could well believe that an habitual beer-drinker, unless very moderate in that line, would be more inclined to swell when stung than an abstainer. But it is quite certain that the effect of bee-stings varies very much in individuals, and, at times, in a contrary direction to that which seems most feasible, just as we have stout people with very moderate appetites, and *vice versa*.

[3054.] *Honey-dew as Bee-food.*—1. I have several pounds of extracted thick honey tainted with honey-dew. Is it advisable to give this to the bees as spring food? 2. If I medicate it, what proportion of water and naphthol beta should be added? 3. I have also some frames of similar honey of 1902; will they be useful for this year's wintering and for swarms?—CUMBRIAN.

REPLY.—1. "Thick honey," even if "tainted with honey dew," will be quite suitable as spring food for bees when reduced to the consistency of ordinary bee-syrup. 2. No need for medicating because of the honey-dew alone, but if medicated as protection from disease, use the naphthol beta as directed on package. 3. Yes, a frame of sealed food is frequently of great service to swarms when first hived.

[3055.] *Moving Bees in April.*—As a reader of your valuable B.B.J. for a short time past, I am asking for advice. I am only a beginner

in bee-keeping, having taken up the idea owing to seeing one of your journals. I was very fortunate in getting a start, for a gentleman in our neighbourhood, who has left for America, gave me a valuable present of five stocks of bees in bar-frame hives, all of which have come through the winter well. But I am about to move some twelve miles away, and so I ask, Would it do to shift the bees so late in the season as this? I have read about loss of bees through moving, but I thought that might only apply to short distances, where the bees would probably return to their old home. If you tell me whether there is any risk in moving my hives so far as twelve miles you will be very much obliged—E. KAIL, *Andover, March 28.*

REPLY.—You need have no fear with regard to loss of bees through change of location when the new stands are twelve miles away. It is only when the distance is within a mile or two that risk from moving comes in.

[3056.] *Using Up Old Bee-syrup.*—May I trouble you to answer me the following questions:—1. I have a quantity of syrup left over from feeding last autumn, and on tasting it I find it has got a "fusty" taste. I therefore ask—1. If I add more water and boil it up again, will it be suitable for the bees this spring? It has not fermented at all. 2. Also on one of my hives the bees have got a cake of candy above frames. Do you advise removing this, and giving warm syrup, or should it remain until the bees have consumed it? I take the B.B.J. every week, and have also got the "Guide Book," which is a great help to me. This is my second season at bee-keeping, and I love the bees very much—in fact, the more I know about them the more I want to know. Wishing the B.B.J. and all bee-men a bumping season.—A. L. P., *Huddersfield, March 26.*

REPLY.—1. Yes; if re-boiled no harm will follow. 2. By all means remove it, unless the bees are carrying the candy down rapidly. Syrup-food is most suitable in April.

[3057.] *Queen-cells in March.*—Will you please tell me what to do in the following case:—I examined my hives on March 22, and found in one of them five or six queen-cells, most of which were capped. Two of them were unsealed, but had larvæ in them. I examined the frames very carefully, but could not see the queen, although she may have been there, as I am only a novice at bee-keeping. Four frames had sealed brood on them, but I could see no eggs. My idea, therefore, is that the queen has recently died, or be n lost, and the bees are trying to raise another. The stock is strong—in fact, the best I have. Would it be best to cut all but one of the queen-cells out, or leave them as they are for a time, and after making sure the stock is queenless to buy one and introduce her? I will look for a reply in your BEE JOURNAL,

which I have taken regularly since I started bee-keeping.—A. NOVICE, *Ilford, Essex.*

REPLY.—The symptoms conclusively point to loss of queen, and as the present time is too early to hope for the successful mating of any resultant queen from cells referred to, it will be advisable to purchase a laying queen if you can hear of one.

[3058.] *Clearing Bees from Tiled Roof.*—1. Can you kindly tell me in your query column how I can remove a swarm of bees from under a tiled roof? 2. When is the right time to operate? 3. Also how to get them from a hole in a tree? The bees in roof are very strong and have been there about two years.—"CANDY," *Norwich.*

REPLY.—Assuming that you possess sufficient experience of bee-work for carrying out instructions, we may say the combs must be exposed by removal of tiles, and cut away one by one, after brushing the bees from each, and running them into a skep or box. The brood-combs are then tied into frames and hung in the new hive before running the bees into the latter. Warm weather should be chosen for operating in. 2. The same may be said of removing bees from trees, but without some skill or experience on the part of the operator it is impossible for us to detail in this column all the various items of careful procedure necessary to ensure success.

## Echoes from the Hives.

*Maldon, Essex, March 24.*—I take your journals and find them a great help; also very interesting. Glad to say my nine stocks of bees have come through the winter safe and sound. The last few days have been quite like spring, although plenty of wind. The bees seem to have made a good start. I have caught three queen wasps between the 16th and 21st—one on the 16th, the others on the 18th and 21st. Are they the first you have heard of?—A. C. T.—[Yes.—Eds.]

## GLEANINGS FROM FOREIGN BEE JOURNALS.

BY R. HAMLYN-HARRIS, D.S.C., F.R.M.S., F.Z.S., F.E.S., ETC.

*Praktischer Wegweiser für Bienenzucht.*—There is an old well-known children's rhyme which says—

"In Poland growls the fierce wild bear,  
Ye bees! give me your honey."

There is now no need (in Germany) to fear the bear; we leave him to Russia, but even there he would hardly venture into the neighbourhood of an apiary, but attacks the winter stores of the wild bees, which are also robbed by the fox, martin, weasel, stoat, badger, squirrel, and hedgehog.

For these enemies an apiary is too strong,

even if the fear of man did not deter from attack. Mice are really more dangerous; they nibble away the entrance, and once inside for the winter, they eat the wax and alarm the bees, and are the cause of many perishing; indeed, often the whole colony is ruined.

Birds are, however, still worse enemies of the bee, as they seize on the bees themselves. A beautiful bird, feared and hated in the south of Europe, is called the bee-eater, and flies after the manner of a swallow. In Germany the woodpecker, redwing, tit, starling, flycatcher, swallow, wagtail, robin, redstart, and golden oreole are all insectivorous, but, on the whole, they do little mischief. The bee-buzzard and stork, on the other hand, are hopeless robbers.

The awkward frog and the shy lizard also are found lurking near hives, and woe to any bee coming too near them. Snap, and all is over!

Then there are many insects which are a plague to the bees, as earwigs, flies, and several kinds of ants, woodlice, hornets, and wasps, which (especially in autumn) slip in at the weakly-guarded entrance to enjoy the stolen sweets. The bee-louse is also a most unbidden guest, which chiefly annoys the queen bee; the oil beetle, or May worm, is still worse, as its larvæ destroys the young brood.

But the most injurious of all insects of this kind is the small wax moth, which lays its eggs in cracks in the hive or in the débris on the floor board. The grubs gnaw the wax, and even the young brood, which often die through their attacks, or emerge with wings wholly or partially destroyed. Spiders are great enemies to bees, especially on the open heaths, where numbers perish in their meshes.

A microscopically tiny growth sometimes covers the interior of hives where ventilation is insufficient; it will even attack the bees themselves, which often die in consequence. To these we must add the dreaded *bacillus alvei*, the source of foul brood, which is apt to collect wherever there is neglected decaying matter.

Lastly, man himself is a terrible enemy—yes, ignorant man.

Last year a bee-keeper near Berlin lost a fine swarm, which, unhappily, fled into the city and settled under the projecting corner of a building. Soon the street urchins had found them out and proceeded to closer examination. Of course, they got stung, and then there was a cry of "The bees! the bees!" The fire brigade was called out (maid-of-all-work in Berlin) and the hose set to play upon the swarm, which was destroyed in a moment.

Another swarm settled on a lamp-post in Berlin; the man came to light the lamp, turned on the gas, one puff, and the bees lay on the ground burned to death. The careless bee-keeper brings as much injury to his bees as any of their other numerous enemies. It is inexcusable to remain ignorant as to care and

treatment of bees, as at the present time there are so many opportunities and inducements to learn.

### PRESS CUTTINGS.

#### BEEES AT AJANTA CAVES.

SIR,—In your issue of the 12th inst. the Collector of Khandeish writes to warn visitors to Ajanta of the danger caused by bees.

These industrious and vindictive insects appear to be as dangerous now as they were in 1877, when Mr. Burgess, the archaeologist, "was dreadfully stung, and had to remain in the river for hours up to his chin in water."

So important was the matter formerly considered that in the 1879 edition of Murray's Hand-book travellers to India are recommended to supply themselves, as part of their outfit, with "a pair of stout leather gauntlets coming up above the wrist half-way to the elbow, and a light wire-mask with a backpiece to protect the back of the head and neck," for use when visiting the caves of Ellora and Ajanta as a protection against the bees, many persons having been so badly stung "that in some cases death has ensued." In the same guide book we read as follows:—

"Having located himself, the traveller will do well to send for Imam, the great bee-hunter, of Ajanta, and inquire in what state the bees are. If likely to be troublesome, Imam will arrange for their destruction before the caves are visited."

Apart, however, from the danger to those visiting what "Murray" describes as "the most extraordinary sight that India has to show," there is another fact I would like to bring forward, namely, that the bees are one of the chief causes of damage to the famous wall-paintings in the caves. In Messrs. Ferguson and Burgess's book on the "Cave Temples of India," it is stated that about forty years ago—i.e., about 1839—the paintings at Ajanta "were very tolerably complete, and their colours exhibited a freshness which was wonderful, considering their exposure to the vicissitudes of an Indian climate for from fifteen to eighteen centuries. Since that time, however, bees, bats, and barbarians have done a great deal to obliterate what was then so nearly perfect."

As the State protection of the remains of ancient India is now contemplated, might I suggest to the authorities that a small portion of the money that will soon be annually allotted to the purposes of preservation be devoted to the eviction of the bees of Ajanta Caves? This would simply mean a trifling amount spent in wages to Imam the bee-hunter, if he is still alive and active, or to his successors if he is dead. It is not every day or in every country that one can see paintings seventeen hundred years old; and it will be indeed a pity if the present opportunity be not taken for establishing the periodical ejection of the bees and bats of Ajanta, on the

two-fold grounds of preserving the paintings and ensuring the safety of sightseers; while as for the "barbarians" they will soon have become creatures of the past.

Furthermore, any steps taken in the direction of facilitating the journey to Ajanta, and rendering a short sojourn there more convenient than at present, would invoke the heartfelt thanks of modern pilgrims to the desolate shrines of one of the grandest of religions.—T. R. A. G. MONTGOMERY, Major, *Byculla, Bombay, January 14.*

To the Editor of the *Times of India.*

Sir,—At this season of the year there are a number of travellers who visit the Ajanta Caves. May I warn them to be on their guard against bees, particularly when visiting Cave No. 10? A gentleman and his wife have just been very badly stung. Visitors are specially cautioned not to smoke, and not to irritate the bees in any way.—G. S. CURTIS, Collector of Khandeish, *Camp, Bhusawal, January 9.—Times of India.*

## Bee Shows to Come.

A nominal charge of 2s. 6d. is made for notices in this column, which covers cost of insertion from order till date of show. Cash should accompany orders for insertion.

June 23 to 27, at London.—"Royal" Agricultural Society's Show. Bee and Honey Section under the management of the B.B.K.A. Increased prizes for B.K.A. Associations as arranged in divisions or groups of counties. Schedules from Edwin H. Young, Secretary, 12, Hanover-square, W. Entries close May 1, or at extra fees up to May 15.

July 22 and 23, at Cardiff.—Honey show of the Glamorgan B.K.A., in connection with the Cardiff and County Horticultural Society. Bees, hives, honey, trophies, wax, appliances, and articles of food. Substantial money prizes and medals. Free entries. Six open classes. Schedules from William Richards, Gabalfa, Cardiff. Entries close July 16.

July 30, 31, and August 1 and 3, at Old Trafford, Manchester.—Annual Show of the Royal Lancashire Agricultural Society. Liberal money-prizes are offered for honey along with silver and bronze medals of the B.B.K.A. and also of the Society. Open classes for Honey-Trophy, Sections, Extracted Honey, Beeswax, Instructive Exhibits in Bee-Culture, &c. Schedules, when ready, from Edward Bohane, Secretary, Miller-arcade, Preston.

August 4, at Leamington.—Tenth annual show of the Leamington St. Mary's Horticultural Society. Three open classes for Six 1-lb. Sections, Six 1-lb. Jars "Light," and Six 1-lb. Jars "Dark" Extracted Honey, respectively. Liberal money prizes. Schedules from P. W. Smith, Secretary, 22, Leam-street, Leamington. Entries close July 30.

August 12, at Radstock, Bath.—Honey show in connection with the annual show of the Radstock and District Horticultural and Fanciers' Association. Schedules from the Secretary, B. M. Clark, 1, Fox Hills, Radstock, Bath.

August 27, at Llangollen.—In connection with the fifth annual Flower Show. Open classes for Six 1-lb. Sections, Six 1-lb. Bottles Extracted Honey, and Beeswax. Schedules from Frank Little, Castle-street, Llangollen. Entries close August 13.

### TRADE CATALOGUES RECEIVED.

Manufacturers have been somewhat less prompt than usual in forwarding new catalogues for 1903. Several, however, are to

hand, and we can commend them to the notice of readers as being well got up, full of good illustrations, and up-to-date in all respects.

Among them are the following:—

E. H. TAYLOR, *Welwyn, Herts.*—A very full list of bee and poultry appliances (80 pages), with "Hints for Successful Bee Management," and other useful information.

R. STEELE, *Wormit, by Dundee.*—This is another well got up and nicely illustrated list. Like the first-named, it includes poultry appliances and foods. The samples of foundation enclosed with list are very good. Mr. Steele also gives "Hints to Beginners in Bee-Culture."

EDWD. J. BURTT, *Stroud-road, Gloucester.*—Mr. Burt's neat little catalogue of 32 pages is again well to the fore, and he still makes a speciality of his timber trade and the supply of wood cut and planed for bee-keepers' use.

### Notices to Correspondents & Inquirers.

All queries forwarded will be attended to, and those only of personal interest will be answered in this column.

F. E. B. WHITELOW (Sussex).—*Bee Anatomy.*—We think you will find the discrepancy more apparent than real, and when the authorities are so numerous, as in the book referred to, that there are sure to be some differences of opinion amongst them. We shall, however, have an opportunity ere long of seeing the author of the "Honey Bee," and will invite his attention to your remarks, which, no doubt, he will explain to your satisfaction.

F. A. ALLEN (Ottawa, Ontario, Canada).—*Book Lists.*—We publish no price list of English bee-books, and in consequence cannot comply with your request for same. The only books issued from this office, beyond our weekly and monthly periodicals, are the books of which our Senior Editor, Mr. Cowan, is the author. Copy of current BEE JOURNAL will be forwarded as requested.

REDLAR (Lymington).—*Formaline.*—We are not conversant with the method of fumigating you refer to. If you tell us where it appears we will refer to it.

ALPHA (Bowness-on-Windermere).—*Bee Nomenclature.*—Bees sent are of the common or brown variety.

F. O. F. (Gosport).—*Joining Bee-keepers' Association.*—The Hon. Sec. of the Hants B.K.A. is Mr. E. H. Bella's, Brangore, Christchurch.

*Suspected Comb.*

T. W. (Polegate, Sussex).—One side of comb is filled with mouldy pollen, the other with sealed food. Not a trace of brood, foul or otherwise, in the cells.



## Editorial, Notices, &c.

### BRITISH BEE-KEEPERS' ASSOCIATION

CONVERSAZIONE.

(Continued from page 134)

Dr. Elliot considered Mr. Weston's remarks interesting from a scientific, if not from a practical, point of view. With regard to the question of the distribution of these microbes, it was well known to bacteriologists that there were certain microbes very widely distributed, but which were only under certain conditions pathogenic or able to produce disease. The *Bacillus coli commune* inhabited the human body, and was very widely found throughout Nature. This was able to produce peritonitis and appendicitis. Then there was the *Bacillus pneumococcus*, almost invariably to be found in the human lung. Many other bacilli existed in the same way, but were only able under certain conditions to produce disease. Of course, their aim must be to find out what those conditions were so as to be able to avoid them. With regard to the treatment of bacilli there was no doubt that in the hands of an experienced bacteriologist, bacilli might be either attenuated or made more virulent. It was of little consequence that all these bacilli were widely distributed so long as they could not produce disease, consequently he saw no cause for alarm.

Mr. Hampton thought they should wait till they had seen the whole of the article before expressing any definite opinion. Meantime he thought there was no cause for alarm, as it was by no means proved that this widely existent bacillus could generate foul brood.

Dr. Elliot said one test which bacteriologists generally employed to find out whether one bacillus was the same as another was to ascertain by experiment whether each could produce the same disease when inoculated. Until that had been done in the present case nothing could be taken for granted, but there would be no denying it if the disease were to be produced through inoculation by the virus itself.

Mr. Reid understood that by the inoculation of *Bacillus mesentericus* into the hive it did not produce foul brood, but by a culture in a broth made of the larvæ of the bees the Professor had been able to produce the actual disease. From this it was to be inferred that if this particular bacillus was distributed in millions it would not produce foul brood, but could only do so after cultivation. Surely here was useful knowledge, although it should not cause them to act like the Brahmin, who, when shown the living contents of a glass of water, committed suicide because he had been killing so many creatures all his life!

Mr. Weston, while not wishing to create undue alarm, said they must not consider because no one in their neighbourhood had

foul broody hives, therefore they could not have it. A bacillus which was ordinarily non-pathogenic could, under different conditions, become pathogenic. Hives must be kept in a condition to resist the disease coming in from outside. It would be seen from the full Report in the BRITISH BEE JOURNAL that the Professor strongly advocated total destruction as the only way of eradicating the disease, the pathogenic germs being so resistant to any means of disinfection that only fire would get rid of them. It was well-known that if poultry, pigs, rabbits, and even bullocks and sheep and other animals were kept in the same habitations and on the same ground they deteriorated for some reason or other, which it was difficult to explain. He thought it would be advantageous to give up using very old hives, which might become saturated with the unhealthy products of the bees. The keeping of these old wooden hives for the usual long period was against bee-keepers. The straw skeps were never retained like that. It was a point to be thought of as to whether a single walled hive would not be more hygienic than the present double-walled one which harboured impurities that could not be got at and eradicated.

Mr. Carr said that without possessing any scientific knowledge, they knew that some of our oldest and best bee-keepers, who knew the importance of keeping their hives clean, were now using the same hives that they had twenty years ago, and saw no reason for destroying them at intervals.

Mr. Durrant had always been led to believe that foul brood only attacked the larvæ, and would be glad to know if the present discoveries tended to alter that view.

Mr. Weston replied that it had been discovered in the queen's ovaries, in the eggs, and in the intestines of the bees.

The Chairman said it was generally supposed that it was conveyed to the larvæ through the alimentary canal of the bee.

Mr. Reid described the way in which the Professor had prepared the medium in which he had produced *Bacillus alvei* from *Bacillus mesentericus*. A large number of larvæ were collected, and crushed, and strained, and then a broth was composed of them according to the laboratory method. Cheshire found *Bacillus alvei* very widely distributed, but mere microscopical investigation was not sufficient.

Mr. Till referred to a very interesting announcement which had recently appeared in the *Times*. It was to the effect that Professor Dewar explained at the Royal Institution that experiments had proved that the typhoid bacillus—after being frozen in liquid air and triturated—had been injected into animals as an anti-toxin, and gave positive immunity to typhoid poison. Of course, the experiment could not be tried on human beings, but the result seemed to suggest great possibilities for the future.

Mr. Reid thought the discovery referred to a very important one, and bore a considerable analogy to the case of foul brood. Formerly it had been the practice to experiment with the waste products of the bacilli in culture, but now the actual bacteria were taken and crushed, and the life-blood extracted from them. Inoculation with this prevented the disease from spreading.

The Chairman said the discussion had been scientific, most interesting, and he hoped would lead to eminently practical results.

Mr. Carr showed samples of handsomely-decorated tin honey-pails, made and used in Canada for extracted honey. They were brought over by Mr. Smith, an Englishman who had emigrated to Canada some years ago and was now an extensive bee-keeping honey-producer in Ontario. Mr. Smith, from whom we had a pleasant call at the B.B.J. Office, said that glass jars such as were used here would not suit the honey trade in Canada, because both consumers and store-keepers needed a handy unbreakable package that would not leak, and nothing suited so well for extracted honey as tin pails, holding from 2 lb. to 25 lb. The samples shown had the producer's name and address printed in gold and colours on the tin itself, which gave the package a very attractive appearance.

Mr. Weston narrated his experience of the G.E.R. Co., who charged more for honey sent in tins than in boxes.

Mr. Brown was in the habit of sending 7, 14, and 28 lb. tins by rail, labelled with information stating where the honey was from, and where going to. He had sent 42 lb., in three separate packages, a good distance by rail for 11d. at "owner's risk."

The Secretary, B.B.K.A., said that the Great Eastern Railway required agricultural produce to be sent in boxes of a certain size.

Mr. Reid remarked the tins were often provided with only the merest trace of solder in the joints, so that the weight of honey would be almost enough to break them. In some cases they could be pushed open by the finger. He further said that if the tin-plate were enamelled with a suitable varnish on the inside, it would be preserved from the action of the honey. Pure tin is a safe metal, and would not be acted on by honey; but iron, although harmless, would discolour the honey and render it unpleasant to the taste. In reply to Mr. Bishop-Ackerman, Mr. Reid said that zinc was a metal easily acted on by the air and all kinds of organic acids. The reason that a coating of zinc preserved iron was that, although oxidised more readily, yet the oxide thus formed adhered firmly and protected the metal underneath, while oxide of iron scaled off and exposed fresh surfaces of metal to corrosion. He (the speaker) would never use zinc separators again after having introduced celluloid.

In reply to a question, Mr. Carr said the cost of the smaller tin "honey-pail"—as it

was called—was, he thought, about 2½d., and the larger one 3½d., which was very cheap, as both receptacles were handsomely decorated and well finished. Probably this price was only possible when ordered in large quantities.

Mr. Carr, by request, showed specimens of bee-candy, one of which, though sold as soft candy, was hard as a stone. The other one he described as the best soft candy he had ever seen. It was produced by a bee-keeper in Devon (a clergyman), and though it had been lying for six weeks at the office of the B.J., yet, as would be seen, it had not hardened at all. It was sold as special medicated honey-candy, intended for use in localities where foul brood was prevalent. The price was rather high, because of its having good British honey in it.

The Chairman was nervous about spreading disease if the candy had honey in it.

Mr. Carr replied that this was the maker's strongest point. He made this candy specially as a preventive of foul brood, and had described his experiments in this direction in B.B.J. of December 25 last (4991, page 516), the result being most satisfactory.

A member present inquired what heat, *i.e.*, moist or dry, was least deleterious to wax, steam, boiling water, or dry heat? If a lot of old combs be put into a heating chamber, and the wax allowed to run out as fast as it melted, would the dry heat be deleterious?

The Chairman said that two gentlemen there strongly recommended the solar extractor as best, which was practically the application of dry heat.

Mr. Weston said that the solar-extractor secured a fairly dry heat, which never exceeded the boiling point of water. But in an oven a dry heat could be obtained far in excess of any boiling point, and any heat that surpassed that might create a burning or charring of the wax. The melting point of wax was 140 deg. Fahr.

Mr. Till thought that the solar-extractor could only be used in July or August, upon which Mr. Reid said he had melted wax since Christmas in his own form of solar-extractor, which was a very simple contrivance, being merely a big basin, inside which was placed a smaller one with a piece of glass on top.

Mr. Weston said it appeared somewhat surprising that the solar-extractor would work at the present time of year, but its doing so depended largely on the continuance of the sun's rays falling on the appliance. In early spring, when there was a clear sky, the heat would remain fairly constant if the extractor were put in the sun and sheltered from cold winds. In March and April he found his extractor worked best; but in summer, when large cumulous masses of clouds were obstructing the sun's rays every few minutes, a lot of the good done was lost.

Mr. R. Brown had arranged the poultry-appliance known as a "foster-mother" to keep up the required temperature, and hoped

to explain its working and the result of its action at a future meeting.

Mr. Reid said his own improvised solar-extractor was set up in the middle of the apiary. When there was any deficiency of heat it could be increased by placing a piece of ordinary window-glass against two posts in such a position that it reflected the sun's rays on to the extractor. That would mean an increase of 20 or 30 per cent. of heat. Silvered glass would be still better, but it was too costly. A cover of plate glass kept the heat in best, but two thicknesses of ordinary glass would probably achieve the same result.

Mr. Weston considered the great advantage of the solar-extractor was that it stood in the apiary the year round as a receptacle for any old combs or bits of comb, and that the wax was removed whenever required by the bee-keeper. It might be remembered some years ago he tried a lot of experiments with the solar-extractor and exhibited the results at the "Royal" Show at Birmingham. He took some wax that had been extracted by the ordinary method and put it in fine muslin, and left it in the solar-extractor. All the *débris* remained behind in the muslin, because the sun melted the wax so gently that it oozed out, and left tiny particles of discoloured honey or pollen behind, so that it looked beautifully bright and clear. Of course, this plan would produce wax of very fine quality, but a tradesman would probably not give a penny more for it for commercial purposes.

The Chairman, in conclusion, said that the discussion had been a most instructive one, and was enlightened by the knowledge and observations of distinguished bee-keepers, who were always kind enough to give others the benefit of their experience.

A vote of thanks to the chairman brought the proceedings of the conversazione to a close.

### GLAMORGAN B.K.A.

#### ANNUAL GENERAL MEETING.

The general meeting of the Glamorgan B.K.A. was held at the Lecture Hall of the Y.M.C.A., Cardiff, on Thursday, March 19.

The chair was taken by his worship, the Mayor of Cardiff, Alderman Edward Thomas, J.P., and the attendance was very large.

The secretary having read the notice convening the meeting, the Chairman moved that the report, a copy of which was in the hands of the members, be adopted. In doing so, he said it was usual for the chairman of the meeting to enlighten his audience to some extent as to the contents of the report, whether he had read it himself or not. He was in the happy position of having read the report before moving its adoption. Bee-keeping was a very interesting and leisurely pursuit, but it was still more satisfactory to find that it was becoming an important

industry in the district. As every one knew, British honey was second to none in the market, and the keeping of bees helped somewhat to revive our failing agricultural industries. Anything which could be done to induce people to return to the land and thus help in some measure to relieve the congested state of our large towns was, he thought, useful work, and certainly bee-keeping was an aid to that end.

Mr. J. Jenkins, C.A., in seconding, said he had audited the accounts, and the result, as every one could see, was a very satisfactory one. For that position we were largely indebted to the Secretary, who had his whole heart and soul in the work.

The statement of accounts was agreed to.

The amended rules of the Association were passed unanimously, and a cordial vote of thanks to the officers during the past year was carried with acclamation.

Mr. R. T. Duncan, in returning thanks, hoped to be still associated with the work of helping a neglected industry. He relied upon the assistance of the district Secretaries to achieve the best results, and he trusted they would spare no effort in furthering the work of the Association.

Mr. F. W. Long, B.A., moved that the whole of the officers be re-elected for the ensuing year. They include: President, Lord Windsor; Treasurer, Mr. W. T. Watkin Lewis; Auditor, Mr. J. Jenkins; and Secretary, Mr. William Richards, Gabalfa, Cardiff. The Association would always have his support because it was so splendidly officered and engineered. The motion was seconded and passed *nem. con.*

Messrs. R. T. Duncan and W. T. W. Lewis were chosen to represent the Association at the B.B.K.A. Conferences.

Dr. De Vere Hunt, F.R.H.S., proposed a vote of thanks to the County Council for making a grant of £50 for spreading apicultural knowledge in the county. This was agreed to.

The Rev. W. Henry A. Walters, first-class expert, then delivered an instructive lecture on "Spring Management," and afterwards replied to questions put by members of the audience.

The usual votes of thanks terminated a very satisfactory meeting.

### NORTHUMBERLAND AND DURHAM B.K.A.

The tenth annual meeting of the N. and D. B.K.A. was held on Saturday, March 28, in the Y.M.C.A., Blakett-street, Newcastle. Taos. Garnett, Esq., presided over a large and representative audience.

Mr. Jas. Waddell, Wooler, the Hon. Sec., read the annual report, which gave a summary of the year's work, and stated that the Expert visited 322 bee-keepers owning 1,986 hives in

the two counties, cycling over 500 miles. Foul brood was found to be more prevalent than was supposed, and it is hoped that with further assistance from the County Councils that it would be greatly checked.

Twenty-two new members had joined the Association, and two District Associations, viz, the Hartlepoons and District B.K.A. and Spennymoor B.K.A., had connected themselves with County Association.

Various correspondence which had taken place between both the Northumberland and Durham County Councils as to grants towards the expert's expenses was read.

Earl Grey was reappointed President, and the Vice-Presidents, Treasurer, and Secretaries were also re-elected.

At the conclusion of the formal business, a discussion of a technical character took place on the subject of "Honey and New Appliances."

An interesting address on "Honey" was given by the Secretary, and several new appliances connected with honey production and bee-management were shown by Messrs. Walton, Rochester, Peacock, and Burkill.

Messrs. Watson, Limited, also sent a number of new goods.

A vote of thanks to the chair concluded a most enjoyable meeting.—JAS. WADDELL, Hon. Sec., Wooler.

#### SHROPSHIRE B.K.A.

The annual meeting of the above was held on Saturday, March 28, at the Mayor's Court, Shrewsbury. Mr. Roff King, presided.

The report and balance-sheet were presented and adopted. Miss M. E. Eyton was re-elected Treasurer, and Mr. S. Cartwright Secretary. The following were elected on the committee: Mr. Roff King (chairman), Miss A. Downward, Messrs. A. Beale, P. Graham, J. Hammond, W. H. Brown, A. G. Preen, P. Jones, J. Carver, J. Clay, R. Holland, J. Griffiths, P. Scott, and J. W. Whitehurst.

Much regret was expressed at the death of the Rev. J. T. Buckler, who had acted as one of the judges at the annual show on several occasions.—S. CARTWRIGHT, Sec.

#### CORNWALL B.K.A.

The annual meeting of the Cornwall Beekeepers' Association was held at Truro on March 25, Mr. W. K. Baker presiding. Dr. Clark was elected an honorary member, and it was suggested that he be invited to introduce lectures on bee-keeping in connection with the summer series of lectures on horticulture.

Votes of thanks were accorded to the retiring officers and the County Council for their grant, and the officers were elected as follows:—President, Rev. Arthur Boscawen, Rector of Ludgvan; Committee, Mrs. Tomm, Miss E. Williams, Rev. J. A. Kempe, Dr. Clark, Messrs. S. H. Lanyon, A. Curnow,

A. H. Wenmoth, G. W. Jevons, T. B. Hender, J. W. Lawry, W. E. T. Bolitho, J. R. Richards, J. Brown, L. G. Campbell, and W. K. Baker; Mr. T. R. Polwhele hon. secretary and treasurer, Polwhele, Truro.—(Communicated)

## Correspondence.

*The Editors do not hold themselves responsible for the opinions expressed by correspondents. No notice will be taken of anonymous communications, and correspondents are requested to write on one side of the paper only and give their real names and addresses, not necessarily for publication, but as a guarantee of good faith. Illustrations should be drawn on separate pieces of paper. We do not undertake to return rejected communications.*

*\* \* In order to facilitate reference, Correspondents, when speaking of any letter or query previously inserted, will oblige by mentioning the number of the letter as well as the page on which it appears.*

#### NOTES BY THE WAY.

[5081.] The fourth month of the advancing year brings us bee-keepers in the south within measurable distance of our chief honey harvest. In two months' time we shall have the white clover bursting into bloom. Bearing in mind, then, that in nine weeks the most we can do is to barely produce three generations of bees ready to take the field when white clover first blooms, we must be up and doing to secure those strong colonies we all love to find when we open the hives to put on the supers. The bee-keeper who is fortunate enough to have these rousing colonies and a flow of honey will have no trouble in getting his bees to take to surplus-chambers—be the supers in the shape of a garden handlight, lard bucket, or even a cheesebox—as readily as to the most orthodox of racks, filled with the latest up-to-date sections and dividers. All we want is bees and honey and receptacles in which they can store the sweets of nature.

We all owe thanks to our friend "D. M. M." for "Statistics" on page 113. The growth of the bee-industry in Ireland is suggestive of the possibilities of the future in other parts, for the growth and extent of bee-keeping the world over is enormous compared with what it was twenty-five years ago. Some are pessimistic with regard to the future, and prophesy that the price of honey will be 4d. per lb. for extracted and 6d. for comb honey retail; but even at that price the production of honey would be more profitable than flower-growing has become in the Scilly Isles this season. During the last five or six years there has not been a great decline in prices for honey, as the advertisement columns of B.B.J. and *Record* testify, but a shortage of crop in 1902 has not raised prices for extracted honey. A few bee-keepers have written me to say that they took my advice and held their stock of honey for better prices, but have not been able to obtain any more than if they had sold last summer. In this matter, I have no doubt they are right, but had all the honey been rushed on

(Continued on page 146.)

## HOMES OF THE HONEY BEE.

THE APIARIES OF OUR READERS.

In the experience of Mr. Booton—who is seen in his apiary below—we have still another recorded instance of the certainty with which a bee-keeper, with an eye to progress, will discard the straw skep for the frame-hive when he begins to take an intelligent interest in his bees by coming into touch with a county B.K.A. But for the visit of the expert mentioned, our friend might still retain his skeps, and take little interest in them. Now, however, we let his "notes" speak for themselves. He says:—

"It is now ten years since I became the owner of a swarm of bees—the first being a

I was going to have another successful year equal to, if not even better than, the previous one, for I had racks of sections on by the first week in May, the stocks then being in an excellent condition, and well supplied with food. However, on the first Sunday in June, I noticed numbers of dead bees lying in front of the hives, and, naturally, I wondered what was the matter. The next day there were a still greater number dead. I then examined one hive and found that the bees were slowly dying of starvation, having exhausted all their food supply.

"Happily I chanced to have some store honey by me indoors, and I immediately took off all the racks, and rubbed some honey over the top-bars of frames, letting it run down



MR. THOS. BOOTON'S APIARY, BARKING, ESSEX.

stray lot that clustered near at hand and were hived in a square box which I placed in a corner of the garden. The following year they sent out a swarm which I hived in a straw skep. In course of time I became the possessor of about half-a-dozen skeps in this way, although I confess to not taking much interest in them at the time. On the expert of our County Association calling at my place he saw me and recommended me to purchase bar-framed hives. I took his advice and have never regretted it, and I now have sixteen stocks in modern hives.

"My best season was that of 1901, when I secured about 2½ cwt. of honey, averaging about 65 lb. from each of the stocks I then had working.

"At the beginning of 1902 I thought that

among the bees. They then just had sufficient strength to commence cleaning one another. I then made a lot of syrup, and put some on plates placed outside each hive. One would have thought there would have been some fighting, but there was none. I continued to feed them in this way for a week. The weather having become a little milder when I looked in the hives again I found that they were all busy storing honey, and on June 24 I replaced the sections on eleven stocks, from which at the end of the season I took 1½ cwt. of honey, which, after taking all things into consideration, I think was very good. I might say that I attribute my success entirely to the advice and help given by Mr. Withycombe, our estimable expert, to whom I am much indebted as a bee-keeper."

(Continued from page 144)

the market as soon as removed from the hives the chances are that a glut of honey might easily have reduced prices 1d. per lb., and that there would have been no upward tendency afterwards. Then, again, there is an ever-increasing supply from abroad; not only so, but an increasing quality to compete with, some of it from our Colonies which is bounty-fed by Colonial Governments to induce the export of and establish a trade in Colonial honey in the English market. Another important fact in connection with the growth of the Irish honey industry is co-operation—not only in marketing their produce, but also in securing appliances at cheap rates by purchasing in large quantities for the supply of members. In the matter of railway rates, too, by sending large consignments, advantages are secured not available to the isolated bee-keeper here with his few sections or tins of honey, on which he has to pay the "small quantity" rate, on both purchases and carriage.

In these days of wood-working machinery, and our advertising columns teeming with offers of beehive wood cut to pattern, and dovetailed hives in the flat, I feel sure that our recruits to the ranks of bee-keeping will do well to start well in the matter of hives. The old grocer's empty box converted into a beehive may answer the purpose, but a well constructed hive lasts for a quarter of a century or more, and with a careful owner will last half a century and be in good working order. I have hives of twenty odd years in use which apparently are as good now as in the late seventies and early eighties. Therefore, to those about to invest in hives, a few shillings extra at the start is a good investment. In the matter of appliances required for the coming season, do not forget to place your orders early; and if untoward weather prevails, do not let your bees starve. Sugar is cheap, and a few bottles of syrup will keep them going, or if your apiary is isolated you can feed in the open by giving the syrup (thin) in shallow dishes or pans, and a few straws on the top to prevent the bees drowning.—W. WOODLEY, *Beedon, Newbury.*

#### TALL SECTIONS.

[5082] Mr. Loveday's reply, on page 107, to my article of January 26, is of peculiar interest, as showing how to avoid or twist the points of an argument. I must, therefore, apologise to the Editors and their numerous readers if in bringing Mr. Loveday back to the points he has so cleverly missed, I take up space which might have been occupied by more useful matter.

Shall we imagine that he has volunteered for our future citizen army, and has been practising with the rifle for some time in a squad of Essex hopefuls? As only good shots are required, they are invited one day to com-

pete on Hatfield Heath for the honour of being chosen as worthy defenders of their country. My article shall be the target, and Mr. Loveday has first to fire four shots. The result will show what chance he would have to secure a coveted place. He steps forward with a careless confidence in his own ability. ("If Mr. Lamb has so little else to advance," &c.), and fires—*First Shot*.—"Mr. Lamb, in his efforts to assure your readers that the 5 in. section is superior to the square section," then quotes the late Sir James FitzJames Stephen. (Signalman reports:—"Shot sky-high, and killed a passing crow!") The captain begs Mr. Loveday to be more steady, reminding him that he is handling a rifle and not a rocket apparatus.) Yes, it was a bad mess. The quotation from the learned judge was made for exactly the opposite reason—not to assure, but to warn off. I ought, perhaps, to have written more simply for him—something like this: "Now, friend Loveday, I have been advocating the tall section, but if you are inclined to regard me as a specialist or expert in this line and think I may be somewhat biased, you have a perfect right to be on your guard and to test for yourself every statement I have made, for you have the great authority of Sir James FitzJames Stephen for so doing."

*Second Shot*.—In the imaginary words Mr. Loveday puts into the learned judge's mouth, and especially "great improvement upon the methods in use for obtaining comb-honey previous to the adoption of the 1-lb. section."

(Flag signal: "The shot fell short, stirred up dust at foot of target.")

No. Mr. Loveday, the learned judge would have said no such thing. At your very suggestion he would have exclaimed, "Save me from my friends." Why? Because the imaginary words would have been open to the retort—"My lord, as our time and the patience of the jury are not unlimited, and there is no dispute about the many and great changes made in the past, may I beg your lordship to sum up the evidence for the advantages to be gained by a change from our present methods," &c.

In passing, may I suggest that Mr. Loveday writes a short history, with dates of the progress, improvements, and perfections (if he likes) in apiculture; such a volume carefully written would be instructive.

*Third Shot*.—Mr. Loveday writes: "His comparisons of the tall sections and the produce of dirty and untidy bee-keeping." (Signal, "Shot grazed the target and buried itself in sandbank. Mr. L. impatiently examines his rifle. The Captain: Come, come, Mr. L, you are surely not going to lay the blame on your weapon? You must pull yourself together and save the credit of Essex.")

I must request Mr. Loveday not to distort my words. I spoke of "dirty and unfinished sections" and cast no reflection on any

individual. He may, perhaps, be able to persuade a bad workman that the motto should be "workmen find fault with their bad tools," and he is at liberty to think there is no difference between "a dirty pig of Mr. Loveday" and "a pig of dirty Mr. Loveday." But I doubt whether our Editors will admit that it is all the same should a critic say:—"An unfair article in the Journal" or "an article in the unfair Journal." At any rate, I object to my adjectives being displaced; and I insist on my point that most of the dirty unfinished sections are so presented to the public because there is an inherent defect in them—they are unsuitable to our changeable climate; being so thick they are not rapidly completed, and a large proportion of them are at the end of the season left unfinished on the hands of the bee-keepers. Some of us break up a great many rather than use again such as are tarnished or propolised badly; others cannot afford to do so. In this respect the tall section will prevent a terrible leakage as well as raise the market standard.

*Fourth Shot.*—Mr. Loveday writes, "There is practically no connection between this, that is, the makeshift way of producing comb-honey adopted by Rev. T. Adams, and the 1 lb. section." (Mr. Loveday, after firing, steps aside, with a triumphant air.) His friends cheer—"Surely a bull's eye!" A person with a field-glass remarks, "That is interesting; but—oh, dear! I am afraid my glasses are out of order; the target looks smudged." Then the strange report arrives, "The shot hit with terrific force, disfiguring greater part of surface—evidently an explosive bullet." The competitors cry, "Boer bullet," "unfair," "shame." The captain records their protest and promises a strict inquiry.

Well, I congratulate Mr. Loveday in leaving his tactics of beating about the bush and coming at last into the open. Will he also come to close quarters? We will see. His apparent onslaught is splendid! It almost takes one's breath away. And the boldness with which bee-keepers are asked to swallow his statement—"One has only to read the account of the makeshift in order to find that it is so." I can imagine some saying, "What a simpleton Mr. Lamb must be to be caught in such a corner!" And others, "One of the two engaged in this controversy must be grossly careless or unscrupulous. Is it Mr. Lamb or Mr. Loveday?" Fortunately, we can soon find out the truth for "one has only to read the account," and we had better add, "with ordinary intelligence." Here it is, copied from page 25.

Mr. Loveday must, of course, join us in its perusal, and it would be as well to put on our spectacles lest we mistake a single word. The Rev. Mr. Adams writes under "the Home of the Honey-Bee," "I have tried the usual 1-lb. and 2-lb. sections, but I find that the shallow-bar frames divided equally into

two parts by two adjoining pieces of wood in the centre are taken to more readily by the bees, and when the two parts are (easily) sawn asunder they are just about the same weight as the 1-lb. sections, and as readily disposed of to the purchaser. This contrivance I regard as one of the special helps to the large 'takes' which I sometimes have." Now what does our East Saxon friend think of this? If he cannot admit that this evidence is wholly on my side—that there is a real connection between Mr. Adams's makeshift and the 1-lb. section; or, in other words, the one was adopted because the other was found unsatisfactory. Will he be so good as to tell us what he thinks Mr. Adams's words mean? Until then I shall consider that he has fired a grossly reckless and unfair shot. If we still differ I shall be happy to suggest that we ask our Editors to decide who is right as regards the Rev. Mr. Adams's quoted words. If they say I am in the wrong I would further propose to pay a fine—say from £2 to £5—to any Essex charity Mr. Loveday may name if Mr. Loveday is willing to do the same for Yorkshire should the verdict be against him.—RICHARD M. LAMB, *Burton Pidsea.*

#### HOME-MADE HIVES.

[5083.] In reply to the criticism of "W. D." on page 137 last week, allow me to say I have full confidence in my friend, who would not mislead me in the matter of hive-making. But in order that I might better be able to meet the objections of "W. D." in dealing with my letter on page 126 I have paid another visit to my bee-keeper friend. He lives about fifteen miles from Ipswich, in a charming country house, and certainly has no need to make his own hives, but does it for a "hobby." At breakfast, when talking the matter over, I learned that he gained the idea from the "Gayton" hive, which is supplied by the makers in the flat, made of  $\frac{1}{2}$ -in. material. Surely there is not so much difference between  $\frac{1}{2}$  in. and  $\frac{1}{16}$  in. as to cause my description to be called "misleading"? By way of illustration my friend drew my attention to some pheasants on the lawn, and said "Nature did not provide those birds (though exposed to all weathers) with a thick feather for the winter, but two feathers on each stalk, and when very cold they ruffle out their feathers to allow air to pass between, to gain warmth. "Two thin vests are warmer than one thick one." Two thin boards nailed 1 in. apart, with the space between filled lightly and evenly with straw (cut evenly to fill the space) is the secret for an even temperature. On no account ram the packing close down (sawdust and chaff are bad, for they settle down close), and a 1-in. board gets hot and makes the hive hot and stuffy.

I now propose to make a hive on the lines given. *Body-box.*—Cut two pieces 9 in. by  $\frac{7}{16}$ , 17 $\frac{1}{2}$  in. long; then cut two "ploughs"

$\frac{1}{16}$  in. full deep and  $\frac{7}{16}$  in. wide,  $\frac{1}{8}$  in. from the outer edge, leaving  $14\frac{1}{2}$  in. inside. Then cut two pieces  $17\frac{1}{4}$  in. full. Nail the faces inwards and saw and plane to  $8\frac{1}{2}$  in., chamfering the edge to  $\frac{1}{8}$  in. thick for frames to rest on. Saw into four strips one of the  $2\frac{1}{2}$  in. by 24 in. long pieces, and plane them down to  $\frac{7}{8}$  in. wide and shorten to  $17\frac{1}{4}$  in. The four pieces cut off will make a recess, when put together,  $16\frac{1}{4}$  in. by  $6\frac{3}{4}$  in. by  $\frac{7}{8}$  in. deep. When putting hive together use a little "Seccotine," which is better than glue. Make the nail-holes from the inner side to the outer with a fine bradawl. The fine wire-nails will go properly in, no special care needed in nailing. (This is a wrinkle.) Lay the cut straw evenly in the recess, and seccotine the four ends of the "splines," letting them in front and back  $\frac{1}{16}$  in. deep; nail on two 18-in. sides using seccotine. When set the hive will be as firm as a rock and 18 in. square. The straw-covers off empty bottles answer well for packing (cost of wood, 10d.).

**Floor Board.**—Two pieces 2 ft. long by 1 in. braced on lower under-side, also under entrance hole, with lathing "spline"  $1\frac{1}{4}$  in. by  $\frac{3}{4}$  in. at the sides to  $17\frac{1}{8}$ , dovetail the "splines" in, nail on your second-hand stuff to 19 in., plane the new  $\frac{1}{16}$  in. to  $\frac{3}{8}$  in., and put on contrary way to 18 in. cut-out entrance (cost of wood,  $5\frac{1}{2}$  d.).

**Dummies** (two are used).—Two sides  $\frac{1}{4}$  in. stuff nailed on to strips  $\frac{1}{2}$  in. wide, giving  $\frac{1}{2}$  in. air-space between. One dummy is easily converted into a first-class feeder holding  $\frac{3}{4}$  pint syrup (cost of wood for the two dummies, 6d.).

**Lift.**—9 in. deep, 18 in. square; plinth's lathing "spline"  $1\frac{1}{8}$  in.,  $\frac{3}{8}$  in. planed. This is very cheap, 100 ft. for 1s. (cost of wood, 7d.).

**Roof.**—Four sides of lathing "splines" fits over lift; nail on top; cover with calico or brown paper soaked with linseed oil, and sift whitening on; when dry, paint well. This stands weather. The following is an excellent recipe for waterproofing; the addition of acetate of lead prevents material from rotting:—Linseed oil, 3 pints; acetate of lead, 1 oz.; resin (pale), 4 oz. Grind the lead with a little oil, mix in the other ingredients, melt over a slow fire, and apply hot.

The above information is not "misleading," but it is sound and good advice, while for practical purposes this hive will be hard to beat. If intended as a travelling hive, use  $\frac{3}{4}$  in. front and back; do not alter sides. Total cost of this hive, as given above, 3s. 2l. —"JIM," Ipswich.

#### MEDICATING BEE FOOD.

[5084.] Referring to query 3054 (p. 137), I think I know who "Cumbrian" is, and if so, I would point out, that your reply, "Use naphthol beta as directed on package," for medicating honey, does not tell him just what he intended to ask. The directions on package give proportions in weight of dry

sugar, but it seems to me our friend "Cumbrian" wants it in weight of honey, which includes water; and as the water in sugar-syrup weighs, roughly speaking, half as much again as the sugar, would not the same apply to honey? And according to this one tablespoonful of naphthol beta to 10 lb. of honey would be an overdose, and two-thirds of the naphthol beta would, I think, be nearer the mark.—GEORGE M. SAUNDERS, Keswick, April 4.

[We do not at all mind our replies to queries being improved upon by anyone who kindly takes the needed trouble, therefore we print the above for the benefit of "Cumbrian," and thank Mr. Saunders for writing. We may, however, be allowed to say that in the reply on page 137, we supposed that "Cumbrian" would take a broad view of our meaning when referring him to the "directions on package." The honey in question would require largely diluting with water, to bring it to the consistency of thin syrup for spring feeding, and the directions deal with certain proportions of sugar and water to which is added a given quantity of Naphthol beta solution. And we credited "Cumbrian" with the exercise of ordinary intelligence in guiding him aright when medicating the syrup-food as intended.—EDS.]

#### WEATHER REPORT.

WESTBOURNE, SUSSEX.

March, 1903.

Rainfall, 2.86 in.	Minimum on grass, 23°, on 11th.
Heaviest fall, .52, on 17th.	Frosty nights, 8.
Rain fell on 19 days.	Mean maximum, 50.8°.
Above average, .94 in.	Mean minimum, 40.5°.
Sunshine, 141.5 hours.	Mean temperature, 45.6°.
Brightest day, 26th, 10 hours.	Above average, 5.1°.
Sunless days, 5	Maximum barometer, 30.42°, on 8th.
Below average, 10.1 hours.	Minimum barometer, 28.90°, on 2nd.
Maximum temperature, 62°, on 25th.	
Minimum temperature, 27°, on 11th.	

L. B. BIRKETT.

## Queries and Replies.

[3059.] *Bees and Horses.*—I shall be glad if you will give me your opinion as to whether it will be safe for me to re-install my apiary of five hives in a position as shown on rough sketch herein? I am removing from a town twenty-four miles away to Stroud, and have a chance to utilise a small strip of ground in a field at the back of our works. There is some-



times a horse grazing in a field directly in front of the hives, but he can get no nearer than about 10 yards because there is a brook, a ditch, and a wood fence between. In the field where I propose placing the hives there are also a couple of goats grazing, and they are tethered, but I can fence them off, although I do not see any necessity to, seeing they are chained to a peg, which is shifted every day. A reply would oblige, and save me much uncertainty.—F. J. M., *Stroud, Glos.*

REPLY.—Though, of course, not entirely free from risk, it will be fairly safe to locate the hives as proposed, if the bees are managed with care and intelligence. The risk—if any—might also be still further minimised if the hive-entrances could conveniently be made to face in the opposite direction to that shown on sketch, thus directing the bees' line of flight away from the grazing-ground of horse, instead of towards it, as proposed.

[3060.] *Transferring Bees.*—As a reader of the BEE JOURNAL and of the "Guide Book" may I ask for reply to the following questions in an early issue of B.B.J.? 1. A week ago I bought a strong stock of bees in a skep. Would it be safe to place this on a bar-frame hive with frames of foundation and let the bees work down, or is it too cold yet for the operation? 2. Is honey as sample sent of good quality, and from what source has it been gathered? 3. What is the stuff on opposite side of comb? 4. Would it be good for the bees if I mixed a little rum in with syrup given? 5. How can I become a candidate for the third-class expert's certificate? 6. Are bees sent just the ordinary English, or have they any foreign blood in them?—L. A. T., *Bromley, April 6.*

REPLY.—1. The skep must not be set above frames till weather is warm and honey is coming in from natural sources. 2. Honey is only of medium quality; it is from mixed sources, chiefly lime. 3. Pollen only. 4. Do not give "rum" to your bees; they are—or ought to be—total abstainers. 5. Write to Mr. Edwin H. Young, secretary B.B.K.A., 12, Hanover-square, W. Do not overlook the fact, however, that an expert must know "all about bees and bee-keeping," practical and otherwise. 6. Bees are the common brown variety.

[3061.] *Queen Ceasing to Lay in March.*—As a reader of your valuable B.B.J., may I ask for your opinion on queen bee sent herewith? I introduced her on October 1 last year, and she laid splendidly before the year was out. I examined the combs again on February 27, and there was a splendid lot of brood and eggs in them. But I saw the queen on March 31 flying about in the warm sunshine. She soon alighted, and I caught her as she was running into the hive. On examining the combs I found neither eggs nor brood in the cells, and in consequence was wondering if the parent queen had died and

this was a virgin princess? I must, however, tell you there was no sign whatever of a queen-cell in any of the frames. They have plenty of stores. Please examine queen and say, What do you advise me to do with her?—H. B., *Newtown, Stourport, April 1.*

REPLY.—The fact of no queen-cells being found makes it clear that a new queen cannot have been raised; therefore the one sent must be the mother-bee. We did not remove queen from cage as there was no outward appearance of injury to account for cessation of egg-laying, but we suspect you have injured—perhaps ruptured—her ovaries in some way when examining the combs at end of February last. The only course was to return queen by post (as we did), and we hope you got her safely back into the hive, as both queen and her attendant bees were nearly dead with cold on arrival. If safely re-introduced, it will be soon seen if any chance remains of a re-start in egg-laying, when you may keep or destroy her as the occasion warrants.

---

## Echoes from the Hives.

*Wells, Somerset, April 1.*—My bees, which are all Mr. Sladen's strain, have wintered well, and are now working freely on the fruit-blossoms. Each hive has now three or four frames filled with brood.—A PERKINS (Major).

*Charlton, Chichester, April 6.*—We are having bad bee-weather here of late, cold winds every day. Palms have bloomed freely for a month past, but not much bee-life on them. Plum and pear trees are now bursting into full bloom; so we must hope for warm weather soon, and a better season for all than last year. My "death roll" is rather heavy (five out of seventeen stocks), but one is a recurrence of the old grievance in the "Wells" hives, *i.e.*, one lot gone clean away or joined up to next compartment. The rest are in good condition with plenty of stores at present. I saw drones flying March 15.—JAMES PALMER.

---

## Bee Shows to Come.

*A nominal charge of 2s. 6d. is made for notices in this column, which covers cost of insertion from order till date of show. Cash should accompany orders for insertion.*

June 23 to 27, at London.—"Royal" Agricultural Society's Show. Bee and Honey Section under the management of the B.B.K.A. Increased prizes for B.K.A. Associations as arranged in divisions or groups of counties. Schedules from Edwin H. Young, Secretary, 12, Hanover-square, W. Entries close May 1, or at extra fees up to May 15.

July 22 and 23, at Cardiff.—Honey show of the Glamorgan B.K.A., in connection with the Cardiff and County Horticultural Society. Bees, hives, honey,

trophies, wax, appliances, and articles of food. Substantial money prizes and medals. Free entries. Six open classes. Schedules from William Richards, Gabalfa, Cardiff. Entries close July 16.

July 30, 31, and August 1 and 3, at Old Trafford, Manchester.—Annual Show of the Royal Lancashire Agricultural Society. Liberal money-prizes are offered for honey along with silver and bronze medals of the B.B.K.A. and also of the Society. Open classes for Honey-Trophy, Sections, Extracted Honey, Beeswax, Instructive Exhibits in Bee-Culture, &c. Schedules, when ready, from Edward Bohane, Secretary, Miller-arcade, Preston.

August 4, at Leamington.—Tenth annual show of the Leamington St. Mary's Horticultural Society. Three open classes for Six 1-lb. Sections, Six 1-lb. Jars "Light," and Six 1-lb. Jars "Dark" Extracted Honey, respectively. Liberal money prizes. Schedules from P. W. Smith, Secretary, 22, Leam street, Leamington. Entries close July 30.

August 12, at Radstock, Bath.—Honey show in connection with the annual show of the Radstock and District Horticultural and Fanciers' Association. Schedules from the Secretary, B. M. Clark, 1, Fox Hills, Radstock, Bath.

August 27, at Llangollen.—In connection with the fifth annual Flower Show. Open classes for Six 1-lb. Sections, Six 1-lb. Bottles Extracted Honey, and Beeswax. Schedules from Frank Little, Castle-street, Llangollen. Entries close August 13.

### Notes to Correspondents & Inquirers.

Letters or queries asking for addresses of manufacturers or correspondents, or where appliances can be purchased, or replies giving such information can only be inserted as advertisements. The space devoted to letters, queries, and replies is meant for the general good of bee-keepers, and not for advertisements. We wish our correspondents to bear in mind that, as it is necessary for us to go to press in advance of the date of issue, queries cannot always be replied to in the issue immediately following the receipt of their communications.

All queries forwarded will be attended to, and those only of personal interest will be answered in this column.

D. T. R. (Londonderry).—*Dealing with Foul Brood*.—1. The brood in comb sent is chilled only—not foul. In one cell, however, we find slight traces of incipient foul brood, so that—even judged by the small piece of comb sent—there are the elements of disease in the hive. If, therefore, the other combs are not more seriously affected than sample you had better trust to the disinfectants now used for keeping the disease under, without going so far as proposed. The prevalence of foul brood in your near neighbour's hives constitutes the greatest danger you have to contend with. 2. We have no experience of the "remedy" you name for "killing the spores of foul brood," nor do we intend to test its effects in that direction, for very good reasons. 3. If you are prepared to pay a moderate fee for a few months' experience in dealing with foul brood we might suggest a suitable place for acquiring sound knowledge on the subject on hearing from you by post. 4. Your "Strange experience" will be dealt with in our query column next week.

A. SMITHERS (Barnet).—*Bee-keeping in America*.—The most suitable book for your purpose will be the "A. B. C. of Bee

Culture," published by the A. I. Root Co. It can be had through this office for 5s. 6d., post-free.

"B" (County Durham).—*Painting Stocked Hives*.—If painting is done after bees have ceased flying for the day no harm will follow, as paint will be dry next morning.

### Suspected Combs.

*Special Notice to correspondents sending queries on "Foul brood."*

We urgently request that all letters sent with samples of suspected comb be put outside the box or tin containing the sample. Also that no more than a couple of square inches of comb be sent, taking care to neither crush the comb nor probe the cells before despatching.

In urgent cases (and where possible) we undertake to "wire" replies as to F.B. if six stamps are sent to cover cost of telegram. All letters should be addressed "Editor," not "Manager."

J. C. S. (Gorebridge).—There are slight signs of incipient foul brood in comb sent.

R. B. D. (Bucks).—Chilled brood only; no disease in comb.

\*\* Some Letters and Queries are unavoidably held over till next week.

### Special Prepaid Advertisements.

Twelve words and under, Sixpence; for every additional Three words or under, One Penny.

NINE STOCKS BEES in Skeps, 10s. each. GEORGE WEBB, Station-road, Swindon. s 99

WANTED, ONE or TWO STRONG STOCKS of BEES Particulars and price to WOOD, Ford House, Holmfirth. s 92

FOR SALE, Natural SWARMS; May, 12s. 6d.; June, 10s. 6d. Book now. C. HAYNES, Hanley Castle, Worcester. s 82

BEAUTIFUL HEREFORDSHIRE HONEY, in 4-lb. tins. Sample 2d. THOMAS CHARLES, Much Marcle, Glos. s 89

BEES FOR SALE in "W.B.C." and other Hives, healthy and strong. ROBERT GRAY, Meadow House, Bromborough, Cheshire. s 98

FOUR HIVES, Extractor, and accessories; sell cheap. BELL, 156, Club Garden-road, Sheffield. s 81

WANTED, STRONG, HEALTHY STOCK BEES, Standard Frames, without Hive preferred. Full particulars. DART, Missenden, Bucks. s 93

STRONG STOCK of BEES in good Hive, with window at back; Frames, 14½ by 9½; price £1. IL WITT, Ascot, Berks. s 87

WANTED, BEES. State full particulars, condition, weight, price, &c. BRAYSHAW, Aultmore, Keith. s 91

RABBITS, PRIZE BRED BELGIAN HARES, prolific strain, three months old, both sexes, 2s. each, usual reductions. W. LOVEBAY, Hatfield Heath, Harlow. s 88

GOOD STOCKS in Skeps, 1902 Queens, 12s. 6d.; Stocks in Standard Frame Hives, 28s. to 35s. each. Guaranteed healthy. WOODS, Normandy, Guildford. s 84

## Editorial, Notices, &c.

### DEATH OF MR. T. G. NEWMAN.

We regret to have to announce the death of Mr. Thos. G. Newman, who was for many years editor of the *American Bee Journal*. Mr. T. G. Newman was an Englishman, having been born at Bridgwater, Somersetshire, in 1833. He lost his father when ten years of age, and he and three brothers went to work to support the family, the mother being left penniless by the father's endorsing a bill for a large sum. Mr. Newman chose the trade of printer and book-binder, and having thoroughly mastered it after an apprenticeship of seven years, he emigrated in 1854 to Rochester, New York, where he had relatives, and at once secured employment on a paper. He soon became assistant foreman of the *Rochester Democrat*, and later, spent several years in editing and publishing a religious paper called the *Bible Expositor and Millennial Harbinger*, as well as a number of theological works. After that he published and edited a daily paper at Cedar Rapids, Iowa. Removing to Chicago in 1872, the next year he became acquainted with the Rev. W. F. Clarke, who sold him his interest in the *American Bee Journal*. Subsequently, Mr. Newman acquired the interest of two others, and thus became sole proprietor of the paper which at that time had less than 800 subscribers. For three years he employed as editors the Rev. W. F. Clarke, Mrs. E. S. Tupper, and Dr. C. C. Miller, while he was himself studying the practice of bee-culture. Commencing with three colonies he increased to more than a hundred in 1879, and so thoroughly had he worked at practical bee-keeping that he was able to conduct the *American Bee Journal* with credit for twenty years, and increase the number of subscribers to five thousand.

Mr. Newman came over to England twice, first, with his family, in 1864, for a rest, when he remained here until 1869, and again in 1879, when he made a tour of Europe. It was on this latter occasion that he visited the Royal Agricultural Society's show at Kilburn, and in the bee-department his kind and genial manner won him many friends amongst British bee-keepers. He also visited many apiaries and was present at a luncheon given at our residence in Horsham, at which besides the representative bee-keepers of this country, there were also present Mr. J. Dennler, of Alsace, and Mr. Gravenhorst, of Germany. On this occasion all three guests received a silver medal in commemoration of their visit. From England Mr. Newman went to France, Germany, Austria, Switzerland, and Italy, where he made the acquaintance of the leading bee-keepers. On our visit to the United States in 1887, we called upon Mr. Newman in Chicago and spent a very

pleasant time with him in viewing the neighbourhood. We saw him again in San Francisco quite recently, but he was looking very worn and had become nearly blind, but he readily recognised us by our voice. We had a nice chat on old times, and he referred with pleasure and pride to the photograph, which he still had, that was taken at our country house in 1879, before all the guests had left. There were nineteen in the picture, but of these only six survive; Abbott, Peel, Cheshire, Gravenhorst, Sisson, Hunter, and Jackson being amongst the most noted names of those who are no more with us.

Mr. Newman was for two years President of the National Bee-keepers' Association, and for fifteen years general manager of the National Bee-keepers' Union. For the past seven years he had been living in California, where he was editor, treasurer, and general manager of the *Philosophical Journal* of San Francisco. Mr. Newman, like all other honourable editors, had to stand the abuse of petty jealous rivals, but he, like others, lived to see these rivals die out one by one, and the *American Bee Journal* rise higher in the estimation of all respectable bee-keepers. It was started as a monthly, now it is one of only two weekly bee papers published, the other being our own BRITISH BEE JOURNAL, with which it enjoys an equal prestige.

We have nothing but the most agreeable reminiscences of our intercourse with Mr. Newman, and are sure that all our readers will join with us in sincere sympathy with Mrs. Newman and family in this time of their sorrow.

### LINCOLNSHIRE B.K.A.

The annual general meeting of the Lincolnshire Bee-keepers' Association was held on Saturday, the 4th inst., in the Guildhall, Lincoln (by kind permission of the Mayor). In the unavoidable absence of the President, Lord Heneage, the chair was taken by G. J. Young, Esq., J.P. The minutes of the previous meeting having been read and confirmed, the annual report was read, from which it appears that the Association is still increasing, having now 600 members, and a satisfactory balance in hand. A vote of condolence with the family of the late auditor was passed, and a good practical lecture on Foul Brood afterwards given by Mr. Herrod. Drawing for prizes and a tea concluded a very successful meeting.—(Communicated.)

### HONEY IMPORTS.

The value of honey imported into the United Kingdom during the month of March, 1903, was £2,850.—From a return furnished to the BRITISH BEE JOURNAL by the Statistical Office, H.M. Customs.

## Correspondence.

*The Editors do not hold themselves responsible for the opinions expressed by correspondents. No notice will be taken of anonymous communications, and correspondents are requested to write on one side of the paper only and give their real names and addresses, not necessarily for publication, but as a guarantee of good faith. Illustrations should be drawn on separate pieces of paper. We do not undertake to return rejected communications.*

### AMONG THE BEES.

#### DRONES.

[5085.] The drone is not in very good repute; with many he is in very bad odour, though why it would be hard to say. He has endured a cycle of silence with occasional periods of calumny. Poets have railed at him and his ways; prose writers have frequently showered opprobrium on him. Even bee-men who ought to have known better, have poured obloquy on him, gloried in his downfall, and made a mock of his expulsion by the "executors pale." They have, foolishly, derided his want of industry, black-balled him, and called him bad names. He has been designated a "yawning" drone, an "idle" drone, a "lazy" drone. Authors have used him disrespectfully, and compared him to idlers and loafers; to men indisposed to work, to weaklings physically and mentally—all these are called "drones of society." The comparison is odious, out of place, inept, and the term is wrong and misapplied. It does the drone a grievous injustice and calumniates him.

The drone was designed for a definite purpose. He fulfils it admirably and well, and so completes and carries out his destiny—aye, though he forfeits even his own life in accomplishing the immutable purpose for which he was created. Though death overtakes him in the very moment of victory, he dies to give life to thousands, and thereby carries on the race from generation to generation through the long æons of time. The destiny is noble; the creature who carries it out deserves our praise, and not our blame. Then why apply so worthy a name to those despicable "drones of society," who toil not nor spin? Why should apiculturists rail at the male bee for not being a worker, a collector, a manufacturer, a producer of honey, when from Creation's dawn Nature decreed him for another purpose? He, too, ought to have his little niche in the temple of Fame, for he lays down his life at the call of duty. What deed could be nobler?

The following points in the drone move our wonder and admiration: his magnificent compound eyes; his marvellous ocelli; his mysterious antennæ, with their extra joint; his keen olfactory organs; his super-delicate organs of touch; and the special functional organs. Each would require a separate article to itself, so wonderful and so perfect are they all. The drone's powers of vision and of flight are sublime! His magnificent compound-

eyes are admirably fitted for the one duty and function of his life—the single *magnum opus* of his existence. Occupying almost the entire space on both sides of his head, they are excellently adapted to assist him in carrying out this purpose to perfection. In his flights through the air their immense magnifying powers enable him to pierce with keen vision the liquid blue, and so he is enabled quickly to detect any royal virgin out for her nuptial flight; while all his three *ocelli*, or simple eyes, placed as they are in a close cluster right in front of his forehead, closely observe her every motion, and follow minutely each rhythmic cadence in her quick aerial course. Rapid as is her progress in the circumambient air, his powers of flight excel—though only in the case of one out of thousands. Swiftly and unerringly, therefore, he pursues her path bent on one single object—the one sole cause of his being called into existence. Those who stupidly and erroneously designate him a *lazy* drone should see him then, when every muscle is strained to the fullest tension, when every nerve is strung to its utmost, when every thought and sentiment of his being is focussed on one object, and when every feeling of body and mind is concentrated on the one desire—to outstrip all rivals, and be the first to reach the goal of his and their longings.

All puny, weak, or starveling drones; all who are small, feeble, or delicate; those undeveloped, dainty, or over luxurious; and all sickly and infirm, each according to the degree of its want of vitality, drop out of the race at an early stage. As the diaphanous atmosphere is pierced and the flight reaches higher regions of space, only the virile, "manly," and vigorous remain to mark the pace and keep the aim of their ambition in full view or close proximity. She, fickle as maids are wont to be, eludes first one and then the other, till only a tithe of the most powerful and best developed remain as royal suitors. All of these put their last remaining efforts to their fullest powers of proof to show their right to be Prince Consort. At last the fittest only survives, and noble destiny becomes the medium for perpetuating the race. Here is a scheme, magnificent in its conception, exquisite in its development, and perfect in its fulfilment. How vain and futile are man's imaginings and inventions placed alongside of it. Yet there are those who toy with puny appliances designed to improve on this admirable scheme of selection.

It is not to be granted that I advocate a do-nothing policy, for my aim is to call attention to the drones, with the object of doing all we can to improve and select only the best of them. It appears singular that when so much care is taken to breed from the very best males alone in all sections of live stock, apiculturists are so supine in the matter when so much of success depends on the drone-bee. I do not for a moment advocate that we

can, or should, select the proper mate for a queen. So much more than might merely please the eye goes into the sum total of her Articles of Choice that she can undoubtedly mate more truly and to better advantage of her own free will. But we can do a great deal to make our drones worthy coadjutors of our best queens. During certain periods of the year a fair number is indispensable in every well-regulated apiary, but we should see to it that only the choicest and most fully developed are allowed to live, and all others should be got rid of as undesirables. Those bred in worker cells, all reared from fertile workers, and all originating from unfertilised queens, should be suppressed as not likely to approach to the highest standard we should aim at securing. Careful feeding, with proper food, assists full development, and ill-fed, half-starved hives cannot turn out the best specimens. Weak or aged queens cannot be expected to supply strong, able-bodied males; and diseased stocks must yield inferior strains, unworthy to consort with any good queen. Drone-rearing in all such colonies should, therefore, be rigidly suppressed.—D. M. M., *Banff*.

## STRONG COLONIES.

### UNITING IN AUTUMN.

[5086.] Mr. Rymer (on page 116) gives valuable testimony in favour of autumn uniting. I have also experienced the benefit of uniting nuclei to working stocks, my method being to extend brood nest to twelve or thirteen frames, then, when supering, contract to ten, the removed frames being shifted into a nucleus hive and a queen cell given. This done, the little lot is fairly strong by August, and is then united to the parent stock, after destroying the old queen. I find that the colonies so treated always do better than those that merely get a new queen without attendant bees, and consequently have come to the conclusion that if such advantages can be had by uniting with a nucleus, still better results would be secured by joining up to a ten-frame colony. I make a point of requeening each stock every year, and am strongly of the opinion that the reason why stocks headed by a young queen should give trouble by swarming is through the queen being cramped for breeding room.

There seems to be an impression that the queen's laying powers should be at their highest pitch while the honey-flow is at its best, and no doubt in a state of Nature such would be the case, and the colony would lay up sufficient for its own requirements, but the bee-keeper's main object is to secure a large amount of surplus; therefore, the queen must be made to do her utmost before the flow begins, so that there may be a strong population ready to make the most of it. Under ordinary management the queen gets no chance to do her best until the honey-flow is on, and then with overcharged ovaries she

vainly seeks cell-room in a brood-nest lessened by the incoming nectar. In this case swarming would be inevitable unless relief is given by the substitution of empty frames for those filled with brood; but any such proceeding would of course, be merely making the best of a bad job. It is significant, as testifying to the efficacy of his method, that Mr. Rymer is able to work his colonies without the issue of a single swarm.

Not being a reader of the B.B.J. before then, I knew nothing about the "Rymer" method until the end of last July—too late to give it a trial; but I saw that it would have to be considerably modified to suit the requirements of my own district. I therefore come to the conclusion that the doubling and dividing of the brood-nest must be carried out before the season opens, the removed part being requeened and worked as an auxiliary to the parent stock, and the two lots being finally united at end of the season.

In the "Guide Book" we read that to keep our colonies strong they must, except in winter, be constantly kept breeding by stimulative feeding.\* But our management necessitates brood-rearing being only a secondary consideration during the honey-flow, everything else being subordinated to the piling up of a heavy surplus, with the result that the colony is, at end of season, found to be possessed of only one requirement of successful wintering—plenty of stores.

Most bee-keepers have had some experience of "weaklings" that, owing to being headed by a worn out or failing queen, are found to be covering only three or four frames at the commencement of the honey-flow: but when the queen is removed and replaced by a young vigorous successor the stock builds up rapidly, for the reason that with such a small population of workers the queen has it all her own way, all the honey taken into the hive being used up in brood-rearing. At end of the season this colony would be possessed of all the elements of success except one, and that could be secured by joining up to the stock with superabundant stores. If carried out in this manner "Autumn uniting" would reduce the apiary to rather small proportions; the right way, therefore, would be to get ahead of the swarming fever by taking a certain amount of increase from each colony early in the season, allowing the new lot to build up with a young queen during the honey-flow and uniting when honey gathering is finished. Mr. Lamb (page 115) recognises the benefit of a narrow brood-nest for wintering, and the disadvantage of having the brood-frames overloaded with stores in spring. I can under-

\* Without quite knowing what passages in the "Guide Book" our correspondent has in mind here, he may rest assured that it forms no part of the author's teaching to advocate feeding bees during the honey-flow. "Summer Feeding" is dealt with on page 111, and the author's own views are, we venture to think, in entire accord with the most up-to-date "Management," as carried out by experienced bee-keepers at the present day.—[W. B. C.]

stand that in hives of the "Combination" type the bees might perish during severe weather through being unable to reach the stores in the distant combs. The principle of a long, shallow brood-nest for wintering is altogether wrong. When left to their own devices bees build their combs very long and always winter safely on such combs. At the beginning of winter they will be found clustered on the lower part of combs, and as stores are consumed the cluster gradually moves upward. Then on the approach of spring, with renewed activity on the part of the queen, the cluster expands and works downward again, and the large extent of empty comb gives ample scope for ovipositing, while at the same time there is always above the brood-area a large reserve of stores to encourage the carrying on of brood-rearing without the slightest intermission. When wintered in this way, a colony would, as Mr. Rymer says, build up naturally, and without any spring humbugging. The bee-keeper can secure the advantages of a deep, narrow brood-nest for wintering either by using a larger frame than the standard, or a double tier of the latter.

But here is the point:—When it comes to working in supers, the deep brood-nest has to take a back seat. The heaviest crops of surplus-honey are always secured above shallow brood-nests. A brood-nest composed of deep frames cannot be made shallower, but with a double set of Standard frames the case is different. With the advent of the honey-flow the upper storey, so useful for wintering, is quite unnecessary, and its place can be taken by surplus chambers.—J. M. E., *Ussie Valley, N.B.*

### BEE-KEEPING IN GERMANY.

(Continued from page 16.)

[5087.] The hive in most extensive use is the "Berlepsch," or "Dathe," which has three stories, and is operated on from the rear on the "breechloader" system. Of the various sizes of frames, the German normal frame is 8.78 in. (223 mm.)\* The wood for this frame is 0.197 in. to 0.236 in. (5 to 6 mm.) thick and 0.945 in. to 0.984 in. (24 to 25 mm.) broad, and 7.28 in. (185 mm.) high, and is, with the exception of the Badish frame, 9.45 in. (240 mm.) broad and 8.27 in. (210 mm.) high, almost exclusively in use with this form of hive, especially in Southern Germany. There is a great deal of adverse criticism about this frame because of its small size, but if there are about six double frames, *i.e.*, 8.78 in. by 14.57 in. (223 by 370 mm.), in the middle of the brood-nest, this small frame does very well for certain parts of Germany. It is doubtful whether, with a very large frame, equally good results could be obtained where the main honey-flow begins with the dandelion (*Taraxacum officinalis*) and ceases when the

hay is cut some six or seven weeks later, because during this time there is often much adverse weather and low temperature to be contended with. With ordinary care and a fair season, it is possible that, with very large frames, one might have a more populous colony and some honey in the brood-nest, but probably no surplus. Still, it is not the form of hive nor the size of frame that are of paramount importance, but the good qualities of the queen and the judicious management that ensures the best results at a given place. The hive under consideration is double-walled in front, with entrance at the bottom, and sometimes an additional one in the third storey. The two sides may be single or double walled, with three grooves on each side 0.231 in. (6 mm.) deep, 0.462 in. (12 mm.) wide, and often lined with tinplate or zinc, the first and third groove with a piece bent once at right angles (A), while for the second



groove a similar piece is bent twice at right angles, the lower 0.231 in. (6 mm.), the upper bend 0.394 to 0.462 in. (10 to 12 mm.), thus (B). In latter case the upper bend pro-

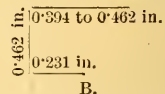

jects 0.157 to 0.231 in. (4 to 6 mm.), and this projection serves to lay a queen excluder upon if desired, and when the third, or surplus, storey is not in use small boards about 0.279 in. (7 mm.) thick, 2.786 in. (70 mm.) broad, and 9.17 in. (233 mm.) long are convenient to cover the brood chamber, and leave 0.231 in. (6 mm.) above the frames for the bees to pass through. One of these small boards is 4.62 to 5.51 in. (120 to 140 mm.) broad, and has a hole about 2.36 to 2.75 in. (60 to 70 mm.) in diameter, covered with wire netting eight meshes to the inch; this forms the feed hole. The frames are closed up with a window or a suitable frame covered with wire netting, one for the two lower storeys and another one for the third. The hive is closed by a door.

In Germany extracted honey being almost exclusively worked for, the brood-chamber is separated from the surplus-chambers by a queen-excluder, but sometimes wooden excluders are used. Some hives have only a low, dark entrance to surplus-chambers which the queen does not enter. Many bee-keepers use no queen-excluding device whatever, and with a good long honey-flow or a non-swarming race of bees this plan does very well, but where the honey-flow is lacking bees get the swarm-fever and the best results are then got by using queen-excluders. To operate on this hive special tongs—and a box in which the frames are hung as removed from the hive,

\* 1 in. = 25.4 millimeter = mm.

are needed. A thorough overhaul or a search for the queen is considerably more difficult and requires more time than in hives operated from above. The results to be obtained are, however, as good as from any other form of hive. In early districts an abundance of nectar is obtainable in the spring and none in summer and autumn, therefore the progressive apiarist will encourage brood-rearing by feeding during the season of scarcity, so that he may have some young bees to carry through in the winter, and early in the fall he will take care that his bees are provided with plenty of food to last till spring. He will also remove all superfluous combs after contracting the hives to as many frames as the bees cover. The little board with the

also a hole in it, the size of which can be regulated. Other bee keepers leave the entrance wide open, but prevent through-draught. Where the sides of the hive are single-walled, they are put some 3 in. to 4 in. apart, and the space carefully filled with some non-conducting material covered with tight-fitting boards to keep all in place and look neat. Nothing is disturbed about the hives, and they remain so protected permanently. If the food is wholesome and the queens young, the winter loss may be as small as 1 or 2 per cent.

In a country where the conditions above referred to prevail the apiculturist must give the utmost care to his bees in spring. After the general inspection, when natural pollen is coming in, brood-rearing begins in earnest.



GERMAN HOUSE-APIARIES FOR "BREECHLOADER" HIVES.

feed-hole is put over the third or fourth frame. A very small cushion is first placed on the boards which cover the brood-chamber, then a larger cushion covers all. Two cushions are used in spring when giving food or water, and other means taken to keep the brood-nest warm, and to prevent the radiation of heat. The cushions contain moss or some other non-conducting material. Close-fitting straw mats, with feed-hole in centre, are also used. A cushion or straw mat is also used to cover the window or the wire-screen, as the case may be. Some bee-keepers close the hive entrance entirely, and ventilate through the feed-hole by means of a tin cylinder made high enough to project over the cushion. The hive door has

Now the main object is to assist the bees in keeping up the high temperature needed by removing superfluous frames, and not to enlarge the brood-nest until the bees are seen at the window, and then only by adding one double—or two small frames, and taking care that radiation is reduced to a minimum. Stores must be watched carefully, without waiting till the bees are in actual need. The best way to supply this is to uncap a frame of honey and give it to the bees; if this cannot be done, then a little warm honey is next best. To keep the bees warm and supplied with ample food is not enough. When rearing much brood much water is needed; the bees do not store water, and will go in search

of it, even in bad weather, when a great many will be lost. They will also go out for pollen and nectar when the temperature is too low. It is quite as easy to supply water as liquid honey. The bees will also take comparatively large quantities, and experiments have proved that colonies supplied freely with water were decidedly more populous at a given time than others not so supplied. Thousands of young bees no doubt get lost during spring through untimely flight. Supplying water, it is asserted, has diminished this loss somewhat. Still, it is claimed by writers in numerous periodicals that the bees in spring [whether they are only young bees has, as far as I am informed, not been ascertained] are too impulsive, too rash, too eager to gather the treasures of Nature. That, owing to their deficiency in meteorological instinct, they rush out to become chilled, and so defeat their own purpose; and, what is even more to be regretted, the object of their master. To counteract the effect of this deficiency, the twentieth-century apiarist has devised means to keep them in their well-provisioned home, when the thermometer is below 50 deg. Fahr. in the shade. Bees, like most winged insects, do not like to be confined, even if it is for their own good—and many apiarists testify of their own accord that it is by far the best thing for them, to be confined to their home in cold windy weather; while we all know that bees have sense enough to stay at home, or go home when it rains. The problem was to confine them so that they would not know it, and, consequently, not suffer from their loss of liberty. Logic and ingenuity have solved the problem. Since the bees lack judgment as to the time when they ought to stay at home for their own good, it is clear they have no judgment as to duration of time, as this would require a higher order of intelligence than the former. We know they stay willingly at home at night.

In view, therefore, of the above facts, we may, by shutting out all light, cause the bees to presume it is still night, and be quiet, if they have all the necessaries of life. Ingenuity has constructed a portico or addition to the entrance (the entrance must remain open) that can be made to exclude light, but receives air through a double bottom, and is ventilated above. So far, only praise has been heard of this arrangement to confine the bees. Undoubtedly, there are times when it is advantageous to keep the bees confined especially very early in spring; in fact, I think light, especially the sun, should not be allowed to fall on the entrance, during winter. There are some localities where there might be a greater need to confine the bees in spring, for instance, where every year, at a time when the dandelion is in full bloom, snow falls. The idea, I believe, is good, but like other good things, might be overdone. In the coming season we shall hear much about it; until now nothing adverse has been heard except where

the construction had been faulty. If light enters the bees will not remain quiet, and more harm than good will result from such confinement.—J. A. HEBERLY, *Weisweil, by Erzingen, Baden, Germany, March, 1903.*

[The writer of the above interesting details is the owner of over a hundred colonies of Carniolan bees kept for queen-rearing and honey production. The illustration on p. 155 is from a photo of an ordinary house-apiairy such as is used in Germany for hives worked from the rear, or—to use the expressive German term—“brechloaders,” as distinguishing them from other hives manipulated from above or in front. Mr. Heberly, who makes a speciality of queen-rearing, has stocks containing a large population of selected drones located some distance away from any other bees, and removes his choicest virgin queens to these special drone-colonies for mating purposes, thus securing the best qualities of selected queens and drones.—Eds.]

#### HOME-MADE HIVES.

[5088.] I notice in your issue of April 2 (page 137) a correspondent signing himself “W. D., Aldershot,” tells us that he was amused with the idea of making a hive with boards  $\frac{1}{8}$  in. thick. I would like to ask what there is to be amused at? I am a bee-keeper of many years’ standing, but have not seen hives from all the makers. Like “W. D.,” I am a joiner, and make some of my hives; not all, for the simple reason that I have not time. I buy a 3-in. “deal” and have four cuts put down, this gives me a board a good  $\frac{1}{2}$  in. thick when finished, which I find plenty thick enough. Now I have hives in my apiary from three different makers and I find there is scarcely a board in them that is more than a trifle over  $\frac{1}{2}$  in. thick. I have used these hives for many years, and have never had a colony of bees perish through cold; in fact, I have found the bees winter just as well in them as in hives with boards much thicker. No, Mr. “W. D.,” the secret of wintering bees successfully does not depend upon the thickness of board used in constructing the hive, but in having a good vigorous strain of bees, good strong stocks, left with plenty of food when packing up for winter, and a well-ventilated, yet waterproof, hive. Under these conditions you need not have any fear about your bees not coming out all right, providing they are headed with a good queen and free from disease. When “W. D.” asks “How are the hives to be nailed together with only  $\frac{3}{8}$ -in. board without splitting the wood?” surely he cannot be in earnest, if a joiner? If he is, I should like him to go with me, in a few weeks’ time, to one of the largest hive-makers in England, and he will there see lads about sixteen or seventeen years old nailing hives up, and without any splitting of the wood. I have no “tongued and grooved” angles, nor glue; I have a clean “butt joint,” well painted;



and give the hives a coat of paint nearly every year. I also take care that they are water-tight. Nor do I ever have any mishap through using thin boards; not only so, but I look after a gentleman's bees near, whose hives are from one of the leading hive-makers, and the boards used in them are even thinner than mine.

In concluding, let me add a line to say I know of two houses near by where bees have been in the roof for many years, and have prospered, for they are strong in both cases—one under slate roof.—WM. BRIGGS, *Dorking*.

### AMERICAN LADY BEE-KEEPERS.

#### A BEE-MAN'S HELPFUL FAMILY.

Writing to Miss Emma M. Wilson, who has charge of the lady bee-keepers' column in the *American Bee Journal*, Mrs. W. H. Laws, Bee Co., Texas, says:—

I always enjoy the writings of "Our Bee-keeping Sisters," and since this department has been started, the *American Bee Journal* has become doubly interesting. I have often wondered how much interest was really taken by the bee-keepers' wives in their husband's business.

I regret to note that those sisters who write seem to be "padding their own canoe," and there is no husband connected with the business. Now, please record that here is one sister who is trying to be a "helpmeet" to her husband, especially in the busy season of the year. For eight months our four children are in school, therefore at that season we do not have much time for bee-work, neither is there a necessity for a great rush in the bee-yards. Yet, on Saturdays we make and wire frames, paint hives, put together nucleus shipping boxes, etc., and always manage to find something we can do profitably that might have to go undone later.

I must say it is a pleasure to spread the paint on nice, clean, new hives, and I have painted a hundred in one day, and manage, by the help of the girls, to keep up our house-work, too. With 500 colonies of bees in seven yards, from four to twenty miles out there is hustling when the honey-flow begins until ready to be taken from the hives.

In this delightful climate camp-life among the hills is delightful, with a wagon loaded with extracting and camping outfit, plenty of "grub," tents, bedding, etc., the wagon going ahead, we follow in the carriage. Best of all we have a negro cook who tends the team, helps about the heavy lifting, and does the odd jobs, and is much appreciated.

We usually reach the bee-yard next to be worked in the afternoon. Tents erected, supper prepared and over, we spread our beds for the night, and early next morning are ready for business. My husband and our eldest son, Huber, aged sixteen, will remove the honey from the hives and bring it to the

extracting tent, while myself and Alice (fourteen) and Kate (twelve) will extract the honey and cut out the nice, white combs, and pack in screw-cap cans ready for the market. Some of you Northern section-honey-producing sisters may laugh at this bulk-comb-honey product, but, believe me, we cannot nearly supply the demand, and it nets us nearly as much per lb. as section honey. Then we have the advantage of filling in around the comb with extracted honey.

Are we afraid of stings? Yes, some; and stray bees brought into the extracting tent sometimes annoy by crawling around too familiarly.

Our girls insist that it is more cleanly and comfortable to wear boys' overalls while working in the extracting house, hence they have their papa to buy them large, roomy overalls, which are drawn on over their clothing. Of course, visitors are not expected.

We have never kept a record of a whole day's work, but I think myself and two girls can extract, cut out, and pack a ton of this bulk-comb honey in one day, with sufficient help to do the lifting.

I, for one, would like to hear from the wives of bee-keepers.

Bee Co., Texas.

MRS. W. H. LAWS.

Miss Wilson adds the following footnote:—

[Mrs. Laws' letter will be read with interest by all our bee-keeping sisters, wives included. She is right—we ought to hear more from the wives. I am sure we would be glad to.

How pleasant it must be to have all the family interested, and have some part in the work. I know something about how nice it is, for at one time our whole family worked with the bees.

Your visits, Mrs. Laws, to the out-apiaries must be delightful—reads like a pleasant summer excursion. You enjoy all the pleasures of camp life (negro cook included), with the profits thrown in.

Tell those girls for me that I think they are very sensible in their choice of dress.]

## Queries and Replies.

[3062.] *Replacing Misbuilt Combs.*—I should be glad of a little advice in your next issue on the following questions:—1. I have three strong stocks of bees, and one rather weak. Could I arrange to give a frame of brood from one of the strong stocks to the weak lot? I have examined all the four hives, and I find brood in all of them, mostly sealed over. 2. I have to-day examined one of the above-named hives, and find it has some very crooked combs, so I have removed three of the most misshapen combs, and replaced them by a store-comb half full of honey from a spare hive, and two frames fitted

with full sheets of foundation. 3. Have I done right in inserting frames of foundation at this season? I am located in a heather district, and we have also a lot of hawthorn and cherry trees about, but these are not in blossom yet. I am, therefore, feeding with syrup until honey is to be had outside, and hoping we shall have a better season all round than last year.—A. H., *Durnford Edge, April 10.*

REPLY.—1. You can of course follow the plan proposed, but as a question of policy we do not advise it without careful consideration. It is seldom wise to build up weak colonies in spring at the expense of strong ones, because the main object is to concentrate our efforts on getting the stocks upon which we rely for profit as strong as possible for the first honey-flow. To have them "boiling over"—as the saying is—with bees; and to rob such colonies of their brood in order to patch up weak lots is not good bee-keeping, especially if the cause of "weakness" in the stocks you propose to strengthen arises either from foul brood or a failing queen. 2. We would only give one frame of foundation at a time, and see that it goes between two *straight combs*. Once you get straight combs started the full sheets may be put between them as often as the strength of the bees warrants it. 3. It is not too early if bees are strong in numbers as stated.

[3063.] *Getting Bees out of Honey-Extracting House.*—I beg leave to trouble you on a small, but rather important, point, with regard to an extracting-shed I have erected. That is to say, can you give me some way of ensuring the quick exit of stray bees, which will, no doubt, accidentally get in? There are two windows in the shed (made to open). Would it answer to have the top panes  $\frac{1}{2}$  in. off top, with some perforated zinc nailed on outside, allowing a bee-space between?—B. X. L., *Wheaton Aston, Staffs.*

REPLY.—The best and simplest plan we know of is to have the windows fixed on central pivot-pins top and bottom, so that as often as a few bees gather on the glass inside, they can instantly be put outside by a half turn of the window, with almost no trouble at all. The odour of honey in an extracting house is so attractive to bees—especially when the "robbing" season is on—that we do not like to keep bees out by perforated zinc only. The odour invites them to openings, and helps to demoralise them, even though it prevents ingress to the house.

[3064.] *Spreading Brood-combs and Feeding in Spring.*—I would be greatly obliged for your valuable help on the following points:—1. Should sheets of foundation be inserted just now in middle or at side of brood nest? 2. How much liquid-food should be given per diem at this season to each stock? Is it a mistake to give a week's supply at one time, and if so, why? 3. I made candy as per "Guide Book" recipe, and placed some

over frames in autumn. Can I safely reduce what remains and give now in shape of syrup? 4. In uncapping sealed stores to stimulate feeding, the uncappings should, I suppose, be consigned to the wax extractor. Is this so? 5. Are swarm catchers of much practical value?—NOVICE, *Aberdeenshire.*

REPLY.—1. If the object is to spread the brood in order to stimulate breeding the frame of foundation must be inserted in centre of brood-nest. Do not, however, lose sight of the fact that injudicious brood-spreading in spring has led to untold mischief to stocks. Well done, it is a helpful operation; but, badly done, "chilled brood" and worse is the result. To avoid this, start by giving one frame of foundation only, and do not begin at all unless there are four or five seams of bees. If the weather keeps warm, a second frame may be given—in centre, as before—in about a week, if the first one is drawn out and occupied with brood; but not otherwise. Then, as warmth increases and bees become more numerous, add a frame at intervals till the full complement is reached. 2. If stores are short, a pint of syrup per week may be required, but if for stimulating only, less than half that quantity will suffice. 3. Yes. 4. Do not remove cappings at all when stimulating by use of sealed food already in the hive; merely bruise or scratch the surface of cappings so as to expose the food. Leave the bees to do the rest. 5. Yes; if efficient, a swarm-catcher is a valuable bee-appliance.

[3065.] *Allowing Bees to Transfer Themselves.*—Last spring I put two stocks of bees in skeps on the top of two bar-frame hives fitted with wired foundation. Owing to the poor season of 1902 I did not venture to remove the skeps away, and they are on still, and bees working strongly; I may say they did not swarm. I want to work this year for section honey. What should I do? 1. Should I lift skeps off and put a super-clearer on top of frames and put skeps on top of this? Is there any fear of queen's being in skeps yet? 2. When would be best time? 3. Should I use the bee-smoker?—NOVICE, *Devon.*

REPLY.—Your want of forethought in not removing the skeps last autumn may greatly tend to hamper progress this season should the brood-nest be now established in the skeps. 1. The first thing, then, will be to lift off the skeps and make this point clear, and if the queens are breeding well below in frame-hives you might put on queen-excluder (not a super-clearer on any account) between skep and frame-hive to keep queen below, as proposed. 2. Do not remove skeps until natural food is plentiful; the bees had better use up as much of the food in skeps as they require until you need to put on sections. 3. No doubt the smoker will be needed, judging from your *nom de plume*.

[3066.] *Bees Not Sealing Brood.*—Last year I had a strange experience in my apiary, which

puzzled me a good deal at the time, and as I had never seen anything like it before I would like to know if you can explain it. I made an artificial swarm from one of my hives, putting the bees into a new hive with "starters" of foundation in the frames. I fed them with syrup medicated with *Naphthol beta*, and also put naphthaline in the hive. The swarm got on all right, but about a fortnight later I found the bees were not sealing the brood over when the larvæ reached the proper condition for capping over the cells. The brood was all compact, and looked plump, white, and healthy; but as the capping was never done the larvæ did not hatch out, though some had reached the proper stage. Can you tell me what could be the cause of this?—D. T. R., *Straidarron, April 2.*

REPLY.—It is not usual, or even advisable, to give medicated food to swarms when first hived. Nor is there any need for using preventives against disease, such as naphthaline. The latter has a strong odour, and if too large a dose be given—or if the naphthaline used is not of the suitable kind—the bees sometimes refuse to completely seal the brood-cells over; consequently the larvæ perish. This is, no doubt, what has caused your trouble.

[3067.] *Sending Queens to the U.S.A.*—Will you kindly let me know the best time to send queens to U.S.A.? Would May or June be the right time, and could I procure small boxes made to contain a queen with a few hundred bees? If suitable boxes are made in England to preserve queens alive for sixteen days I would be glad to know where I could procure them. I have never sent queens by post and should much like those I am thinking of sending to arrive safely at their journey's end. What supply of food will be needed? Or should the queen and her attendant bees be sent on a piece of comb with food in it to last sixteen days? A reply in next BEE JOURNAL will greatly oblige a perplexed BRITISH BEE JOURNAL reader.—NEMO, *Trieste, April 2.*

REPLY.—May is a good month for sending, if weather is normal, but June is, of course, more safe. The plan of sending queens in boxes on miniature frames of comb—as was common a dozen or more years ago—is rarely followed now. You could, no doubt, get a pattern queen-travelling cage or box by writing to one of our advertisers who import queens, say, Mr. Sladen, Ripple Court Apiary, near Dover. As regards food, syrup or honey is not used now, specially prepared soft candy being found to answer better.

#### MAKING AN OBSERVATORY HIVE.

These hives are usually constructed to swing round on a pivot in the centre of bottom of hive, and stand so that either side can be turned to the spectator without moving the stand. We will first describe the stand

This must be made hollow for just over half its length. It can be best managed by cutting out a slot from the inside and affixing a thin piece of wood over the slot. One-inch stuff must be used, the slot being  $\frac{5}{8}$  in. deep. It is through this slot that the bees obtain access to the hive, thus answering the purpose of an entrance. Exactly in the centre of the stand a  $1\frac{1}{2}$ -in. centre-bit hole is made and a piece of strong brass tube inserted, fitting into this hole perfectly tight, and further secured by means of screws. The tube must be flush with the top surface of the stand, and also flush with the under-side in the slot mentioned before. The stand must be at least 6 in. broad and extended to 9 in. in the centre. You thus have a stand with a tunnel running from one end, and having communication at its end through the brass tube at surface in centre. The bottom or thin piece of wood must not be fixed over the under-side of the slot until the hive is finished. The bottom board of the hive is made from 1-in. stuff, cut to the following dimensions, 34 in. by  $2\frac{1}{2}$  in., this receiving the two sides and middle partition, which must be mortised into it for strength. Exactly in the centre of this bottom board a centre-bit hole must be bored to correspond with the hole in the centre of the stand. Into this a piece of brass tube is fixed of the exact size of the inside of the pieces of tube fixed in stand, flush with the upper surface of the floor-board, but long enough to come just below the bottom edge of the tube in the stand when floor-board is in position on stand. Into the bottom edge of this tube two holes are drilled, into which a piece of wire is fixed to act as stops, thus preventing the withdrawal of the tube fixed in floor-board when hive is in position. This is the hinge or pivot which allows the hive to be turned in any position without any danger of stopping up the entrance. The sides and middle partition are made of four cut stuff, and without the tenons at end must measure  $17\frac{1}{2}$  in. by  $2\frac{1}{2}$  in. The piece used for the centre division must have a small archway cut in the tenoned end just where it partially covers the entrance in floor-board, and on each side two grooves are cut along its entire length at a distance of  $1\frac{1}{8}$  in. from each other, measuring from their inside edges. The two ends must have corresponding grooves cut, but only on one side of each. These grooves are for the purpose of accommodating the glass slides. The bottom board must also have grooves cut to accommodate the bottom edges of the glass sides. Eight pieces of wood, measuring  $8\frac{1}{2}$  in.  $\times$   $1\frac{1}{2}$  in.  $\times$   $\frac{1}{4}$  in., must now be cut out and fixed equidistant from each other between each pair of grooves in sides and centre partition. These are for the lugs—which must be shortened—of the frames to rest upon, and form the inside surface of ends of hive. The tops of each of ends and centre partition must be braced together by

means of narrow mouldings tenoned into each. The cover is made in the same manner as the unicomb hive, but should have a ventilator, to be used as occasion requires, in the centre. It is also advisable to make one in each end at top, as often a colony in an observatory hive is obliged to be disturbed, and so excited, when the rise in the temperature consequent on same would be very detrimental to the colony. The glass sides are each formed of two sheets of glass. The frames are placed in position by withdrawing the glass from one side. Ornamentation can be left to the maker's taste, but should always be very plain. This hive must be made of hard wood, as soft wood would not stand the strain at the tenons.

Many of these hives are made with double glass sides, which are an improvement. Others are provided with shutters to keep out the light when not required for observation. All observatory hives must have an outside cover well lined with thick felt.

It is quite possible for an amateur to construct an observatory hive. We saw one at Felton in Northumberland, made by an ex-sailor, which answered admirably out-of-doors during the summer months. The bees must be removed into an ordinary frame-hive during early spring, late autumn, and winter. None but straight combs can be used. It is advisable that these should be prepared specially between separators.

[The above is reprinted from a former issue, in response to recent requests for reliable details on the subject of making an Observatory Hive.—EDS.]

## Bee Shows to Come.

*A nominal charge of 2s. 6d. is made for notices in this column, which covers cost of insertion from order till date of show. Cash should accompany orders for insertion.*

June 23 to 27, at London.—"Royal" Agricultural Society's Show. Bee and Honey Section under the management of the B.B.K.A. Increased prizes for B.K.A. Associations as arranged in divisions or groups of counties. Schedules from Edwin H. Young, Secretary, 12, Hanover-square, W. Entries close May 1, or at extra fees up to May 15.

July 22 and 23, at Cardiff.—Honey show of the Glamorgan B.K.A., in connection with the Cardiff and County Horticultural Society. Bees, hives, honey, trophies, wax, appliances, and articles of food. Substantial money prizes and medals. Free entries. Six open classes. Schedules from William Richards, Gabafla, Cardiff. Entries close July 16.

July 30, 31, and August 1 and 3, at Old Trafford, Manchester.—Annual Show of the Royal Lancashire Agricultural Society. Liberal money-prizes are offered for honey along with silver and bronze medals of the B.B.K.A. and also of the Society. Open classes for Honey-Trophy, Sections, Extracted Honey, Beeswax, Instructive Exhibits in Bee-Culture, &c. Schedules, when ready, from Edward Bohane, Secretary, Miller-arcade, Preston.

August 4, at Leamington.—Tenth annual show of the Leamington St. Mary's Horticultural Society. Three open classes for Six 1-lb. Sections, Six 1-lb. Jars "Light," and Six 1-lb. Jars "Dark" Extracted Honey, respectively. Liberal money prizes. Schedules from E. W. Smith, Secretary, 22, Leam-street, Leamington. Entries close July 30.

August 6, at Nantwich.—Honey department of the Cheshire Agricultural Society's Show under the management of the C.B.K.A. Numerous classes for hives, honey, and wax. Money prizes and medals. Schedules from T. A. Beckett, St. Werburgh's Chambers, Chester.

August 12, at Radstock, Bath.—Honey show in connection with the annual show of the Radstock and District Horticultural and Fanciers' Association. Schedules from the Secretary, B. M. Clark, 1, Fox Hills, Radstock, Bath.

August 27, at Llangollen.—In connection with the fifth annual Flower Show. Open classes for Six 1-lb. Sections, Six 1-lb. Bottles Extracted Honey, and Beeswax. Schedules from Frank Little, Castle-street, Llangollen. Entries close August 13.

## Notices to Correspondents & Inquirers.

*All queries forwarded will be attended to, and those only of personal interest will be answered in this column.*

\*.\* Mr. W. Herrod, the well-known apiarist and B.B.K.A. expert, asks us to insert the following note:—"Can some bee-keeping reader inform me of a place for sale as near following description as possible. Eight-roomed house (or thereabouts), out of repair not objected to; about five acres of ground in good bee-district, about one hour from London and two miles distant from station. Or piece of ground suitable for building on, containing either orchard or spinney. Any help will be greatly esteemed." Address:—The Horticultural College, Swanley, Kent.

CANDY (Norwich).—*Clearing Bees from Tiled Roof.*—We fear you would not succeed in "driving" the bees from roof into a skep; indeed, as a task for a beginner (a lady also) the course we advised is more likely to succeed than the plan you now propose.

SISS (Cranbrook).—*Queries and Replies.*—Not being able to understand the contents of your post-card dated 7th inst., we will be glad of a further line in explanation (in an envelope, please), along with name and address for reference, as per rule. With regard to books on "fruit growing, budding, grafting," &c., you should write to a gardening paper, such matters being beyond our scope.

EIDLOG (Mansfield, Notts).—*Feeding Bees in April.*—Syrup-food will be preferable to candy from mid-April forward.

R. J. ROBB (Hert Bank).—We will give full reply to your query next week.

### *Suspected Combs.*

J. W. M. (Bangor).—Comb contains nothing worse than pollen; the white appearance seen in a few cells is mildew on the surface of the pollen.

G. H. P. (Notts).—Comb is affected with foul brood. In view of your fourteen healthy stocks, we should remove risk by destroying the weak lot outright by burning.

I. D. B. I. (Ireland).—An exceptionally bad case of foul brood, such as demands total destruction of hive and contents.

\*.\* *Some Letters and Queries are unavoidably held over till next week.*

## Editorial, Notices, &c.

### THE "ROYAL" SHOW OF 1903.

The close proximity of the date for closing entries must be our excuse for reminding intending exhibitors that they should within the next six days apply for and return their entry forms, otherwise it will be too late to make an entry, save by payment of extra fees. In view of the urgency of the case we again, and for the last time, insert the full schedule of prizes, with necessary particulars, on page iii, so that readers may obtain the needful information without delay. Had the present month been one of even normal mildness bee-keepers would not have required stirring up to arouse their interest in the bees, but with night frosts registering as many as 7 deg. to 10 deg. below freezing point occurring as late as April 17, and cold winds that have for some time past effectually stopped all activity in bee-life and work, it need not occasion any surprise if thoughts of shows and showing are just now absent from minds which under more genial conditions would be found full of latent enthusiasm for the craft. On the other hand, we must not forget that if bee-keepers feel justly disappointed at the untoward weather conditions fruit growers are immeasurably more unfortunate. We read a few days ago of acres of fruit orchards devastated in Kent alone, in places where the prospects of a good crop had been exceptionally promising. This means to some a whole year's failure in this branch of agriculture, and should arouse real sympathy for fruit-growers, but so far as it affects bee-keepers, it is an established fact that some of the most productive honey seasons on record have followed on times of complete failure in the earlier part of the same season.

We have, therefore, no reason whatever for taking a gloomy view of the prospect before us, but the point we here desire to give prominence to is the changed conditions with regard to honey-exhibiting at the coming "Royal" Show. These conditions entirely do away with the former just complaint of bee-keepers—especially those in the north and midlands, that the early date on which the "Royal" is now held reduced the chance of staging an exhibit of the current year's honey to a minimum. This complaint was so well founded that it had to be met by authorising the return of entry fees when adverse weather delayed honey-gathering. Now, however, the necessity for honey of the current year is a thing of the past. In every class for both comb and extracted honey the produce of "any year" is available. This should in a great degree, tend to counterbalance the effect of failure in the early crop of the present year. Our fear is that this important fact may be overlooked or lost sight of, and we trust this reminder may have the effect of causing

readers to look over their stock of honey "of any year" and make an entry while there is time. No need now exists for dwelling on the lessened chances of honey of the current year on the show-bench, and as the short crop of 1902 will be nearly sold out, the keenness of the competition should be materially reduced and the chance of winning proportionately increased.

We may also—with advantage, let us hope—refer to the "Royal Show" Fund, the first list of donations to which appeared in our issue of March 26 (page 122). The object of this fund is, primarily, to meet the increased outlay caused by an extended prize list, but beyond this it is very desirable that bee-keepers should assist in providing a permanent building for the bee and honey section of the show, and it will be disappointing to a degree if members of the affiliated county associations fail in rising to the occasion, or shirk their proper share of the responsibility involved. It is a great mistake to suppose—as some do—that the parent association possesses any available funds for the last-named purpose, and it is manifestly unfair to leave so large a share of the necessary financial help to the few whose names figure so regularly as donors. There is less need, so to speak, for guineas than for shillings or half-crowns, and the bee-keeper who scruples to contribute his mite for what is obviously for the good of the whole craft, lacks one attribute of the genuine bee-man, from cottager onward. We shall, therefore, be genuinely disappointed if we are not privileged to publish an early and substantial addition to the "Royal Show Fund" in the shape of small contributions of 1s. upwards.

### BRITISH BEE-KEEPERS' ASSOCIATION

The monthly meeting of the Council was held at 105, Jermyn-street, S.W., on Wednesday, April 15, Mr. T. I. Weston occupying the chair. There were also present Dr. Elliot, Messrs. W. Broughton Carr, W. H. Harris, W. F. Reid, E. D. Till, and the secretary. Letters regretting inability to attend were received from Rev. W. E. Burkitt, Messrs. D. W. Bishop-Ackerman, R. T. Andrews, E. Walker, and C. N. White.

The minutes of the previous meeting were read and confirmed.

Mr. H. A. R. Burrough, Eanswythe, Thornton Heath, was duly elected to membership of the association.

The Report of the Finance Committee, together with the list of payments recommended—as presented by Mr. Till—was approved.

A number of nominations of judges at county shows were received and dealt with, and the necessary arrangements made for the forthcoming first-class examination on May 20, for which a good number of names of candidates have already been sent in.

A sub-committee, consisting of the Vice-

Chairman, Mr. W. H. Harris, and Mr. W. F. Reid, was appointed to draft the proposed letter to the County Council Technical Instruction Committees *re* Educational and Expert work of the British Bee-keepers' Association.

The next meeting of the Council will be held on Wednesday, May 20.

The following communication has been received from the secretary :—

Please permit me to acknowledge in the columns of the BEE JOURNAL the receipt of several additional contributions to the "Royal Show" Fund, which now stands as under :—

	£	s.	d.
Already acknowledged.....	16	15	0
S. Atkin.....	10	6	
W. L. Crowley.....	5	0	
E. Walker.....	5	0	
W. Herrod.....	5	0	
Total .....	18	0	6

As the amount guaranteed by the Association is this year about £30 more than the sum usually offered in the hive and honey department, it will be seen that further donations are necessary to make up the sum required.

I shall be happy to forward copies of the prize schedule and entry forms to applicants, and trust bee-keepers in every county will rally to the support of the exhibition by a generous entry. Members of affiliated associations may, if preferred, obtain schedules on application to their county secretaries.

EDWIN H. YOUNG, Secretary,

12, Hanover-square, London, W.

April 20.

## GREATER CORK INTERNATIONAL EXHIBITION, 1903.

In connection with the above Exhibition, which will be held in the picturesque grounds adjoining the river Lee, from June to November of the present year, a special section has been arranged to be devoted to the exhibition of bee-appliances, honey, and all matters pertaining to the bee-keeping industry. A detached, well-lighted building has been set apart for the effective display of hives and other appliances, and all arrangements in connection with it have been placed in the hands of a committee of practical bee-keepers, entirely unconnected with any firm manufacturing or trading in bee-appliances or products. The committee are prepared to arrange for exhibits from manufacturers from all quarters, and, where desired, to undertake the placing of these to the best advantage; or exhibitors may, subject to the approval of the committee, arrange their own exhibits in the space allotted to them. A thoroughly qualified attendant will be placed in charge, and where, as is

desirable in all cases, prices are fixed for the various articles the committee will undertake the sale of these, to be delivered at the close of the exhibition, or to transmit orders for duplicates, as may be arranged. To cover the cost of supervision, &c., a moderate charge for space has been fixed. A Bee Tent will be erected in close proximity to the building apportioned to the bee-appliances, in which lectures and demonstrations by competent lecturers will be given. Plots illustrating the cultivation of the most suitable bee-plants will be arranged, and the whole will form an interesting and instructive illustration of all branches of the bee-keeping industry. The forthcoming exhibition will, therefore, afford a most favourable opportunity for bringing the various descriptions of hives and other appliances under the notice of all classes of bee-keepers. In connection with the exhibits in this section, a number of medals have already been promised, the awarding of which will form the subject of future consideration.

## CONGRESS OF BEE-KEEPERS

AT STRASBURG, JULY 20 AND 21, 1903.

A congress of bee-keepers will be held at Strasburg on the above-mentioned dates, at which lectures will be delivered on various subjects of interest to bee-keepers, such as :—

The most practical form of hive.

The better development of brood in spring in large, as compared with small, hives.

Larval food and female larvæ.

The fight against foul-brood.

The recognition of serum in honey.

The training of bee-keepers.

Protection for honey.

Mr. J. Dennler, Mutzig, Alsace, is President of Committee.

## BEEES UNDER GLASS.

EXPERIMENTS IN CORNWALL.

Our practical experience—along with that of many well-known bee-keepers—being altogether against confining bees under glass, we attach little more than a tentative value to the importance of the following experiments reported in a recent issue of the *Western Morning News*. The details given will, however, possess interest for readers, as showing that with a large house available and peach trees growing in four rows, each 300 ft. long, it may be possible and profitable to place a stock hive under glass and cut the bees entirely off from the outside. On the other hand, we still hold the view that to keep bees under glass and allow them to fly abroad in the open will inevitably cause a lamentable waste of bee-life and end in failure.—[EDS.] :—

"The success of a novel experiment conducted by Mr. Cardell Williams, bee-expert

and lecturer in bee-keeping under the Cornwall County Council, in conjunction with Mr. Madge, head gardener to Mr. Hain, M.P., St. Ives, on the relationship of bees to flowers, and which already has been reported in these columns, has attracted considerable attention among fruit-growers and gardeners in the West. The same experiment, with slight modifications, has been successfully carried out at Messrs. A. & F. Craze's Nursery Gardens, Polgrain, St. Erth. Mr. Cardell Williams and Mr. Wills, head gardener, were the promoters of the scheme. A hive was placed in a peach-house, 300 ft. long, with four rows of peaches, but there was no outlet to enable the bees to gain access to the outer world, as was the case at Mr. Hain's gardens. Water was placed in the house for the use of the bees, and gardeners frequently worked in the house without suffering any inconvenience from stings, &c. The bees worked as energetically as if out of doors, and not a bloom escaped. The abundance of fruit set this year is enormous at Polgrain Farm—in fact, it is the best crop yet obtained. In other years there had been an abundance of blossom, but many trees had no set fruit. This year Messrs. A. & F. Craze have not sanctioned the use of camel-hair brushes, pampas grass, and other antiquated methods to mix the pollen, the bees having been allowed to do the work solely. The same experiment is in operation in the strawberry, cucumber, and other houses, and has produced splendid results. The result of these experiments shows that the bee is the natural agent in setting fruit, and other unnatural methods should therefore be dispensed with. Messrs. Craze are of opinion that it pays to keep bees for the sake of the fruit alone. Other gardeners and fruit-growers of the West are adopting the same methods, greatly to their advantage."

#### REVIEWS.

*The Bee-keeper's Guide: or Manual of the Apiary.* By A. J. Cook. Published by G. W. York, Chicago, U.S.A. — We are pleased to see a new edition (the seventeenth) of this useful guide. Professor Cook is so well known as an authority on bee-keeping that many will welcome this addition to our apicultural literature, more particularly as the book has been thoroughly revised, enlarged, and much of it rewritten, while many illustrations have been added. Amongst these are several relating to the anatomy of the bee, taken, with Mr. Cowan's permission, from his text-book "The Honey Bee," so that the work in this respect, as well as in the literary part, is brought up to present knowledge of the science. Professor Cook considers that the progress in apiculture has been so great, and the views and methods of the best bee-keepers so changed, that he was warranted

in thoroughly revising this edition, to which he has added eighty pages and seventy-five illustrations. The first part treats of the natural history of the bee, and ends with a bibliography reprinted from the list of works in Cowan's "The Honey Bee," to which is added the names of twenty authors of books on practical bee-keeping. The second part consists of chapters on appliances, and practical manipulation in general. There is also an interesting chapter on honey-plants, profusely illustrated, and one on the evils which confront the bee-keeper, containing all the most recent investigations on foul brood and other diseases. Although Professor Cook's work treats only of American methods, there is much that our bee-keepers would find useful, and we commend the book to their attention.

*Forty Years among the Bees.* By Dr. C. C. Miller. Published by G. W. York, Chicago.—This is the title of a charming new book by a veteran bee-keeper, who has for many years been prominent amongst writers in the apicultural journals. The first few pages are devoted to the autobiography of Dr. Miller, and here we learn something about his early years, of his college life, and how he worked his way on a very small sum, equivalent to 1s. 5d. a week, how he further studied and practised medicine, regarding which, he says, it did not take him more than a year to find out that he had not a sufficient stock of health himself to care for that of others, especially as he was morbidly anxious lest some lack of judgment on his part should prove a serious matter with some under his care. He therefore gave up the medical profession and in 1861 took to his first bees. The author then gives his experience with bees, the difficulties he encountered, and how he overcame them. This is all done in such clear, simple language that it is easily followed and understood. There are no chapters, as in ordinary books; short paragraphs being substituted with such headings as "First Section-honey," "Mending Combs," "Putting on Separators," and others, the whole of which fill over 300 pages. Under every heading is found some useful idea or "dodge," and our author describes in plain language just what he does in his own apiary and how he does it. The value of the book is much enhanced by the numerous illustrations taken with kodak by the doctor himself. Although the book is not divided into chapters each dealing with one subject, reference to any portion of it is made easy by the copious index found at the end. The book is full of good things from cover to cover, and every bee-keeper will want to read it, for here we have the practical experience of a successful bee-keeper, who has also been a careful observer for forty years. We recommend bee-keepers to get this book and feel sure that they will be well repaid if they read it from beginning to end.

## Correspondence.

The Editors do not hold themselves responsible for the opinions expressed by correspondents. No notice will be taken of anonymous communications, and correspondents are requested to write on one side of the paper only and give their real names and addresses, not necessarily for publication, but as a guarantee of good faith. Illustrations should be drawn on separate pieces of paper. We do not undertake to return rejected communications.

Communications relating to the literary department, reports of Associations, Shows, Meetings, Echoes, Queries, Books for Review, &c., must be addressed only to "The Editors of the 'British Bee Journal,' 17, King William-street, Strand, London, W.C." All business communications relating to advertisements, &c., must be addressed to "THE MANAGER, 'British Bee Journal' Office, 17, King William-street, Strand, London, W.C."

\* \* \* In order to facilitate reference, Correspondents, when speaking of any letter or query previously inserted, will oblige by mentioning the number of the letter as well as the page on which it appears.

### THE "ROYAL" SHOW FOR 1903.

[5089.] Since you published the contribution of £16 15s. in B.B.J. of March 26 (page 122) from members of the B.B.K.A. Council towards the "Royal Show" fund of the coming show in June next, I have been expecting to see a supplemental list of donations from your readers, who are all, more or less, interested in so important a competition. Apart from what are termed "other expenses" connected with providing suitable provision for the Bee and Honey Section of the show, the year's schedule classifies competitors into districts, so that honey from one part of the kingdom will not be in unfair competition with honey from bee-pastures of totally different character, a long-needed reform.

The prizes are greatly increased in number by this new departure, hence the necessity for more prize-money than heretofore.

As the members of the B.B.K.A. Council have themselves contributed liberally, they can fairly ask British bee-keepers generally to help on the effort. Some may only be able to send little, while others can afford more, but the smallest sums will be acceptable.

If each bee-keeper who reads this letter of mine will kindly act on "the spur of the moment," we shall see a list next week which will amply answer our expectations.—E. D. TILL, *Eynsford, Kent, April 20.*

[While heartily seconding Mr. Till's request, we are pleased to see a second list this week, and will gladly receive contributions.—EDS.]

### HOME-MADE HIVES.

[5090.] I have read with much interest the correspondence in B.B.J., *re* home-made hives, and I think it is a pity that "Jim, Ipswich," did not take your advice in the first instance and learn something about the bees themselves before he started making houses for them. Instead of doing this he proceeds to tell the readers of the journal how to make cheap hives. The first point for argument to my mind is this:—Does your correspondent prac-

tically know anything about the bees' requirements? If not, how can he instruct readers of the journal how to make satisfactory hives for keeping them in? It is all very well to get a pattern hive, measure it, and then give details of sizes, &c., for making, but it is the man who is a practical bee-keeper who knows whether such hives meet the requirements of the case from the bee-keeper's point of view. I have at the present time a hive made of  $\frac{1}{2}$  in. material with double-walls all round; but it is made on the telescopic principle, so that when the honey-flow is over the "lift" is inverted and falls over the body-box, thus giving for winter three thicknesses of wood. I find this to answer very well for ordinary hives (not telescopic I mean). I use  $\frac{3}{4}$  in. stuff for outer-case. I may say that before starting bee-keeping I took in the B.B. JOURNAL for twelve months and studied the "Guide Book" at every opportunity, a thing which I should advise every beginner to do, as therein is found the standard internal sizes for hives and advice on all other subjects connected with bee-keeping. Apologising for trespassing on your valuable space.—HARRY CLARKE, *Allesby, April 17.*

### FEEDING WITH ARTIFICIAL POLLEN.

[5091.] In the current number of your monthly, the *Bee-keepers' Record*, there is a good suggestion that an old skep from which the combs have been removed should be used for the above purpose.

This feeder might, however, be improved if the empty combs were still *in situ*, as they form capital holders of the flour, which may be easily shaken into the cells; the latter also afford good foothold to the bees and thoroughly protect their contents from the weather.

Failing a skep, old combs may be filled with the flour, and the pieces stood upon edge in a box, preferably covered by a roof, which will also afford protection from the direct rays of the sun, our aim being a "feeder" and not a solar-extractor.

My own bees are at this date working vigorously in an arrangement of this kind, in spite of available field-pollens.—L. S. CRAWSHAW, *Ikley, April 20.*

(Correspondence continued on page 166.)

### HOMES OF THE HONEY BEE.

#### THE APIARIES OF OUR READERS.

It is always a source of pleasure to add another to the list of good bee-keepers who are by profession schoolmasters. They help on the industry in a way not available to any one else, especially when the pupils (both boys and girls in Mr. Sutherland's case) are induced to render practical help in the work of bee-management. This is technical instruction in its best form, and we hope school teachers will



take the hint, and add bee-keeping to their list of extra subjects. Writing of himself, our Scotch friend says :—

“ My home of the honey bees is situated some twelve miles from John o' Groats. The apiary consists of twenty frame-hives and three straw skeps. The county of Caithness can boast of several excellent and up-to-date apiaries, and, but for the disastrous year of 1902, all would be in a thriving condition and give satisfactory results. For example, let me say, I commenced the year 1901 with fourteen stock hives, and by swarming they increased to twenty-four, and gave me in addition about

as can be expected ; but then the heather continues to bloom on into September, so that when we read of some of your correspondents packing their bees for winter in August or the first week in September, we get a ‘ pull ’ on our southern friends at the back end of the year should the autumn be favourable.

“ As to personal ‘ notes,’ I am a schoolmaster, and the school children seem to derive no small amount of pleasure from, and take as much interest in, the bees as I do myself, especially during the swarming season. I took up bee-keeping as a hobby in 1896, beginning with a straw skep and Mr. Cowan's



MR. PETER SUTHERLAND'S APIARY, WATTEN, CAITHNESS, N.B.

700 lb. of section-honey—but 1901 was an exceptional year. Probably, taking one year with another, it would not be far off the mark to strike the average in our district at from 30 lb. to 40 lb. of surplus per hive. Caithness being an exceedingly poor county for honey-yielding trees and shrubs, we depend for our main honey harvest on white clover and heather, which grow in great abundance all over the county. ‘ With ‘ winter lingering long,’ it makes us feel quite envious to read in the B.B.J. of our southern brethren taking off racks of sections by the month of May. To secure our first lot of sections here by the first or second week in July is about as good

‘ Guide Book,’ and worked gradually into the general use of frame-hives. Not having kept a very accurate account of income and expenditure, I cannot say to what extent my hobby has paid, but to the fact that I have enjoyed unique pleasure and healthy and quiet recreation I can heartily testify. Then there is the satisfaction of giving a ‘ sweet morsel ’ to an ‘ occasional friend, besides what may be sold to meet cost of wood, foundations, sections, and incidental expenses. All the hives are made by myself in a workshop erected in a garden specially prepared for the bees. Not infrequently I enlist the willing services of the school-boys, whilst the girls—working

on the 'division of labour' principle—will fit me up a couple of hundred sections during a play-interval. All are quite enthusiastic over the bee-business, and when they grow up and have homes of their own I trust their experience may not be lost. I am also—along with other keepers of 'Homes of the Honey Bee'—in no small degree indebted to the assistance of my good wife for giving me the alarm at swarming-time, and for cleaning and grading sections at the end of the honey-season. When the heather-flow comes on, with the assistance of a neighbouring farmer and the use of his commodious spring-cart, we remove half a dozen of the strongest hives to a Highland 'sheiling' about five miles distant, where, in the very midst of acres of heather bloom, the little workers seem to drink in renewed vigour and activity. The heather harvest may extend till about September 12, after which date all hives are examined and made secure for safe wintering. Foul brood, I am happy to say, I have had no experience of. I try to keep my hives as clean and sweet as possible, transferring the bees and combs each spring all from the old hives into fresh ones, and keeping stocks as strong as possible by stimulative feeding. Yet the 'bee-pest' is not unknown in the county, and at least two of our most careful and experienced bee-keepers have been troubled with it. But at present, so far as I know, they have fairly well stamped it out.

"Before closing these few cursory notes I desire to express my indebtedness to the BRITISH BEE JOURNAL for the many valuable hints I have received from time to time. I have worked the JOURNAL on much the same system as I work my hives—and in due course have had most, if not all, of my difficulties solved by reading it."

### CORRESPONDENCE.

(Continued from page 164.)

#### HIVES AND FRAMES.

[5092.] I have been much interested in the late discussion in your columns on the question of frames, which has more recently wandered off in the direction of hive-construction, during the past few issues. As a practical cabinet-maker, well on in his seventeenth year as a bee-keeper, who, after trying numerous kinds of frames, and devices for dividing same, hit upon a plan which has always worked perfectly, I thought your readers might like to hear some particulars of same.

But, first, let me say I began bee-keeping in 1886, by purchasing two stocks of bees in frame-hives, along with all honey in them, just as they were returned from the heather, for £5, and, as I took from them 30 lb. of comb-honey each, I consider they were not dear at the price. The hives had been made by a country joiner, of 1½-in. red deal, dovetailed

together, with a shallow upper-storey of the same material. The frames, however, were not of standard size, being about 12 in. long by 11 in. deep in the brood-nest, while those in the super were 6 in. deep.

In the following summer no less than five swarms issued from the two hives, one being a virgin swarm, and I had to provide hives in a hurried fashion; two of which I bought of a joiner's apprentice, which he had made up in his spare time, and the frames of these were about 13 in. long by 10 in. deep.

I had already secured the Cottager's Handbook, "Modern Bee-keeping." With its help and several trade catalogues I set to work to make my own hives and appliances, and have continued to do so ever since.

As an old cabinet-maker, I have a great respect for yellow pine, and naturally kept to it at first as the most suitable material for both hives and frames, but, at the risk of being accused of heterodoxy by appliance-makers, I take leave to state that there are various woods to be had as *cheap*, while not only *superior* to yellow pine, but for an amateur hive-maker more ready to his hand. The material known in trade as "American Whitewood" (Canary Pine) can be bought in any thickness of boards up to 36-in. wide planed on both sides. It is not only as cheap, but is free from knots or shakes, and not only so, but when exposed to the weather it will last twice as long as yellow pine.

I adhere to the "W.B.C." design or type of hive with the usual distinct and separate outer-case to fit over the brood and surplus-chambers. Both outer-case and body-box are dovetailed at corners, the former being of board ¾ in. thick and the latter ½ in. The floor-board is, of course, loose and has a trenched bee-way or entrance. I have seen scores of hives sent out by appliance-dealers made from ½ in. yellow pine (before planing) that would hardly bear their own weight when lifted about by railway porters.

With regard to frames, let me say at once I believe in absolute uniformity throughout the apiary in all frames and appliances; and the standard frame is, to my mind, convenient and in every way suitable. I have tried various devices for spacing frames, staples, distance-pins, metal-ends, broad-shoulders, &c., but for some years past have used none other but the one of which I enclose a rough sketch, and which I consider perfect. The frame-ends rest on metal runners or strips, but these need not frighten your readers, for I simply clip them out of an old coal-bucket. The edges are straightened by means of a file such as is used for sharpening circular-saws. I groove a piece of wood so that the file fits tight when forced into the groove; then place these strips, one at a time, in a bench-vice, run the wood as a fence and the file on the top, and the edge of strip you can be straightened to perfection.

In making top-bars of frames I hunt up

strips of various woods, including American whitewood, satin walnut, sycamore, beech, American ash—in fact, anything but yellow pine, which latter I consider altogether too soft and weak for the top-bars of frames. Plane these strips up  $1\frac{1}{2}$  in. by  $\frac{3}{8}$  in., and place several together. Mark a square line for shoulder, two more lines for trench for side-bars; gauge  $\frac{1}{8}$  in.; then cut with small saw to gauge-mark; pare out with a sharp chisel; mark off shoulders; square a lot off together; cut them down with fine saw; gauge  $\frac{1}{8}$  in. each side, and shave off with a sharp chisel; run a saw-cut down the centre line of top bar, beginning with a keyhole saw and completing with a panel saw; and have a top bar that will not sag, and when worked on metal runners, as described above, there is very little trouble with propolis. Compared with the usual form of broad-shouldered top-bar the main advantage of that described above is that you may close up dummy-boards in any position, and leave a parallel bee-way  $\frac{1}{8}$  in. between dummy and outside frame. The frame-ends or lugs are tapered to a point, and thus give a good grip of same for handling. I also taper the side bars after the frames are put together from width of top bar ( $1\frac{1}{2}$  in.) to width of bottom bar ( $\frac{3}{8}$  in.), which I consider another advantage, as there is less bulged comb than with a parallel  $\frac{1}{8}$  in. frame.

I had no idea it would take so long to express the above, but in conclusion I send name and address, while signing myself

“STANDARD FRAME.”

### THE USES OF HONEY.

[5093] I think the annexed extract from a well-known monthly magazine is well worth reprinting in your journal. What a splendid thing it would be for bee-keepers if some one could persuade the proprietors of cafés to set before their customers a small pot of honey to sweeten their tea, coffee, or cocoa with instead of sugar! It would perhaps not be as simple and easy a method, but if the “fashion” could be once set it might go well, especially among the higher classes.—F. H., *Warrington*, April 17.

The extract reads as follows:—

“A few years ago honey was looked upon merely as a delicacy—a kind of sweet to place upon the tea-table. True, mothers and nurses used it in cases of infantile mouth disorders, but only lately have its all-round valuable properties become recognised. Those suffering from obesity may safely substitute it for sugar. In medicine we have found its value. It forms an effective and pleasing basis to many of our hand-pastes and skin-softening preparations, while no woman who appreciates a really good cup of tea would think of sweetening it with sugar while honey is to be obtained. Try it, and you will find that the latter imparts a delicacy of flavour never obtained by the aid of sugar.”—*The Lady's World*.

### NOTES FROM WYCHWOOD FOREST.

[5094] The poor bees are having a bad time of it this spring. It is a case of woe betide stocks that are short of stores. Having—to my sorrow—failed in attending to the needs of one colony, the result of a recent inspection was to find the bees all dead!

With fruit-blossom plentiful, and numerous flowers in bloom all around, I thought the worst was over, but the recent spell of wintry weather, with biting winds, will play havoc, I fear, with the bees, unless a change comes, as I trust it will, by the time this is in print. I am told that one man in this neighbourhood has lost five stocks of bees this spring, and another bee-man was telling me of numbers of bees he saw lying about on the ground dead. The outlook for big returns of our fine Oxfordshire honey is not too hopeful; still, we remember that the night is darkest just before the morn. We must use diligence and practice patience, and hope on.—J. KIBBLE, *April 16*.

### DOES THE CROCUS YIELD HONEY?

[5095.] I thought you would be interested in the enclosed extract from the *Daily Graphic* if it has not before met your eye.

I maintain that it is a physical impossibility for bees to get honey from crocuses. The nectar, if any, lies at the base of the pistil, quite  $1\frac{1}{2}$  in. or 2 in. beneath the cup, and I feel certain that bees only gather pollen from the crocus. Though I have had a very good opportunity lately of watching bees on crocuses, I never yet saw one use its tongue on the stigma of a flower. They certainly go to the base of the cup, but not for honey. In fact, there is none there, but for grains of pollen which have fallen from the anthers.

In my experience, the purple crocus is quite as much visited as the white variety.

I think the writer of the article in question can hardly have seen the inside of a hive, or he would not say that bees mix the pollen. Were he to look at a frame of comb he would find the little store of blue-squill pollen carefully separated from that gathered from the yellow crocus pollen, and, later, green stores of sycamore pollen. Bees do appear to dart from one flower to another, but do not always find suitable spoil. I can imagine that, in honey gathering, if the supply is short they are not so particular, and I have always thought this, though I may be wrong; but a glance at a comb proves the pollen is separated. I have wondered, apart from this article in the *Daily Graphic*, how bees prevent pollen from germinating, as it can be easily made to germinate in a solution of sugar.

What a wonderful season! The Hampstead bees were building comb in their candy boxes in March!—K. M. HALL, *Curator, Stepney Borough Museum, E.*

[Notwithstanding the “careful observations” which enables the writer of “Nature Notes” in the *Daily Graphic* to rightly assert

that bees gather nectar from the crocus bloom, it is well known that practical bee-keepers attach little or no value to the crocus as a honey-plant. It is, no doubt, very useful as a pollen-yielder during the early spring in places where the willow does not grow, or where gorse and dandelion are seldom seen in bloom; but that is all. The same may be said of the writer's other "discovery," supposed to prove the falsity of the common statement in text-books "that bees, when gathering pollen, strictly confine themselves to one sort of flower." Bee-keepers are, we think, agreed with regard to both assertions in the "text-books"—viz., that the crocus is a liberal pollen-yielder, but not of much value as a honey-plant; and that bees, as a rule, when foraging, confine themselves to one variety of flower. The slight and very rare deviation from this regular habit is merely the exception that proves the rule.—EDS.]

## Queries and Replies.

[3068.] *Bees Deserting Hive in April.*—I should be glad of your opinion, or that of any of your readers, on the following incident:—In this neighbourhood we have had a week or ten days of bright but exceptionally cold weather, hard frost at night and bitter winds by day. To-day has, however, been fine and warm, and this morning my stocks were all busy. I went out to the apiary about 1 p.m., and found a good deal of commotion, and for the time of year a large number of bees flying. I thought nothing of it, but on going out again after dinner found a cluster of bees just on and under the overhanging roof of one of the hives. I scattered them with the smoker, but in about a quarter of an hour they clustered again in the same spot. I put a skep over them, and by evening they had gone up into it. The total cluster in the skep was about the size of a man's fist. Do you think it was a swarm, and if so, what induced them to come out, as I am not aware of any hive being at all crowded?—H. W. ATCHLEY, *Bristol, April 19.*

REPLY.—The probability is that the cluster of bees will be what, in common parlance, is known as a "hunger swarm." You should endeavour to find out by examination the first fine day which hive the bees have forsaken.

[3069.] *Bee Parasites.*—Enclosed please find a dead bee and on it what I take to be the parasite known as the *Braula ceca*. I noticed it about a month ago on the thorax of a bee, and, on opening the hive again to-day it was still in the old place so (much, against my better feelings) I killed the bee and am forwarding to you. Is it not generally considered that these insects die off through the

winter months?—J. J. W. R., *St. Albans, April 16.*

REPLY.—The insect is—as supposed—the *Braula ceca*, or blind louse. The parasite in question fortunately does not thrive in this country and will usually die out during the second season subsequent to its introduction to a hive located here. It is, however, by no means uncommon to see them survive the first winter after being discovered in a hive.

[3070.] *Prevention of Swarming.*—Please give me your advice on the following points: 1. I have a strong colony of bees in a frame-hive, and I do not wish them to swarm. Will they not be exceedingly likely to swarm if the hive is "boiling over" with bees a month or two hence? 2. Will early supering check this tendency? The locality is 700 ft. above sea-level. If so, how soon, in an average season, should the supers be inserted? 3. If the bees persist in swarming, would it be advisable to place the swarm in a hive containing a weak colony? 4. In that case, would it be necessary to get a new queen for the old colony, so as to ensure brood being raised without loss of time, and would it also be necessary to destroy the queen in the weak colony? I send name, &c., while signing myself—BEGINNER, *Blairgowrie, N.B., April 18.*

REPLY.—1. Very likely, if the usual preventive measures of giving timely room, together with shade and ventilation in hot weather, be not attended to. 2. Yes, if given in time—that is, a little in advance of the bees' requirements. When the bees pretty well fill the hive, and are seen to be lengthening out the cells in upper part of combs in the brood-nest, supers must be given at once. 3 and 4. On no account do this; hive the swarm in a hive of its own. It would be folly to unite a good natural swarm to a weak lot of bees in another hive.

[3071.] *The Solar Extractor.*—I notice the question of solar wax-extractors was discussed at the last meeting of the British Bee-keepers' Association in London. It would be a great help, I am sure, to many bee-keepers if one of the speakers would instruct us how to make a good practical solar extractor at a moderate cost.—J. W., *West Kirby, Cheshire, April 12.*

REPLY.—You will find a solar extractor illustrated and described in the "Guide Book," page 86. A description, with full details of material required and measurements of same also appeared in our pages some time ago, in an article by G. M. Doolittle. The number containing it can be had post free for 1½d. in stamps.

[3072.] *Bees Dying in Spring.*—When cleaning and examining my stocks to-day, I found one hive literally choked with dead bees, and the floor-board covered with the curious little grubs, a sample of which I enclose. Can you tell me what they are, and

the cause of the death of the bees? The hive was full of bees and brood, and very strong, and they still had honey in store, so it was not starvation.—F. G. C., *Shepton Mallet*, April 20.

REPLY.—As you do not say the stock has perished outright, we infer that it is a case of several seams of bees becoming separated from the cluster and perishing through inability to reach the food stores. The choking up of entrance by dead bees should never be allowed to happen, as entrances are constantly watched and kept clear by careful bee-keepers. If the whole colony has perished we can only attribute the loss to some failure in winter preparation; but should a fair number of bees still be found alive, and the queen be in good condition, the stock may still recoup itself and do well. The "grubs" mentioned are the larvæ of some species of winged insect such as are found in decaying or decomposing animal matter of all kinds.

### PRESS CUTTINGS.

#### RADIUM, OR PERPETUAL HEAT.

The extraordinary discovery made by M. Curie, of the French Academy of Sciences, and just announced, in connection with the element radium, itself but recently discovered, has caused much stir and sensation in the London scientific world.

M. Curie has found out that radium possesses the weird property of being able to give out heat without combustion and without any molecular change, or, in simpler words, that if you possess a piece of radium you have a source of heat that is a thing of joy and warmth for ever.

Sir William Crookes, who has during the last few days been experimenting with radium, was seen by an *Evening News* representative this afternoon, and was asked his opinion on the French physicist's find.

He said that M. Curie's position in the Parisian scientific world put the genuineness of his discovery beyond doubt.

Asked about the source whence radium gets its "perpetual energy," Sir William replied that the matter was a puzzle. He had his own theories on the subject, however, and would after investigation communicate them to the public.

Radium as a heat giver is not a cheap question to take up as an experimental hobby. This interesting element costs £400 a gramme and is a thousand times dearer than any other metal.—*Evening News*.

#### BEEES BUSY AT AN AUCTION.

Whilst conducting a sale at Aldenham, Herts, under a distress for rent, Mr. W. H. Binyon, a Watford auctioneer, had a very

unusual experience. Annoyed at his goods being disposed of, the tenant of the house suddenly rushed out, and, seizing a hive of bees, pitched it into the midst of the bidders and auctioneer. The disturbed insects, thus rudely awakened, flew in every direction, causing both auctioneer and bidders to make a rapid exit. The owner, regretting his hasty action, soon afterwards came upon the scene with his face and hands protected, and hived the disturbers of the auction.—*Daily News*.

#### MUMMIFIED BEES.

At the International Agricultural Exhibition which is now being held in Vienna, a most interesting exhibit of bees is shown, in which will be seen perfectly-preserved specimens of mummified Egyptian bees estimated to be 6,000 years old. Three hundred tall fir and pine trees will serve to decorate the exhibition.

## Bee Shows to Come.

*A nominal charge of 2s. 6d. is made for notices in this column, which covers cost of insertion from order till date of show. Cash should accompany orders for insertion.*

June 23 to 27, at London.—"Royal" Agricultural Society's Show. Bee and Honey Section under the management of the B.B.K.A. Increased prizes for B.K.A. Associations as arranged in divisions or groups of counties. Schedules from Edwin H. Young, Secretary, 12, Hanover-square, W. Entries close May 1, or at extra fees up to May 15.

July 22 and 23, at Cardiff.—Honey show of the Glamorgan B.K.A., in connection with the Cardiff and County Horticultural Society. Bees, hives, honey, trophies, wax, appliances, and articles of food. Substantial money prizes and medals. Free entries. Six open classes. Schedules from William Richards, Gahalfa, Cardiff. Entries close July 16.

July 30, 31, and August 1 and 3, at Old Trafford, Manchester.—Annual Show of the Royal Lancashire Agricultural Society. Liberal money-prizes are offered for honey along with silver and bronze medals of the B.B.K.A. and also of the Society. Open classes for Honey-Trophy, Sections, Extracted Honey, Beeswax, Instructive Exhibits in Bee-Culture, &c. Schedules, when ready, from Edward Bohane, Secretary, Miller-arcade, Preston.

August 4, at Leamington.—Tenth annual show of the Leamington St. Mary's Horticultural Society. Three open classes for Six 1-lb. Sections, Six 1-lb. Jars "Light," and Six 1-lb. Jars "Dark" Extracted Honey, respectively. Liberal money prizes. Schedules from P. W. Smith, Secretary, 22, Leam-street, Leamington. Entries close July 30.

August 6, at Nantwich.—Honey department of the Cheshire Agricultural Society's Show under the management of the C.B.K.A. Numerous classes for hives, honey, and wax. Money prizes and medals. Schedules from T. A. Beckett, St. Werburgh's Chambers, Chester.

August 6, at Kingsthorpe, Northants.—Honey show of the Northants B.K.A., in connection with the Horticultural Society's Exhibition. Three open classes with special prizes, including one for single 1-lb. jar of honey. (*Entry free*.) Prizes 20s., 10s., 7s. 6d., and 2s. 6d. Schedules from R. Hefford, Hon. Sec., Sunnyside, Kingsthorpe, Northampton. Entries close August 1.

**August 12, at Radstock, Bath.**—Honey show in connection with the annual show of the Radstock and District Horticultural and Fanciers' Association. Schedules from the Secretary, E. M. Clark, 1, Fox Hills, Radstock, Bath.

**August 27, at Llangollen.**—In connection with the fifth annual Flower Show. Open classes for Six 1-lb. Sections, Six 1-lb. Bottles Extracted Honey, and Beeswax. Schedules from Frank Little, Castle-street, Llangollen. Entries close August 13.

**August 27, at Montgomery,** in connection with Montgomery and District Horticultural Show. Open classes for Six 1-lb. Sections and Six 1-lb. Jars Extracted Honey. Prizes in each class 10s., 5s., 2s. 6d. Entrance-fee 1s. each. Schedules from W. J. Jones, Secretary, Montgomery. Entries close August 20.

### Notices to Correspondents & Inquirers.

*Letters or queries asking for addresses of manufacturers or correspondents, or where appliances can be purchased, or replies giving such information can only be inserted as advertisements. The space devoted to letters, queries, and replies is meant for the general good of bee-keepers, and not for advertisements. We wish our correspondents to bear in mind that, as it is necessary for us to go to press in advance of the date of issue, queries cannot always be replied to in the issue immediately following the receipt of their communications.*

*All queries forwarded will be attended to, and those only of personal interest will be answered in this column*

**M. WALKER (Colwyn Bay).**—*Starting Bee-keeping.*—The first thing needed by a beginner in bee-keeping is a reliable text-book, without which no one can expect to manage bees well or with a chance of success. The "Bee-keeper's Guide Book" will afford the information asked for, and a perusal of its contents will put you in a fair way of obtaining all the requirements, with names, &c., of dealers from whom they may be purchased.

**A YOUNG BEGINNER (E. Dereham).**—*Mustard as a Bee-plant.*—The White Mustard (*Sinapis alba*) yields good honey plentifully at midsummer, if sown early in April. The fault against mustard as a bee-plant is that honey from it granulates very rapidly after removal from the hive, and this drawback must be taken into account by the bee-keeper.

**"Buzz" (Belfast).**—We do not doubt the queen's being "an imported Italian," as stated, but it bears all the appearance of an unmated queen.

**R. E. BUTT (Birmingham).**—*Joining B.K. Association.*—If you decide to join a county or a local association, assistance would probably be afforded by way of expert advice or help. Mr. Frank Tilley, 44, Beech-road, Bournville, Birmingham, last year took an active interest in endeavouring to form a district association for his locality and would no doubt advise you on the subject.

### Suspected Combs.

*Special Notice to correspondents sending queries on "Foul brood."*

*We urgently request that all letters sent with samples of suspected comb be put outside the box or tin containing the sample. Also that no more than a couple of square inches of comb be sent, taking care to neither crush the comb nor probe the cells before despatching.*

*In urgent cases (and where possible) we undertake to "wire" replies as to F.B. if six stamps are sent to cover cost of telegram. All letters should be addressed "Editor," not "Manager."*

**H. W. (Tottenham).**—The comb sent is affected with foul-brood in the incipient stage. Not only so, but the queen heading the stock is a worthless drone-breeder, as shown by the drone-brood being reared in worker-cells. It is useless trying to save such a colony; and, as the combs are evidently old, we advise doing away with the colony entirely, and destroying combs and frames. The hive may be used again after thorough disinfection.

**S. S. (Devon).**—Much obliged for second sample of comb. It gives just the help in diagnosing your case that the first specimen failed to do, and we could see at a glance that the brood is affected with foul brood. The disease—judging by sample—is only in the incipient stage, and may be checked by the judicious use of preventive measures, if the stock is fairly strong and headed by a prolific queen; otherwise we should not risk infecting the other hives by keeping the diseased colony alive. It will be far better to put an end to it and thus remove the risk without delay.

**SUBSCRIBER (Stourbridge).**—Your sample reveals a bad case of foul brood of old standing. "Burn the lot!" is our advice.

**"MAGISTER OLIM" (Colwyn Bay).**—Comb marked No. 1 contains only old mouldy pollen. It has evidently been bred in but once, and built in a hive badly stocked with bees, as the combs are imperfectly drawn out. No. 2 contains chilled brood only (no disease). The sample of sealed brood comb shows that the bees have been forced to build the brood-cells on the bared mid-rib of an old black comb, and that they have not taken kindly to their task is seen by the way in which the cells are built. No. 3 has only built-out cells on one side of comb, while cells (all capped over) are filled with granulated honey. The whole of your specimens give evidence of want of experience, because properly stocked hives, fairly well managed, will never be occupied with such combs as those sent. The "Guide Book" would render you much help in putting matters straight.

*\* \* \* Some Letters and Queries are unavoidably held over till next week.*

## Editorial, Notices, &c.

### AFTER THIRTY YEARS.

On Thursday, May 1, 1873—just thirty years ago—appeared the first number of the **BRITISH BEE JOURNAL**, heralded by its founder and first editor, the late Chas. N. Abbott, in these opening words:—

“In offering our services to our bee-keeping brethren through these columns, we do not in any way intend or seek to rival or disparage any other work or journal in which bee-keeping is considered, nor to dispute its claims to their serious attention and consideration.”

“We are glad indeed to acknowledge their value and worth, and our indebtedness to those great observers, authors, and contributors, who, since the days of the first great bee-master, Huber, have accepted his initiative, and made plain the way by which the earnest amateur may acquire the proficiency in knowledge of the Natural History and habits of the honey bee which is so highly essential to all who intend to make bee-keeping either profitable, instructive or pleasurable.”

Bearing in view the high ideal thus formed, Mr. Abbott conducted the **JOURNAL** for ten years in a manner creditable to himself and the best interests of the industry he sought to serve. But, beginning as our worthy predecessor did, with the professed object of teaching the art of bee-keeping, as time went on he was, by sheer force of circumstances, drawn into the bee-appliance trade, and in this way the paper in some degree lost its independent character as a journal. The result was that the late Rev. H. R. Peel—who at the time, in his enthusiasm for the bees, undertook the Hon. Secretaryship of the B.B.K.A.—was anxious that the Association should be represented by a journal entirely freed from trade interests, and with this in view purchased the copyright of the **JOURNAL**, and became its Editor. On the death of Mr. Peel the paper passed into the hands of its present proprietor and Senior Editor, Mr. Cowan, who is, and has been, Chairman of the British Bee-keepers' Association for many years past.

It is not to be expected that thirty years can pass by without competition in Bee-Journalism any more than in other things, nor is it desirable that it should be so. Consequently, rival journals have appeared at intervals as time passed, but so far it cannot be asserted that any have “come to stay,” as the term goes. Legitimate and honourable rivalry is in every way commendable, and has neither been complained of nor resented in the slightest degree by ourselves, and we have been glad to express in our pages a cheery word of “send off” for such more than once. On the other hand, where rivalry takes a form that does not commend itself to the principles we strive to uphold, the only course is to

ignore them or treat references to ourselves in print with silent contempt.

This much may, then, be said of the **BRITISH BEE JOURNAL** after its thirty years of life. It stands to-day in what may be called a condition of honourable and healthy old age, with abundant evidence that it has lost the respect of no honourable and fair-minded man. For the opinion of those who lack these attributes we need not care.

The circumstances which have kept our Senior Editor away from England for a period of nearly five years are known to readers, and we are sure it will be welcome news when we say that in a week hence Mr. Cowan leaves Boston on the voyage home. We—as Junior Editor—have endeavoured, in some way, to fill the gap caused by his long absence, but shall personally welcome his home-coming, for more reasons than one, while content in the knowledge that we have tried to keep to the straight and honourable course of journalism from which our senior has never deviated since the **BEE JOURNAL** became his property nearly twenty years ago. W. B. C.

## Correspondence.

*The Editors do not hold themselves responsible for the opinions expressed by correspondents. No notice will be taken of anonymous communications, and correspondents are requested to write on one side of the paper only and give their real names and addresses, not necessarily for publication, but as a guarantee of good faith. Illustrations should be drawn on separate pieces of paper. We do not undertake to return rejected communications.*

### AMONG THE BEES.

#### POLLINATION OF PLANTS.

[5096] At this season of the year pollen is so conspicuously to the front that naturally it bulks somewhat in our apicultural thoughts. I suppose every one knows it is the “dust” of flowers, that it is carried in by bees, and that it serves as a part of their food. Few know or care much more about it, but this use is a merely subsidiary one, and the chief purpose for which it has been created is to fertilise other flowers. It is, indeed, the fecundating substance which enables the seeds of flowers to come to full fruition, and it renders them capable of germinating into new plants. In the centre of the flower we have the pistil, standing, as a rule, upright. The lower part is the stigma, and here we find the ovum with its ovules secreting the hidden germ. Surrounding these parts are quite a number of short rods, bearing the pollen-grains ready to act when time and opportunity favours. Many thousands of pollen-grains are found in a single flower, as many as 250,000 having been counted. Nature seems at times prodigally bountiful in rearing and distributing an extra number of these, for the same reason, perhaps, that we find so many drones in some of our hives, to certify that no failure shall take place on her part to secure fecundation.

It is well known to botanists that flowers are of different sexes. Some are male, some

are female, while others are both, and are said to be hermaphrodite. The latter are capable of being self-fertilised. Many more flowers are fertilised by winds, but insects are by far the best and safest medium for transporting pollen from flower to flower. Bees in particular are excellent carriers of pollen, and thus greatly aid reproduction in the vegetable world. But the plant has to give a *quid pro quo*, and therefore ingeniously tempts the bee to visit quite a number of successive blooms of its species by hanging out right in front of its keen eyes, and equally keen scent, the tempting sweet which it covets so much because it is indispensable for its very existence. Humming a deep song of gratitude, it hovers over each flower lovingly, sucking out its coveted nectar, which the flower can well spare, and receiving from its visitor in return the impregnating pollen-grains it requires for bringing its seed to full fruition. Some species of flowers are known to be visited by at least sixty different insects, and all of these serve to carry pollen from one to the other, thus making it almost a certainty that the natural laws will be fulfilled. I have seen one single flower visited by sixteen separate bees in the space of about five minutes. Some visited one floret only, while others visited several. Even when they did not wait to load up the grains in their pollen-baskets, they went away to visit another flower, generally of the same species, with their thorax distinctly coated with many minute grains. Then the viscous substance formed on purpose on the stigma retained the needed supply, which, by an ingenious contrivance, is conveyed inside to the ovule to impregnate it, much as the spermatozoa finds its way at the will of the queen into the egg which she desires shall become a female worker-bee. The special adaptation and general procedure are, indeed, wonderfully similar on the whole. The ovule of the female plant has to be penetrated by the male substance, and the laws of reproduction are as specific and well regulated in the plant as in the animal. The ovule contains the germ of the new plant, but it remains fallow and undeveloped unless the necessary pollen-grains penetrate the ovum.

It is generally recognised that cross-fertilisation, which frequently is a necessity if there is to be any fertilisation at all, is the general rule. Even hermaphrodite flowers show a preference for pollen from another plant. This is believed to be a well-known law prevalent in the choice of drones by queens from another apiary, or at least another hive. The same seems to hold good in the floral world, and pollen from another flower is preferred. This the bee supplies, as when she is rifling the sweets of the flower she is just in the position which best suits for depositing the grains on the stigma just where they are most easily assimilated by the ovules.

The manner in which the stamens, pistil, style, and stigma seem to assist the insect as

an involuntary agent is most interesting, and can be observed in several of our common flowers, amongst them being the broom, furze, sage, and other labiates, the pea family, some bell flowers, and certain orchids. This is, of course, most noticeable in all flowers of irregular formation, and the observation of several of these deserves the particular notice of all lovers of bees and flowers. When alighting on a flower of regular formation it is, of course, possible for the bee to approach it from any point of the compass and settle on any part so that no undue strain is placed on any particular section of the flower. Several flowers, however, grow out from close to the stem, and of necessity must be visited from one point. The whole weight of each successive bee as she alights must rest on this, and hence the flower, to prevent this part being torn away, must protect itself, and, as a result, evolves the lip we find on numerous flowers. Many successive insects alight on the same spot, for if they visit the flower at all they have scarcely a choice, but must rest just at that one point so as to profit by their visits in securing either pollen or honey. Now our friends the bees, (both "humble" and hive-bee), thus alighting in the same position, induce the living protoplasm of the flower to respond to their pressure and courtless calls, for ages it may be, thus cause the flower to assume the very shape which is most favourable for these visits. The front petal, from repeated irritation, forms a lip, and even calls into being new cords and bands to strengthen and sustain the welcome weight of the insect.

In reply to Mr. Sherwood (5076, page 127), I am unable to give any authentic account of actual experiments being recorded to prove the truth of this belief, which, however, is universally credited as a sequence of natural reasoning in modern botany.—D. M. M., Banff.

#### HOME-MADE HIVES.

[5097.] In a recent number of the BEE JOURNAL I noticed the answer to "F. T., Wolverhampton," on "American Bacon-boxes for Hive-making," and quite agree with your remarks in reply. Used boxes are not advocated for the making of bee-hives, I know, on account of the joining-up required if the wrong sort of boxes are used; but from the right sort of boxes very good hives can be made. I enclose a photograph of one made by myself from boxes, and, as you will see, no paint has been used to hide imperfections. I should be very pleased to give a short article on the subject if you think it would be of any use to readers of the JOURNAL.

[In response to our request we have been favoured with the following details.—Eds.]

The boxes used are:—(1) An egg box; (2)



lobster box; and (3) "Quaker Oats" box. The cost of the boxes is 1s. 1d.

*The Stand.*—Cut four pieces from the thickest board of an egg-box, 26 in. long and 4½ in. wide. Put the pieces in pairs and nail each pair together; then at one end cut slanting from 2 in. at the bottom to full width of the board at the top, far enough back to allow a 6-in. alighting-board to be nailed on. Then cut two pieces and nail together to form the cross-piece at the back, measure from the back 19½ in., and fill up to the alighting-board with another piece of the egg-box.

*Floor-board.*—For this take the end of a "Quaker Oats" box, and after cutting off the dovetail ends cut two pieces from the other end of the box and nail on to the sides; this will not only make the floor-board the full width, but will keep it from twisting. Cut



Home-made Hive Made from Used Boxes.

out entrance in the centre of the front, ⅜ in. deep by 9 in., and back into the floor-board about 2 in., then gradually slant up to level.

*Outer Case.*—Take the four cross-pieces of the egg-box; these will be found to measure 9¼ in. by 19¼ in. by ¾ in. Cut two pieces 18 in. long, and two pieces 19½ in., and after planing nail them together, forming a bottomless box 19½ in. square. Then cut from the sides of the egg-box three pieces, 3 in. wide, to form plinths for the back and sides of the outer case; these serve the double purpose of keeping the floor-board in position, and preventing the body-box from being moved out of its place in rough weather.

The entrance-slide can be made by cutting one piece of wood ½ in. wide, and one piece 1½ in. wide, nailing together, so as to form a rabbet. Nail on to the front of the hive, level with the bottom of the outer case, and fit two pieces to slide in the groove. For the porch,

cut two small brackets, and nail on a board 19½ in. long by 4 in. wide.

*Body box (or Brood-chamber)*—Take the four pieces of the lobster-box measuring 9½ in. by 20 in., cut two pieces 8½ in. by 17½ in., and two pieces 8½ in. by 16 in., the latter to be chamfered on the top edge. Nail these at equal distances from each end of the longer pieces, so that the inside measurement is 14½ in. by 16 in. This is important. The space to the end of the side pieces can be filled up with the pieces cut off in reducing, nailing them a little lower than the chamfered edge to form a fingerhold; and two other pieces about 2 in. wide, nailed up to the end to keep the frames in position, finishes the body-box.

*Lift.*—Take one of the 6 in. pieces of the egg-box, and make another bottomless box, the same outside measurement as the outer case of the body-box, but with plinths nailed on all round.

*Roof.*—Cut two pieces from the side of the egg-box, 20 in. long and 4 in. wide; also two other pieces, 6¾ in. by 19½ in. Mark the centre of the latter, and cut off slanting to 4 in. deep on each side; then nail the four pieces together. For the top, use the two sides of a "Quaker Oats" box, measuring 1 ft. by 2 ft., and a further piece 2 in. wide, nailed along the ridge, to prevent any wet getting through the joint. This will fit over the lift or body-box, and, to prevent it going too far down, four small strips should be nailed inside, about ½ in. from the bottom.—HARRY CLARKE, *Allesley, Coventry.*

## WEAK STOCKS.

THEIR VALUE AS AUXILIARY COLONIES.

[5098.] So much has been, and is, written about the value of "strong colonies" and the obtainment of them, that a word for those which might otherwise have to "go to the wall" may not be out of place.

We are all glad to have strong colonies, and would like all our stocks to come under this heading, for that at times they fall short of the description is our serious loss, and it is with the object of suggesting that there are uses for the weaker lots that these lines are penned. I would at the outset disclaim the idea that the following matter is put forward as in any way original, as I am only too well aware, in all matters connected with the craft, of my own debt to those who were past masters ere I began my apprenticeship upon the articles of which the ink is not yet dry. There are limits to the amount of work which may be done by even the strongest of colonies, and it is a settled axiom that the greatest returns of honey are incompatible with the maximum increase of colonies. Honey is the prime object of bee-keeping, and this is best obtained by colonies devoted to this work

alone, the most profitable of which are the strongest stocks, or those with the largest field force; this force itself being at certain times advantageously strengthened by additions from other or "auxiliary colonies," under which heading I shall class all those which are not run for honey alone, but in some way or other reinforce the main armies of honey-producing hives.

It is with the object of assisting the beginner to decide upon the use to be made of various colonies not strong enough to give much surplus, that I have endeavoured to give some of the conditions essential to success when devoting these stocks to auxiliary purposes, in the following order:—

*Queen-rearing.*—It is not requisite, although advisable, that the strongest stocks should be sacrificed to this purpose. The vital point is that there shall be plenty of young bees to act as nurses. Strong colonies possess these, and are therefore successful, but a smaller colony may be arranged to have the desired strength of *queen-rearing bees*. A sound, warm hive, ample stores of all descriptions, steady feeding and a contracted entrance are very desirable points where the hive is made queenless.

*Drone-rearing.*—This is not intended as an argument in favour of weak stocks, as the strongest stocks are admittedly the best for this purpose, but any colony designed to rear drones largely must be classed as auxiliary, as it cannot be a good honey-producer. A stock, however, made queenless will satisfactorily rear drones from a choice strain, if it be made queenless. Cells should be removed from time to time and the hive reinforced by brood from another auxiliary. Feeding should not be neglected. The hive should be in a sheltered position, a south-westerly facing preferred, as we want our drones to fly in the afternoon. The date for this purpose should be definitely decided by the bee-keeper ahead of his requirements, as the drones should be flying when the queen cells are sealed.

*Worker-rearing and Comb-building.*—I have coupled these because one of the best methods of obtaining straight worker combs is to crowd a small colony on to three combs—one of honey, one of hatching brood, and a centre comb of foundation. With a young queen a starter only may be given, but profuse feeding is necessary. Mr. Simmins gives a repelation of syrup and Porto Rico sugar, in separate side-feeders. The combs, as built and filled with eggs, are utilised in a nucleus or as otherwise desired.

*Comb-filling.*—A colony too weak to store surplus may be profitably employed in filling and sealing empty combs. These may be placed at the side of the brood-nest, and warm, thick syrup, given in a rapid feeder. Thin wood dividers between the combs give the best combs, and combs may be built from full sheets in this way.

*Section-building.*—This may be usefully

begun in a similar colony to the above, by placing sections in a broad frame at side (or back) of brood-nest. A standard comb between these and brood-nest should catch surplus pollen. The drawn-out sections may be exchanged for others fitted with foundation when the sheets are well begun, and any syrup stored may be given back to the bees.

*Nuclei.*—A very weak colony may be usefully treated as such by the simple expedient of re-queening with a young queen or a queen cell.

If placed in a nucleus box, its roomy hive may perhaps be more profitably employed.

I have already considerably exceeded my intended limits, but the importance of the subject would seem to me to bear fuller treatment by the abler pen of an older bee-keeper, from whom one might obtain some of the useful points which have gone to make up his success. My desire has been to suggest to the bee-keeper that he shall from the beginning of the season, or as early as possible, definitely devote certain colonies to his desired auxiliary work, believing that the principle of allotted duties upon which the internal economy of each hive is based will bear extension to the apiary itself, and that it is "good bee-keeping" so to do.—L. S. CRAWSHAW, *Ilkley, April 27.*

#### CHEAP HOME-MADE HIVES.

[5099.] Referring to the letter of your correspondent, "Jim, Ipswich," who writes under the above heading on page 126, and my own letter on the same subject on page 137, I was somewhat surprised to find it rather sharply criticised by a certain section of bee-keepers who are anxious to justify themselves. I had intended to pass them by, but as they touch on a very important point, I ask the favour of space for a final reply to same on my part, feeling, as I do, that such articles are of little interest to the majority of your readers. In the first place I am, as stated, a beginner in bee-craft, but what I have said on the subject of hive-making I still adhere to, backed as I am by the instructions given on the subject in the "Guide Book." On the other hand, your correspondent "Jim" (on page 147) says: "A 1 in. board gets hot and makes the hive hot and stuffy," and recommends packing the dead-air space with fine cut straw, while the "Guide Book" recommends packing dead-air space in winter only. Again, with regard to "Jim's" point of comparing wild birds with bees in captivity, my reply to this may also serve as an answer to Mr. Briggs, who writes (on page 157) of bees found doing well under a slated roof. The criticisms of this correspondent are rather trying to the nerves of a practical joiner of nearly twenty-five years' experience. Therefore, I may be excused for asking "Jim" how he nails his angles of 3-in. wood without splitting boards?

When writing I treated him as an amateur in woodwork, and it should be clear to Mr. Briggs that we joiners often have to work on much thinner material than  $\frac{3}{4}$ -in. stuff, and the "wrinkle," mentioned on page 148, in using the bradawl is one of many such wrinkles joiners hear of. In regard to Mr. Briggs's offer to show me how hives are nailed together by lads, I have helped to train several apprentices to our joinery trade, and it would interest me more to know what thickness of wood the hive-making lads worked on. Therefore, the visit would be of very little interest to me. With reference to the butt, in making such hives I take it for granted wire-nails are used, and these, driven into "end-grain," the boards could be easily pulled off by the finger and thumb, with what result we may easily guess.

Even a packing-case maker generally uses fillets either inside or outside his angles, so that he nails into straight grain, and thus makes his case rigid. In conclusion, let me now drop hive-making and return to the subject of bee-life. The next and last point in the criticism of your correspondent, "Jim," is an important one. Both correspondents to whom I have referred, viz., "Jim," and W. Briggs, seem to delight in making comparisons with wild Nature. In one case the pheasant is quoted, in the other, bees under a house roof. I add another instance: It is said a horse turned into a meadow in severe weather, with no shelter beyond a covered shed, will fare very well, but take that horse into a draughty stable, the chances are it will take harm from the cold. I therefore ask the reason, why are such comparisons made? Do they serve the purpose of justifying oneself in the construction of a cheap home-made hive, or tend to prove that bees would fare just as well in a match-box hive, or in the hollow trunk of an old tree? If this is so, we may put aside our ideas of "modern bee-keeping," including our bar-frame hives and appliances, as well as our queen-rearing and re-queening. Turn our backs on the gatherings that periodically take place at 105, Jermyn-street, and set no value on the researches of scientists who have devoted valuable time and study for the good of bee-keepers, and return to the straw skep and sulphur pot. On the other hand, if one is permitted to judge from the spirit of your correspondents in last week's issue, it is clear that there still remain good bee-keepers who are deeply interested in the delightful study of bee-keeping, and imbued with that spirit, whatever they do in connection with their bees they will do it well.—W. D., *Aldershot*, April 27.

#### A RAILWAY PORTER'S BEE-HIVE.

[5100.] While surveying at North Tawton, a station on the London and South-Western Railway in Devonshire, I came across a swarm of bees which had built their nest in a recess at the side of a chimney-stack of a railway

porter's cottage, and, thinking it might be of interest to your readers, I took the photo of which I enclose a copy. I learnt that the bees took up this position about two or three years ago, and the porter, not being a bee-fancier, tried one day to get rid of the bees by



Bees in House Roof.

means of sulphur-fumes, and was successful in destroying what he termed "buckets full o' 'em." He also removed bricks to expose the combs, and took out two or three large basins full of honey and comb, and having, as he thought, done a fairly good day's work, retired to bed in peace and fell asleep. Soon after he was suddenly awakened by a sharp pain in the leg, and, striking a match, found that one of the bees had gone to bed with him, and had its revenge by stinging the disturber of the bee-nest and robber of their stores. Not many months after the bees were in possession by hundreds, but the porter acted on the principle of "once bitten, twice shy," so he left the bees alone, and they are again busy as ever flying around the chimney-stack on a bright day. His back door is but a few feet away, and he says that his children will have a "warm time" of it. Should I ever come across another curious bee-nest, I shall be very pleased to send you a photo for the benefit of your readers.—JOHN B. MANN, *Exeter Station*.

#### A PARTING WORD FOR THE BEES.

[5101.] It has often been stated that bees can be made as profitable as any other department of farming. Speaking for myself I may say that after five years' experience I can not

only fully endorse that statement but "go one better," and say they are certainly far more profitable than either poultry, cows, or pigs. I owe my success in bee-keeping entirely to the "Guide Book" and the B.B.J., having received neither instruction or advice from any other source. And now, on having to give up bee-keeping and return to town life, I wish to thank yourselves and the various contributors to the B.B.J., for the valuable assistance I have received from its pages. Few among older readers will have forgotten poor Lordswood, and I may also mention the name of H. W. Brice, for I consider that every beginner in bee-keeping should carefully peruse the able article by the latter, entitled "How to Succeed," which appeared some time ago.

For myself, I think it will be admitted that I have been fairly successful when I mention that having made from £20 to £25 per annum by the sale of honey. Nor did I ever lose a customer, or fail to find a market for all the honey I could produce, and gained the two first prizes for comb honey in sections and for extracted honey at the Penzance shows of 1901 and 1902.

I have had no extraordinary "takes" of honey from a single hive, or even so good an average per hive as are recorded in your pages—in fact, nothing in the way of "record" takes, although I am a "bit of a fisherman." I need hardly say how great is my regret at having to part with the bees. They have been both a "hobby" and an item of business, and I am sad enough in knowing that it may be years before I again have the inexpressible pleasure of seeing my own bees "swarm." Again thanking you very sincerely.—SAM. HARBORNE, *Treen, Cornwall, April 27.*

### MODERN BEE-KEEPING.

*From a Paper read at a Meeting of the Society of Arts, London, April 22.*

By WALTER F. REID, F.I.C., F.C.S.

(Member of Council and First-class Expert of the British Bee-keepers' Association.)

It was our privilege to attend the meeting referred to and hear an exceptionally interesting lecture, profusely illustrated by an almost unique collection of lantern slides. The latter comprised views of apiaries, hives and apparatus used in bee-keeping in various parts of the world, along with photos from life of the various manipulations in bee-handling by skilful experts. The first portion of Mr. Reid's paper was of such unusual interest to bee-keepers that we are glad of the privilege of reproducing it from the full report of the journal of the Society of Arts, as under.—  
[Eds.]

"The industry of bee-keeping is one of the oldest, if not the oldest, of all the industries connected with agriculture. From the very

earliest times we find references to bees and their products, and these references are of such a nature as to show an intimate knowledge of bee-keeping. In the Bible, for instance, beeswax or honey is mentioned more than seventy times. Honey was the only substance known to the ancients capable of replacing our sugar, and for a long time it was the only substance available for preserving organic materials. The body of Alexander the Great was preserved in honey, and it has been recorded that Herod I. kept the body of Mariamne, his wife, for seven years in honey. Wax was of the greatest importance when candles and lamps were the sole means of illumination, and during the Middle Ages enormous quantities were consumed in the services of the Church of Rome. In those times bee-keepers had special rights and privileges, and formed powerful guilds, especially on the Continent. The introduction of sugar, together with the more extensive use of oils for illuminating purposes, brought about a decadence in bee-keeping, from which it is only now recovering. It has been fully demonstrated that honey has a dietetic value possessed by no form of sugar, while beeswax possesses properties not shared by paraffin or other mineral waxes, and which are rapidly causing the demand for it to increase. One of the chief obstacles to a general restoration of bee-keeping to its former prosperity lies in some of the bee-keepers themselves. There are thousands of apiaries in this country, the owners of which employ methods and appliances which the Egyptian of 4,000 or the Greek of 2,000 years ago would have condemned as obsolete. Fortunately the British Bee-keepers' Association, and the affiliated county associations are working hard to spread the knowledge of more modern, humane, and remunerative methods, and their efforts are being rewarded with a gratifying amount of success. Some of the county councils are also doing good work, and under the new Education Act may do much to foster this important rural industry. In a few cases, however, the instructors appointed have not been sufficiently familiar with modern methods, so that their teaching must have a retrograde effect.

Before real progress could be made in apiculture it was necessary to obtain an intimate knowledge of the organisation and habits of the bees themselves. For centuries the wildest guess work took the place of exact observation, even the sexes of the bees were hopelessly confused, and the Germans still refer to the drones in the female and the queen in the male gender. The man who of all others contributed most to our knowledge of bees was Huber, the blind naturalist of Geneva. Although he was himself unable to observe, yet, with the help of others, he made most important discoveries, and, at the same time, laid the foundation for an improvement destined to revolutionise bee-keeping, namely, the hive

with movable combs. In Huber's hive the combs were fixed in frames swinging on hinges, so that they could be opened out like the leaves of a book. While observations could be easily made upon bees kept in such a hive, yet the construction was expensive, the combs were not interchangeable, and there were other reasons why this invention was not suitable for the practical apiarist. Following Huber many attempts were made to construct hives with movable frames; but the first successful hive on modern principles appears to have been that of P. J. Prokopovitch, a Russian bee-keeper, who in 1841 invented the system which contains the essential elements of our sections and shallow-frames of to-day. He also used a slotted-board or grating as a queen-excluder, and was thus enabled to secure comb honey uncontaminated by brood or pollen. As Prokopovitch had an apiary of 2,800 hives, at which the number of students was never less than eighty, his ideas spread rapidly. In Germany Dr. Dzierzon used movable frames for the body of the hive, and has probably done more than any one else to extend the use of this kind of hive. In Great Britain Mr. T. W. Cowan has been the apostle of the bar-frame hive, and in the columns of the BRITISH BEE JOURNAL, as well as in numerous publications, he has rendered signal service to British bee-keepers. The movable frame has been invented and introduced into practice, but it still had one defect. In order to induce the bees to attach their combs to the upper bar of the frame, it was necessary to affix a piece of comb to the wood, and this method was adopted by Prokopovitch. The combs worked out by the bees were not, however, always straight, and consequently not interchangeable. It remained to find some means of compelling the bees to build straight combs in the frames, and here again the right man appeared in due course in the person of a Bavarian carpenter, J. Mehning, of Frankenthal. He found that when a sheet of wax is embossed with a pattern representing the base or foundation of the cells the bees will adopt this work of human hands as their own, and finish off the cells thus sketched out for them. A frame filled with such a sheet of "foundation" ensured a straight comb, and thus in 1865 another important step in apiculture was made. Hitherto, in order to obtain honey it was necessary to crush the comb containing it, and strain off the honey from the fragments of wax. This was much to be regretted, not only because it took the bees a long time to build fresh combs, but also because they consumed about 10 lb. of honey in order to secrete 1 lb. of wax, and this had to be done in that short period of the year available for the honey harvest. It occurred to an Austrian officer, Major von Hruschka, in 1865, that the honey might be extracted without injuring the comb. He tried the experiment, and it succeeded. The method he adopted was to fasten the

comb in a frame after the capping of the honey-cells had been pared off, and to revolve the frame rapidly by means of a string. Under these circumstances the honey flies out of the cells, leaving the comb uninjured and fit for re-filling by the bees. This invention of Hruschka is the original of the centrifugal machine known as a 'honey-extractor' by the modern bee-keeper of to-day."

Mr. Reid then proceeded to explain the uses of various appliances, of the best types and latest forms, with the help of a complete set of the various articles required in an apiary worked on modern principles. All of which matters, though new to the majority of those present, are well known to our readers.

The paper concluded with a long and interesting series of photographic views of apiaries in various parts of the United Kingdom selected from the "Homes of the Honey Bee" as illustrated in this JOURNAL, accompanied by a very brief reference to each.

The lecture was listened to with evident interest, and at its close a cordial vote of thanks was accorded to Mr. Reid for his paper.

---

## Queries and Replies.

---

[3073.] *Bees Dying in Winter through Unwholesome Stores—An Editorial Complaint.*—I am sending herewith two pieces of comb taken respectively from my two hives, and I should be obliged if you would tell me what is the matter with them. Is it foul brood? Regarding the hive from which No. 1 sample was taken. I had to destroy the queen last September, as I found she had lost one wing and the use of one leg, and, in consequence, could not move properly over the combs, and was hardly breeding at all. The new queen substituted for the maimed one did very well, but the stock was very weak and deficient in honey, so I fed the bees until late in the autumn, and gave the food too fast, as I found that the syrup was dripping down on to the floorboard. On discovering this I slackened the supply. On opening the hive last month I found all the bees dead and mouldy, and most of the combs in a horrid mess. I therefore ask, Can I use any of the combs, or should I destroy the lot? With reference to No. 2 sample, the hive it came from was rather weak last autumn (I fear the queen went off along with a swarm which issued in mid-July, when I was from home, and I did not discover the loss until September), but the bees appeared to have enough honey, so I did not feed them. They have wintered all right, and the queen is now breeding a little, but the colony is very weak. Although no feeding was done I find the combs apparently the same as in the first-named lot. 2. Is it possible that they have contaminated their honey by "robbing" the

food from No. 1? I may say that all through last summer and up to the present month we have had an exceptionally wet time.—F. H. D., *Pontypool, April 21.*

REPLY.—1. There is no sign of brood, foul or otherwise, in either sample of comb sent. But if all combs in the hives referred to were in similar condition to samples, we cannot wonder at bees dying outright in No. 1, and being found "very weak" in No. 2. The combs must certainly have been as stated, "in a horrid mess," nor did the process of examining the samples, as packed by yourself, conduce to editorial blessings, and we must be excused for saying it is a bit too bad for correspondents to inflict such disagreeable tasks upon us. Regarding the facts, it may be said that the syrup food given last autumn to No. 1 has evidently run from the feeder down among the combs, saturating the pollen in the cells, and setting up fermentation of the syrup-and-pollen mixture, causing it to ooze from the cells in a "mess" as stated. Partaking of such food, and clustering on such combs, could only end in death to the bees, and we therefore advise destroying such combs by burning. 2. The second hive may also have suffered by the bees carrying off unwholesome stores from floorboard of No. 1.

[3074] *Bees Queenless and Broodless in April.*—I am forwarding for your inspection a small piece of comb from one of my hives. When I packed the stock down for winter it was very strong in bees, and well supplied with stores; in fact, I was so well satisfied that I did not give them a cake of candy as is usual. On my overhauling the frames now, I find only about a handful of bees in the hive, and no trace of a queen or brood. Several of the frames, however, are half full of honey. 1. Will you kindly say if you can trace any foul brood in the comb sent? I have never had any disease among my bees, and hope it may be many a long day before I do. But I should like your opinion on the comb. 2. If free from disease, will the other stored combs in same condition as sample do to feed my other stocks; or would it be advisable to put a skep of bees on top of the vacant hive and allow the bees to transfer themselves into it? I presume it would be too early to do that yet. I have been a subscriber to B.B.J. for many years and have derived great benefit from perusal of it. I send name and address, while signing myself "AN OLD READER," *Oakle-street, April 21.*

REPLY.—1. The comb, though old and black, contains nothing worse than pollen and honey. 2. With regard to the food in hive, it will be quite safe to give it to the other stocks if all the combs are like sample sent, but not otherwise. We should not advise the transference of a stock from skep on to such old combs as those in question. Far better to let the bees build clean, new combs on frames

fitted with full sheets of foundation. It amply repays the outlay to do so. In any case, the skep should not be placed over a frame-hive until it is getting crowded with bees, and weather is settled and warm.

[3075.] *Dealing with Foul Brood.*—Here-with I enclose pieces of comb taken from hive, which, I fear, has foul-brood. I suspected it last year, but was reassured in my mind that it was all right. The bees were strong in autumn, and had an abundance of stores and brood right up to September without any stimulating. They now cover only about three or four frames. The queen is an old one, and the combs are also old. The stock has been well packed up with American leather-cloth next the frames, so no water has got amongst them. I enclose stamped telegram form, and should you find foul-brood, I will be obliged if you will kindly "wire" me; if not, a reply in B.B.J. would suffice. There is a lot of eggs laid in the combs, but very few cells are capped over, and it looks as if there had been a decided stoppage in breeding. I trust that it may not be foul-brood, as I have about forty stocks of bees. I am a regular reader of the B.B.J., and am always glad to avail myself of many hints therein given. If foul-brood exists, do you advise getting the bees off the present frames on to clean ones in fresh hive, and destroying these old frames?—H. G. M., *Dorset.*

REPLY.—As stated by "wire," there is foul brood in comb. It is not at all a bad case, but with forty stocks of what we assume are healthy bees in hand we should not palter with a few bees in the effort to save them, but mercifully put an end to the lot, and destroy the combs. Then disinfect the hive before using again. We also advise a careful eye being kept on the hatching brood in the other stocks where the smallest suspicion arises.

[3076] *Transferring Bees from Bucket.*—I am writing to know if you will kindly afford me a little information about bees. Last summer I bought a swarm that had been hived in an old wooden bucket, and as I had no previous experience whatever of dealing with bees, I let them remain in the bucket for the winter. Now, however, I want to transfer the bees out into a frame-hive which I have by me. They are a pretty strong colony and appear to have wintered very well. I kept the hive warm and gave the bees syrup through a feed-hole, made in the bottom of the bucket. The swarm was hived in May last year, and I did not take any honey away from them at end of the season. I wish to know the best time of the year to transfer them as stated above. I have read up in the "Bee-keeper's Guide Book" the way to do it and think I can manage all right. I also want, if possible, to shift them so as to prevent swarming this year. Kindly oblige me with a

reply and thanking you in anticipation thereof.  
—J. W. C., *Aldershot, April 17.*

REPLY.—Our advice is, allow the bees to transfer themselves, as directed in the "Guide Book," which you already possess. It is infinitely better to do this than adopting the plan of cutting out combs and brood, and laying them into frames. Not only so, but the bucket may remain on as a surplus-chamber after the bees have transferred the brood-nest below, and be removed at end of season full of honey for extracting.

[3077.] *Swarm-Catchers and Non-Swarming Hives.*—Being a reader of your helpful papers, the BEE JOURNAL and Record, I beg leave to trouble you on the following points: 1. I am desirous of making a swarm-catcher, and with regard to the same would like to know if the queen can pass through a "Porter bee-escape? As my employment does not allow me to be near my bees between the hours of 9 a.m. and 5 p.m., I intend to use a swarm-preventing chamber under my hives. But I do not quite clearly understand how the swarm-preventing chamber is worked in order to effect the intended purpose. I therefore ask: 2. Is the box of shallow-frames (fitted with foundation) inserted below the brood-chamber in the morning and withdrawn in the evening? and are the bees which have gathered in the lower box brushed or shaken into a hive ready for their reception? I send name and address, and sign myself A BEGINNER, *Newcastle-on-Tyne.*

REPLY.—1. In making your "swarm-catcher" do not introduce a "Porter bee-escape" at all. Use the cone of perforated metal generally adopted. 2. The shallow-frame box used under brood-chambers in non-swarming hives is inserted below the body-box when the latter begins to get crowded in early summer; and when the bees have—sooner or later—taken possession and started building combs therein, the box is moved bodily, bees and all, and placed above the brood-chamber. It then becomes the storage-chamber for surplus honey, and by giving the bees room to work helps to prevent swarming. Your view of putting the bees of lower chamber into a new hive is altogether an erroneous one.

[3078.] *Hybridising Bees.*—After studying the subject theoretically for some time, I am about to commence bee-keeping. I have the promise of the first swarm from the hives of a cottager in the village, and I hope, after it is established in my frame-hive, to be able to Italianise it by introducing a Ligurian queen in place of the black one; but I am told by a friend that if I do so there will be some risk of my subsequently hybridising the other bees in the village, and that "hybrids" are very bad tempered. I should be very sorry to be the means of destroying the harmony which at present seems to exist between the bees of the village and their owners, and it seems to me

that if I allow no drone-comb in my hive I can keep Italian bees without the suggested danger. Will you kindly advise me in the matter in the columns of your valuable paper, which I now take in regularly?—T. C. C., *Coombe Bissett, Salisbury, April 27.*

REPLY.—Since you have not yet made a start with bees, and desire to introduce no element of discord between the village bee-keepers and yourself, we advise deferring the introduction of a new variety of bees till the necessary experience has been acquired which will enable you to judge of the advisability or otherwise of a change. As a matter of fact, we may say, once you introduce the Ligurian bee into your hives the villagers' bees will soon become hybridised unless you entirely stop drone-rearing, and to do so would tend to mar your own prospects of success.

## Bee Shows to Come.

*A nominal charge of 2s. 6d. is made for notices in this column, which covers cost of insertion from order till date of show. Cash should accompany orders for insertion.*

June 9 and 10, at Bishop Stortford.—Annual Show of the Essex Agricultural Society. Bee and Honey Section under the management of the Essex and Suffolk Beekeepers' Association. Classes open to the United Kingdom. Schedules from Mr. W. J. Sheppard, King's Head Hill, Chingford. Entries close May 15.

June 23 to 27, at London.—"Royal" Agricultural Society's Show. Bee and Honey Section under the management of the B.B.K.A. Increased prizes for B.K.A. Associations as arranged in divisions or groups of counties. Schedules from Edwin H. Young, Secretary, 12, Hanover-square, W. Entries close May 1, or at extra fees up to May 15.

July 22 and 23, at Cardiff.—Honey show of the Glamorgan B.K.A., in connection with the Cardiff and County Horticultural Society. Bees, hives, honey, trophies, wax, appliances, and articles of food. Substantial money prizes and medals. Free entries. Six open classes. Schedules from William Richards, Gabalfa, Cardiff. Entries close July 16.

July 29, at Wallop, Hants.—Honey Show of the Broughton and Wallop Branch of the Hants and Isle of Wight Bee-keepers' Association. Two open classes for single-section and 1-lb. jar respectively (entry free). Schedules from Miss Tucker, The Ludens, Broughton, Stockbridge, Hants. Entries close July 22.

July 30, 31, and August 1 and 3, at Old Trafford, Manchester.—Annual Show of the Royal Lancashire Agricultural Society. Liberal money-prizes are offered for honey along with silver and bronze medals of the B.B.K.A. and also of the Society. Open classes for Honey-Trophy, Sections, Extracted Honey, Beeswax, Instructive Exhibits in Bee-Culture, &c. Schedules, when ready, from Edward Bohane, Secretary, Miller-arcade, Preston.

August 4, at Leamington.—Tenth annual show of the Leamington St. Mary's Horticultural Society. Three open classes for Six 1-lb. Sections, Six 1-lb. Jars "Light," and Six 1-lb. Jars "Dark" Extracted Honey, respectively. Liberal money prizes. Schedules from P. W. Smith, Secretary, 22, Leam-street, Leamington. Entries close July 30.

August 6, at Nantwich.—Honey department of the Cheshire Agricultural Society's Show under the management of the C.B.K.A. Numerous classes for hives, honey, and wax. Money prizes and medals.

Schedules from T. A. Beckett, St. Werburgh's Chambers, Chester.

August 6, at Kingsthorpe, Northants.—Honey show of the Northants B.K.A., in connection with the Horticultural Society's Exhibition. Three open classes with special prizes, including one for single 1-lb. jar of honey. (*Entry free.*) Prizes 20s., 10s., 7s. 6d., and 2s. 6d. Schedules from R. Heford, Hon. Sec., Sunnyside, Kingsthorpe, Northampton. Entries close August 1.

August 12, at Radstock, Bath.—Honey show in connection with the annual show of the Radstock and District Horticultural and Fanciers' Association. Schedules from the Secretary, B. M. Clark, 1, Fox Hills, Radstock, Bath.

August 27, at Llangollen.—In connection with the fifth annual Flower Show. Open classes for Six 1-lb. Sections, Six 1-lb. Bottles Extracted Honey, and Beeswax. Schedules from Frank Little, Castle-street, Llangollen. Entries close August 13.

August 27, at Montgomery, in connection with Montgomery and District Horticultural Show. Open classes for Six 1-lb. Sections and Six 1-lb. Jars Extracted Honey. Prizes in each class 10s., 5s., 2s. 6d. Entrance-fee 1s. each. Schedules from W. J. Jones, Secretary, Montgomery. Entries close August 20.

### Notices to Correspondents & Inquirers.

*Letters or queries asking for addresses of manufacturers or correspondents, or where appliances can be purchased, or replies giving such information, can only be inserted as advertisements. The space devoted to letters, queries, and replies is meant for the general good of bee-keepers, and not for advertisements. We wish our correspondents to bear in mind that, as it is necessary for us to go to press in advance of the date of issue, queries cannot always be replied to in the issue immediately following the receipt of their communications.*

*All queries forwarded will be attended to, and those only of personal interest will be answered in this column*

H. M. RILEY (Leicester).—*Books on Bee-keeping.*—Either the "Guide Book" (price 1s. 8d. post free) or "Modern Bee-keeping: a Handbook for Cottagers" (price 7d.) will answer your purpose, both being suitable for beginners.

L. B. WITHERS (Kent).—*The Recent Articles on Foul Brood.*—It is not intended to publish the above in separate or pamphlet form, but the back Nos. of B.B.J. containing the complete series of articles (ten weekly issues in all) can be had for 10d. post free.

F. T. (Wolverhampton).—*"Canadian Bee Journal."*—The journal referred to is published monthly. It can only be had from the publishers, Messrs. T. Goold, Shapley, & Muir Co. Ontario, Canada. Price one dollar per annum. If desired, we would lend you a specimen copy from our "file" for perusal.

G. PITTMAN (Birmingham).—*Dead Bees Cast out of Hives.*—Bees sent have the appearance usually seen on "robber-bees" from other hives, but it is difficult to say for certain how much of the shiny, black look borne by the bees when received may be due to their being suffocated in the very closely packed matchbox used in posting. Over a dozen poor bees (of the more than 100 sent) were just alive when received,

though how they managed to survive is a wonder. If there are any stores in the hive, we should try the effect of ceasing to give candy, in order to end the trouble complained of.

G. (Suffolk).—*Bee Books.*—We hope to be able to supply Dr. Miller's book along with that of Professor Cook shortly, when prices, &c., will be announced.

T. PRING (Gosport).—*Moving Bees.*—If some particulars are sent of the "mistake" you fear has been made in moving bees, we will probably be able to give advice thereon. There should be no difficulty in moving a hive four or five miles if carried, as stated, by "hand truck."

E. JACKSON (Cambs).—*Old Combs for Surplus Storing.*—It is always deemed advisable to use combs that have never been bred in for surplus storing, and there can be no doubt that the quality of the honey is improved thereby.

### Suspected Combs.

G. W. (Carnarvonshire).—The sample of comb is affected with foul brood. Moreover, as the stock is weak and you failed to find the "queen," and to say nothing of drone-brood being reared in worker-cells, the best thing to do is burn the lot as being worse than valueless.

(REV.) J. SMITH (York).—Comb contains nothing more than pollen, worthless to the bees as food, because of having become hard and mouldy. The hon. sec. of the York and District B.K.A. is "Mr. Fred. T. Pay, Dunnington School, York."

MEIRIONWR (Dolgelly).—There is foul brood in comb sent, and, as from other indications, the queen appears prolific, we advise getting the bees off frames on to ready-built combs in clean hive, if possible. The combs on which the bees now are should be destroyed, and hive disinfected before using again.

N. B. (Oxon).—No need for microscopic examination of comb sent; it is a decided case of foul brood, and should be dealt with at once, as proposed.

INQUIRER (Hull).—The appearance of sealed cells in comb very much resembles that of foul brood, but some of the unsealed larvæ (in pupa stage) looks as if there had been some over-dosing with naphthaline. We should like further particulars with regard to this. On the other hand, the queen is evidently faulty from drone-larvæ being reared in worker cells. We find slight traces of foul-brood; but the stock seems altogether out of normal condition, and is not likely to do any good.

*\*\* Some Letters and Queries are unavoidably held over till next week.*



# Editorial, Notices, &c.

## THE "ROYAL SHOW FUND."

We are glad to learn from the subjoined communication that the date of closing entries for the "Royal" Show has been extended till May 15 without extra fees. No doubt the disappointing weather throughout April had a depressing effect on the entries up to the date originally fixed; nor can we wonder if bee-keepers, who find no newly-gathered honey in their hives at a time when they should be applying for entry forms, do not feel a very lively interest in preparations for the show-bench.

On the other hand, it would be regrettable in the highest degree if, through any apathy on the part of bee-men, the special efforts made this year by the Council of the B.B.K.A. and the generous way in which their efforts have been supported by the Royal Agricultural Society should be rewarded by a half-hearted display in the bee department at the first exhibition of the Society on their permanent show-ground in London. We, therefore, once again express our earnest hope that the extension of time for making entries till the 15th inst. will arouse in all well-wishers of the industry a little of the public spiritedness which prompts a man to take a personal share in what conduces to the general good. In other words, to do something practical by way of promoting the industry in which bee-keepers as a body are interested; and the most useful way in which the spirit referred to can be applied just now is in the direction indicated above, and we trust our appeal will be responded to in the hearty way it needs and deserves.

The following contributions to the above Fund are hereby gratefully acknowledged:—

	£	s.	d.
Amount as per previous list	18	0	6
Gen. Sir Stanley Edwardes ...	0	10	0
F. W. L. Sladen .....	0	5	0
F. E. Matthews.....	0	3	0
Rev. W. E. Burkitt .....	0	2	6
R. Brown.....	0	2	6
Geo. Hayes .....	0	2	6
H. W. Seymour .....	0	2	6
J. Pearman .....	0	2	0
S. J. Mayer .....	0	1	0

Total ..... £19 11 6

EDWIN H. YOUNG, Secretary,

12, Hanover-square, London, W.

May 4, 1903.

### Special Notice.

In view of the recent unpromising bee-weather it has been decided to forego extra

fees upon entries for the Honey Classes at the "Royal" Show sent in between the present date and May 15, which latter is the final day for entries.

A few copies of the Prize Schedule and entry forms remain on hand, and may be had upon application to the Secretary, B.B.K.A., 12, Hanover-square, London, W.

Accompanying the above communication we were favoured with the following letter from the Vice-Chairman of the B.B.K.A.—  
[EDS.]:—

DEAR MESSRS. EDITORS,—May I through the medium of your columns draw the attention of all Secretaries of County Associations to the above special notice? When the new classification by groups of counties was proposed, it was considered a great step in advance in favour of the Northern and Midland counties, and, as honey of any year may be staged, entries should not be lacking. I regret to learn that the members of county associations are not at present making entries in sufficient numbers to warrant the continuance of this year's classification for another season. It is, therefore, sincerely to be hoped their secretaries will see that they do not fail to support the Central Association at the most important show held in recent years. We have provided a most liberal prize list, which will give chances of winning to a far larger number of competitors than ever before, and it will be a great disappointment to those who work hard in the interests of bee-keeping if bare show-benches are to be their reward.—  
THOS. I. WESTON, Vice-Chairman, British Bee-keepers' Association, May 4.

## CUMBERLAND B.K.A.

Three sectional annual meetings of the above Association were held at Whitehaven, April 16, Carlisle, April 23, and Keswick, April 29, with Mr. James Thomson, its Vice-Chairman, Canon Rawsley, its Chairman, and Thos. Couch, Chairman pro tem., presiding respectively, who, together with members present, numbered thirty-five in all. The County Council representatives were Messrs. Henry Fox, C.C. St. Bees, Thos. Carey, C.C. Maryport, and (unofficially) A. Mitchell-Dawson, C.C. Keswick.

The expenses for 1902 amounted to £83 15s. 3d., which were met, with a trifling balance to the good; there would, however, have been a deficit had not the County Council increased their grant of £30 by a special grant of £6 10s., and other donations amounting to £4 5s. 9d. were sent in response to an appeal by the Hon. Sec.

The Hon. Secretary read communications sent to the County Council, asking for a considerable addition for 1903 to their grant of last year, accompanied with facts and figures showing the impossibility of working

the whole county efficiently, and clearing it of disease, without a suitable grant.

The Report for the second year's work showed an increase of membership from 109 to 183, and now stands at 217.

All the officers were re-elected, and the Right Hon. W. C. Gully (the Speaker) and Claude Lowther, Esq., M.P., were elected Vice-Presidents.

Messrs. Wm. Dobson, C.C., and Hugh Jackson, C.C., were elected Hon. members.

The report of the expert (Mr. J. Gray) showed that he visited 215 apiaries, 157 of which were found healthy and 58 diseased. The number of hives examined was 731, of which 591 were healthy and 140 diseased. In the Keswick district 56 per cent. of stocks inspected were found diseased in 1901, compared with 20 per cent. in 1902. On account of the large increase of new membership in other parts of the county, and new centres of disease discovered, it is impossible to compare percentage for other districts.

Eleven lectures were given.

It was decided to employ a second expert, and to give cash prizes for honey at Carlisle, Penrith, and Gosforth shows.—GEORGE M. SAUNDERS, Hon. Sec.

## Correspondence.

*The Editors do not hold themselves responsible for the opinions expressed by correspondents. No notice will be taken of anonymous communications, and correspondents are requested to write on one side of the paper only and give their real names and addresses, not necessarily for publication, but as a guarantee of good faith. Illustrations should be drawn on separate pieces of paper. We do not undertake to return rejected communications.*

### NOTES BY THE WAY.

[5102.] The month of April, which poets associate with "Sunshine and showers," may deserve its title in ordinary seasons; but the poetical has been very different from the actual experiences of 1903, and with the advent of May things apicultural here in Wessex have not much improved. We are certainly enjoying a higher temperature, but so much rain has fallen that our bees have no chance of reaching the rapidly-increasing breadth of pasturage. Saturday (the 2nd) was fine and bright during part of the day, and never have I seen bees more busy gathering in a supply of food. The enforced idleness of the past month will, I fear, be apparent when the honey-flow comes a month hence, and those bee-keepers who have endeavoured, as far as possible, to supply their bees with needful requirements for the growth of colonies, will again be to the fore with stocks ready to take to the supers as soon as there is honey obtainable outside to put in them.

"After thirty years!" What a vast number of incidents have happened in the British bee-world since 1873. Those who formed the

vanguard of the craft in the long distant days have either fallen by the way or are unable through increase of years to still carry the flag or plant it higher year after year, and cry "Excelsior!" The past volumes of B.B.J. chronicle the onward march of the industry, and contain many tributes to the worth of our veterans who have "passed the bar." To those amongst readers of our journal who have subscribed from its first issue the intervening years have passed as a swift post; to myself it seems but as yesterday when the letters appeared in the *English Mechanic* from bee-men advocating the establishment of a bee-journal.

Feed, feed, feeding has been the order of the past week or two. The candy-cakes have been superseded by the syrup-bottle, and extra wraps given to keep out the cold. Many of the intrepid little workers, whose instinct sent them forth in quest of pollen, never returned to their homes. The cold, biting, chilling, wintry blasts of April threw them down on the ground, and they became so benumbed that they were unable to take wing again. I saw hundreds, heavily loaded with pollen, strewn on the highway near my apiary (I mused on the light heed that nature takes of the suffering of any of God's creatures), as I mentally bewailed the loss of so many useful little lives cut short while doing their duty to the community to which they belonged.

The time for entries for the "Royal Show" is with us again, and from correspondence that has reached me I gather that the "Royal" is shorn of its unique position and its prizes reduced, if not to a parochial value, at least to a district value, comparing them with previous years and their national value. I hope the alterations have induced bee-keepers of the many districts to compete in goodly numbers, so that the B.B.K.A. may be recouped for their endeavour to meet, if not stultify, the loud complaints of those who in previous years thought or considered themselves handicapped in having to compete with the whole of the kingdom. Referring to the letter of "J. M. E." (5086, page 154) on bees perishing in "combination hives," I would say strong colonies are the goal of our work and hope, and in the careful painstaking bee-keepers' hands are the rule rather than the exception, and after my many years' practical experience of the long or "combination" style of hives, I have year after year had my strongest colonies in these hives; hives containing twelve standard-sized frames boiling over with bees ready to take to the supers as soon as put on at the beginning of the honey flow; hives that have many times required a second rack in a few days, and sometimes two racks under the first in less than a week, to prevent swarming, when we have had a good honey-flow. I have hives the register of which shows good or extra good results from 1889 to 1902, and if the simple

device of laying little strips of wood across the tops of frames is adopted when packing down for winter, no seams of dead bees will be found starved because they cannot reach the stores, if such be in the hive. Another simple device for winter passages is the fixing a ferule of tin in a hole cut in the top portion of the brood-comb. Bees will not fill these holes with either wax or propolis, so that there is always a passage-way for them through these combs; but if holes are cut without putting in the tin they are soon filled up, or are used by the bees as positions for queen-cells early in the season, and thus induce the swarming fever, and possibly lose the season for the bee-keeper.

The weather has been so cold up to time of writing that the usual spring cleaning of hives has been postponed till favourable weather arrives. We hear of losses amongst cottagers who still use the skeps, though, I am sorry to say, the cottagers who keep bees are yearly decreasing in numbers. The past twenty years of modern bee-keeping and its teachings, either by van, school, or village-green lectures or demonstrations, have fallen on deaf ears so far as the country cottager is concerned; possibly if bees were stingless and would store their honey in a tin in the hives, with a tap so that the cottager could draw it off for consumption without any trouble, we may see a larger number keeping bees. I admit their plea that there is no demand for or sale of honey in crocks as in years gone by, also that "these gents what lectures" says as how our honey is not so good as the honey from the new-fashioned hives. These are stock phrases, and I have no doubt true.—W. WOODLEY, *Beedon, Newbury.*

### SECTION-FRAMES.

[5103.] The question of the suitability of the square ( $4\frac{1}{2}$  in. by  $4\frac{1}{2}$  in.) section is one that, like the "frame," appears to have become a stock subject for discussion. Whether the tall section so ably championed by the Rev. Mr. Lamb will seriously affect the position of its elder brother remains to be seen, but in any case this principle of a thinner comb for super-honey is one that requires some consideration. It is well-known that during "glut" seasons bees will store honey in almost any receptacle; but, taking one year with another, it is evident that the best results are to be secured by working with such supers as are found to be best through all the vicissitudes of our widely varying seasons. It is also a fact that during a short honey flow shallow-frames will be filled and completely sealed, while sections are left unfinished; the superiority of the shallow frames over the "puzzle boxes" may be owing either to the thinner combs or to the bees being able to cluster in greater numbers on the larger comb surface. But when it comes to marketing, the shallow-frame is at a dis-

advantage, customers apparently preferring to have their honey in small pieces rather than in large combs that once cut are continually messy until finished. There has been some comment over the rather ingenious way in which the Rev. Thos. Adams got over this difficulty by fixing up his frames so that they could be sawn in halves when filled by the bees.

I wonder how many bee-keepers have heard about the recently-invented section frames? With the exception of being close-ended, they are very similar to the ordinary shallow-frame, and are equally suitable for extracting; but when intended to be sold as comb-honey, by means of a simple arrangement which causes no obstruction to a free passage over the entire comb surface, the bees are made to store the honey in three separate divisions, any of which can be cut out without interfering with the others.

Last season was, perhaps, a record one in the north for badness, the securing of surplus being beyond the genius even of your contributor "D. M. M.," and matters were very much the same here in most cases, the net result of the season's campaign being in most apiaries the securing of a quantity of worked-out combs. And yet in an apiary not far away the bee-keeper, by using the section-frames mentioned, secured quite a good surplus of well-finished heather honey.

I have obtained a quantity of the new frames and intend giving them a fair trial against sections, and hope by end of season to send along comparative results.—J. M. E., *Ussie Valley, N.B., April 28.*

### BUILDING UP STRONG STOCKS.

#### A COMPLAINT AGAINST FAULTY HIVES.

[5104.] One of my three hives is in splendid condition at present, mainly, as I think, owing to a visit to the heather last year. The contrast between it and others which did not go is very striking, and is a forcible argument in favour of the extra trouble entailed by sending away, for even if the heather honey-harvest turns out a poor one, the result is shown by having a good strong stock ready for early work. What I am a little uncertain about now is whether to try and get some sections of fruit-blossom honey, or to add more room for breeding? My bees are in the midst of plenty of pear and apple trees, which are only just commencing to blossom with us, so that with first the early and then the late kinds, it should keep the bees humming merrily for the next three or four weeks if the weather is favourable. My short experience teaches that the weather never has been so as yet, but the bloom is later this year, and "hope springs eternal." If I decide on the plan of allowing more space for ovipositing, instead of making an effort to secure early sections, I thought of giving a box of twelve shallow-

frames of drawn-out comb underneath the present brood-nest of a non-swarmling hive. Do you think this the best arrangement? On the other hand, could I work in standard frames in any way? The bees are practically covering ten frames at present, and I do not desire to increase my stocks. The real harvest, which is principally clover, does not start for another five or six weeks yet, so that there is plenty of time to build up a very strong stock.

I occasionally see mentioned in your pages complaints of hives sent out by well-known makers, and have myself a serious cause for complaint. I bought a 24s. hive from a well-known firm last year, which was wretchedly put together. The body-box barely takes in the frames, leaving no room for the passage of bees between the hive side and frames. The entrance-slides allow bees to pass in and out at the corners, and robber-bees can readily pass in between hive extensions, while a "Wells" division board was too deep, the breadth of the top-bar rendering it useless. And all this from a firm who take plenty of prizes for the best made hives, and for a hive at a reasonable price. I wonder what their cheap hives are like. I have four hives, all from different makers, each cost over £1 and carriage, and there is not an entirely satisfactory hive among them. I consider it disgraceful, and feel very much aggrieved. Enclosing my name and address, while signing—*XENOPHILUS, Whitehaven, May 2.*

[With regard to trying to get sections filled from the first bloom in May, we should give up that idea so far north as Cumberland. The same may also be said on the question of giving standard frames below brood-nest to prevent swarming. We should be content to give the dozen shallow-frames of worked-out comb, and not be in too great a hurry to do this unless the brood-nest is examined and found to contain six or more combs of brood. The non-swarmling chamber will be useful when room for ovipositing is really needed, but to use it now would retard brood-rearing instead of increasing it.

We cannot understand your complaint of badly-made hives being so common as would be inferred from details given above. They are contrary to our own experience, and we would be glad of a private line for our own satisfaction (not for publication) in order to enable us to understand who are meant by "prize-winning firms."—EDS.]

### AN EARLY SWARM.

THE FIRST RECORDED FOR 1903

[5105.] I think the readers of the *B.B.J.* will be interested to hear that Miss E. Black, Red House, Ufford, Woodbridge, had the pleasure of hiving a very strong swarm of bees, which issued from the hive belonging to her on Saturday, April 25. To-day, May 2,

whilst touring through Suffolk, I had the pleasure of seeing it working vigorously on six nearly drawn out combs.—A. W. SALMON, Essex and Suffolk Bee-keepers' Association, *Saxmundham, May 2.*

(Correspondence continued on page 186)

### HOMES OF THE HONEY BEE.

THE APIARIES OF OUR READERS.

It is very gratifying to illustrate a "Home of the Honey Bee" like that of Mrs. Wotton seen on next page, along with the experiences of a lady bee-keeper of a so decidedly practical type as the owner thereof. The "notes"—sent at our request—need no addition from us, they are in themselves an object-lesson in bee-keeping which lady readers and the wives of bee-keepers of the sterner sex may well take to heart.

"The fact that so few of the 'Homes of the Honey Bee,' as illustrated in our *JOURNAL*, belong to lady bee-keepers has often been a surprise to me. In looking over last year's volume of the *Record*, I find the proportion is one lady to twenty-two gentlemen. Why this should be I cannot understand. Are there really so few of us, or do our lady friends not care to let it be known what they can do?

'However this may be, I enclose two photos of part of my apiary, taken by an amateur friend. It was impossible to get all the hives into one picture, for, as will be seen, they stand in the backyard of a cottage, and are surrounded on all sides by walls or high trees.

"Amongst the numerous occupations that have of late years been open to women, surely bee-keeping is one of the pleasantest, and to those of us who reside in rural districts, not by any means the least profitable, if we bear in mind the small amount of time necessary for the work required, taking the year through. If, therefore, a few words from an old hand like myself is likely to be an inducement for any younger member of my own sex to start bee-keeping, or encourage those who have made a beginning, I shall feel only too pleased to have been of some little service, should you think well to publish the following particulars:—I am a gardener's wife, and in the year 1869 I had put into my hands 'Pettigrew's Handy Book of Bees' and this book first brought the subject of bees under my notice. Up to that time I should have hesitated in deciding between a bee and a wasp if shown both, but through studying 'Pettigrew,' along with other bee literature, I was fired with enthusiasm, and having purchased two swarms in straw skeps, I resolved to become mistress of the art. My resolve was perhaps a little strengthened because of the jocular predictions of gentlemen friends, who all prophesied the speedy collapse of my new venture. The 'collapse,' however, has still to come, for as you see from the date of

my start, more than thirty years have passed, and I have not given up yet.

"As a matter of fact, I made steady progress for the first few years, and soon gave up the straw skep for the bar-framed hive and other appliances for modern bee-keeping, and by thus keeping up-to-date I soon became a successful exhibitor at several local shows. I also gradually increased my stocks until they numbered twenty, but for the past few years I find twelve to be quite as many as time or strength allows me to manage properly.

"When I say that I have taken as much as 500 lb., and seldom less than 300 lb., of good honey in one season, and sold it all in 1-lb. jars, you will, I hope, acknowledge that I have worked successfully, for everything has

"I attribute much of my success to the fact of having made it a rule to try and keep the bees healthy by giving every hive and colony a thorough spring-cleaning. I start this about April, and begin by transferring the bees and combs into a clean hive, after scraping top-bars of frames and removing all propolis, brace-comb, &c.; then the hive from which the first lot were taken undergoes a thorough scrubbing with soft-soap and soda. If time permits, a coat of paint is given to the outside. It is then ready for the next stock; and so I go right through the apiary in this way, not omitting to slip a few bits of naphthaline into each hive, and always clipping a wing of the queen if I chance to see her. I never leave the bees without a cake of candy during the



MRS. J. WOTTON'S APIARY, WIDMERPOOL, NOTTS.

been done by myself, without the least assistance from any one, except when a swarm issued and clustered high up beyond my reach; for—in spite of all my endeavours at prevention—the bees sometimes would swarm. If they settled within reach, I always hived them myself; but they more often chose to fly high in the air, and cluster on a topmost branch of one of the tall trees around us, and, of course, I have been obliged to ask some friend to bring the bees down for me. Had I my time to see over again, I would adopt the new non-swarming hives, which are so much talked of, and thus remove what I have always regarded as the only drawback to my bee-keeping; but my old hives—all good ones—are still serviceable and will last my time.

winter months, whether they have enough honey stored or not, and I find they always take it. My bees are invariably healthy, and it has been my good fortune never to have seen foul-brood.

"As swarming time approaches, any stocks that are not exceptionally strong are united after dredging the bees with flour, which makes the task quite easy. This done, they are soon all ready for supering. When the inflow has started, I chiefly use shallow-frames for extracting, but work one or two hives for sections only.

"With regard to disposal of the honey crop, I have never had the least difficulty in selling all the honey I could get—indeed, could always sell more; have never kept any

from one year to another; but, then, no pains are spared to put the honey on the market in attractive form and thoroughly ripened. Last, but not least, I charge only a fair selling price.

"I am not without hope that my experience may be of some service in drawing the attention of ladies to the subject of bee-keeping, and, although none of us may reach perfection, we may—if suitably situated, and determined to work earnestly and intelligently—depend on some profit, and will most certainly derive great delight from this soul-inspiring and intensely interesting study of that industrious little labourer, the honey-bee.

With good wishes for a prosperous season in 1903 to all fellow bee-keepers."

### CORRESPONDENCE.

(Continued from page 184.)

#### CARNIOLAN BEES.

[5106.] Since the publication of my article in your issue of April 16 (page 164) I have received so many inquiries that I cannot possibly answer all. You would, therefore, greatly oblige me by inserting the following particulars relating to Carniolan bees. I can assure inquirers that the Carniolan is the gentlest of all bees; they cling well to the combs, are very industrious, and winter well. The hives in which they are kept in Carniola are almost exclusively simple shallow-boxes, 10 in. to 12 in. broad, by 4 in. to 5 in. high, and about 2 ft. long. They have no frames, the combs being attached to the roof or lid, which latter is nailed down. This small and faulty hive has tended to develop the swarming habit, but this tendency to a great extent disappears in the roomy modern hives, and by judicious treatment. The Carniolan bee, owing to its gentleness, may be specially recommended to beginners and ladies.

While somewhat resembling the black bee in appearance, each segment of the abdomen is edged with a distinct grey stripe, but when the bees are old and have lost the pubescence or hairiness, the grey rings disappear.

According to Root's "A B C of Bee-Culture," they are a variety of the black bee, but even if similar in appearance, they are quite different in habit and character. I send a great many queens to various parts of Germany, and it was very surprising to me when selecting colonies for breeding purposes to find nearly always more or less of individual bees with the first segment coloured much in the same way as the Italian. If only single bees marked in this way were shown, they would at once be pronounced Italian hybrids. I cannot account for this curious thing. I have bought Carniolans in regions where an Italian bee had not been introduced for many years. Whether it is due directly to Italian blood or to a tendency to "breed back," as the

saying goes, I cannot say. Some of the queens are as dark in colour as those of the ordinary black bees, while others are leather-coloured, like many pure Italians. At present I am unable to say whether there is any connection between the hybrid-markings referred to and the colour of the queens. I expect to devote some attention to this question of colour during the summer, and may give my observations later on.

I would also be allowed to inform the British bee-keepers that I cannot fill orders for queens of my own breeding before June, and will notify when ready for delivery through the JOURNAL.

At present I can only supply queens from imported colonies, carefully selected, but with no other guarantee than safe arrival—J. A. HEBERLY, *Weisweil b. Erzingen, Baden, Germany, April 21.*

### WEATHER REPORT.

WESTBOURNE, SUSSEX.

April, 1903.

Rainfall, 2.39 in.	Minimum on grass, 17°, on 18th.
Heaviest fall, .75, on 28th.	Frosty nights, 10.
Rain fell on 11 days.	Mean maximum, 51.1°.
Above average, .75 in.	Mean minimum, 36.2°.
Sunshine, 175 hours.	Mean temperature, 43.6°.
Brightest day, 8th, 11 hours.	Below average, 2.4°.
Sunless days, 3.	Maximum barometer, 30.48°, on 18th.
Below average, 17.2 hours.	Minimum barometer, 29.40°, on 29th.
Maximum temperature, 57°, on 8th and 29th.	
Minimum temperature, 25°, on 18th.	

L. B. BIRKETT.

## Queries and Replies.

[3079.] *Transferring from Skeps to Frame-Hives.*—I began bee-keeping last year, and now have two colonies of Carniolans. The other day I had the gift of three colonies in skeps, and am anxious to transfer them to frame-hives. So I write to ask:—1. If I may transfer them at once according to directions in the "Guide Book"? 2. I presume the colonies ought to be examined before transference. To do this, are the straw skeps to be inverted; and, in the meantime, is an empty skep to be placed on the stand to receive returning bees? When is the best time to examine them? 3. Being a novice, I should be extremely unlikely to detect foul brood in combs inside a skep. What do you advise? 4. When a skep is placed over a frame-hive for transference, how do you tell when the

bees have taken possession of the frames so as to remove the skep altogether? 5. Is it possible to take out combs from skeps, and fasten them inside frames till the brood is hatched out? I may add that in all the skeps, pollen is being carried in. I enclose card, and sign myself, "NEMO," Kent.

REPLY.—1. The time for transferring must be governed rather by weather than *dates*, and under this rule we advise no start being made during the prevalence of the present cold winds and generally adverse weather. You do not say if it is proposed to transfer on the old plan of cutting out combs of skeps, and tying them into frames of new hive, but we much prefer the alternative plan given in "Guide Book." With regard to queries numbered 2 and 3, the skeps must, in any case, be examined or judged by present conditions of prosperity and healthiness, and for this purpose it would be well to get help from some one with experience. 4. The skep must be raised to see if bees are working in lower hive, and frames of latter lifted to examine for eggs and brood. 5. Do not think of this; let the bees transfer themselves.

[3080.] *Queens Duplicating Eggs in Cells.*—On looking into one of my hives the other day, I noticed in several cells that there were two eggs in each. Is not this an unusual occurrence? If you can give me any information about this I will esteem it a favour.—J. B., *Laugholme, N.B.*

REPLY.—The duplication of eggs in cells is not at all uncommon, but does not often happen in hives managed by experienced beekeepers. It may arise from one of several, and greatly varying, causes, such as a prolific queen at the head of a weak stock, or queen getting aged and so worn out as to lose her alertness and anxiety to "get around"—as Americans say—as many cells as possible. Unmated queens too, when starting to lay, often deposit eggs irregularly in cells, sometimes two or more in each.

[3081.] *A Beginner's Various Queries.*—My wife and I, though beginners in beekeeping, have the fortune to be less fearful of stings than some of our more experienced neighbours, and have, in consequence, been called on to make a spring examination of several stocks of bees. Among them was one colony housed last year in an old sugar-box, and the bees have built a very pretty nest in the far corner of it. The box has no hole above which supers could be placed, and I am advising the owner to allow the bees to transfer themselves to a frame hive by modifying the process recommended for transference from skeps (see page 140 of the "Guide Book"). It will naturally be a rather awkward job to get the sugar-box comfortably fitted above the new hive, and so I ask:—1. Would it be well to remove them from it, and house

them in a skep until the grubs are hatched, and the bees properly established in the lower hive? Or would this method of transference be altogether inapplicable? A second colony is very strong in bees, but established on very old, black combs, in a very dirty hive; we separated the combs with great difficulty, and removed the scraps of brace-comb built between the outer edges of the frames and the walls of the body-box. 2. Was this correct? One whole frame was filled with drone-comb, and largely occupied with brood, and drone-brood occupied a conspicuous space on another frame of comb. I therefore ask:—3. Would it not be well to take the frame of drone-brood from the bees altogether, and melt it down for the wax? My third inquiry concerns two weak colonies in bar-frame hives—one old and dirty like the last, and infested with wax moth; the second in rather better condition, being a last year's swarm. The combs in the first are all black with age, but what brood there is seems plump and healthy. Many of the cells, once used for storing, are coated with a thin layer of white substance, which we take for mould. 4. Is there any means of getting rid of this? And, finally, would it be advisable to unite this colony with the equally feeble but somewhat less antiquated residue of the last year's swarm. Pray excuse me for asking so many questions at once.—BASIL DE SELINCOURT, *Chipping Norton.*

REPLY.—1. As the colony occupies only a corner of what we suppose is a good-sized sugar box, the method of allowing the bees to transfer themselves would hardly succeed, seeing that bees will only transfer their brood-chamber below when crowded for room overhead. If, therefore, you possess sufficient skill to cut the combs of brood away from the sugar box and tie them into frames with tape in the usual way, they might be transferred to a frame hive when weather is warm and settled. Failing the needful skill to carry out the latter plan we should advise reducing the size of the sugar box by some extemporised rough-and-ready plan, so that the bees would be induced to swarm early. Then twenty-one days later drive the bees from sugar box, and run them into a frame-hive fitted with full sheets of foundation. 2. Yes. 3. By all means do away with the superfluous drone comb; it is worse than useless. 4. The "white substance" will no doubt be mildewed or mouldy pollen. The bees will remove this if not too many cells are so affected.

[3082.] *Propolis as a Remedy for Curing Wounds.*—I remember it being mentioned in the BRITISH BEE JOURNAL about propolis being an excellent remedy for curing wounds, and a preventive of blood-poisoning. It was also again mentioned some time back as being used in the last war with good results, besides being used for "foot and mouth" disease in cattle. In view, then, of the usefulness to

bee-keepers to know something further about this, some details of the method of making the same would be much valued by readers. I might also ask: Would propolis scraped from the frames of a diseased stock be injurious to wounds, or would the preparing of same destroy germs?—R. A., *Salop*.

REPLY.—We have no special knowledge of either the curative or antiseptic value of propolis; but with regard to the mention of it in the B.B.J. to which our correspondent refers, it appears on page 98 of our issue of March 5 last, in "Gleanings from Foreign Bee-Papers." The extract there given is from a German bee-paper, in which mention is made of "propolisin," a preparation extracted from propolis, said to possess all the valuable properties attributed to it. It is, however, obviously quite beyond us to give any "details" of its manufacture. On the other hand, we should have no fear with regard to propolis from hives affected with foul brood having any deleterious effect on human beings.

[3083.] *Making the "W.B.C." Section-rack, and a Super-clearer.*—Will you please give me through the B.B.J. the full particulars and dimensions how to make a "W.B.C." section-rack and also a super-clearer?—J. J. II, *Trimdon*.

REPLY.—The "particulars and dimensions" necessary for making the appliances mentioned, not being printed and available, we cannot furnish them, while the task of preparing such a reply to a query is obviously out of the question. The section-rack referred to is, however, described and illustrated on page 54 of "Guide Book," and this would, no doubt, greatly assist in making the appliance; but the purchase of one from a good maker would fully serve the purpose and prove the need for a pattern to work from. The same may be said of the super-clearer shown on page 63 of the same book.

[3084] *Bees Deserting Skep in Winter.*—A bee-keeping friend the other day asked if I could explain why his bees had deserted a skep-hive in which they were strong and vigorous in October last. He thought the stock was all right, but not seeing any bees about one fine day in February, he lifted the skep, and there was not a bee to be seen, though the hive was clean, and contained about 14 lb. of beautiful honey. It was packed up warm, and everything put in order for safe wintering. Not being able to explain the cause of bees deserting, I will be glad if you can give any cause or reason for same, and oblige my friend and self.—T. R., *Tamworth, Warwickshire, April 30*.

REPLY.—The most probable cause of desertion would appear to be loss of queen. If the skep in question threw off a swarm, and the succeeding queen got lost on her mating-trip, the bees would linger on in a condition of queenlessness, then, during the past late

autumn, would likely desert their skep and join on to a contiguous stock in same apiary.

[3085.] *Bees Collapsing in May from Want of Food.*—As a three years' subscriber to your JOURNAL, I should be glad of your opinion on sample of comb enclosed. I may say it was cut from a hive found in a state of collapse from starvation, not a scrap of stores in comb, and only a patch of brood in two combs—same as sample—and nearly the whole of bees dead.—NOVICE, *Warwickshire, May 1*.

REPLY.—Clearly a case of death from famine. The brood, though dead, is perfectly normal, and no trace of disease.

[3086.] *Drone-brood Found in Worker Cells.*—As a new beginner and subscriber to your valuable journal, I write asking your opinion on the following:—In the autumn of last year I purchased a stock of bees, which have been doing allright until the last two or three weeks, when, on examining the frames of comb, I found nothing else but drone brood in worker cells, and the same thing continues, although there is still a good stock of bees in the hive. I mentioned this to a bee-keeping friend, who suggests that the queen must have been ruptured. I bought another hive stocked with bees a week ago, and have moved them about a mile or so away from where they previously stood. On the following day hundreds of bees were seen crawling about the garden, which I picked up and put on the alighting board, but they would not go into the hive, and, of course, perished. Seeing I had lost so many bees out of the new hive I thought it might be advisable to unite the two together, and therefore ask your advice in B.B.J. on the following:—1. What is the cause of drone brood being bred in combs of worker cells? 2. Is there any remedy for same? 3. What can be the cause of so many bees crawling about on the ground after the hive was removed? 4. Would it be advisable to unite the two? Thanking you in anticipation.—R. A. R., *Carlisle, May 4*.

REPLY.—1. The most likely cause is that the original queen has been lost or killed early in the spring, and a successor reared at a time when mating was impossible. 2. None other than removing the unmated queen and replacing with a fertile one. 3. No doubt the jolting and disturbance during removal of the hive has caused many of the young recently hatched bees to leave the hive when not strong enough on the wing to fly well, and they have got chilled on the ground. 4. Either unite both stocks or re-queen the first-named.

[3087.] *Hives with Cross-built Combs.*—Can you give me any help in the following difficulty:—I have an old frame-hive with fixed floor, and there are in it only four frames. The remainder of space the bees have entirely filled up with comb, so that it is impossible to move the few frames in the hive. There is plenty of sealed stores, but



the trouble is:—1. How can I get the bees into a new hive, and when is the best time to do it? I also possess another frame-hive, and during the past winter a lot of the bees have died in the cells, so I ask:—2. Can the other bees clear their dead comrades out, or are the combs containing them useless? I might say they are nice straight combs. I send name and address while singing myself  
*INDUSTRIOUS, Strood, Kent.*

REPLY.—1. If the four frames of comb contain brood, and the queen fortunately happens to be on one of them, you might cut away or sever any attachments that connect them with the immovable combs, and place the frames, bees, and queen in a new hive. The latter must then be put on the old stand; the bees left in the old hive will return to the old location and rejoin the queen and bees in the new hive, which should have remainder of its frames fitted with full sheets of foundation. Defer operations till weather is warm and settled. 2. If cells are full of dead bees, we would either pull the bodies out with tweezers or melt the combs down for wax rather than inflict the interminously heavy task of removal on the poor bees. If only a hundred or so require removal, the bees might be left to do the work, but not otherwise.

[3088.] *Practical Value of Swarm-Catchers.*

—1. Might I ask you to give me your opinion on the "swarm-catcher," or, if this is a too definite question for publication, tell me what there is for and against swarm-catchers in general? I presume from the fact that, as far as I can find, no mention is made in the "Guide Book" of this appliance, that its disadvantages outweigh the great advantages that such an appliance, if efficient, would be to the many bee-keepers who are away from home the greater part of the day. 2. Would narrower spacing, effected by pushing back the "W.B.C." ends of alternate frames, have any effect in decreasing the tendency to swarm and would the present time be right for doing the same?—C. G. S.,  
*South Norwood, May 4.*

REPLY.—1. There can be no question as to the usefulness of swarm-catchers if they effectually serve the intended purpose, nor is the non-mention of the appliance in the "Guide Book" to be taken, as presumed by our correspondent. It is a new invention still in the trial stage, and once a reliable and effectual "catcher" appears it will, no doubt, be brought to notice as prominently as need be. 2. Narrowing the spacing of frames as stated would not, in our opinion, have the desired effect, and might possibly tend to increase the chances of swarming.

#### TRADE CATALOGUES RECEIVED.

ABBOTT BROTHERS, *Southall, near London.*

—While retaining the special features of their former catalogues, Messrs. Abbott have in

new list for 1903 introduced several important novelties, the most recent of which is a hive roof claimed to be "absolutely water-tight." The firm have also made a special feature of their glass honey-jar trade, a full list of these being described and finely illustrated. Altogether, the list before us is full (seventy-two pages) and complete in all respects, embracing every requirement for the use of bee-keepers. It also includes a replica of the catalogue of the late firm of Geo. Neighbour & Sons, whose business in High Holborn was purchased a few years ago by Messrs. Abbott, and is now removed to Southall.

JAS. LEE & SON, 10, *Silver-street, High Holborn, 4, Martineau-road, Highbury, London, and Monk's Acre Apiary, Andover.*—Messrs. Lee's Catalogue for 1903 is entirely revised and brought up to date. There are few lists of bee-goods which include so many specialities and original articles of the makers' own designing as the well-illustrated one before us. Among the specialities for 1903 is the "R. H. Smith" super-clearer, designed by a Canadian bee-keeper, for removing bees rapidly from surplus-chambers. This appliance possesses something far above mere novelty, and we predict for it a good demand as being a marked improvement on the Porter escape where a good number of hives are kept. No item of real use to bee-keepers is omitted from Messrs. Lee's list.

J. T. BURGESS & SON, 10 & 11, *Guinea-street, Exeter.*—This old-established firm have now gone in thoroughly for the bee-appliance trade on a large scale. Their catalogue for 1903 is a compactly-got-up one of thirty-six pages, in which the business arrangements are very complete—a fact which customers will appreciate as conducing to safe delivery, cost of carriage, and many useful particulars. The goods are evidently all of good type and make, and bear evidence that the firm have spared no trouble in making every appliance as efficient for the purpose as may be.

W. H. C. THURMAN & Co., *Friary Mill, Dorchester, Dorset.*—Messrs. Thurman are new to our pages as manufacturers of bee-goods; and judged by their excellent and well-got-up list, they intend to make a bold bid for the favour of bee-keepers. The methods of doing business are such as commend themselves to buyers, and having a practical bee-keeper of many years experience at the head of the apicultural branch of affairs, reliable advice may be looked for by intending customers who may obtain queens, stocks, and swarms of English bees, along with all appliances for immediate use at short notice.

F. W. L. SLADEN, *Ripple Court Apiary, near Dover.*—Unlike our other advertisers, Mr. Sladen devotes himself entirely to the bee-business, having given up dealing in hives and appliances. Being not only a practical bee-keeper on a large scale, but a skilled ento-

mologist, and possessing exceptional knowledge of all known races of bees, it will be seen by a perusal of his list wherein lies the value of dealing with a specialist in the subject. Those who desire to possess queens carefully bred from selected parents will therefore do well to get the list in question. A novel feature of Mr. Sladen's business is that of sending out mounted specimens—in a neat case—of the several strains and varieties of the bees reared in his extensive apiaries in Kent. Mr. Sladen evidently attaches more importance to quality than initial cost, relying on the ultimate results for proving his contention.

## Bee Shows to Come.

A nominal charge of 2s. 6d. is made for notices in this column, which covers cost of insertion from order till date of show. Cash should accompany orders for insertion.

**June 9 and 10, at Bishop Stortford.**—Annual Show of the Essex Agricultural Society. Bee and Honey Section under the management of the Essex and Suffolk Beekeepers' Association. Classes open to the United Kingdom. Schedules from Mr. W. J. Sheppard, King's Head Hill, Chingford. Entries close **May 15**.

**June 23 to 27, at London.**—"Royal" Agricultural Society's Show. Bee and Honey Section under the management of the B.B.K.A. Increased prizes for B.K.A. Associations as arranged in divisions or groups of counties. Schedules from Edwin H. Young, Secretary, 12, Hanover-square, W. Entries close **May 15** (without extra fees).

**July 22 and 23, at Cardiff.**—Honey show of the Glamorgan B.K.A., in connection with the Cardiff and County Horticultural Society. Bees, hives, honey, trophies, wax, appliances, and articles of food. Substantial money prizes and medals. Free entries. Six open classes. Schedules from William Richards, Gabalfa, Cardiff. Entries close **July 16**.

**July 29, at Wallop, Hants.**—Honey Show of the Broughton and Wallop Branch of the Hants and Isle of Wight Beekeepers' Association. Two open classes for single-section and 1 lb. jar respectively (entry free). Schedules from Miss Tucker, The Lindens, Broughton, Stockbridge, Hants. Entries close **July 22**.

**July 30, 31, and August 1 and 3, at Old Trafford, Manchester.**—Annual Show of the Royal Lancashire Agricultural Society. Liberal money-prizes are offered for honey along with silver and bronze medals of the B.B.K.A. and also of the Society. Open classes for Honey-Trophy, Sections, Extracted Honey, Beeswax, Honey-Confectionery, Bee Flowers, Instructive Exhibits in Bee-Culture, &c. Schedules from Edward B. Hane, Secretary, Miller-arcade, Preston. Entries close **June 30**.

**August 4 at Leamington.**—Tenth annual show of the Leamington St. Mary's Horticultural Society. Three open classes for Six 1-lb. Sections, Six 1-lb. Jars "Light," and Six 1-lb. Jars "Dark" Extracted Honey, respectively. Liberal money prizes. Schedules from P. W. Smith, Secretary, 22, Leam-street, Leamington. Entries close **July 30**.

**August 6, at Nantwich.**—Honey department of the Cheshire Agricultural Society's Show under the management of the C.B.K.A. Numerous classes for hives, honey, and wax. Money prizes and medals. Schedules from T. A. Beckett, St. Werburgh's Chambers, Chester.

**August 6, at Kingsthorpe, Northants.**—Honey show of the Northants B.K.A., in connection with the Horticultural Society's Exhibition. Three open classes with special prizes including one for single 1-lb. jar of honey. (Entry free) Prizes 20s., 10s., 7s. 6d., and 2s. 6d. Schedules from R. Hefford, Hon. Sec., Sunnyside, Kingsthorpe, Northampton. Entries close **August 1**.

**August 12, at Radstock, Bath.**—Honey show in connection with the annual show of the Radstock and District Horticultural and Fanciers' Association. Schedules from the Secretary, B. M. Clark, 1, Fox Hills, Radstock, Bath.

**August 27, at Llangollen.**—In connection with the fifth annual Flower Show. Open classes for Six 1-lb. Sections, Six 1-lb. Bottles Extracted Honey, and Beeswax. Schedules from Frank Little, Castle-street, Llangollen. Entries close **August 13**.

**August 27 at Montgomery,** in connection with Montgomery and District Horticultural Show. Open classes for Six 1-lb. Sections and Six 1-lb. Jars Extracted Honey. Prizes in each class 10s., 5s., 2s. 6d. Entrance-fee 1s. each. Schedules from W. J. Jones, Secretary, Montgomery. Entries close **August 20**.

## Notices to Correspondents & Inquirers.

Letters or queries asking for addresses of manufacturers or correspondents, or where appliances can be purchased or replies giving such information can only be inserted as advertisements. The space devoted to letters, queries, and replies is meant for the general good of bee-keepers, and not for advertisements. We wish our correspondents to bear in mind that, as it is necessary for us to go to press in advance of the date of issue, queries cannot always be replied to in the issue immediately following the receipt of their communications.

All queries forwarded will be attended to, and those only of personal interest will be answered in this column

\* \* A subscriber to our monthly, the *Record*, requests us to insert a line asking if any reader of the B.B.J. can oblige him with a clean copy—for binding—of the *Record* for January, 1902. The number referred to is out of print, and cannot be had through the ordinary channels, but any reasonable price asked will be paid for one.

J. A. B. (High Wycombe).—*Questionable Bee-Food*—We should be sorry to offer such "stuff" as sample—whatever it may consist of—to bees as food, and advise its being promptly thrown away.

### Suspected Combs.

"CANDY" (Norwich).—No. 1 sample has no trace whatever of brood—foul or otherwise—in cells. The sealed cells contain honey (or syrup) only. No. 2 is very badly affected with foul brood. So bad is it that the comb should be at once destroyed and all combs, frames, &c., burnt.

"REGULAR READER" (Suffolk).—Foul brood rapidly developing in comb sent. For the safety of contiguous healthy stocks we advise destruction of the affected colony.

T. W. (Maidstone).—Comb is very badly affected with foul brood.

"INTERESTED" (Cambs).—Both samples of comb show foul brood, No. 2 being badly affected.

INQUIRER (Hull).—In view of what we said last week there is little use in keeping the stock hanging on; it will be best to destroy the bees and combs as not being worth taking farther trouble over.

\* \* \* Some Letters and Queries are unavoidably held over till next week.

## Editorial, Notices, &c.

### THE "ROYAL SHOW FUND."

The following additional contributions to the above Fund are hereby gratefully acknowledged :—

	£	s.	d.
Amount as per previous list	19	11	6
H. Jonas .....	1	0	0
A Friend .....	1	0	0
Richard Allen .....	0	5	0
E. H. Taylor .....	0	5	0
G. H. Lander.....	0	2	6
Wm. Challis .....	0	1	0
<b>Total .....</b>	<b>£22</b>	<b>5</b>	<b>0</b>

EDWIN H. YOUNG, Secretary,

12, Hanover-square, London, W.

May 12, 1903.

### "MODERN BEE-KEEPING."

A HANDBOOK FOR COTTAGERS.

The new edition of the above useful little handbook has been thoroughly revised and brought up to date in all respects. Among the new features are several good half-tone block illustrations, including an excellent portrait of the Baroness Burdett-Coutts, President of the British Bee-keepers' Association. We also note a new chapter on "Wax Extracting," and one on "Working for Heather Honey," written especially for this edition. "Modern Bee-keeping" has always been a favourite handbook for cottagers and artisan bee-keepers, and the ninth edition will no doubt meet with equal favour as its predecessors. We heartily commend it to all bee-keepers who do not seek a more comprehensive work on the subject.

### HOME COUNTIES NATURE-STUDY EXHIBITION IN 1903.

An influential committee has been formed, with Lord Avebury as chairman, and the following communication commends itself to the notice of readers as a subject closely connected with bee-keeping, and one in which the industry might well take a prominent place in the proposed exhibition. Lord Avebury was formerly President of the British Bee-keepers' Association, and is known to be still interested in bee-keeping, as are also several other members of the Committee. Therefore, if the scheme drawn up by the Committee includes exhibits of bees and appliances it might be well worth notice from those concerned with the pursuit of apiculture as a favourable opportunity for

bringing bee-keeping to public notice as a Nature-study in its best sense.

To the Editors, BRITISH BEE JOURNAL.

SIRS.—The association which he'd the very successful "Nature-study Exhibition" last year was organised for that purpose alone, and has been dissolved. It suggested, however, in its official report, that the movement with which it was so prominently identified could for the present be best advanced by local organisations, the activity of which it had already noted with satisfaction. In order, therefore, that the work may be continued in the South-eastern counties of England, which are more or less in touch with the Metropolis, and as an outcome of the efforts of delegated members of the "Middlesex Field Club and Nature-study Society" and the "Selborne Society," a Home Counties Nature-study Exhibition is being organised in London on definite lines, and will be held this year, it is hoped, in the gardens of the Royal Botanic Society at a time convenient to teachers.

On behalf of the Executive Committee, and as members of the Executive of the late Nature-Study Exhibition Association, we venture to bring the undertaking to your notice, and to intimate that after carefully considering the results and reports of last year's exhibition, the Committee has drawn up a scheme with schedules, which may be obtained from the Honorary Secretary, Mr. Wilfred Mark Webb, at 20, Hanover-square, W., who will gratefully receive all offers of help in the form of prizes, donations, subscriptions, and suggestions as to exhibits.

We sincerely trust that this effort to localise and to promote the nature-study movement, will meet with the ready sympathy and support of all interested in a branch of education so full of promise.—We remain, yours faithfully,

MARY GURNEY.  
FREDERICK OLDMAN.  
R. HEDGER WALLACE.  
WILFRED MARK WEBB.  
J. MARTIN WHITE.

20, Hanover-square, W.

### SURREY BEE-KEEPERS' ASSOCIATION ANNUAL MEETING.

The annual general meeting of the above Association was held on the 25th ult. in the County Hall, Kingston. In the unavoidable absence of General Sir Percy Feilding, K.C.B., President, Mr. W. Welch, C.C., was voted to the chair, the attendance including Messrs. A. Seth-Smith, F. B. White (Hon. Secretary), A. Dean, T. Gibbons, W. F. Reid, E. A. Stopford, W. Hampton, J. N. Hardingham, J. Kachler, J. H. Marsh, C. T. Overton, C. A. Overton, G. Anderson, E. O. Stephens, F. H. White, A. H. Miller, W. Sole, A. P. Harrison, and T. H. E. Watts-Silvester.

Letters regretting inability to attend were

read from Major E. F. Coates, Messrs. J. King, G. M. Walker, R. C. Blundell, and Rev. C. S. Rowland.

The Chairman, in moving the adoption of the report and balance-sheet, said the association was to be congratulated on another successful year. Referring to the annual show, which will again be held at the Crystal Palace on September 17, 18 and 19, the Chairman observed that the entries numbered 286 last year, which, compared with only forty at their first exhibition, showed a remarkable increase.

The report was adopted.

Mr. A. Seth-Smith proposed a vote of thanks to the County Council for the grant of £150 for carrying out certain educational work by the Association, and for the gratuitous use of rooms for meetings. In continuing his remarks, he said that although other associations had received grants, yet few yielded so excellent a result as the Surrey Association. He attributed their success to the energetic management of the affairs of the Association, of which their worthy honorary secretary was the mainspring.

Mr. W. F. Reid seconded, observing that some other councils spent more money on bee-keeping, but got nothing like equally good results as their Association.

The Chairman, in acknowledging the compliment, said the County Council were extremely well satisfied with the manner in which the money was expended, and the excellent results of the instruction imparted, which had always been recognised. It was due almost entirely to the exertion and energy of their Secretary, without whose help they could not have carried out the work to the satisfaction of the County Council.

A vote of thanks was accorded the retiring Executive Council, Joint Committee, and officers.

The following gentlemen were elected as the Executive Council for the year ending March, 1904:—Rev. C. S. Rowland, Messrs. Archibald Seth-Smith, F. J. Bernan, R. C. Blundell, W. A. Dawson, F. S. Fletcher, John Kachler, G. C. Halahan, J. W. Lewis, J. H. Marsh, A. H. Miller, W. F. Reid, W. Sole, E. A. Stopford, E. Walker, A. Watkin, T. H. E. Watts-Silvester, M.A., F.R.C.S., and F. B. White.

Discussion then turned on matters affecting the interests of bee-keepers, in the course of which Mr. White mentioned the annual show as being of great assistance to members in the disposal of their honey, one person having sold a ton of honey through the show, and received orders for more. Every one with honey to sell should therefore support the show, the expenses of which were of necessity specially subscribed by the members. He hoped the next show would be supported not only by financial assistance, but by members exhibiting their honey and produce. Mr. White also commended the use of the Association labels and advertisement cards, and announced

that the new council would consider the question of insurance.

The meeting terminated with a vote of thanks to the chairman for presiding.

## Correspondence.

*The Editors do not hold themselves responsible for the opinions expressed by correspondents. No notice will be taken of anonymous communications, and correspondents are requested to write on one side of the paper only and give their real names and addresses, not necessarily for publication, but as a guarantee of good faith. Illustrations should be drawn on separate pieces of paper. We do not undertake to return rejected communications.*

*\* \* In order to facilitate reference, Correspondents, when speaking of any letter or query previously inserted, will oblige by mentioning the number of the letter as well as the page on which it appears.*

### AMONG THE BEES.

#### "OUR JOURNAL."

[5107.] An industry such as apiculture requires some focus on which our thoughts can be concentrated, some centre which will act as a point of union, some pivot round which our views, acts, and results, may revolve. It is only by a constant and free interchange of opinion that we can discover what other apiculturists say, think, and do; and it is only by a constant interchange of views that we can find out when and where progress and advancement are being made. It is by suggestion on the one hand, and criticism on the other, that we can sift the wheat from the chaff; clearly distinguish between light and darkness, and eliminate what is worthless from what is of value. We can thus insure that we, too, can participate in the progress and advancement recorded from any part of the world, building up our knowledge on the only sure foundation of practical experience which has stood the test of criticism and trial.

OUR JOURNAL, more than anything else known to me, supplies such a medium for securing this usefulness and helpfulness, and must thus aid us in seeking and finding new ways and means of benefiting the craft. Its efforts are not personal or local, not for the good of any single individual or clique, but purely for the advance and betterment of the bee industry as a whole. It airs no personal grievance, seeks no personal gain, booms no special company or individual. Its motto is, *Excelsior!* upward and onward, so it sticks to no rut, but advances with the times; steering clear of ultra-conservatism on the one hand, and, on the other, avoiding all precipitate and ill-advised plunging into waters of unknown depth. All obsolete schemes, methods, and devices, are shredded off when better have taken their place; and, keeping pace with all that is newest and best, it seeks to push us all well up and abreast of the times. It is, thus, naturally and inevitably, the central point round which bee-men gather. With it as our rallying point we no longer feel ourselves out in

the cold, existing as isolated units, as we know that we have a bond of union, combining all bee-keepers from John o'Groats to Land's End in a common fellowship. We are made to feel, as far as bee-culture is concerned, that we are all brethren; and individually and collectively we can view each other, as I often see your correspondents love to describe it, *bee friends*, irrespective of nationality, rank, or degree—for the labourer, in your pages, is the equal of the lord, and his writings are as heartily welcome when they tend to the advancement of apiculture.

Primarily the aim of the JOURNAL is to elucidate, to investigate, to impart instruction, and thus to enlarge the sum of bee-knowledge. We can aid this by recording our doings and "thinkings." We see others submitting opinions with which we cordially agree; but often theories are promulgated contrary to our own individual ways of thinking and acting. These last stimulate us to think and ponder, and if they inculcate something good, which appears feasibly reliable, we investigate and frequently get "more light." We have thus recorded weekly the experiences of fellow-workers in all lines of the cult, and we can, for the mere trouble of reading what they write, reap the fruits of the wisdom derived by them from much thought and severe labour. By long testing in the school of practice, they save us often much toil and trying worries. Men from all parts of the country are thus brought into line, and become adepts in the best and newest devices discovered by experts in each section of the hobby. And not content with the latest in our own Islands, the JOURNAL puts the "world in tribute."

Novices have the rough places of apiculture made smooth and plain for them, and in the Socratic pages of the "Query and Reply" columns a long-suffering patience is displayed worthy of commendation. Time after time are those oft reiterated questions patiently answered, because, though to many they appear trivial, the presiding mentor of that department views them as real stumbling-blocks to beginners. The page devoted to honey sampling, by an expert of wide knowledge in the art, must prove a boon to many; and the foul brood column is a veritable blessing, not only to the inexperienced questioner, who is unable to diagnose the foul scourge, but to many others who are led to keep a wary eye on their brood-nests, and catch the pest in its initial stages, when prevention is more potent than cure. The strenuous efforts to secure a Bill for the suppression of this devastating demon are still fresh in the memory of all, and they may yet bear fruit in a consummation devoutly to be wished. Then have we not our new insurance scheme existing as an established fact?

And not only for what it does, but also for what it does *not* do, are we its debtors. How many rapid and meaningless contributions are we saved from perusing because they never

see the light? How many raving, rabid diatribes are dropped into the waste-paper basket? How many reams of "copy" loaded with virulent vitriolic venom have been suppressed and consigned to the flames? Only one can tell, and he keeps the secret closely locked up in the inner recesses of his own bosom. Our pages are thus saved from being likened to a bear-garden, where all could tear and rend, although all fair and legitimate criticism is made fully welcome. "Gutter" literature may find its place elsewhere, but not in the pages of the BRITISH BEE JOURNAL. Here are the words of the presiding genius:—"No contribution written in the public interest and couched in courteous language will reach the waste-paper basket, but all personality or scurrility will be carefully excluded." Long may this continue to be the rule guiding "the man at the helm" (W. B. C.), for any other course, sooner or later, would inevitably lead to the shoals and the quicksands, and end in wreck and destruction!

We may thoroughly rely on this high standard being maintained as long as its policy is guided by our Senior Editor, Mr. Cowan, whose personality is unique among bee-men, for it is not too much to say that no other single man holds an equal position in the apicultural world. Familiar with bee-keeping in all its phases, he also knows about it in nearly every part of the civilised world, not from simple reading, but from personal experience. He has handled bees in the African desert, all over the Continent of Europe, in the United States, and in Canada. His power as a linguist makes him at home everywhere, and he is known, honoured, and respected wherever modern bee-keeping is practised.—D. M. M., *Banff*.

#### TALL SECTIONS.

[5108.] In last week's JOURNAL (page 183), "J. M. E.'s" article headed "Section-Frames," puts the case for the newest sections neatly into a nutshell, and also lends valuable aid to the discussion by telling us (what is news to me) something about the "section-frames," and the good results secured by their use last year. I have for some time felt that North Britain, above all other parts of the Kingdom, should be eager to find out the best manner of harvesting heather-honey, because their seasons are generally short and the honey in comb is superior to that pressed out. Forward then, Scotland! May you reap the full benefit of improvements which your leaders may discover.

As our thoughts are in the Highlands, I cannot travel south before remarking on the extraordinary attitude of Mr. David Raitt towards any change as regards sections, in his notes under "Homes of the Honey Bee" in *April Record*. Extraordinary! because he is the son of one of the most open-minded and pro-

gressive bee-men of his day. Extraordinary! because in one sentence he modestly says, "I will not pretend to pose as an authority," and in another puts down his foot pretty firmly, "suffice it to say, the less innovation along that line (tall sections) the better in my opinion." But most extraordinary! because he seems unaware of the delicate ground upon which he is treading. Are appliance-dealers to dictate without giving a particle of reason what apparatus bee-keepers should or should not use? Is not this putting the cart before the horse?

As Mr. Raitt stated that business had claimed most of his time for the past six years, it was the more incumbent upon him to show that, at any rate, he had given the "tall sections" fair consideration by giving us a little of the how, when, &c., of his experiences. I would say I welcome the helpful observations of the youngest and humblest of bee-keepers, but to write "I might have enlarged on my experiences" does not move the argument an inch forward or backward: it only makes one's mouth water for more details. I trust, then, when the slack time comes round again Mr. Raitt will indulge us, and I hope to weigh and examine them carefully. For a particular reason they should be brought under the full force of the "Röntgen rays." I will add, in theory I agree with him that it would be wise to fix as "standard" any apparatus which has reached well-nigh perfection. But in practice it is often difficult to do so, because our ideas as to what is perfection vary from time to time, and from each other. For instance, I am quite satisfied with the frames, foundation, extractor, jars I use, but until a good majority agreed with me they could not be made "standard." Again, until lately the "Garstang" press was good enough for me, but last year I found that the Rymer press, about which I should like to say something more shortly, was far superior. Once more, I have had no fault to find with the "Porter" escape, but I shall certainly try the "R. H. Smith" super-clearer which Messrs. Jas. Lee & Sons are bringing out. When I am looking out for improvements in every direction, how can I possibly be satisfied with the square section, which has been a comparative failure?

I would therefore be inclined to say just the opposite to Mr. Raitt, that it is absolutely not essential but ruinous to success that a "standard" size should be fixed, because from the aspect of the bee-keeper's Excelsior! (higher, yet higher) is a better motto than "to stand still," which generally means to go back, and from the standpoint of appliance dealers at a period of severe competition "standards" may spell ruin. What do our Consuls report on the prospect of British trade with China and parts of Africa? That whilst we are sending out stereotyped goods, in other words "standards" as good enough for the natives, the Germans and Americans are capturing the

markets by studying and supplying what the people require.

Now, turning to Essex once more, I would request Friend Loveday either to withdraw his sweeping assertion that Rev. Mr. Adams's makeshift is practically in no way connected with the 1-lb. section, or to tell us with what the makeshift is practically connected? Until he does so our argument (?) resembles that of two raw schoolboys who fly at each other vigorously thus: "I say it is," "No, it isn't," and is out of place in a scientific journal. "Practically" is no doubt a useful word, and may mean much, but it may mean little or nothing, only, as it were, so much dust to hide the poverty of an argument. One of our judges recently declared that he hated it and ignored it, because to describe a thing as "practically is so," means that it is not so.

Your monthly, the *Record*, for May, brings a little grist to the mill. It notices the similarity between the present method of producing super-honey and that adopted by the Russian bee-master, Prokopovitch, sixty years ago. If I may be allowed to refer to that account, as read through my coloured spectacles, I would call the special attention of all who are trying to produce honey-comb for the market to the size of the frames used. We read, "the figure frame is about 12 in. by 6 in., and their breadth not more than 1½ in." Is my advocacy, then, of a section narrower than 2 in. very unreasonable? I have, however, the support from the East of probably the greatest Russian bee-master two generations ago, as well as from the West of the progressive Americans, in contending that the 5-in. section is preferable to the square one, because, as a receptacle for marketable honey it is more natural for the bees and more suitable for bee-keepers in our variable climate.

It only remains for me to appeal to all bee-keepers who are able to give it a fair trial, and also to associations and show committees to give it a fair trial, not by having a special class for it—it will be time enough for this when a good many have decided to adopt it—but by allowing it to be exhibited side by side with the square sections. In other words, to open the section-classes to all sizes, as long as they are 1-lb. in weight, so that judges, producers, and consumers may be able to compare, criticise, and discover the merits or demerits of one and all.—RICHARD M. LAMB, *Burton Pidsa*, May 9.

#### BEE-KEEPING FOR COTTAGERS.

[5109.] I was, as usual, interested in Mr. Woodley's "Notes by the Way" in this week's B.B.J., but I feel it incumbent on me to say a word on behalf of the cottagers who, Mr. W. says, are too indolent to take up the bar-frame system. Judging from my own experience, I am inclined to believe that the initial cost of starting bee-keeping on modern lines is quite prohibitive to the average working man, and,

until this cost can be materially reduced, skeps for the bees will be as far as most cottagers can get. I give below an abridged but accurate statement of what I have spent since May, 1901, commencing with one hive only:—

Dr.	£	s.	d.
To one complete frame-hive and section-racks.....	0	16	10
Wood, paint, &c., for four home-made hives .....	0	12	5
Appliances and fittings for five hives (no extractor) .....	3	12	0
Four stocks bees .....	1	14	6
Sugar .....	1	0	9
Literature, insurance, &c. ....	0	9	6
	£8	6	0
Cr.	£	s.	d.
By 63 lb. honey, 1902, from the skeps, after the bees had transferred themselves below, at 8d. per lb. ....	2	2	0
Deficit .....	6	4	0
	£8	6	0

This is the state of affairs dating from May, 1901, or after two years' work, yet, now having five strong stocks, I am hopeful of making the bees pay, and pay well. At any rate, the extreme pleasure in the hobby has been, and will no doubt be, its greatest reward.

I enclose you small snapshot of three of my hives (two of which are home-made) and later, if of any use to you, I should like to send you a picture of my small apiary, and also give you the result of the season, as arrived at in the centre of this town.—R. J. T., *Romford, May 11.*

[We shall be very pleased to have photo as promised.—Eds.]

### MOLES AND WHITE CLOVER.

HOW MOLE-TRAPS ARE MADE.

[5110.] I write to ask if you or any reader would kindly help me in a matter which, though not directly relating to bees, seriously affects the clover pasturage on which we so much depend for our honey. The moles destroy the clover plant out here to such an extent that we must catch them in order to save the crop. But the ordinary mole-traps used are so often stolen that I thought of one used for the purpose by our farmers in England. The one I have in mind is simple and easy to make, so that if stolen it does not much matter. I can make the appliance in question, but do not quite remember how they are fixed in the ground, so that when the mole passes through the "run" the spring—formed of a bent twig—is released and the trap springs up in the air! I also forget whether string or wire is used for the "catching loop." Any help I may get in clearing the matter up will be much appreciated.

Our bees out here work well on the cherry, pear, and peach blossoms, rain only falling on

two days during the blossoming period. The rest of the time veritable bee-weather prevailed, with sunshine every day; though the nights are cold. I have forty-eight stocks of bees, all on standard frames, and that terrible disease, foul-brood, is unknown here. I often think what a scourge it must be to the bee-man at home.

In conclusion, I again express the hope that some reader will give me a word of advice in *BEE JOURNAL* about the "mole-trap." I send name, which is known to you, while signing myself—NEMO, *Trieste, Austria.*

[Having no personal knowledge of mole-trapping, or of traps used for the purpose, we will be glad if some reader better informed than ourselves will give the required information.—Eds.]

### THE "ROYAL SHOW FUND."

[5111.] I am sure many of your readers, along with myself, will regret the necessity for an appeal by the Vice-Chairman of the B.B.K.A. (page 181) to county associations for contributions towards the "Royal Show Fund," and I think it was a pity that some of the county representatives at the conference held in London last October did not see their way clear to suggest that it be made incumbent on all representatives to bring the matter before their respective associations, with regard to contributing, say, a sum of 10s. per county association towards the fund in question. The matter would thus have been brought prominently before the members. It seems to me unreasonable for our representatives to attend that conference and advocate the grouping of counties without asking their associations to contribute towards the Prize fund. It is, however, not too late to send along their contributions now.—J. PEARMAN, *Derby, May 9.*

### A CURIOUS CASE.

[5112.] Here is a curious event I would like you to throw some light on. Of two hives of bees standing beside each other last autumn, I concluded, one was queenless. I tried to get a queen from abroad, but in awaiting a reply to my order, the season got too far advanced; and I finally determined to feed up both stocks well, hoping that the bees would live till spring, and I might then get queen or unite the two if necessary. One day in the early part of April I looked at hives for first time this season, and saw the bees of both were bringing in pollen. This surprised me, so I determined to take first fine day to open up for inspection. Eventually I examined the hives, and the result was as follows:—In the hive supposed to be queenless, I found nearly all the bees lying dead on floor of hive, and some few in central combs. There were about as many living bees as would cover one comb, and on the second comb I found a small patch of new

brood. There was also plenty of the syrup from autumn feeding in all the combs. I next turned to the hive left with queen, and found all the syrup given in autumn exhausted. There were no dead bees in hive and no indication of new brood, except one queen-cell, with queen almost ready for hatching out. There seemed to be a few young bees lately hatched, but the stock is in low condition. Now it seems to me that the bees of last-named hive, having used up their stores, began to rob the other one, which was most likely undefended; and then queen from second hive somehow got intelligence of the condition of the queenless hive and took possession of it, leaving the other hive to get on as best it can, and in consequence they have developed this coming queen. Now the question is, how is she to be fertilised? Are drones kept over during winter, or must she be visited by those of some other hive, as no drones are to be seen in the present stock, and no more brood in the combs? There is only herself, that is the peculiarity. What do you advise to be done? I may say the hives belong to a friend whose bees I inspect occasionally.—R. J. R., *Hest Bank, Lancaster*.

[Judging by the details given, we cannot pretend to account for the remarkable results with any degree of certainty. As regards what is best to be done, the only useful thing is to unite both lots after removing the queen, supposed to have hatched out in April, as there would be no chance of her having mated, and she will in consequence be worthless. Your own idea of the fertile queen changing her quarters may be partly right, because bees do at times desert foodless hives in the form of "hunger-swarms," but the queen-raising in the deserted hive rather upsets this notion, unless we fall back on the well-worn axiom "bees do nothing invariably."—EDS.]

#### DEALING WITH FOUL BROOD.

[5113.] I am greatly obliged by your "wire" re foul brood in specimen of comb sent. I immediately drove the bees into a skep, and kept them for forty-eight hours; then placed them in new hive, on frames fitted with foundation, along with two combs containing medicated food I had by me. I destroyed the old hive (which was partly straw) and frames containing food, brood, &c., by fire, and quite "burnt the lot." I am carefully examining all stocks. I found that a 1902 swarm, which had two frames given them from the diseased stock in question, had foul brood on one of the frames so given. The brood on one side of the comb was beautifully white and plump, but on the other side there was some like that sent you. I therefore took out both the old frames and burnt them. The bees were fed on medicated syrup last year, which accounts, I presume, for the healthy brood on one side.

I also noticed, in another stock otherwise

apparently quite healthy and strong, that there were only three cells containing dead larvæ. Is it at all likely that the larvæ sometimes die in this stage from causes other than foul brood? They were whitish, and came out of the cells similarly to the other—which was not a bad "case," in your view. I carefully took it away and burnt it.—API, *Dorset*.

[There is, of course, always the possibility of a few deaths occurring from chilled brood in a healthy stock, but, when discovered, it is always best to cut out the dead brood and destroy it, though we should not go so far as burn a frame of healthy brood when so few as only three cells were affected.—EDS.]

#### ABOUT BEE-TENT WORK.

[5114.] May I be allowed to offer a few hints to experts and lecturers from one who has had experience of the work? The time will soon arrive when the bee-tent will be removed from its winter store-room and pitched upon some piece of ground near at hand for overhauling. Repairs to canvas, cords, or framework may be necessary before it is fully fit for its season's work; some cords may be old or worn, and need replacing by new ones strong enough to stand a good storm such as is now and then encountered. Arrangements should also be made for the excessive hot days we sometimes have. The lecturer then finds it uncomfortably hot for a large audience to be enclosed in the tent along with himself when he is driving the bees and talking at the same time. On such days it is a good plan to loop up both parts of the canvas curtain where they lace together; indeed, I have sometimes been glad to loop up the whole of the curtain to get a little of the outside air.

A very responsible part of the expert's duty, when arranging for bee-demonstrations, is finding suitable places on which to stand the skeps of bees sent from a distance for "driving" purposes. I have sometimes found these almost useless for the purpose, owing to carelessness in packing, or the jolting of the conveyance used in getting them on the ground. On arrival the bees should have immediate attention and be placed, if possible, a short distance from the tent, under a shady hedge or tree for a little while, then quietly untied and allowed free flight. Sometimes they may be placed within the bee-tent if the latter is not so near other departments of the show as to cause possible inconvenience to visitors.

*Furniture of the Tent.*—The interior of the tent should be furnished, where possible, so as to give it somewhat of an educational aspect; diagrams hung opposite the entrance, a deal table (size about 4 ft. by 3 ft.), and upon it a variety of things connected with apiculture, such as a complete hive for description, samples of comb-foundation, section; smoker,



driving irons, frame, a filled section, glass jar of extracted honey, indeed, anything useful as an object-lesson, the whole to have an orderly appearance, and ready at hand to pick up anything that may by chance become the subject of the lecture at the time. Personally, I like to have a chair in the netted-off part of the tent. It gives an idea of "at-homeness" that helps to reassure nervous people on the other side of the netting, and also serves as a resting place for some assistant while the lecture is being delivered. A clean bucket containing water for washing hands, and towel tacked to the tent pole is useful.

The former practice of transferring combs from skeps to frame-hive in the tent has been wisely discontinued, and those of our leaders who first advocated its discontinuance, not only in the bee-tent, but in general practice, should receive the thanks of all up-to-date experts and bee-keepers.

I think all the purposes of a demonstration in the bee-tent are met by showing how to open a frame-hive, lifting out a frame of comb, bees and brood, and showing it round. Then driving a stock from a full skep to an empty one, and afterwards throwing out the bees from latter on the table and allowing the bees to run in to parent skep again.

A long blouse or bee-dress (like that shown on page 80 of the "Guide Book") is an excellent garment for keeping the clothes of the demonstrator clean, and can be easily washed when soiled. I have worn one in the middle of the hottest day (with my coat off, of course), and have been quite cool.—JOHN BROWN, *Polyphiant, Lاونceston, May 12.*

### NON-SWARMING HIVES.

[5115.] I have been reading in B.B.J. about a recent addition to the "W. B. C." hive in the shape of a non-swarming chamber, and wondering whether it has proved sufficiently successful for me as an amateur to try it. I have kept bees for some few years now, and have always used the "W. B. C." hives, along with the "W. B. C." section-box. Being about to purchase a new hive of the same kind, I am uncertain whether to get this non-swarming chamber or not; but should I do so, I shall certainly be disposed to use excluder zinc between it and the brood-chamber, for fear of the queen getting placed up above when it is moved! But I see a difficulty, in the design, as shown on page 14 in Messrs. Lee's catalogue.

Supposing the non-swarming chamber to be in use with excluder zinc between it and the brood-chamber, and the entrance to the hive to be as shown in the woodcut referred to, how can the newly-hatched drones get out of the hive? They cannot pass the excluder zinc placed on top of the non-swarming chamber, through which the bees have to pass as their only means of entering the hive above, the entrance to which appears to be

on a level with the bottom of the non-swarming chamber. Will you also tell me whether I could use my racks of your hanging-sections in the non-swarming chamber? And is there any better invention than zinc for keeping the roofs of hives dry? I find zinc buckles terribly, and the water is driven by wind under the top-piece of the roof, following the zinc, which goes well under this wooden piece, and finds the joint, and runs in, much the same as without the zinc at all!

Apologising for troubling you with all these questions.—(Mrs.) A. E. M., *Chepstow.*

[On no account must you cover the frames in non-swarming chamber with queen-excluder, since by so doing the drones would be imprisoned in the hive above and cause all sorts of mischief. The non-swarming chamber is placed below the body-box primarily to give the bees room and occupation in comb-building, but when they have got started well at work the extra chamber, bees and all, is removed and placed above brood-nest, when it becomes the surplus-chamber for honey-storing; and by providing plenty of storage-room overhead in this way swarming is prevented.—EDS.]

## Queries and Replies.

[3089.] *Working for Section Honey and Preventing Swarming.*—Kindly give me replies to following:—I work entirely for sections, and my hives are all the "W.B.C." I would, therefore, like to know: 1. If you work these always with a box of shallow-frames under the brood-nest of standard frames? 2. If so, should these be put on when the honey flow begins? 3. In case the stock is not over strong in bees, I presume the ten frames in body-box will give the queen plenty to do without the shallow-frames? 4. I have a few pounds of candy on hand, and as liquid food is now best can I boil this down to syrup, and if so, what quantity of sugar and water should I add to each 1-lb. cake of candy to make it syrup? I am not anxious to use the shallow-frames in the way mentioned unless you advise it.—F. J., *Mountmellick.*

REPLY.—1. First, let us say, there is no difference between working the "W.B.C." hive for sections and any hive of similar type. In our busier bee-days of bygone times we always used a box of shallow-frames above (not below) the brood-nest of such stocks as were worked for section-honey. Our reasons for so doing were, however, entirely local and peculiar, as follows:—We did our best to get stocks strong as early as possible, and, having many sycamore trees about, the inferior early crop of honey gathered from these was not suitable for sale in sections, so we had it stored in shallow-frames and left it on the

hives for the food-supply to keep the standard frames below available for brood only as far as possible, whilst the section-racks were placed above the shallow-frames. 2. Using boxes of shallow-frames below brood-nests is a new idea, intended mainly to give more room and prevent swarming; therefore the boxes are given when the honey-flow begins, or as soon as the hive becomes fairly crowded and the bees show signs of preparing to swarm. 3. If the ten standard frames of body-box are all available for brood-rearing, we find them sufficient for any ordinary queen's powers of ovipositing; but in some districts, or with extra prolific queens, the shallow-frames may be placed above brood-nest with no excluder between; thus the brood-nest is enlarged with a minimum of trouble. 4. Use the candy as sugar in making syrup of it for bee-food in spring. Your letter got accidentally mislaid, hence delay in reply.

[3090.] *Making Artificial Swarms—Moving Bees.*—With reference to my recent communication on "Moving Bees," mentioned on page 180, I should have specified that the "mistake." I fear had been made was in the jolting of the hand truck over rough ground, and subsequent "tipping up" of the truck during the removal, thereby possibly jamming bees between frames. On lifting off roof next day I discovered that some bees were crushed between the perforated zinc—on which the feeding-bottle rested—and the tops of frames. These dead bees have not yet been removed. I therefore, as the veriest tyro in such matters, ask: 1. May I undertake a thorough inspection of hive now, and how should the frames be removed if found fastened to the hive sides with brace-comb. 2. If on inspection I find the colony very strong, should I proceed to "divide" it as directed on page 94 of "Guide Book," as I already possess a spare hive? 3. In conducting this operation, do I understand rightly that the "ripe queen-cell" referred to should be cut from the comb on which the queen has been found, and which has been transferred to the spare hive? 4. Should the hive entrances be opened wide in all weathers, as in the evening after a cold day, I found several bees had failed to reach the entrance? These I placed in a small box and brought indoors, where they speedily recovered, flying strongly the next morning and joining the hive. Is this common practice? 5. I have a quantity of comb, some comparatively new, whilst remainder looks very old. Do you advise utilising the former or destroying the whole and starting with new foundation? Trusting that I am not giving you too much trouble.—F. PRING, *Gosport.*

REPLY.—1. If a warm day be chosen, hives may always be safely examined in May. Any frames fastened to hive-sides by brace-combs must have the attachments severed by passing a knife between, and then cutting away the brace-combs. 2 and 3. The fact of your being

the "veriest tyro" makes us hesitate in advising artificial swarming, as described in "Guide Book," unless you master all the details given more thoroughly than you have evidently yet done. For instance, "the comb on which the queen has been found" will not have a ripe queen-cell on it when removed, as you suppose, the said cells being formed after removal of queen from the parent stock. Better defer making artificial swarms till you have gained some experience of bees. 4. The hive entrance is regulated according to season and weather, but, once it becomes settled and warm, wide doorways are the rule, and would rather facilitate than hinder the entrance of tired, home-coming bees. It is quite usual for some bee-keepers to "warm up" chilled bees, but in large apiaries the task is perforce left to the next morning's warm sunshine. 5. Use the new combs, and melt down the old ones for wax.

[3091.] *A Beginner's Queries.*—I begin by confessing that I know nothing whatever of bees, except by perusing the pages of B.B.J. of the last three weeks and reading the "Guide Book." I purchased in January a stock of bees in a frame-hive from a cottager, who assured me they were free from disease. But as his ideas of bee-keeping are rather out of date, I have this day adopted the suggestion in "Guide Book" (page 170), and have transferred the bees to a new hive. In doing so I noticed that the combs were of a dark smoky colour, and so I ask:—1. Is this as it should be? I noticed, too, on one comb a black patch about 1 in. square. 2. Is this foul brood? If so, how must I deal with it? I have been giving the bees syrup-food, but having recently seen several drowsy and dead bees in front of the hive, I have concluded these are robbers, and have, in consequence, discontinued feeding. 3. Is this the right thing to do? My advice to a novice with mind intent upon "spring cleaning" is, first, make sure the fuel in bellows is burning well, so that it may not go out just in the midst of the operation; second, do not trust to ordinary woollen gloves. I did, and at least a dozen inquisitive bees crawled up my coat-sleeves, and it was a case of pins and needles! Having retreated, at the double, to the other side of the garden, my coat came off quicker than I put it on, but having got rid of the now stingless bees, I pulled a pair of thick cycling stockings over my hands and arms, and so finished my task. I shall try the carbolic cloth in future "spring cleaning." 4. Am I not right?—W. R. H., *Alexandra-road, Oxford, May 7.*

REPLY.—1. All combs in brood-nests become dark in colour after long use. 2. We cannot accurately diagnose foul brood from description of comb; a sample containing dead larvae must be sent for personal inspection. 3. If feeding really causes "robbing," the food should only be given after sundown, and feeding-bottle removed early next morning; but if the stores in hive are not running

short, there is no need to feed at all; and we are not sure it is a case of "robbing" from the few details given. 4. Quite right so far as regards smoker fuel being set well alight at the outset; but the use of woollen gloves, or gloves of any kind, causes stinging by bees, and the sooner they can be dispensed with the better: for both operator and bees. A little more practical experience of bee-handling will convince you of this.

[3092.] *Medicating Bee Food.*—Kindly answer the following in your next B.B.J.:—1. What is the correct number of grains of naphthol beta required to be added to each pound of sugar for medicating bee-syrup? 2. How many hours should bees be confined with safety in empty skeps when taken off diseased combs to be starved prior to re-hiving?—"NAPHTHALINE," *Stafford, May 11.*

REPLY.—1. The printed directions on each packet of naphthol beta sent out from this office read thus:—"Dissolve three grains of naphthol beta in spirits of wine, or of methylated spirit for every pound of sugar used in syrup-making." We do not, however, guarantee the quality of any naphthol beta not obtained through this office. 2. The usual time is forty-eight hours, but some modification of the time must be allowed for if, owing to the condition of food stores in the hive from which bees are removed, they are unable to gorge themselves with food when being driven or shaken from the combs. It is thus at times advisable to look at the driven bees in say, thirty hours, and if they are found dropping from the cluster, and dying from starvation, measures must be taken to avoid further deaths.

[3093.] *Bees Dying from Starvation.*—I should be much obliged if you would tell me 1. What the small white objects at bottom of cells in the enclosed piece of comb are? I had a skep of bees sent me a few weeks ago, and all seemed well till three days ago, when my gardener sent word that a lot of dead bees were lying outside the skep. I was ill at the time, but went to the bees to-day, and found about 1,000 bees lying dead outside, and a very few sluggishly crawling on the skep. I lifted the latter up, and there was quite another 1,500 to 2,000 bees lying dead on the floor. The skep contained six good-sized combs, which I pulled out, and found on them about a score of bees still alive and a dead queen. There were absolutely no stores, and some dozen or so capped brood-cells with dead larvæ in them. I enclose a few of the latter. 2. Was death due to starvation from hunger or cold? Should I have fed the bees on arrival? 3. Can I safely use the old combs instead of foundation for a frame-hive? The bees appeared to be going in and out freely a week ago on fine days. I must apologise for troubling you with such a lot of questions about what is probably a very simple case, but I cannot find any satisfactory solution in my

books, and my practical experience of bee-keeping is of the smallest.—A BEGINNER, *Cumberley, Surrey.*

REPLY.—1. What appear to be "small white objects" are simply the reflected light of the polished walls of the cell-base, the triple sides of which converge to a central point at bottom of the cell and give the appearance of a white speck. 2. The death of bees is clearly owing to starvation from want of food. 3. Use foundation in preference.

---

#### TRADE CATALOGUES RECEIVED.

C. REDSHAW, *South Wigston, near Leicester.*—Mr. Redshaw's list for 1903 contains not only a full line of his well-known bee foods, which for quality and accuracy of make have long held a high place, but also includes a number of things outside bee-keeping. Among these we note poultry appliances, greenhouses, and portable buildings of all kinds, with full specification and price of each. It is a useful list, and well worth perusal.

F. W. L. SLADEN, *Ripple Court Apiary, near Dover.*—From the fact of Mr. Sladen issuing a separate list for his bee and queen-rearing trade, and another for the hive and appliance business—the fact of our receiving only the first-named one led us into the error of supposing that he had given up the latter branch of the business. We have since had a copy of his "Price List of hives and bee-appliances," which, as before, is compact and brief, containing particulars of a small but select collection of goods, which he has paid particular attention to perfecting, and all are stated to be of "best quality only."

---

## Bee Shows to Come.

*A nominal charge of 2s. 6d. is made for notices in this column, which covers cost of insertion from order till date of show. Cash should accompany orders for insertion.*

June 9 and 10, at **Bishop Stortford.**—Annual Show of the Essex Agricultural Society. Bee and Honey Section under the management of the Essex and Suffolk Beekeepers' Association. Classes open to the United Kingdom. Schedules from Mr. W. J. Sheppard, King's Head Hill, Chingford. Entries close May 15.

June 23 to 27, at **London.**—"Royal" Agricultural Society's Show. Bee and Honey Section under the management of the B.E.K.A. Increased prizes for B.K.A. Associations as arranged in divisions or groups of counties. Schedules from Edwin H. Young, Secretary, 12, Hanover-square, W. Entries close May 15 (without extra fees).

July 22, at **Broughton Hants.**—Fruit, Flower, Vegetable, and Honey Show. Twentieth year. Liberal prizes, with silver cup, valued £50, open to the United Kingdom. Particulars from Fred. J. Hinwood, Broughton, Stockbridge, Hants. Entries close July 18.

July 22 and 23, at **Cardiff.**—Honey show of the Glamorgan B.K.A., in connection with the Cardiff and County Horticultural Society. Bees, hives, honey, trophies, wax, appliances, and articles of food. Substantial money prizes and medals. Free entries. Six

open classes. Schedules from William Richards, Gwalffa, Cardiff. Entries close July 16.

July 29, at Wallop, Hants.—Honey Show of the Broughton and Wallop Branch of the Hants and Isle of Wight Bee-keepers' Association. Two open classes for single-section and 1-lb. jar respectively (entry free). Schedules from Miss Tucker, The Lindens, Broughton, Stockbridge, Hants. Entries close July 22.

July 30, 31, and August 1 and 3, at Old Trafford, Manchester.—Annual Show of the Royal Lancashire Agricultural Society. Liberal money-prizes are offered for honey along with silver and bronze medals of the B.B.K.A. and also of the Society. Open classes for Honey-Trophy, Sections, Extracted Honey, Beeswax, Honey-Confectionery, Bee Flowers, Instructive Exhibits in Bee-Culture, &c. Schedules from Edward Bohane, Secretary, Miller-arcade, Preston. Entries close June 30.

August 4, at Leamington.—Tenth annual show of the Leamington St. Mary's Horticultural Society. Three open classes for Six 1-lb. Sections, Six 1-lb. Jars "Light," and Six 1-lb. Jars "Dark" Extracted Honey, respectively. Liberal money prizes. Schedules from P. W. Smith, Secretary, 32, Leam-street, Leamington. Entries close July 30.

August 6, at Nantwich.—Honey department of the Cheshire Agricultural Society's Show under the management of the C.B.K.A. Numerous classes for hives, honey, and wax. Money prizes and medals. Schedules from T. A. Beckett, St. Werburgh's Chambers, Chester.

August 6, at Kingsthorpe, Northants.—Honey show of the Northants B.K.A., in connection with the Horticultural Society's Exhibition. Three open classes with special prizes, including one for single 1-lb. jar of honey. (Entry free.) Prizes 20s., 10s., 7s. 6d., and 2s. 6d. Schedules from R. Hefford, Hon. Sec., Sunnyside, Kingsthorpe, Northampton. Entries close August 1.

August 12, at Radstock, Bath.—Honey show in connection with the annual show of the Radstock and District Horticultural and Fanciers' Association. Schedules from the Secretary, B. M. Clark, 1, Fox Hills, Radstock, Bath.

August 27, at Llangollen.—In connection with the fifth annual Flower Show. Open classes for Six 1-lb. Sections, Six 1-lb. Bottles Extracted Honey, and Beeswax. Schedules from Frank Little, Castle-street, Llangollen. Entries close August 13.

August 27, at Montgomery, in connection with Montgomery and District Horticultural Show. Open classes for Six 1-lb. Sections and Six 1-lb. Jars Extracted Honey. Prizes in each class 10s., 5s., 2s. 6d. Entrance-fee 1s. each. Schedules from W. J. Jones, Secretary, Montgomery. Entries close August 20.

### Notices to Correspondents & Inquirers.

Letters or queries asking for addresses of manufacturers or correspondents, or where appliances can be purchased, or replies giving such information, can only be inserted as advertisements. The space devoted to letters, queries, and replies is meant for the general good of bee-keepers, and not for advertisements. We wish our correspondents to bear in mind that, as it is necessary for us to go to press in advance of the date of issue, queries cannot always be replied to in the issue immediately following the receipt of their communications.

All queries forwarded will be attended to, and those only of personal interest will be answered in this column

S. W. FULLBROOK (Berks).—*Making Artificial Swarms.*—With regard to dead larvæ mentioned, we cannot venture any opinion thereon unless a sample is sent. So far as making an artificial swarm from what you call hive No. 2, we ask, Why think of doing so if there is already a queen-cell in the hive that will hatch out in about five days? We should let the bees swarm

naturally if they will, and you need have little fear about the young queen getting mated when there are already drones hatching out in hive No. 1.

"NEW FOREST" (Hants).—*Painting Hives.*—We do not know anything of "Carbonilian," but since you say it is "a kind of creosote," and is a preservative of wood, there can be no objection to using it in lieu of paint for hives. We presume that any objectionable odour it may have will pass off when dry.

H. J. CAMPBELL (Ayrshire).—*Immature Bees Cast Out.*—The bees sent are small immature drones that have died in the cells through being outside the cluster, and have so become chilled.

J. C. LLOYD (Lewes).—*Salicylic Acid for Medicating Bee Food.*—Both "salicylic and borax" and "phenol" were largely used for medicating bee-syrup some dozen or more years ago, each having its advocates; but the important experiments made by Dr. Lortet made it clear that naphthol beta—if pure and of proper quality—is superior to either salicylic acid or phenol, the latter have almost fallen into disuse.

L. COLLINGS (Leyland).—*Books on British Wild Bees.*—Messrs. Lovell, Reeve, & Co., Henrietta-street, Covent Garden, will supply particulars of works on the subject, but such books are, as a rule, rather costly. Mr. Sladen's articles on "Our Wild Bees," as published in B.B.J., may be had for a few pence from this office, and for an ordinary reader cover the subject very well.

B. BOOTHROYD (Weston-super-Mare).—*Bad Weather and Feeding Bees.*—We do not think that B.B.J. readers who peruse its pages carefully will have failed to realise the need for feeding their bees where stores are short. It is those who don't read and don't think about their bees in times of scarcity who suffer by finding stocks dead from starvation.

### Suspected Combs.

A. C. (Lee, S.E.).—We regret to say both samples of comb are badly affected with foul brood. You should burn both the "weak stocks" from which combs were taken at once, or the other hives may suffer, even if not already affected.

A. G. C. (Sussex).—There are slight signs of foul brood in comb, as stated in reply by our "wire," and the stock will need prompt remedial measures in the shape of using preventives, and careful watching in addition as breeding increases, to see that the disease is held in check. There being no spores to deal with, the case is hopeful so far as yielding to treatment.

"A Ten Years' Reader" (Glam.).—Comb is affected with foul brood.

\*.\* Some Letters and Queries are unavoidably held over till next week.

## Editorial, Notices, &c.

### MR. COWAN'S RETURN TO ENGLAND.

Our Senior Editor arrived at Liverpool by the Cunard s.s. *Saxonia* on Thursday last, the 14th inst., and is now in London. It is difficult to realise that so long a time has elapsed since Mr. Cowan left this country for Southern California in 1898, and a little later on became possessor of his residence at Pacific Grove, Monterey Co., which is, we believe, one of the most beautiful spots in a part of the world so exceptionally endowed with Nature's wonders as California.

The intervening time has, however, apparently sufficed to endear Mr. and Mrs. Cowan to the inhabitants of the place, judging from various "happenings" on their departure for England. We gather from the *Pacific Grove Review* that on this becoming known, arrangements were made for public receptions in the afternoon and evening of the day prior to the departure, given in their honour at the Natural History Museum, of which Mr. Cowan had been for three years President. Both events were largely attended, and our contemporary says, "Clergymen representing various religious bodies attended and expressed on behalf of several congregations their appreciation of Mr. and Mrs. Cowan's worth as members of the community, among whom they had laboured as active workers in all that tended to its welfare."

An illuminated address from the Board of Directors and members of the Association was also presented to Mr. Cowan, expressive of their appreciation of his valuable services as President, and "hoping to have the pleasure of welcoming himself and Mrs. Cowan back again."

The above pleasant news will, no doubt, be gratifying to Mr. Cowan's friends at "Home," for our esteemed Senior Editor, as we know, will never cease to regard England as his "home," wherever he may be, and a very cordial welcome was extended to the Chairman on his return by the Council of the B.B.K.A. at its meeting yesterday.—(W. B. C.)

### DRIFFIELD B.K.A.

#### ANNUAL MEETING.

The annual meeting of the Driffield and District Bee-keepers' Association was held at Driffield on the 30th ult., Mr. Foster presiding. The Hon. Secretary read the annual report and statement of accounts, according to which nearly £20 worth of appliances had been sold during the year, which showed that bee-keeping on modern principles was making steady progress in the district. It was decided to again have honey classes at the Driffield Agricultural Show, the bee-section having been considered an additional

attraction. Mr. H. Holt, J.P., was re-elected President, along with some prominent patrons, and a strong working Committee was formed, with Mr. W. E. Richardson as Secretary, and Mr. Watson as Treasurer.—(Communicated.)

## Correspondence.

*The Editors do not hold themselves responsible for the opinions expressed by correspondents. No notice will be taken of anonymous communications, and correspondents are requested to write on one side of the paper only and give their real names and addresses, not necessarily for publication, but as a guarantee of good faith. Illustrations should be drawn on separate pieces of paper. We do not undertake to return rejected communications.*

\*. \* In order to facilitate reference, Correspondents, when speaking of any letter or query previously inserted, will oblige by mentioning the number of the letter as well as the page on which it appears.

### AMONG THE BEES.

#### SOME SEASONABLE NOTES.

[5116.] *Tardy Spring.*—Winter has lingered long this year, and kept its icy fingers on vegetation, chilling and checking growth until the very closing days of April. Bees were slow of starting breeding, for mild weather, with its attendant result of pollen-bearing flowers, seems a necessary stimulus to secure a successful extension of the brood area in even the best hives. The spring-cleaning was not got over until the 25th, and then the internal progress showed, as a whole, a minimum of development. Stores in every case were found ample to carry on the colony until forage can be obtained from the white clover bloom. The patches of brood were small in most, but in almost every case the queen seemed anxious to force on the bees and had deposited eggs in a wider area than the workers could well tend or supply with the necessary heat. In one hive five queen-cells were discovered in different stages of development, one all but ready to seal; yet there was a large patch of sealed brood, and quite large stretches of brood just ready to seal over, showing unmistakably that a prolific queen had headed the colony quite recently. As it had been quite undisturbed till that date, it is rather a puzzle to account for her disappearance. One point may be worthy of recording. *Not one* of the southern driven lots got last year has pulled through! My explanation of the phenomenon is as follows: They had been chilled in driving, and thoroughly enervated by lack of food during the long journey, owing to the wintry weather then so prevalent. Though the bees partially recovered when fed on arrival, they were so weakened that they died off, while the fertility of the queens had been so much impaired that, if they started laying at all, it was in such a perfunctory manner that they left practically no young bees to replace those dying off, and hence the colonies have been so depleted that none of them can survive as independent lots.

This experience in my knowledge is unique—fortunately so.

*Placing Hives.*—At this season so many bee-keepers will be starting new swarms that a few practical hints on adjusting the hive may be seasonable. Choose preferentially a southerly position for the front, so that the bees may get as much advantage of the sun as possible. If they can be sheltered from the most prevalent cold winds by a wall, hedge, or fence, it adds to their comfort and tends to prolong bee-life. It is of great advantage that they should stand with the back of the hive to a walk or path, so that any manipulations may be done from behind, without coming in contact with the foragers. Care must be taken to see that hives are planted down on stands perfectly level, as this has a most important bearing on the proper building of both brood and super combs. Without this care frames are pretty certain to be completed so irregularly and out of plumb that they are incapable of being exchanged with others when necessary. Sections are also certain to be badly and irregularly built, with brace combs, ties, and bulges fixed on to the dividers, resulting in broken cells, bleeding sections, and imperfect and unsaleable honey. Amongst the work now requiring attention may be mentioned the preparation of section racks, so that they may be ready for the honey-flow expected at an early date. Full sheets should always be used, and where the split in the top is angular care must be taken to see that the sheet hangs true, as it has a tendency to stand out at an angle corresponding with that in the split.

*Remunerative Bee-keeping.*—Just to show how our hobby is appreciated, and how far what some of our prominent bee-keepers speak and write may travel, I give the following, copied verbatim from the *Aberdeen Daily Journal*:—"At a meeting of the Society of Arts in London Mr. Walter F. Reid, of the British Bee-keepers' Association, read a paper on 'Modern Bee-keeping.' Thousands of bee-keepers in this country, said Mr. Reid, employed methods and appliances which the Egyptian of 4,000 or the Greek of 2,000 years ago would have condemned as obsolete. [Query?—D. M. M.] There could be no doubt that bee-keeping in most rural districts was remunerative. For instance, in 1894 two workmen bought a skep of bees on joint account. They had now twenty-four stocks, which had yielded on an average 56 lb. of honey per hive." May so remunerative an average yield be the result to all who work on modern lines during 1903!

*Bees Interchanging Hives.*—Observation makes me inclined to the belief that bees are at times not so very clannish as they are generally believed to be; but that they can at least pay an occasional visit (perhaps only a courtesy call) into their neighbours' homes. At one time I had a Ligurian colony shifted into line with about a dozen other hives, and

their golden bands enabled me to see that considerable numbers of these visited with impunity two hives on one side, and three on the other, of their own home. Several of them must have totally deserted their own fireside, and emigrated as they carried pollen steadily into the cities of their adoption for several weeks, and then they must have passed over to the great majority I suppose, for their visits ceased. Is this a common occurrence?

*A Miserable May.*—The three weeks already gone, since a delightful May-day ushered in the month, deserve no more favourable description. Our county newspaper has been cheering us up by predicting a bright future as a consequence of all this soakage, and quotes several proverbs to back up its assertion, among them being:—

"A rainy May marries peasants."

(French.)

"Water in May is bread all the year."

(Spanish.)

"A wet May makes big loads of hay."

(English.)

"May showers bring milk and meal."

(Scotch.)

All which should encourage us to hope.—  
D. M. M., *Banff*.

#### SOME ESSEX NOTES.

[5117.] The outlook here is far from bright. Feeders have to be kept in use upon many hives. Cold storms of rain or hail constantly recur at short intervals, and the nights are very cold. There is hardly any blossom on the whitethorn in this district; in fact, I have only seen one small bunch in a two-mile walk. The land is naturally heavy here, and along with the very cold nights, has stunted the growth of clovers and sainfoin growing around.

It has come to my knowledge that a number of colonies of bees in this district died outright from starvation during April, but no sooner had we two or three days of sunshine, when bees could be heard humming in the trees, than the usual applications to buy and borrow supers began to come in from bee-keepers, who, though they neglect both to give their bees necessary food and to order appliances for their use, are most anxious to pocket the proceeds of sales of early takes of honey.

*The New Tall Section.*—Referring to the request made (on page 194 last week) by the Rev. R. M. Lamb, let me say I have nothing to "withdraw." If you make use of the makeshift methods of individual bee-keepers in order to illustrate—and, I may very well add, exaggerate—one side of a discussion, and I find it necessary to deal with your own illustrations, in defence of an appliance—in the abuse of which you do not spare any one concerned—it is not myself who has anything to withdraw.

I welcome anything new and progressive in

bee-keeping appliances; my objection is to the way that Mr. Lamb endeavours to compel—as it were—every one else to adopt his own ideas, and in his abuse of the 4¼ by 4¼ section quite ignoring the disadvantages of the tall section.—WM. LOVEDAY, *Hatfield Heath, Harlow, May 18.*

### UNKNOWN LARVÆ

IN CAPPINGS OF HONEY-COMBS.

[5118.] In answer to my request for specimens of cappings affected by these larvæ in the BRITISH BEE JOURNAL of August 28 last year, a bee-keeper residing in Surrey was good enough to send me some which showed the characteristic tunnels of the pest so well that I took a photograph of them, which I now have the pleasure to enclose. A and B are pieces of capping seen from the *under side*.

C and D show the outer side. The tunnels are really on the under side of the cappings. From <sup>A</sup> the outside the comb has merely the appearance of being covered with small cracks, which are often not easily detected except on close inspection.

The specimens are slightly magnified—the outlines of the hexagonal cells, which are just visible, will show to what extent.

I have chosen the present time for bringing this subject forward because it is about this season of the year (or a little later) that the pest begins to make its tunnels in the cappings of honey-combs, and it was in some specimens forwarded to me at this time of the year that I found the minute larvæ in these tunnels. Later on the pest appears to leave the combs, and in the specimens from Surrey here illustrated—which were sent to me in September—although the tunnels were very numerous, no trace of the larvæ could then be found. It appears that the larvæ commence to tunnel the cappings while the combs are still inside the hive, and if bee-keepers will kindly forward to me (by post) some specimens of the cappings when they are first seen to be affected, I shall be very greatly obliged, as I am anxious, if possible, to work out the life history of this very interesting and elusive little animal. The tunnels referred to appear to be sometimes mistaken for those of the wax-moth larvæ, but I am certain that it is quite distinct from, and in no way related

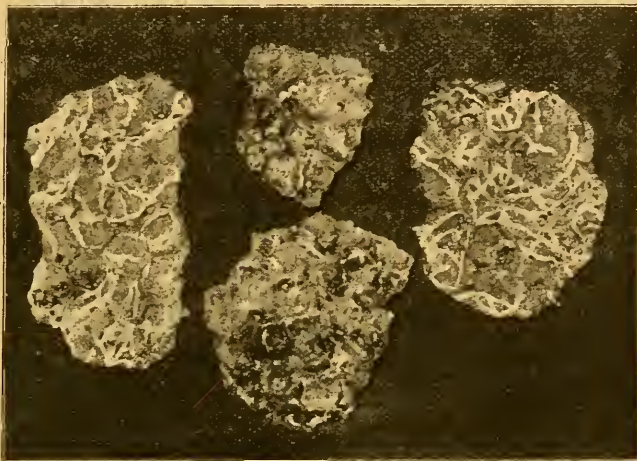

to, the latter insect. In sending specimens for examination, the cappings should be shaved off the comb with as little honey as possible, and they may be placed between two pieces of section separated by two narrow strips to keep them from getting crushed in the post.

I have received cappings containing the tunnels of these larvæ from Surrey and from Oxfordshire, and it is probable that the pest is widely distributed outside these two counties, and that it is not particularly rare.—F. W. L. SLADEN, F.E.S., *Ripple Court Apiary, Dover, May.*

### BADLY MADE HIVES.

[5119.] Referring to my complaint on page 183 of BEE JOURNAL as to badly made hives, and your request to be furnished with name

of maker, I think it will be best not to state the name even to yourselves. I am in communication with the firm with regard to the matter. I was practically forced to put the hive into use, and had to make a dummy-board myself. The ordinary ones I have (standard size) will not go

in by a long way. There was no dummy in the hive when it came. I measured the hive carefully, and found it barely 14¾ in. The maker has asked me to return it, and I feel that I should do so to justify the complaint, but it is most inconvenient to myself to do so, my time for outdoor work being strictly limited, as I follow indoor employment. It would require carrying some distance to the station, and I can remedy it with less inconvenience to myself. I paid a good price for the hive, and was entitled to have a well-made one. I have overcome the difficulty of bees escaping other than at proper entrance by thickening the slides with strips of linoleum.—“XENOPHILUS.”

### MOLES AND WHITE CLOVER.

[5120.] In the B.B.J., May 14, page 195, “Nemo,” writes to ask how mole traps are fixed in the ground? In reply, I may say about this part of the country the old-fashioned wooden mole-traps are fixed in the ground by means of two wooden stakes about 8 in. or 9 in. long, the stakes being made with a hook

at the top end, so they may be fixed one at each side of the trap. The hooks catch on the top of the trap and hold it firmly down in the ground. The bow-spring-stick, or bent twig (generally made out of a hazel rod) is about  $\frac{3}{4}$  in. to 1 in. in diameter and 4 ft. or 5 ft. long, but the length of the stakes and spring-stick depends upon whether the ground be solid or sandy in nature. The catching-loops (two in each trap) are made with copper wire similar to that used for "snares." The wire loops are fastened on the string which holds the bow-stick, and the other end (which is about 3 in. long) have a knot at the end to go through the hole (which is about  $\frac{1}{2}$  in. diameter) in the centre of the trap. The nose-peg, which latter is cut to fix in the hole on the under side of the trap holds the string till the mole springs the trap. I suppose that "Nemo" knows how to fasten the bow-stick to the trap when he set it, so now I will close wishing him good success with his mole-catching.—Wm. CHALLIS, *Cambs.*

#### MOLE TRAPS.

[5121.] Your correspondent, "Nemo" (page 195), will no doubt receive information through the JOURNAL as to ordinary traps, but the following plan I have just heard of, and it is new to me. Take a piece of lead pipe the length of two moles, say 9 in. or more and 2 in. in the bore. By means of a square piece of wood pushed into it hammer it so that it becomes a square pipe instead of a round one. Then make a leaden door for each end. This need not fit well, but the top of the door must be rolled round so as to make a rough hinge, and the two holes made in the square pipe so that a wire may be inserted to complete the hinge. This little door must open freely inwards, and a little of the bottom edge of the lead pipe must be bent up to prevent either door opening outwards, except, of course, by the owner of the trap. An observation hole is bored with a carpenter's centre-bit in the top of the square pipe. This pipe is buried in the run of the mole, and no thief can tell it is there.

The mole easily enters from either end and soon dies. Very often another mole enters from the other end, and eats his relative, being the only mark of respect he is able to show. If this note is of any use to "Nemo" I shall be amply rewarded. I could send a sketch, but I do not suppose it is necessary.—F. V. HADLOW, *Sussex, May 15.*

[In addition to the above communications, we have been favoured with interesting letters from Mr. W. J. Small and Mr. Thos. Lee, both of which contain several rough sketches without which the interesting details given would not be understood. We have, therefore, forwarded the letters to our correspondent in Austria, and on his behalf and our own beg to thank all of those who have

kindly complied with the request made on page 195.—EDS.]

(Correspondence continued on page 206.)

#### HOMES OF THE HONEY BEE.

THE APIARIES OF OUR READERS.

The nicely located apiary of Mr. Purdie, seen on opposite page, with the accompanying "notes" regarding its owner, affords another instance of the enthusiasm of the genuine bee-man who cares for his bees and finds his bee-paper as interesting to day as he did fourteen years ago. In thanking our friend for his cordial "invite," we may assure him that such tokens of goodwill are highly valued by the recipient. Mr. Purdie says:—

"It is fourteen years since I commenced bee-keeping, and the only regret I have is that I had not begun the fascinating hobby earlier. Like other novices, I was mightily afraid of stings, but the bee-keeper once caught remains, and to-day I am more in love with the tiny insects than ever. Speaking from experience, the very reliable platform of personal experience, I say that no pursuit gives more pleasure, and very few so much of profit, as bee-keeping. Not only so, but no matter how much the bee-man's interest may wane after the honey-crop has been disposed of, and the apiary settles down to the long, dreary winter, no sooner does the increasing warmth of April send the busy workers forth than his enthusiasm rekindles, and the hum of the apiary once again becomes the sweetest music. Great also is the feeling of keen satisfaction when every stock answers to the roll-call when the winter is over, and not a vacant hive in the lot.

"My apiary is situated on the banks of the Ettrick, seven miles up from the Royal and historic Burgh of Selkirk, and eleven miles further on is Ettrick Hall, the birthplace of James Hogg, the Ettrick Shepherd. Being at a fairly high altitude, and the farms mostly pastoral, our district is almost exclusively a heather one. But such heather! By the middle of August acres upon acres of the purple bloom cover the hill sides, and the ground being of a hard, rocky nature, the nectar gathered is of the highest quality. Given a fine August, and a field day with the bees on the heather is, as we Scotch folks say, 'A sicht for sair e'en.' Unlike our southern brethren, with their huge takes of clover-honey—weighing anything from 50 to 300 lb. from a single hive—we are well contented with an average of 30 to 40 lb. per hive. Owing to scarcity of summer forage for the bees feeding has to be resorted to, but I find it pays threefold to have the bees ready for the heather honey-flow, for in bee-keeping, as in everything else, a stitch in time saves nine. I now have eleven hives, but am sorry to say that pest of the bee-keeper, foul brood, has given me a lot of trouble, so much so that in my opinion no amount of 'tinkering' will suffice to stamp it out once it gets a proper



foothold; indeed, there is, to my mind, only one remedy powerful enough to cope with it, and that is extermination. To bee-men afflicted with the plague I say, clear it out and begin anew. The hives may, with careful disinfecting, be made to do duty again, but all loose things, such as frames, wraps, &c., burn the lot, and you will never regret it. Personally I am in favour of legislation on the subject, and regret very much that compulsory powers for dealing with it are so difficult to obtain in this country.

"I am an advocate for allowing bees to swarm naturally; without this most interesting of all the items of bee-life my bee-ardour would cool considerably; and where is the old

humble self. At the foot of the garden are seen my two eldest boys who prefer to look on the apiary at a respectful distance, and as the photo was taken on a warm July afternoon the bees were much in evidence, consequently their discretion was commendable. Further afield on the wire-bridge that spans the Ettrick is seen my wife along with the youngest boy and girl. Unlike some of her English sisters, my wife has an unconquerable 'shyness' where bees are concerned, and is quite content to leave the work with me so long as I make her the chancellor of the exchequer. The farmhouse seen in the background is known as Howford, and stands on the opposite side of the river; my own house



MR. DAVID W. PURDIE'S APIARY, BROOKHILL, ETRICK, SELKIRKSHIRE.

stock that can compete successfully with a swarm for either finishing honey or bringing it rapidly into the hive?

"Edinburgh is our market for honey, where it generally fetches about 1s. per 1-lb. section, but we also work 'ekes' holding from 12 lb. to 18 lb. each. The difference between the double and single-walled hives with me is about *nil*, and I am inclining to work a few more skeps, as they swarm earlier. Seventy pounds of heather honey has been my largest take from one hive. By occupation I am a crofter renting a small holding of  $7\frac{1}{2}$  acres on the Buccleuch Estate, the care of which, with the bees and a few other jobs, suffices to keep me fairly busy. As regards the picture, the figure standing amongst the hives is my

being located a little to the side, could not be shown in the photo, taken by Mr. Brown, watchmaker, Selkirk. In conclusion, I prophesy a good bee year in 1903, and if beginners—aye, and experts too—will take to heart the kindly and sound advice given every month in your admirable paper, they will be all the better for it. My only regret is that our genial Editor 'W.B.C.' cannot see his way to have an 'At Home' in Edinburgh where we Scotch bee-keepers could have a chat with our own 'oracle' in the flesh. I can say with truth the *Record* has given me much instruction in the craft, and I am reminded that my first contribution to its pages appeared in the issue for February, 1889, now over fourteen years ago."

## CORRESPONDENCE.

*(Continued from page 204)*

## THE WORK OF THE EXPERT.

[5122.] *What he is expected to do.*—This depends, no doubt, upon the particular Association which employs him, but the "tune" must vary with the ability of the caller to pay the piper, and, in the case of a wealthy association, more experts might, no doubt, be employed, and more time devoted to individual members, than in the case of one comparatively poor and sparse.

The association having made its arrangements, the members should not trespass upon the time of the expert for elementary information; for although all possible information is cheerfully supplied, the fullest details cannot be given of many matters in the time at his disposal, and where, as is often the case, questions are asked ranging from the wiring of foundation to the dodges of queen-rearing, members must not be aggrieved if the expert is unable to give practical demonstrations.

Questions of importance to the beekeeper should be noted beforehand, and ordinary queries should so far as possible be related to the management of the particular stocks for the ensuing period, whilst general information should be sought from the text-book.

Much must depend upon the expert himself and the time at his disposal, but this latter should be economised where possible by the bee-keeper, who should attend to the preparation of his stocks, the removal and replacement of roofs, quilts, &c., that the expert may devote the bulk of his time to the more important part of the work. It should be borne in mind that there are other members to be visited, and the expert must be assisted along, as he is only too often delayed on his round by the uncertainty of the weather.

To illustrate the work actually done by an expert at one visit I will instance the case of "R." The owner does not live near the apiary, and was not present. Of the eight stocks examined two were in good condition; three were actually starving (these were fed with surplus combs, and given an immediate dose of syrup); one had a last year's virgin queen, and was united to its neighbour; two were slightly affected with foul-brood, and had three combs burnt. Details of the work done were left for the owner, with warnings as to the spread of the disease. I mention this case in order to show what serious responsibility may at times devolve, of necessity, upon the expert, upon whom the blame for any error of judgment must inevitably fall.

*What he does.*—The principal duty of the expert, when making a tour of the membership, would appear to be the examination of stocks for the purpose of finding diseases, with a view to their cure and the taking of further precautionary measures to prevent the spread

of disease—in a word, the detection of foul-brood, which is admittedly the trouble most to be feared and the most difficult to eradicate. The disease, to be cured, must, of course, be detected, and for this work the expert of experience is pre-eminently qualified, having usually had access to hundreds of affected stocks, and having seen the dreaded foe in all its guises. He is prepared for the discovery of the incipient signs, and often detects the disease in the cases of strong stocks showing only single affected cells.

His time, in thoroughly examining such stocks, is well spent, and I would repeat that every assistance should be given by the bee-keeper, so that the expert's time may not be wasted in trifles. Having detected the trouble he treats the colony, advises upon the course to be pursued, and in many cases superintends the destruction of affected stocks.

It is a question whether this last should ever be expected of the expert. He must keep himself free from infection, and his visit is not always near to the time of day the best for the work. Yet it is certain that if he undertake it it will be done most thoroughly.

In another case the expert pointed out several weak stocks that were affected, and it was decided by common consent to destroy them.

After his departure, the owner read up the subject, resolved to essay their cure, failed in this, and one or more were eventually robbed out by his own and his neighbour's bees previously free from the disease!

There can be little doubt that the spring is a favourable time for the examination of stocks whilst these are building up, and are yet not so strong as to remove the larvæ as rapidly as they become tainted, but that this is the best time for cure, is open to serious question. This would be when the stock is at swarming point and honey is coming in, and for the expert to assist at this operation would mean, in most cases, a second or summer tour.

I could instance a surfeit of cases relating to the present year, where the spring visit has saved strong stocks from death by starvation, but a summer tour might be even more efficacious in the case of foul-broody stocks and their legatees.

Some associations can afford, and consider as indispensable, the autumn round, which would give three visits per annum, but not every county can afford these, eminently desirable though they may be.

*What he should do.*—Unfortunately, in some cases the expert's powers are limited, so that, however well-intentioned, he may be unable to do that which would ensure the wellbeing of surrounding bee-keepers, and make successful bee-keeping more possible than it is sometimes, owing to the culpable carelessness of ignorantly selfish individuals.

In a third case I was desired to examine the bees, and did so, as the visit of the Asso-

ciation expert was not due. Of seven stocks in well-tended and up-to-date hives, all were affected by foul-brood, although certified as healthy by the expert the previous year, 1902. I was informed by the owner that a neighbour kept bees in skeps, and that these often died out, but that no attempt was made at renewal, and that the owner declined to allow expert examination, and denied all knowledge of disease amongst his bees. There is no doubt that the bees may have become infected from this source.

Now, I ask, how is it possible to deal with a case of this kind without compulsory powers enabling the expert to make at least the necessary examination of all stocks? For it is, unfortunately, true that the very strongest and healthiest stocks are just those most likely to rob a dying and diseased lot.

We are told that in certain American States the disease has been practically stamped out by the efforts of foul-brood inspectors; and whilst it may not be practicable here to employ such for this sole purpose, nor advisable to place indiscriminate powers in the hands of the expert alone, yet the report of the latter might, with the aid of a County Council grant, be made to that body, one of whose officials could, if necessary, verify and order the destruction of the affected stocks. But, whatever the method of dealing with such cases, it is apparent that something must be done, and that soon, to help us in our efforts to stamp out this foul fiend of disease.

Bee-keepers, wake up! Legislation is not here yet, but we may have it if we will only work together for it, and not rest until we have sufficiently aroused and interested "the powers that be" in our crying need. First, let us get rid of our own lethargy.

I think that this is a matter for renewed discussion by district associations, but in the meantime let us strengthen the hands of our association if it possesses any vigour at all, work amongst our neighbours for the good cause, sink any petty jealousies, and we shall be amply repaid by the increased value for our own money, and the additional protection afforded to our own well-cared-for but dangerously situated stocks.—L. S. CRAWSHAW, *Ilkley*.

## Queries and Replies.

[3094.] *Doubling and Storifying*.—Would you kindly advise me through the medium of the BEE JOURNAL on the following points:—1. The "British Bee-keeper's Guide Book," under the head of "Doubling and Storifying" (page 58), says: "The hive containing brood-combs is now placed on top of the other stock, forming a second story." Thus a double set of combs is given; the hive full of comb is soon full of bees by the hatching above and below; and this immense population will

quickly fill with honey the emptied combs of upper story," &c. Am I right in taking this to mean that it is put between the two lots containing brood? 2. Should one queen be removed, or excluder be used, and the two lots worked something like a "Wells' hive"?—"*COTSWOLD*," *Oxon*.

REPLY.—1. The context on page quoted shows that the "second story" is simply an empty body-box in which is placed all the combs that contain brood from a strong stock, the remaining space being filled with empty combs or frames of foundation. Neither queen nor bees are removed from the hive depleted of its brood, these being brushed or shaken off combs and allowed to run back into their hive. 2. You will see from details given that no removal of queen takes place at all, and no queen-excluder is placed between the two chambers of the doubled hive. A careful perusal of "Guide Book" will make it quite clear as we have stated.

[3095.] *Italianising Stocks*.—I have three stocks in skeps which are at present transferring themselves to frame-hives by being placed above the top-bars. I wish to Italianise these stocks, and therefore ask:—1. Can I at the end of May remove old queen, drive the bees out of skep, throw them down at entrance of bar-frame hive, and drop an Italian queen amongst them as they run in? 2. Can I do this all in one operation, or would it be better to remove old queen a day or two beforehand?—S. D., *Kent*, May 7.

REPLY.—1. The plan you propose is not safe, and we do not advise its adoption. If you decide on direct introduction, first allow the bees to transfer the brood-nest below, and see that all brood is hatched out from combs of skep. Then remove the latter, cover the bees down comfortably in frame-hive, and allow them to settle down quietly for a day or two. Meantime, procure the Italian queens, and, after removal of queens to be deposed, introduce them according to the orthodox rule of Mr. Simmins' plan, viz, defer operating till dark; keep the queen quite alone in a clean matchbox for not less than thirty minutes without food; then go to the hive, and, by the light of a lamp, quietly raise the corner of quilt, give a puff of smoke to drive away any bees that may show themselves, and, pushing open the lid of matchbox, allow the alien queen to pass down between the combs; cover all down without disturbance, and do not interfere with the hive in any way for forty-eight hours. 2. Act as advised above, but preserve the deposed queen until it is seen that the Italian is accepted. Remove queen to be superseded the day before.

[3096.] *Handling Queen Bee*.—*Bees and Pollen*.—May I ask you kindly to answer the following questions? 1. Which is the proper way to pick up a queen, by the tips of her wings or by the thorax, and does the same apply to a worker bee? 2. Can old-bees live

on pollen alone for any length of time? 3. Do bees unload each other at entrance of hive or elsewhere? 4. Why do bees which have fallen to the ground, and have been there for some time, always fan for a long time at the entrance of the hive instead of running in at once when placed there? Is this a subterfuge on their part to prevent their being cast out as useless? In other words, do they try to make out that they have been "told off" to fan, and are not damaged bees to be ruthlessly cast out?—J. S. FORRESTER, *Norwich*.

REPLY.—1. Most experts pick a queen up and hold it by the wings, but at times it is expedient to grasp the insect gently by the thorax. 2. No. 3. Bees unload both honey and pollen within the hive. 4. We expect the "fanning" serves to express the pleasure of the bee at finding itself at home again. We can hardly attribute such cunning or deceptive tactics to the bees as you suggest.

[3097.] *Starting Bee-keeping*.—Being desirous of keeping bees, I am rather doubtful on one point, and therefore ask:—Is it necessary to be right out in the open country to be able to keep them? I am located in a suburb of Manchester, but for the bees to get right out into the country without many buildings round about they would have to fly a distance of three miles. Is bee-keeping possible under these conditions?—"DOUBTFUL," *Eccles, Lancs*.

REPLY.—The open country "with its fields and its flowers" is no doubt far better for bees than the suburbs of a large town, but hives have been known to prosper within a mile or two of Manchester. A very well-known bee-keeper has his apiary at Fallowfield, near Manchester. And here in the South bees are known to do well within three miles of Regent-street, London.

[3098.] *Renewing Combs in Hives*.—I would be very grateful for answers to the following queries:—I have one or two rather old combs in brood-chamber of one of my hives, which I desire to replace with frames fitted with full sheets of foundation. 1. Ought I to place the former in an upright position above the brood-chamber until the bees remove the brood and honey from them? 2. Is *brown Demerara* sugar (pure cane) detrimental to bees? 3. Is there any list of bee-flowers suitable for these Northern parts which you can recommend?—"NOVICE," *Aberdeenshire*.

REPLY.—1. The proper course is to remove an outer frame containing neither brood nor honey, and part the other frames so as to admit a frame fitted with full sheet of foundation in the centre of brood-nest. When this comb is partly built out (say a week later), remove another outside comb, and proceed as before, until all old and faulty combs are replaced by new ones. 2. Raw sugars are unsuitable for bee-food, being altogether too laxative, especially for winter food. 3. We think Messrs. Guthrie Bros.,

Alloway, Ayr, send out a list of bee-flowers suitable for the North.

[3099.] *Bees Killing off Drones in May*.—I visited my apiary on May 9, and noticed at one hive the bees were killing off the drones. Sometimes the unfortunate drone got away, but more often the victim was killed outright. On Sunday, May 10, they were still at it—the same "killing" work. I always thought the drones were killed later on in the season, or at close of the honey harvest. If this is so, why were they being killed at this season?—J. SKINNER, *Bristol, May 12*.

REPLY.—You are quite right in assuming that, as a rule, drones are only killed off by bees after the main honey-gathering of the season is ended, but variations from this rule do occur at times owing to varying causes. If, therefore, the drones of the particular hive in question are being killed off it is advisable to examine the combs and brood in order to see if all is in normal condition when compared with the other stocks where all is going on right. An experienced hand would probably soon detect the cause of trouble, but those less skilled must simply note the difference in the hives, as advised, and form their conclusions accordingly. For instance, there may be a superabundance of drone-comb in the hive, or a drone-breeding queen heading the colony, and, in consequence of shortage of stores, the bees are thinning down superfluous food-consumers.

[3100.] *Keeping Bees in Attics*.—I am thinking of starting bee-keeping this spring, and have already been promised a swarm of Ligurian bees and have studied the "Guide Book" and BEE JOURNAL. I could keep the hives in a garden well sheltered and against a south wall, but as I have two spare rooms above the offices, where they would be close at hand, and I could keep my eye upon them, I thought that if they would do as well there as in the open I would prefer the indoor location. I may say one room faces east and the other west, and both are attics, so have only a slate roof overhead. I therefore ask, if I kept the hives indoors, would it be necessary to have double walls to the hives, or would one be sufficient? I may say the town has only 500 inhabitants.—F. H. L., *Market Bosworth, Nuneaton*.

REPLY.—If the windows are not too high from the ground and fairly well protected from strong winds, the bees will do very well indoors. Pre-supposing, then, that you would cut an entrance (about 6 in. wide) in lower edge of window-sash, it would be well to provide a sheltered porch for a good-sized alighting-board projecting some distance outward, so that laden and tired bees returning home during high winds may fly right inside the sheltered porchway and not be liable to be dashed to the ground by the wind—maybe never to rise again to the entrance. Single-

walled hives are all that is needed in an indoor apiary.

[3101.] *Dealing with Drone-Breeding Stocks.*—1. Will you kindly inform me if there is any suspicion of foul brood in the three pieces of comb herewith? They are all out of one hive. The stock is very weak, and evidently the combs are very old; the bees were well fed up in autumn with syrup, and supplied with candy cake for the winter. 2. With regard to the small piece of comb and brood (marked No. 1), it was taken from a stock built up from four lots of driven bees from skeps united last autumn, and well fed. I cannot find the queen, and am afraid the stock is queenless. There are a great number of drones both inside and flying outside of the hive. Am I right in suggesting the brood is drone-brood? If so, what do you advise me to do? The stock at present seems strong. I thank you very much for your previous answers to my questions, and regret having to trouble you again.—T. W., *Maidstone.*

REPLY.—1. All three pieces of comb are badly affected with foul brood, and as the stock is weak and combs old, we advise total destruction by burning. 2. It is difficult to judge whether the colony from which the small bit of comb was taken is headed by a drone-breeding queen, or if a fertile worker has produced the drone-brood hatching in vorker cells. While your failure to find a queen points to the latter as being the more likely, we incline to the view that there is a drone-breeding queen in the hive, if drones are as plentiful as stated, but in any case the stock is worthless unless re-queened without delay.

[3102.] *Ligurianising Stocks.*—I am thinking of sending to one of your advertisers for an Italian queen. 1. Do you know anything of the firm (whose name I enclose) or their bees, and can you recommend them as reliable? As a subscriber to your paper I have thought of sending you a line from time to time, if acceptable. What a bad time we bee-keepers are having just now! For myself, I have to keep on feeding, feeding, and am getting almost tired of it. There does not seem to be any appreciable quantity of honey in the flowers, even when it is warm enough for the bees to go foraging. Nor do they seem to have got any help from the apple-blossom in the orchards this year. Of course, the frost spoilt the greater portion of that; the blossoms absolutely fell off before being fully opened. My bees are the common, or native, kind, and do not seem to breed fast enough to suit me; they are more healthy than the majority of stocks about, yet they do not get on as fast as I should like. I thought if I introduced a little Italian blood it might improve them.—G. G., *Worcester, May 12.*

REPLY.—1. The firm named are quite reliable, and will, no doubt, deal fairly with you. Anything you may have to impart with regard

to bees and bee-keeping that may be helpful to readers will be welcome at all times for publication.

## Echoes from the Hives.

*Easton, Bristol, May 12.*—All of my six stocks have wintered well; some of the hives looked like swarming on Sunday, the 10th, as there was always a crowd on the alighting boards, although I had entrances open about 9 in. wide. The bees crowd ten standard frames in five of the hives. Last year, bad as the season was, I had over 200 lb. of honey from my six stocks, and it did not cost me a farthing for feeding up, the bees having lived entirely on their own natural stores. I am going to put on supers in a day or two in order to try and check swarming. The pear and cherry bloom is all over here now, but apple blossom is fully out. For my own use I like fruit bloom honey better than that from clover.—J. SKINNER.

## Bee Shows to Come.

*A nominal charge of 2s. 6d. is made for notices in this column, which covers cost of insertion from order till date of show. Cash should accompany orders for insertion.*

June 9 and 10, at *Bishop Stortford.*—Annual Show of the Essex Agricultural Society. Bee and Honey Section under the management of the Essex and Suffolk Bee-keepers' Association. Entries closed.

June 23 to 27, at *London.*—"Royal" Agricultural Society's Show. Bee and Honey Section under the management of the B.K.A. Increased prizes for B.K.A. Associations as arranged in divisions or groups of counties. Entries closed.

July 22, at *Broughton, Hants.*—Fruit, Flower, Vegetable, and Honey Show. Twentieth year. Liberal prizes, with silver cup, valued £50,—open to the United Kingdom. Particulars from Fred. J. Hinwood, Broughton, Stockbridge, Hants. Entries close July 18.

July 22 and 23, at *Cardiff.*—Honey show of the Glamorgan B.K.A., in connection with the Cardiff and County Horticultural Society. Bees, hives, honey, trophies, wax, appliances, and articles of food. Substantial money prizes and medals. Free entries. Six open classes. Schedules from William Richards, Gabalfa, Cardiff. Entries close July 16.

July 29, at *Wallop, Hants.*—Honey Show of the Broughton and Wallop Branch of the Hants and Isle of Wight Bee-keepers' Association. Two open classes for single-section and 1-lb. jar respectively (entry free). Schedules from Miss Tucker, The Lindens, Broughton, Stockbridge, Hants. Entries close July 22.

July 29, at *Henbury, near Bristol.* Annual Show of the Henbury District Bee-keepers' Association in connection with the Horticultural Society's Exhibition. Several open classes with good prizes (two classes with free entry). Schedules from I. Atkin Waller, hon. sec., Pen Park, Westbury-on-Trym, near Bristol. Entries close July 24.

July 30, 31, and August 1 and 3, at *Old Trafford, Manchester.*—Annual Show of the Royal Lancashire Agricultural Society. Liberal money-prizes are offered for honey along with silver and bronze medals of the B.K.A. and also of the Society. Open classes for Honey-Trophy, Sections, Extracted Honey, Beeswax, Honey-Confectionery, Bee Flowers,

Instructive Exhibits in Bee-Culture, &c. Schedules from Edward Bohane, Secretary, Miller-arcade, Preston. Entries close June 30.

August 4, at Leamington.—Tenth annual show of the Leamington St. Mary's Horticultural Society. Three open classes for Six 1-lb. Sections, Six 1-lb. Jars "Light," and Six 1-lb. Jars "Dark" Extracted Honey, respectively. Liberal money prizes. Schedules from P. W. Smith, Secretary, 22, Leam-street, Leamington. Entries close July 30.

August 6, at Nantwich.—Honey department of the Cheshire Agricultural Society's Show under the management of the C.B.K.A. Numerous classes for hives, honey, and wax. Money prizes and medals. Schedules from T. A. Beckett, St. Werburgh's Chambers, Chester.

August 6, at Kingsthorpe, Northants.—Honey show of the Northants B.K.A., in connection with the Horticultural Society's Exhibition. Three open classes with special prizes, including one for single 1-lb. jar of honey. (Entry free.) Prizes 20s., 10s., 7s. 6d., and 2s. 6d. Schedules from R. Hefford, Hon. Sec., Sunnyside, Kingsthorpe, Northampton. Entries close August 1.

August 12, at Radstock, Bath.—Honey show in connection with the annual show of the Radstock and District Horticultural and Fanciers' Association. Schedules from the Secretary, B. M. Clark, 1, Fox Hills, Radstock, Bath.

August 27, at Llangollen.—In connection with the fifth annual Flower Show. Open classes for Six 1-lb. Sections, Six 1-lb. Bottles Extracted Honey, and Beeswax. Schedules from Frank Little, Castle-street, Llangollen. Entries close August 13.

August 27, at Montgomery, in connection with Montgomery and District Horticultural Show. Open classes for Six 1-lb. Sections and Six 1-lb. Jars Extracted Honey. Prizes in each class 10s., 5s., 2s. 6d. Entrance-fee 1s. each. Schedules from W. J. Jones, Secretary, Montgomery. Entries close August 20.

### Notices to Correspondents & Inquirers.

All queries forwarded will be attended to, and those only of personal interest will be answered in this column.

C. D. G. (Cams).—*Raw Sugar for Bee-Food*.—At no season of the year is raw or unrefined sugar quite suitable for bee-food, being liable to cause dysentery through the large amount of treacle or molasses it contains. It is, of course, less harmful as summer food than for wintering on, because of bees taking daily flights in warm weather. But refined cane sugar is at all times best for bee-food.

A. DALING (Essex).—*Wax-Moth in Skeps*.—We fear there are no means of destroying the wax-moth larvæ in skeps occupied by bees. With frame-hives it is different, and there is always some chance of dealing with the pest by examining for, and removing such frames of comb as are infected with, the moth grub. Broadly speaking, however, it may be said that the moth never makes any headway in a strong stock of bees if well managed by an experienced bee-keeper.

J. WATTIE (Cheshire).—*Honey Sample*.—Sample of granulated honey sent is good in colour and flavour, and fairly good aroma; very smooth in grain, and of about the consistency of very thick paste. In fact, it runs slowly from jar when latter is reversed, yet shows no signs of fermentation. We judge it to be mainly from white clover.

It may probably be Colonial honey, from New Zealand, but we do not share your view of its being a "Californian mixture."

F. A. (Birmingham).—Mr. J. R. Noble Bower is Hon. Sec. of the Warwick B.K.A.

### Suspected Combs.

*Special Notice to correspondents sending queries on "Foul brood."*

We urgently request that all letters sent with samples of suspected comb be put outside the box or tin containing the sample. Also that no more than a couple of square inches of comb be sent, taking care to neither crush the comb nor probe the cells before despatching.

In urgent cases (and where possible) we undertake to "wire" replies as to F.B. if six stamps are sent to cover cost of telegram. All letters should be addressed "Editor," not "Manager."

"KINGSLANE" (Peterston).—Comb sent contains a compact mass of unsealed brood, plump and healthy-looking in all respects, and occupying nearly every cell. The three sealed cells, however, show foul brood of old standing, and it is certain that the hatching brood will be more or less affected sooner or later. It would appear as if the bees are naturally vigorous and strong, with a good queen at their head, and their present vitality enables them to resist the disease to a great extent. We therefore advise removal of all cells such as we found to contain diseased larvæ, and use disinfectants, while carefully watching to see how newly capped brood hatches out.

J. H. (Millom).—The only cell of comb in which any trace of larvæ could be found showed foul brood of old standing. In every other sealed cell the dead larvæ had dried up and disappeared.

T. M. (Surrey).—No trace of brood at all in small bit of comb sent. We must have a fresher piece to enable us to say if affected with foul brood. The comb is, however, so old and black that it is quite unsuitable for further use in hives, whether diseased or not.

W. P. (Holbeach).—The small bit of crushed comb sent contains only chilled brood and pollen. Sample is, however, quite unsuitable for proper examination. You should also address samples to "Editors," not "Manager," and please read rules with regard to sending suspected combs.

A. C. T. (Maldon).—Comb contains chilled brood only.

H. R. C. (Anglesey).—Bad case of foul brood.

BETA (Cams).—There is foul brood in comb, but, if bees are worth saving, you may deal with them, as proposed, by "starvation process."

D. G. (Yorks).—No. 1 is a distinct case of foul brood. No. 2 shows slight trace of incipient foul brood in two cells only. Rest of dead brood chilled only.

\*.\* Some Letters and Queries are unavoidably held over till next week.

## Editorial, Notices, &c.

### BRITISH BEE-KEEPERS' ASSOCIATION

The monthly meeting of the Council was held at 105, Jermyn-street, S.W., on Wednesday, May 20, Mr. T. W. Cowan occupying the chair. There were also present Miss Gayton, Dr. Elliot, Messrs. D. W. Bishop-Ackerman, R. T. Andrews, W. Broughton Carr, H. Jonas, E. D. Till, E. Walker, T. I. Weston, F. B. White, and the Secretary. Letters explaining inability to attend were read from the Hon. and Rev. Henry Bligh, and Mr. C. N. White.

Prior to the commencement of business on the agenda, Mr. T. I. Weston (vice-chairman) expressed on behalf of himself and colleagues pleasure at the return to England of Mr. Cowan, after an absence of nearly five years in California. The welcome they were extending to Mr. Cowan would, he felt sure, be cordially endorsed by all bee-keepers. Mr. Cowan, in acknowledging the welcome, expressed gratification at meeting with his old friends, and his thanks for the continued confidence shown by the Council in electing him year after year to the chairmanship, notwithstanding his absence from their deliberations.

The minutes of the previous meeting were read and confirmed.

Mr. T. E. Whitelaw, 5, Highwood-road, Holloway, N., was duly elected a member of the association.

The report of the finance committee, presented by Mr. Weston, was approved.

The Secretary reported donations and promises to the Special Prize Fund amounting to £23 16s. He further presented a statement in regard to entries for the coming Royal Show, those for honey in the "grouped county" classes being considered very unsatisfactory. It was resolved to apply for permission to show amongst the Educational Exhibits at the Royal Show the Berks Association's bee-van, equipped for work.

Mr. Cowan stated that the Committee of Examiners had been sitting from 10 a.m. in connection with the examination of nine candidates for first-class certificates. The papers written by the candidates had yet to be examined, and a further report thereon would be presented at the next meeting.

The Council sanctioned the appointment of examiners of third-class candidates in Cornwall, Leicestershire, Lincolnshire, and Middlesex.

It was decided to make a grant in aid of the prizes for honey at the Dairy Show to be held in October, and to draft the proposals at the next meeting.

Mr. Weston was authorised to, if possible, arrange for a renewal of the insurance policy, for a further period of one year from August 1 next.

The next meeting of Council will be held on Wednesday, June 17.

### HONEY IMPORTS.

The value of honey imported into the United Kingdom during the month of April, 1903, was £2,637.—From a return furnished to the BRITISH BEE JOURNAL by the Statistical Office, H.M. Customs.

## Correspondence.

*The Editors do not hold themselves responsible for the opinions expressed by correspondents. No notice will be taken of anonymous communications, and correspondents are requested to write on one side of the paper only and give their real names and addresses, not necessarily for publication, but as a guarantee of good faith. Illustrations should be drawn on separate pieces of paper. We do not undertake to return rejected communications.*

*Communications relating to the literary department, reports of Associations, Shows, Meetings, Echoes, Queries, Books for Review, &c., must be addressed only to "The Editors of the British Bee Journal, 17, King William-street, Strand, London, W.C." All business communications relating to advertisements, &c., must be addressed to "THE MANAGER, 'British Bee Journal' Office, 17, King William-street, Strand, London, W.C."*

*\* \* In order to facilitate reference, Correspondents, when speaking of any letter or query previously inserted, will oblige by mentioning the number of the letter as well as the page on which it appears.*

### NOTES BY THE WAY.

[5123.] At last we have had a whole week of fine weather after the first seventeen days in May, during which we had continual rain, except on two days. It was also cold, wet, and dull, stopping all work in the apiary and keeping the bees indoors, so that we were feeding to keep them from starving. Large families and no income and little reserve of stores made matters serious, but the change soon put new life into the bees, and they have gone forth to the forage grounds, though for want of sunshine there was very little for them to gather for a few days. Yesterday and to-day, however (25th), they are working well.

We have had no swarms around us yet, except one on May 22, which issued from a skep belonging to an old lady who lives in a sheltered valley. I have some strong colonies, but do not expect any swarming in May this year, owing to the adverse weather. Bees cannot be produced to order in a few hours, like manufactured articles; no matter how good the weather, it still takes twenty-one days to produce the bee, and a few days longer before the insect is either able to swarm out or take up its duty in field work.

*Tall Sections.*—That worthy champion of the tall thin sections, Rev. R. M. Lamb, is still in love with the new shape—though I fail to see any advantage—in a 5 in. by 4½ in. section over a 4½ in. by a 4½ in. one. If the square-section is a "puzzle box" to the bees, are we to suppose that the ¾ in. in length or height will solve it for them? I have tried a few each year and shall do so again this season, but only as an experiment

or test. So far I have no occasion to wish for a new size section, because, in the first place, I have never the slightest trouble in getting my bees to take to the supers, and putting 15 oz. to 17 oz. of honey in the  $4\frac{1}{2}$  in. by  $4\frac{1}{2}$  in. by  $1\frac{1}{8}$  in. sections. Secondly, the new sections would cost more, require more foundation, and take larger squares of glass, which would again add to cost. Then a new supply of dividers, and an alteration of racks. All extra expenses] in production, and where is the advantage?

Every bee-keeper knows that bees build their store-combs thicker than those used for brood; an examination of any straw skep or box hive, or even a hollow tree, will prove this. It thus becomes clear that the natural instinct of the bee is a deep cell for stores; then why retard this natural tendency, unless there is some actual gain in so doing? I admit that the cost of modern hives (as "R. J. T." says on page 194) is a bar to many labourers taking up with modern bee-keeping. We also know that the cheaper kind of frame-hive is not equal to the better hives, such as the "Combination," or the "W.B.C.," for practical bee-work in our fickle seasons. The cottager is, therefore, doubly handicapped at the start; yet from actual experience in giving help and advice, I know my remarks were in accordance with facts. So long as I took the main share in the management, the returns were good, but when my personal care relaxed, they rapidly went back, and the bees were given up or sold outright. At the same time, I am glad to admit that the account of our friend "R. J. T." augurs well for his success in the future.

*Bee-Tent Work.*—After a quarter of a century's work of "driving" bees, I myself think the time is come when this part of the performance should be discontinued. We want to teach modern bee-keeping, and how to manage the frame-hive; and the manipulation of a frame-hive is calculated to foster the use of that hive rather than simply driving a skep of bees. Then another objection, and a real objection, to skep-driving is the possibility of spreading foul-brood around the precincts of the show-ground. Skeps are, or have been, obtained for "driving" purposes, somewhere near, or, at least, in the neighbourhood of, the show; and, I have no doubt, "experts" have known cases of bad breakdown and of foul-brood hives being sent for manipulation. With frame-hives the case is different; they are as an open book, and any disease can be seen at a glance.—W. WOODLEY, *Beeton, Newbury.*

#### PAINTING HIVES WITH "CARBONILIAN."

[5124.] I cannot but think that in your reply to "New Forest," on page 200 of B.B.J. of May 14, your notice of the possibly objec-

tionable odour of this or any other form of creosote paint is wise, but I would emphasise your note into a stronger form of warning. It is extremely doubtful whether the odour of coal-tar creosote ever leaves the treated wood, and it has an objectionable quality of tainting other substances in proximity. It was the late Mr. Geo. Neighbour, I believe, who at one time painted a number of his hives with a coal-tar paint, and thereby tainted and spoiled a number of sections. I do not know whether there would be a difference in this respect in favour of creosote distilled from wood, but I should be inclined to go slow, and make an experiment upon a very small scale. I would say that wood creosote is more expensive than coal-tar creosote, but is much the better of the two products, for the preservation of wood. Possibly the paint in question may contain so little of the creosote as to be free from objectionable qualities. Perhaps "New Forest" will let us know, through the JOURNAL, should he try it, and find it to be satisfactory.—L. S. CRAWSHAW, *Ilkley.*

[5125.] In reply to your correspondent, "New Forest, Hants" (page 200), may I say the kind of creosote he speaks about is "Carbolineum"? It is very largely used for railway sleepers, to prevent the ravages of insects. The legs of bee-hives might with advantage be dressed with it, to stop earwigs climbing up, but, if the hive body is painted over with Carbolineum, the bees will give notice to quit.—HERBERT BALLINGTON, *Matlock Bank.*

#### TALL SECTIONS.

REPLY TO THE REV. R. M. LAMB.

[5126.] Limited as my time necessarily is, I must send a few lines of reply to your reverend correspondent anent his letter in B.B.J. of 14th inst. (page 193). I will endeavour to keep cool and courteous as may be, in view of the sweeping criticism of my remarks in which he has condemned in a wholesale way before asking for the reason why I consider the "less innovations" in sizes of sections the better. I thank Mr. Lamb for his kind references to my late father, but fail to see why he judges "the chip of the old block" to be deficient in charity.

In this particular matter of tall versus square sections, I think I have some precedent to go by in my judgment of the tall and narrow section as against our  $4\frac{1}{2}$  in. by  $4\frac{1}{2}$  in. by 2 in. section to which the present generation has been educated. Firstly, some seventeen or eighteen years ago, when the Canadians brought over some forty tons of comb honey to the Colonial Exhibition in these same narrow sections, they caused a flutter for the time. But later on the then authorities of our craft



had ample demonstration of their good and bad points, and my late father and others imported a shipment of said "new" sections, with the result that a few years afterwards thousands of these sections were turned into fire-lighters! Again, on the introduction of narrow sections some five years ago, along with fence-separators, our ever-cautious Editor, "W. B. C.," in a leading article, advised us to "go slow" in the matter (I think I quote correctly). How then can it be said that the narrow section has not had time to come to the front? I think it safe to say its seeming advantages and disadvantages are about equal, and I speak not only of the "narrow" tall but the "narrow"  $4\frac{1}{4}$  in. by  $4\frac{1}{4}$  in. section. Here, however, let me say I would push the  $4\frac{1}{4}$  in. by  $4\frac{1}{4}$  in. as against the tall section any day as being more proportionate and marketable, and of better shape for standing the handling of railway and other servants. Indeed, in the latter particular the ordinary  $4\frac{1}{4}$  in. by  $4\frac{1}{4}$  in. by 2 in. section is many points ahead of narrow in that it provides a wider base and top attachment of comb, as also at sides, so that in well-filled sections the liability to become detached from the wood is reduced to a minimum. On the whole, then, when we consider glazing both sides with the glass between the uprights, &c., &c., the "new" section that has to replace our usual  $4\frac{1}{4}$  in. by  $4\frac{1}{4}$  in. by 2 in. with bee ways, must bring very tangible advantages along with it before it comes to stay. The tall sections necessitate alterations in existing racks or crates, in travelling crates to the market, and, certainly not least, hives that are scattered broadcast over the land that take exactly two ordinary section-racks, but not two tall ones.

I am not non-progressive, Mr. Lamb—it is all the other way—and I am not cranky, I hope. Our little "set to" will not be in vain if it calls out allies to the field, and using the pages of this journal to give either side its due.—DAVID RAITT, *Blairgowrie, May 23.*

### THE CURE FOR RHEUMATISM.

[5127.] It is apparent that the question of bee-stings as a cure for rheumatism is still a matter of interest for the lay Press, and that all now needed for the flotation of large "Rheumapathic" establishments is the testimony of bee-keepers, when we may later confidently expect the supply of the cure in small doses upon the ubiquitous automatic machine. I am induced to say this much after perusing a recent article in the *Daily Telegraph*, whose Berlin correspondent says:—

"Set a thief to catch a thief" is a maxim which has been found useful in many walks of life, but never before has it been tried in such an uncompromising and, it must be added, successful manner as by Dr. Perc, of Marburg, in the sphere of medicine. This disciple of

Galen delivered an address before a brilliant gathering of colleagues on the healing properties of the sting of bees in cases of rheumatism of the joints and muscles, as well as neuralgia. It was known from time immemorial, Dr. Perc pointed out, as a means of curing rheumatism among the lower orders who have no faith in medical science. The first member of the faculty to apply it was the learned physician himself, and 500 successfully treated cases bear witness to its efficiency. He, therefore, claims the right to regard it as a specific against rheumatic pain.

When the angry bee stings a healthy person the result is two-fold; a little mole is made on the spot and the part begins to swell; sometimes even headache and fainting fits may in exceptional cases ensue. If one is frequently stung by bees the organism gets gradually inured to the poison, so that although the little mole or mark is visible each time, there is no swelling whatever, the body being immune against the poison. If a patient suffering from rheumatism be stung by a bee the part affected does not swell at first, nor until the bee poison has been frequently introduced, and then the pain gradually vanishes from the rheumatic joint. Those established facts formed the basis of Dr. Perc's further experiments. He lets his patient be stung at first by a few bees, then by slow degrees he increases their number, the sting being inserted near to the joint or muscle affected. Of course the bee must not be allowed to wander from the point, as that might cause complications, at least so far as the 'sitting' is concerned. Like the famous American pill, it must not 'go fooling about, but stick to business.' In one 'sitting' he lets as many as seventy bees do their worst to his client. He described the case of one woman who, having suffered excruciating tortures from 'rheumatiks,' came to him for treatment. He informed his hearers that in the course of her cure he caused her to be stung 6,592 times, whereupon the audience before whom the learned physician was discoursing displayed a considerable degree of emotion. The woman is now healed and happy. Every organism which is once made immune against bee poison is equally immune against rheumatism. This new specific, if generally adopted, will give a fillip to apiculture, as well as relief to a much-suffering class of patients.

We are not told just what the "fillip" is to be; whether every patient is to become his own pincushion, a keeper of bees, and to stir them up each night before retiring; or whether a new industry is to spring up for the supply of bees to hospitals, specially vicious hybrids being at a premium! I seem to remember one old cottager, too stiff with "rheumatiks" to ring back his swarming bees with the sound of the brass pan and the tinkling cymbal; but such may be the exception, having, perhaps, dodged the remedy as worse than the disease.—L. S. CRAWSHAW.—*Ilkley, Yorks.*

## MARKETING HONEY.

[5128.] Thanks to the aid afforded by your advertisement columns, I have disposed of my rather large overplus of last year's honey, and can now start the coming season with an empty store-cupboard. Hitherto it has always been a worry to get the honey sold, as I have not time to canvass customers, and what I had left I generally fed the bees with in spring. As you may suppose, the bees didn't object to this—in fact, I rather think they benefited by the diet; but it is more satisfactory to sell, and give syrup-food when any keep in this way is needed. Again thanking you.—H. B., *Workshop, May 21.*

## BEES AND FLOWERS.

BEAUTY FOR BORDERS AND HONEY FOR BEES.

It is always gratifying to find influential journals connected with gardening devoting space in their columns to the subject of apiculture; but we do not often find matter so useful and full of interest to bee-keepers as the following article by F. M. Wells in a recent issue of our contemporary, *Gardening*, which we have pleasure in reprinting for the benefit of our readers who may desire to see more of the paper in which it originally appeared. Mr. Wells says:—

It matters little whether or not we keep bees ourselves, but it is worth much to grow a certain proportion of the flowers in our beds and borders that they are known to favour, simply for the pleasure of seeing them at work. If we have no bees, other people have, and some of them are sure to appear if we have but the flowers to offer them that they find to their taste.

There are many plants among the hardy and half-hardy annuals that delight the bees and attract them to our gardens. One of the best is the really old-fashioned Cerinthe. So well known was this plant as a flower for the bees that its old-time name was Honeywort, and as such many old authors write of it. It is a hardy annual, growing only to about 1 ft. in height. The one known as *C. retorta* is the most effective.

Another hardy annual of the same height that is excellent for bees is *Dracocephalum Moldavica*. The perennial forms of this plant are equally serviceable for the purpose. This subject belongs to the sturdy family of Lipworts, and its pretty violet blue flowers make a charming bit of colour in a border. *D. Canariensis* is the old-fashioned Balm of Gilead. In this plant, as in the Cerinthe, we secure for ourselves one of the truly "old-fashioned flowers."

A glorious touch of blue is to be achieved by growing the hardy annual *Phacelia campanularia*. And how the bees linger over it and hum their contentment! Just as attractive as it proves to the taste of the bees should it prove to the human sight, for it is really a beautiful plant. *P. tana-*

*retifolia*, with purple flowers, is only second in beauty and is of taller growth. I do not think the whites are effective; there are other white-flowered annuals greatly to be preferred.

*Eutoca viscida* is sometimes known as *Phacelia viscida*, and is a very good border plant. It delights in a dry, sunny position. It is just the kind of plant to grow in a border at the foot of a wall.

*Glaucium corniculatum*, with its bright red flowers, is a capital annual, and as it is dwarfish in character it may be planted towards the forefront of the border, as the flowers are well displayed.

*Collinsia bicolor* and *C. grandiflora* are to be recommended. There is another variety known as *C. verna*; but this requires autumn sowing. It is very early to flower, but the bees seem to scent it from afar, and soon are to be seen gathering the nectar from the blue and white blossoms.

I have been told that the Clarkias are favoured of the bees. If such is the case, then, while giving them a dainty dish, we supply ourselves at the same time with one of the most beautiful annuals we can grow. I speak rather of the beauty of form of the individual blossoms than of the habit of the plant, and in some cases the colouring; but if the white form be chosen, then in *C. pulchella integripetala alba* and *C. pulchella marginata flore pleno* we shall have blossoms that may be mingled with the tenderest exotics and excite no sense of incongruity.

Some of the Boraginacæ are valuable for bees, and among them the pretty red flowered *Echium Creticum* may be recommended. The plant is likewise suitable for a sunny dry position. A blue variety may be secured in *E. plantagineum*. They are annuals of a useful height, being some 2 ft. All the plants I have mentioned are annuals, but at some future time I hope to recommend some perennials that are attractive to our winged friends.

## WAX PRODUCTION IN MADAGASCAR.

The following particulars relative to the production of and trade in wax in Madagascar are taken from a report by the Governor-General of the island published in *La Quinzaine Coloniale* of March 10.

Madagascar is included amongst the wax-producing countries of the world, and its produce has always been appreciated on European markets. Up to the present, however, no colonists have taken up this industry seriously, in spite of its offering good prospects of remunerative returns.

There is no doubt, says the Governor-General, that bee-keeping, either alone or in connection with agricultural work, could be carried on extensively in Madagascar with good chances of success. Bees abound in the

forest regions which run from north to south parallel to the coast.

The exports of wax in 1901 amounted to 262,923 kilos. (263 tons), valued at 649,730 frs. (£25,989), as against 217,918 kilos, valued at 507,800 frs. (£20,312), during the preceding year.

The chief exporting centres are Tamatave, Mananjary, Vatomandry, Farafangana, Majunga, Analalava, Diego-Suarez, Vohémar, and Maroantsetra. Rafia, gum copal, and rubber are also collected by the natives at the same time.

The average price of the wax per 100 kilos. (2 cwt.) at the ports of shipment is as follows :—

Port of Shipment :—	Price in Francs.
Tamatave .....	250
Majunga .....	200
Vohémar .....	200
Fort Dauphin .....	200
Mananjary .....	250
Maroantsetra .....	145 to 160

—Board of Trade Journal, April 16.

### STIMULATING EARLY BREEDING.

#### WHY FEED SPARINGLY AND OFTEN ?

A few letters of inquiry received since the publication of my article about spring care of bees have shown me that some beginners do not understand the reason why bees should be fed sparingly and often to stimulate spring breeding. This is an important matter, and should be elucidated as fully as necessary.

When bees are not harvesting anything in the fields, they are comparatively quiet. Breeding takes place as the warm days come, but is not pushed with much vigour until the blossoms begin to appear and a little nectar is found. When this happens there is more stir in the hive. The bees that come home from the foraging ground, instead of depositing it in the cells, often hand their load to the young bees, so as to be able to get off to the fields again. Thus a number of bees are carrying food about in the hive, and whenever one of them meets the queen, she respectfully and deferentially holds her proboscis towards her, and offers her a taste. Being oftener solicited to eat, the queen consumes more honey, and her eggs are matured more rapidly. So, during a honey-flow, no matter how light it be, the queen's breeding increases until the fatigue of a protracted laying puts an end to her prolificness.

The doings that I have just mentioned may be witnessed daily in an observatory hive of a single comb, with glass on both sides. Such a hive is very useful for helping one to learn the habits of bees. You may read of such things in books or in the journals, but they do not impress themselves upon your mind when you read of them as they will if you are an eyewitness to the details of the hive-life. With such a hive you have a source of endless

information and amusement. You can see the actions of the bees when returning from the fields, the nursing of the young, the laying of the queen, the respectful care which the bees take of her, their sorrow when she is taken away, their labour to replace her, the rearing and hatching of both bees and queens, &c. An observation hive ought to be kept at least for a portion of the year, by every one who is desirous of becoming fully informed as to the habits of the bees.

If bees are fed sparingly and often, there is a constant carrying about of nectar, the queen is offered food often, the bees are stirred up and create more heat than if quiet, and the result is a greater amount of brood produced. If the food is given in large quantities, all at one time, for the entire season, and in order to enable them to reach the honey crop in safety, it will, of course, have a good effect, but will not be so advantageous as the same amount given at different times. The bees will store it away to use as is needed, but a few days after feeding they will be back again to a quiet condition, unless the flowers are appearing. To be sure, if there were flowers yielding honey, I should not think of advising any one to do any feeding. We are only speaking of the days, unluckily too numerous, in early spring, when the bees can find nothing, or next to nothing, in the fields. With repeated light feeding, the colony is kept in a stimulated condition, the amount of food consumed will be greater than if the nourishment is given all at one time, but the number of eggs laid will be much greater, and the colony will be strong earlier.

It is not sufficient to have plenty of bees in your hives, you must have them at the right time. If a colony remains weak till the honey yield has begun, unless the crop is to be protracted six weeks or more, not much good is done, seeing that it takes twenty-one days on the average for the worker-bee to hatch, and after that about ten days more before she becomes an active field-worker ; so it is in March and April that we must induce our bees to breed. The March bees strengthen the colony and enable it to rear the April brood on a larger scale, and the latter is in the field just about the time of the opening of the harvest.

Colonies which were fed sufficiently and properly, sparingly and often, during the spring months, are sure to make the best colonies for the harvest, unless their queen lacks in prolificness. Let me cite you an instance of involuntary feeding which will show the help that light and constant feeding gives to a colony.

At the end of the winter in 1902, we had a few hives in which the bees had died, though their supply of honey had been ample. Each of these hives contained several combs heavy with honey. They were cleaned up and closed up, awaiting the proper time to re-stock them with bees. They were very old hives, had been

manufactured by us in 1870, and had been in constant use since that time. One of the hives had a very small hole on the underside of its floor-board, a hole so small that only one bee could get through it at one time, and this even with some difficulty. This small hole was discovered by the bees of one of the stocks in the yard and they immediately went to work to appropriate the spoils. We had noticed the bees flying about, a few at a time, but a cursory examination had failed to reveal any trouble, so nothing was done to interfere with them. The robbing of that honey extended over the space of at least two weeks, by the bees of just one hive. It changed the condition of that colony so much that it seemed to have doubled its strength within a month or so, and its crop was about double that of the next best hive in the yard. It had bred its bees at the right time. The robbing of the combs had extended over this long period of time, just because it was impossible for the bees to get through the hole any faster, ever their own eagerness being an impediment to their progress, as two or three bees would often try to get in at the same time and interfere with one another's speed.

This is a good instance of the good done by feeding sparingly and often. I would, however, not recommend a voluntary following of a similar course. The bees that become accustomed to this robbing in the open air soon become a nuisance, while the bees that are fed at home in the evening are never led into bad practices unless pilfering chances are opened to them.

It is hardly necessary to repeat what I said before, that feeding should be done with judgment. A colony heavy with honey should not be fed, as it may accumulate too much. A good way to stimulate such a colony is to uncup a few cells of its sealed honey from time to time. The doing of this forces them to handle their honey, and acts in a similar way to feeding. On the other hand, a very weak colony that has but a few handfuls of bees requires but a very scanty feed. Too much will cause its ruin, for it will be unable to take care of it, and the robber-bees from stronger colonies will attack and may overpower this one. The apiarist must examine his colonies often, judge of their strength and their needs, and use care and discernment as to the amount and frequency of feeding to be done.—C. P. DADANT in *American Bee Journal*.

## Queries and Replies.

[3103.] *Unseasonable Manipulations*—I possess only a single stock of bees, and last autumn I sent a piece of suspected comb on which you reported "foul brood just developing." As it was late in the season, the bees were left on six combs with a good queen and fed with medicated syrup, and from their

flights on one or two occasions early this year I thought they were strong in numbers. After reading the articles on foul-brood which have lately appeared in the B.B.J. I decided to run the bees into a new hive fitted with "starters" of foundation; and, after four days, give them full sheets and destroy the starters. In pursuance of this plan, I ran them into this new hive on the 18th inst.; but, on examining the combs of the old one, could not find the queen or any trace of eggs or brood; and the bees would barely cover three frames. There were, however, several pounds of sealed stores left. I am afraid the hive is queenless, and shall be much obliged for your advice. I am a mere novice, and was not surprised at not being able to spot the queen; but surely I could see the eggs and brood if there were any? I now ask: Is the stock strong enough to be worth introducing a queen to; and, if so, should I shake the bees in front of the hive and run the queen in with them? To-day (May 19) the bees are clustering about the entrance, and many are crawling on the ground, some seem injured; and some are dead!—E. E. S., *King's Norton, May 19*.

REPLY.—It was an unfortunate time to choose for depriving bees of their combs and food, with weather so adverse as to cause the death of strong stocks through starvation. The reason, therefore, of the poor queenless bees clustering at the entrance of the empty hive, and dying off as stated becomes obvious. As regards re-queening, we fear it will not be worth the trouble and expense, for if long queenless the few bees will be old and quite unsuitable for building up a stock into profitable condition for this season's work.

[3104.] *Loss of Queen and Bees in May*.—I am a novice at bee-keeping, having only begun a year ago with a stock of Carniolans got from Mr. Sladen. The colony swarmed last year—a splendid big swarm, too. Both swarm and parent stock wintered well. I examined them and spring-cleaned both hives on April 10. Then the swarm appeared to shape better than the parent colony. Both queens seemed active. As the weather has been so unfavourable, I have not examined either till to-day, when, to my astonishment, the colony formed from the swarm appeared almost destitute of bees and no queen. They have been fed regularly in stimulating quantities, yet there appears to be no stores in the combs, and, so far as I could see, no brood. I have watched them each day, and have seen no sign of swarming; in fact, the hive was never full enough for that. I saw two or three cells which appear to be queen cells, one of which is sealed over; but the bees do not cover more than about two frames. I have reduced the number of frames to four, and packed them up warmly, then partly closed hive-entrances of the hive, and continue to feed the colony regularly. 1. Write back what is best to be done under the conditions

noted. The other hive is crowded with bees and brood. 2. What am I to do to prevent the parent-hive from swarming? Is it too early to super? There seems but little honey to be gathered at present. I am a regular reader of your paper, but have seen nothing to touch my case.—“NEMO,” *Kent*.

REPLY.—1. Without personal inspection little more than a guess can be made with regard to disappearance of queen and bees. Assuming then that the stock was strong on the 10th ult., as stated, it seems to us probable that some mishap has occurred to the queen during the examination on that date, and that a great portion of the bees have deserted and joined on to the other colony through their own hive being rendered queenless and broodless, in addition to being short of stores. The sealed queen-cell will most likely be found abortive, while the partly-built ones simply serve to show the vain attempts of the bees to raise successor to the lost queen. The few bees left are not worth re-queening. 2. The crowded hive should be supered at once in view of present fine weather.

[3105.] *Removing Skep-hives after Transferring.*—Though a regular reader of the B.B.J., I am quite a novice in bee-keeping, and the following may be of some interest to others like myself if you will kindly reply to my queries. I had a swarm of bees in straw skep, which was hived on May 21, 1901. In the spring of last year I made a bar-frame hive, and fitted its eleven frames with full sheets of foundation. When the proper time arrived I cut a hole in the quilt covering brood-nest of new hive, and placed the skep of bees on top of the quilt, so that the bees might transfer themselves into the frame-hive below, which they did all right, and I have left it on till now because, owing to the bad weather, the bees did not do much last season. I therefore ask when and how the skep should be taken off? Also, do you think I could manage the job myself, bearing in mind that I have never seen it done? Besides, I am, as stated above, only a novice at bee-work, and am away from home a great deal. A reply through B.B.J. will greatly oblige.—J. H., *Sawbridgeworth*.

REPLY.—There will be no difficulty whatever in removing the skep, the trouble to a novice being the task of ascertaining whether it is advisable and safe to take it away just now. If you have ever lifted out and examined the combs of a frame-hive, and can turn up the skep and examine the combs to see if they contain brood and stores, no more is needed. The task is simple and would only take a bee-man a few minutes. Your object is to see if the queen is breeding below; if she is, and there are three or four frames of comb containing a fair supply of food, the skep need not be replaced at all after removal for examining the condition of the lower hive. That is to say, if combs in skep are broodless

and foodless, take it away permanently and melt down the combs for wax, unless it is preferred to leave it on as a surplus-chamber for honey-storing, though we do not advise this course.

[3106.]—*Section-racks for “W.B.C.” Hives.*—Will you please tell me: 1. What advantages the “W.B.C.” section-rack has over those in general use, and does it contain the usual twenty-one sections,  $4\frac{1}{4}$  in. by  $4\frac{1}{4}$  in.? My hives, with one exception, are the “W.B.C.” 2. When ventilating hives in hot weather by raising them off floor-board with, say  $\frac{1}{8}$  in. wedges, I presume to be of use the outside cover must be also raised, say, by having the wedges made of section-wood (will not this be thick enough?) long enough to take in cover as well as hives. 3. Do you use full sheets of foundation in the sections? F. J., *Mountmellick, May 15*.

REPLY.—1. The sections hang in frames—three in each frame—and are handled as frames are instead of singly. The rack takes seven frames holding twenty-one sections. 2. The outer case is raised an inch or more by slips of wood placed across the corners of floor-board. 3. Yes.

[3107.] *Helping to Stamp Out Foul Brood.*—I was yesterday asked to look at a hive supposed to be affected with foul brood last year, but now believed by the owner to be all right owing to its being strong in bees. On examining I found the bees strong as stated, covering ten frames. 1. There was every indication of foul brood, and wishing the owner to have proof I enclose sample of the brood-comb for inspection, and ask for your opinion thereon. There were two bee-less hives standing close by, each containing old combs, and the second sample is taken from one of them. There has been no bees in the hive for twelve months. I shall suggest that the owner gets a new hive and if this is done I will shake and brush the bees off each frame and run them into a skep. Confine them therein for forty-eight hours without food; then treating them as a swarm, throw the bees on to an enlarged alighting board and run them into the new hive. I shall burn the skep and all the old frames along with combs. There are some frames fitted with new foundation in one of the empty hives, and also three in the stock hive. 2. Would you suggest burning the lot? Now comes the most important thing to me personally. I do not mind assisting a fellow bee-keeper when in trouble, but am none the less anxious to prevent any mishap to my own bees in consequence, and so I ask. 3. How shall I disinfect my implements and clothing after working about the infected hives referred to. Owing to bad weather I am feeding my own bees, and do not want to infect them, and will therefore be greatly obliged if you would kindly “wire” reply to the owner with regard to foul brood in comb sent, and also please send me a supply of naphthol beta and

naphthaline. I send name and address for reference, and sign—"AN OLD READER," *Gloucester, May 24.*

REPLY.—1. The comb is affected with foul brood. 2. Yes. 3. We think you have the "Guide Book," and if this is so, act according to instructions therein with regard to disinfecting clothing, hives, &c.

[3108.] *Bees Dwindling in Spring.*—Would you kindly enlighten me on the following? I am only a beginner in bee-keeping this year, and in April last I purchased a stock which had wintered well, and the bees were quite strong in numbers. The stock had been fed well about twelve days before purchase, and I continued to give food slowly, but I have noticed a gradual falling off in the numbers of bees. About a fortnight ago they were working splendidly, but all at once they became quiet and inactive, and on inspection I found that I had not half as many bees in the hive as when it arrived, and I therefore thought I must have lost the queen. I noticed that the syrup was running down the combs on to the hive floorboard. There was also a lot of the syrup (I take it) not sealed over. I got a bee friend to inspect the hive, and he found the queen all right, but no brood, and he was surprised at the small number of bees. He seems to think I have over-fed them with syrup. So I have taken two old combs out, and replaced by frames of comb-foundation. 1. Should I continue to remove the old combs and replace by foundation as they are drawn out by the bees? 2. Shall I have caused dysentery by over-feeding? Thanking you kindly for reply in B.J.—ROBERT WM. POTTER, *Huddersfield.*

REPLY.—1. The falling off in the number of bees is obviously owing to the age of queen and bees, and the unfavourable condition in which the stock was prepared for winter. It is simply a case of "spring dwindling," as the term goes. The bees are mainly aged workers, played out by last season's labours, and naturally die off rapidly while there are no young, lusty ones being reared to take their places. In such a case the stock should have been carefully nursed by packing as warmly as possible and stimulating with warm syrup, placed directly over the cluster, so as to be accessible at once. Whenever food is given, care must be taken to get the bees to "feed" from it, otherwise the feeder may be neglected and the syrup run down among the combs, as yours did, and do far more harm than good. It is little use giving comb-foundation to a small lot of bees dwindling in numbers and broodless at this season, for if the queen cannot be started breeding, you have small chance of getting bees to build out new combs. The colony is evidently in a bad way owing to the faults we have named, viz., aged queen and aged bees. 2. Overfeeding will not cause dysentery if food is suitable.

[3109.] *Supering with Shallow-Frames.*—Will you kindly advise me on the following little difficulty? I supered a hive to-day with shallow frames, but the crate would not fit so that the respective frames above and below could be parallel with each other. Consequently the frames above and below hang crosswise. Will this arrangement be detrimental to the working and storing of the bees, or would you advise removing the shallow frames and substitute sections? I have the excluder beneath the surplus-chamber now, but as the frames are, as I have said, cross-wise, it might be advantageous to dispense with the zinc. Thanking you in anticipation for an early reply in our B.B.J.—J. R. T., *Romford.*

REPLY.—No appreciable difference will be found in working frames of surplus-chambers at right angles with those below; nor is there any need for removing excluder zinc in consequence of frames crossing those of body-box.

[3110.] *Bees Deserting Hive after being Robbed.*—I shall be glad if you can suggest any solution to the following:—On Sunday, the 10th, robbing was started in one of my stocks. Next day being wet everything seemed about normal, but on the evening of the following day (Tuesday) I find every bee gone! The, to me, curious part of the affair is that there are hundreds of eggs apparently just laid, and larvæ in various stages, but no capped brood, and plenty of sealed stores. What strikes me as most curious is that the queen appeared to have only commenced laying five days or so, and then totally disappeared.—"PUZZLED," *Wealdstone.*

REPLY.—Such desertions of hives by bees, as you give details of, do occur occasionally, but happily not often. The only explanation we can give is that the excitement caused by robbing and carrying off the food to a contiguous hive communicates itself to the bees of the robbed stock, and they join hands with the marauders in the latter's hive.

[3111.] *Suspected Queenlessness.*—Will you kindly help me in the following difficulty? I bought a straw skep about three months ago containing a last year's swarm. The bees work pretty freely gathering pollen when weather permits. I have looked inside, but can neither see sealed brood nor any other kind of brood, and therefore ask:—1. Would bees work if queenless? 2. If there is no queen would you advise re-queening?—O. T., *Huddersfield.*

REPLY.—1. In view of the difficulty of examining combs in skeps it is not quite safe to assume queenlessness when pollen is being carried in.

#### TRADE CATALOGUE RECEIVED.

GEORGE ROSE, *Liverpool, Preston, and Ormskirk.* Head Office, *Great Charlotte-street, Liverpool.* Mr. Rose's ninety-six page catalogue forms one of the largest and most comprehensive lists we have so far seen. It

includes a full line of seeds and plants for gardeners, and as complete a list of hives and appliances as the most ardent bee-keeper could desire, all articles being fully described in detail, priced, and numbered, for convenience when ordering.

We also note that Mr. Rose stocks an exceptionally full line of American bee-goods made in the U.S.A., alongside those of British make as used in this country. On the whole we may say the big list before us is got up on the most progressive lines, and will be very useful for reference.

## Echoes from the Hives.

*Hayle, Cornwall, May 19.*—My fifteen stocks, all in frame-hives, are doing fairly well, which is more than I can say for others around me. I examined a little apiary of four hives on May 16, and found two of them almost starving. In one, the bees clustering on their combs were too weak to fly, and there was about a pint of bees dead on the floor-board. I set to work and soon made a feeder from a syrup tin. Then prepared some syrup, and next day had the pleasure of seeing the revived bees flying strongly and likely to do well. I have one stock now crowding thirteen standard frames and working well in sections.—THOS. STAPLETON.

*St. Martin, Cornwall, May 23.*—I had my first swarm, and a very large one, on the 22nd inst. Last year my first swarm occurred on May 24.—G. WALTER JERVOIS.

## Bee Shows to Come.

*A nominal charge of 2s. 6d. is made for notices in this column, which covers cost of insertion from order till date of show. Cash should accompany orders for insertion.*

**June 9 and 10, at Bishop Stortford.**—Annual Show of the Essex Agricultural Society. Bee and Honey Section under the management of the Essex and Suffolk Bee-keepers' Association. Entries closed.

**June 23 to 27, at London.**—"Royal" Agricultural Society's Show. Bee and Honey Section under the management of the B.B.K.A. Increased prizes for B.K.A. Associations as arranged in divisions or groups of counties. Entries closed.

**July 22, at Broughton, Hants.**—Fruit, Flower, Vegetable, and Honey Show. Twentieth year. Liberal prizes, with silver cup, valued £50, open to the United Kingdom. Particulars from Fred. J. Hinwood, Broughton, Stockbridge, Hants. Entries close July 18.

**July 22 and 23, at Cardiff.**—Honey show of the Glamorgan B.K.A., in connection with the Cardiff and County Horticultural Society. Bees, hives, honey, trophies, wax, appliances, and articles of food. Substantial money prizes and medals. Free entries. Six open classes. Schedules from William Richards, Gabalfa, Cardiff. Entries close July 16.

**July 29, at Wallop, Hants.**—Honey Show of the Broughton and Wallop Branch of the Hants and Isle of Wight Bee-keepers' Association. Two open classes for single-section and 1-lb. jar respectively

(entry free). Schedules from Miss Tucker, The Lindens, Broughton, Stockbridge, Hants. Entries close July 22.

**July 29, at Henbury, near Bristol.** Annual Show of the Henbury District Bee-keepers' Association in connection with the Horticultural Society's Exhibition. Several open classes with good prizes (two classes with free entry). Schedules from I. Atkin Waller, hon. sec., Pen Park, Westbury-on-Trym, near Bristol. Entries close July 24.

**July 30, 31, and August 1 and 3, at Old Trafford, Manchester.**—Annual Show of the Royal Lancashire Agricultural Society. Liberal money-prizes are offered for honey along with silver and bronze medals of the B.B.K.A. and also of the Society. Open classes for Honey-Trophy, Sections, Extracted Honey, Beeswax, Honey-Confectionery, Bee Flowers, Instructive Exhibits in Bee-Culture, &c. Schedules from Edward Bohane, Secretary, Miller-arcade, Preston. Entries close June 30.

**August 3 (Bank Holiday) in the Walled Meadow, Andover.**—Honey Show in connection with the Andover and District Horticultural Society. Class for single 1-lb. jar of extracted honey (with no entry fee). Also classes for sections, extracted honey (light and dark), and beeswax. Schedules from the Hon. Sec., Dr. Gillett, Elvin House, Andover. Entries close July 28.

**August 4, at Leamington.**—Tenth annual show of the Leamington St. Mary's Horticultural Society. Three open classes for Six 1-lb. Sections, Six 1-lb. Jars "Light," and Six 1-lb. Jars "Dark" Extracted Honey, respectively. Liberal money prizes. Schedules from P. W. Smith, Secretary, 22, Leam-street, Leamington. Entries close July 30.

**August 6, at Nantwich.**—Honey department of the Cheshire Agricultural Society's Show under the management of the C.B.K.A. Numerous classes for hives, honey, and wax. Money prizes and medals. Schedules from T. A. Beckett, St. Werburgh's Chamber, Chester.

**August 6, at Kingsthorpe, Northants.**—Honey show of the Northants B.K.A. in connection with the Horticultural Society's Exhibition. Three open classes with special prizes, including one for single 1-lb. jar of honey. (Entry free.) Prizes 20s., 10s., 7s. 6d., and 2s. 6d. Schedules from R. Hefford, Hon. Sec., Sunnyside, Kingsthorpe, Northampton. Entries close August 1.

**August 12, at Radstock, Bath.**—Honey show in connection with the annual show of the Radstock and District Horticultural and Fanciers' Association. Schedules from the Secretary, B. M. Clark, 1, Fox Hills, Radstock, Bath.

**August 27, at Llangollen.**—In connection with the fifth annual Flower Show. Open classes for Six 1-lb. Sections, Six 1-lb. Bottles Extracted Honey, and Beeswax. Schedules from Frank Little, Castle-street, Llangollen. Entries close August 13.

**August 27, at Montgomery.** in connection with Montgomery and District Horticultural Show. Open classes for Six 1-lb. Sections and Six 1-lb. Jars Extracted Honey. Prizes in each class 10s., 5s., 2s. 6d. Entrance-fee 1s. each. Schedules from W. J. Jones, Secretary, Montgomery. Entries close August 20.

## Notices to Correspondents & Inquirers.

*Letters or queries asking for addresses of manufacturers or correspondents, or where appliances can be purchased, or replies giving such information can only be inserted as advertisements. The space devoted to letters, queries, and replies is meant for the general good of bee-keepers, and not for advertisements. We wish our correspondents to bear in mind that, as it is necessary for us to go to press in advance of the date of issue, queries cannot always be replied to in the issue immediately following the receipt of their communications.*

*All queries forwarded will be attended to, and those only of personal interest will be answered in this column.*

**J. S. F. (Norwich).**—*Bees and Pollen.*—We rather think that allowance must be made for poetic licence in the description quoted.

In fact, it needs only to watch bees at work to realise how regularly the worker-bee hurriedly "waddles" into the hive when loaded with big pollen-pellets, without waiting to be relieved of its load at the doorway, as described by Victor Rendu forty years ago.

C. G. F. (St. Albans).—*Queen Cast Out*.—Queen shows only a faint trace of Ligurian marking. If you are correct with regard to the queen-cell found, and that a young queen has recently emerged from it, it seems certain that the old queen cast out has been superseded. Examine again in a few days, and if you cannot find queen look for newly-laid eggs, which will show if she is there.

X. Y. Z. (Wandsworth Common).—*Wax-Moth*.—The larva sent is that of the small wax-moth, not the destructive *Galleria cereana*, or true wax-moth, the larva of which measures about one inch when full-grown.

F. E. MATTHEWS (Birmingham).—*Drones in Worker-cells*.—With a queen of last year and normal worker-brood in eight frames, it certainly is unusual to find drone-brood being reared in worker-cells in the latter half of May. However, as there are only a few cells so occupied, it need cause no alarm for the welfare of what is evidently a strong, prospering colony.

FOWLER (Bournemouth).—*Lymington as a Bee District*.—Without having any personal knowledge of Lymington, we should say that few counties surpass Hants for bee-forage.

H. BALLINGTON (Matlock Bank).—The queen sent is an adult, but bears none of the usual signs accompany old age, or of being worn out.

A. FERGUSSON (Argyll, N.B.).—*Insurance for Bee-keepers*.—Where there is no county B.K.A., applications for insurance may be sent to the Secretary, B.K.A., Mr. E. H. Young, 12, Hanover-square, London.

F. H. (Sussex).—*Buying Swarms*.—There is little to fear if you purchase natural swarms from a known and reputable man. It is not too much to say that dealers in bees who are advertisers in our pages have a reputation to keep up, and will not wilfully send out bees other than healthy.

#### *Suspected Combs.*

"IGNORANT" (Surrey).—We find no disease in comb.

R. H. (Clonmel).—No trace of brood at all in comb sent. Nothing beyond a few cells partly filled with pollen and sealed honey.

L. B. (Carnforth).—The so-called "coffee-coloured substance" resembles diseased larvae in colour only. It looks more like treacle or syrup made from raw sugar. If the other combs are well filled with healthy brood as stated, you need feel no alarm with regard to disease, but there was no brood at all in sample.

T. H. HOLDAWAY (Wroxhall).—Comb contains worker brood only. It is a clear case of death from starvation, not disease.

T. LAWN (Cambs) and W. A. K. (Prestwick).—Both samples are affected with foul brood.

G. N. (Reading).—The brood in larger sample seems all right, and bees were rapidly hatching out. The coloured substance in unsealed cells is freshly gathered pollen. We found one cell in smaller sample affected with incipient foul brood; the disease is therefore developing in the stock whence sample was cut.

J. C. (Ayrshire).—Foul brood is rapidly developing in comb sent. Since you already possess the "Guide Book," we can add nothing useful to what is recommended therein with regard to "treatment."

AN OLD BEE-KEEPER (Hunts) and G. E. B. (Lincs).—Bad cases of foul brood.

T. A. J. (Holywell).—1. Comb is badly affected with foul brood, so you did well to destroy the bees and combs, &c. 2. Refer to "Guide Book" for directions how to protect the other hives. 3. When stocks are weak and diseased it is quite common to see several eggs in single cells. 4. No need to remove old queen cells after swarming.

W. T. (Lavenham).—No disease in comb, but queen is evidently worthless, as shown by drone-brood in worker cells.

E. J. (Cambs).—Samples marked 3 and 6 show foul-brood developing in a few of the cells, but no larvae in an advanced stage of the disease. In No. 6 the bulk of brood seems all right, and was hatching out when received; but in three cells we found decided samples of foul-brood in the advanced stage. You will see a description of how the stocks should be treated in both stages in "Guide Book," if the reply to "Kingslane" (page 210) does not meet your case.

FAX (Eltham).—Comb contains neither brood nor food, nothing more than pollen.

J. D. (Thirsk).—No disease in comb; but it is so old and black as to be hardly fit for the melting-pot, to say nothing of its being suitable for the bees' use.

T. W. (Maidstone).—We regret to say all three samples of comb are affected with foul brood. Nos. 1 and 2 are badly diseased and No. 3 still worse. The strong lots may be got off combs and treated as swarms in accordance with known methods, but the weak lot is worthless and should be destroyed.

#### *Honey Sample.*

CUMBRIA (Keswick).—Sample is almost wholly from heather. It is of very good quality for table use.

\*.\* We regret to be compelled to hold over many Queries till next week in consequence of the crowded state of the Query Column.



## Editorial, Notices, &c.

### BEE-KEEPERS' INSURANCE SCHEME.

We are very pleased to publish the following letter from the Vice-Chairman of the British Bee-keepers' Association. Its importance to all readers needs no emphasising at our hands by way of illustrating the usefulness of the insurance scheme to all who keep bees.—[EDS.]

DEAR MESSRS. EDITORS,—In the interest of all who keep bees I ask you to give the fullest publicity to the following statement. The owner of one of the largest apiaries in the Eastern Counties became a member of the B.B.K.A. in January, 1903, and in March last joined the insurance scheme, paying his 1d. per hive on 150 stocks. On May 18 a mare and foal belonging to a neighbour were in a pasture adjoining the apiary, and in some way the foal became entangled with the head-ropes of the mare, causing both to plunge about violently. The plunging and commotion soon aroused the bees, and they came out of the hives in battalions to drive off the disturbers of their peace; but though the owner of the bees, on seeing the condition of affairs, lost no time in going to the rescue (and notwithstanding his efforts), the result of the bees' attack was the death of the foal and a severe stinging of the mare. The next morning found the bee-keeper in receipt of a claim for damages and veterinary expenses, which he promptly forwarded, with full particulars, to our Secretary at 12, Hanover-square. Mr. Young without delay placed the claim before the underwriters, who requested information on certain points. On Wednesday, the 27th, I was able to satisfy them on those points, and the case being clear and *bonâ-fide*, the claim was settled, in full, to the satisfaction of all parties, ten days only having elapsed since the time of the accident. Will you now permit me to urge on the bee-keepers of this country the advisability of taking advantage of the very liberal scheme put forward by the B.B.K.A. For the insignificant sum of one penny per hive they can be secured to the extent of £30 against damage caused by their bees to third parties. For members of affiliated county associations the scheme is worked through their secretaries, and persons who are not members of any association can, by sending a stamped and addressed envelope to Mr. Edwin H. Young, 12, Hanover-square, obtain full particulars. The policy of insurance for the season 1903-4 will date from August 1, and the schedule list of members forming the scheme will be opened on July 1.

Thanking you in advance for the kind consideration your columns always afford us.—T. I. WESTON, Vice-Chairman, B.B.K.A., May 28.

## Correspondence.

The Editors do not hold themselves responsible for the opinions expressed by correspondents. No notice will be taken of anonymous communications, and correspondents are requested to write on one side of the paper only and give their real names and addresses, not necessarily for publication, but as a guarantee of good faith. Illustrations should be drawn on separate pieces of paper. We do not undertake to return rejected communications.

Communications relating to the literary department, reports of Associations, Shows, Meetings, Echoes, Queries, Books for Review, &c., must be addressed only to "The Editors of the 'British Bee Journal,' 17, King William-street, Strand, London, W.C." All business communications relating to advertisements, &c., must be addressed to "THE MANAGER, 'British Bee Journal' Office, 17, King William-street, Strand, London, W.C."

\* \* In order to facilitate reference, Correspondents, when speaking of any letter or query previously inserted, will oblige by mentioning the number of the letter as well as the page on which it appears.

### AMONG THE BEES.

#### BEE-KEEPING IN SCHOOLS.

[5129] The authorities of the Education Department have not hitherto done much to help in spreading the cult of bee-keeping, but on more than one occasion, indirectly at least, they have been the means of throwing cold water on several attempts to introduce apicultural instruction into the public school curriculum. As a "special" subject it was distinctly tabooed some years ago. Of late, however, it was occasionally introduced and taught in a tentative and spasmodic manner under the head of "Nature Knowledge." Many country teachers, independent of official sanction, took up the subject *con amore*, and, apart from regular school work, carried on courses of instruction which did much to disseminate a knowledge of, and a love for, the pursuit. Now we seem to be approaching the dawn of brighter things, for the subject is at last recognised as a natural branch of study worthy of being specially commended. Instead of being utterly ignored, or openly condemned, it is actually approved as a branch of rural economy deserving of sanction and approval.

One of the latest of the many circulars being issued from Whitehall, is that offering suggestions for supplementary courses of instruction in day schools; and, in the course for rural schools, we have quite a number of practical suggestions wide and varied in their scope and embracing many points of special interest to all dwellers in the country. In an agricultural community where farming is almost or at times altogether, the sole industry, plant life must bulk extensively in any such course. Agriculture, horticulture, and apiculture—the latter being the "poetry of agriculture"—being bound up in any system of rural economy must all find a place; and as a natural sequence comes the inclusion of our hobby. Accordingly we find ourselves being advised that the nature study lessons given in the rural course should be so amplified and extended as to be useful in the work of field and garden. "School gardens"

are recommended; while much may be done with window boxes and flower pots. Approaching nearer our subject we find it stated that "the history of weeds, flowers, and insects should be worked out." Weed and insect pollination of plants would also prove an interesting study, and would naturally lead to *observations on bees and bee-keeping at the nearest bee hive*. The words I have italicised, so far as I know, for the first time, give official sanction for the teaching of apiculture in schools, and so may yet work out a little revolution in helping to extend a knowledge of our industry in its newest and best form.

Up to the present the expressive influence of want of official sanction and approval has checked any desire on the part of publishers to issue any special text-books on bee-keeping, and the result is that at the present time no work exists capable of being recognised as a fitting book to put into the hands of either pupils or teachers. Scrappy chapters, dealing generally in second-hand information are, indeed, common in various reading books and in a few dealing specially with Nature knowledge. Many of them, however, convey erroneous notions, facts being mixed with a large percentage of fiction. Some are actually filled by pages quoted almost verbatim from works written in the first century of the Christian era! I believe in Columella, but would prefer that children should receive their first notions of bee-keeping from some other and more modern source. These compilers seem utterly oblivious of the momentous changes wrought in apiculture since the advent of modern bee-keeping, when for the first time the industry has been established on anything like a scientific basis and carried on on intelligent lines.

I would not be in favour of much book work, but I would by no means despise the use of a good text-book, and indeed consider it a necessity. Yet from the nature of the subject the instruction must be mainly practical, and the lessons chiefly from facts derived by observation. Care must be taken that the course of lessons secures that practice is based on seasoned and well illustrated theory. By clear explanation, illustrated wherever possible by simple experiments, the pupils should be made to understand and appreciate "the reason why" of the detailed practical methods taught. "The children should be trained and encouraged to observe, test, note, compare, and infer for themselves." By carrying on the teaching in the spirit of these wise words, country children can be taught a love for the flowers and the bees, which will bear fruit in brightening their lives, and the result will tend to make many a rural home cheerier and happier.—D. M. M., *Banff*.

NOTE.—Alas for the mutability of human wishes, and for the short-lived schemes of mice and men! The famous "Circular 374" is likely to prove abortive, and so my little roseate dream may sink with it into oblivion.

In the hope, however, that it may do some good in drawing attention to the pursuit and help to disseminate a knowledge of our hobby, I will let my article stand. Perhaps, indeed, the whole scheme savoured too much of Utopia for this utilitarian age, and that only a chosen few will ever know the full joys of a beeman's ideal bliss.—D. M. M.

#### BEE-KEEPING FOR COTTAGERS.

[5130.] I quite agree with the remarks of Mr. Woodley, on page 183, when referring to bee-keeping cottagers as a class. Most of them are too indolent or too careless to start the modern system of bee-keeping. They are either unable or unwilling to go to the expense of buying a new frame-hive, and if they manage to get one without purchase will not look after it. I have myself, on urging the advantages of the modern plan, been answered something after this fashion:—"I am quite satisfied with the old system, it's good enough for me. Wooden hives are too dear, sections the same. If one does buy some, half of them get broke in doubling them up, and you can't sell them when filled." These are the sort of complaints one meets with. In fact, my own experience is, give a cottager a frame-hive, put the bees in for him, tell him how to manage the hive and what appliances to get, hand him a catalogue of a well-known and reliable appliance-maker, and hope you have rendered some useful help. Call again next season and you may find the hive as you left it. A few thicknesses of brown paper may have been put on for the winter, the bees have eaten their way through it, and, perhaps built combs to the roof. If you want to help him to straighten things up again and ask for his smoker, it is a hundred to one he has never bought a single thing you advised him to get. So much for the old skeppist and getting him to mend his ways. On the other hand, the cottager, with whom you will succeed in making a modern bee-keeper of, is the one who has never owned a skep. Let him pay you a few visits and watch you at work among the bees. Give him a "Guide Book," and get him to read it. That will do more good than any lecture. He soon gets interested, and if he is made of the right stuff he succeeds. The skeppist tells you that it "doesn't pay to start bar-frame hives, they are too much trouble." I visited one who had over thirty stocks in domiciles varying from a well-made frame-hive to an old soap-box with a sack thrown over it, skeps, old galvanised iron buckets, and coal-scuttles included.

This plan of keeping bees pays them, they will tell you, better than the modern method. When the man who takes their honey intends to make his annual call he writes to say he will be there on a certain day, and the bee-keeper decides on how many lots he will keep for stock and the rest of the poor bees are condemned to the sulphur pit. The honey-

buyer calls in the morning with three barrels numbered 1, 2, and 3. He cuts out the combs, puts best honey in barrel No. 1, dark-coloured in No. 2, and brood in No. 3. The bee-man gets his skeps, boxes, and buckets back and 3d. or 4d. per lb. for the honey. He has no trouble with live bees and no stings, and his money is handed over to him. I started in this way myself, but now have a modern apiary which I am pleased to show any one, amateur or professional. I also enclose my statement of accounts for last year, written up April 1, 1903. My total harvest was 336 sections, 257 lb. of extracted honey and 15½ lb. of wax. The total sales so far are given, so that I have in stock, used myself, and given away the remainder, viz., 75 sections, 61 lb. of extracted honey, and 10 lb. of wax :—

EXPENDITURE.

	£	s.	d.
Appliances ... ..	13	7	8
Carriage and Postages... ..	2	14	6
Entry to Shows ... ..	1	9	6
Newspapers and Advertisements ... ..	1	13	4
Bees bought ... ..	7	15	0
Subscriptions ... ..	0	10	0
	£27	10	0

RECEIPTS.

	£	s.	d.
Sold, 275 Sections ... ..	8	7	8
„ 182 lb. Extracted Honey	7	4	8½
„ Appliances ... ..	1	19	9
„ Bees ... ..	12	7	8½
Prizes ... ..	3	4	0
Returned Fees... ..	0	6	3
	£33	10	1
	£	s.	d.
	33	10	1
	27	10	0

Balance ... .. £6 0 1

The balance of honey and beeswax on hand will add to the credit balance.—“FRAME-HIVE,” *Oxon.*

A NOTE FROM SOUTH HANTS.

[5131.] We have had excellent bee weather here for some days, and everything points to a successful season. Until recently conditions closely resembled those of last year, and some stocks required feeding to prevent risk of starvation.

All my hives (nine) wintered safely, but in March one colony deserted their habitation, owing probably to loss of queen, and one of my neighbours had a similar experience. In both these cases ample stores were left behind. I begin the honey season with eight stocks, and all are in good or first-class condition. This result is certainly due in great part to last year's “record” swarming which left all colonies headed by a young queen. I had

section-racks on all hives by May 30, and in several cases the bees had taken possession on the day after supering. I entirely endorse the view of your correspondent, Mr. Wm. Woodley, as to having hives ready for the honey flow with twelve frames “boiling over” with bees. These can be reduced to ten frames, if desired, when supers are put on, but, at any rate, the bees are there. I am now giving the tall sections a trial for the first time and hope to say a word about them later on.—A. R., JUN., *Sberton, Hants, June 1.*

TALL SECTIONS.

[5132.] Referring to the communication 5126 (page 212), and in response to Mr. David Raitt's appeal for “allies,” I must say that I think Mr. Lamb is too enthusiastic over the “Tall Section” to benefit their cause, and to urge which he would stifle all the good points of the square 4½ by 4½ section, and magnify their mismanagement in the hands of those who would probably do no better with the tall sections. I am sure that many, like myself, regret to see old bee-keepers, who become friends through the BEE JOURNAL—and who are ungrudging writers to its pages—being “sat upon” by Mr. Lamb. Mr. Raitt distinctly said that in “his opinion,” &c.; Mr. W. Woodley tells us that he “tries a few tall sections each year”; and so on with others. Let us have every one's opinion in the B.B.J.; and, above all, let us have reports of results. A good thing, as long as it is brought before the public, will push itself. Mr. Wm. Loveday writes much to the point in his reply to the Rev. Mr. Lamb on page 202.

I have been very successful myself with the 4½ in. by 4½ in. sections, in using those with the beeway 1½ in. wide and also with the no-beeway 1½ in. wide, both of which have the same width of comb, most being well over 1 lb. The tall section comes in handy for those who use a “combined rack” of shallow frames and sections, which I think is a useful system for bee-keepers with not more than six or eight stocks. Those in a larger way will probably prefer to work sections and shallow frames on distinct stocks as before, or, rather than alter the sections, use shallow frames 4½ in. deep only (the side bars are easily reduced, and I know of one appliance dealer, at any rate, who would so supply) combined with 4½ in. by 4½ in. sections in “W. B. C.” hanging frames for sections, with separators arranged to hang detached from the frames. If the shallow frames are filled with extra thin foundation they will just hold a good 3 lb. of honey, and there are wide shallow frames on the market which, if used with the hanging separators form complete boxes, and can be glazed and sold as comb honey, and those in my opinion (please note, Mr. Lamb) are just the thing for going to the heather.

As regards the appearance and handling of

the two sections, I prefer the square, and think it a more natural width of comb for the bees, and that it will travel safer (I saw a complaint against the "tall section" as to this a few months ago in the B.B.J.). The extra foundation needed by the "tall" is a disadvantage.—GEORGE M. SAUNDERS, *Keswick*.

### MOLE-TRAPS.

[5133.] In reply to your Trieste correspondent, "Nemo" (5110, page 195), the common mole-traps are made similarly to the enclosed sketch, which I forward in the hope that it may be of interest to "Nemo" or to others of your readers:—

A piece of oak, or other hard wood, 5 in. by 2½ in., has a couple of hoops inserted as shown on the under side. There are two loops made of flexible wire—as shown in sketch, fig. 1—

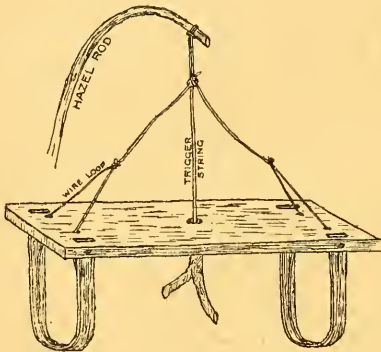

Fig. 1.

one at each hoop, whilst a knot on the end of the trigger-string is passed through a central hole, and prevented from returning by a small twig or trigger stuck into the hole. The trap is embedded in the run, and the mole, in attempting to pass, dislodges the twig, when the hazel wand attached to the loops pulls the knot through and draws the loops tight, one of which imprisons the mole. Another common form of trap is that of the barrel shown (fig. 2), a 2-in. hole passing through a piece of



Fig. 2.

wood about 5 in. long by 3 in. diameter at the middle. The underside of the barrel is cut out to allow of setting the trap, the mode of catching being the same.

I have not fully described these traps, but my rough sketches may make clear any other

points not understood by your correspondent, who, I take it, is familiar with the steel traps sold for this purpose. The latter are much less trouble to set, and more efficient than the above, save, perhaps, when these somewhat primitive snares are in the hands of an experienced old "mowdiewort catcher."—L. S. CRAWSHAW, *Ilkley*.

### MOLES IN WHITE CLOVER.

[5134.] If your correspondent "Nemo" will get some pieces of boiled liver half an inch square, and cut a slit in them half-way down, then putting a little powdered arsenic in the slits, and drop a piece in the holes and runs of the moles, covering up with a clod of earth, he will, after two or three applications, be rid of them. I have tried all kinds of traps, but find nothing so quick and effective as above.—"SUBSCRIBER," *Vienna, May 26*.

### B.B.K.A. EXAMS.

[5135.] Can you tell me the objections against publishing the examination papers of above? I was enabled to take the very highest place in my final examination at Cambridge by working up old papers. I am desirous of helping the cottagers in my parish to keep bees scientifically, but can hardly expect their confidence unless I am able to add "Cert. Bee Expert," 3rd, 2nd, or 1st, to my—M.A. CANTAB.

[The question of publishing the examination papers furnished to candidates, together with written work of the successful ones, has been discussed more than once by the B.B.K.A. Council, and it was unanimously decided that neither should be published. The object is to ensure that candidates may rely as little as possible on aptitude in "reading up" so as to determine ability by dealing with the subject on the spot. In this way it is admitted that an examination on bee-keeping, particularly that for the first-class certificate, must be dealt with on different lines from those connected with other subjects.—Eds.]

(Correspondence continued on page 226.)

### HOMES OF THE HONEY BEE.

#### THE APIARIES OF OUR READERS.

We are very pleased to illustrate on opposite page this week an apiary of Mr. Wells, along with its owner, whose "Notes" form a connecting link with such well-known pioneers of modern bee-keeping as those mentioned. Nor is Mr. Wells one of the standstill school of bee-men who are sad because honey to-day will not bring 1s. 6d. per lb. We hope he and his good wife will long maintain their interest in the bees and all that pertains to good bee-keeping. He says:—

"In response to your request for a few

notes to go along with photo in 'Homes of the Honey Bee,' I began bee-keeping in April, 1886, and am, therefore, not what can be called a young recruit. I was induced to take up the pursuit by an old bee-keeper, still living in this village, who was a personal friend of the late Mr. Robert Symington, who used to live here, and was the means of that gentleman becoming a bee-keeper. This was about the time when the BRITISH BEE JOURNAL was started and did so much in promoting public interest in the frame-hive. I believe the late Mr. C. N. Abbott, who then edited the B.B.J., used to visit Oxendon, along with other noted bee-keepers of that day, and among other improvements he introduced some Ligurian queens to Mr. Symington's stocks and those of my old neigh-

something to feel a bit proud of. However, I don't take all the praise to myself for this; what little I know of bees and bee-keeping I owe to the B.B.J. and 'Guide Book.' But the very essence of successful bee-keeping lies in the fact of knowing how to work up good stocks, beyond this we only need warmth and sunshine. With regard to marketing our honey we nearly always manage to sell out, but not at the price named by some of your correspondents, as we have to rely chiefly on the wholesale trade. We sell best quality retail at 8d. lb., and the dark coloured at 6d. to clear it off. My great endeavour is to please my customers, which means increased sales. As an exhibitor at our county show for the last few years I have been very successful, taking quite my share of



MR. CHAS. WELLS' APIARY, OXENDON, MARKET HARBOROUGH, NORTHANTS.

bour. My own bees are, therefore, descendants of these queens, but I suppose they have not much of the Ligurian blood left in them now, owing to the introduction of fresh stock in my apiary since then. However, I can truly say they are able to give a good account of themselves when the weather comes right. My largest take from a single stock was 144 lb. of extracted honey in 1893. We are much too busy to weigh up the produce of single hives now, but we have had some very good takes since then. Last season, for instance, though a poor one in most places, was the best year we ever had. From nine hives worked for honey we sold 880 lb., and used and gave away certainly not less than 40 lb., which gives a total of 920 lb., a result which all must agree is

prizes for honey and wax, and I have had the honour of winning the silver and bronze medals of the B.B.K.A. for sections and extracted honey, so can fairly claim to be a successful bee-keeper. My hives stand in a quiet out-of-the-way garden about 100 yards distant from my house. They take a bit of watching in swarming time. This part of the work mainly devolves on my good wife, who also often hives the swarms. My hives consist chiefly of the 'W. B. C.,' which I like very much. I have also a few of Abbott's 'Copyable' hives, which are good ones, but I find the sides are rather too high for taking honey off easily. The figure seen in the picture is that of your humble servant, and my stocks number ten for the coming season of 1903.'

## CORRESPONDENCE.

(Continued from page 224.)

## BEES "BALLING" QUEENS IN SPRING.

[5136.] As a bee-keeper of over twenty years I am a little diffident about troubling you with what may appear to be the questions of a tyro, but I will cover any possible disgrace under the plea that it is of general interest. I, therefore, ask:—Can you throw any light upon the fact that the opening of hives in the spring and early summer sometimes occasions the "balling" of the queen, and this more frequently with weak stocks than strong ones? Friends have reported this fact to me, but I have escaped it until this year, when it has occurred two or three times. Neither of the queens was killed, because happening to have my attention drawn to the fact by the buzzing. I caged the queen in each case, leaving only a block of candy for the bees to eat through to release her. After the first time I was on the alert, but had I not discovered it the loss would have been considerable, as my queens are of Mr. Sladen's most valuable strain.

My second object is to caution other bee-keepers to have an eye and ear ready for the prevention of such a possible disaster.—R. J. H., *Croydon, May 28.*

[Although the fact you name has been well known to experienced bee-keepers for many years past, the actual cause of the trouble is, and probably will be, matter for conjecture. It seems, however, certain that the "balling" referred to as occurring in early spring is mainly owing to untimely or awkward manipulating of hives by beginners, who do not realise that when the breeding season is starting, bees are in some way apt to "ball" their queen if excited or alarmed for her welfare. The late C. N. Abbott used to call it "hugging" their queen to death. It is certain that all old hands are very careful at such times not to excite the bees, but handle the frames quietly, and with more care than usual, and, in consequence, do not often have queens balled in spring.—Eds.]

## WEATHER REPORT.

WESTBOURNE, SUSSEX.

May, 1903.

Rainfall, 2.70 in.	Minimum on grass,
Heaviest fall, .78, on 3rd.	25°, on 13th.
Rain fell on 13 days.	Frosty nights, 0.
Above average, .93 in.	Mean maximum,
Sunshine, 246 9 hours.	60.4°.
Brightest day, 26th, 15 hours.	Mean minimum,
Sunless days, 2.	44.6°.
Above average, 6.7 hours.	Mean temperature,
Maximum temperature, 77°, on 31st.	52.5°.
Minimum temperature, 35°, on 19th.	Above average, 1.5°.
	Maximum barometer,
	30.45°, on 23rd.
	Minimum barometer,
	29.30°, on 5th.

L. B. BIRKETT.

## DISINFECTING COMBS AND HIVES.

FORMALDEHYDE AND FOUL BROOD SPORES.

I see your remarks on the use of formaldehyde in your April 15 issue. I think I wrote you of my curing combs of infectious foul brood by means of this chemical late last summer, and was somewhat surprised that you did not give this matter the publicity it deserves. Foul brood is a germ disease, just as small-pox probably is; and my reasoning was that, if formaldehyde can thoroughly and completely disinfect premises harbouring germs of small-pox, and completely destroy the germs, spores, and all traces of the disease, it might also kill and eradicate foul brood. My tests satisfied me that such treatment does entirely destroy foul brood. The disease did not reappear in combs that were infected and so treated. The chemical is not applied by spraying, as you suppose, but the vapour is driven off by evaporating with a lamp. Various styles of formaldehyde fumigators are now for sale at drug stores at 25 cents each. Each fumigator contains enough formaldehyde to disinfect a common living-room. The cheaper plan is to buy the formaldehyde (40 deg. solution), put a little of it in a tin dish, and place it over a small spirit lamp. I fumigated five or six hive-bodies full of frames at one time in this way with three or four tablespoonfuls of formaldehyde, putting the lamp and tin dish in a hive-body and empty super, and stacking on top the hives to be fumigated. I lighted the lamp before stacking up; and after all the formaldehyde was evaporated I tilted up the hives enough to enable me to blow the lamp out and then let the whole outfit stand twelve or fourteen hours, shut up tight. After it was all over it took quite a lot of airing to reduce the pungent odour of the gas, and it annoyed the bees to receive one of these frames in the colony; but they managed to dispel the rest of the fumes.

The fact that boiling does not destroy the spores of foul brood does not prove very much. It goes to show that we must use an entirely different method of eradication. Because we can drown a cat, it does not prove that we can destroy other animal life in the same way; for fishes could stand no end of drowning. It does not even prove that fishes are particularly hard to kill, but that we must try some other method. We do know that formaldehyde vapour or fumes are particularly destructive to germ life; and I believe that its use will mean a big thing for the bee-keeping fraternity.

I will add that the cases I treated last year appear to be entirely cured up to this time this spring. I have only one case on hand, which was not treated with formaldehyde. I expect to get rid of this in a few days.—WILLIAM HAHMAN in *Gleanings* (American).

## Queries and Replies.

[3112.] *Buying Diseased Stocks.*—On March 20 last I bought a stock of bees in a skep and carried them myself a distance of eight miles to my home. The bees seemed to cover about four combs. The skep was placed on top of a frame-hive already furnished with some combs for transfer. Two of the frames taken from another hive were well supplied with food. From that date the bees have never seemed to work properly, and I suspected queenlessness, because the bees gradually decreased in number. Knowing that stores were short, I gave syrup in a bottle-feeder placed on top of skep, but very little of the syrup was taken down. On Tuesday last there was some fighting going on at the hive entrance, apparently with robbers, and a good number of bees lay dead upon the ground. On Saturday last, May 30, I examined the skep and found about a hundred bees dead upon the floor-board, and a dozen or so alive upon the combs, no stores, and two small patches of brood, which I enclose for your inspection. I shall be glad to have your opinion on the following:—1. Does the comb contain foul brood? 2. Is bee sent in paper a queen? 3. Should comb sent be diseased, would it be advisable to start a swarm upon the same frames of comb and foundation the skep was placed upon? I may say the foundation is not drawn out at all. I enclose my card, and sign myself—CAPTAIN KETTLE, *Warwickshire.*

REPLY.—1. Sample pieces of comb sent are badly affected with foul-brood. 2. Dead insect is, no doubt, the queen of the stock in skep. 3. The robber-bees noticed at work pillaging the skep on the 30th inst. will probably have carried the infection into whatever hives they belong to, whether your own or those of neighbours. It was a most unfortunate purchase, and surely the former owner of the skep must have been ignorant of what he was selling you.

[3113.] *Stock Headed by Worthless Queen.*—I bought a stock of bees about a month ago with the enclosed queen, said to be a good one, and upon examining the hive three weeks later found there was no sign of brood in any stage in any of the combs. I am only a novice at bee-keeping and shall therefore be obliged if you will kindly give me your opinion of the queen. The stock was sent to me from some distance by rail and to all appearance travelled well. I am a constant reader of both of your valuable papers.—X. Y. Z., *Plymouth, June 1.*

REPLY.—Dead queen (mutilated in post) was too dry and hard for examination of ovaries, but appears aged and worn out, judging by the jagged wings. Surely the stock must have been weak when purchased?

[3114.] *Management for Beginners.*—Being quite a beginner with bees, I will be obliged for replies to the following questions. On May 20 I had a swarm from a skep I have, and was successful in putting the bees into my new hive, which contains eleven frames (fitted with full sheets of foundation), and a rack of twenty-one 1-lb. sections also fitted with full sheets. There is a queen excluder between body-box and sections. My questions are as follows:—1. Have I done right in putting the whole of frames with queen excluder and the sections on? 2. If not, can I take sections and the queen excluder off now, and only let frames remain? 3. If sections are to remain, when would they be likely to contain honey so as to be taken away? 4. And when full, do I place another rack on top of them, or take the full one away and put another in its place? 5. Could I, if I should get another swarm or cast, put them in with the first lot by putting them down at entrance? 6. Or would it be best to put them into another hive without sections next time?—E. H. P., *Kent, May 25.*

REPLY.—1. In the first place, you must never give surplus-chambers to a swarm when hived. For the rest, it is advisable to raise the quilts next morning after hiving, and contract the body-box to five or six frames, judging by the size of cluster. The full number of frames is given a week or ten days later, according to weather and honey income. If honey is plentiful the rack of sections may be put on in less than a fortnight after swarm is hived. 2 and 3. Remove rack at once. 4. Yes; but it does not often happen that a swarm of current year fills more than one rack of sections. 5. The second swarm had better be hived apart, and twenty-one days later the bees driven from parent skep, and added to the second frame-hive as proposed.

[3115.] *Bees and Poultry.*—I should like to know if any of your readers, who keep bees and poultry, have ever had the experience which befell us last week. A super was being put upon a frame-hive, which was particularly strong in bees, when suddenly they attacked some young chickens which were running in an enclosure close by. They stung them badly, and in many cases we picked six or more bees off their bodies. Ten died, and the remaining nineteen were very bad for a day or two, but eventually recovered. The old hens were apparently not attacked. Is this an unusual occurrence, and is there anything to be done to prevent its happening again? We read your paper with interest, and shall be glad to hear if any other bee-keepers can record a similar attack.—T., *Bromley, Kent, May 30.*

REPLY.—It is happily very unusual for bees to attack poultry when giving supers. In fact, such a thing never occurs to an experienced bee-keeper. Nor does it need more than the use of a little smoke—judiciously applied—

along with careful and quiet handling, to enable any one to put supers on with almost no disturbance.

[3116.] *Removing Skeps after Transferring Bees.*—If on lifting up a skep to-day (which has been placed on top-bars of a frame-hive since last June for transferring) there is found brood and honey in skep and some capped brood and larvae on frames below, is it safe to presume that the queen has gone below, and to put on excluder, leaving skep as a surplus-chamber? My six stocks have come out well and are now in the pink of condition, but I had to feed them all during March and April. I supered three of them with shallow-frame combs May 17, and they were working vigorously in them on the 24th. Thanking you in anticipation.—“BUCHANAN,” *Dawley, Salop.*

REPLY.—It might be well to examine the frames of lower hive to make quite sure the queen was below at time of removal, but it will be fairly safe to assume that she is, if eggs are seen in the lower hive. With regard to putting excluder-zinc between skep and lower hive, there will be no danger if you examine the combs of skep, and make sure there is no drone-brood therein, as the excluder would prevent drones leaving the hive, and might cause trouble in that way.

[3117.] *Giving Room in Advance of Requirements.*—I started bee-keeping in April last and have bought a very strong stock on ten standard frames. After getting them home I examined the frames and found irregular patches of brood on several combs. Last week all cells were empty of brood or eggs. This week no eggs are visible, but a great number of cells are half filled with honey. I detected about half-a-dozen drones, but have not seen the queen yet. I am able to see the hives only once a week, so have put on a box of standard frames filled with foundation underneath brood-chamber, with the idea of preventing swarming. I have also put a box of shallow-frames on top of brood-chamber. The bees are working hard and seem contented. Am taking in your journals and also have the “Guide Book” and one year’s B.B.J.s, but see no *exactly* parallel case to my own, so ask you to kindly say—1. Must I get a new queen? and 2. Have I done right or wrong in placing a box of standard frames under brood box and shallow-frames on top?—G. C., *Rotherham, May 26.*

REPLY.—The condition of the hive when examined last reveals a state of things requiring entirely opposite treatment to that adopted. If there are “no eggs and no brood, and no queen visible,” it is futile to give room either above or below. As to “swarming” under such conditions, you must really study the “Guide Book” a little closer in order to get a better grasp of the subject it deals with. 1. If the bees are really queenless, it becomes a question whether the stock is worth re-queening. 2. You have dealt with the bees as if

they were strong and prospering, but altogether wrong in view of its present almost hopeless condition.

[3118] *Bees Robbing Nuclei.*—On Saturday (May 23) I introduced two valuable queens to nuclei; robbers commenced operations almost immediately, though my other stocks are well supplied with food and I use every care to prevent temptation, and have not before been troubled with robbers. I contracted and crowded entrances with grass besprinkled with carbolic-water; this was ineffectual, so closed doorways with perforated zinc for a while, then opened them to release robbers and closed again with zinc. At night I moved the hives completely away and put others with just a little syrup on empty combs in place; these were soon cleaned up in morning and all, apparently, quietened down. To-night (Tuesday) I replaced nuclei and, within half-an-hour, the robbers (without doubt) were diligently buzzing and darting about. I do not wish to lose the queens, and shall be grateful for any suggestions?—C. S., *Harrogate.*

REPLY.—It is more than probable that the “robbing” will cease now that honey is coming in plentifully. It would, however, be well either to defer placing the nuclei on their old stands for a few days longer, or reverse the entrances by putting backs of hives to the front for a time.

[3119.] *Dealing with Swarming.*—Your kindness and help before encourages me to be importunate again. Furthermore, as a reader of the B.B.J., I have found the “Queries and Replies” column to be so interesting and instructive that in seeking benefit for myself I may occasion benefit to some of your many readers. May I ask, therefore—1. Would strips of queen-excluder zinc, put across opening, on exceptionally hot days, prevent swarming? 2. I had a swarm on May 22, which, after cutting all queen cells out, I put back to its old home, where now the bees are busy in supers. Is there any drawback to this plan, and are they likely to swarm again? 3. Is it wise to get drone-traps and destroy the drones, for not wishing to increase my apiary and multiply queens, I have no useful purpose for them.—ENQUIRER, *Suffolk.*

REPLY.—1. Do not try this method on any account; it would lead to mischief in many ways. 2. The only drawback to this plan is that it too often fails in securing the object aimed at. 3. “Drone-traps” are things of the past. Limit the number of drones by only allowing a small amount of drone-comb in the hive. This is easy, and secures the end in view.

[3120.] *Introducing Foreign Queens.*—Referring to imported queens, kindly advise on the following:—1. On arrival of the queen, can I keep her in the house in the travelling cage if



I am not ready for her introduction to hive; and what is done with the bees that are sent with the queen? 2. How long will queens be safe out of hive? 3. Could not the queen imported be given to a small nucleus as a safer method than introducing to a full hive? For instance, take, say, three combs of capped brood and a pint of young bees from strong hives, and run the queen in the night following. Then build up the stock with brood from strong stocks. My object is to make sure of keeping safe an expensive queen.—“ANXIOUS,” *Hull, May 29.*

REPLY.—1. Yes, but no time should be lost in getting the alien queen into her new home. 2. If properly prepared for travelling, queens may be kept for some weeks, as when sent several thousands of miles to distant parts of the world. But it is always risky. 3. It is far safer to follow the directions sent along with queens or given in “Guide Book” than try plans that may seem safer or better to yourself.

## Echoes from the Hives.

*Woodham Ferris, Essex, May 30.*—The weather here since May 22 has been splendid, and the honey started coming in at once. I supered my strongest lot on May 23, and the bees took possession at once; I have since had to give them a second box of shallow-frames. Four of my hives now have their second super on and filling fast. There is a fine show of clover-bloom just commencing, notwithstanding the bad season last year. I got over six hundredweight of surplus last season from eleven hives, spring count, and by autumn I had increased to fifteen stocks, but I had twelve swarms and casts altogether, most of them I returned after destroying queen cells. My best hive gave me 103 lb. of extracted. This was a colony I purchased in a skep the autumn before, and I drove them and put them on frames.—H. R. W.

*Terrington St. Clement, Norfolk, May 30.*—The evening of May 21 was a warm and bright one, and I decided to have an hour among the hives, and was soon “busy as a bee.” The first few stocks examined were simply packed with bees, so I had to super almost the whole lot at once. I am using “W.B.C.” hanging-frames for sections, each rack takes seven of these, the ends of the boxes being raised to the top of the frames are just the depth required, hence I have only one make of rack in use now and that serves for both sections and shallow-frames. I have enough combed sections left from last season to put two or three frames in so that every hive will be worked for comb-honey, and a glance beneath the quilts this evening shows the bees have taken possession of the supers and the rest of the frames may be given in a few

days if the weather is propitious. Altogether I am surprised at the very forward state of my stocks. Several swarms are reported from skeps about here, the earliest I heard of being on May 22. I have been working on about half acre of Iceland poppies during this week, and the hum of the bees has been sweet music as every one of the numerous flowers seemed to contain a pollen-collecting bee, and in consequence my estimation of this bright little poppy (*Papaver nudicaule*) is greatly increased.

A few weeks ago I made a note of a prize offered at our flower show, and so numerous have been the demands for particulars that I trust you will allow me to make a few further remarks about it. On July 1 entries close for the best essay on “How our Produce should be Marketed.” The prize is £2, “to be increased to £3” should its excellence merit an increase in the prize money, and the prize money is given by a firm of fruit salesmen. The competition is open, and I will willingly send a schedule on application being written to any one writing for one. A silver medal is offered for the best 1 lb. jar of honey (entry free).

Referring to Mr. Wells’s article on “Flowers for Bees,” I grew half a rood of clarkia one year, and found the bees used the flowers very regularly.—W. J. BELDERSON.

## Bee Shows to Come.

*A nominal charge of 2s. 6d. is made for notices in this column, which covers cost of insertion from order till date of show. Cash should accompany orders for insertion.*

June 9 and 10, at Bishop Stortford.—Annual Show of the Essex Agricultural Society. Bee and Honey Section under the management of the Essex and Suffolk Bee-keepers’ Association. Entries closed.

June 23 to 27, at London.—“Royal” Agricultural Society’s Show. Bee and Honey Section under the management of the B.B.K.A. Increased prizes for B.K.A. Associations as arranged in divisions or groups of counties. Entries closed.

July 15 and 16 at Lichfield.—Annual Bee and Honey Show of the Staffs B.K.A. Open Classes for Comb and Extracted Honey and Appliances. Schedules from Rev. G. C. Bruton, Great Haywood, Stafford. Entries close June 20.

July 16 and 17, at Lincoln. Honey, Hives, and Bee Appliances, in connection with the annual show of the Lincolnshire Agricultural Society. Bee department under the management of the Lincs B.K.A. £23 in prizes. Schedules from E. Godson, Hon. Sec. L.B.K.A., Tothill, Alford. Entries close June 16.

July 22, at Broughton, Hants.—Fruit, Flower, Vegetable, and Honey Show. Twentieth year. Liberal prizes, with silver cup, valued £15, open to the United Kingdom. Particulars from Fred. J. Hinwood, Broughton, Stockbridge, Hants. Entries close July 18.

July 22 and 23, at Cardiff.—Honey show of the Glamorgan B.K.A., in connection with the Cardiff and County Horticultural Society. Bees, hives, honey, trophies, wax, appliances, and articles of food. Substantial money prizes and medals. Free entries. Six open classes. Schedules from William Richards, Gabalfa, Cardiff. Entries close July 16.

July 29, at Wallop, Hants.—Honey Show of the Broughton and Wallop Branch of the Hants and

Isle of Wight Bee-keepers' Association. Two open classes for single-section and 1-lb. jar respectively (entry free). Schedules from Miss Tucker, The Lindens, Broughton, Stockbridge, Hants. Entries close July 22.

July 29, at Henbury, near Bristol, Annual Show of the Henbury District Bee-keepers' Association in connection with the Horticultural Society's Exhibition. Several open classes with good prizes (two classes with free entry). Schedules from I. Atkin Waller, hon. sec., Pen Park, Westbury-on-Trym, near Bristol. Entries close July 24.

July 30, 31, and August 1 and 3, at Old Trafford, Manchester.—Annual Show of the Royal Lancashire Agricultural Society. Liberal money-prizes are offered for honey along with silver and bronze medals of the B.B.K.A. and also of the Society. Open classes for Honey-Trophy, Sections, Extracted Honey, Beeswax, Honey-Confectionery, Bee Flowers, Instructive Exhibits in Bee-Culture, &c. Schedules from Edward Bohane, Secretary, Millcr-arcade, Preston. Entries close June 30.

August 3 (Bank Holiday) in the Walled Meadow, Andover.—Honey Show in connection with the Andover and District Horticultural Society. Class for single 1-lb. jar of extracted honey (with no entry fee). Also classes for sections, extracted honey (light and dark), and beeswax. Schedules from the Hon. Sec., Dr. Gillett, Elvin House, Andover. Entries close July 28.

August 4, at Leamington.—Tenth annual show of the Leamington St. Mary's Horticultural Society. Three open classes for Six 1-lb. Sections, Six 1-lb. Jars "Light," and Six 1-lb. Jars "Dark" Extracted Honey, respectively. Liberal money prizes. Schedules from P. W. Smith, Secretary, 22, Leam-street, Leamington. Entries close July 30.

August 6, at Nantwich.—Honey department of the Cheshire Agricultural Society's Show under the management of the C.B.K.A. Numerous classes for hives, honey, and wax. Money prizes and medals. Schedules from T. A. Beckett, St. Werburgh's Chambers, Chester. Entries close July 16. At double fees July 23.

August 6, at Kingsthorpe, Northants.—Honey show of the Northants B.K.A., in connection with the Horticultural Society's Exhibition. Three open classes with special prizes, including one for single 1-lb. jar of honey. (Entry free.) Prizes 20s., 10s., 7s. 6d., and 2s. 6d. Schedules from R. Hefford, Hon. Sec., Sunnyside, Kingsthorpe, Northampton. Entries close August 1.

August 12, at Radstock, Bath.—Honey show in connection with the annual show of the Radstock and District Horticultural and Fanciers' Association. Schedules from the Secretary, B. M. Clark, 1, Fox Hills, Radstock, Bath.

August 25, at Cartmel, Lancashire.—Honey show in connection with the Cartmel Agricultural Society. Open classes for sections, extracted honey, and beeswax. Local classes for sections and extracted honey. Schedules from Wm. Cragg, Secretary, Cartmel, via Carnforth.—Entries close August 13.

August 27, at Llangollen.—In connection with the fifth annual Flower Show. Open classes for Six 1-lb. Sections, Six 1-lb. Bottles Extracted Honey, and Beeswax. Schedules from Frank Little, Castle-street, Llangollen. Entries close August 13.

August 27, at Montgomery, in connection with Montgomery and District Horticultural Show. Open classes for Six 1-lb. Sections and Six 1-lb. Jars Extracted Honey. Prizes in each class 10s., 5s., 2s. 6d. Entrance-fee 1s. each. Schedules from W. J. Jones, Secretary, Montgomery. Entries close August 20.

### Notices to Correspondents & Inquirers.

All queries forwarded will be attended to, and those only of personal interest will be answered in this column.

W. J. FARMER.—*Compulsory Powers for Dealing with Foul Brood.*—This question was so thoroughly dealt with in our pages a few years ago, that it seems idle to re-

start discussion again just now. There will always be some objectors to official interference with the liberty of the subject—hence the difficulty; but we imagine that most of the objectors would alter their views if a neighbouring bee-man insisted on leaving his hives rotten with disease in the open garden, to be "robbed out" by bees belonging to the helpless victim whose adjoining apiary is ruined in consequence.

### Suspected Combs.

VERONICA (Kingsbridge).—We find no foul brood in comb sent. The incompleting capping of larvæ is due to some other cause not apparent and not accounted for in the details sent. One source of mischief we note is a larva of the true wax-moth, *Galleria cereana*, which has already tunneled the comb with its passage-ways. If the stock is badly infested with this pest it may account for the dead brood, but you do not mention it at all.

R. M. B. (Luton).—There are slight signs of foul brood of old standing in one cell of sample. All the rest of larvæ seems in normal condition save being "chilled" to death. We might judge better if some unsealed brood had been sent.

J. H. (Corbridge).—We find no disease in sample No. 1. In No. 2 foul brood is just developing. The naphthaline sent is suitable if you do not give an overdose of it.

"LONDON."—No disease in comb; but queen is evidently a drone-breeder.

M. J. (Sussex).—A rather bad case of foul-brood. We do not know what is meant by your having "sprayed the combs with Remedy." We fear it will do no good in your case, and the combs had better be destroyed. If the bees are "strong," as stated, they may be saved by treating them as a swarm in a clean hive, as directed in "Guide Book."

P. Q. R. (Stourport) and J. S. (Cornwall).—Decided cases of foul-brood.

J. R. C. (Cumberland).—1. Comb contains foul-brood of old standing; being old and black, we advise burning the lot. 2. It is quite possible the bees "robbed out" have joined the robbers in the hive of the latter.

I. F. W. (Leicester).—No foul brood in comb. The dead larvæ is chilled only.

W. E. S. (Wellington, Som.).—We cannot trace any disease in comb.

J. S. (Cornwall).—A pronounced case of foul brood.

P. W. (Essex).—Comb is diseased, and being very old and black is only fit for burning. If there are "two quarts of bees" as stated, you might start them in another hive as a swarm, now that weather is so favourable.

\* \* \* Some Letters and Queries are unavoidably held over till next week.

## Editorial, Notices, &c.

### DO FLOWERS PRODUCE HONEY?

We have been favoured by an esteemed clerical friend, a reader of this journal for many years past—who is also an experienced bee-keeper, and holds the certificate of the B.B.K.A. as an expert—with a cutting from a recent issue of the *Liverpool Daily Post* in which the question of honey and flowers is dealt with editorially. The subject is of more than ordinary interest to bee-keepers, in so far as it directly raises the question whether or not the orthodox and long-cherished idea regarding the source of honey-production is true in substance and in fact. Our contemporary says:—

"One more illusion has been dispelled. Flowers, of themselves, are incapable of producing honey. Careful investigation has now revealed the fact that honey is a product of fermentation. The sap of the petal of a flower contains a large amount, proportionately, of starch, and only a small amount of sugar. This starchy sap exudes on perforation, but is not sweet, and not like honey to the taste. When the bee enters a flower it scratches the sac which contains this liquid, and moistens the small wound with saliva. Then it leaves it, and goes on to the next flower. On the morrow it returns to gather the produce of the fermentation in the shape of honey—that is, unless some other insect has been there first. Experiments have been tried on the starch and cellulose extracted from flowers by inducing fermentation by means of the addition of ptylin or yeast, with satisfactory results. The flavour of honey depends partly on the flower and partly on the ferment. It is the former which accounts for the slight variation in the taste of honey gathered from different localities, and the latter which causes all honeys to taste nearly alike."

In response to a request for our opinion on the above, we may say no "illusion has been dispelled," for it has long been known, and repeated *ad nauseam*, that flowers do not produce honey, but nectar, which latter is converted into honey by the bee. Nor is honey "a product of fermentation"—such as is ordinarily produced by "yeast"—but is the conversion of the cane-sugar of nectar—as secreted in the nectaries of flowers—to the grape sugar of honey by means of an enzyme produced by the bee. Stated clearly, nectar is the conversion of the starch contained in the sap of the plant or flower into sugar. The nectar—not the starchy sap—exudes at a favourable temperature, being collected in the special receptacles of the flower as named above.

Again, the bee on entering a flower, does not "scratch the sac" containing a liquid or "moisten the wound with saliva" prior to re-

turning on the morrow for the fermented product of her act. Such reasoning is entirely against known facts. The bee at once sucks up into her honey-sac the nectar exuded on the day of her visit, and on returning to the hive regurgitates it into the comb-cells after adding a secretion from special glands opening into the mouth of the insect. This secretion contains the enzyme which converts the nectar into honey. The flavour of honey does not depend in the slightest degree on any "ferment," as asserted by our contemporary. It depends on the essential and volatile oils contained in the nectar, more or less differing with every flower from which it is gathered.

Finally, it is, to say the least, misleading to mix up purely chemical terms with those in ordinary use when dealing with articles of food. In other words, we may say the popular view of what we know as pure honey has little or nothing in common with either cane sugar, grape sugar, starch, or cellulose, as these latter are regarded by persons unacquainted with scientific terms. To put the matter in another and still plainer way, there is not much in common between a beefsteak and the sole of one's shoe; yet the constituent parts of both are, chemically speaking, the same. We may, therefore, still continue to cherish our present ideal of honey as a product of flowers converted by the bee into one of Nature's most wholesome and palatable sweets. Nor have we any hesitation in declaring that the "illusion" stated to have been "dispelled" is on the other side.

## Correspondence.

*The Editors do not hold themselves responsible for the opinions expressed by correspondents. No notice will be taken of anonymous communications, and correspondents are requested to write on one side of the paper only and give their real names and addresses, not necessarily for publication, but as a guarantee of good faith. Illustrations should be drawn on separate pieces of paper. We do not undertake to return rejected communications.*

*Communications relating to the literary department, reports of Associations, Shows, Meetings, Echoes, Queries, Books for Review, &c., must be addressed only to "The Editors of the British Bee Journal," 17, King William-street, Strand, London, W.C." All business communications relating to advertisements, &c., must be addressed to "THE MANAGER, British Bee Journal," Office, 17, King William-street, Strand, London, W.C."*

*\*.\* In order to facilitate reference, Correspondents, when speaking of any letter or query previously inserted, will oblige by mentioning the number of the letter as well as the page on which it appears.*

### OUR FAILURES.

[5137.] There is a class of failures in bee-keeping that arise from ignorance, want of energy, and from physical inaptitude, to which must often be added the disadvantage of small means. Of these it need here only be said that it is the duty of every experienced bee-keeper to actively discourage any one from starting an apiary whom he recognises as lacking the necessary qualifications and that

experts especially should refrain from conveying the idea that any one can handle a hive off-hand with the ease that they themselves display in the bee-tent, or that dexterity alone is necessary to ensure success. All should remember that every failure is a discredit to the industry they profess to cherish, and amongst the most fruitful sources of disease is a neglected, dwindling apiary.

Again, there is no one whose business or pleasure leads him to visit many apiaries but must have noticed many that, for no apparently adequate reason, are practically non-remunerative. The owner seems to be no longer able or willing to do the bees justice; he will probably tell you that the labour is too great; he has no time to attend to them. Glancing round the garden, one can recognise the parent hives; the progeny, at first accommodated in skeps, has overflowed into makeshifts and queer commercial boxes. In full sympathy with a really busy man, it seems worth while to inquire into the causes of his failure, not without some hope of being able to suggest a remedy.

The two main causes of such a state of things are a faulty equipment and the want of a good system of management. Much depends on a fair start, and an odd lot of hives at the outset is a heavy handicap. For comfortable bee-keeping—and comfort means the saving of time and labour—a beginner should, if possible, equip himself with two hives of the same size and by the same maker, one to be colonised, and the other for the time to remain empty. If this cannot be managed, the second hive, when acquired, must be like the first. Practise economy in everything; let the hive be quite simple; eschew all new devices; but do not stint the number of hives. Some will at times be vacant, but if used on the system to be described, they will pay their cost over and over again; and a good hive, if frequently repainted, will last for many years. Second-hand hives, be they full or empty, are no bargain for a beginner; let him buy them if he likes them when he has learned to judge of them properly.

A man should buy hives suitable to his physical powers. Broadly speaking, there are now, and probably always will be, only two kinds in use; the "W. B. C." type with loose outer case, a limited brood nest, and frames at right angles to the entrance; and the long, double-walled Combination hive, with frames parallel to the entrance. Each has its advantages, but the former is much less laborious to handle, and a man of moderate strength should choose it in preference, unless he can reckon on always having help at hand. Everything, from supers, frames, &c., down to the very entrance-doors of the hives should be interchangeable throughout the apiary. In this respect, the "W. B. C." hive arrangement for working both shallow-frame and section supers at the same time is convenient. The writer, who although he constantly recommends this hive has never possessed one, has secured the same advantages

in long hives by shortening the ends of his shallow-frames, and making the super-boxes, which are double-walled, of exactly the same square outline for frames or sections.

He loses both time and labour who shall set himself to produce first-rate comb-honey in an unsuitable district. His hives may be boiling over with bees in the spring, but unless there are broad acres of some special honey-plant, such as clover, sainfoin, or mustard, or great wealth of fruit blossom, or if the soil is such that a fortnight's hot sunshine parches it, his sections will be but second-rate, and his bees, having little else to do, will turn to swarming; while, on the other hand, working throughout the year on woodland, moor, or meadow they might have filled his shallow-frames with good store of honey.

The question of swarming leads to the main cause of trouble, indiscriminate increase. The busy man, of all others, should decide how many stocks he is able to manage comfortably in the heat and stress of summer, and with *little more than half* that number he should always go into winter. *Half* would be safer, especially for the comb-honey producer; for, say what you will, bees will swarm, and the best course for the small apiarian is to keep his stocks strong, let them swarm if they will, and make the swarms do the work. The trouble and time spent are reduced to a minimum, and the only requisite is proper hives in which to accommodate the swarms. There is nothing new in this system, but it is much neglected. Its main principle, that of strengthening the swarm by the addition of the flying bees from the parent stock, was recognised and acted on more than 100 years ago by Schirach, and as elaborated by Mr. Heddon in America it was described by Cheshire in his "Bees and Bee-keeping" in 1886, since which time the present writer has constantly practised it with complete success, and he is convinced that there is no way in which a small apiary can so easily be kept in hand and worked with profit.

We will suppose that your hives are supered. When a swarm comes, take it as usual, and let it stay where it is while you place a fresh hive close alongside the parent, but turned aside at about half a right angle from the old line of flight. The same evening open the parent hive, setting the super on one side for the moment; take out two frames of brood (no queen cells) and one of honey, and place them in the new hive. Fill up each hive with foundation and empty combs. Set the super on the new hive and run the swarm in by the entrance. In a day or two, when the new colony is quite at home, turn its hive to face the same way as the parent. The two hives will now be practically on the same stand.

In about eight days from the issue of the swarm another would be due, so two or three days in advance of this date, on a sunny morning, lift up the old hive very gently and remove it to quite a new stand. The flying

bees will all join and strengthen the swarm, which should now be working hard in the super, while the old colony will be so far depopulated that it will not have the heart to swarm again. It will become strong enough under its new queen, as the brood hatches, to fill a super of its own, should the conditions be suitable. At any rate, it should store several combs in the body-box. In the unlikely event of a second swarm issuing from either hive let it stay in the skep till the following night and then return it, removing the queen as the bees run in if you think fit, otherwise the bees—or fate—will settle the succession.

In the autumn remove the older queen, and join the two stocks, leaving plenty of stores. No candy should be necessary. The superfluous stored combs are set aside carefully for feeding and stimulation next spring, and to serve again, empty or stored, when swarms come; the spare hive is overhauled and repainted at leisure; and the bee-keeper goes into winter with his proper number of hives containing strong colonies under young queens, and everything shipshape and in the best condition.

In the event of its being impossible to provide enough extra hives, the system could, to some extent, be carried out by using make-shifts. In this case the contents of the parent hive would be removed into the makeshift, which would take its place; there would be more trouble; the chance of the extra super must be foregone, and other advantages would be lost. In working as recommended, the busy man may, if he pleases, spare himself the trouble of doing anything to the parent hive beyond removing the super. This was Mr. Heddon's procedure, but I have found it advantageous to transfer combs to the swarm in proportion to its strength, and to the amount of brood in the parent hive. It is a matter of judgment; if made too strong there is more chance of a second swarm.

It will be noticed that to carry out this scheme all swarms must be identified, and as this in itself takes time, and is not always an easy matter if the issue has escaped attention, I hope our Editors will allow me to repeat the method of identification that I sent them nearly nine years ago; not my own device, for the flouring of bees for recognition dates from the days of Aristotle. When a swarm must be hived, unless you are quite certain whence it came, take a flour-dredger with you as well as a skep. There will generally be a few bees somewhere outside the skep after turning it over; if not, detach a few from the cluster, and give them a thorough dusting, repeating it if necessary. Forthwith remove the skep, and place it where the bees are not likely to find it; it need not be taken far if well concealed. The dusted bees, disheartened by the flour, and having lost their fellow-swarmers, will before long make their way to the apiary, where they will be seen roaming disconsolately,

like belated bee-ghosts. In from five to thirty minutes from their dusting they will be fanning vigorously on their own alighting-board, and all doubts as to the parent hive will be at an end.—LIEUT.-COL. H. J. O. WALKER, *Budleigh Salterton, Devon.*

## SPREADING BROOD.

### ITS DANGERS AND ADVANTAGES.

[5138.] How much may have been written upon this subject I cannot conjecture, yet the matter periodically crops up for advice in the columns of this journal, owing, no doubt, to the "differing of the doctors." I have before me as I write a variety of text books which refer to the subject in terms ranging from those of an eminent authority who builds up in this way the whole of his colonies, to those of one who desires to see this manipulation banished from the pages of all journals.

Between these two some truth must lie, or it would even seem that both may be right, as what is meat to one eater may be poison to another, and this particular manipulation may bring success or disaster in the hands of different operators. I do not know but that the latter is the view I would more readily support, as the practice may be a dangerous pitfall for the novice with his possibly weak colonies and poor queens, whilst conversely, the better the queen the less necessity for artificial brood-spreading; and as the quality of stock should be carefully improved year by year, and the number of old queens limited, the operation should be theoretically a diminishing quantity even in expert hands.

Precept and practice, however, do not always walk hand in hand, and whilst I would not indiscriminately preach the spreading of brood, on account of its possible ill effects, I yet consider that, when intelligently done, there may be undoubted gain. Too often the underlying principles of such matters are entirely ignored, and the spreading of brood by a beginner is often practised haphazard upon the strength of a text-book reference, whereas it is essentially an operation to be labelled, "Not for the inexperienced." I hope to be able to indicate simply some of the conditions necessary to success, and thereby, perhaps, point out the danger once again, it being understood that I do not wish to dogmatise upon the subject, nor have I much that is new to offer, the formation and expression of my own opinion being simply based upon the experiences of others, tried, so far as possible, in my own operations.

First then, the prime object of spreading brood is a rapidly increased brood nest, having in view the opening of the honey season, before which date a crowded hive is desired. Foundation should never, in my opinion, be used for this purpose, as brood is wanted, not early or cheaply-built combs, and the two purposes must not be confused. Every comb so built in spring is built at the expense of the very

life of the bees, for though, if absolutely necessary owing to shortage, combs may be built in this way, yet the heat necessary for their production is obtained at the expense of the consumption of valuable stores which should be used as brood food, whereas the combs can be produced more cheaply later in the year when the bees have "surplus heat" at their disposal. Too often the bees attack the foundation with obvious reluctance, the corners remaining in this state for long, with every incentive to damage or warp. Of course they may be worked out in this way later in the year, when honey is coming in, by such stocks as are too weak to store much surplus, but they would be better given to swarms, or to special stocks devoted to the purpose.

To obtain the best results with spreading brood, fully-drawn combs free from old pollen should be given. This may save the disappointment of comb cut down, and drone comb built; but if frames are inserted in the centre of brood nest I would give preference to clean old combs, then to new ones. Queens appear to lay more readily in combs in which brood has already been reared, and I have had cases where a perfectly new comb on either side of the brood nest has seemed to confine its area until such time as the bees were forced to expand.

It is better that the combs should contain stores, as the uncapping and *traffic of the honey in the hive* has a highly stimulative effect, owing no doubt to the more frequent feeding of the queen. The operation must, however, depend upon the condition of the season and the hive. It cannot safely be practised before permanent warm weather has set in, judged by the minimum temperatures of the night. It is also apparent that a well-packed double-walled hive is more likely to obviate chill than one thin and poorly protected. I have sometimes seen brood spread to the extreme outside comb next to a thin single wall, with the inevitable result that bees on the point of hatching were ruthlessly and wantonly exchanged for a few eggs, the worst possible of such bargains with the bees! The age of the queen must also be considered. A young vigorous queen will probably rear all the brood advisable, while an old queen may be fairly hustled into doing better than her own best. Would it not be better to have all our "honey stocks" headed by just such fine young queens?

Where small patches of brood are naturally begun upon additional combs, it is perhaps inadvisable to insert a new one, but the brood-nest might be left alone, as the step once taken the bees will now extend rapidly, though artificial extension may, if still desired, be obtained by placing these combs in the middle.

Where the brood nest shows its outer combs next to the pollen combs, well filled with hatching brood and well covered with bees, a comb may be fairly inserted. The "spreading" must, however—and this is the

main contention—*depend upon the quantity of bees and not of brood.* Where the bees are covering more combs than contain brood, extension may be safely practised, but where the brood-nest has already reached that common condition of early summer, the combs well filled with sealed brood, but thinly covered with bees, *leave it alone.* In other words, the spreading of brood by the insertion of more combs may be fairly practised where the colony is making little or no progress for no apparent reason than a disinclination on the part of the bees or queen to extend. The operation is of value as providing combs free from pollen-clog and drone-cells in the best place, for while drone comb is often occupied without any apparent justification of a desire to swarm on the part of a weak colony, drone-rearing and swarming on the part of even strong colonies may be, to some extent, retarded by extension of the brood-nest in proportion to the bees.

If the advance of the season has been *well gauged* in relation to the sequence of brood-spreading operations, supers may be put on with the last of the "spread," which might be about ten days before the beginning of the honey-flow, as the bees thus have surplus-room in advance of their requirements, and can become accustomed to an excluder *before* the necessity for it.

The indications of injudicious spreading of brood are very simple. The queen ceases to lay in the outer combs of the nest, and in bad cases the brood is largely chilled owing to the incapacity of the bees to keep it warm during cold nights; a colony in such a case often failing to recover from the setback until too late in the season, so that I would here re-emphasise the warning to the beginner that more harm than may at times be done by the indiscriminate use of our powers over the movable frame, and that in this as in many other bee matters, *one cannot be too careful.*—L. S. CRAWSHAW, *Ilkley.*

#### BEE NOTES FROM IRELAND.

[5139.] It struck me that as the columns of the B.B.J. seldom contain any bee-notes from "Ould Ireland" I would step in and give you a few, for I am sure English readers would like to hear occasionally how the bees do over here. 'Tis true the industry has a very different standing with Pat from what it has across the water; but sure 'tis looking up it is now altogether, for haven't we a *Bee Journal* of our own this two years, and everything to match? However, that is no reason why I should forsake my "first love" (which affection began nearly five years ago and seems likely to last for ever!), and so—bee-keepers being brothers all the world over—I am just as anxious to keep in touch with the old headquarters as with one nearer home.

Here in Dublin we have had glorious bee weather since May 21, and there is every

promise of a continuance of the same. My own efforts have chiefly been directed towards the prevention of swarming, and to turning the bees' *superabundant* energy (no pun intended) upwards into the sections. The giving of plenty of ventilation and "room in advance of requirements" (advice so often reiterated and so valuable where section-honey and no swarming is desired) seems to have acted well with me, for, though my four stocks have been for some time teeming with bees, yesterday (June 5) I saw a drone for the first time this season.

Talking of populous colonies reminds me to refer, rather tardily, to the disastrous cyclone which Dubliners experienced for the first time for sixty-four years. None of my stocks are any the worse for having had their roofs whipped off and carried away till stopped by a high wall. This, too, although the hives were well fastened to stakes! Luckily, the bodies stood firm, and an early examination soon put things to rights.

My strongest stock I supered on 25th ultimo, and two colonies are now working famously, each in two racks of sections. The earlier sources of honey here are whitethorn (of which there are unlimited quantities in the Phoenix Park, about a mile away) and fruit-blossom. Last year I had several extensive patches of *Limnanthes Douglasii* sown, and it is really delightful to see how the bees take to this flower. Almost every little white-and-yellow cup contains its bee, and the hum of the busy pilferers can be heard at a considerable distance.

For the benefit of those novices who regard the operation of giving an additional super under one or more already on very much in the light of an "ordeal by fire"—as I did a year or two ago—I give my own experiences in the matter for what they are worth.

Selecting the middle of a bright, warm day, armed with my smoker, filled with suitable material well alight, I give a couple of puffs of smoke at the entrance and pause for a few seconds. Then, after loosening the section-rack already on with a knife to allow of ready removal, and sending a little more "smoke" down through the top of the same, I quietly but quickly raise the partially-filled rack and setting it down on the edges of the "lift" (to prevent crushing bees) laid ready on one side, I give more smoke to send the bees down from frame-tops out of the way. Then, placing the second-prepared rack on top of the frames, I replace the first super on top, and all is finished. If done as quickly as possible compatible with smoothness and quietness of working (*Festina lente* is an excellent motto for the bee-keeper!) the nervous beginner will be surprised how easy the operation is. Rarely will even a single bee offer fight, and the chance of crushing is reduced to a minimum. One caution is, however, needful. The amount of smoke given should only be just sufficient to secure the end in view.

Smoke given *ad libitum* upsets the bees, and they are longer getting to work again.

I have tried the plan so often advocated of *sliding* the crates along the frames, but invariably more irritation has resulted to the bees than by the above method. It sounds quite easy to say "just slide the section-rack along the frames," but in practice it is not so easy. There are generally little bits of comb and propolis about which make the "sliding" jerky, and therefore annoying to the bees, and it is next to impossible to avoid temporarily catching some of them by the legs—an excellent way of ensuring their "making for you" in the proverbial "bee-line."

As to the comparative merits of the "carbolic cloth" and the "smoker" as bee-quieters, personally I prefer the latter; the carbolic cloth not being either rapid or effective enough in most cases, though at times it is no doubt invaluable. However, my "notes" are exceeding their due proportions, and I must stop. Wishing you and all bee-keepers a prosperous year, I enclose my card and sign—"DUBLIN BEE," *Dublin, June 6.*

## LONG SECTIONS

FOR HEATHER HONEY.

[5140.] At the annual meeting of the N. and D. B.K.A., held at Newcastle-on-Tyne last March, Mr. John Walton, Blackhill, exhibited a 3-lb. section of heather honey, gathered in August, 1902. The size was  $12\frac{3}{4}$  in. by  $4\frac{1}{2}$  in., made up of two ordinary 1-lb. sections, and stiffened on top-bar by the addition of two pieces of wood which held the foundation. Mr. Walton tried these 3-lb. sections on several hives, as follows: Section racks were fitted with alternate rows of 3-lb. sections and three 1-lb. sections, all being fitted with foundation alike, and it was stated that the 3-lb. sections were all drawn out and filled, while the 1-lb. sections were scarcely touched.

Considering the poor season last year at the moors, this experiment of Mr. Walton's is of great value to heather honey producers, and I was pleased to note the suggestion Mr. Gao. M. Saunders (5132, page 223) regarding shallow-frames as sections, and trust that he will try the idea of Mr. Walton this year and later on give his opinion on same in pages of the B.B.J. for the benefit of readers.—J. WADDELL, Hon. Sec. N. and D.B.K.A.

## CARBOLINEUM AS HIVE-PAINT.

[5141.] I beg to thank you and also to express my indebtedness for reply regarding painting hives with carbolineum to Mr. L. S. Crawshaw and H. Ballington for the kindly words of warning on page 212. Since writing you the first time I was talking to a bee-keeping friend and it appears that he tried "Carbolineum" once, but the bees did not like it as the odour never leaves the wood. I have therefore decided to paint my hives with light coloured paint.—*New Forest, Hants.*

## HO ! SENTINEL !

Ho ! sentinel bee !

What of the morning, sentinel bee ?  
Gleams on the threshold the sunrise alight,  
Paling the morning star never so bright ?  
Rises a mist from the dews of the night ?

What of the morning ? Ho ! sentinel knight.

Ho ! forager bee !

What of the pasture, forager free ?  
Seek we the highland, or seek we the low,  
Or where the blossoms of yesterday blow ?  
Lead where the richest of nectaries flow,  
Haste to the pasturage, forager slow.

Ho ! sentinel bee !

What of the homestead, sentinel bee ?  
Home we come bearing the spoil of the field,  
Nectars and many-hued pollen our yield ;  
Peaceful our mission—no weapon need'st  
wield,

Home is the password, thou amazon shield.

L. S. CRAWSHAW.

## WORKING FOR EXTRACTED HONEY.

Just as soon as the crop begins to yield we place our extracting supers on the hives, usually one to each colony. If the outlook is very promising, and some colonies extra strong, we give these two supers. Of course, the combs are already built in these, and all the bees have to do is store the honey. If our supply of supers and combs proves insufficient before the crop is at an end, we often resort to equalising—*i.e.*, we take sealed combs from full supers and exchange them for empty ones removed from the supers of poorer colonies which have been unable to fill theirs ; some colonies filling two or three supers, while others only begin to store honey. By this equalising we secure a greater amount of filled supers, and save handling empty combs when the extracting is done.

When the clover crop is fairly over, extracting is begun. We never leave the supers on with clover honey in them for the fall crop, unless the amount of honey harvested is so scanty as to make it unprofitable to extract. The mixing of clover and fall honey is objectionable, unless the honey is very thoroughly mixed, because when honey of two grades is extracted at same time it is apt to make streaks of different shades, and is not so nice as if uniform. Yet we must say that a mixture of clover and fall honey makes a very saleable article, if the different grades are thoroughly mixed, and we have often made such a mixture to satisfy fastidious customers, but the honey must be heated and stirred well in order to mix properly, and it requires great care not to spoil its flavour in heating.

As a rule, it is much the best to harvest each grade separately, and so we aim to extract at least twice a year, once in July and the second time in September.

As to honey getting too thick, there is little

danger of that, and we prefer to have it a little too thick than too watery, as it is sometimes, especially the first crop, when it contains any lime honey. The latter honey has always given us the greatest trouble to secure it sufficiently ripened, even if left on the hives for some time after the end of the harvest.

We say that we always extract at the end of the crop, but there are no rules without exceptions. We have had seasons when it would have been out of the question to keep the bees supplied with sufficient room, had we not taken the honey off two, three, and even as many as five times during one crop. But such seasons are rare. Yet we must be prepared for them. The more scarce they are, the more important it is to take advantage of the good luck.

We have often tiered up three supers, one above the other, and our supers contain from 55 lb. to 65 lb. each. We have rarely put more than three of them on one hive. We do not believe there is any objection to tiering up still more, only with a narrow hive like the eight-frame Langstroth, one must be very careful how they are placed. The least slant to one side or the other would perhaps cause the hive to tip, as the weight of the honey would increase the settling to the lower side. We have no use for the eight-frame hive, even for comb-honey production. The ten-frame hive is small enough.

If the honey of the fall-crop is left on the hive till November, it may become so thick as to be inconvenient to extract. As a rule, it is best to extract the crop just as the harvest ends. By this method we not only secure as ripe honey as can be had, but also save much labour by doing the work all at one time.

Some apiarists haul the supers home from an out-apiary to do the extracting at leisure. We do not like this method. We extract on the spot, and return the supers to the hives at once. Whatever may be said in favour of the method of taking the combs home, our method is more expeditious and more economical.

Regarding the removal of the brood to prevent swarming, we do not recommend it. This method at best would only prevent the issue of a part of the natural swarms, but the apiarist would have to make artificial increase with this brood, or cause swarming with the colonies to which it would be given. It would entail much labour and some risk, and hardly answer its purpose.

If an apiary is properly conducted for extracted honey with large hives, and a plentiful supply of supers filled with combs, there will be very little swarming, and it will not prove necessary to take any measures to prevent it. Ordinarily, such measures would be useless, or worse than useless. A colony which is at all times supplied with a large quantity of empty combs, will make no preparations for swarming, unless it is in an uncomfortable position, exposed to the sun, or with too little ventilation, or with too many



drones. Neither will such a colony produce much wax. I have seen it often stated that the bees produce wax independently of their will. The quantity thus produced is very small. It is only when they are compelled to remain full of honey for hours and days that the small scales of wax are produced, seemingly owing to the prolonged holding of a surplus of honey within their sac. When the colony swarms each bee takes a load, and as they find no combs in their new abode, they are compelled to carry this load until a part of it has been changed to wax. The bee which finds room to unload her honey sac as soon as she arrives home, produces only a minimum of wax. That is one reason why the production of extracted honey is so great when a full supply of combs is furnished to the colony.—C. P. DADANT in *American Bee Journal*.

## Queries and Replies.

[3121] *Dealing with Foul-brood.*—My neighbour has a stock of bees affected with foul-brood; the stock in question is very strong, ten frames crowded with bees, working vigorously, and just taking to the supers. Under these circumstances, do you recommend leaving them, with the supers on, and taking the surplus honey, and immediately at the end of the honey-flow run the bees into a skep, confine them for forty-eight hours, burn contents of hive, and feed them up for the winter as driven bees; or take them off frames now and deal with them as above? In this case no surplus honey would be got. There are other hives in close proximity. Apologising very much for troubling you.—T. W., Kent, June 8.

REPLY.—You give no particulars as regards the extent to which the bees in question are diseased, but as the stock is evidently strong and doing well, we should let them work in supers till end of the honey-flow, and deal with the bees as proposed after removal of surplus honey. See, however, that the work of preparing for winter is begun early in the autumn to allow of new combs being built out and the food given sealed over before cold weather sets in. It might also be well to give the stock a young queen in lieu of old one, if possible, when packing down.

[3122.] *Bees Deserting Hive.*—The bees deserted one of my hives last week, owing, may be, to lack of attention, as I was prevented from attending to them, and I fear they got short of food, though they had all their stores left them last year, and plenty of candy from February up to April. They seem to have joined my Italian stock, for I notice a great number of black bees among the latter. To make quite sure it is not a case of foul brood, I send on a piece of comb taken from

the deserted hive, and will be obliged if you will report on same.—HOPEFUL, *Kinver*, June 3.

REPLY.—There is no disease in comb, which clearly shows a case of deserting the hive through starvation.

[3123.] *A Beginner's Queries.*—I am only a beginner at bee-keeping and will be obliged for reply to the following questions in your valuable journal:—1. In putting on a queen-excluder, how can one do it without squashing bees? 2. How do you renew the supply of naphthaline in a hive? As far as I can see it requires removal of a frame or two in order to get space for giving a fresh supply. 3. Yesterday I put on a second super, and, owing to the sections standing a bit higher than the super the top one does not fit close to the lower one, but, as it were, stands on the actual sections, which, I should think, would cause a draught which ought to be avoided. Is this so, or does it not matter as it is a "W.B.C." hive?—H. C. T. B., *Foots Cray, Kent*, June 5.

REPLY.—1. Give a puff or two of smoke when removing the quilts and slide the excluder over the surface of top-bars as the bees are driven down. This can be readily done without crushing a bee, if care is used. 2. The removal of dummy-board gives space for inserting the half of a split ball of naphthaline without lifting frames. 3. The sides of properly made section-racks fit closely all round one above the other without any such misfit as is named. It is important to keep surplus-chambers warm and avoid through draughts while sections are being filled, whatever type of hive is used.

[3124.] *Dealing with Weak Stocks.*—Will you kindly inform me if sample of comb sent is affected with foul brood? It was taken this morning from a stock which has been rather weak up till lately, but which, I find, has gained considerably in the last three weeks. I may say I gave the stock a frame of capped brood from another hive about a fortnight ago. I have fourteen other stocks, and know of no foul brood anywhere in the neighbourhood, so hope I am mistaken.—J. S., *Oxon*, June 6.

REPLY.—The dead larvæ in comb is not affected with foul brood, but has probably been chilled for lack of bees to cover and keep it warm. Is the comb sent cut from the frame of capped-brood given from another stock a fortnight ago? If so, it would account for its being chilled, as the "weak lot" of bees would be unable to do more than cover and attend to the brood already in the hive.

[3125.] *Bad Methods of Swarm Preventing.*—I was rather disappointed by your reply to the query of "Enquirer, Suffolk" (3119, page 228), in B.J. of June 4, regarding the use of excluder zinc across hive-entrance to prevent swarming. 1. Would you be good enough to tell me as a beginner the nature of the "mis-chief" it leads to. 2. Would a swarm-

catcher cause the same mischief? I have a swarm-catcher on one of my two hives, and the bees have to work through excluder zinc. Now I find that the drones ascend freely into the chamber of "catcher" from which they cannot return to the hive, and I can easily release them by lifting off the cover, and so get rid of them. I shall remove the catcher until I see your reply to above, and probably lose my swarm, as I am only at home for a short time in the evening, and have no one whom I could leave to watch. I admit, of course, having a swarm-catcher is somewhat different from a strip of excluder in the entrance, but I do not see any difference in its effect on the bees. 3. Can you tell me why the queen in my other hive—though extremely prolific—does not breed a single drone. There is no drone-comb in the hive, but I have given it a comb containing drone-brood from the other hive.—BEGINNER, *Chester*.

REPLY.—1. The nature of the mischief may be readily imagined by realising the difference you admit there is between a swarm-catcher and a small strip of excluder zinc across the hive entrance. In one case the drones—as stated—have free access to the "catcher," and can be released at will, while the passage-way of the worker is not impeded by them. In the other case, not a tenth of the passage-way is allowed for the bees, and the few holes of the excluder open to the workers are blocked up by drones vainly endeavouring to squeeze through them. Surely this is mischief enough? 2. The trouble is not a tithe of what follows in the first case, yet all good bee-keepers detest having to use "catchers" even when obliged to do so, because of the hindrance to free working they inflict on strong stocks in warm weather. 3. The absence of drone-comb in the hive accounts for the non-production of drones.

[3126.] *Dealing with Foul Brood*.—Last summer the whole of my apiary, consisting of about forty hives (nearly all of which were more or less diseased), were treated as directed in the "British Bee-keeper's Guide Book," and now, upon inspection, all except two appear to me to be perfectly healthy. I have enclosed a sample of brood from each of the two hives last-named, and will be glad if you will say if my suspicions with regard to them are correct. I enclose name, &c., while signing myself—THREAKERS, *Herts*, June 3.

REPLY.—Both samples of comb show unmistakable signs of incipient foul brood, though in each case young bees are hatching out all right, and but a very small proportion of the larvæ is affected. There would no doubt be a fair chance of utilising the bees, say by getting both lots off their combs, and after uniting, treating them as a swarm in a clean hive. On the other hand, in view of the risk to the thirty-eight now healthy colonies, we should be strongly tempted to do away with

the diseased stocks as being true economy in the long run.

[3127.] *Dealing with Drone-breeding Stocks*.—The enclosed piece of comb is taken from a hive which must have lost its queen either late last year or early this, as the queen they now have is a young one and a drone-breeder. The sample being suspicious-looking I would be glad of your opinion? It may only be chilled brood, as the bees were much scattered over the ten combs. I have now contracted the hive to four frames, which the bees cover well. Should there be no disease I will give a ripe queen-cell, and help up with brood from other hives, but not otherwise. I send name, &c., while signing myself—BEES, *Midlothian*, June 8.

REPLY.—There is a very slight trace of incipient foul brood in the comb sufficient to show danger, and as the adult worker bees will be old and die off rapidly we should not advise your wasting time and trouble in re-queening the stock. To use an aphorism, "the game is not worth the candle."

[3128.] *Swarms Joining of Themselves*.—In "Guide Book" (page 18) it states that "sometimes two swarms will issue simultaneously, and join together of themselves; when this occurs they should be treated as one, not separated." 1. Will you kindly inform me if this refers to swarms from different hives? 2. Will one hive ever cast off two swarms at same time?—L., *Keswick*, June 7.

REPLY.—1. Obviously, yes. 2. Two swarms could not issue from the same hive "simultaneously," except in the case of delay in the issue of second or third swarms, in which case the bees occasionally issue in two small lots, each being headed by a young queen. The "Guide Book" plainly refers to swarms from different hives.

[3129.] *Bees Refusing to Enter Sections*.—I have a hive strong in bees, and the frames full of honey and brood, and I put on eight days ago a rack of sections with full sheets of foundation, but the bees will not work in them. 1. Will you be so good as to tell me what it would be best to do under the circumstances? 2. I have just made three hives, and should like to know if a lead paint would hurt the bees; if so, what would you recommend in preference? 3. Where can I purchase a "Raynor" feeder as described on page 110 of "Guide Book"?—BEGINNER, *Lincoln*.

REPLY.—1. Wrap the sections as warmly as possible, and allow no escape of warmth from brood-chamber. The bees will enter if you conserve the warmth by plenty of warm wrappings. 2. Ordinary paint is not hurtful. 3. Any of our advertisers who deal in bee-goods will supply the "Raynor" feeder.

[3130.] *Making an Observatory Hive*.—Kindly give an answer to the following queries re observatory hive:—1. What distance

should be allowed between the glass doors? Is  $1\frac{3}{4}$  in. sufficient? 2. Is it necessary to provide for ventilation independent of the tunnel entrance? 3. Is it usual to place sections or bell-glass on top of a three-frame observatory, which would be about 2 ft. 6 in. above the entrance? 4. What is the maximum length of a tunnel through which the bees will traverse should it be glass covered? 5. What is the best way to stock a hive of this description?—**BENACHIE, Portsmouth.**

REPLY.—1. If combs are in good condition—*i.e.*, not widened out at top—the  $1\frac{3}{4}$  in. space is right, but  $3\frac{1}{4}$  is the *safest* spacing to adopt. 2. Yes, top ventilation is essential. 3. Of late years a row of sections is often placed above the frames, but usually it is simply to add to the attractiveness of the hive on the show-bench. 4. There is no maximum length for the tunnel. 5. In "stocking," the frames selected are simply hung in the hive with adhering bees, taking care to have enough bees on them to cover the brood well.

## Echoes from the Hives.

*Nantperchellan, Pembrokeshire, June 6.*—My thirteen stocks came through the winter well, and are now working busily in supers. The weather is good and helps one to look forward for a good season. I was glad to see Mr. Woodley (on page 212) inviting attention to "Bee Driving," and I would ask why is bee driving included in the requirements for the B.B.K.A. examinations for experts' certificates? For myself, in order to become proficient I would have to take a retrograde step and keep bees in the old fashioned way or go round the cottagers begging a job at "driving," and in most cases only to find that they preferred the sulphur pit to having their bees "driven."—**W. J. S.**

*Pilsley, Chesterfield, June 8.*—I am rather late with my first "echo" for this year, but bee-work has also been very backward up to the last three weeks. In fact, I have not quite finished my spring cleaning, but hope to have got through it ere I see these lines in print. The bees are now going for all they are worth on the dandelion and buttercups, so plentiful in the fields; but we have had no May-bloom at all to speak of so far, nor do I know of a sycamore tree in my neighbourhood that has shown any bloom this year. Sycamore-bloom must be very scarce, for I have only seen one tree with any bloom on at all. The bees have got a nice bit of new honey off the flowers now in bloom in the woods and fields hereabouts. We have a few apple trees about, but not many. Damson trees bloomed in vain for the bees, owing to keen night frosts at the time. My own stocks came out all alive, but I had to unite two lots. I have,

therefore, five colonies now getting in good form for the white clover, when it blooms a few weeks hence. I came across one hive the other day stocked with a good colony of bees that had died during the wet weather in May of sheer hunger. A pound of sugar would have saved it. The next one in the same apiary was on its last legs, for it had ceased breeding and eaten up every ounce of stores when the weather changed for the better just in the nick of time, and saved the bees' lives. The queen had laid about a score of eggs when I found out its condition. I told the owner to join the bees to the next lot to do any good. I had found one of my own stocks very short only a few days before, but after being helped along they are coming on splendidly now. Whit-Monday was a capital bee day, and while overhauling my hives I got "snapshotted." I send you the result, to see if it will do for the "Homes of the Honey Bee."—**TOM SLEIGHT.**

## Bee Shows to Come.

*A nominal charge of 2s. 6d. is made for notices in this column, which covers cost of insertion from order till date of show. Cash should accompany orders for insertion.*

**June 23 to 27, at London.**—"Royal" Agricultural Society's Show. Bee and Honey Section under the management of the B.B.K.A. Increased prizes for B.K.A. Associations as arranged in divisions or groups of counties. **Entries close June 20.**

**July 15 and 16 at Lichfield.**—Annual Bee and Honey Show of the Staffs B.K.A. Open Classes for Comb and Extracted Honey and Appliances. Schedules from Rev. G. C. Bruton, Great Haywood, Stafford. **Entries close June 20.**

**July 16 and 17, at Lincoln.** Honey, Hives, and Bee Appliances, in connection with the annual show of the Lincolnshire Agricultural Society. Bee department under the management of the Lincs B.K.A. £25 in prizes. Schedules from R. Godson, Hon. Sec. L.B.K.A., Tothill, Alford. **Entries close June 16.**

**July 22, at Broughton, Hants.**—Fruit, Flower, Vegetable, and Honey Show. Twentieth year. Liberal prizes, with silver cup, valued £15, open to the United Kingdom. Particulars from Fred. J. Hinwood, Broughton, Stockbridge, Hants. **Entries close July 18.**

**July 22 and 23, at Cardiff.**—Honey show of the Glamorgan B.K.A., in connection with the Cardiff and County Horticultural Society. Bees, hives, honey, trophies, wax, appliances, and articles of food. Substantial money prizes and medals. Free entries. Six open classes. Schedules from William Richards, Gabalfa, Cardiff. **Entries close July 16.**

**July 29, at Wallop, Hants.**—Honey Show of the Broughton and Wallop Branch of the Hants and Isle of Wight Bee-keepers' Association. Two open classes for single-section and 1-lb. jar respectively (entry free). Schedules from Miss Tucker, The Lindens, Broughton, Stockbridge, Hants. **Entries close July 22.**

**July 29, at Henbury, near Bristol.** Annual Show of the Henbury District Bee-keepers' Association in connection with the Horticultural Society's Exhibition. Several open classes with good prizes (two classes with free entry). Schedules from I. Atkin Waller, hon. sec., Pen Park, Westbury-on-Trym, near Bristol. **Entries close July 24.**

July 30, 31, and August 1 and 3, at Old Trafford, Manchester.—Annual Show of the Royal Lancashire Agricultural Society. Liberal money-prizes are offered for honey along with silver and bronze medals of the B.B.K.A. and also of the Society. Open classes for Honey-Trophy, Sections, Extracted Honey, Beeswax, Honey-Confectionery, Bee Flowers, Instructive Exhibits in Bee-Culture, &c. Schedules from Edward Bohane, Secretary, Miller-arcade, Preston. Entries close June 30.

August 3 (Bank Holiday) in the Walled Meadow, Andover.—Honey Show in connection with the Andover and District Horticultural Society. Class for single 1-lb. jar of extracted honey (with no entry fee). Also classes for sections, extracted honey (light and dark), and beeswax. Schedules from the Hon. Sec., Dr. Gillett, Elvin House, Andover. Entries close July 28.

August 4, at Leamington.—Tenth annual show of the Leamington St. Mary's Horticultural Society. Three open classes for Six 1-lb. Sections, Six 1-lb. Jars "Light," and Six 1-lb. Jars "Dark" Extracted Honey, respectively. Liberal money prizes. Schedules from P. W. Smith, Secretary, 22, Leam-street, Leamington. Entries close July 30.

August 6, at Nantwich.—Honey department of the Cheshire Agricultural Society's Show under the management of the C.B.K.A. Numerous classes for hives, honey, and wax. Money prizes and medals. Schedules from T. A. Beckett, St. Werburgh's Chambers, Chester. Entries close July 16. At double fees July 23.

August 6, at Kingsthorpe, Northants.—Honey show of the Northants B.K.A., in connection with the Horticultural Society's Exhibition. Three open classes with special prizes, including one for single 1-lb. jar of honey. (Entry free.) Prizes 20s., 10s., 7s. 6d., and 2s. 6d. Schedules from R. Hefford, Hon. Sec., Sunnyside, Kingsthorpe, Northampton. Entries close August 1.

August 12, at Radstock, Bath.—Honey show in connection with the annual show of the Radstock and District Horticultural and Fanciers' Association. Schedules from the Secretary, B. M. Clark, 1, Fox Hills, Radstock, Bath.

August 25, at Cartmel, Lancashire.—Honey show in connection with the Cartmel Agricultural Society. Open classes for sections, extracted honey, and beeswax. Local classes for sections and extracted honey. Schedules from Wm. Cragg, Secretary, Cartmel, via Carnforth.—Entries close August 13.

August 27, at Llangollen.—In connection with the fifth annual Flower Show. Open classes for Six 1-lb. Sections, Six 1-lb. Bottles Extracted Honey, and Beeswax. Schedules from Frank Little, Castle-street, Llangollen. Entries close August 13.

August 27, at Montgomery, in connection with Montgomery and District Horticultural Show. Open classes for Six 1-lb. Sections and Six 1-lb. Jars Extracted Honey. Prizes in each class 10s., 5s., 2s. 6d. Entrance-fee 1s. each. Schedules from W. J. Jones, Secretary, Montgomery. Entries close August 20.

### Notices to Correspondents & Inquirers.

Letters or queries asking for addresses of manufacturers or correspondents, or where appliances can be purchased, or replies giving such information, can only be inserted as advertisements. The space devoted to letters, queries, and replies is meant for the general good of bee-keepers, and not for advertisements. We wish our correspondents to bear in mind that, as it is necessary for us to go to press in advance of the date of issue, queries cannot always be replied to in the issue immediately following the receipt of their communications.

J. B. W. (Gelli-Lydan).—*Excessive Pollen-gathering.*—Bees do at times gather pollen in such quantities that the brood-combs become pollen-clogged, and, in consequence,

are useless for either brood-rearing or honey-storing. Such combs must be replaced by serviceable ones without delay.

B. D. (Torquay).—*Packing Space in "W.B.C." Hives.*—1. The space between outer-case and hive-bodies of hive named is at no time "filled in with cork-dust." The space is not filled in at all for winter, but left as a free air-space to promote the health of bees. It may be helpful in early spring to fill in the space with crumpled-up newspapers (easily removable) when giving extra top-coverings to add to warmth of brood-nest, but that is all. 2. When giving a swarm, the body-box is raised up an inch or more in front, using the entrance-slides as wedges, as described and illustrated in "Guide Book."

P. L. F. (Leeds).—*Honey Samples.*—The honey may be pure, but the quality is not good. On the other hand, "a cold stone scullery" is not a proper place to store honey in if it is to be kept in good condition.

"MERTON" (London, E.C.).—*Irregular Egg-laying in Weak Stocks.*—When queens lay five or six eggs in a cell it is evident the stock is in abnormal condition from some cause. In your case it is probably the inability of the few bees to cover brood and the prolificness of the queen that cause the trouble.

#### Suspected Combs.

*Special Notice to correspondents sending queries on "Foul brood."*

We urgently request that all letters sent with samples of suspected comb be put outside the box or tin containing the sample. Also that no more than a couple of square inches of comb be sent, taking care to neither crush the comb nor probe the cells before despatching.

In urgent cases (and where possible) we undertake to "wire" replies as to F.B. if six stamps are sent to cover cost of telegram. All letters should be addressed, "Editor," not "Manager."

B. O. T. (Staffs).—1. Comb sent shows a bad case of foul brood. 2. We cannot understand the dealer, whose name you send, supplying a stock of bees as "all right" if in the condition described with regard to wax-moth when received. They should have been promptly returned after inspection when purchased last year.

J. B. M. (Yorks).—Dead brood in comb is "chilled" only, not diseased.

L. P. (Leamington).—Decided case of foul brood.

G. G. (Belvedere) and E. S. H. (Bognor).—Chilled brood only in samples.

R. W. P. (Darlington).—A clear case of foul brood, though not so distinctly noticeable as usual. We find a few diseased larvae only recently infected, but close examination shows traces of disease in the spore stage. It has therefore existed in the hive evidently for some time past.

\*.\* Some Letters and Queries are unavoidably held over till next week.

## Editorial, Notices, &c.

### FORMALIN OR FORMALDEHYDE?

The article on page 226 of our issue for June 4 has aroused some interest in the germicide known among American bee-keepers as formaldehyde, and used for disinfecting hives and combs occupied by bees affected with foul brood. Inquiries which have reached us include the following: (1) What is formalin? (2) Where can it be obtained? (3) What is its price? (4) How is it used? (5) Is it a poison? (6) Is it liquid or solid? (7) Is it dangerous to use? For ourselves, we have never used formaldehyde, but know it to be a most powerful germicide, and also a dangerous poison if taken internally. But the following remarks regarding it, which appear in current issue of the *American Bee Journal*, are so much to the point that we reproduce them. The writer, Mr. R. D. Cleveland, says:

"As I am *not* a chemist, perhaps I can the better tell laymen about it. My experience with it has been practical, and what I don't know about it might fill a volume, but I'll try not to go that far.

In the first place, so far as the laymen go, the two words mean the same. Formaldehyde bears the same relation to formalin that ammonia does to aqua-ammonia. Ammonia is a gas, and aqua-ammonia is water charged with the gas of varying strengths up to 26 per cent., after which the water will absorb no more.

Formalin is water charged with the gas—formaldehyde—usually to about 40 per cent. Commercially, all we ever have to do with is formalin, so we might as well drop the longer word.

It was discovered not many years ago by German chemists, and has been largely used as a germicide. It has a peculiarly sharp odour, and produces a stinging sensation in the nose some time after smelling it. To some it is more offensive than ammonia, and would better be approached with caution on first acquaintance. It is as harmless as ammonia, however, and is good for catarrh.

As it is an absolute preventive of mould and fermentation, it has been largely used for that purpose. A few drops in a quart of milk will keep it sweet for days, or in paste will preserve it indefinitely. (Try this.)

Being so good a preservative, milkmen, brewers, and others have 'got on to' it, and here is where the abuse of a good thing has come in. It has been found extremely dangerous, if not deadly, when taken into some stomachs, and is now condemned as a preservative of foods by various health departments.

It renders gelatine or glue insoluble in hot water, and is an antiseptic toughener of the skin. The German soldiers are made to bathe their feet in a weak solution of it, and

to drop a little in their shoes to toughen them and prevent sweating.

As a germicide I believe it is considered pre-eminent by the best authorities. Sheets saturated with it are now used almost universally for disinfection after contagious diseases, and it is regarded as sure death to all germs of disease.

It may be bought of any druggist, and costs about as much as ammonia."

While hoping that formalin will prove a valuable agent in destroying the spores of foul brood in hives and combs, we must point out that the drug named is a germicide so powerful in its effect that it means certain death to any living brood of bees within reach of its fumes. Therefore, however useful it may be for disinfecting purposes, to call it a "cure for foul brood" is as misleading as it is to say that either naphthaline or naphthol beta will cure foul brood by destroying the spores. This is an error many fall into, but the fault is not ours, as we have never gone beyond saying that the value of antiseptics is limited to the bacillus and has no effect on spores.

### ESSEX AGRICULTURAL SOCIETY.

SHOW AT BISHOP'S STORTFORD.

The above Society held its annual show at Bishop's Stortford on June 9 and 10, in connection with which the Essex and Suffolk Bee-keepers' Association arranged a honey show and bee-tent for lectures and demonstrations of practical bee-work. The honey-tent was managed by Messrs. W. J. Sheppard, Hon. Secretary, A. W. Salmon, and W. A. Withycombe, the County Expert. The exhibits staged were less numerous than the entries, owing to the scarcity of 1902 honey, coupled with the present adverse weather. The quality, however, was good, and the competition keen. New inventions and bee-appliances were numerous, Mr. E. H. Taylor, Welwyn, Herts, staging a most useful collection of hives and appliances of every description. The numerous visitors to the tent were keenly interested in the observatory hives shown stocked with bees by Messrs. E. H. Taylor and W. Loveday. Lectures were given at intervals in the bee-tent by Messrs. W. A. Withycombe and A. W. Salmon, and were very largely attended. Dr. T. S. Elliot officiated as judge of the bee exhibits, and made the following awards:—

*Collection of Hives and Appliances.*—1st, E. H. Taylor, Welwyn, Herts.

*Observatory Hive (with Queen and Bees).*—1st, W. Loveday, Hatfield Heath, Harlow; 2nd, E. H. Taylor.

*Complete Inexpensive Frame-hive.*—1st, Jas. Lee & Son, London; 2nd, E. H. Taylor.

*Frame-hive made by an Amateur.*—1st, C. Lodge, High Easton, Dunmow.

*Beeswax.*—1st, C. Lodge; 2nd, W. Loveday.

*Useful Inventions.*—1st, J. H. Howard, Holme, Peterborough (bee-spaced woven-wire

dividers for sections); 2nd, Jas. Lee & Son (new eight bee-way super-clearer); 3rd, H. Edwards, Sunningdale, Ascot (queen-rearing apparatus).

*Display of Honey, Mead, and Vinegar.*—1st, W. Loveday; 2nd, C. Lodge.

*Six 1-lb. Sections.*—1st, W. Loveday; 2nd, C. Lodge.

*Three 1-lb. Sections.*—1st, W. Loveday; 2nd, C. Lodge.

*One 1-lb. Section.*—1st, C. Lodge; 2nd, W. Loveday; 3rd, T. Bunting, Debden.

*One Shallow-frame of Honey.*—1st, W. Loveday.

*Six 1-lb. Jars Extracted Honey.*—1st, C. Lodge; 2nd, W. Loveday; 3rd, G. Hills, Comberton.

*Three 1-lb. Jars Extracted Honey.*—1st, C. Lodge; 2nd, J. B. Houle, Chittlehampton; 3rd, W. Loveday.

*Six 1-lb. Jars Granulated Honey.*—1st, W. Loveday; 2nd, C. Lodge.

*One 1-lb. Jar Extracted Honey.*—1st, W. Loveday; 2nd, G. Hills; 3rd, Miss Barker, Barnston.

*Honey Vinegar (1 Pint).*—1st, W. Loveday; 2nd, C. Lodge.

*Mead (1 Pint).*—1st, T. Bunting; 2nd, W. Loveday.

The silver medal of the B.B.K.A. for the best exhibit of comb-honey was awarded to W. Loveday, the bronze medal of the B.B.K.A. for best exhibit of extracted honey going to C. Lodge, and the Association's certificate for best granulated honey to W. Loveday.—(Communicated.)

#### HONEY IMPORTS.

The value of honey imported into the United Kingdom during the month of May, 1903, was £3,362.—From a return furnished to the BRITISH BEE JOURNAL by the Statistical Office, H.M. Customs.

## Correspondence.

*The Editors do not hold themselves responsible for the opinions expressed by correspondents. No notice will be taken of anonymous communications, and correspondents are requested to write on one side of the paper only and give their real names and addresses, not necessarily for publication, but as a guarantee of good faith. Illustrations should be drawn on separate pieces of paper. We do not undertake to return rejected communications.*

#### AMONG THE BEES.

[5142.] *The Rymer Method.*—In recording the results of 1901, I think I mentioned that a limited trial of Mr. Rymer's method had not been very successful in my hands. The fault was not his but mine, if fault there was, yet my attention has lately been drawn to a statement by a contributor implying that I had condemned this plan. I, on the contrary, highly approve of it and of its receiving an exhaustive trial, and I trust we shall have quite a number of reports at the end of the

season from those who have fairly tested and can cordially support it as one worthy of being considerably extended in heather districts. We want some systematic plan which would thus almost automatically supply us with a colony abnormally strong just when heather starts into bloom. In my opinion, this is secured by the policy under consideration, which, in theory at least, provides a ready way for the manufacture of thousands of young bees during the month of July. A pretty lengthy experience of the practical side of the question enables Mr. Rymer to declare the complete success of his scheme, and the results in surplus-storing secured by his hives prove beyond cavil that he can get not only bees, but honey. I am anxious that heathermen should lay their heads together and bring out all the best of their experiences to aid their less experienced brethren to secure a full harvest of this admirable specimen of one of nature's richest and most luscious sweets. Mr. Rymer might therefore favour us with all that he has of the latest and best in regard to his scheme at an early date, so that preparations might be made in advance.

*A Novel Beehive.*—In many of our provincial towns we find merchants use as a sign of their places of business a huge beehive, gaily coloured a golden hue. Generally it is a go-ahead grocer who adopts this emblem of industry and energetic application to business. I have, however, discovered that in the City of Aberdeen there now exists, or lately did exist, such a sign, unique, I should think, of its kind, for it was exhibited by the proprietor of a public-house. A large hive was hung above his door, with a number of buzzing bees all around it, and inscribed on it was this legend in rhyme:—

“Within this house we all love,  
Good whisky makes us funny;  
If you are dry, step in and try  
The beverage of our honey.”

*Simple Nuclei Forming.*—A plan which I find very successful is the following:—Taking advantage of the fact that bees from a distance will stay wherever they are planted down, I obtain a 4-lb. or 5-lb. lot of driven bees as early in the season as possible. If a number of queen cells have been secured, reared from our best available queen, and about twelve days' old, four or five excellent nuclei may be obtained with little labour and no worry. Take a comb with some brood and honey and place two frames on either side of it, with empty comb or full sheets of foundation, contracting the hive to this space, and warmly wrapping all above and around. Now cut out one or two of the prepared cells with a good margin of comb, fixing them securely in the centre frame, and into this nucleus hive run in about 1 lb. of the driven bees. Five or six of these may be made up from the driven lot, and the strangers at once settle down to the new location, and work with a will drawing out the new comb, or storing honey and pollen. In about a fortnight it may be safely counted

on that these young queens have hatched, been mated, and are busy laying. They have required no supervision, which is an important feature of the plan, and to many busy men almost a necessity. Early August is generally an excellent time for rearing these young queens to replace old or worn-out mothers; and if the season is a good one they prove a success without any worry or watching to see that they are not depleted by the old field-bees returning to their original hive, as too frequently takes place when we make up nuclei with our own home bees.

An important point necessary to secure the best and most successful results in nuclei-forming is to aid the virgin in overcoming the natural difficulties encountered by the young queens on their marital flight by planting these small colonies on well-marked sites apart from other hives, and facing different points of the compass. Another point often overlooked is that, if the weather is wet, cold, or stormy, they should receive gentle stimulative feeding until it becomes more propitious. It keeps up the energy of the small lot of bees, even though not required as an actual necessity. Nuclei should at all times be kept very warmly wrapped up, and everything done to add to the comfort and wellbeing of the tiny community. Too small lots should not be formed, as undoubtedly the state of the nucleus has a reflex influence on the future success of the queen.

*The Roll Call.*—As I anticipated early in spring, far too many empty hives adorn our bee-gardens. I think I am safe in estimating that 25 per cent. of the colonies winter-packed have died out completely, or dwindled down to such a state of depletion that they were worthless; while another 25 per cent. may be set down as weaklings, most of them being very questionable assets as far as securing surplus goes. This leaves only half capable of being classified as thoroughly fit and efficient. These promise well, but the accounts I have lately received from the centre, and even the South of England, confirm the impression I had already formed that the season is in every way a late one. Ever since June came in, however, the weather has been ideal, so there is hope for us yet.—D. M. M., *Banff*.

#### NOTES BY THE WAY.

[5143.] The weather, chequered and changeable as it is, has no doubt, been the chief topic of conversation with bee-keepers. June 1 was a glorious day, warm and genial—in fact, an ideal bee-day. Then followed an interval cold as at Eastertide. Somehow Friday is generally a warm day, and so it was that week; but on Saturday and Sunday we had cold easterly winds. My bees worked for about three hours on Saturday afternoon, but Sunday was as dull and cold as in November.

Very few bees visited the drinking-places, showing that no honey had been gathered of late. I visited my out-apiary and found all quiet and the entrances clear of bees as in mid-winter, save where there was not room for all the bees to get inside. My "watcher" for swarms had retired to his more congenial fire-side. I returned home bemoaning the tardy advance of things apicultural, when my good wife reminded me that it was much the same last year, for we were feeding some stocks on June 6, and that it was very wet during the show week at Reading in 1902. Our hope now is for a speedy change for the better to enable our bees to garner some of Nature's sweetness.

*Wax-moth.*—In districts or apiaries where this pest exists, a sharp look-out should be kept for larvæ or developed moths, because the latter part of June and July covers the period when these pests increase rapidly. Also when supers are put on see that no larvæ or cocoons are left in the saw-cut of top-bars or under the projecting ends of frames. Examine the crevices between hive sides and round all edges of dummies for traces of moth. If the pest gets possession of straw skeps, make a bonfire of hive and contents.

*The "Royal" Show.*—I am sorry to see that the entries for the "Royal" have not been satisfactory, more especially as it is now a Metropolitan show, giving visitors from all parts of England a double opportunity of combining the sights of London with the attractions of the big show of the R.A.S.E. No doubt the poor entry for honey is accounted for by the adverse bee-season of 1902. Anyway, let us hope that the younger generation of bee-keepers will not tire of staging specimens of their craft or produce, seeing how it advertises in a practical form to the large section of the British public who attend shows that British honey is still pre-eminent. If we relax our efforts our friends, the foreigners, are ever ready to cater for and seize our markets.

*Later.*—The above "Notes," written for last week's issue, having by accident missed in post, I send on a supplementary "Echo" from the "Beedon" hives, dated June 15:—

The "month of June" has not "put things in tune." In other words, we have not had a good bee-day since Whit Monday, June 1, and now we have passed mid-June. Never since 1888 do I remember such a long spell of unsettled wet weather interspersed—when fine—with cold north-easterly winds. Fields of bee-forage blooming in every direction, yet the poor bees kept idle for days together, and, in some cases, the feeding-bottle still required to keep them from starving. Nevertheless, we still hope for a change for the better, and, even if it comes too late to secure the full harvest expected, may we have such a return as will afford encouragement for holding on to the craft.—WM. WOODLEY, *Beedon, Newbury*.

## LONG SECTIONS.

[5144.] I am glad to see that Mr Waddell (5140, page 235) has come forward to speak for another heather county, as the management for obtaining heather honey is not the same as that required for clover and other honeys. The heather crop coming so late in the year, and growing at high altitudes, the low temperature—especially at night—has to be contended with. I have not the least doubt that Mr. Walton's method would be a success, as the size of comb the bees are allowed to work on is just the same, as I recommend myself, viz., to use shallow-frames "reduced" to  $4\frac{7}{8}$  in. deep over all; but if an all-round wide frame is used it forms a stronger receptacle when it comes to marketing than two 1-lb. sections arranged and built up with two pieces of wood, as on Mr. Walton's plan. For marketing purposes, of course, the projecting ends of top bars need to be sawn off, or they could be supplied ready nicked by the dealers to break off.

Perhaps our Editors will allow me to say—as it is no use to recommend a thing without saying where it may be obtained—that suitable frames of varying widths (according to the weight of comb-honey desired in each case, with the same depth of reduced shallow-frame) can be obtained as follows:—1. Close-ended shallow-frames from Wm. Cartwright, Moore, near Warrington. 2. No. 1 "New" Section-Hangers (used as "frames" without the sections) from Wm. Dixon, 5, Beckett-street, Leeds. 3. No. 33A shallow-frames from James Lee & Son, 4, Martineau-road, High-bury, London, N. There may be other firms who supply these; if so, the editors will, I am sure, allow them to say so.

I have tried the ordinary shallow-frames fitted with thin foundation, for heather comb-honey for some years past, and the yield obtained by them has exceeded by all comparison that obtained by sections. Even weak stocks store in them.—GEORGE M. SAUNDERS, *Keswick, June 13.*

## A BEE NOTE FROM AUSTRIA.

## MOLE TRAPS.

[5145.] Allow me to thank you, and also those correspondents who so promptly replied to my question on the subject of mole traps. I have already made two, but the setting of that "trigger-string-knot" puzzles me a little. I suppose there is no notch in the fork for the knot? I do not like taking up valuable space in our esteemed JOURNAL, but would like to say a few words about our bees. Last year I had about thirty swarms, and took about 1,800 lb. of extracted honey, all of which was sold at 10d. the half-kilo. bottle.

Foul brood I have never seen out in these parts. In fact, except by what is said in our JOURNAL, I do not know what the disease looks like. However, I try to be forewarned, in case of necessity.

My forty-eight stocks are working well, but, so far this year, there have been no swarms; while the bees are killing off drones, as much as to say, "We don't want you this year—so go!" I often take a run on my "bike" to my out-apiary,  $8\frac{1}{2}$  miles from Trieste, at 4.30 a.m., and in about an hour from starting am amongst the bees, hard at work putting in frames, till 10.30, when I ride back to Trieste for dinner at noon. Then off to the Eastern Telegraph Company's office, where I do my regular "eight hours a day" at my ordinary work. So you see I am no drone!

I heard recently of a "bee grotto" located about ten miles from Trieste. I intend to "load up" on an early day, and, with the help of "bike" and camera, will see if it is suitable for a BEE JOURNAL picture, and, if so, will send you a photo, along with a descriptive account, should it be interesting enough for readers in England and elsewhere. Hoping you will excuse this long letter, I enclose name, and sign as before.—"NEMO," *Trieste, Austria, June 9.*

(Correspondence continued on page 246.)

## HOMES OF THE HONEY BEE.

## THE APIARIES OF OUR READERS.

Our bee-garden picture this week shows the apiary of Mr. T. I. Weston, Vice-chairman of the B.B.K.A. We are sorry that Mr. Weston is not seen in the photo; one who has done so much for bee-keeping needs, to our mind, at least, so much of personal introduction as his appearance in the picture would have afforded. Anyway, we are glad to see his bee-garden, and, notwithstanding the owners' reticence regarding his labours on the B.B.K.A. Council, we add a line to say that it is mainly due to his efforts that the scheme of insurance for bee-keepers is now in working order. For the rest the following "notes" need no addition from us:—

"In response to your request for some particulars to accompany the view of my apiary, I send you a few 'cuttings' from that portion of my life which I have given to bee-keeping, and the various interests bee-keeping has led up to. Circumstances took me to Wickham Bishops, in Essex, in 1880—a village distant some seven miles from Hazeleigh, where lived and died the Rev. George Raynor, one of the early fathers of modern bee-keeping. There were several bee-keepers in the parish who were more or less his pupils, and one of them, in November, 1884, sold me his two skeps of bees, being wearied of skep keeping. My note-books tell me my next expense was a 'Bee-keeper's Guide,' on March 11, 1885; for spring had arrived, and the bees were busy, and I, of course, thought I must be busy with them too. Wanting to know how to go to work, I bought the 'Guide,' which I found most useful; but, at first, not having had practice, I went through the usual begin-



ners' troubles. I sympathise both with them and you, Mr. Editor, when I read their queries and your ever-patient replies. I did not write to the B.J., but paid a visit to Hazeleigh, and then for the first time saw a large apiary. I can still picture to myself the tall, spare, white-headed man, courteous in manner, rapid of speech, with keen intelligence in his grey eyes, but sadly deaf, who hastened from hive to hive as he opened one or another to illustrate his remarks with the very object spoken of. The advice so kindly given that afternoon did much to make me a bee-keeper. Shortly after this visit I became a member of the Essex 'Bee-keepers' Association, their expert on his rounds giving me many useful hints,

little interest in pushing them, I let the question drop. Having had good success with my bee-keeping in the year 1890, I thought I would greatly increase my apiary. I had had five years' experience, and formed certain opinions as to what a hive should be, so I made drawings, and then asked for a price for fifty, with unsatisfactory result. I was asking for the unusual, and was asked to pay accordingly. So I took counsel with the village carpenter—a shrewd man who had learned his trade in London—hired a large, airy shed, bought a hand-power circular saw, and, having carefully calculated the quantities, sent the carpenter to the importers to buy the material required. He well earned his com-



MR. T. I. WESTON'S APIARY, WICKHAM BISHOPS, ESSEX.

and showing in practice how bees are best handled. It was in 1888 I first meddled with the appliance question. The local dealer had charged me 2s. 3d. for a large bottle feeder. I remonstrated, knowing something of the glass-bottle trade, and told him I would undertake to supply him with a good one which, after taking an ample profit, he could retail to the public at 1s. each. My ability to do so was doubted, but a ready sale was promised if the supply was forthcoming. The feeder was made, and at 1s. showed a 70 per cent. profit to the dealer. In your columns may be found a very favourable criticism of it, but the advent of candy-feeding stopped the sale of bottle-feeders to a great extent, and there being

mission by choosing good stuff, and when the timber carriage brought it up the heavy task I had undertaken was manifest. I had the help of an elderly villager, whose failing sight had thrown him out of work (a millwright by trade), to turn the saw, which also cut to bevel, rabbeted, or grooved, as needed. The hives are very like some made for Rev. G. Rynor:—A floorboard on four splayed legs, and alighting board, porch and front, and two sides of the outer case—these all nailed together form one portion. The back, held in place by two studs in its bottom edge, dropping into sockets on the back rabbet of the floorboard, and by the plinth of the roof fitting over its top edge. The roof, flat and sloping from front to back, with the boards

long enough to form a deep eave behind, to throw the water-drip clear of the casing. Inside the case is room for an eleven-frame body-box to stand either parallel or at right angles to the entrance, with a deep lift and two section racks over it. The entrance-way is cut in the thickness of the floor, so the brood-boxes and lifts, having no entrance in their sides, retain all bees when lifted out of the casing and carried on a board or tray to the workroom for examination. I made a special wide-ended top bar, which has worked well. Its one drawback is the slight trouble caused by its not easily clearing the bottom edge of the cage of the honey extractor. With slight repairs to legs and roofs the hives have stood the test of hard work, and will yet last a long time if used with ordinary care. Every portion is accessible for cleansing, which, in my opinion, is an essential point in a well-designed hive.

In 1891 my bee troubles began. Foul brood, which had been increasing in Essex, broke out among my bees, and I know how it came. It was a long battle before I quelled it, and it cost me from first to last between fifty and sixty stocks of bees, and the profits of three seasons.

Thinking that the Association should do something to combat the disease in the county, I attended the annual meeting at Chelmsford and thus became acquainted with the late Mr. F. H. Meggy, proprietor of the *Essex Chronicle*, and Hon. Sec. of the Association. From then till 1898 I took an active part in the work of the Essex Association, the most difficult task being a census of the bee-keepers in the county and the number of stocks they had in frame-hives and skeps. The information proved of much value to the expert in his work and to the secretary. In 1896 I was invited to join the B.B.K.A., and was shortly afterwards elected on the Council. The investigation into the occurrence of foul brood in Essex, which I had made with Mr. Meggy in 1894, was of use in helping forward the endeavour to obtain compulsory powers for dealing with foul brood, but unfortunately has so far proved unsuccessful. In 1898 I took up the question of wax-extracting by solar heat—an old subject, but much neglected. After trying several forms of extractor I made one which worked sufficiently well to recommend for use. It was exhibited at the 'Royal' show at Birmingham, where a first prize was awarded to it. In 1898, business cares took me away from my bees, and since then I have done only an occasional day's work there. They have been in the charge of Mr. Thos. Hammond, of Great Totham, who may be seen standing among them. I did not, however, give up the pleasure of meeting my colleagues in their work at Jermyn-street, my share in which need not be here referred to, beyond saying that I hope long to be able to assist them in promoting the welfare of bee-keeping in the United Kingdom."

## CORRESPONDENCE.

(Continued from page 244.)

## FRAME HIVES AND FOUL BROOD.

[5146.] A recent observation by a bee-keeper of some standing, to the effect that the frame-hive is responsible for much of the spread of foul brood, leads me to take up the cudgels in its defence, believing that the view is based upon a misconception, and that the matter will bear ventilation.

It is seriously argued that disease is more rampant now than in the old skep days, owing to its more ready propagation by contagion, and the loss of the check undoubtedly exercised upon it by the annual destruction of combs. But are these the full facts? What complete knowledge have we of the range of the disease in skeps? How was it ever possible to judge of this accurately, or to estimate it at this day? Is the testimony of the skeppist upon the point reliable? Most emphatically not! Ask to-day one of this school—whether the possessor of frame-hives or not—if he has foul brood, and he will most likely assure and reassure the negative, whilst an examination may show his back garden to be a hotbed of the disease. Does he know it? Probably not, and here is half the trouble, for his bee-keeping is built upon a foundation of ignorance and superstition which the skep hive does much to foster and protect. "But the disease has spread." That may be possible, only do not mistake better statistics for increase of the complaint. It may have spread. It must, in the nature of things, do so; but it remains to be proved that the spread is greater than would otherwise have been, and that it is still spreading more rapidly in spite of all associated effort to reduce it.

The destruction of combs is very well in its way, but the methods of the skeppist do not ensure against infection. The very plan of removing his "surplus" (*sic*), and his smearing of the skep with infected honey, is a simple, but probably effective, method of ensuring a further culture when the skep is stood outside to be cleaned up by the bees, or when doing another year's service. I also ask: Is it always the older combs which are destroyed? It is possible that some old skeppists are so fatuously blind to their own interests as to destroy the old stock and save the swarm, but although I have known an instance of this it is certainly not the general practice. Even if unaware that he thus sacrifices his young queens, he is less inclined to use the dirtier older comb. "Needs must," of course, when the shortage of honey drives, but this method cannot be regularly practised without serious diminution of stocks, because swarms too light to "take up" are often too light to winter well. I have, perhaps, laboured the point somewhat, but it needs it in order to make my reasoning clear.

Then, again, what about the old skeps? Are

they free from disease? Are they, too, destroyed as a matter of true or any other kind of economy? We know that they are not, until patched a dozen times and creaking with years, they at last collapse or fail in holding together. Who is to certify such as healthy? I say it is not possible, and, where disease exists, one skeppist is a menace to the whole countryside, for nothing can prevent the spread of disease by the robbing of his infected skeps.

It may be conceded that the increased traffic in bees and hives may be responsible for some spread of foul brood, but this was not the point raised, nor is it an inherent defect of the frame-hive.

It is well, in any case, to be aware of possible danger from this or any other source, that it may be avoided, and it behoves the users of frame-hives to look to it that there shall be no reproach attached to them on the ground of carelessness in this matter.

Even if it be true that disease has spread, that is no argument for a return to old and obsolete methods, but rather for renewed strenuous effort to combat it under conditions apparently more favourable to its growth. Certain it is that these very conditions are also those which conduce to its easy detection, and therefore, if there be a remedy at all, to its final extirpation. And if there be virtue in this matter of annual destruction of brood combs, apply the same principle and obtain the same results! The frame-hive is at least at no disadvantage in this respect.

It will not do good to argue the point *ad absurdum*; there are usually two sides to a question, and whilst something may be said for the old methods, under modern conditions there is no excuse for the spread of the disease.

Nothing but the falsest economy of unadulterated selfishness, which, alas! exists even amongst bee-keepers, is responsible for the continued state of things which we deplore. For ignorance there is little excuse, except that we ourselves have not done so much as might be to dispel it.

Up and doing, then! Let each tactful bee-keeper take a personal interest in the bees of his uninformed skeppist neighbour, even to the providing him with a few new skeps, and let those devoid of tact obtain it of the changers, or refrain from meddling at all in the matter.

Brethren, do not lose heart; by patient search the needle may be found in the hay, and the continued onslaught upon the enemy must finally drive it from our shores.

Granted that we have no law to help us, and that without it erosion of the rock of ignorance is a slow process, and drastic methods impossible, yet let us not cease from work; but, whilst looking to it that we ourselves are free, attack persistently around us, that we may with the final blow kill not only

the old methods, but the old devil of disease.—  
L. S. CRAWSHAW, *Ilkley*.

## Queries and Replies.

[3131.] *Spring Management for Beginners.*

—I am a beginner in bee-keeping, having purchased my first stock in the spring of 1902. I lost a great many bees in transit owing to insecure packing, for they found a way out on the journey, and were lost. In the end, however, I built them up into a strong stock, and put a rack of sections on last year; but, probably owing to the bad season, the result of my first season was *nil* so far as regards surplus. A large amount of honey was stored in the brood chamber, the whole thirteen frames being well filled with sealed stores. The stock wintered well, and when examined at end of March last I found ample stores, one frame untouched, and most of the others from a third to a half full. I began to feed them on April 4, and a month afterwards the hive was very full of bees, and plenty of capped brood. So I put a rack of sections on fitted with full sheets of foundation. This was nearly a month ago, and the bees have been working furiously ever since, but when I examined the sections on May 30 I could see no signs of the combs being drawn out. I therefore looked in brood nest below, and found the frames being rapidly filled with honey and sealed over. The questions are:—1. Is it usual for the bees to fill the frames of their brood nest, however large, before commencing to store honey in sections? 2. Is it advisable to remove two or three of the partly-filled frames, and contract by the dummy-board, and so allow less space for storage in brood chamber, and thus force the bees into sections? I want some surplus honey this year, and would not mind the expense and trouble of feeding in the autumn, if necessary. 3. Do you think thirteen frames too many for brood chamber of an average stock, and would you recommend reducing to the usual ten frames? It is a home-made hive, hence probably the thirteen frames. I have just made another hive to hold ten frames from instructions given a few weeks ago in the B.B.J. Would you suggest transferring from the old hive to the new, and doing away with the oldest and most crooked frames? Regretting my lengthened queries, and thanking you in anticipation.—WALTER LAINCHBURY, *Northants*.

REPLY.—1. In a well-managed hive there should be, at this season, no more frames of comb in the brood-nest than allows full room for the exercise of the queen's laying powers, along with the two outside combs for food supplies, and even these latter should be occupied with brood in a week or two. There will, of course, always be more or less (the

less the better) of food in the upper portions of the brood-combs, but if you allow thirteen frames for brood, and five or six are so occupied, it need cause no surprise if the bees use the surplus combs for storage and refuse to enter sections. 2. We should reduce the number of combs in brood-chamber to nine or ten, according to the cell-room available for brood, taking away frames of sealed combs as proposed. 3. Our preference is for a ten-frame brood-chamber, unless in case of very prolific queens. The ten frames must, however, be all available for brood, not occupied by either surplus stores or over-abundance of pollen. 4. By all means do this, and get rid of faulty combs.

[3132.] *Formaldehyde and Foul Brood Spores.*—I was very much interested in the article on p. 226 of B.B.J. of June 4 on formaldehyde for disinfecting combs and hives. Will some of our readers who have a knowledge of chemistry please say:—1. What is formaldehyde, and how obtained? 2. Is it a poison? 3. What is its price? 4. Where can it be purchased pure?—OLD CAMBS BEE-KEEPER.

For reply see Leader on page 241.

[3133.] *Loss of Swarm after Cutting out Queen-cells.*—As a constant reader of the B.B.J., may I ask your kind advice in the following circumstances? Expecting to be away from home on June 1 (Whit Monday), I examined my three hives in the morning, and removed queen-cells from the only one of the three containing any. Notwithstanding this, however, the bees swarmed about mid-day, and, as I was away, the swarm was lost. I was most careful in my examination of the hives, but suppose I overlooked some cells. Upon examining same hive on Friday, June 5, I found three or four queen-cells, one of which I left, this being capped over and apparently all right. On Monday, June 8, I again opened the hive to give a frame of brood (taken from an overcrowded hive), and found the cell left quite intact. There were also several newly formed ones. 1. Can you suggest why there is so much queen-rearing going on? 2. I also gave the rack of sections which I had removed at time of swarming. Did I do right? An early reply will oblige.—S. H. HOLDAWAY, *Wroxall*.

REPLY.—1. It was unwise to cut away queen-cells four days after the loss of top swarm. Had all the cells been left intact till the second swarm issued nine or ten days later, all cells might have been removed and the swarm returned the same evening, when matters would have gone on all right. As it is, the single cell left may have proved abortive, as seems probable in view of further queens being raised as stated. By the time these lines are in print it will be known how the queen-cells have resulted, so you had better examine the stock and let us know

result, when we will advise further. 2. No harm was done in returning the sections, but it is not too probable that they will be filled after the set-back the stock has had.

[3134.] *A Beginner's Queries.*—I am a beginner and take much interest in your valuable journal. I bought a stock last July, and, although in a very exposed place, have had no trouble whatever with them. I took two frames of honey last autumn, and the bees have wintered well on eight frames. I have not fed them at all, and they are now very strong. On Monday, May 25, I put in the other two frames fitted with full sheets of foundation, and all was going on well until this morning, when I found about twenty dead and dying bees in front of hive thrown out. I am sending you some of the bees, and shall be glad to know (1) why they are cast out. They are larger than any I have seen before. I might say on Friday it was so hot I took off two bags which I had used for quilts. I still left two on; but next night was very cold and a sharp frost here. 2. So I ask, did I remove quilts too soon, and should I replace them?—F. LASIBROOK, *Hants*.

REPLY.—1. The dead bees sent are young drones cast out owing to the few days of cold weather that occurred about the time. 2. No harm will follow removal of quilts in the present warm weather.

[3135.] *Dealing with Diseased Stocks in June.*—Do you advise any intermediate mode of treatment, at this time of year, in dealing with a diseased stock, supposing there are a large number of bees, but where foul brood is apparent in several combs? If so, kindly state briefly what you advise.—C. J. G. G., *Wills, June 10*.

REPLY.—June is a favourable month for utilising strong colonies of bees—found affected with foul brood—by getting the bees off comb, and dealing with them as an artificial swarm, according to directions on page 148 of "Guide Book." On the other hand, if the bees are working in sections, they may be allowed to remain in the hive till close of the honey season, as advised in reply to "T. W., Kent," on page 237 last week.

[3136.] *Dealing with Foul Brood.*—I am enclosing three samples of suspected foul brood for your examination. Having no previous experience of the disease, I am anxious as to result. Particulars are as follows:—The stock from which sample No. 1 is taken I found fairly strong in bees, with a good active queen, and a quantity of brood in all stages. The owner is a working man, willing to have stock destroyed if necessary. Sample No. 2 is from one of two stocks where the bees have died out, leaving a quantity of honey and capped brood in combs. In this way they die off nearly every year. Sample No. 3 is from a hive which has been dealt with in accordance with the directions in "Guide Book," viz., all

bees brushed off combs into clean skep to be retained forty-eight hours without food. Hive, quilts, frames, honey, and brood destroyed by fire. New hive is prepared, fitted with full sheets of foundation, as a new home, and I intend feeding according to instructions. I send name, &c., while signing myself—C. J., *Weston-super-Mare, June 9.*

REPLY.—We are glad to learn that the owner of hive from which sample No. 1 was cut is willing to have the stock destroyed if diseased. It is a bad case of foul brood, and, as you already possess a copy of "Guide Book," we need only refer you to page 148 for full instructions with regard to treatment. Sample No. 2 is typical of a badly diseased comb, though all dead larvæ in the capped cells have dried up and disappeared. So long as combs like sample are kept hanging about where flying bees can get at them, so long will foul brood be rampant in the place. We should burn the lot, and be rid of it. No. 3 is also a bad case of foul brood, and you have dealt rightly with it.

[3137.] *Immature Queens Cast Out after Swarming.*—1. Can you tell me what the enclosed pupæ are? I found them to-day just outside a hive which swarmed nine days ago, on June 1. In order to prevent the issue of second swarm I cut out, as far as I could see, all but two queen-cells, one of them much larger than the others. My sister (I was unfortunately away for a day or two) tells me she saw a queen just coming out of the larger cell on Saturday, June 6. 2. I should also be glad to know if you think any of the enclosed larvæ are queen-nymphs, and, if so, is the fact that they have been thrown out of the hive a sign that the queen hatched on June 6 is already mated? This seems hardly likely, as to-day is only the fourth day from date of hatching, and we have had almost incessant rain. One appears to be only a worker-larva, judging by its size. 3. Can you suggest why it has been turned out? I did not see any others about. I have been feeding the stock ever since the swarm issued, so they cannot be wanting food. I am sorry to trouble you about what may seem a small matter, but I am only a beginner, and that of June 1 was my first swarm.—E. K. H., *Brondesbury Park, N.W., June 10.*

REPLY.—1. One of the pupæ is an embryo queen, which had probably been cast out of cell a few days before the 9th inst., the soft parts of the abdomen being already eaten away by some insects when picked up. The casting out of undeveloped queens after swarming need cause no alarm, as it simply indicates that a young queen has been hatched and heads the colony. 2. The pupæ cast out have nothing to do with mating. It may be from a week to twelve days or more before fertilisation takes place in the present uncertain weather. 3. The chance worker-larva cast out means nothing in particular.

## Bee Shows to Come.

*A nominal charge of 2s. 6d. is made for notices in this column, which covers cost of insertion from order till date of show. Cash should accompany orders for insertion.*

**June 23 to 27, at London.**—"Royal" Agricultural Society's Show. Bee and Honey Section under the management of the B.B.K.A. Increased prizes for B.K.A. Associations as arranged in divisions or groups of counties. **Entries closed.**

**July 15 and 16 at Lichfield.**—Annual Bee and Honey Show of the Staffs B.K.A. Open Classes for Comb and Extracted Honey and Appliances. Schedules from Rev. G. C. Bruton, Great Haywood, Stafford. **Entries close June 20.**

**July 16 and 17, at Lincoln.** Honey, Hives, and Bee Appliances, in connection with the annual show of the Lincolnshire Agricultural Society. Bee department under the management of the Lincs B.K.A. £28 in prizes. Schedules from R. Godson, Hon. Sec. L.B.K.A., Tothill, Alford. **Entries closed.**

**July 22, at Broughton, Hants.**—Fruit, Flower, Vegetable, and Honey Show. Twentieth year. Liberal prizes, with silver cup, valued £15, open to the United Kingdom. Particulars from Fred. J. Hinwood, Broughton, Stockbridge, Hants. **Entries close July 18.**

**July 22 and 23, at Cardiff.**—Honey show of the Glamorgan B.K.A., in connection with the Cardiff and County Horticultural Society. Bees, hives, honey, trophies, wax, appliances, and articles of food. Substantial money prizes and medals. Free entries. Six open classes. Schedules from William Richards, Gabalfa, Cardiff. **Entries close July 16.**

**July 29, at Wallop, Hants.**—Honey Show of the Broughton and Wallop Branch of the Hants and Isle of Wight Bee-keepers' Association. Two open classes for single-section and 1-lb. jar respectively (entry free). Schedules from Miss Tucker, The Lindens, Broughton, Stockbridge, Hants. **Entries close July 22.**

**July 29, at Henbury, near Bristol.** Annual Show of the Henbury District Bee-keepers' Association in connection with the Horticultural Society's Exhibition. Several open classes with good prizes (two classes with free entry). Schedules from I. Atkin Waller, hon. sec., Pen Park, Westbury-on-Trym, near Bristol. **Entries close July 24.**

**July 30, 31, and August 1 and 3, at Old Trafford, Manchester.**—Annual Show of the Royal Lancashire Agricultural Society. Liberal money-prizes are offered for honey along with silver and bronze medals of the B.B.K.A. and also of the Society. Open classes for Honey-Trophy, Sections, Extracted Honey, Beeswax, Honey-Confectionery, Bee Flowers, Instructive Exhibits in Bee-Culture, &c. Schedules from Edward Bohane, Secretary, Miller-arcade, Preston. **Entries close June 30.**

**August 3 (Bank Holiday) in the Walled Meadow, Andover.**—Honey Show in connection with the Andover and District Horticultural Society. Class for single 1-lb. jar of extracted honey (with no entry fee). Also classes for sections, extracted honey (light and dark), and beeswax. Schedules from the Hon. Sec., Dr. Gillett, Elvin House, Andover. **Entries close July 28.**

**August 4, at Leamington.**—Tenth annual show of the Leamington St. Mary's Horticultural Society. Three open classes for Six 1-lb. Sections, Six 1-lb. Jars "Light," and Six 1-lb. Jars "Dark" Extracted Honey, respectively. Liberal money prizes. Schedules from P. W. Smith, Secretary, 22, Leam-street, Leamington. **Entries close July 30.**

**August 6, at Nantwich.**—Honey department of the Cheshire Agricultural Society's Show under the management of the C.B.K.A. Numerous classes for hives, honey, and wax. Money prizes and medals. Schedules from T. A. Beckett, St. Werburgh's Chambers, Chester. **Entries close July 16.** At double fees July 23.

**August 6, at Kingsthorpe, Northants.**—Honey show of the Northants B.K.A., in connection with the Horticultural Society's Exhibition. Three open classes with special prizes, including one for single 1-lb. jar of honey. (*Entry free.*) Prizes 20s., 10s., 7s. 6d., and 2s. 6d. Schedules from R. Hefford, Hon

Sec., Sunnyside, Kingsthorpe, Northampton. Entries close August 1.

August 12, at Radstock, Bath.—Honey show in connection with the annual show of the Radstock and District Horticultural and Fauciers' Association. Schedules from the Secretary, B. M. Clark, 1, Fox Hills, Radstock, Bath.

August 25, at Cartmel, Lancashire.—Honey show in connection with the Cartmel Agricultural Society. Open classes for sections, extracted honey, and beeswax. Local classes for sections and extracted honey. Schedules from Wm. Cragg, Secretary, Cartmel, via Carnforth.—Entries close August 13.

August 27, at Llangollen.—In connection with the fifth annual Flower Show. Open classes for Six 1-lb. Sections, Six 1-lb. Bottles Extracted Honey, and Beeswax. Schedules from Frank Little, Castle-street, Llangollen. Entries close August 13.

August 27, at Montgomery, in connection with Montgomery and District Horticultural Show. Open classes for Six 1-lb. Sections and Six 1-lb. Jars Extracted Honey. Prizes in each class 10s., 5s., 2s. 6d. Entrance-fee 1s. each. Schedules from W. J. Jones, Secretary, Montgomery. Entries close August 20.

September 17, 18, and 19.—At Crystal Palace, Surrey, B.K.A. Annual Exhibition of Bees, Honey, Wax, and Appliances, &c. Further particulars and schedules ready shortly from F. B. White, Secretary, Marden House, Reahill, Surrey.

### Notices to Correspondents & Inquirers.

Letters or queries asking for addresses of manufacturers or correspondents, or where appliances can be purchased, or replies giving such information can only be inserted as advertisements. The space devoted to letters, queries, and replies is meant for the general good of bee-keepers, and not for advertisements. We wish our correspondents to bear in mind that, as it is necessary for us to go to press in advance of the date of issue, queries cannot always be replied to in the issue immediately following the receipt of their communications.

ERRATUM—*Making an Observatory Hive.*—In our issue of last week (*vide* third line of reply to query 3130, page 239) for “ $\frac{3}{8}$ ” read “ $\frac{1}{4}$ .”

J. LOADER (Hants).—*Immature Drones Cast Out.*—No alarm need be felt at a few aborted and immature drones being cast out in such weather as you describe. The partly formed wings are due to insufficient warmth while reaching maturity.

(Rev.) C. F. B. (Stratton St. Margaret).—*Queen Bees and Foul Brood.*—Inspection of dead queen affords no help to us in judging with regard to foul brood in the hive from which the insect was taken. At same time we may mention it as a well-known fact that young and vigorous queens are of great service in overcoming the disease, while old and worn-out ones tend in an opposite direction.

C. T. BIRCH (Okehampton).—*Press Cuttings.*—Much obliged for sending above. Many such items reach us from one quarter or another, but most of them are either so silly or absurd to practical bee-keepers that we only print such as are useful.

H. P. B. (Yeovil).—*Experts' Certificates.*—Particulars regarding examination for the

B.B.K.A. certificates may be had from the Secretary, Mr. Edwin H. Young, 12, Hanover-square, London.

W. L. (Kimbolton).—*Bees Storing Surplus below Brood-nests.*—If pressed for storage room they will build and fill combs below, but not nearly so well as overhead, which is the natural and proper position for surplus chambers.

B. A. M. (Easingwold, Yorks).—*Wasps' Nests in Hives.*—The tiny and fragile structure is an embryo wasp's nest in a very early stage of construction. There is already half a dozen larvæ in the few cells of comb already built by the queen or parent wasp. The nest, if undisturbed, would probably have become larger than a full-sized swede turnip if space allowed.

I. S. (Castle Carrock, Carlisle).—*Queen Cast out Dead.*—The dead queen-bee bears the appearance of having been “balled,” and looks as if old and worn out. We can form no idea as to disease in stock unless a sample of brood is sent.

F. J. HINWOOD (Stockbridge).—Referring to the show at Broughton, Hants, on July 18, the value of the silver cup was corrected from £50 to £15 in B.B.J. of May 28, as will be seen in subsequent issues of both papers.

W. T. (Wolverhampton).—*Replacing Damaged Certificates of the B.B.K.A.*—By applying to the Secretary, Mr. E. H. Young, 12, Hanover-square, London, you will learn if certificates gained by experts can be replaced if damaged, on payment, as desired.

### Suspected Combs.

ANXIOUS ONE (Milnthorpe).—Comb sent contains drone-brood only, and is therefore unsuitable for diagnosing the disease. You had better send a small sample of worker-brood, sealed and unsealed, if possible.

ANXIOUS (Midgham).—Some cells in large sample (old comb) contain foul brood in decided form, though not of long standing. The second piece (in which larvæ has nearly reached the pupa stage) shows one cell only where foul brood is traceable, the rest of larvæ being in normal condition and apparently healthy. No. 3 sample (new comb), containing eggs and very small larvæ only, seems all right and free from disease so far.

W. L. (Kimbolton).—Bad case of foul brood. We should burn the stock. If it “has never done any good since purchased last autumn,” as stated, the sooner it is destroyed the better.

“JACK TAR” (Lancs).—We only find chilled brood in sample. No disease in shape of foul brood.

\*\* Some Letters and Queries are unavoidably held over till next week.

## Editorial, Notices, &c.

### BRITISH BEE-KEEPERS' ASSOCIATION

The monthly meeting of the Council was held at 105, Jermyn-street, S.W., on Wednesday, June 17, Mr. T. W. Cowan occupying the chair. There were also present Colonel Walker, Dr. Elliot, Mr. G. H. Morrell, M.P., Messrs. D. W. Bishop-Ackerman, W. Broughton Carr, W. F. Reid, C. N. White, F. B. White, and the Secretary. Apologies for enforced absence were read from Miss Gayton and Mr. W. H. Harris.

The minutes of the previous meeting were read and confirmed.

The following new members were elected, viz : Mr. C. J. Mapey, Cherry Hinton, Cambridge; Mr. Chas. Munckton, West borough, Wimborne, Dorset.

The report of the Finance Committee was presented by the Secretary and duly approved.

It was stated that arrangements had been made for the issue of a new policy of insurance, to be dated July 1, 1903, covering the period from August 1, 1903, to August 1, 1904, and that premiums for risks under such policy would be payable on and after July 1. Proposal forms will be sent out in due course.

The Examiners reported that the results of the recent First-class Examination were not yet known, but they hoped shortly to complete their work and publish the names of those candidates recommended for the Diploma in the B.B.J. This proposal was approved.

In accordance with the recommendations of Examiners of Third-class Candidates in Leicestershire and Cornwall, it was resolved to grant Certificates to Messrs. J. M. Best, S. Clark, J. O. Clemmow, J. Geary, T. Geary, G. J. Levers, F. W. Palmer, J. G. Payne, and J. E. Roper.

On the motion of Mr. C. N. White, seconded by Dr. Elliot, it was resolved to make a grant of £15 towards the prizes for honey at the forthcoming Dairy Show, and to nominate Colonel Walker and Mr. W. Broughton Carr as judges thereat. The schedule was passed subject to approval by the B.D.F. Association.

Nominations were made of examiners to officiate at the "Royal" Show, and in Devonshire, Glamorganshire, Oxfordshire, and Wiltshire.

A draft of a letter intended to be sent to Technical Instruction Committees of County Councils was submitted by Mr. Weston, and ordered to be duplicated and sent to each member of the Council prior to the next meeting, when it will be further considered.

It was resolved to compile a register of expert certificate holders, for issue with the next report.

The next meeting of the Council will take place on Wednesday, July 15.

### ROYAL AGRICULTURAL SOCIETY.

SHOW AT PARK ROYAL, LONDON.

The sixty-fourth annual exhibition of the R.A.S.E. opened auspiciously on Tuesday, the 23rd inst., at the Society's permanent show-yard, Park Royal, London. After the heavy and continuous rainfall of the past week or two the prospects of a successful inauguration of the splendid new show-ground were far from promising. Fortunately, however, the change came just in time, and, save for a few spots where the heavy cart traffic had formed what might easily have proved veritable quagmires, the ground on the opening day was in fair condition; and, favoured with a bright sun and fresh breeze, the rough places were made plain in the fullest sense.

We have just time to give the prize-list in this week's number, and must leave fuller comment on the show till our next issue.

Messrs. T. W. Cowan and Walter F. Reid judged the bee-appliance and miscellaneous classes; those for honey and honey trophies being taken by Messrs. Henry Jonas and P. Scattergood; Mr. W. Broughton Carr acting as steward of the department.

The following were the awards:—

*Class 384.—Collection of Hives and Appliances.*—1st, James Lee & Son, Martineau-road, Highbury, London; 2nd, E. H. Taylor, Welwyn, Herts; 3rd, W. P. Meadows, Syston, Leicestershire.

*Class 385.—Outfit for Beginners in Bee-keeping.*—1st, James Lee & Son; 2nd, E. H. Taylor; h.c., W. P. Meadows.

*Class 386.—Complete Frame-hive for General Use.*—1st, James Lee & Son; 2nd, James Lee & Son; 3rd, W. P. Meadows; h.c., C. L. Greenhill, Graham-road, Wimbledon.

*Class 387.—Inexpensive Frame-Hive for Cottagers' Use.*—1st, James Lee & Son; 2nd, W. P. Meadows; 3rd, E. H. Taylor; h.c., C. L. Greenhill.

*Class 388.—Honey Extractor.*—1st, W. P. Meadows; 2nd, E. H. Taylor; h.c., W. P. Meadows.

*Class 389.—Observatory Hive with Bees and Queen.*—1st, James Lee & Son.

*Class 390.—New Appliance Connected with Bee-keeping.*—1st, James Lee & Son; 2nd, W. P. Meadows.

(Classes 391 to 394 limited to Cornwall, Devon, Somerset, Dorset, and Wilts.)

*Class 391.—Twelve 1-lb. Sections.*—1st, E. C. R. White, Newton Toney, Wilts; 2nd, J. Edwards, Callington, Cornwall.

*Class 392.—Twelve 1-lb. Jars (Light-coloured) Extracted Honey.*—1st, E. C. R. White; 2nd, Chas. Squire, Morteboe, North Devon; 3rd, J. Edwards; h.c., J. Seldon, Umberleigh, Devon.

*Class 393.—Twelve 1-lb. Jars (Medium or Dark) Extracted Honey.*—1st, H. H. Woosnam, Hope, Devon; r., Rev. W. E. Burkitt, Hungerford, Wilts.

Class 394.—*Twelve 1-lb. Jars Granulated Honey.*—1st, P. B. Govett, Tideford, Cornwall; 2nd, J. Coates, Tiverton-on-Avon, Somerset; r., J. Edwards.

(Classes 395 to 398 confined to Berks, Hants, Isle of Wight, Surrey, Sussex, Kent.)

Class 395.—*Twelve 1-lb. Sections.*—1st, W. Woodley, Beedon, Newbury, Berks; 2nd, W. Blakeman, Ovington, Alresford

Class 396.—*Twelve 1-lb. Jars (Light-coloured) Extracted Honey.*—1st, W. Woodley; 2nd, T. Blake, Broughton, Hants.

Class 397.—*None Staged.*

Class 398.—*Twelve 1-lb. Jars Granulated Honey.*—1st, W. Woodley; 2nd, T. Blake.

(Classes 399 to 402 confined to Suffolk, Essex, Bucks, Middlesex, Herts, and Oxon.)

Class 399.—*Twelve 1-lb. Sections.*—1st, Wm. Loveday, Hatfield Heath, Harlow, Essex; 2nd, C. Lodge, High Easter, Essex; 3rd, H. W. Seymour, Henley-on-Thames, Oxon.

Class 400.—*Twelve 1-lb. Jars (Light-coloured) Extracted Honey.*—1st, Wm. Loveday; 2nd, C. Lodge; v.h.c. and r., H. W. Seymour.

Class 401.—*Twelve 1-lb. Jars (Medium or Dark) Extracted Honey.*—1st, H. W. Seymour.

Class 402.—*Twelve 1-lb. Jars Granulated Honey.*—1st, C. Lodge; 2nd, W. Loveday; r. and h.c., H. W. Seymour.

(Classes 403 to 406 confined to Norfolk, Cambs, Hunts, Beds, Leicester, and Northants.)

Class 403.—*Twelve 1-lb. Sections.*—1st, R. Brown, Somersham, Hunts.

Class 404.—*Twelve 1-lb. Jars (Light-coloured) Extracted Honey.*—1st, R. Brown; 2nd, H. M. Turner, Romanhurst, Northleigh, Witney.

Class 405.—*Twelve 1-lb. Jars (Medium or Dark) Extracted Honey.*—1st, R. Brown; 2nd, F. J. Old, Piddington, Northants.

Class 406.—*Twelve 1-lb. Jars Granulated Honey.*—1st, R. Brown.

(Classes 407 to 410 Glos, Mon., Worces., Hereford, Warwickshire, and Salop.)

Class 407.—*Twelve 1-lb. Sections.*—1st, J. Helme, Norton Canon, Hereford; 2nd, G. W. Kirby, St. George, Bristol, Glos; r., E. G. Willan, Hanley Castle, Worces.

Class 408.—*Twelve 1-lb. Jars (Light-coloured) Extracted Honey.*—1st, A. G. Preece, West-cliff, Shrewsbury, Salop; 2nd, P. H. Rawson, Market Drayton, Salop; r., H. Cleaver, Leamington, Warwick.

Class 409.—*Twelve 1-lb. Jars (Medium or Dark) Extracted Honey.*—1st, G. W. Kirby; 2nd, J. Helme.

Class 410.—*Twelve 1-lb. Jars Granulated Honey.*—1st, P. H. Rawson; 2nd, H. Cleaver.

(Classes 411 to 414 confined to Notts, Lincs, Rutland, Cheshire, Derbys., Staffs.)

Class 411.—*Twelve 1-lb. Sections.*—None staged.

Class 412.—*Twelve 1-lb. Jars (Light-coloured) Extracted Honey.*—1st, T. S. Holdsworth, Kirton Lindsey, Lincs; 2nd, A. G. Pugh, Beeston, Notts; 3rd, W. Hatliff, Caistor, Lincs; r., W. Crellin, Barnston, Cheshire.

Class 413.—*Twelve 1-lb. Jars (Dark or Medium coloured) Extracted Honey.*—None staged.

Class 414.—*Twelve 1-lb. Jars Granulated Honey.*—1st, W. Crellin; 2nd, T. S. Holdsworth; r., D. Marshall, Cropwell Butler, Notts.

(Classes 415 to 418 confined to Yorks, Lancs, Northumberland, Durham, Cumberland, Westmoreland, I. of Man.)

Class 415.—*Twelve 1-lb. Sections.*—1st, J. Waddell, Wooler, Northumberland; 2nd, W. Dixon, Beckett-street, Leeds, Yorks.

Class 416.—*Twelve 1-lb. Jars (Light-coloured) Extracted Honey.*—1st, W. Dixon; r., A. S. Dell, Leigh, Lancs.

Class 417.—*Twelve 1-lb. Jars (Medium or Dark) Extracted Honey.*—(No entry.)

Class 418.—*Twelve 1-lb. Jars Granulated Honey.*—(No entry.)

(Classes 419 to 422 confined to Wales.)

Class 419.—*Twelve 1-lb. Sections.*—1st, A. Hamer, Llandilo, S. Wales.

Class 420.—*Twelve 1-lb. Jars (Light-coloured) Extracted Honey.*—1st, Jno. Berry, Llanwrst, N. Wales; 2nd, A. Hamer.

Class 421.—*Twelve 1-lb. Jars (Medium or Dark) Extracted Honey.*—1st, Jno. Berry; 2nd, A. Hamer.

Class 422.—*Twelve 1-lb. Jars Granulated Honey.*—1st, Jno. Berry; 2nd, A. Hamer.

(Classes 423 to 426 confined to Scotland and Ireland).—(None staged.)

#### OPEN CLASSES.

Class 427.—*Honey Trophy. (Attractive display in any form.)*—1st, W. Woodley; 2nd, R. Brown; 3rd, R. Baldwin, Manor Park, Aylesbury.

Class 428.—*Beeswax (not less than 3 lb.)*—1st, Jno. Berry; 2nd, H. W. Seymour; 3rd, J. Peakman, Derby; r. and h.c., J. Edwards.

Class 429.—*Beeswax (not less than 3 lb. Quality, cakes, and package suitable for the retail trade.)*—1st, E. C. R. White; 2nd, Jno. Berry; 3rd, J. Pearman; r. and h.c., H. W. Seymour.

Class 430.—*Honey Vinegar (Half Gallon).*—1st, H. W. Seymour; 2nd, G. W. Kirby; c., J. Gray, Long Eaton, Derbyshire.

Class 431.—*Mead (Half Gallon).*—1st, H. W. Seymour; 2nd, E. Walker, Maybury, Woking; 3rd, J. Pearman; r. and h.c., G. M. Tune, Llangollen, N. Wales.

Class 432.—*Interesting or Practical Exhibits connected with Bee-culture.*—1st, J. Gray.

Class 433.—*Exhibit of a Scientific Nature not mentioned in foregoing Classes.*—1st, F. W. L. Sladen, Ripple Court, Dover.



## Obituary.

### DEATH OF MR. WILLIAM CARR.

We sincerely regret to announce the death of another veteran bee-keeper in the passing away at a ripe old age of Mr. William Carr, late of Newton Heath, near Manchester, who died at his residence, Moorland House, Leek, Staffordshire, on April 30. Though probably unknown even by name to the present generation of BEE JOURNAL readers, Mr. Carr was one of the pioneers who, in the early seventies, laboured hard in promoting the best interests of the bee industry.

When this journal was started thirty years ago he was for several years a frequent contributor to its pages, beginning with the first issue in May, 1873, wherein an article of his on "Profitable Bee-keeping" appears.

He was also one of the original members of the British Bee-keepers' Association, and when Mr. C. N. Abbott, then Editor of this Journal, undertook, on behalf of the B.B.K.A., a mission to Ireland for the purpose of giving lectures and demonstrations in the modern methods of handling and managing bees, Mr. Carr was deputed to accompany him, and by their joint efforts in various districts much good was done in developing the industry in the Green Isle.

Owing to the fact of Mr. Carr living in the North in days when a journey to London was of more account than in these times, he was not very often in town, but he frequently acted as judge at bee and honey shows in the North. He was, however, appointed one of the judges at the "Royal" show held at Kilburn, London, in 1879. His name also appeared in the list of judges at the early shows of the B.B.K.A., held at the Crystal Palace and at the Royal Horticultural Society's Gardens in London. Mr. Carr was for some years a familiar figure at such of the "Royal" shows as were held in the North of England. He was also a member of the Lancashire B.K.A. from its institution in 1882 up to the time of his death, and to the last, as we are given to understand, his interest in and love for the honey bee never abated, but continued to the end of his long life.

It is not generally known that Mr. Carr was one of the first to import the Ligurian or Italian bee into England, and he was successful in distributing many queens of that variety in this country.

We are indebted to Miss R. E. Carr-Smith, niece of Mr. Carr, for particulars of his death, which occurred quite suddenly and unexpectedly from heart failure, on the morning of April 30, while sitting in his armchair in the dining-room at Moorland House. Miss Carr-Smith will be remembered as being for some Hon. Secretary of the Berks B.K.A. when she resided in that county. In giving some further details the lady adds:—"From his earliest days my uncle was a true and enthusiastic bee-

keeper; an example of untiring industry in the study of bees and all connected therewith; and when any one sought his advice—as many did—with regard to increasing a scant income, or improving their health and happiness, he invariably said 'keep bees!' as he himself did with both pleasure and profit. And to the end of a successful and happy life, even in his eightieth year, he was a member of two bee associations, and a constant reader of your journals."

### "SHOOK" OR "FORCED" SWARMS.

The question to which American bee-keepers apply such varying terms as "shook," "forced," and "brushed" swarms is still to the fore in Bee Journals across the Atlantic, where the idea of improving on what are known as natural swarming apparently continues to be regarded by American apiarists as something "new" in bee-management. We ourselves briefly referred to this matter on page 38 of B.B.J. for January 22 in a few prefatory words, when reprinting a lengthy article from *Gleanings* on the subject of "shook" swarms. Our remarks at the time merely referred to the similarity of the plan detailed in the pages of our contemporary as being analogous to the method long practised in this country, and known as "artificial swarming," without definitely comparing the respective items of procedure. A recent inquiry for more light on the question of "shook" or "forced" swarms makes it clear that an impression still exists among our readers that the American plan is different from ours, and that something may be learned from it.

In answer to the above, we might refer our querist to the article from *Gleanings* printed six months ago, but for preference we avail ourselves of a recent issue of the *American Bee Journal*, wherein appears an article by Mr. Chas. W. Cilley headed "An Experiment with Forced Swarming," in which the writer says:—

"I saw in the last *Journal* some questions in regard to forced swarms, and as I have had some experience in that kind of management of bees, perhaps I can write something that will help some one.

Now, I have used this plan of forced swarms for the past four years in my own apiary, and have not had a natural swarm during that time. I have also done lots of that kind of work for other people during the past year, and it has been very satisfactory to all of them, so I think it is pretty good proof that the plan of forced swarming is all right.

I also tested the plan by putting a forced swarm by the side of a natural swarm that came out the same day the forced swarm was made, to see if there would be a difference in them in the fall, but I do not believe the best bee-keeper in the world could have told the natural from the forced swarm October 1. It

is a great saving of time and trouble where one has to be away from home a good deal, or has an out-apiary to look after. There are a number of ways to make forced swarms, but I will give the way that suits me best, and any one can use it with safety.

I usually make the forced swarms about the last week in May or the first week in June, but you cannot always go by the time of the year to divide them, but when they are strong enough in bees, or when they are about to swarm naturally, take a hive that has starters an inch or more wide in all the frames, with no supers on, and place it near the hive from which you want the forced swarm to be taken, then remove the old hive and set it back a few feet out of the way, and place the new hive on the old stand. It should be done in middle of the day, when the old bees are working in the field, then they will return to the new hive on the old stand, and you will not have to shake or brush them from the combs.

Then go to the old hive, and blow in a few puffs of smoke at the bottom; raise the cover after a few minutes, and blow a little smoke under to drive the bees out of the way; then lift out the frames carefully until you find the frame the queen is on. Carry this frame, bees and all, to the new hive, lift the cover, and put the frame in the centre of the hive; put on the cover, and you have forced the swarm with most of the old bees and the old queen, the same as a natural swarm, and also one frame of comb and brood, and most likely some empty cells for the queen, so she can keep right on laying.

Now quite a lot of old bees are still in the old hive, and will return to the new hive on the old stand the first time they fly, or most of them will, so you will see the forced swarm will be about the same as a natural one.

Now you can place the parent hive anywhere you please, and the colony will probably not swarm that year, because so few of the old bees will be left that they will not get strong enough until the swarming season is over.

The advantage of this plan of forced swarms is in having only two good swarms, where you would get two or three, or perhaps more, if you let them swarm naturally.

Now I think I hear some one say 'What will the colony in the old hive do, as they have no queen?' If you do not divide them until they have some cells started they will soon have a queen from one of them, but if you divide them before they have cells started (queen-cells I mean), then they will rear a queen from some of the small brood, or perhaps from eggs.

Now some will say 'I do not like queens reared that way.' But I have seen as good queens reared that way as any I ever had. I have one now that will be four years old next spring if she lives, and did fine work the past season. But queens can be reared so as to

have them ready when you wish to make your forced swarms, and you can introduce one of them in the old hive if that suits better. I have never had a forced swarm leave or desert their hive."

Mr. Cilley, in the above "Experiment," defines a plan of forced swarming so parallel to what has long been practised in this country, and known to readers of Cowan's "Guide Book" ever since its first edition appeared over twenty years ago, that, with the view of making the point clear, we reprint below the brief paragraph which contains the gist of Mr. Cilley's plan in a few lines. It occurs in the chapter on "Artificial Swarming" where, after a few words of caution as to season and the conditions essential before operations are safe. We read as follows on page 94:—

*To Make Two Colonies from One.*—Take a comb of brood and bees on which the queen is found and place it into a hive, filling up the latter with empty combs or comb-foundation. Then place it on the stand where the stock stood, removing this to a new location. Cover up the hive, and all bees on the wing will return to the old stand, join the queen, and form the swarm. The old stock should have the frames brought close together, and an empty comb inserted at the side of the hive in place of the one taken out. This hive may have a laying queen introduced, or a ripe queen-cell may be given it on the second day after the operation.

## Correspondence.

*The Editors do not hold themselves responsible for the opinions expressed by correspondents. No notice will be taken of anonymous communications, and correspondents are requested to write on one side of the paper only and give their real names and addresses, not necessarily for publication, but as a guarantee of good faith. Illustrations should be drawn on separate pieces of paper. We do not undertake to return rejected communications.*

### NOTES BY THE WAY.

[5147.] Having got past the longest day we may well ask "What of the outlook?" From the bee-keeper's point of view the outlook is meagre. The season is so far advanced in the southern part of the kingdom that come what may in the shape of good bee-weather the results for the year must be very much below the average. The past week has been on a par with the previous one—wet for the greater part of the time, and, when not raining, dull and cold. It seems strange to have to inscribe on the hive records such entries as "June 18, gave syrup," "June 20, ditto," yet such is the fact. I have been giving many stocks a 1-lb. bottle of syrup every second day to keep them going, but even this has not prevented the casting-out of drone-brood, which, in what ought to be the height of the season, presages against the supply of drones next month for queen breeding. Our wisecracks say "now the longest day is passed we shall

get better weather ;" that "the wind will now change from the east and north-east." I trust they may be right, and then we bee-keepers will soon put on our smiles, and see a revival of hopes so often frustrated and damped by adverse weather. Indeed, the hope of better fortune is already in the ascendant, and we seem in a fair way of seeing a better state of things. The 21st was a great improvement on the 20th, the sun shining out brightly, and the bees worked well till late in the afternoon ; it was, in fact, the best day we had here since the 1st of the month.

The great advance of the "Weed" foundation on the old style of dipping the sheets of wax before being pressed into foundation, is shown principally by the few complaints from users. We seldom now hear the cry that "the bees would not work it out into combs." Nor do we hear of any objections to the combs of which "weed" foundation forms the mid-rib. Surely these are points of great importance to both the producer and the consumer of comb-honey. I am exceedingly well pleased with the grand parcel of extra thin super foundation received from the British "Weed" factory at Holme, in return for my year's parcel of wax—it was simply perfect.

As some of my customers in the North have written asking me how to get sections well filled, I may say we have our wax sheets cut so that they are fixed at the top of section only by pressure roller. Those who prefer the split-top sections can, however, fix theirs in the split, and allow the foundation to touch the wood on each side of the sections. Our racks are the ordinary size to take twenty-one sections, and we use the ordinary tin or zinc dividers, slotted or plain pattern. These simple methods, with strong stocks of English bees, and with the hives standing perfectly level, comprise all our "secrets" and all our stock-in-trade for turning out the usually well-filled sections so much admired by customers. Of course, we require good honey-flows and continued warmth to get first-class sections.

In working with bees I use the carbolised cloth in putting supers on or taking them off, and consider it far preferable to the smoker, though I always have the smoker ready for any emergency. The carbolised cloth is simply a square piece of calico, on which is sprinkled a few drops of Calvert's No. 5 Carbolic Acid, not diluted, but just dropped from the bottle to cover the square as far as possible ; then roll it up tightly, and in a few minutes it will be ready for use. As the quilts are removed, allow the carbolised cloth to fall on the frames, and the bees rush down out of the way. The hive can be examined at once, or the rack put on—it is a great saving in bee-life ; no crushed bees, and, with adroit promptness in work, very few stings, compared to the older system of smoking the bees. The work of supering is thus done so quickly that the bees lose very little time in their work.—W. WOODLEY, *Beeton, Newbury.*

## BEEES AND WAX-MOTH.

[5148.] I beg to thank you very much for your prompt and full report on piece of "suspected comb" forwarded to you on June 1 and reported on page 230 of June 4 issue. The hive from which the sample was taken unfortunately did not get the attention I had intended giving it. When having my first look into hive at end of March, I found holes in the chaff-cushion, through which the contents were escaping, so I removed it, intending to replace it with a new one ; but somehow this was not done, and I think brood must have got chilled in consequence. Respecting the wax-moth you mention, I found two grubs on top-bar, and three more on floor of hive. Would these cause so much brood to die ? My other stocks thirty-five in number, all came safely through winter, with the exception of the one alluded to and two which superseded queen in May, and have now had young queens laying for more than a week, so they are ready for the honey-flow. With fine weather, they would most likely soon give a good account of themselves. My first swarm of 1903 issued Sunday, May 31. The stock had built out comb in sections, and stored a little honey therein ; since then, however, there have only been a few days on which honey in any quantity was gathered, and work is at a standstill as I write. Referring to insurance, I may possibly increase my number of hives to fifty. Can I have the policy altered to cover risk on this number when renewing, by paying the additional cash ?—VERONICA, *Kingsbridge, June 14.*

[When the real wax-moth (*Galleria cereana*), the larva, or grub, of which was sent, gets possession of a stock the bees are frequently overcome by its ravages, and perish outright. Inquiries connected with insurance policies must be addressed to Mr. E. H. Young, Sec. B.B.K.A., 12, Hanover-square, London.—Eds.]

## THE WEATHER : A GRUMBLE.

[5149.] It is a matter of common opinion that the weather is the topic to which one instinctively turns when at a loss for conversation, and it is, no doubt, due to this fact that the weather as a topic bears an unenviable and not altogether justly-deserved reproach.

It is true that many of our remarks upon the subject are stereotyped to a degree past belief. Our "Nice day" or "Good morning" may be merely expressions of a desire for the best, but have, probably, lost even that amount of significance, and it may be forgiven if one's regard for the subject relegates it easily to the beginnings and endings of small-chat conversation.

Yet it is a subject which cannot be seriously ignored, and is not, to judge merely by the prominent positions accorded to the meteorological reports in our great dailies, and by the

anxiety with which those who have "no faith in sich" scan the evening and morning sky.

To a bee-keeper "weather" is almost everything, and one may therefore be excused for considering it a subject of sufficient importance to warrant its rescue from the ignominious position of stop-gap, and deserving of better treatment than that possibly accorded to imperial Cæsar's clay.

What boots it, if stocks be strong to the point of overflowing, if bees are healthy, if surplus receptacles are ready and in place, if flowers be blooming abundantly and possibly yielding nectar, should the weather be unfavourable and it be impossible for the bees to gather? Sunshine is wanted, not cold, wind, and wet, the blistering trio which seem at present to preside over this year of grace and glorious English summer.

Is there not here a chance for some budding Lubbock to train the future race of bees to an improved trick of their cousins, the umbrella ants, that they may sally forth on forage bent in fitting costume, garbed in the latest of watertoshes, for which garment of leaves a tiny variety of *Ficus elastica* would seem to be the most suitable plant.

But about the weather. What can be said of a midsummer day preceded by a night of frost, four degrees of which were registered in my own valley in a sheltered spot, while there would be a considerably lower temperature upon the hills, where broad splashes of bright young green of the bracken of yesterday are now changed to dull sweeps of dead, brown black?

What does it matter that the day itself follows with a maximum shade temperature of 84 deg.? Little, except to mark the incongruity! I must own to an exceeding pessimism at the moment, which, however, is justified by our circumstances.

The heather is our source of surplus here, and this failed us entirely last year. White clover does not flourish with us, as we are on the millstone grit—a cold, ungenerous soil—and are some distance from the mountain limestone, its nearest natural habitat.

For my own information I have sown some patches of white clover, and, while it blooms, the bees certainly visit it, but perfunctorily, and as though as a matter of duty or on account of its reputation!

Our bees depend upon the hawthorn and sycamore to build up for the later flow, and this year "may-blossom" has been scanty, and the sycamore has not bloomed at all. I have under these circumstances just completed a round of as many bee-keepers as I know, for ten miles each way of the dale, bidding them look to the salvation of their stocks and "feed" to save. I am downhearted after the visits, as I did the same thing after the failure of the crop last autumn, only to find now that in most of the cases my warnings have been neglected, and that the bulk of the stocks are dead. Now, too late, the owners are willing to attend to the remainder.

Who would not be pessimistic? It is a safe position, far safer than to sit upon the fence—which may be wearing barbed wire for aught one knows—for if matters turn out well we benefit alike, but if not, well not, and "I told you so" an unfailing refuge!

So "Here's to the pessimist," and we will drink it not on the thorny fence, but under the hedge, sheltered alike from the heat and the storm.

I had some chat the other day with a neighbouring bee-keeper of long experience, and he told me that this particular district used to be a good one, when much farming was carried on here, and limestone from the Skipton district used to be brought down and burnt locally.

With the regular top-dressing of lime, the white clover flourished, but now it has departed as the land has gone out of cultivation, a part of the price we bee-keepers pay for the so-called cheap imported grain. But I must not let this fit of pessimism drive me to drink of politics, or I shall soon have the editorial bee in my bonnet, buzzing about my unprotected head!

Back to that safest of topics, the weather and the bees. My own bees are in really good condition, several of the hives are crowded out, thanks to timely attention, and I am therefore, in the absence of other work for them to do and to keep "Satan" at bay, occupying their energies by continually extending the brood-nests, obtaining thus some well-built new combs as the bases of some coming nuclei.

To come "back to our mutton" the weather, it is unlikely, in spite of all our criticism, that any of us could manage our own or any other weather to our entire satisfaction, not to mention that of our neighbours, and it is worse than useless to grumble at what one cannot remedy. Still, it lets off steam, and we feel in some sense responsible for the next fine day!

We are, perhaps, too much expectant of a full supply of the best every time, but we should strenuously object to an assessment of, say, income-tax upon this principle. It is possible that, by the time these lines are in print, we may be revelling in summer weather, for, if it be that these cold northerlies are due to a heated upward current further south, it must be very hot there, and, when the worm—pardon, the wind—does turn, we shall surely be roasted!

So even in this our darkest hour we will allow some little optimistic gleam to pierce our gloom, hoping against hope that even if the year fails us for a heather crop, as it has failed others in the fruit districts, there may be districts where the delayed clover shall yet considerably exceed the somewhat dampened expectations, and take even now the wind out of the sails of that monthly bugbear, the returns of imported honey. Oh! Have you never seen the sails of a bugbear?

After all, it is easy to complain, whilst year after year, seedtime and harvest follow with unflinching regularity, and the bounty of our Father is spread with unstinting hand over other fields as well as our own, and we have not perished of want. Springs are as green and flowers as sweet and fresh, following years of drought or flood, and we cannot fairly estimate the value of our mercies by one short period alone, but must in this, as in other cases, consider a succession of years, taking the lean years which follow with the fat years which precede.—L. S. CRAWSHAW, *Ikley-in-Wharfedale, June 21.*

### "OUR FAILURES."

[5150.] I am sure the able article of your correspondent, Colonel Walker, on "Our Failures" (5137, page 231, in BEE JOURNAL of June 11) will prove of considerable help to many young bee-keepers like myself, who like to find out the weak places in our bee-keeping, in order to remedy them where we can. May we hope to hear from him again, on the subject of the advantages and management of the "Combination" hive? I think this hive deserves more advocacy than it gets.—R. F., *Leek, Staffs.*

### BEEES ATTACKING POULTRY.

[5151.] Referring to the request of "T., Bromley" (3115, page 227), I would like to say my chickens run about with impunity among the hives. If bees are properly subdued and quietly handled there is, as you observe, very little likelihood of such an event as is described by your correspondent.—C. GILBERT, *Swindon, Wilts.*

## Queries and Replies.

[3138.] *Undesirable Swarming.*—I am a beginner at bee-keeping, and a constant reader of both your papers, yet I do not remember having seen the treatment necessary in such a case as I have experienced here. The facts are as follows:—I have one strong stock of bees, supered on May 1 to give them necessary room, and to see whether they would secure surplus from fruit and hawthorn blossom. The bees took to the surplus-chambers at once, and in the course of the month of May half filled the super with comb and honey. A second super was placed under the first on June 1, yet notwithstanding this and other precautions, a big swarm issued on Friday the 5th at the end of a spell of three weeks' fine weather. I saw the latter half of the swarm issue and the clustering (to me a novel experience), and noted that there were two separate clusters of bees. One of the clusters broke up and returned to the hive, some of the bees entering freely, and others

reaching about the adjacent ground in battalions. The second cluster followed suit. Whilst watching the re-entry, the queen was seen on the ground with an injured wing—whether clipped or not artificially, I am unable to say. I picked it up, placed it on the alighting board, and in a few minutes the bees were practically all in the hive again. On Friday the 12th, the first possible afternoon, the weather having been cold and wet for a week, the bees swarmed again (in my absence), forming a fine single cluster of immense size, and returned of themselves once more. In this case no trace of the queen was observed. I do not want a swarm, but rather a test honey-crop for the district, and am adopting all possible expedients to prevent swarming, short of opening the hive and cutting out queen cells. What course should I follow? The first fine morning I intend to place a third rack of sections under the two now on. If they persist nevertheless in swarming, can I stop the business as follows:—When the swarm leaves and clusters, place at once a new hive ready fitted with foundation in the place of the old one, removing old one a distance of 2 yds. Open the old one, take off supers and excluder, find the queen (easier to do in the absence of so many bees), place her with comb on which she is found in the new hive and await return of bees. If bees return as usual, put on the super and treat as a swarm? The bees in question wintered splendidly. I saw two drones leave the hive on March 15. The spring cleaning took place on April 8, when I found brood on five or six combs, and two small batches of sealed drone-comb at the bottom of two of them. The only trouble observed was a little mould at the back corners, and black mildewed pollen in some of the central combs. The bees are, I believe, the strongest colony in the parish. I may add the white clover is in blossom now, and will be abundant in a week or so. I have no difficulty in manipulation operations. The bees are quiet; but queen finding in a strong hive is, I fear, beyond me at present.—A. H. T., *Penarth, June 14.*

REPLY.—The above query being in type and intended for last week's issue, but unavoidably held over, we insert below a supplementary query, since received, and reply to both at foot.

[3139.] *Swarming Vagaries.*—I see by this week's *B. B. J.* that my query dated 14th arrived too late for reply at once. Meantime, I took local advice and was preparing to carry it out when the bees solved the difficulty themselves, and in a way as to show that local opinion would have, if followed, made confusion worse confounded.

I will, therefore, simply give the result of my subsequent observations.

Sunday and Monday were unfavourable days. Bees were restless on Tuesday (16th), and I watched till 3 p.m., expecting they

might try to swarm a third time. My wife found them out strong at 4 p.m. with many drones on the wing; but they were driven in by a sudden rainstorm.

In the evening I made preparations for overhauling the hive on the morrow, hoping to find the crippled queen, but on going to the hive I found the old queen (enclosed for inspection) on the alighting-board dead!

I was told, on consulting a good local bee-man, that "the swarming trouble was now over" and that I might with confidence leave the bees alone, "as a new queen would have to be raised," and so on.

Not being quite satisfied, however, I stayed at home next morning (the 17th), and while watching the hive the bees swarmed at 11 o'clock (a very big lot) and clustered nicely. I hived them in a skep where they remained till 5.30 p.m., when I ran them into a frame-hive as directed in "Guide Book," and looked out for the queen. The last handful of bees got separated from the main body and seemed disinclined to move forward. I noted a young active queen trying to hide itself amongst them, but when helped along with a feather it entered the hive. To my astonishment, however, I found a dying queen left behind with half-a-dozen bees. This I removed and send forward for your examination. There are on the latter distinct yellow streaks on the abdomen—as will be seen—none of which are on the parent queen. I therefore now ask:—

1. Is it not unusual for two virgin queens to go off with a swarm? 2. Is it usual for bees (queen hybrid) to vary much in markings as the two specimens sent? On Thursday (the 18th) I picked up a living—and again differently marked, queen cast out from the parent hive, and later on heard a "piping" sound inside the hive. The bees had practically left the supers, so I removed the top one and took out twelve completed sections and three or four partly finished. The lower rack had scarcely been touched, and as the bees are still very strong in numbers, I left it on. 3. Is there still a risk of a second swarm coming off? Moreover, I presume the two hives will have virgin queens, and that there is a risk of losing them altogether. 4. Is this not so? I intend to examine the swarm for eggs, &c., seven days hence, if the weather be suitable. 5. When had I better examine the old stock? I may be allowed in conclusion to say that for beginners like myself, your correspondence columns are a source of the greatest interest.—A. H. T., *Penarth, June 19.*

REPLY.—It is needful to have the original query before us, along with the sequel, in order to arrive at a fairly safe conclusion with regard to the above case. As we understand the matter, the cause of the swarm—which issued on June 1—returning to the parent hive was the inability of the old queen to fly, owing to a maimed or "clipped" wing. The continued adverse weather which followed would seem to have caused the bees to destroy

the queen-cells already formed on the 1st inst. Any way, the old queen failed to issue along with the bees when swarming again on the 12th, and then—after more cold days—followed a case of matricide on the return of another spell of swarming weather. The fact of "piping" being heard on the 18th makes it certain that the first set of queen-cells were destroyed, and a second set formed subsequent to the swarm of June 1. For the rest, and in answer to the questions enumerated, we reply:—1. It is not at all uncommon for two or more virgin queens to accompany the bees when swarming has been deferred from loss of the old queen, through accident or otherwise, at first attempt to swarm. 2. The variation in your case shows that the parent queen has been crossed by a hybrid drone, and the resultant progeny show yellow markings more or less distinct. We found a slight band of yellow in both specimens sent. 3. The fact of several dead queens having been cast out makes it certain that the stock will swarm no more this year, notwithstanding the "piping" heard on the 18th. 4. Yes, but the risk of both queens failing to mate is very small. 5. It is always advisable to make sure that young queens are safely mated.

[3140.] *Feeding Swarms after Hiving—Getting Rid of Ants.*—I am a beginner at bee-keeping, with no experience to fall back upon, so I shall be glad if you will kindly answer me two questions. I hived my first swarm on June 6, and they appear to be a fine, healthy lot. I opened the hive four days later and contracted it to seven frames, adding three more quilts. The bees had covered five frames and partly covered the other two. I put on a bottle of medicated syrup (naphthol beta), which I regularly replenish as soon as emptied. The bees are taking this down at the rate of about half a pint per day. Since they were hived we have had only four or five fine days, and on these it has been so cold, and the flowers are in such a bedraggled and muddy condition, that I am afraid there has been no honey-gathering done. It has rained in torrents most days, and I want to ask:—1. If, under these conditions, I am feeding properly? 2. I do not understand what is meant by "stimulative feeding." Perhaps you will kindly explain. 3. On the 12th inst. I found the quilts and part of the inside of the hive literally black with ants, so I have sprinkled the quilts and affected parts with powdered naphthaline, and have painted the hive-legs with crude carbolic acid (undiluted). Will it affect the bees in any way?—HARRY BURGESS, *Croydon, June 19.*

REPLY.—1. Yes, quite properly, but after thirteen days since swarm was hived feeding may be stopped directly the weather improves. 2. Stimulative feeding means supplying the bees with food slowly and regularly, at a time when natural food is unobtainable, in order to

stimulate breeding in the early spring months. It also enables swarms to furnish their hives with comb at a time when, if unfed, no progress could be made in this direction. 3. The ants must be got rid of without delay. Stand the hive legs in saucers or vessels containing water or paraffin, or use the new "iron shoe" for hive legs.

[3141.] *Failing Queens and Fertile Workers.*  
—I write to ask your advice in the following case:—In one of my hives the bees only cover three or four frames, although I have been feeding them since April 2, and the bees have been carrying in pollen since March 13. I can see nothing wrong with the queen, but the brood (of which there is some in two frames) is rather scattered, and I notice there are two or three eggs in some of the cells. 1. Must it be supposed from this that there is a fertile worker in the hive, and the queen (hatched in 1901) is failing? 2. If this is the case, are the bees worth re-queening? 3. I should also like to know whether drone-eggs laid in worker-cells develop and lead the ordinary life of drones, though smaller in size, or whether they are cast out and killed by the bees. With thanks for answers to former inquiries.—H. E., *Sunderland.*

REPLY.—1. The method of depositing the eggs as described points to a fertile worker, but any uncertainty will be removed if drones are being reared in worker-cells. 2. The stock might possibly build itself up into condition for winter if a young queen were given at once, but it is hardly worth the trouble and cost of re-queening. 3. Drones raised under the conditions named are capable of fulfilling all the functions of those raised under normal conditions.

## Bee Shows to Come.

A nominal charge of 2s. 6d. is made for notices in this column, which covers cost of insertion from order till date of show. Cash should accompany orders for insertion.

July 15 and 16 at Lichfield.—Annual Bee and Honey Show of the Staffs B.K.A. Open Classes for Comb and Extracted Honey and Appliances. Schedules from Rev. G. C. Bruton, Great Haywood, Stafford. **Entries closed.**

July 16 and 17, at Lincoln. Honey, Hives, and Bee Appliances, in connection with the annual show of the Lincolnshire Agricultural Society. Bee department under the management of the Lincs B.K.A. £28 in prizes. Schedules from R. Godson, Hon. Sec. L.B.K.A., Tothill, Alford. **Entries closed.**

July 22, at Broughton, Hants.—Fruit, Flower, Vegetable, and Honey Show. Twentieth year. Liberal prizes, with silver cup, valued £15, open to the United Kingdom. Particulars from Fred. J. Hinwood, Broughton, Stockbridge, Hants. **Entries close July 18.**

July 22 and 23, at Cardiff.—Honey show of the Glamorgan B.K.A., in connection with the Cardiff and County Horticultural Society. Bees, hives, honey, trophies, wax, appliances, and articles of food. Substantial money prizes and medals. Free entries. Six open classes. Schedules from William Richards, Gabalfa, Cardiff. **Entries close July 16.**

July 29, at Wallop, Hants.—Honey Show of the Broughton and Wallop Branch of the Hants and

Isle of Wight Bee-keepers' Association. Two open classes for single-section and 1-lb. jar respectively (entry free). Schedules from Miss Tucker, The Lindens, Broughton, Stockbridge, Hants. **Entries close July 22.**

July 29, at Henbury, near Bristol.—Annual Show of the Henbury District Bee-keepers' Association in connection with the Horticultural Society's Exhibition. Several open classes with good prizes (two classes with free entry). Schedules from I. Atkin Waller, hon. sec., Pen Park, Westbury-on-Trym, near Bristol. **Entries close July 24.**

July 30, 31, and August 1 and 3, at Old Trafford, Manchester.—Annual Show of the Royal Lancashire Agricultural Society. Liberal money-prizes are offered for honey along with silver and bronze medals of the B.B.K.A. and also of the Society. Open classes for Honey-Trophy, Sections, Extracted Honey, Beeswax, Honey-Confectionery, Bee Flowers, Instructive Exhibits in Bee-Culture, &c. Schedules from Edward Bohane, Secretary, Miller-arcade, Preston. **Entries close June 30.**

August 3 (Bank Holiday) in the Walled Meadow, Andover.—Honey Show in connection with the Andover and District Horticultural Society. Class for single 1-lb. jar of extracted honey (with no entry fee). Also classes for sections, extracted honey (light and dark), and beeswax. Schedules from the Hon. Sec., Dr. Gillett, Elvin House, Andover. **Entries close July 28.**

August 4, at Leamington.—Tenth annual show of the Leamington St. Mary's Horticultural Society. Three open classes for Six 1-lb. Sections, Six 1-lb. Jars "Light," and Six 1-lb. Jars "Dark" Extracted Honey, respectively. Liberal money prizes. Schedules from P. W. Smith, Secretary, 22, Leam-street, Leamington. **Entries close July 30.**

August 6, at Nantwich.—Honey department of the Cheshire Agricultural Society's Show under the management of the C.B.K.A. Numerous classes for hives, honey, and wax. Money prizes and medals. Schedules from T. A. Beckett, St. Werburgh's Chambers, Chester. **Entries close July 16.** At double fees July 23.

August 6, at Kingsthorpe, Northants.—Honey show of the Northants B.K.A., in connection with the Horticultural Society's Exhibition. Three open classes with special prizes, including one for single 1-lb. jar of honey. (*Entry free.*) Prizes 20s., 10s., 7s. 6d., and 2s. 6d. Schedules from R. Hefford, Hon. Sec., Sunnyside, Kingsthorpe, Northampton. **Entries close August 1.**

August 12, at Radstock, Bath.—Honey show in connection with the annual show of the Radstock and District Horticultural and Fanciers' Association. Schedules from the Secretary, B. M. Clark, 1, Fox Hills, Radstock, Bath.

August 19, in the Great Western Park, New Swindon.—Wilts B.K.A. County Show of Bees, Honey, &c. Fifteen classes in all, five open to all England. Schedules from the Hon. Sec., W. E. Burditt, Buttermere Rectory, Hungerford, or from local Hon. Sec., S. W. Fittness, Market House, Marlborough-road, Swindon. **Entries close August 10.**

August 25, at Cartmel, Lancashire.—Honey show in connection with the Cartmel Agricultural Society. Open classes for sections, extracted honey, and beeswax. Local classes for sections and extracted honey. Schedules from Wm. Cragg, Secretary, Cartmel, via Carnforth.—**Entries close August 13.**

August 26, at Reading.—Honey Show of the Berks B.K.A., in conjunction with the Annual Exhibition of the Reading Horticultural Society. Open classes for comb honey in sections and for extracted honey. Local classes include prizes of 20s., 15s., 10s., and 5s. for honey trophy. Also classes for owners of small apiaries. Schedules from D. W. Bishop-Ackerman, Hon. Sec., Berks B.K.A., 131, King's-road, Reading.

August 27, at Llangollen.—In connection with the fifth annual Flower Show. Open classes for Six 1-lb. Sections, Six 1-lb. Bottles Extracted Honey, and Beeswax. Schedules from Frank Little, Castle-street, Llangollen. **Entries close August 13.**

August 27, at Montgomery, in connection with Montgomery and District Horticultural Show. Open classes for Six 1-lb. Sections and Six 1-lb. Jars, Extracted Honey. Prizes in each class 10s., 5s.,

2s. 6d. Entrance-fee 1s. each. Schedules from W. J. Jones, Secretary, Montgomery. Entries close August 20.

September 17, 18, and 19.—At Crystal Palace, Surrey, B.K.A. Annual Exhibition of Bees, Honey, Wax, and Appliances, &c. Further particulars and schedules ready shortly from F. B. White, Secretary, Marden House, Redhill, Surrey.

## Echoes from the Hives.

Wells, Somerset, June 18.—Bees are doing well here in spite of the cold and rainy weather. Yesterday was the only fine day since Friday, 12th. I have already had four swarms from hives I had specially set apart for swarming; the others are all supered, some with two racks of sections, and every one is crowded with bees. Mine are all pure Italians: Mr. Sladen got the queens for me, and they are, in my opinion, preferable in every way to the blacks, except that the cappings on the sections are a shade darker in colour, owing to the want of air-space between capping and honey. I have had to destroy one queen, as, owing to some slight defect, she was unable to get her eggs more than half-way down the cells.—A. PERKINS (Major).

## Notices to Correspondents & Inquirers.

Letters or queries asking for addresses of manufacturers or correspondents, or where appliances can be purchased, or replies giving such information can only be inserted as advertisements. The space devoted to letters, queries, and replies is meant for the general good of bee-keepers, and not for advertisements. We wish our correspondents to bear in mind that, as it is necessary for us to go to press in advance of the date of issue, queries cannot always be replied to in the issue immediately following the receipt of their communications.

B. J. F. (Cheshire).—*Incorrect Use of Bee Terms.*—In assisting you, as desired, to differentiate between *nucleus* and *nuclei* among other terms used by bee-keepers, we cannot improve on the following brief definitions as given in a recent issue of the *American Bee Journal*:—"The correct use of bee terms, at least of a few of them, is a matter of more or less perplexity to those not familiar with them. An egg in a cell hatches out into a *larva*. *Larva* is the singular, *larvæ* the plural; one *larva*, two or more *larvæ*. *Larval* is the adjective; as 'bees in the larval state.' *Nucleus* is the singular, *nuclei* the plural; one *nucleus*, two or more *nuclei*. When used as an adjective *nucleus* is the word; *nucleus* plan, not *nuclei* plan of increase, no matter if a hundred nuclei are used."

W. STANDING (Blackpool).—*Insect Nomenclature.*—1. The insect sent is a queen wasp. 2. They may be easily destroyed when found lurking in hive roofs or beehouses preparatory to starting a nest; at other times or when seen on the wing they have to be brought down by water from a syringe or knocked down with the readiest thing at hand before being killed.

LAURA HARVELL (Woodcote).—*Moths in Hive.*—Your specimen is a small moth, not the true wax, or "Miller" moth, *Galleria cereana*. The latter is larger and a much more formidable enemy to bees. The small moth never gets a footing in strong hives, though *G. cereana* often does and destroys combs wholesale. Such care as you are giving, *i.e.*, destroying the larvæ promptly when seen, is all that can be done; but as the stock is your "weakest hive," it accounts for the moth trouble. Try to strengthen it with a young queen. Glad to hear your other hives are doing so well.

H. C. T. B. (Foots Cray).—*Faulty Section Racks.*—1. The maker of rack is at fault and should remedy the defect. 2. *Feeding Swarmed Stocks.*—If there is food in super the necessity for feeding the parent hive, of course, does not arise, unless you remove the super and give it to the swarm for completing.

J. WALLACE (Bramhall, Cheshire).—*Insect Nomenclature.*—Mr. F. W. L. Sladen, to whom we forwarded the insects and mud-cells with hatching brood, kindly writes regarding them as follows:—"The insects sent are solitary wasps of the genus *Odynerus*. They are quite harmless to bees, and usually construct their mud cells under projecting ledges of stone or brick. These wasps generally provision their nests with small green caterpillars. The parent *Odynerus* succeeds in disabling these caterpillars, without killing them, in such a way that they will remain alive in the nest for days in a half-paralysed condition, until its young can devour them. It is believed that they do not suffer when in this condition. I have taken over a dozen of these wretched caterpillars from a single mud-cell. The specimens sent are all females of the species *O. pictus*. The males had probably emerged a few days before the cells were taken."

### *Suspected Combs.*

"PENN" (Bucks), and J. W. (Warrington).—We find slight signs of foul brood in comb. The disease is evidently in the incipient stage in both cases.

M. B. (Sussex).—We find very slight signs of incipient foul brood in a single cell only of sample. The rest of larvæ is chilled only. Bearing in mind the extremely infectious nature of *Bacillus alvei*, and the difficulty of eradicating the disease when it has reached the spore stage, it can never be absolutely certain that there will be no recrudescence of the malady. It would, however, seem that the remedial measures adopted in skilled medical hands—as in your case—are successful in controlling the disease, if not effecting a complete cure. As you are a medical man, we might suggest a trial of "Formaldehyde," mentioned on p. 226 of B.J. for June 4, for disinfecting combs and hives.

"PUZZLED" (Dearham).—There is no disease in small bit of comb sent.



## Editorial, Notices, &c.

### ROYAL LANCASHIRE AGRICULTURAL SOCIETY.

SHOW AT MANCHESTER.

#### *Extension of Date for Entries Closing.*

We are asked to draw attention to the extended date (July 7) of closing entries for the above important show, to be held at Old Trafford, Manchester, on July 30 and three following days. The fine bee weather now prevailing will, no doubt, enable many bee-keepers to take advantage of the extra week's time for deciding to exhibit, in view of the good prospect of honey-gathering between now and staging day. The prizes offered are liberal and numerous, while valuable silver and bronze medals, &c., are given in addition as special prizes in the various classes.

The Trophy Class (open) has prizes of £3, £2, and £1, besides above-named medals, with £2, £1, and 10s. offered in each class for 1-lb. sections and 1-lb. jars extracted honey respectively. Other open classes include equally liberal prizes for dark honey, heather honey, honey-confectionery, beeswax, and displays of bee-flowers, so that all sections of bee-keepers are catered for.

No time should, therefore, be lost in applying for a schedule. (See advertisement on front page.)

### ROYAL AGRICULTURAL SOCIETY.

SHOW AT PARK ROYAL, LONDON.

*(Continued from page 252.)*

The success or otherwise of the new departure in establishing a permanent show-yard in London for the annual meetings of the R.A.S.E. cannot possibly be gauged by the show of last week; more time must be allowed, for many reasons. A change involving the laying out and properly completing a show-yard of such magnitude, to say nothing of such developments as will be found to draw crowds of visitors to the place, is as yet in the distance, and only practical experience will show where shortcomings are, if such exist. The weather was all that could be desired, but the show-yard at Park Royal was certainly not seen to advantage, nor did the incomplete arrangements for the comfort of visitors—though doubtless unavoidable—tend to convey a favourable impression; but as we have said, it is mainly a question of time, and when next year's show comes round a considerable change will, no doubt, be seen in all directions.

The thoughts of our readers will naturally turn to the bee-department, and it will serve to emphasise the difficulties to be contended with in other directions by taking account of how adverse weather affects our section of the

show. The general complaint was the few entries in each of the honey classes; but on all hands it was admitted that the short honey-crop of 1902, and the fact that all but a very few had "sold out," made a small entry inevitable, especially in view of the thirty-seven classes for honey alone comprised in the schedule.

*Class 384.—Collection of Hives and Appliances.*—Though the entries were few compared with some years, the collections staged made up an excellent display by reason of the large number and great variety of goods each of the exhibits contained, Messrs. Jas. Lee & Son's first-prize collection being in all respects admirable and worthy of the award. Taking full advantage of the "other distinct articles not specified" item in the schedule, Messrs. Lee staged no less than fifteen frame-hives, each one "distinct" and different from any of the others. The exhibit also contained several useful novelties, among them a Danzenbacker hive, adapted from that made in America, where the "Danzy" is very popular. We saw also a section-rack as adapted for long sections or shallow-frames of heather honey, as recommended recently. Another novelty was the "R. H. Smith" super-clearer.

Mr. E. H. Taylor took second prize with another large exhibit of useful goods, though duplicated articles and small appliances used in the apiary were more to the front. The hives were of good type, and all dovetailed, thereby securing additional strength and durability. We are glad to see this feature of hive-making now being generally adopted, and it is safe to say that all makers will ere long find it necessary to possess one or other of the improved machines for superseding the wire nail in putting hives together. Mr. Taylor's hives were among the first to be so made in this country, and others are of necessity following suit.

Mr. Meadows' third prize collection suffered somewhat in appearance from the super-abundance of tinwork—a fault that seems the natural outcome of a manufactory with a special reputation for high-class metal goods. There was, however, the usual full supply of hives and appliances, and it was on the special recommendation of the judges that a third prize was given to Mr. Meadows as the number of entries limited the number of prizes to first and second.

*Class 385.—Outfit for Beginners in Bee-keeping.*—Another small entry, and each exhibit consisted of the usual articles. We begin to think that the object for which this class was established has now been attained, and would not be sorry to see the prizes go in a more useful direction. The same things are shown every year, and the competition seems to have resolved itself into a question of who will give most value for the 30s. limit of schedule; and when an exhibitor offers more than full value it has a demoralising effect all round.

*Class 386.—Complete Frame-hive for General Use.*—This class, though small, was an exceptionally good one. In fact, we did not see a single hive that was other than good "for general use." The first prize was again secured by Messrs. Lee & Son with a "W.B.C." hive of the original pattern without any non-swarming arrangement. In fact, the makers write us to say: "It is what we call our standard pattern 'W.B.C.' such as we are daily sending out to customers." Messrs. Lee also took second prize in this class for another hive of the same type, but holding twelve frames, and with some other slight alterations. As, however, no exhibitor can take two prizes in one class, this hive was ineligible, and the second went to Mr. Meadows for the next best, viz, his well-known and excellent "Birmingham" hive, which took premier honours at the "Royal" in 1898. In the same way the reserve number and highly commended hive of C. L. Greenhill moved up and secured the third prize for a hive of the same type as the first-prize one, but with outer cases made to telescope over body-box for winter. It also had a novelty in shape of a sliding flight-board for summer use, made to slide out of the way in winter below the ordinary alighting-board.

*Class 387.—Inexpensive Frame-hive for Cottagers' Use.*—Messrs. Lee again got first prize, this time for a neat hive, double-walled front and back, deep lift to cover its rack of sections, and telescope over body-box in winter. The floorboard is fixed to stand, which latter has a strong iron eye screwed into each corner to preserve the wood from rotting. The second prize went to Mr. Meadows's well-known excellent hive for taking bees to the heather. Though now before the public for some years, we have seen no hive to surpass this for the rapid and effective way in which the bees can be secured from the slightest risk of escaping during transit, while ensuring ample ventilation on the journey without removal of surplus-chambers. By means of this registered ventilator the desired advantages are attained in the simplest possible manner. Mr. Taylor's third-prize hive is also a good one. It has deep lift—made to telescope over body in winter—rack of sections, and raised stand fixed to floorboard, with detachable porch—a useful and effective hive for cottagers' use.

*Class 388.—Honey Extractor.*—Only two manufacturers competed in this class, Mr. Meadows taking first with an exceedingly well-made machine—the "Cowan" Rapid—with reversing cages. The second prize was awarded to Mr. Taylor for a machine of same type, and Mr. Meadows got the reserve number and h.c. for the "Raynor," a well-known and popular machine without the reversible cages.

*Class 389.—Observatory Hive with Bees and Queen.*—Messrs. Lee & Son's capital three-frame observatory hive deservedly took the only prize awarded in this class.

*Class 390.—New Appliances Connected with Bee-keeping* (to which no prize has been awarded at a show of the R.A.S.E.).—Some interesting exhibits were staged here along with others that only need a practical test prior to being discarded by the inventors themselves.

The first prize went to Messrs. Jas. Lee & Son for the "K. H. Smith" registered super-clearer (so named after the inventor, an extensive honey-producer located at St. Thomas, Ontario, Canada). This appliance is a distinct advance on the "Porter" bee-escape, as being more rapid in clearing surplus-chambers. There are eight bee-ways or exits for the bees, which latter pass by the delicate springs with almost no hindrance whatever, but cannot return; nor can the springs become blocked by bees, as sometimes happens with the "Porter" escape. A certificate of merit was also awarded to Mr. W. P. Meadows for what we think will be a very useful combined uncapping tin and wax extractor. No other appliance in the class received any recognition from the judges.

Our necessarily brief notice of the numerous classes for Honey, together with those for bees-wax, mead, honey vinegar, and the classes for interesting and scientific exhibits connected with bee-culture, is unavoidably held over till next week.

## Correspondence.

*The Editors do not hold themselves responsible for the opinions expressed by correspondents. No notice will be taken of anonymous communications, and correspondents are requested to write on one side of the paper only and give their real names and addresses, not necessarily for publication, but as a guarantee of good faith. Illustrations should be drawn on separate pieces of paper. We do not undertake to return rejected communications.*

*Communications relating to the literary department, reports of Associations, Shows, Meetings, Echoes, Queries, Books for Review, &c., must be addressed only to "The Editors of the 'British Bee Journal', 17, King William-street, Strand, London, W.C." All business communications relating to advertisements, &c., must be addressed to "THE MANAGER, 'British Bee Journal' Office, 17, King William-street, Strand, London, W.C."*

## AMONG THE BEES.

### THE BEE NATION.

[5152.] We are all familiar with the proverbial bundle of sticks, and have it reiteratedly dinned into us to prove that union is strength. We, who are familiar with the amazing results of unity and combination in the bee-hive have an admirable illustration of the effect of confederated effort. How small and puny a single bee is; how little it can accomplish by its own unaided effort; how evanescent is its existence even under the most favourable circumstances and surroundings; and how futile would its labours prove if done for its own pleasure and gratification alone! For propolis would be as useless as

the dust of the earth; pollen would be all a vain show, like gold to a hungry man; and honey would be almost as profitless, because, apart from the tiny drop it might suck like the butterfly from the passing flower, it is incapable of providing a store wherein to lay by a supply against the period of gloom and chill when the flowers fail to secrete sweet juices to nourish it. Apart from its fellows it could derive little pleasure from life, because there could be no call on it for labour of any kind, so that what is now its chief joy and delight would fail to find a place in its existence. It would have no wax to evolve, no comb to build, no larvae to tend, no cells to seal, no bee bread and chyle food to manipulate, no family cares to beguile the tedious time, no household duties to engross its attention, no domicile to protect, and no stores to defend. It might live thus a single, joyless, life of slow dragged-out existence for several days; shut out from association with its fellows, hermit like, isolated, and alone. But the first chill night of proud independence would also be its last because loneliness and solitariness would cramp its energies, chill the very fountains of life, and impair its vitality. Its already cold blood would cease to flow, and it would soon become mere matter.

The feeling of friendship or kinship, association and unity would be lacking in a case of "single blessedness," and without them the bee cannot exist. These bonds are the very life and soul of the hive bee, and a part of its very existence, the very essence of its being, a thing apart from which a colony of bees would find life not worth living. The sense of effort—combined effort—is an utter necessity; the warmth, shelter, and comfort of their own "fireside," and the sweet sense of friendship engendered from association on the domestic hearth, are a part of the bees' being and an utter necessity. The propagation of the species requires combination and unity of effort, and without it the race would soon die out. Sweet content, glad joyousness, perfect happiness, are intermingled with the admirable concord of associated effort, when each will for the good of the whole is bent, and every single bee, in a spirit of the most unselfish devotion to the well-being of the community, strives to add to the stock of happiness for all. No wonder the poet says they teach the art of order to a peopled kingdom, for no species of government capable of suggestion could so ideally and really carry out the perfect good of the community as the admirable rule and order the spirit of the hive spontaneously engenders in the heart and being of these teeming thousands. How perfectly and successfully this works out for the comfort and well-being of a family all imbued with the same aims and objects, the same ideal federated effort towards perfection and the goal desiderated and wrought for by every single individual, every beeman can see by carefully studying the well regulated order

secured in a healthy and powerful colony of bees.

The community is composed of "unnumbered bodies with a single mind," and this guides, directs, controls all those tens of thousands so that they work in harmonious combination, and the result attained is such as if it were the fruits of the effort of one single unity. Witness the construction of those marvellous cells, each a perfect palace and work of art; those tiny attentions, trifling but necessary, constantly continued, which the nurses bestow on the rising generation until they cap the cells; those stores of golden juice, garnered by ceaseless toil, so preserved that age does not deteriorate its sweetness or its potency; those masses of bee-bread hoarded up until the queen starts ovipositing; those wise and almost prescient provisions made for fertilising queens; and the no less far-seeing and almost prophetic preparations made for renewing queens, by an act almost amounting to a creative faculty. All of them are unique and ideal in their perfection of attainment. Association and combination are the secret of success. As old Purchas says, "*Una apis, nulla apis*; one bee is no bee; but a multitude, a swarm of bees, uniting their forces together is profitable, very considerable, very terrible; profitable to their owners, comfortable to themselves, terrible to their enemies."—D. M. M., *Banff*.

#### BEEs TRANSFERRING THEMSELVES.

[5153.] The above-named excellent plan of getting a stock of bees in a skep to change their abode insensibly, and with no waste of bee-life into a frame-hive, has often been explained in our columns. The principle is absolutely simple. The skep is placed over the top-bars of frames, which latter are filled with foundation, all is made snug, and the bees gradually work down.

When they are established below, the skep is removed as a super full of honey.

But (there is always a "but") here comes the rub. With all great principles, whether mental or moral, a difficulty often arises in carrying them out. We most of us are believers in a high ideal of life, yet we all feel the difficulty of living up to our ideal. Now what has this little sermon to do with "bees transferring themselves?" Just this, that in carrying it out we must be prepared for unexpected contingencies, and be ready to meet them. I take this to be one of the great secrets of successful bee-keeping. If you are not *prompt* with bees, they will be *prompt* with you, and not only will you know it, but every one else in the garden will know it too. A gentleman's gardener in a village near me had a swarm of bees last year; they were hived in a skep and left there. A friend put them over a frame-hive this year to transfer themselves. He has been very anxious lately to "know how they were getting on."

So I looked at them the other evening. They were booming after a grand bee-day. I told him I would lift the skep, and, if it were not ready to come off, would replace it. But, as Burns reminds us,

The best laid schemes of mice and men  
Gang aft a-gley.

And when I had very carefully (with a little smoke) tilted the skep, I found one or two of the combs—heavy with honey and soft from heat—break away; so that had I replaced it the bees below would have been swamped with honey. The colony had evidently established itself below, though there was still a good deal of brood in the skep, and it would no doubt have been better to leave it on but for the broken combs. I made up my mind at once to drive the bees, so turned up the skep and got my friend, the gardener, who was well protected, to hold it while I slipped on a carbolio cloth over the frames for a moment, and then adjusted a rack of sections, made all snug, and took the skep away and drove the bees. The combs had so fallen together that I wedged them apart to enable the bees to run up, which all did, excepting a few, who were too sticky. I tied the brood into a couple of frames, as in the old method of transferring. And as fortunately the hive was a long one of the "Combination" style, all I had to do was to slip back dummy and insert the frames.

I had turned up the skep containing the driven bees at the alighting-board, but finding they went up very slowly shook them out on a board and cloth, and they merrily made for home, as I did myself a few minutes later, realising how much the bicycle has done to bring us country bee-keepers in touch with each other. Can you kindly tell me for my own instruction and the benefit of our readers if I did right or where my methods were faulty?—A. A. H., *Alresford, Hants, June 26.*

[You did quite right.—EDS.]

### THE "RYMER" METHOD.

#### WORKING FOR HEATHER HONEY.

[5154.] In response to the request made by "D. M. M., Banff," on page 242 of B.J. for June 18, I may say there is very little to add to the details of my method as practically adopted and given in the B.B.J. for November 1, 1900. The plan there described has been such a complete success in my hands that I shall be very cautious in deviating from it or making any alterations. The fact of no swarm having issued from any of my forty stocks in nine years makes it fairly safe to say that swarming is—in my hands—entirely under control. This is the one thing I set out to accomplish, and, having succeeded, as a matter of course, my honey-crop has been considerably increased.

Like the "Contributor" referred to by "D. M. M.," I was myself under the impression that the latter condemned the method, and I am glad to be set right. I had hoped

that our Scotch friend would have made it a success, because there is one point in this method that I cannot test myself, as my bees are permanently located near the heather. I have had the question put to me by a good many brother bee-keepers who have visited me for a bee-chat, "How would you remove those enormous stocks to the moors?" I confess I do not know, and have had no occasion to think out a plan, as I have no removing to do. On the other hand, I am quite sure I would find out some means of doing it if the need arose, and I am equally certain that "D. M. M." could do the same. Anyway, if removal to the distant heather was made a success with one or two hives it would be "one" great point gained for heather-men, and my opinion is "D. M. M." is just the man to undertake the task, as it will require some thought as to the ways and means of securing the end in view.

I am under the impression that many bee-keepers do not realise the amount of breeding-space some of the most prolific queens require when heather-honey is the main object in view and late-bred bees are of such value. In some cases it will take two "W. B. C." brood-boxes, a box of shallow-frames, and a "W. B. C." section-rack to hold together such a stock as I have in view. But it is only such colonies that are able to make one great effort on the heather in August or early September, according to the season.

Regarding the slight changes made since November, 1900, it must be borne in mind that I always have a queen-excluder placed on top-bars of the second brood-chamber, and as the queen must be placed in the *lower* brood-box in the middle of July and the excluder placed on the top of this chamber, measures must be taken to secure this end. The method I have adopted in a good many cases lately is first to find out in which chamber the queen was at the time; I lift off the top brood-chamber (after giving a little smoke) and place it on a board close to the side of the hive from which it is removed, and, raising the box up by a wedge so that the bees can get out easily; after watching the bees a few minutes they will enable you to judge easily in which of the two brood-chambers the queen is. I like this plan better than the brushing off process and trouble of lifting out frames and examining them. If the bees in top chamber are well smoked down before removing the latter it will—in nine cases out of ten—be found that the queen is in the bottom box. You then confine her there and replace all. Occasionally it happens that the bees are requeening themselves and sealed queen-cells may be found in both of the brood-chambers, in which event an examination must be made while all is quiet, and such steps taken as you think best to meet the requirements of your own particular case.

I must impress on all that the queens must be the best you can get, and not more than

two years old; a supply of young queens should, therefore, be raised every year to keep your stock in good condition.

The *quality* of the queens should be the first consideration. At some future time (if it would be of interest to bee-keepers) I might touch on this matter of queen-rearing and introducing as practised by myself, but, as there are so many ways of obtaining good queens, I might only occupy space that could be put to better use.—J. RYMER, *Levisham, Yorks, June 27.*

#### QUEEN MATING.

[5155.] I do not know whether my experience *re* queen mating is unique or not, but certainly the little incident herein related was very interesting to me, and maybe to others. On Wednesday, June 17, I had a swarm, and wishing to have this on the old stand I removed the parent stock to a fresh one and put body-box into the outer case of a hive with entrance at each end of flight-board. I then divided stock by inserting a division board in centre, thereby making two small stocks, with queen-cells in both. On the eighth day after swarming (it being an ideal bee-day) I thought it probable that one of the young queens might come out on her mating trip, so sat down near the hive to watch. Sure enough, about 2.30 a young queen came out and flew all about the entrance examining it most minutely, but never going more than 3 or 4 ft. away from the hive into which she soon returned, in fact, acted exactly as any young bee does on its first flight. In a few minutes another queen came out and acted precisely as the first had done. I thought no more would be seen of them that day, but remained watching, and very soon both queens came out almost together, and this time circled upward into the air. In a short time both queens returned in close succession, and I then saw that one had been fertilised but the other not. Shortly afterwards the latter came out again, but soon returned still a virgin. This somewhat surprised me as there were hundreds of drones flying at the time; indeed, the air seemed to be full of them. However, the young queen came out a third time, and on her return it was plainly seen that she had mated and was all right.

Now, in most writings respecting the behaviour of a young queen on her mating flight, there seems to be a good deal of difference from my own experience. It is usually stated that a virgin queen turns out in a careless, haphazard fashion, rushing out and flying away without the remotest idea as to where she left her hive, and that on returning she tumbles into the first hive she comes to, whether her own or any other, making no difference at all. This is the point I want to emphasise strongly in these remarks, because nothing would be farther from the truth, as I

have now proved by] ocular demonstration. The fact is, she acts exactly as other young bees do, only, if anything, observing more cautiously. On taking a second flight, *i.e.*, her real mating trip, she leaves the hive quietly and with no undue haste, and begins to circle upward in gradually increasing circles, and on her return is most particular in finding her own home, examining entrance each time most minutely before venturing in, as though she knew the result of making a mistake. In this case the two entrances are not above 15 in. apart, on the same flight-board and exactly alike, only a half brick lying between them, but I am quite satisfied that had they been close together there would have been no mistake made. I am also satisfied that if a queen fails to reach home on her mating flight, the failure must be attributed to some other cause than entering the wrong hive, and I shall remain satisfied on the subject, unless some one can say they have certainly seen such a thing occur. If you think these remarks would be of any interest to bee-keepers you can insert them. If not there is room in the "w.p.b."—W. T. POSTLETHWAITE, *Salcey, Cheshire.*

[It is, to say the least, always "interesting" to record the experiences of bee-keepers in all the varying items which make up bee-life, but we fear it would add little to the practical usefulness of our reports to attach undue importance to *first* experiences. To do so would be like taking a beginner's views in preference to those of the man whose experience gives weight to his words, and real value to his views. Without knowing what "writings" are referred to as being faulty in descriptions of queen-mating, it is safe to assume that the authors, whoever they are, will be men whose personal knowledge of queen-mating will extend beyond the one day's experience of our correspondent. At the same time, we are always glad to publish such interesting communications as the above.—Eds.]

#### SECTIONS FOR HEATHER HONEY.

[5156.] Referring to Mr. Jas. Waddell's remarks in B.B.J. of June 11 (5140, page 235) *re* large sections for heather honey, permit me to say I have for some years used non-sectional supers for heather instead of sections, and find the returns much larger. Several years ago I met a well-known Scotch bee-keeper at Melrose, a Mr. Jas. Johnstone, Touch, who recommended the use of the non-sectional supers to me in preference to the ordinary sections. Last year was a failure in most heather districts, but a friend told me that the only heather honey he got was in small sectional supers.

The reason is obvious—bees can cluster in greater numbers in a non-sectional super. If all are made the same size, and foundation attached to bars, it is possible to remove well sealed bars from three or four supers, and

make up, say, two or three good supers by substituting sealed bars for unsealed ones.

I quite agree with Mr. Woodley's remarks on page 212, *re* driving bees in bee-tent work. I think the practice should be done away with, and manipulation with a frame-hive substituted. With regard to the best section for general use, I find nothing to equal the old two-way one, but so far I have not tried new "tall sections," but I hope to this year.

Bees here about are almost at starvation point, and are feeding at midsummer with plenty of clover over the garden wall. So far the season is worse than last year. Hope it may soon improve.—H. MARRS, *Newtonards, Dumfriesshire, June 24.*

### LONG SECTIONS

FOR HEATHER HONEY.

[5157.] Referring to Mr. G. M. Saunders's letter (5144, page 244), he seems to infer that the long sections as used by myself are too lightly got up for marketing purposes. I would, therefore, like to point out, that I conveyed the same over twenty miles of very rough country roads, without a single breakdown. I am confident when worked out and filled they are strong enough for any purpose. But if so wished, any one can get them made by Mr. David Raitt, Blairgowrie,  $12\frac{3}{4}$  in. by  $4\frac{1}{2}$  in. by 2 in. by  $\frac{1}{4}$  in. thick.

These sections are more economical than shallow-frames as the latter have to be cut down in order to make them fit into the section-racks, whereas these I have referred to can be worked in the same rack as with a 1-lb. section and cost less than the shallow-frames.—J. WALKER, *Blackhill, co. Durham, June 24.*

### BUYING SECOND-HAND HIVES.

[5158.] I received your "wire" yesterday and also your letter this morning, and I am much indebted to you for the prompt and timely advice given. I will, of course, do as you suggest.

If it had not been for reading the "Guide Book" and taking the BEE JOURNAL my little apiary would probably have been ruined. Last year was my first, and a very poor year it was, but I felt quite repaid, though I did not get a section. This year, however, there is a prospect of profit as well as pleasure.

I have seven lots of bees now, three being this year's swarms, one of which came off last week on a cold, miserable day, as unlike swarming weather as possible, but I made the bees warm and fed them, and they are now doing first class.

The hive about which I wrote you was handy, and I got it to save time, but I have profited by the experience, and in future will be prepared beforehand for swarms.

My best stock is in a "W.B.C." non-swarm-

ing hive. I transferred a strong lot to it from an old hive. I had the assistance of a friend who has had more experience with bees than myself, and though it was a difficult job on account of brace-comb and old frames, I am greatly pleased with the result, for this hive has already given me my first taste of the honey harvest. Again thanking you,—D. S. P., *Ferry Hill, June 23.*

### BEE-KEEPING IN GERMANY.

[5159] I see in the JOURNAL of June 18 a "Bee Note from Austria," signed, "'Nemo,' Trieste." Would it be against your rules to give me "Nemo's" real name and address in Trieste? I am going out to Austro-Hungary (Transylvania) myself in about three months' time, and as a bee-keeper I should very much like to know the address of a fellow bee-keeper. I shall probably start bee-keeping there in the spring, and "Nemo" might perhaps be willing to give me some assistance and advice as to where to get hives and appliances. Besides, he appears to be an Englishman, and though I can manage to "get along" in German and Hungarian I can speak and write with much greater ease in my native tongue. Hoping you will excuse my troubling you, I remain,—(Mrs.) L. SHIRLEY, *Sharland Lodge, St. Helier, Jersey.*

[It is against our rule to give names without permission from those who write under a *nom de plume*; but we will be very pleased to send "Nemo's" name and address privately, or will forward a letter if sent to this office, and have little doubt that the needed help would be afforded. We may also say "Nemo" is an Englishman, and his apiary was shown in our "Homes of the Honey Bee" a few years ago. Our correspondent may be glad to know that Mr. Chas. Schroder, the British Vice-Consul at Trieste, is an ardent bee-keeper, and regular reader of the B.B.J.—EDS.]

## Queries and Replies.

[3142.] *Artificial Swarming and Non-Swarming.*—Would you kindly advise me as to what I should do under the following circumstances:—This spring I had two strong stocks, from which I made an artificial swarm, and afterwards fed both stocks from which the swarm was made until they had again increased to nine frames each. I then put in a box of shallow-frames with starters only under each stock, and a rack of sections above. On examining the stocks in question to-day I find the shallow-frames fully drawn out, and well filled with brood, mostly drone. The combs, however, are not built within the frames or straight, as they should be, but across them, and are all shapes, as shown in rough sketch. Nothing at all has been done.

Kindly say what I should do in the matter, and you will greatly oblige — ENQUIRER, *Strachur, N.B., June 23.*

REPLY.—According to our reading of the above letter, there seems to have been an entire departure from the orthodox principles usually observed in such operations as are detailed. The exact method followed in making an artificial from two stocks is not made clear, but we presume that some combs of brood were taken from both the parent stocks. This being so, we must suppose that the “non-swarmling” hive idea was intended to be followed in giving a box of shallow-frames below the brood-chamber for transferring above the latter when ready for removal. This being so, we cannot understand why a rack of sections was given overhead at same time. The proper course would have been to fill the shallow-frames with full sheets of foundation, and, as soon as the bees had started building therein, to lift the box—bees and all—above the brood-chamber, with queen-excluder between.

In reply to the query with which our correspondent closes his letter, we cannot understand bees disregarding “starters” of foundation properly fixed in frames, and building combs crooked and crosswise in all the frames, as stated. To build “mostly drone-comb” is just what the bees would do when preparing to swarm, but, if the “starters” extended to full length of top-bars, the foundation must surely have dropped out to account for what followed. Any way, the box of combs—as now built—are worse than useless. We advise removal at once; then melt all broodless comb down for wax, and destroy the drone-brood.

[3143.] *Loss of Swarms.*—Referring to my query (3133, page 248), and your kind reply thereto, I fully intended to examine the hive in question, but the bees swarmed before I was able to do so, on June 21. After removing queen-cells, I returned swarm, and to-day (Monday) they are very busy, the weather being the best we have had since June 1. Upon examining the queen-cells after removal I found in one a fully-developed queen, which I destroyed, as I saw the other queen enter the hive all right. May I now ask:—1. What period usually elapses between issue of swarm and hatching of queen? 2. What is the probable age of queen that headed swarm? 3. Are queens fertilised by drones of the same hive?—S. H. HOLDAWAY, *Wroxall.*

REPLY.—1. Seven to nine days. 2. The swarm which was lost on June 1 would be headed by the parent queen, the age of which may be known to yourself, but we cannot say. 3. Not necessarily; in fact, queens often fly long distances for mating.

[3144.] *Allowing Bees to Transfer Themselves.*—Some time ago I wrote you about transferring a colony of bees from a bucket into a frame-hive. You advised me to place the

bucket on the frames and let the bees transfer themselves. I did as you advised, about a month ago, and to-day examined them for the first time. I find the bees have not yet even started work in the frames, although a lot of bees were clustered between them. I fitted the frames with quarter sheets of foundation. What can I do to make them go down into the frames? or would you advise me to let the bucket remain on till the end of the season, or can I drive them out of it, if so, when is the time to do it? If I leave the bucket on till the end of season and they do not go down I shall be as far off getting them out as ever. I want to get a little honey this year even if I have to feed them during the winter. Thanking you in anticipation of a reply in the BEE JOURNAL.—J. W. C., *Alder-shot, June 23.*

REPLY.—The transferring has no doubt been delayed by adverse weather. Now that honey is fairly plentiful, the combs will soon be built out and the brood nest transferred below. Under present conditions it will be best to leave the bucket on as a super, and remove at end of season.

[3145] *Deferred Swarming.*—I want to ask a question. I have the “Guide Book,” and have taken the B.B.J. for some time now, and am greatly indebted to you for such excellent and practical advice. As a novice, I have found the “Guide Book” exceedingly useful. The question I want an answer to is this. I bought my first stocks of bees (two) in February, 1902. They were hived in lard buckets. I had a swarm from each the same year in June. One I put in a “bucket,” for want of a proper hive, and the others in a skep. They have wintered very well, and, to judge from pollen-carrying, began breeding very early. After reading the “Guide Book” I made myself some frame-hives; and this spring, as the weather became warmer and food was coming in, I put them all on top of frame-hives, fitted with ten frames of wired foundations—full sheets. But on examining them Saturday, I found the two stocks had gone down and had nearly filled the buckets with honey and sealed it over, but there were brood still in the lower parts of the comb. The swarm of last year (that I hived in the bucket), which was the last I put on frame-hive, had a queen-cell with the end torn open, and was empty. This hive is the only one that shows any drone-brood in comb as yet, and that only this last week; but this morning I see a lot of immature drones cast out in front of hive, and they are still being thrown out. The bees have plenty of sealed food—in fact, the bucket is more than half full of sealed honey, and they have three or four of the frames of comb drawn out and are teeming with bees. I therefore ask, What is the meaning of queen-cell being there, with so much room below? Also, why are they casting out drones? I may say we have been having it wet for this

last three or four days, and they have had no chance to get out much.—R. LITMAN, *Castle Cary*.

REPLY.—The torn-down cell may simply indicate deferred swarming, owing to adverse weather. When this occurs bees will often destroy queen-cells and build others later on, when weather improves.

[3146.] *Bees and Brood Cast Out of Hives*.—I should be much obliged for a line of advice in the following circumstances:—We had continuous rain last Saturday, Sunday, and Monday. On Sunday I noticed in front of two of my hives a lot of bees, chiefly lying on their backs, either dead or in a half torpid state. I brought them into the house, and after being warmed, about half of them revived and flew back to the hive. I then began to feed the bees with syrup, thinking that food must be getting short. On Tuesday it was not raining, and the bees again began to carry out corpses and half dead bees. They have been doing so ever since, and altogether have carried out probably 1,000 to 1,500 bees, including some partly developed brood. Both hives referred to were stocks which I had transferred from skeps some weeks ago. They are well covered on top with quilts, but the hive is single walled. I have two other hives—two skeps. Dead bees have been cast out of both the last-named frame-hives, but to a smaller extent, and the strongest hive also turned out a few drones. The last is very strong indeed, and warmly packed with cork dust and quilts. The skeps turned out very little of either brood or bees.—A BEGINNER, *Camberley*.

REPLY.—The trouble complained of is, no doubt, caused by adverse weather and the stoppage of honey income. At such times, not only is immature brood cast out for lack of daily supplies, but young bees just hatched also become the victims of impending famine. All will go on right again, no doubt, now that the weather has improved. But it was injudicious on your part to transfer bees in such adverse weather as has been prevalent all through the early part of the present summer.

[3147.] *Introducing Queens to Alien Bees*.—Will you kindly tell me what is wrong with the enclosed comb? I may explain that some time ago I sent for three queens, and they arrived on Monday, the 8th, but owing to bad weather I could not make the artificial swarms, for which they were intended, until Wednesday, the 10th. The queens came in small wooden boxes, and I introduced them by shaking bees off the frames, sprinkling them with flour, and dropping queen in among them as they again ran into the hive. The bees were carefully shaken off the combs, any that stuck being brushed off with a wing. Do you think the grubs have been killed by my shaking too hard, or is it a case of disease? I have looked at the other frames and cannot see anything wrong, and the hive

I took the comb from is a very strong stock, nor can I see anything wrong with any combs there. An answer in B.B.J. will greatly oblige. I send name for reference while signing—"ANXIOUS," *Shanklin, Isle of Wight*.

REPLY.—We find nothing wrong with sample of comb, which is mainly drone-comb never bred in and containing no trace of brood at present. We should be glad to hear how your artificial swarms are progressing, and will be agreeably surprised if they are doing well under the adverse conditions prevailing when swarms were made.

[3148] *Delayed Swarming*.—I have got one hive of bees (a first swarm of July, 1902), and have been looking forward to it sending out a swarm this season in good time, as there was every sign of this taking place before now. Thinking it possible that the swarm had issued unobserved and without my knowledge, I had the frames examined (except two end ones), and could find no trace of queen or queen-cells. There were, however, lots of drone-cells. Owing to my inexperience I may have let a queen-cell pass unnoticed. I have Cowan's "Guide Book," and from it think it must be quite easy to distinguish queen-cells. The stock is strong and healthy, having been fed all winter, and has lots of food.—T. JOHNSON, *Kilchattan Bay*.

REPLY.—If no queen-cells or traces of such were left in the hive, it is certain that no swarm has issued. On the other hand, it is more than likely that the adverse weather has delayed swarming.

## Echoes from the Hives.

*Chipperfield, Kings Langley, Herts, June 29*.—After a fortnight of cold winds and saturating rains we have had eight days of delightful bee weather here in West Herts. My eleven stocks of bees came through the winter safely. I began feeding with flour candy at the end of February, then with syrup till May 21. When I put supers on the bees took possession, but stored very little honey until the 29th, when they worked on the white-thorn and holly, which bloomed freely here. Then followed a fortnight's bad weather, and bees were almost idle, with fields of forage all around. A change for the better then came, and my bees have been making up for lost time. Never during my seven years' experience have I seen anything to equal it. I lifted the first racks and placed another below each on the 23rd. On the 25th I gave them a third, the other two being filled with honey, although not sealed. On Saturday last (the 27th) I put on a fourth rack on some of the strongest lots. In order to account for this I may say my bees have quite 120 acres of the sainfoin within a mile of the hives, with fields of wild mustard. So if the fine weather con-



times I shall have nothing to grumble about this season. This should teach bee-keepers never to lose heart.—H. SIMMONDS.

*Exeter, June 23.*—Here in the West of England we are having a great deal of rain, but are now hoping for better times for the bees. I have one "W. B. C." hive stocked with Italians, which has now two brood-chambers and two boxes of shallow-frames on, the latter being nearly full. A swarm came off on June 12, and the bees entered the "Edwards' Swarm Catcher" nicely, and remained till hived. I consider it a really good invention as answering the purpose admirably, without obstructing the work of the bees in the least. The past winter has been a disastrous one for the bees; nearly every bee-keeper about here has lost several hives.—A. SYMES PARRISH.

## Bees Shows to Come.

*A nominal charge of 2s. 6d. is made for notices in this column, which covers cost of insertion from order till date of show. Cash should accompany orders for insertion.*

**July 15 and 16, at Lichfield.**—Annual Bee and Honey Show of the Staffs B.K.A. Open Classes for Comb and Extracted Honey and Appliances. Entries closed.

**July 16 and 17, at Lincoln.**—Honey, Hives, and Bee Appliances, in connection with the annual show of the Lincolnshire Agricultural Society. Bee department under the management of the Lincs B.K.A. Entries closed.

**July 22, at Broughton Hants.**—Fruit, Flower, Vegetable, and Honey Show. Twentieth year. Liberal prizes, with silver cup, valued £15, open to the United Kingdom. Particulars from Fred. J. Hinwood, Broughton, Stockbridge, Hants. Entries close July 18.

**July 22 and 23, at Cardiff.**—Honey show of the Glamorgan B.K.A., in connection with the Cardiff and County Horticultural Society. Bees, hives, honey, trophies, wax, appliances, and articles of food. Substantial money prizes and medals. Free entries. Six open classes. Schedules from William Richards, Gabalfa, Cardiff. Entries close July 16.

**July 29, at Wallow, Hants.**—Honey Show of the Broughton and Wallow Branch of the Hants and Isle of Wight Bee-keepers' Association. Two open classes for single-section and 1-lb. jar respectively (entry free). Schedules from Miss Tucker, The Lindens, Broughton, Stockbridge, Hants. Entries close July 22.

**July 29, at Henbury, near Bristol.**—Annual Show of the Henbury District Bee-keepers' Association in connection with the Horticultural Society's Exhibition. Several open classes with good prizes (two classes with free entry). Schedules from I. Atkin Waller, hon. sec., Pen Park, Westbury-on-Trym, near Bristol. Entries close July 24.

**July 30, 31, and August 1 and 3 at Old Trafford, Manchester.**—Annual Show of the Royal Lancashire Agricultural Society. Liberal money-prizes are offered for honey along with silver and bronze medals of the B.B.K.A. and also of the Society. Open classes for Honey-Trophy, Sections, Extracted Honey, Beeswax, Honey-Confectionery, Bee Flowers, Instructive Exhibits in Bee-Culture, &c. Schedules from Edward Bohane, Secretary, Miller-arcade, Preston. Entries close July 7.

**August 3 (Bank Holiday), in the Walled Meadow, Andover.**—Honey Show in connection with the Andover and District Horticultural Society. Class for single 1-lb. jar of extracted honey (with no entry fee). Also classes for sections, extracted honey (light and dark), and beeswax. Schedules from the Hon. Sec., Dr. Gillett, Elvin House, Andover. Entries close July 28.

**August 4, at Leamington.**—Tenth annual show of the Leamington St. Mary's Horticultural Society. Three open classes for Six 1-lb. Sections, Six 1-lb. Jars "Light," and Six 1-lb. Jars "Dark." Extracted Honey, respectively. Liberal money prizes. Schedules from P. W. Smith, Secretary, 22, Leam-street, Leamington. Entries close July 30.

**August 6, at Nantwich.**—Honey department of the Cheshire Agricultural Society's Show under the management of the C.B.K.A. Numerous classes for hives, honey, and wax. Money prizes and medals. Schedules from T. A. Beckett, St. Werburgh's Chambers, Chester. Entries close July 16. At double fees July 23.

**August 6, at Kingsthorpe, Northants.**—Honey show of the Northants B.K.A., in connection with the Horticultural Society's Exhibition. Three open classes with special prizes, including one for single 1-lb. jar of honey. (Entry free.) Prizes 20s., 10s., 7s. 6d., and 2s. 6d. Schedules from R. Hefford, Hon. Sec., Sunnyside, Kingsthorpe, Northampton. Entries close August 1.

**August 12, at Radstock, Bath.**—Honey show in connection with the annual show of the Radstock and District Horticultural and Fanciers' Association. Schedules from the Secretary, B. M. Clark, 1, Fox Hills, Radstock, Bath.

**August 12, in Swanmore Park, Bishop's Waltham.**—Honey Show of the Swanmore Branch, Hants and Isle of Wight B.K.A., in connection with the Bishop's Waltham Horticultural Society. Local Classes for Comb and Extracted Honey, Honey Trophy, &c., and Classes for Sections and Extracted Honey Open to Members of the County B.K.A. Schedules from Miss Martion, Secretary, Swanmore, Bishop's Waltham.

**August 12, at Wye.**—East Kent Honey Show. Open Class for Single 1-lb. Jar Extracted Honey with no Entry fee. Prizes—1st, £1; 2nd, 10s.; 3rd, 5s. Schedules from Secretary, J. Tippen, Wye, Ashford, Kent.

**August 19, in the Great Western Park, New Swindon.**—Wilts B.K.A. County Show of Bees, Honey, &c. Fifteen classes in all, five open to all England. Schedules from the Hon. Sec., W. E. Burkitt, Buttermere Rectory, Hungerford, or from local Hon. Sec., S. W. Filtness, Market House, Marlborough-road, Swindon. Entries close August 10.

**August 22, at Hawkshead, Lancashire.**—Honey show in connection with the Hawkshead Horticultural Society. Open classes for Six 1-lb. Sections and Six 1-lb. Jars (medium or dark) Extracted Honey. Prizes 10s., 6s., and 4s., and medals of the L.B.K.A. Schedules from Dr. Allen, Hawkshead, Lancs. Entries close August 15.

**August 25, at Cartmel, Lancashire.**—Honey show in connection with the Cartmel Agricultural Society. Open classes for sections, extracted honey, and beeswax. Local classes for sections and extracted honey. Schedules from Wm. Cragg, Secretary, Cartmel, via Carnforth.—Entries close August 13.

**August 26, at Reading.**—Honey Show of the Berks B.K.A., in conjunction with the Annual Exhibition of the Reading Horticultural Society. Open classes for comb honey in sections and for extracted honey. Local classes include prizes of 20s., 15s., 10s., and 5s. for honey trophy. Also classes for owners of small apiaries. Schedules from D. W. Bishop-Ackerman, Hon. Sec. Berks B.K.A., 131, King's-road, Reading.

**August 27, at Llangollen.**—In connection with the fifth annual Flower Show. Open classes for Six 1-lb. Sections, Six 1-lb. Bottles Extracted Honey, and Beeswax. Schedules from Frank Little, Castle-street, Llangollen. Entries close August 13.

**August 27, at Montgomery.** in connection with Montgomery and District Horticultural Show. Open classes for Six 1-lb. Sections and Six 1-lb. Jars, Extracted honey. Prizes in each class 10s., 5s., 2s. 6d. Entrance-fee 1s. each. Schedules from W. J. Jones, Secretary, Montgomery. Entries close August 20.

**September 17, 18, and 19, at Crystal Palace, Surrey.** B.K.A. Annual Exhibition of Bees, Honey, Wax, and Appliances, &c. Further particulars and schedules readily shortly from F. B. White, Secretary, Marden House, Redhill, Surrey.

**September 19, to 26 at the Agricultural Hall, London.**—Honey Show in connection with the

seventh Annual Exhibition and Market of the Grocery and Kindred Trades. Numerous classes and liberal prizes for comb and extracted honey and beeswax. Open to all British Bee-keepers. Special attention is directed to the new Honey-selling Classes with free entry. Schedules from H. S. Rogers, Secretary, Exhibition Offices, Palmerston House, Old Broad-street, London, E.C.

### Notices to Correspondents & Inquirers.

"SUFFOLK" (Eye).—*A Beginner's Difficulties*.—You can never hope to succeed with bees without either some personal guidance or the help of a text-book wherein the learner is shown what to do and how to do it. The hiving of your first swarm is a case in point. Even a beginner should know that if the top-bars of frames are not covered down so as to keep the bees below it is almost certain that they will ascend to the highest point of roof and start comb-building there as yours did. The bees must be got out of the roof by "driving"—a simple enough operation for an expert, but for a beginner unacquainted with the most elementary bee-operations it is not easy to give the *modus operandi* in this column. We are glad to hear that you are a member of the County Association, and we know the Hon. Sec. well enough to say if you ask for help it will be gladly given. The "dark spots" in the new pieces of comb cut from the hive-roof are simply cells half-filled with fresh-gathered pollen.

J. J. K. (Ware).—*Feeding Bees to get Sections Filled*.—We cannot advise as profitable the plan of giving bees extracted honey to get sections filled after the season's honey-flow is over. It works out better in theory than practice, and we should sell the honey at a low figure for preference, for it is more than probable that the bees would carry the honey below into the brood-nest, if weather was cool when feeding.

G. H. B. (St. George's, Salop).—Much obliged for Press report of your case, and glad you were successful in recovering value of the bees destroyed through faulty drain pipes. The report is, however, far too long for our columns.

F. P. C. E. (Rotherfield).—*Enamelling Honey Extractors*.—It can do no possible harm to enamel the outside of your extractor as proposed.

J. R. (Middlesex).—*Risks of Infection*.—We should not deem it absolutely necessary to "confine and starve a natural swarm from a stock slightly affected with foul brood." With regard to surplus-chambers taken from same stock, it might be safer to spray the partly built combs with a disinfectant, though the risk cannot be great under the circumstances named.

E. B. (Wilmslow, Cheshire).—*Transferring Bees to Frame-hives*.—Set the skep above

top-bars of the frame-hive, and let the bees transfer themselves as directed on page 140 of "Guide Book."

W. L. (Kimbolton).—*Checking Swarming*.—The "3-in. or 4-in. space" you propose to allow below frames would certainly check swarming for a short time, but as the bees would extend their combs, and so fill the space with drone-combs built to bottom bars of frames, you would do more harm than good by the proposed plan.

B. E. B. (Bedford Park, W.).—*Honey Sample*.—The sample is fairly good in quality, but having been gathered last year, and "run from the combs in front of a fire," it makes us wonder why it is now so soft after granulating. The district, however, evidently yields very fair honey.

W. BLACK (Cockermouth).—*Queens Duplicating Eggs*.—The slow progress made by the stock, and the fact of the few eggs being laid irregularly and more than one in a cell, bear out the appearance of dead queen sent, viz., that of being old and worn out.

F. K. (Horsham).—*Damaged Queen*.—The dead queen sent has by some mischance been ruptured, and would never have been of any use to the colony.

#### *Suspected Combs.*

MISS COOK (Surrey).—Sample shows a decided case of foul brood, but with "six full combs of brood all looking healthy," and bees "very strong in numbers," we should let them go on working till the honey season closes before starting them in a new hive as a swarm. By so doing the healthy brood will have hatched out, and help to build up the colony after the combs they are now on are destroyed.

E. F. B. (Colchester).—Brood is "chilled" only. We find no disease in comb, but the fact of worker bees being few in number, and drones plentiful, makes it certain that whether a worn-out queen or a fertile worker heads the stock it is worthless, and had better be destroyed.

O. P. (Winchmore Hill).—Brood in comb is chilled. No disease at all.

T. B. (Hereford).—We find no trace of brood at all in comb, but sample is a poor one for judging from. We ought to have brood in some tangible form for examination. Sealed cells in which brood has been so long dead that all trace of it has gone is quite unsuitable for the purpose of diagnosing disease.

"BEE MAN" (co. Down).—Bad case of foul brood.

E. G. L. (Co. Down).—There is foul brood in comb, but not a bad case. When writing, please address "Editor, B.B.J."

\* \* \* *Some Letters and Queries are unavoidably held over till next week.*

## Editorial, Notices, &c.

### THE SHOW AT PARK ROYAL.

(Continued from page 262.)

#### THE HONEY CLASSES.

The few remarks we made last week on the changed conditions of the "Royal" Show of 1903 apply with equal force to the honey classes. In this section the plan of grouping the counties had its first trial, and in working out this change a considerable extension of the prize list was inevitable. Nine groups—or divisions—were arranged for, with four classes in each group; and in this way thirty-six classes had to be provided for, as against ten in former years.

Unfortunately, the new arrangement came into force in a year when honey is so scarce that, had it not been for the new rule which makes honey of any year eligible, no display at all would have been possible. But notwithstanding all the various difficulties, past and present, a very nice, if small, display of honey was staged. To enter closely into details would serve no useful purpose; therefore we simply offer our congratulations to those who had the forethought to keep back a portion of their harvest and carry off prizes for it of sufficient value to recompense them well for the trouble taken. Had others been equally enterprising, fewer prizes would have been withheld for lack of competition.

It is satisfactory to no one to see a slack competition, and that this was the case may be judged from the fact of two exhibitors carrying off all the prizes in the four classes confined to Wales; while in one group, comprising six counties, Mr. R. Brown, Somersham, took the whole four first prizes.

The Honey Trophy Class produced only three entries, Mr. Woodley's 1st-prize one being an exceedingly good display of sections of last year's honey, along with extracted honey, wax, &c., very tastefully arranged. So well was the comb-honey preserved that it presented a useful lesson to those not up in the art of knowing how to keep honey. Mr. Brown's 2nd-prize trophy was also a very good one, and had the unexpected merit of being all honey of the present season's gathering—a fact that, no doubt, caused much surprise. It showed, however, what an energetic and practical bee-man can do "if he tries," and it was on that account worthy of all the praise bestowed on it.

Mr. Baldwin's trophy, which was awarded a 3rd, was of a different class, being mainly honeycomb designs worked by the bees—very interesting, no doubt, but hardly a "Honey Trophy" in the full sense of the term.

The adage *verbum sap.* will, we hope, be taken to heart by those who have a good harvest to report for 1903, so that next year's show at Park Royal will not see prizes for honey going a-begging.

The wax classes were well filled, some excellent samples being staged, and the winning exhibits were all good.

Honey vinegar and mead produced fifteen entries in all, but, apart from the winning samples, there was a falling off in merit.

The two remaining classes, for exhibits of a "practical" and "scientific" nature respectively, were disappointing. Only one prize was awarded in each class, that which included articles of food going to Mr. J. Gray for a curiously named exhibit of "Honey Shells," these being small portions of granulated honey put up in a shell-like receptacle made from biscuit-flour for table use at home or at restaurants. In the scientific class Mr. F. W. L. Sladen took 1st with an interesting little exhibit of comb-cappings showing the damage done to the surface of capped sections by a minute parasite, the larva of which tunnels its way on and under the surface of the cappings in somewhat similar fashion to the wax-moth larva.

## Correspondence.

*The Editors do not hold themselves responsible for the opinions expressed by correspondents. No notice will be taken of anonymous communications, and correspondents are requested to write on one side of the paper only and give their real names and addresses, not necessarily for publication, but as a guarantee of good faith. Illustrations should be drawn on separate pieces of paper. We do not undertake to return rejected communications.*

### NOTES BY THE WAY.

[5160.] We have now had a fortnight of good bee-weather. Ever since the longest day passed the sun and warmth has cheered the hearts of both bee-keeper and farmer, the one with a honey-flow and a grand swarming time, and the latter with a splendid time for the hay harvest. Some of our farmer friends have carried their crop without a drop of rain; others who were early in cutting have had it washed. The patient, hopeful man has again scored, and so in the apitary the painstaking bee-man has had, and got both swarms and honey in return for the labour and expense of continuous feeding so long as required. For myself, I fed liberally, but when the spell of bee-weather came I wished I had been even more liberal with the syrup-feeder, so that breeding might have gone on still more rapidly. It would have paid well to do so. Others have, no doubt, noted the same fact, viz., that those stocks which received best attention have given best returns.

*Rearing Queens.*—For those in the southern part of the kingdom I would commend the note of Mr. "D. M. M." in B. J. of June 18 (page 242) re queens in August to carry out the instructions there given during the first fortnight in July. The bulk of our drones are killed off before August in the south, generally the last ten days in July.

If stocks are kept queenless, of course.

drones can be secured till later in the year, but I always prefer things done in due season. Rather let us assist Nature than expect to force the old dame. On the other hand, the date "D. M. M." mentions may be just the best time in North Britain.

*Wax Moths.*—Wherever these pests have got a footing care should be taken to kill every moth and larva wherever seen. Only continued vigilance will bring success in keeping them down. The moths range in colour from light fawn to a darker grey, and are very active. I have found larvæ under the edge of carpet quilts covering the sections, and on, under, and between the ends of frames, and as the larvæ hatch out the resulting moths will get into the corners of hive-covers. Therefore, if a sharp look-out is not kept they will escape observation, their colour being so much like that of the wood. On turning up a strong skep the other day I found several cocoons on both sides of the entrance at the edge of hive, resting on the wood. This gave me the cue, and other straw skeps were soon examined with the carbolised cloth, and moths or larvæ destroyed wherever found.

*Marketing the Crop.*—This will be our next job; and what of the price? The season cannot be so good as usual, therefore the crop must be a light one. I was glad to hear friend R. Brown, of Somersham, made a good price of his sections at the "Royal" Show—15s. per dozen, I heard—1s. 3d. each. I hope those who are fortunate enough to get a good "take" will not sacrifice it this year at low prices. All the old honey was practically cleared out, therefore I feel we ought to make a fair price for our new section honey. In working for extracted honey we have more or less to compete with the world at large as regards prices. The foreign honey from some parts may be, and I have no doubt is, put up cleaner and better than it was fifteen or twenty years ago, consequently it brings a better price to the producer, and the foreign product is a more formidable rival to the home producer than formerly; but the fragile nature of comb-honey precludes the export of the commodity, and from being placed on the market.

*Honey Jars.*—The size of honey jars requires attention. Perhaps those who are able to obtain jars to hold  $\frac{1}{2}$  lb. or  $\frac{1}{4}$  lb. will give their brethren in the craft the maker's or dealer's name in the B.B.J., so that we may all secure this much-to-be-desired jar, and the enterprising firm receive the orders of bee-keepers generally.—W. WOODLEY, *Beeton, Newbury.*

#### AN OBSERVATION.

[5161.] Some time ago a few remarks appeared in your columns as to the cause of the excited movements of single bees in an observatory hive. I had frequently noticed the same thing in my Lee's three-frame observatory hive; and, like your contributor,

had been much puzzled at the cause or object of the same, but had finally put it down to the fact that probably a particle of dirt or pollen had got into one of the delicate organs somewhere in the body of the bee, and that this was the means adopted to get rid of the obstacle. This theory was, however, I believe, shown to be a false one by an observation I made this week. I was sitting in my apiary at noon, on a very fine day, when I noticed a few bees alighting on a piece of comb-capping that lay at my feet. About a foot away from the piece of comb lay a dead bee, and all at once I noticed a bee dash itself down on top of the dead bee in a most excited manner, rushing round about it and shaking itself like a terrier shaking the water off its coat after just coming out from a swim, and in fact performing exactly the same motions as those I had observed in the observatory hive. I also noticed that as soon as the bee in its excitement moved away from the dead bee, the motions stopped at once, but as soon as it returned, which it did several times, the same performance took place.

In the case of the observatory hive the motions take place in the middle of the cluster of bees; here it took place over a single bee. Can it be that the object of the motions was to attract the attention of the dead bee, and those in the hive to attract the attention of a bee there; yet why should it wish to attract their attention? Again is the bee it wishes to attract in the observatory hive a dead or dying bee that has not yet fallen from the comb? Or is it possible that this is the way in which the bee expresses its emotions of pleasure at meeting with a particular friend, or of sorrow at the death of one, perhaps the nurse bee that first gave it food? Yet again this cannot be the case or they would be more frequently observed.

The reasons for the motions are still to me a mystery, and I should be glad if any of your observant readers could throw a little more light on the matter.—"BRIDGEFIELD," *Maesybont, Llandebie, July 4.*

#### BEEES IN IRELAND.

[5162.] Here in Dublin the season has been an unusual and rather chequered one. East winds have been remarkably prevalent during "the clover month," and each day for several weeks a few drones were sacrificed by the ever-cautious bees. There has also been no real "glut" up to date. In spite of all efforts to prevent swarming, two stocks swarmed on June 29 and 30 respectively. Surplus has come in very slowly, and sections are consequently badly finished. Five of the racks on my four stocks are practically full of honey, but as yet lack proper sealing. This year, for the first time, I was the victim of brood in sections. I have always had a queen-excluder (celluloid) by me to use if I found it necessary, but till this year I have never needed it.

Indeed, I regard excluders as a great nuisance, for if attention is paid to the brood-nest before supering the queen will rarely ascend. In my own case, it was this very inattention to the wants "below stairs," in one hive only, that caused the trouble I complain of. It is difficult enough, at times, to get bees into supers without discouraging them and increasing their unwillingness by the use of that *bête noire*, the queen-excluder.

When I read of the misfortunes of bee-keepers whose apiaries are attacked by that arch-enemy of the bee, foul brood, I feel inexpressibly sorry for them. It must be most discouraging when everything seems to be going well to have one's efforts nullified in this way. As to myself, for the five years I have kept bees for amusement my stocks have been provisionally kept free from the disease. Whether it is my own endeavours or what men call "luck" that has preserved them I am not prepared to say. At the same time, I use habitually every precaution in my power to ward off the pest by not only medicating food, and so on, but by freely enlisting the services of the ordinary preventives in and about the hives and all accessories. There is one point, however, in connection with this black cloud in the bee-man's otherwise fair sky which is worth noting, and which may perhaps serve in some measure as a consolation to those whose apiaries are or have been afflicted with the scourge. Dr. A. W. Smyth, in an article in the June *I.B.J.*, says:—

"We know that the microbes causing foul brood retain their vitality in honey for some time, but just how long we do not know. That the spores of *Bacillus mesentericus* will germinate after being steeped in honey for over a year I have very great doubts, and if a few years' immersion in concentrated honey is fatal to them, we have a clue to the reason why bees store, and keep in store, large quantities of honey." Thus the point is simply this:—"If the microbes causing foul brood could be exterminated there would be no bee-keeping—the bees would not store honey enough to make it an object."—*"DUBLIN BEE," July 6.*

#### QUEENS MATING.

[5163.] I herewith send you a further contribution on the vagaries of the two young queens referred to in my letter of last week [5155, page 265]. On Saturday afternoon, June 27, two days after that experience, while in my accustomed place quite near the hive, I saw a queen come out and take flight, returning in a few seconds. She again came out and took flight three or four times, when I was called in to tea. On my return I again saw her take flight twice, making in all six times that I saw her fly at intervals, and the time she was away varying from a few seconds to several minutes. All doubt as to her own

hive seemed to have now entirely disappeared, as she entered with as much confidence as the other bees. I got so accustomed to seeing her flying that I should not have been much surprised had she returned laden with pollen. I have thus far only written of one queen, but I afterwards saw the other one return from a flight, and the way she entered the hive almost indicated that she had been acting like her sister all the afternoon; but my attention had been centred on the first queen that came and that hive alone, therefore I had not noticed the second queen. I thought my observations would end here, but next day (June 28), at 1.55, I saw queen leave and return in few seconds; she then must have left unseen, as at 2.25 saw her return. At 2.30 she left again, returning at 2.40. Here my observations end, for I have not seen either queen since. After this, I re-read part of "Guide Book," and found it stated that, "Usually in from three to five days after birth the young queen leaves the hive for fertilisation—ordinarily she never afterwards leaves the hive except when accompanying a first swarm." I hope our Editors will not say that neither of these queens was fertilised, because on that point I am quite certain. I knew what to look for if mating had taken place, and I saw it distinctly in both cases. I have no further remarks to make on foregoing facts, except that I think the "Guide Book" should read, "after commencing to lay," instead of "after fertilisation." I scarcely know whether you refer to me as "a beginner" in your footnote on page 265. If so, I may say that myself and five or six other bee-keepers met and formed the "Ulverston Apiarian Society" forty years ago, when bar-frames were just beginning to be talked about.—W. T. POSTLETHWAITE, *Sale, Cheshire.*

#### QUEEN'S OVIPOSITING.

##### EGG-CARRYING BY WORKERS.

[5164.] The following fact may possibly be of interest to readers of the *B.B.J.* While pointing out yesterday certain features of an observatory hive to a small class, I noticed the queen lying still on a piece of comb forming the back of a row of cells, attended by a few workers. The latter seemed restless and dissatisfied with the queen's proceedings, and at last one of them began to lick the dorsal surface of her abdomen. After a few seconds she deposited an egg which the worker carried about on its tongue, seeming rather disconcerted, and not knowing what to do with it eventually dropping it on to the comb, where it was soon stamped on by other workers. May not this proceeding possibly point to the fact that oviposition is due to some kind of reflex action produced by stimulation of the abdomen from contact with the bottom of the cell, though in this case, since there was no cell, the stimulus came from the tongue of the

worker?—M. D. HILL, M.A., F.Z.S., *Eton College, Windsor, July 3.*

#### TAKING BEES TO HEATHER.

[5165.] On reading the remarks of Mr. Rymer on taking enormous stocks to the heather in B.J. of July 2 (page 264), I thought I would send you a sketch of the ventilating floorboard I use, which explains itself. If possible, I remove all surplus a day or two before going to the heather, putting empty supers in the place of the full with a piece of scrim over top of sections. A few hours before starting I remove the quilts and open ventilator to get the hive cooled down as far as possible. In this manner I have taken enormous stocks thirteen miles on a lorry over roads that are not the best.—W. D. M., *Brechin, N.B., July 6.*

[We are obliged to our correspondent for sketch of his ventilating floorboard, which is, in principle, the same as Messrs. Lee & Son's "Scotch Heather Hive," for which they got first prize at two Scotch shows. It is therefore hardly worth incurring expense for blocks in order to show the admitted effectiveness of ample bottom ventilation—as shown in sketches—for securing the end in view.—EDS.]

#### PREPARING HIVES FOR THE HEATHER.

[5166.] It would be of much advantage just now if Messrs. "D. M. M., Banff," W. McNally, David Raitt, Jas. Waddell, and others within distance of the heather would kindly mention the various systems as carried out in their districts, especially as regards ventilation given to the bees for the journey. First with regard to ordinary hives—by bottom ventilation, entrance, or giving top ventilation over the supers by means of canvas, wire-net, or other material. Also whether both top and bottom ventilation are used together or only one? It would also be useful to have particulars of special heather-going hives arranged by the bee-keepers themselves, either with extra high entrances, or with ventilation holes cut in floorboards.

Referring to "Long Sections for Heather Honey," and in reply to Mr. J. Walker (5157, page 266), I have no doubt that the long sections as used by himself are made strong enough, but might not be considered so by another bee-keeper using the same. A further drawback, I think, is that the "building up" of the sections would detract from their appearance on the market. Nothing could be better than the long section, which he says Mr. David Raitt will supply, and which I did not know about. But the shallow-frames would not need to be cut down for the bees to fill them if "W.B.C." hanging-frame section-boxes were used, and, of course, these frames will also take the Raitt long section. —GEORGE M. SAUNDERS. *Keswick, July 4.*

#### CAMPHOR V. FOUL BROOD.

[5167.] Some few weeks ago I put one or two ordinary 1d. square lumps of camphor into a tin canister having a very tight-fitting lid, and on opening the latter the other day I found quite a quantity of little particles of camphor crystallised on and firmly adhering to the inside of the lid. I therefore put the following query:—Does camphor (like radium) keep on bombarding with its particles the interior of a closely-enclosing receptacle? And is it possible for camphor (although it may possibly be a weak germicide), by this continued action, so to impregnate the atmosphere, and also combs (in a ten-frame hive, say), as to cure foul brood? I am writing this with Mr. Cheshire's pamphlet on foul brood before me, and read therein (page 27), speaking of phenol, "that  $\frac{1}{100}$  despatched foul brood, even while honey was coming in." Now, what I should like to know is: If  $\frac{1}{100}$  only of phenol given in the bees' food is death to foul brood, what action would the continued presence, say, of two 1d. lumps of camphor in a ten-frame hive have over the healthy brood and working of the bees, and would it cure foul brood in such a hive? Has any one really tried it? I have read somewhere that bee-keepers in Russia put a lump of camphor in hives suffering from foul brood, "and the disease disappears." Does it? Who knows? And how big is the camphor lump used?—OLD CAMBS BEE-KEEPER.

#### HOMES OF THE HONEY BEE.

##### THE APIARIES OF OUR READERS.

It is satisfactory to find in Mr. Sheppard—whose apiary appears on next page—another reader who is in the fullest sense a good bee-keeper. His "record" shows this, for he not only makes his own hives, but secures satisfactory harvests, sells his honey well, takes prizes at shows, and keeps free from foul brood. For the rest, his interesting notes speak for themselves. He says:—

"I commenced bee-keeping in 1896 with a single straw skep, which swarmed that year, and in addition yielded surplus to the extent of a small straw super of honey. The swarm was hived by a bee-keeper, but the bees left their new domicile next day, and started off for 'fresh fields and pastures new.' We followed them for about a mile, when they halted, and after clustering well we hived them ourselves this time, and they settled down to work all right. The second year I made two wooden hives, called "Ivo" Cottagers," which I saw described in *Farm Field and Fireside*. The hives had bars on which to fix foundation, but I afterwards made frames instead of bars, in order to make the combs portable. The same year I heard of the county B.K.A., who were sending out experts to advise members, &c. This was just the thing I wanted, so I duly forwarded

my subscription, and all I got that year and next were the receipts for my money. In 1898 I bought a frame-hive, and subscribed to the *Bee-keepers' Record*, then later on to the *BRITISH BEE JOURNAL*; and to these two papers and the 'Guide Book' I owe all my knowledge of bee-keeping. The same year I secured a 2nd prize at the local flower-show, and also successfully transferred the bees and combs from two skeps into frame-hives. In 1899, after subscribing three years to the Association, I received a visit from the expert, who was, I believe, a disciple of Dr. Dickel. He also, in my absence, gave a rack of sections to one hive without using excluder-zinc between brood-chamber and section-rack; consequently when I expected to take off some sealed

two miles from here, there is some heather. I have on two occasions taken a hive to the heather there, but the bees failed to store any honey. I notice that most B.B.J. readers had a poor season in 1902, but I had no reason to complain, having taken two boxes of shallow-frames from each of my best stocks. I totalled up 146 lb. of extracted honey, thirty-six well-filled sections, and some others partly filled. Strange to say, my strongest stock gave me no surplus or profit of any kind last year. It swarmed on Coronation Day, and the swarm was safely hived in a skep prior to returning the bees to the parent hive in the evening; but when all was ready for this it was found that the swarm had decamped and was lost. The parent hive was also afterwards discovered to



MR. W. IVAN R. SHEPPARD'S APIARY, CHEWTON MENDIP, BATH, SOMERSET.

honey I found all the sections filled with brood and pollen, and I have never since supered a hive without excluder-zinc. I have been fairly successful on the show bench, for out of twenty-two entries I obtained in prizes eight 1st's, eight 2nd's, one reserve, one h.c., and two commends; only two of all my entries being unnoticed. At the Confectioners' Show, held in London in 1901, I secured 2nd prize for honey. I never manage to get very heavy 'tak's' of honey from one hive like some of your readers; 50 lb. to 60 lb. in a good year from strong stocks is the most I can do. We have little fruit-bloom here, though we have sycamores and hawthorn, but the bees seldom store in my supers until the white clover blooms. Then there are a few limes to finish with: while on the Mendip Hills, about

be queenless, so I united a driven lot with them.

I generally manage to dispose of my honey at 9d. to 1s. for 1-lb. screw-cap jars and glazed sections; but I only sell really good honey, and never take any from the brood-chambers. During the whole time I have kept frame-hives I have never had a swarm from one until last year, when the bees got the swarming fever, and it went on till the end of June. Then the weather improved, and the white clover began to blossom, and I was not troubled with a single swarm.

All the hives seen in the picture are my own make, except the one on the extreme left, which is a single-walled hive, as is also the adjoining one. The couple of small ones are "Ivo" Cottagers, and the other three are

double-walled hives on the 'W. B. C.' plan. The figures in photo are myself and two of my sisters, who are both bee enthusiasts, and can handle bees quite as well as I can, and glaze sections very much better. The hives are rather close together, but the floor-boards are painted of different colours, so there is never any confusion or robbing. Up to the present, I am glad to say, I have not had foul brood in any of my hives, and hope I never shall. I maintain the view that bee-keeping is the most pleasurable and interesting hobby any one can occupy themselves with, in addition to being a profitable occupation for one's leisure time. When I commenced bee-keeping one sting in the eye would close the latter up, but now they do not take any effect and never trouble me now."

## Queries and Replies.

[3149.] *Swarming Vagaries.*—I should be extremely grateful if you would kindly give me your views in B.B.J. re the peculiar swarming propensities of one of my stocks of bees, as illustrated in the following case:—A hive threw off a large swarm on May 29, which disappeared and was lost for two days, then discovered hanging in a neighbour's garden. This swarm I hived on eight frames, fitted with full sheets of foundation, and fed them continuously during subsequent bad weather. At commencement of present fine weather I put on a rack of sections, with queen-excluder below. On the morning of Sunday, June 23, this same swarm threw off another fairly large swarm, which, after clustering for about fifteen minutes, returned to its hive on the 30th. The bees again swarmed, and I hived them in a straw-skep, and they seemed to settle down, but in half an hour again returned to parent hive. To-day (July 2) they again swarmed twice, and, although very restless while clustering, they each time returned to parent hive.

I removed the zinc excluder on the 28th, thinking this might be an impediment to their occupying the rack of sections. This section rack contains several partly-combed sections left over from last year. I therefore ask:—Should I be right in placing a box of shallow-frames, with starters only, under body-box? Or would you attribute subsequent swarming to loss of queen on first attempt to swarm, on June 28? I examined the hive on June 28, and found seven frames contained brood nearly to top-bar of frame, also an empty queen-cell.

I must apologise for lengthy communication, while thanking you in anticipation of reply, as I am only a beginner.—W. A., *Woolston, Hants, July 2.*

REPLY.—If there were so many as seven combs filled with brood, and probably honey in remaining combs, it would seem as if the bees threw off what is popularly termed a

"virgin swarm"—doing this in preference to working in surplus-chamber. Your idea of queen being lost is hardly likely to be correct, but the best course is to ascertain for certain if there is a queen in the hive, and, if so, leave matters to adjust themselves, because the bees will, no doubt, enter sections now that honey is coming in, and the frames in body-box are fully occupied with brood and honey as stated.

[3150.] *Honey Samples: Coloured Glasses for Grading Honey.*—1. I am sending you a sample of honey. I should like to know about the quality and colour for show purposes. I had on June 18 a super of ten shallow frames, eight of which were nicely sealed over, of this honey. I have not had any dark honey from this place before. Can it be from the gorse blossom, as there is about 50 acres of it close by? The honey gathered here is generally from sainfoin and white clover, of good colour and flavour. 2. I should be thankful if you will let me know through the B.B.J. where to get the coloured glasses used for grading the colour of honey? We have a very backward season so far.—R. MORGAN, *Cowbridge, Glam, July 3.*

REPLY.—1. You are probably right with regard to source of honey sent. 2. The coloured glasses can only be had from the Secretary of the B.B.K.A., Mr. Edwin H. Young, 12, Hanover-square, London, price 6d. post free.

[3151.] *Beginners and Storifying for Surplus.*—Will you kindly reply to the following questions through your valuable journal, from which, as a beginner, I have received so much benefit? I had one strong stock in frame-hive last year, and from it got an early swarm which was duly put into a frame-hive and wintered well. I fed up according to "Guide Book" in the spring, as I proposed trying the storifying principle, and accordingly added another box of standard frames on top as a second story. The bees took to this, and quickly drew out the foundation into combs in which the queen soon started laying, so that almost the whole of the frames in second chamber contain healthy brood which has been hatching out very freely lately. As the brood hatches out, however, I find that on each frame there is a quantity of drone-brood in worker cells, besides drone-comb worked out and laid in and from which drones are hatching out; is this natural? and if not should I cut the drone-brood out? Do you think that the queen is a young unmated one or is she getting old and worn out? Also would it be best to requeen the stock now? And if so could I place an excluder between the two stories and requeen the top one, as it would be easier to find the queen in the top? Briefly then my queries may be enumerated thus:—1. Was I right in adding this storey and not putting excluder between? 2. Is it natural for the bees to draw out drone-cells on



worker-comb? if not should I be doing wrong if I cut these out and destroyed them? 3. As this was the first swarm would it be headed by the old queen or a young one? 4. Could I re-queen the top story with a new queen and retain the old queen in the bottom one, providing I had a sheet of excluder between? —B. J. E., *Whitstable, June 29.*

REPLY.—1. We fear you have not quite grasped the correct method of storifying. It is not intended to double the size of brood-chamber by giving a second tier of standard frames above the present body-box without excluder-zinc between, as this would inevitably tend to reduce the chance of surplus honey. 2. When bees are preparing to swarm, they will construct more or less drone-cells on worker-foundation. 3. The old queen always heads the first swarm. 4. Do not try this plan.

[3152.] *Bees Filling Brood Nest with Honey.*—What ought I to do with a stock that is rapidly filling up the nine brood combs with honey, so that I am afraid the queen will not have enough room to lay? The honey is not sealed over, but nearly all the cells near the top and sides of frames seem about half full. I put on a rack of sections about a fortnight ago, but the bees have not yet gone up into them. I am a regular reader of B.B.J. which I find most useful and interesting.—MERTON, *June 30.*

REPLY.—The fault probably lies in the lack of warm packing above and around the rack containing sections. If surplus chambers are made warm and snug for the bees, it is seldom they refuse to take possession, it being natural for bees to store over the brood. Add plenty of coverings and note the effect.

[3153.] *Transferring Combs and Bees from Skep to Frame Hive.*—I should be obliged if you would advise me, through the B.B.J., what to do in the following circumstances:—In the beginning of June I transferred a strong swarm from a skep, where they had been for a month. I drove the bees, cut out the combs, and tied them into eight frames with tape; then put the bees in the frame-hive, and thought I had done a smart thing. In about ten days I examined them, and found the whole eight frames were firmly fastened together with brace-comb, so that it was impossible to separate them without breaking combs and causing a lot of honey to run down on floorboard, and probably drowning many bees, and maybe attracting robbers. I immediately put in two full frames of foundation, which are now being drawn out very fast. I therefore ask:—1. Would it be advisable to take out the first-named eight frames now at all cost, and replace them by full sheets of foundation; or would you leave them as they are for the winter, and remove them in the spring, when there will be practically no honey? I suppose the reason of the comb being joined was that there was insufficient

room for the bees. 2. Is there any seed that could be sown now that would produce a honey-producing flower in the autumn, as I have a good bit of spare ground near my hives? It is, no doubt, needless to say that I am quite a beginner with bees.—SARNIA, *Guernsey.*

REPLY.—Yours is one more case showing the disadvantages of the old and worn-out method of transferring bees as described; for the rest we reply: 1. For the valid reason given we should defer removal of most of the cross-built combs till end of the honey season, but if two or three could be got out and replaced by sheets of foundation it would be helpful in preparing for winter. 2. No, it is too late now to sow for present year's bloom.

[3154.] *Queens Leaving Hives for a Flight.*—Will you please answer me the following in the B.B.J.? On looking at my hives on Saturday, June 27, at about 12.30, I noticed the queen on the alighting-board of one hive. I watched for a while and she returned to the hive. In the afternoon, about 5 o'clock, I saw her out again; she made no attempt to fly and the bees did not seem at all concerned about her; they went on with their work as usual. Some six or eight bees were "fanning" at the entrance for all they were worth. I opened the hive and put her in again. On Sunday, the 28th, I noticed her out again in the afternoon, and once more put her back. I have not seen her out to-day. I examined the hive, and all looked in a normal condition, so thought they may be going to swarm, but I could find no queen-cells. The stock is one I bought in March last in a straw skep, and put the latter on the top of ten frame-hives fitted with full sheets of foundation, as directed in "Guide Book." Now that the warm weather has come and bees are working well, please say: 1. What was the cause of queen coming out? 2. Did I do right to put her back again? 3. Will the stock be all right and does this often occur? I send name, &c., and sign myself—"PUZZLED," *Huddersfield, June 29.*

REPLY.—1. It is not possible to account for these occasional flights of queens beyond applying the truism that "bees do nothing invariably." 2. Quite right. 3. Most likely yes. These are rare "happenings."

[3155.] *Using Suspected Appliances.*—I have maintained a weary struggle with foul brood for the last seven years with varying success. I think you will sympathise. I write now to ask your opinion on the use of supers that have been removed from foul-broody hives, in the four following cases:—(1) Supers removed before the spore stage, the bees *not* having worked in them; (2) at the same stage, the bees having occupied them; (3) after spore stage, bees *not* having worked in them; (4) the same stage, the bees *having* occupied them? I shall be grateful if you advise a constant and much interested

reader. "F. B." is very bad four or five miles from here.—DEVONIENSIS, *S. Devon, June 30.*

REPLY.—1, 2, and 3. If combs are sprayed with a solution of phenyle or of Izal they will be practically safe to use. 4. The risk here is more pronounced, so if combs are not of much account we would melt them down for wax.

[3156.] *Wintering Bees.*—As a reader of the B.B.J., and an amateur at bee-keeping, would you let me know if I am right in discarding syrup altogether, and feeding only on soft candy. I object to syrup as being messy, and find that all my stocks lived through last

winter, and were supplied only with soft candy. The candy I make myself, putting about 1 lb. of honey to 6 lb. of sugar and pea-flour when pollen is needed by the bees. Some stocks I had took a 1 lb. cake of candy in a week, others considerably less, but all came through winter good and strong. Is syrup too watery a food, and does it produce diarrhoea? Is not well-made soft candy more like a bee's natural food?—J. R., *Ganton, July 1.*

REPLY.—Candy, though best for winter use to supplement a short supply, is not safe as the sole resource of food to bees. Apart from honey, good syrup-food is far best as the main supply.

## NOVELTIES FOR 1903.

A NEW HONEY JAR.



ACTUAL SIZE (details of design not shown). To hold 1-lb. honey only.

We have, so far, been favoured with but few "novelties" for the present year, and unless something is held in reserve for the earlier shows, in order to have its value appraised by the judges, it would seem as if 1903 is not to be prolific in regard to new or novel bee-appliances.

Messrs. Abbott Bros., of Southall, have sent us the above illustration of a glass honey-jar

(showing the *actual size*) which, to say the least, is new in design and shape, and for which the following advantages are claimed:—  
 "1. Novel in shape, and attracts notice. 2. Strong, easily packed and cleaned. 3. Bright glass, making honey look bright and clear. 4. Perfection for table use, contents easily got at, spoon always clean and handy."

Samples, 6d. each post free. Prices and particulars on application to the firm.

[3157.] *Returning Swarms and Casts.*—I do not want increase of stocks, and two of my hives have swarmed, the first on June 21. I removed all queen-cells but two, and then returned the swarm, first removing the old queen—hatched in 1901. Up to date of writing (July 5), though fifteen days have passed, there has been no sign of a "cast" from them, nor do I want one. The second hive swarmed on June 27. In this case I again removed (as I thought) all the queen cells but two, and returned the swarm minus the old queen. I killed her. Six days after (on July 3) they came out again ("cast") but after a short time returned. On examination of the hive I found the largest of the queen-cells I had left empty, but there were some half dozen others all sealed. I removed them, saying to myself: "There must of necessity be a young queen here. 1. Was my reasoning correct? 2. Why were sealed queen-cells still in the hive? One of the first things the newly-hatched queen does is to destroy her possible rivals. I have repeatedly returned swarms as above, but this is my first cast.—W. C. H., *South Devon, July 5.*

REPLY.—1. Yes. 2. The impulse of the first hatched queen is as you suppose, but the bees protect the still unhatched princesses from her fury, and this is why "piping" is heard before the second swarm issues. The young queen heads the latter, and then follows the fight for supremacy among the others.

[3158.] *Beginners and Removing Queen Cells*—I notice in your paper the readiness and simplicity with which you answer questions. I therefore as a beginner take courage to ask the following ones, however foolish they may appear to the more experienced. On June 28 I had a swarm, and upon cutting out all the queen-cells in the old stock I returned the swarm, and as the bees entered the hive I saw and killed the old queen; this I did to make sure of their having or raising a young one for next year. 1. Was there likely to have been a young queen in the hive? 2. Yesterday, the 4th inst., I found the enclosed dead drone on the alighting-board. Does that indicate the fructification of a queen? 3. Would you also kindly tell me if when a queenless stock raises queen-cells, and one hatches out, it sends off a swarm? 4. When the other queen-cells become ripe for hatching ought all cells in such a stock to be cut out except one?—G. H. F., *Kent, July 5.*

REPLY.—1. There would be young queens hatching when the top swarm issued, but none would reach maturity for eight or nine days unless the conditions were abnormal from some cause. 2. Not necessarily, nor could we judge with regard to drone sent, as it was flattened out of all recognition in post. 3. Not as a usual thing, though it may at times. 4. If the operator is experienced, one fully ripe cell only need be left, but it needs practice to judge of this.

## Bee Shows to Come.

*A nominal charge of 2s. 6d. is made for notices in this column, which covers cost of insertion from order till date of show. Cash should accompany orders for insertion.*

**July 15 and 16, at Lichfield.**—Annual Bee and Honey Show of the Staffs B.K.A. Open Classes for Comb and Extracted Honey and Appliances. Entries closed.

**July 16 and 17, at Lincoln.**—Honey, Hives, and Bee Appliances, in connection with the annual show of the Lincolnshire Agricultural Society. Bee department under the management of the Lincs B.K.A. Entries closed.

**July 22, at Broughton, Hants.**—Fruit, Flower, Vegetable, and Honey Show. Twentieth year. Liberal prizes, with silver cup, valued £15, open to the United Kingdom. Particulars from Fred. J. Hinwood, Broughton, Stockbridge, Hants. Entries close July 18.

**July 22 and 23, at Cardiff.**—Honey show of the Glamorgan B.K.A., in connection with the Cardiff and County Horticultural Society. Bees, hives, honey, trophies, wax, appliances, and articles of food. Substantial money prizes and medals. Free entries. Six open classes. Schedules from William Richards, Gabalfa, Cardiff. Entries close July 16.

**July 29, at Wallop, Hants.**—Honey Show of the Broughton and Wallop Branch of the Hants and Isle of Wight Bee-keepers' Association. Two open classes for single-section and 1-lb. jar respectively (entry free). Schedules from Miss Tucker, The Lindens, Broughton, Stockbridge, Hants. Entries close July 22.

**July 29, at Henbury, near Bristol.**—Annual Show of the Henbury District Bee-keepers' Association in connection with the Horticultural Society's Exhibition. Several open classes with good prizes (two classes with free entry). Schedules from I. Atkin Waller, hon. sec., Pen Park, Westbury-on-Trym, near Bristol. Entries close July 24.

**July 29, in Swanmore Park, Bishop's Waltham.**—Honey Show of the Swanmore Branch, Hants and Isle of Wight B.K.A., in connection with the Bishop's Waltham Horticultural Society. Local Classes for Comb and Extracted Honey, Honey Trophy, &c., and Classes for Sections and Extracted Honey Open to Members of the County B.K.A. Schedules from Miss Martin, Secretary, Swanmore, Bishop's Waltham.

**July 30, 31, and August 1 and 3 at Old Trafford, Manchester.**—Annual Show of the Royal Lancashire Agricultural Society. Liberal money-prizes are offered for honey along with silver and bronze medals of the B.B.K.A. and also of the Society. Open classes for Honey-Trophy, Sections, Extracted Honey, Beeswax, Honey-Confectionery, Bee Flowers, Instructive Exhibits in Bee-Culture, &c.

**August 3 (Bank Holiday), in the Walled Meadow, Andover.**—Honey Show in connection with the Andover and District Horticultural Society. Class for single 1-lb. jar of extracted honey (with no entry fee). Also classes for sections, extracted honey (light and dark), and beeswax. Schedules from the Hon. Sec., Dr. Gillett, Elvin House, Andover. Entries close July 28.

**August 4, at Leamington.**—Tenth annual show of the Leamington St. Mary's Horticultural Society. Three open classes for Six 1-lb. Sections, Six 1-lb. Jars "Light," and Six 1-lb. Jars "Dark." Extracted Honey, respectively. Liberal money prizes. Schedules from P. W. Smith, Secretary, 22, Leam-street, Leamington. Entries close July 30.

**August 6, at Nantwich.**—Honey department of the Cheshire Agricultural Society's Show under the management of the C.B.K.A. Numerous classes for hives, honey, and wax. Money prizes and medals. Schedules from T. A. Beckett, St. Werburgh's Chambers, Chester. Entries close July 16. At double fees July 23.

**August 6, at Kingsthorpe, Northants.**—Honey show of the Northants B.K.A., in connection with the Horticultural Society's Exhibition. Three open classes with special prizes, including one for single 1-lb. jar of honey. (Entry free.) Prizes 20s., 10s., 7s. 6d., and 2s. 6d. Schedules from E. Heford, Hon.

Sec., Sunnyside, Kingsthorpe, Northampton. Entries close August 1.

August 12, at Radstock, Bath.—Honey show in connection with the annual show of the Radstock and District Horticultural and Fanciers' Association. Schedules from the Secretary, B. M. Clark, 1, Fox Hills Radstock, Bath.

August 12, at Wye.—East Kent Honey Show. Open Class for Single 1-lb. Jar Extracted Honey with no Entry fee. Prizes—1st, £1; 2nd, 10s.; 3rd, 5s. Schedules from Secretary, J. Tippen, Wye, Ashford, Kent.

August 12, at Hardenhuish Park, Chippenham, Wilts. Honey show in connection with the Chippenham and District Horticultural Society. Ten local classes for bees, honey, and beeswax. Open class for honey trophy. Prizes 20s. and 10s. Schedules from Wm. Small, Secretary, Market-place, Chippenham.

August 12, in the Market Hall, Tavistock. Devon B.K.A. annual show of honey, wax, bees, and appliances, in conjunction with the Exhibition of the Tavistock Cottage Garden Society. Schedules from E. E. Scholefield, Heathfield, Chudleigh, S Devon. Entries close July 3.

August 19, in the Great Western Park, New Swindon.—Wilts B.K.A. County Show of Bees, Honey, &c. Fifteen classes in all, five open to all England. Schedules from the Hon. Sec., W. E. Burditt, Buttermere Rectory, Hungerford, or from local Hon. Sec., S. W. Filtness, Market House, Marlborough-road, Swindon. Entries close August 10.

August 22, at Hawkshead, Lancashire.—Honey show in connection with the Hawkshead Horticultural Society. Open classes for Six 1-lb. Sections and Six 1-lb. Jars (medium or dark) Extracted Honey. Prizes 10s., 6s., and 4s., and medals of the L.B.K.A. Schedules from Dr. Allen, Hawkshead, Lancs. Entries close August 15.

August 25, at Cartmel, Lancashire.—Honey show in connection with the Cartmel Agricultural Society. Open classes for sections, extracted honey, and beeswax. Local classes for sections and extracted honey. Schedules from Wm. Cragg, Secretary, Cartmel, via Carnforth.—Entries close August 13.

August 26, at Reading.—Honey Show of the Berks B.K.A., in conjunction with the Annual Exhibition of the Reading Horticultural Society. Open classes for comb honey in sections and for extracted honey. Local classes include prizes of 20s., 15s., 10s., and 5s. for honey trophy. Also classes for owners of small apiaries. Schedules from D. W. Bishop-Ackerman, Hon. Sec. Berks B.K.A., 131, King's-road, Reading.

August 27, at Llangollen.—In connection with the fifth annual Flower Show. Open classes for Six 1-lb. Sections, Six 1-lb. Bottles Extracted Honey, and Beeswax. Schedules from Frank Little, Castle-street, Llangollen. Entries close August 13.

August 27, at Montgomery, in connection with Montgomery and District Horticultural Show. Open classes for Six 1-lb. Sections and Six 1-lb. Jars. Extracted Honey. Prizes in each class 10s., 5s., 2s. 6d. Entrance-fee 1s. each. Schedules from W. J. Jones, Secretary, Montgomery. Entries close August 20.

September 17, 18, and 19, at Crystal Palace. Surrey, B.K.A. Annual Exhibition of Bees. Honey, Wax, and Appliances, &c. Twenty-four classes (ten open to all). Increased prizes and medals. Schedules from F. B. White, Secretary, Marden House, Redhill, Surrey. Entries must be made before September 1.

September 19 to 26, at the Agricultural Hall, London.—Honey Show in connection with the eleventh Annual Exhibition and Market of the Grocery and Kindred Trades. Numerous classes and liberal prizes for comb and extracted honey and beeswax. Open to all British Bee-keepers. Special attention is directed to the new Honey-selling Classes with free entry. Schedules from H. S. Rogers, Secretary, Exhibition Offices, Palmerston House, Old Broad-street, London, E.C.

### Notices to Correspondents & Inquirers.

ERRATUM.—In Prize List of "Royal" Show, Class 408 should read—"1st Prize, A. G. Preen, Nesscliffe, near Shrewsbury."

\*\*\* A correspondent informs us that a swarm of bees settled against an upper window of

the Swan Hotel in the High-street, Tewkesbury, and were safely hived from the top of a 40-ft. ladder.

A. H. W. (Birmingham).—*Rapid and Slow Feeders*.—Each of these appliances have a distinct and definite purpose. It is, therefore, neither "usual" nor advantageous to employ a rapid feeder for stimulating queens to lay in spring or autumn. On the other hand, the slow feeder is specially designed for stimulating brood raising, while the "Rapid" is for feeding up in autumn or for building up driven lots of bees late in the year.

CONSTANT READER (Hertford).—*Removing Bees from Trees*—If, as stated, the tree in which the bees are located is "dead" we should cut the top off just above the combs endeavouring to expose the comb-tops in so doing. You might then carry out your own proposal to "smoke or drive the bees" into an empty skep fixed above the combs. Should this be impracticable, the tree might again be cut through below the entrance used by the bees, and the whole removed to be dealt with afterwards by cutting out combs or locating the bees and tree in your apiary as a "novel bee-hive" such as was illustrated in our pages some time ago.

### Suspected Combs.

GEO. STBLEY (Hardington).—1. There is not a trace of brood in comb, foul or otherwise. It would seem to be a case of starvation and probable queenlessness if no trace of brood was seen in any of the combs. 2. The latter are so black and old—judged by sample—as to be unfit for using again for a swarm.

F. M. (Eastbourne).—Slight case of foul brood.

E. H. (Bognor).—Comb is badly affected with foul brood.

X. Y. Z. (Cornwall).—No. 1 sample contains bruised and chilled brood only. No disease. No. 2 is affected with foul brood of old standing.

F. N. (Andover). Foul brood is rapidly spreading in comb sent. The stock should be destroyed.

MERTON (London, E.C.).—1. The comb is slightly affected with foul brood, and as "queen is old and bees very weak" we advise total destruction without delay.

### Honey Sample.

F. ROSE (Farnborough).—Sample is by no means so bad as to be called "unsaleable," especially if kept till granulated. The flavour is not familiar to us, nor can we recognise its source, though it reminds us somewhat of *Trifolium incarnatum* or crimson clover.

\*\*\* Some Letters and Queries are unavoidably held over till next week.

## Editorial, Notices, &c.

### INSURANCE FOR BEE-KEEPERS.

The scheme of insurance for bee-keepers promoted by the British Bee-keepers' Association has passed its first year with satisfactory results to all concerned. Only one case came up for adjustment during the year, and that was promptly and satisfactorily settled. A new policy, covering the period between August 1, 1903, and August 1, 1904, has now been obtained, and premiums for risks under this policy have been payable since July 1. We therefore urge that no time be lost in forwarding the amount due for renewals, to the Secretaries of their respective Associations, from whom members not yet insured may obtain proposal forms. Non-members of county associations desirous of insuring may obtain particulars from Mr. Edwin H. Young, Sec. B.B.K.A., 12, Hanover-square, London.

It is expected that the number of hives insured will be doubled this year, and we sincerely hope this expectation will be realised. Indeed, there is no reason why 50,000 hives might not be covered, to the advantage of the bee industry as a whole.

### HONEY IMPORTS.

The value of honey imported into the United Kingdom during the month of June, 1903, was £5,732.—From a return furnished to the BRITISH BEE JOURNAL by the Statistical Office, H.M. Customs.

## Correspondence.

*The Editors do not hold themselves responsible for the opinions expressed by correspondents. No notice will be taken of anonymous communications, and correspondents are requested to write on one side of the paper only and give their real names and addresses, not necessarily for publication, but as a guarantee of good faith. Illustrations should be drawn on separate pieces of paper. We do not undertake to return rejected communications.*

*Communications relating to the literary department, reports of Associations, Shows, Meetings, Echoes, Queries, Books for Review, &c., must be addressed only to "The Editors of the British Bee Journal, 17, King William-street, Strand, London, W.C." All business communications relating to advertisements, &c., must be addressed to "THE MANAGER, 'British Bee Journal' Office, 17, King William-street, Strand, London, W.C."*

### AMONG THE BEES.

[5168.] *A June Frost.*—The severe frost which played such havoc on June 20, blackening potatoes, ruining most of our fruit crops, and even singeing the leaves and young growths of hardy trees, might have passed unrecorded in these pages, but that it seriously affected at least two plants affording forage to the bees. Broom blossom, which was uncommonly luxuriant this year, was completely destroyed,

and all the heads of white clover then in flower were thoroughly blasted. Although a new succession of bloom followed later, yet the effects gave a serious check to our bees at a critical time, when brood-raising was going on at high pressure in anticipation of preparations for swarming. In my experience such an occurrence is unique. Taken as a whole, June was far from being a good bee month, and mere dribbles came in on even the best days. Weather, a good part of the time, was not bad, but still there was a mysterious something in the atmosphere which checked the full flow of nectar necessary to create anything like a "boom." Here we are at the end of the first week in July with no swarms, no surplus gathered, and no great stores in brood-boxes. From the 8th onward white clover has been yielding well however, and weather shows evident signs of amendment.

*English Swarms.*—These reached us at a late date this year, being almost three weeks behind time, but since arrival they have been fed to keep them alive. One swarm arrived in a moribund state, owing to its taking forty-eight hours too long en route, as it lay over Sunday somewhere. So I am left with about half the bees and a queen whose powers of ovipositing were considerably impaired by the long period of enforced fasting. Swarm providers should take a note of this, and avoid such an occurrence by dispatching all orders having to travel long distances early in the week. Last year, and this season again, north men complain of careless and inefficient packing and consequent loss. A mild protest against such practices may do good.

*Strengthening Strong Stocks.*—I was much pleased on reading Colonel Walker's contribution on page 232. His emphatic recommendation of the very ingenious plan he there advocates to secure strong colonies deserves our thanks. The system is, I believe, very considerably practised in some parts of America, and is highly spoken of as a means of securing large takes in a honey-flow abundant while it lasts but of short duration. In this country it should answer the purpose admirably, especially when we are working for a late flow such as the heather. It is, though aiming at the same end, the antithesis of the Rymer method. The one is a swarming plan, the other non-swarming, yet they both aim at multiplying the number of bees, and, at the opening of the honey boom, if possible, throwing the full force to work under one roof in the same supers. Here, I contend, is the best means of filling our sections, even the despised 4½-in. Given colonies such as can be obtained by one or other of these methods, and I feel confident that the very finest work can be turned out both in bulk and finish. Such colonies would laugh (if bees can laugh) at finical hair-splitting fractions of an inch; and, if I were to attempt to prophesy, I would predict that they would show a decided preference for the thicker

comb in which to store all super honey. They are generally quick in appreciating anything to their advantage, and willingly accept any labour-saving appliances offered them. Here they have fewer cells to construct and fewer to seal over. The wider shallow-frames in surplus chambers were offered them on this principle, and, so far as I know, beemen who work for extracted honey favour their use, and deem them the best.

*A Breakdown.*—In living swarms I have never experienced any collapse of the foundation till lately. I name it now to prevent others falling into my error. I had lived a travelled swarm, placing the feeder over the quilt, and hurriedly, owing to a sudden call to other duties, poured in the syrup before it had cooled. The heat of the day, and the heat generated by the fed bees, combined with the over warm feeder, made the interior of the hive so uncomfortably warm that the foundation collapsed, making an ugly breakdown. I lost two days comb-building, my syrup was wasted, a good number of bees were crushed, and the interior thrown out of gear, all by an over-hurried and thoughtless act, thus proving the truth of the old proverb—"Most hurry; least speed."—D. M. M., *Banff*.

#### FORMALDEHYDE AND "FOUL BROOD."

[5169.] Though I have not had any practical experience with formaldehyde myself, but will shortly—my attention being drawn to it by what appears (according to *Gleanings*) to be the successful use of it by experts in the United States—the following may be of interest, considering the importance of the subject:—

Formic aldehyde (gas) is the active constituent of formalin. According to the *Century Dictionary* as follows:—

1. "A gas  $\text{CH}_2\text{O}$ . It can be obtained in several ways; as for example, by leading a mixture of vapour of methyl-alcohol  $\text{CH}_4\text{O}$ , and air over a heated platinum spiral. When dissolved in water [formalin] it is a powerful disinfectant."

2. "Aldehyde (al = alcohol de = deprived of hyd = hydrogen). A transparent colourless liquid produced by the oxidation of ordinary alcohol. When exposed to the air, or to oxygen is converted into acetic acid. Also a general name of a class of compounds intermediate between alcohols, and acids."

In America, spraying with its solutions has been found ineffective, and the successful means has been by vapourising with a lamp with the 40 per cent. saturated solution, and no mention is made of another way, but I find on inquiry that there is a better way of forming the gas, and that is by using dry formaldehyde tablets which are full strength, over a special lamp—a methylated spirit one—and the products of combustion coming over from

it, together with the water contained in them form, with the heated tablets, the gas. These dry tablets, and the lamps specially constructed to use with them, are patented; and The Formalin Hygienic Co., Ltd., 3, Lloyd's avenue, London, E.C., are sole licensees of Messrs. Schering, of Berlin. Their tin-plate lamps, with fifty tablets, cost 9s.; copper lamps, with fifty tablets, cost 10s. (fifty tablets are worth 1s. 6d.). The tablets are more effective and cheaper, according to an English doctor who has used them for foul brood.

The fumes from the gas do not injure fabrics, &c., &c., although care is needed not to inhale the fumes, as they are strong. They are fatal to bees, live brood, and the wax moth. In America the usual method of treating stocks is to shake the bees off the combs into boxes, then hang the bee-less comb in an airtight cupboard, insert a tube at the bottom leading to an oil can spout, in which is the formalin (liquid), and boil it off. Leave shut up for twelve hours, then give the comb back to the bees (after leaving exposed to the air for four hours to clear away the fumes which it is stated they will clear up from diseased remains, and keep healthy, even though the combs contain much honey and pollen. In a large apiary another method is to put excluder zinc over a strong but disease colony, run the other stocks into hives, or foundation, and put their brood combs tiered up over the excluder on the one colony, to hatch out all brood that will, and then fumigate their combs.

I shall follow the first method with friend's stock this week as follows:—Stand square board, with bricks for legs, with hole in centre for fumes to rise through. Place the stock-box with combs on it, raised on V-shaped blocks to get the gas all round it. Make a square cover (like an inverted box) made air tight, to come down on to the board using felt to make a good gas joint. Have a hole with a cork at the top, remove the cork, light up, and as soon as the air has been driven out, cork up, keep the burner going a hour, plug up burner-hole, leave for twelve hours; expose combs to air *during night* four hours, then put the bees back on to their combs.

Half the terrors of foul brood are gone if all combs, quilts, &c., can be saved, and combined with naphthol beta, for the bees themselves, would be a complete cure.—GEORGE M. SAUNDERS, *Keswick*.

[We hope to refer to this matter again next week.—EDS.]

#### HOW TO MAKE A FRAME-CAGE.

[5170.] Having occasion to introduce a valuable queen from America, and being desirous to ensure her safety by the use of a "Doolittle plan," in which the queen to be

introduced is placed, together with a comb of hatching-brood freed from adhering bees, in a wire cloth frame-cage, I found it necessary to construct the cage for the purpose, the simple details of which may interest other readers. It will be understood that the object of the arrangement is that a nucleus of newly-hatched bees shall attach themselves to the only mother they have known, the cage being placed in the centre of a colony, or disposed of otherwise in some place of equally correct temperature.

The sketch may perhaps make the details clear without much explanation. Two ordinary standard frames have each had one side covered with perforated zinc, these frames forming the halves of the cage, which, when placed in contact with the selected frame of

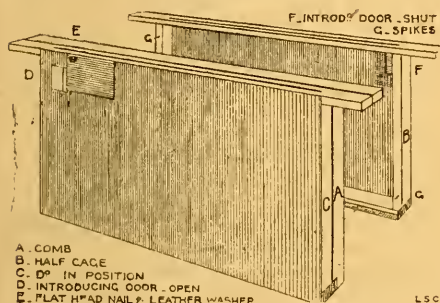

Frame Cage for introducing Queens.

brood, entirely enclose the comb. The halves of the cage are fixed in place by short spikes formed of nails partly driven, cut off and filed to points. A simple introducing door is made in the zinc as shown, one of which in each side might, if desired, allow of the release of the queen and her young bees in an otherwise queenless colony, as I suppose that there are few existing combs without passage beneath, or "popholes" which allow free communication from side to side. A strip of the zinc is fastened along the bottom bar of each half to close any opening formed by a reduced bottom bar of frame; this would of course be unnecessary with bottom bars of  $\frac{1}{2}$ -in. wide in contact. Mr. Doolittle gives  $\frac{1}{4}$ -in. to  $\frac{3}{8}$ -in. as the distance between comb and cage, but the extra room here shown would not seem to be a disadvantage, for I heard recently of a cage made with  $\frac{1}{4}$ -in. beeway, the perforations in which contained many torn legs, &c., and with so little room the queen might easily suffer damage, as the best of flat combs will project in places beyond the worker width of about  $\frac{3}{8}$ -in.

If it be desired to hang this cage in a normal colony, where attack is certain, it may be made double-walled by the simple expedient of sliding another sheet of the perforated metal into the side-bar grooves of a frame of the "Howard" type, and with this

double wall, a larger mesh or perforation might be an improvement. Or, with a tough, wired comb, the frame being thoroughly supported by this method of caging, the cage and contents may be placed between the quilts of a strong stock, and removed without disturbance. The selected comb should preferably be taken from a queenless colony, or from an upper story above an excluder, or prepared in this way beforehand in order to prevent the loss of unsealed brood from starvation.

This plan of making the cage in halves instead of one box, appears to me to possess several advantages. The cage is perhaps more easily made by an amateur workman than of metal soldered together. No cover is necessary; the bee-way around the end of frame is not interfered with; the removal of the comb is extremely easy, and the risk of crushing the queen upon withdrawal is entirely obviated.

The comb may, as a matter of fact, be freed from the cage while it is hanging in the new home of the nucleus, and the halves may be allowed to remain outside an additional pair of combs added to the new central brood comb, until free from young bees which might otherwise be lost.—L. S. CRAWSHAW, *Ilkley*.

#### THE "RYMER" PRESS.

[5171.] It has for some time been my intention to bring this useful press especially before the notice of our north-country bee-men. As the heather-season is approaching, and I trust we may have a good harvest, the present time is perhaps as suitable as any. I have hitherto used the "Garstang" press, and have found it fairly efficient. But last year Mr. Rymer kindly let me try his press, and I was so struck with its superiority that I have pleasure in recommending it. I found it twice as rapid as the "Garstang," and believe with some practice I could have done a great deal better. Here are some special points in its favour. It is *Simple*.—There is but one compartment to hold combs from several shallow-frames; one strainer-cloth, and no further straining required. With cover hinged, there are no loose parts when at work, and yet all easily removable for cleaning. *Easy*—in every process of management—in fitting up, packing, pressing, removing wax, and cleaning. *Cleanly*.—Parts which do not necessarily come in contact with the honey need not be soiled. Being well tinned, the flavour of the honey is not in danger of being affected. *Complete*.—It is self-contained. There is no necessity for an extra receptacle for bottling, as there is a honey-receiver with tap, holding about a hundredweight,—nor for another strainer. *Rapid*.—The former points also mean the saving of much time at every turn. Besides, the honey can be forthwith bottled. It is *well made*. Both metal and woodwork

are strong and compact. Mr. Rymer was fortunate in getting Mr. Meadows, whose name is a guarantee for good workmanship, to turn it out. One improvement, however, occurred to me: the bottom grate, being loose, rises with the wax when removed, but this could easily be remedied by means of two simple catches.

It can be generally useful. It would do admirably for pressing various kinds of fruits for making jellies, and in an emergency it could even be used as a makeshift for the extractor. I have sometimes wondered what I should do if my extractor failed in the midst of the honey flow? The thought of several colonies requiring room; some dozens of supers ready for extracting; agents requesting immediate instalments of honey, but the extractor *hors de combat*. Well, all this has, like a nightmare, flitted across my mind.

Now, with the Rymer Press at hand, such a predicament could be met with some amount of composure. I should take the shallow-frames straight from the hives to the press; cut out the combs, leaving only a V-shaped guide under the top-bar, and at once give the sticky frames to stocks most in need of room. The honey could also be bottled without delay, as it would be free from air-bubbles.

In order to test the Rymer Press I would throw out a suggestion to some association in a heather district. Its members could get up a novel and attractive "Press" competition by inviting those who are familiar with the different types to work them before the public either in the same time or with the same amount of honey.

I believe such a contest would prove a most interesting and valuable object lesson. And if Mr. Rymer handled his press, and an assistant were allowed, I should be proud to help him.—RICHARD M. LAMB, *Burton Pidsea Rectory, Hull, July 11.*

#### SWARMING EXPERIENCES.

[5172.] Referring to my queries on p. 257, allow me to thank you very heartily for the kind way in which you have dealt with my letters on the difficulties of a beginner. Perhaps you will be interested personally in my final experiences of the season's "swarming vagaries" from this, my first hive. I mention it, not necessarily for publication, unless the facts and results may possess interest for beginners like myself, as the case seems to have been a peculiar one. The bees sent off a second swarm on June 21, and after hiving them in a skep I overhauled the parent stock, and cut out sixteen queen cells (afterwards retaining the swarms). Of these, nine had given birth to queens (caps still attached in most cases), while seven were sealed over. Of the sealed ones, one contained a dead worker only, three contained pupæ, one an emerging queen, and two were empty. It seemed to me as if the emerging queen and

the "piping," taken together, account for the swarm. My observations, however, count for nothing, as they are of one solitary hive; but as the facts named have been carefully noted I thought it might be of some interest to you, and suggest to you more than it does to me. I may add that my troubled experiences of swarming have all turned out right, both parent stock and swarm now doing well. After ransacking back numbers of the JOURNAL, I now fully appreciate your advice to beginners, to start with a single hive only.

One note I took may be of interest to your readers—viz., a query some time ago concerning the "visits of bees to spring cabbages." The point was that the cabbages contained hundreds of dead bees, and there seemed a difficulty in accounting for this fact. I had the misfortune to lose a thousand or two of bees this season through planting three or four rows of cabbages immediately in front of the hive. The bees settle on these cabbages to clean themselves, &c. If they alight on the edge of the leaf, or on a fairly horizontal surface, all is well. If, however, as too frequently happens, they try to alight on the steeply-inclined inner or outer surface of a leaf they are in the same difficulty as when they try to pass through a pane of glass—they have no foothold, and fall down between the leaves, and as they cannot climb out are safely trapped, frequently, moreover, drowned in a pool of water. Cabbages are thus death-traps to bees.—A. H. T., *Penarth, July 10.*

#### CAMPHOR *v.* FOUL BROOD.

[5173.] In reply to your correspondent, "Cambs Bee-keeper" (5,167, page 274), camphor, unlike radium, does not bombard, but evaporates, and it is prepared by sublimation. If camphor be placed in a tin and the latter is put in a warm place the camphor sublimates again and form xlas on the tin.

If placed in a bee-hive it evaporates and impregnates the atmosphere of the hive, but does not form xlas again. Phenol and camphor are used differently for the cure of foul brood. Bees would not stay in a hive where phenol was allowed to evaporate the same as camphor or naphthaline, as it would suffocate them.

I have tried camphor for foul brood, given it a fair trial (two years), but it does not cause the disease to disappear.

Being troubled with foul brood, I have been experimenting for the past three years with various remedies, and have come to the conclusion that neither camphor, naphthaline, creasote, menthol, thymol, nor pine oil used in the hives each alone is perfect, but that a combination of some of the above is splendid.

I am at present working with the various kinds of eucalyptus oils, and hope during the winter to give results of my experiments in this JOURNAL. As yet I cannot be quite sure of my effecting a cure, as there is so much foul brood in the district where I live; con-



sequently, until certain that I can keep my bees free from the disease (which I think I have got rid of this year), then I will (with the Editor's permission) give my methods of working, so that all who may care to try it can do so. I shall be pleased if any reader can suggest any other antiseptic suitable for this work. I shall certainly try it.—BLACKWOOD, Co. Durham, July 11.

[5174.] I noticed in the last issue of the B.J., in paragraph 5,167, the query, "Does camphor (like radium) keep on bombarding with its particles the interior of an airtight-enclosing receptacle?" The question arises: Does the querist mean that by some means or another the camphor dissociates into small pieces visible to the naked eye and shoot about like heated fat on to which water has been dropped, or that the molecules of the substance are displaced by explosive violence and cause a transformation scene and then settle somewhere in a changed but somewhat similar form? It is not unusual to find particles of camphor adhering to the stopper and sides of bottle or other receptacle in which it is stored, where it volatilises according to surrounding temperature and finally sublimates at a suitable temperature. Considering that very little is yet known about radium from a physicist's point of view, the action of heat on the molecules of camphor can scarcely be compared. Camphor is frequently used by bee-keepers in the same way as naphthaline is used for foul brood in the incipient stage, and its results have proved to be similar. In the presence of oxidising agents camphor yields camphoric acid, which is considered to be a strong antiseptic. It is generally thought that only true poisons (including phenol) applied in strong solutions can really act as destroyers of germ life, hence the oft-repeated reply that disinfectants stringent enough to destroy advanced disease must necessarily destroy the bees too.—A. W. S., Chingford, July 11.

[5175.] The phenomena noticed in reference to camphor by your correspondent (5167, page 274) reveals only an ordinary case of evaporation and freezing. The amount of heat and cold to produce the crystals mentioned varies according to the substance experimented upon. Naphthaline acts, or is acted upon, in much the same way if kept in a tin or bottle, and is presumably better for use in hives than camphor. If a solid lump of water (ice) were subjected to a slight rise of temperature—say, in a glass bottle—and afterwards placed in a temperature below 32 deg. Fahr., the vapour would crystallise in the same way as camphor, &c., are seen to do.—F. V. HADLOW, Buxted, Sussex, July 10.

#### SWARMS ABROAD.

[5176.] I am sending you a newspaper cutting from the *Bristol Observer*, thinking it might possess interest for readers, and also in

order to ask a question regarding the same swarm of bees referred to in cutting, as I happened to be the "young fellow," mentioned as having caught them. I took the swarm home, and, after removing the queen, united the bees to a stock that had swarmed a fortnight previous. I had a super on the last-named hive when the swarm came off, but the bees had not taken possession of the same before nor since, and as the super has now been on quite three weeks do you think my adding the stray swarm will induce them to work in the super, or will they be likely to swarm again? The super is fitted with shallow frames, with full sheets of foundation.—A BEGINNER, *Bedminster, Bristol, July 11.*

The cutting sent reads as follows:—"Taking a walk abroad in the neighbourhood of Knowle one sunny afternoon this week, a correspondent was witness of an incident that is certainly not common in the streets of a town. A swarm of bees was observed passing along overhead like a dark cloud, and they alighted in a thick black mass on the sun-blind of a shop window. The bystanders who witnessed the novel sight scattered and fled—it was amusing to see the celerity of their movements—evidently deeming discretion the better part of valour, in so far as the bees were concerned, at any rate; but one young fellow, who evidently understood bees and their ways, climbed up and deftly transferred them to a temporary hive—to wit, a large box—afterwards marching off in triumph with the box on his shoulder."

[The fact of a swarm (perhaps two) having issued from the hive will account for the box of shallow-frames not being taken possession of. However, if all goes on well and bees have united peaceably, it is probable that some honey may be stored in the super during the next fortnight, if bee-forage is fairly plentiful.—EDS.]

#### A PROFITABLE SWARM.

[5177.] It may interest some readers of the B.B.J. to learn of the good work done by a swarm of bees taken on June 21 last. The swarm in question was a "strong one" and was placed in a single hive on ten frames of clean, drawn-out combs. When examining the hive on July 1, I found these combs all partly filled and sealed with honey. Breeding was also rapidly progressing on the lower part of the frames, and as the hive was now ready for the supers, I at once gave a box of shallow-frames with clean, drawn-out combs. Ten days later (July 11) these were all beautifully filled and sealed, which, on being extracted, yielded 25 lb. of splendid clover honey. This, I think, clearly demonstrates the utility of clean, drawn-out combs when used in the height of the season, and the amount of honey that can be obtained in so short a time.—T. LOWTH, *Morton, Lincoln, July 13.*

## ORDERING COMB-FOUNDATION.

[5178.] May I be allowed to say appliance dealers would be very much helped if bee-keepers would remember when ordering foundation that "super" is an indefinite word, embracing shallow-frames for extracting and sections; and for each there are two or three different foundations? What, then, is the appliance dealer to send when a customer orders "1 lb. of super foundation"?—GEORGE ROSE, *Liverpool, July 13.*

## A FOUL BROOD DUMMY.

[5179.] I am writing to describe a new cure for foul brood which has just been introduced by Mr. Jas. Abbott, of Dublin, and which I have not yet seen described in your journal. The invention is called a "Foul Brood Dummy." It consists of a double-walled dummy, in which a bottle containing formic acid is inverted, the fumes of which, escaping through muslin, pass through a piece of perforated zinc into the hive. The dummy complete costs only a shilling, and ought certainly to be worth a trial. The strength of the formic acid is 1'060. It is stated the strength has been carefully studied to avoid harming the bees. Thinking the dummy might interest our brother bee-keepers across the channel, I have written these few lines.—G. F. GILLILAND, *Londonderry, July 10.*

## WORKING FOR HEATHER HONEY.

## THE RYMER METHOD.

The mention (on page 264) of Mr. Rymer's method of working for heather honey has produced so many applications for B.B.J. of November 1, 1900, containing the article referred to that our stock of that issue is sold out, and the demand still continues. We therefore reprint Mr. Rymer's method in somewhat condensed form below:—

As swarming plays such an important part in securing a good harvest of honey, and seems to crop up every season, I have decided to give your readers my system of management, by which I have totally overcome swarming and greatly increased my income of honey. It seems to be pretty clear now to the majority of bee-keepers that honey and swarms cannot be secured in the same year, hence the great need for a good non-swarming hive.

In considering the question of honey-production, it may be said that three things greatly govern the result—first, the season; second, the district; third, the management. Over the first and second we have no control, so that success or failure rests with the third. Before going into the class of hive and the method I adopt, let me say my own district practically yields no clover honey, so that my whole

efforts must be devoted to securing surplus from the heather. This being so, readers will understand that the system adopted has for its aim securing the greatest harvest from the heather in the least possible time. In fact, time may be said to be the most important factor in the case, the heather season being generally so short in duration that we can only rely on about twelve or fourteen days for the main income.

In considering all this my first step was to find out the most suitable hive to meet the special requirements. Fortunately, all my hives, with the exception of four, were the well-known "W. B. C.," and I soon found out that this hive was the only one to suit my purpose; so I set to work and tried all the various systems laid down to do away with swarming, but somehow every effort in this direction seemed to fail in practice. The best stocks in my apiary—those looked forward to as likely to yield the greatest amount of surplus, and from which the greatest things were expected—were the worst transgressors. Some fine day, when having a look round about noon to see how my plans were working, I would see the bees of my best stock teeming out of the hive in thousands, thus shattering one's expectations and dashing to the ground any prospect of a great heather yield for the year. Some may say, "You should have returned the swarm," but I did do that more than once, only to find that returning them never proved satisfactory or gave me the advantage I expected, so I determined to stop the thing altogether, if possible. I tried working a box of shallow-frames under the brood-nest, and this reduced swarming to a certain extent; but finding the shallow frames below often contained brood and eggs when removing them to their place overhead, I altered my plan, and when room was required to prevent swarming I put the shallow frames on the top of the brood-nest instead of below; thus it became a part of the brood-chamber. This plan answered the best of any tried so far, but did not stop swarming. I therefore took another step—one that I have never seen even suggested. I made myself a few extra brood-boxes, having decided to give each hive during the swarming season twenty brood-frames instead of the usual ten. This, I am glad to say, proved the greatest "hit" I have ever made in the bee-line, so far as single hives are concerned. But in order to explain how I proceed with working the double set of brood-frames in each hive, let me say swarming usually takes place here in the month of June. Therefore I begin early in May by looking over all hives very carefully, and any found to be full of bees at all the four corners are given a second set of ten standard frames fitted with full sheets of brood-foundation. As soon as this second brood-chamber is full of bees I add a "W. B. C." hanging section-rack, after setting on a sheet of queen-excluder zinc, and in a good many cases a second rack

is needed when the first is getting full. Strange though it may seem—and taking the average—I have had more sections filled on the top of the two brood-chambers than I ever got on a single one containing the ordinary ten frames.

(Conclusion next week.)

### WEATHER REPORT.

WESTBOURNE, SUSSEX,  
June, 1903.

Rainfall, 2.17 in.	Minimum on grass,
Heaviest fall, .50, on 15th.	24°, on 22nd.
Rain fell on 9 days.	Frosty nights, 0.
Above average, .13 in.	Mean maximum,
Sunshine, 213.3 hours.	63.1°.
Brightest day, 1st, 14.5 hours.	Mean minimum,
Sunless days, 4.	47.6°.
Below average, 16.6 hours.	Mean temperature,
Maximum temperature, 79.5°, on 1st.	55.3°.
Minimum temperature, 37°, on 22nd	Below average, 1.9°.
	Maximum barometer,
	30.45°, on 4th.
	Minimum barometer,
	29.50°, on 19th.
	L. B. BIRKETT.

## Queries and Replies.

[3159.] *Transferring Bees, and Packing Honey for Market.*—Early this year I came into possession of a bee-house containing ten stocks of bees in skeps, and am now anxious to transfer them into frame-hives, and move same some 30 yards away. In the spring I put a body-box fitted with full sheets of foundation under each skep, and the bees have taken to same very well. On July 1, one of the stocks seemed anxious to swarm, but not wanting a swarm so late in the year as this, I lifted skep off, removed the two outside frames (full of honey) and substituted two empty combs. To-day the bees started clustering out in large quantities, hanging right down to ground. I thought, therefore, to repeat the operation by removing more frames, but found the outside comb almost full of brood, so, of course, I did not disturb them further, but left it. On returning the skep to its original place on top-bars, it came to pieces, being very old, so I put on a shallow-frame box, and took the skep away. On examining the latter, it was found nearly full of sealed honey. A few bees were just hatching out, but I saw no eggs or pollen. 1. Please say if I did right; also how I can get the bees from the skep and extract the honey, which is very "messy" with the broken comb. I have also got a stock in a wood box (a swarm hived last year). This lot has sent out a large swarm, which has already given me 30 lb. of honey, and there will soon be 30 lb. more to

take. The combs in the box are built anyhow, as there are no frames at all. 2. Can I drive the bees out same as from skeps, and, if so, when? 3. I want to send a lot of extracted honey in 1-lb. jars by rail. If I wrap each jar in corrugated paper and put in a strong box to fit tight, will it travel well to my customers? I am also sending some sections, and am wondering if the contents would arrive all right if packed tight in a wooden box. 4. Can you inform me where to get cans for extracted honey something after the style of milk-cans? Several of my customers have asked for them, and they will come much cheaper for carriage. Am sorry to trouble you with so many queries, but I take a great interest in bees apart from the profit side.—"SUBSCRIBER," *Barfield, Hants, July 10.*

REPLY.—1. The proper course under the circumstances would have been to lift the skep and place a box of shallow-frames above the top-bars of frame-hive; then set skep over all. This would not only have prevented bees from clustering outside, but allowed all brood in skep to hatch out before removing the latter as a super. The mishap of breaking down the combs in skep was, no doubt, a preventable one, had care been taken; the honey in broken combs must perforce be drained out in front of fire and strained through muslin. 2. The bees able to fly will return to the hive, and any young ones, newly hatched, should be put back by hand. For remainder of queries, and also as an essential aid to success, we advise the purchase of a "Guide Book," wherein will be found fuller and more complete replies than we can give in this column.

[3160.] *Queen Mating.*—Would you kindly answer the following questions in the next issue of the B.B.J.? 1. Does the queen in a second swarm or "cast" get mated when coming out with the swarm, or has she to fly again for fertilisation? 2. If I put a frame of brood into a queenless hive, may I leave the bees to make what queen or queens they like, or is it better to cut out all but one queen-cell? I ask, because, if I do this and the queen fails to mate, I am in as poor a fix as at the beginning. On the other hand, if I do not and several queens are rendered unfertile, what happens? Your kind reply will be esteemed. With thanks for the help so often given.—F. HAMSHAR, *Cuckfield, Sussex, July 10.*

REPLY.—1. The young queen heading the second swarm is a virgin at the time, and mating takes place after the swarm has been hived a day or two. 2. If the queenless hive is in proper condition for queen-rearing and cells are formed from brood given, it is safest to leave all the queens to hatch out, and thus allow for the "survival of the fittest."

[3161.] *A Beginner's Queries.*—As a reader of the B.B. JOURNAL, I should like your advice on the following:—No. 1 hive was

purchased in 1901, with brood-combs ready built out. I then transferred to it, in May, a stock of bees from a skep, and I am pleased to say the hive was quite filled with honey at the end of the season, and plenty left in the combs to carry the bees safely through the winter. Last May I found them very strong, so I put on a rack of sections, quite expecting they would soon fill it; but the bees scarcely entered the sections at all, consequently my yield of honey was nil. I again put the sections on in middle of May last, and, on looking at them last week, I was again disappointed to find scarcely a dozen bees in the rack. Can you account for this, as I naturally want some honey this year to compensate me for the expense I have gone to? I may say that a small swarm issued from the hive, and the rack has been well covered to keep it warm. Hive No. 2 is two driven lots, and was built up last autumn from bees which I drove and united. On examining them in May I found only a small quantity of brood, so I removed a frame of brood from No. 1 hive to help them, but on examining them again last week I found there was scarcely enough bees to cover three frames, and the brood which I put in had not been hatched out, so I conclude the stock is queenless. What would you advise me to do with them: should I re-queen the stock, or unite the bees to the other hive? Greatly oblige, A. W. L., *Ventnor, Isle of Wight, July 9.*

REPLY.—1. Before being fully able to understand why bees do not fill supers with honey when given them, you must realise that without suitable weather for honey gathering and nectar-yielding flowers growing within reach from whence honey can be got, both bees and bee-keepers are helpless. 2. It is of little use re-queening a weak lot of bees at this season, and even the bees themselves are hardly worth saving.

[3162.] *Making Artificial Swarms.*—As a regular subscriber to both your journals will you kindly answer this in your next issue. I have been a bee-keeper for some years, and last Saturday decided to swarm a stock artificially as per "Guide Book," viz., moving the stock and leaving one frame of brood with queen on old position. It succeeded—too effectually, I think, as on examining the old stock yesterday I find barely a quart of bees left—about three seams of them, and there are about four or five frames of capped brood uncovered by bees which I greatly fear are chilled. Please say: 1. Is this usually the case or rather, how can it be prevented? 2. Is it necessary for bees to actually cover the brood or is the heat generated from adjacent combs sufficient to keep it alive? 3. Does an artificially swarmed stock make queen cells and place larvæ in them? I send name, &c., for reference while signing—"WEST LICESTRIAN," *Leicester, July 9.*

REPLY.—1 and 2. If the stock operated on had been in proper condition for artificially

swarming there would have been more than a quart of bees left, supposing all the foraging bees to have returned to the old stand. On the other hand, the parent hive always needs the closest attention to prevent brood-chilling, and an experienced hand takes especial care to add warm coverings, reduce entrance to narrowest limits, and feed the bees continuously for several days until sufficient bees hatch out to form a field force for the colony. 3. Bees when rendered queenless form queen-cells round a very young larva two or three days old.

[3163.] *Queen Rearing and Artificial Cell-Cups.*—I have been trying queen-rearing, on the artificial cell-cup plan, but cannot seem to get them accepted (only a few) even if I make stocks queenless. I enclose three cells for you to see if these are made right. I have added the royal jelly and larvæ, using a small camel hair brush for this purpose. I have not tried taking away the brood, as I did not think this necessary, as this plan is generally used to get queen-cells built in the supers, on any strong stock. I am requiring a few young queens this month to replace old ones, and ask whether you recommend this plan or the one in the "Guide Book." Thanking you in anticipation of reply,—H. SWIFT.

REPLY.—We rather think the fault lies in your "cell-cups" judging by samples sent. These are all right, and nicely made at the lower or open end of the "cup," and also with regard to size and capacity of same, but the base of the cup has a little pit or well—so to speak—formed by the flat point of the stick or "dipper" which is altogether unsuitable in shape for the proper development of the queen larva, and, as such, is probably rejected by the bees. Had the base of cell been simply concave in shape so as to form a rounded base to cell it would be far more likely to be accepted by the bees for queen-raising.

[3164.] *Swarming Troubles.*—I am a novice at bee-keeping. I would like advice on the subject. I bought a stock of bees in a frame-hive, advertised in B.B.J. The bees swarmed on June 22, and were hived in a new frame-hive. They seem to be going on all right, but I am anxious about the parent stock. A bee-keeping friend helped me to examine the old hive four days after swarming, and we could neither find queen, drones, nor brood, but the bees seem to be working very well. I therefore ask, what would you advise under circumstances? 1. If there is a queen and no drones to fertilise her, what will happen? 2. Is it not unusual for bees to swarm when there are no drones present in the hive? Please reply.—ANXIOUS ONE, *Keighley, Yorks, June 30.*

REPLY.—1. If there were no drones in several miles radius within reach of virgin queens, of course fertilisation would be impossible, but this is a possibility so remote as not to be worth taking into account. 2. Yes, but the drones had evidently left with the swarm.

## Echoes from the Hives.

*March, North Cambs., July 11.*—Bees have done splendidly in this district; at least, those that have had good attention. I know of some failures caused by the bee-keeper not being adapted for up-to-date methods. On Sunday, June 28, we had seven swarms come off, three clustering on the top of high trees. It made me wish Richard Brown was near by to lend a hand, with "Kitty" in the cart to convey the crop home. Just now it is work night and day, but we bee-keepers do not mind that, anyhow during harvest.

I trust that all bee-keepers have had as successful a season as I have. I also hope that the heather-men will have a good time; they need encouragement after a season as last year. When such bee-men as "D. M. M." and McNally report a failure, what about the smaller ones?—H. T. WRIGHT.

## Bee Shows to Come.

*A nominal charge of 2s. 6d. is made for notices in this column, which covers cost of insertion from order till date of show. Cash should accompany orders for insertion.*

**July 22, at Broughton, Hants.**—Fruit, Flower, Vegetable, and Honey Show. Twentieth year. Liberal prizes, with silver cup, valued £15, open to the United Kingdom. Particulars from Fred. J. Hinwood, Broughton, Stockbridge, Hants. **Entries close July 18.**

**July 22 and 23, at Cardiff.**—Honey show of the Glamorgan B.K.A., in connection with the Cardiff and County Horticultural Society. Bees, hives, honey, trophies, wax, appliances, and articles of food. Substantial money prizes and medals. Free entries. Six open classes. Schedules from William Richards, Gwabala, Cardiff. **Entries close July 16.**

**July 29, at Wallop, Hants.**—Honey Show of the Broughton and Wallop Branch of the Hants and Isle of Wight Bee-keepers' Association. Two open classes for single-section and 1-lb. jar respectively (entry free). Schedules from Miss Tucker, The Lindens, Broughton, Stockbridge, Hants. **Entries close July 22.**

**July 29, at Henbury, near Bristol.**—Annual Show of the Henbury District Bee-keepers' Association in connection with the Horticultural Society's Exhibition. Several open classes with good prizes (two classes with free entry). Schedules from I. Atkin Waller, hon. sec., Pen Park, Westbury-on-Trym, near Bristol. **Entries close July 24.**

**July 29, in Swanmore Park, Bishop's Waltham.**—Honey Show of the Swanmore Branch, Hants and Isle of Wight B.K.A., in connection with the Bishop's Waltham Horticultural Society. Local Classes for Comb and Extracted Honey, Honey Trophy, &c., and Classes for Sections and Extracted Honey Open to Members of the County B.K.A. Schedules from Miss Martin, Secretary, Swanmore, Bishop's Waltham.

**July 30, 31, and August 1 and 3 at Old Trafford, Manchester.**—Annual Show of the Royal Lancashire Agricultural Society. Liberal money-prizes are offered for honey along with silver and bronze medals of the B.E.K.A. and also of the Society. Open classes for Honey-Trophy, Sections, Extracted Honey, Beeswax, Honey-Confectionery, Bee Flowers, Instructive Exhibits in Bee-Culture, &c.

**August 3 (Bank Holiday), in the Walled Meadow, Andover.**—Honey Show in connection with the Andover and District Horticultural Society.

Class for single 1-lb. jar of extracted honey (with no entry fee). Also classes for sections, extracted honey (light and dark), and beeswax. Schedules from the Hon. Sec., Dr. Gillett, Elvin House, Andover. **Entries close July 28.**

**August 3 (Bank Holiday) at Melton Constable Park.** Annual Show of the North Norfolk B.K.A. Schedules from the Hon. Sec., C. J. Cooke, Edgefield, Melton Constable. **Entries close July 27.**

**August 4, at Leamington.**—Tenth annual show of the Leamington St. Mary's Horticultural Society. Three open classes for Six 1-lb. Sections, Six 1-lb. Jars "Light," and Six 1-lb. Jars "Dark" Extracted Honey, respectively. Liberal money prizes. Schedules from P. W. Smith, Secretary, 22, Leam-street, Leamington. **Entries close July 30.**

**August 6, at Nantwich.**—Honey department of the Cheshire Agricultural Society's Show under the management of the C.B.K.A. Numerous classes for hives, honey, and wax. Money prizes and medals. Schedules from T. A. Beckett, St. Werburgh's Chambers, Chester. **Entries close July 16.** At double fees July 23.

**August 6, at Kingsthorpe, Northants.**—Honey show of the Northants B.K.A., in connection with the Horticultural Society's Exhibition. Three open classes with special prizes, including one for single 1-lb. jar of honey. (Entry free.) Prizes 20s., 10s., 7s. 6d., and 2s. 6d. Schedules from R. Hefford, Hon. Sec., Sunnyside, Kingsthorpe, Northampton. **Entries close August 1.**

**August 6 at Madresfield.**—Honey show of the Worcestershire B.K.A., in connection with the Madresfield Agricultural Show. Schedules from A. R. Moreton, Leigh, near Worcester. **Entries close August 1.**

**August 12, at Radstock, Bath.**—Honey show in connection with the annual show of the Radstock and District Horticultural and Fanciers' Association. Schedules from the Secretary, B. M. Clark, 1, Fox Hills Radstock, Bath.

**August 12, at Wye.**—East Kent Honey Show. Open Class for Single 1-lb. Jar Extracted Honey with no Entry fee. Prizes—1st, £1; 2nd, 10s.; 3rd, 5s. Schedules from Secretary, J. Tippen, Wye, Ashford, Kent.

**August 12, at Hardenhuish Park, Chippenham, Wilts.** Honey show in connection with the Chippenham and District Horticultural Society. Ten local classes for bees, honey, and beeswax. Open class for honey trophy. Prizes 20s. and 10s. Schedules from Wm. Small, Secretary, Market-place, Chippenham.

**August 12, in the Market Hall, Tavistock.** Devon B.K.A. annual show of honey, wax, bees, and appliances, in conjunction with the Exhibition of the Tavistock Cottage Garden Society. Schedules from E. B. Scholefield, Heathfield, Chudleigh, S. Devon. **Entries close July 31.**

**August 13, at Bath.**—Honey show in connection with the Annual Show of the St. Saviour's Horticultural and Industrial Society. Held in Kensington Meadows. Seven local and seven open classes (including one for single 1-lb. jar of honey with free entry), for six sections, six 1-lb. jars extracted honey, three shallow-frames comb-honey for extracting, and for collection of honey, also honey products. Also for collection of bee-appliances and observatory hives with bees. Schedules from C. J. Calvert, hon. sec., 10, Eastbourne, Bath.

**August 15, at Chorley, Lancs.**—Classes for six 1-lb. jars Extracted Honey and six 1-lb. Sections. Open to the county. Schedules from Peter Hodgkinson, Secretary, Chorley Agricultural Society, Town Hall-square, Chorley, Lancs.

**August 19, in the Great Western Park, New Swindon.**—Wilts B.K.A. County Show of Bees, Honey, &c. Fifteen classes in all, five open to all England. Schedules from the Hon. Sec., W. E. Burkitt, Buttermere Rectory, Hungerford, or from local Hon. Sec., S. W. Filtness, Market House, Marlborough-road, Swindon. **Entries close August 10.**

**August 19 and 20, at Shrewsbury.**—Annual show of the Shropshire B.K.A., in connection with the Shrewsbury Horticultural Society's Great Floral Fête. Seven open classes for honey. Schedules from S. Cartwright, hon. sec., Shawbury, Shrewsbury. **Entries close August 7.**

**August 22, at Hawkshead, Lancashire.**—Honey show in connection with the Hawkshead Horti-

cultural Society. Open classes for Six 1-lb. Sections and Six 1-lb. Jars (medium or dark) Extracted Honey. Prizes 10s., 6s., and 4s., and medals of the L.B.K.A. Schedules from Dr. Allen, Hawkshead, Lancs. Entries close August 15.

August 22, at Barnton, near Northwich.—Honey department of the Flower Show. Local classes for light and dark honey, sections, and beeswax. Class for twelve 1-lb. jars extracted honey open to county and members of the Cheshire B.K.A. First prize, silver medal of the C.B.K.A. and 15s. Schedules from Mr. S. Wade, Heathside, Barnton, Northwich. Entries close August 15.

August 25, at Cartmel, Lancashire.—Honey show in connection with the Cartmel Agricultural Society. Open classes for sections, extracted honey, and beeswax. Local classes for sections and extracted honey. Schedules from Wm. Cragg, Secretary, Cartmel, via Carnforth.—Entries close August 13.

August 26, at Reading.—Honey Show of the Berks B.K.A., in conjunction with the Annual Exhibition of the Reading Horticultural Society. Open classes for comb honey in sections and for extracted honey. Local classes include prizes of 20s., 15s., 10s., and 5s. for honey trophy. Also classes for owners of small apiaries. Schedules from D. W. Bishop-Ackerman, Hon. Sec. Berks B.K.A., 131, King's-road, Reading.

August 27, at Llangollen.—In connection with the fifth annual Flower Show. Open classes for Six 1-lb. Sections, Six 1-lb. Bottles Extracted Honey, and Beeswax. Schedules from Frank Little, Castle-street, Llangollen. Entries close August 13.

August 27, at Montgomery, in connection with Montgomery and District Horticultural Show. Open classes for Six 1-lb. Sections and Six 1-lb. Jars, Extracted Honey. Prizes in each class 10s., 5s., 2s. 6d. Entrance-fee 1s. each. Schedules from W. J. Jones, Secretary, Montgomery. Entries close August 20.

September 5 to 12, at the Agricultural Hall, London.—Honey show in connection with the Confectioners', Bakers', and Allied Traders' (11th) Annual Exhibition and Market. Numerous classes and liberal prizes for comb and extracted honey and beeswax. Open to all British Bee-keepers. Special attention is directed to the new Honey-selling Classes with Free Entry. Schedules (now ready) from H. S. Rogers, Secretary, Exhibition Offices, Palmerston House, Old Broad-street, London, E.C. Entries close August 19.

September 17, 18, and 19, at Crystal Palace, Surrey, B.K.A. Annual Exhibition of Bees. Honey, Wax, and Appliances, &c. Twenty-four classes (ten open to all). Increased prizes and medals. Schedules from F. B. White, Secretary, Marden House, Redhill, Surrey. Entries must be made before September 1.

September 19 to 26, at the Agricultural Hall, London.—Honey Show in connection with the eleventh Annual Exhibition and Market of the Grocery and Kindred Trades. Numerous classes and liberal prizes for comb and extracted honey and beeswax. Open to all British Bee-keepers. Special attention is directed to the new Honey-selling Classes with free entry. Schedules from H. S. Rogers, Secretary, Exhibition Offices, Palmerston House, Old Broad-street, London, E.C.

## Notices to Correspondents & Inquirers.

Letters or queries asking for addresses of manufacturers or correspondents, or where appliances can be purchased, or replies giving such information, can only be inserted as advertisements. The space devoted to letters, queries, and replies is meant for the general good of bee-keepers, and not for advertisements. We wish our correspondents to bear in mind that, as it is necessary for us to go to press in advance of the date of issue, queries cannot always be replied to in the issue immediately following the receipt of their communications.

\* \* Mr. A. R. Heselwood, Tetford, writes as follows:—"Please stop my advertisement in B.B.J., for I have received so many answers to it that I should have to drive

all the bees in the neighbourhood to fill orders."

"T." (Bromley, Kent).—*Swarms Deserting Hiving Skeps.*—We think, from details given, it is pretty certain that the bees have not decamped at all, but have returned unseen to the parent hive. Should no further swarm have issued by the eighth day after first swarm came off, go after sundown to the hive, and lay one ear close down to hive for a moment, and if the sound of queens "piping" is heard you may be certain that parent queen was lost on the 11th, so that if a swarm issues on 18th or 19th it will be headed by a young queen, and may be returned to the parent hive same evening, after cutting out all queen cells.

W. WRIGHT (Totteridge).—*Sowing Clover for Bees.*—The best clovers for bee-forage are the White Dutch (*Trifolium repens*) and Alsike or hybrid clover (*T. hybridum*).

"Lost!" (Richmond).—*Swarms Absconding.*—There is no reliable way of accounting for swarms deserting skep twenty-four hours after hiving. The only safe thing to say is that such a thing rarely or never occurs to an experienced bee-keeper, but in less experienced hands it is merely guess-work to try and explain the mishap.

L. M. B. (Hailsham).—*Insect Nomenclature.* The "grubs" in comb are simply chilled larvæ that have died from cold.

F. D. HILLS (Hants).—*Insect Nomenclature.* The occupant of mud cells received is a grub or larva of the solitary wasp of the genus *Odynerus*. On page 260 of B.J. for June 25 last will be found particulars regarding the same insect.

(Miss) E. J. O. (Raglan, Mon.).—*Varieties of Bees.*—The bees sent are Ligurian-Carniolan hybrids. This cross is sometimes exceedingly good-tempered, and at others they are rather the reverse.

J. M. (Appleby).—*Honey Plants.*—The blooms sent are from the *Limnanthes Douglasii* one of the best honey plants.

C. G. (Leeds).—The blossoms sent are from the weed commonly known as charlock or wild mustard.

P. SHACKLETON (Burnley).—*Insect Nomenclature.*—The "bee" forwarded is a queen wasp, and, as wasps are usually included among the enemies of bees, queens are destroyed whenever found.

J. REAVELEY (Harrogate).—*Queen Cast Out.*—The bee sent is a young unmated queen. Fuller reply next week.

### Suspected Comb.

J. W. L. (Keswick).—There is foul brood in comb sent; we will reply more fully next week.

\* \* Some Letters and Queries are unavoidably held over till next week.

## Editorial, Notices, &c.

### BRITISH BEE-KEEPERS' ASSOCIATION

The monthly meeting of the Council was held on Wednesday, the 15th inst., at 105, Jermyn-street, S.W., Mr. T. I. Weston occupying the chair. There were also present Dr. Elliot, Messrs. D. W. Bishop-Ackerman, W. Broughton Carr, W. H. Harris, E. D. Till, and the Secretary. Letters explaining enforced absence were read from Mr. T. W. Cowan (Chairman), Miss Gayton, Rev. W. E. Burkitt, Messrs. H. Jonas, W. F. Reid, P. Scattergood, and C. N. White.

The minutes of the previous meeting were read and confirmed. Four new members were elected, viz. :—

Mr. C. H. Bennett, Princes House, Palace-street, Westminster; Mr. C. Dunn Gardner, Fordham Abbey, Soham, Cambs.; Mr. Joseph Lamb, 8, Grange-street, St. Albans; Mr. Chas. Waghorn, Foresters' Arms, Paddock Wood, Kent.

The Finance Committee's report, presented by the Chairman, gave particulars of receipts and expenditure to date, and was duly approved. Amongst the payments authorised were the amounts due in respect to prizes and sales at the late "Royal" Show at Park Royal.

Reports were received in regard to third-class examinations recently held at the "Royal" Show and in Lincolnshire and Middlesex, and it was resolved to grant certificates to the following candidates, viz. :—Messrs. F. E. Gifford, P. Hansen, Charles Munkton, and T. W. Swabey.

The report of the examiners of candidates for first-class certificates was also considered, and it was decided to award diplomas to the following:—Misses Bury, Dunham-Massey, and Wimpres, Messrs. L. Bigg-Wither and L. S. Crawshaw.

A large number of applications for the services of judges and examiners were received and dealt with by the Council. The applications embraced the following counties, viz., Berks, Cheshire, Cumberland, Kent, Lancs, Lincs, Norfolk, and Worcester. Judges were also appointed to officiate at the Grocers' and Confectioners' Exhibitions at the Agricultural Hall in September next.

On the motion of Mr. Weston, seconded by Mr. Ackerman, it was resolved to nominate Mr. T. W. Cowan to represent the Association on the Council of the new Lady Warwick Hostel, at Studley Castle, for the first year, commencing in October next.

The Council further considered the proposed letter to County Education Committees, which, in its amended form, was duly approved and ordered to be sent out.

The next meeting of the Council was fixed for Wednesday, September 16.

### LINCOLNSHIRE B.K.A.

#### ANNUAL SHOW AT LINCOLN.

This show was held in connection with that of the Lincolnshire Agricultural Society on July 16 and 17, and resulted in a splendid display of extracted and comb-honey, there being no less than eighty-six entries for extracted honey and thirty-six of sections, the total entries, including appliances, being 150. The early part of the season was anything but favourable for the bees in Lincolnshire, and up to June 21 no honey was stored in supers; in fact, bees were hardly able to keep themselves. But after that time clover has bloomed abundantly, and the weather favourable for honey gathering, with the result that Lincolnshire bee-keepers were able to stage and show some very beautiful honey, mostly obtained from white clover. There were also some very fine sections shown, and in one class (containing twenty-six entries) the first, second, and third prizes were so very even that their relative positions had to be decided by the small number of defects in each. In the class for light-coloured extracted honey there were thirty entries, and, with the exception of two or three, all were good—the prizetakers' very good indeed. On the whole, it was a very fine display of honey, and where all was so good it is no discredit to those who failed in winning a prize. Unfortunately, a drizzling rain came down all the first day, so that the attendance at the bee department was not as large as it ought to have been:—

Mr. T. W. Cowan, 17, King William-street, Strand, W.C., and the Rev. Sydney Smith, Wheldrake Rectory, Yorks, judged the Bee and Honey exhibits, their awards being as follows:—

*Trophy of Honey in any Form (not to exceed 250 lb.).*—1st (and Silver Medal B.B.K.A.), A. W. Weatherhogg, Willoughton, Lincs.; 2nd (and Bronze Medal B.B.K.A.), D. Seamer, Grimsby; 3rd, W. Hatliff, Thoresway, Caistor.

*Twelve 1-lb. Sections (Open Class).*—1st, A. W. Weatherhogg; 2nd, R. Brown, Somersham, Hunts; 3rd, W. Patchett, Cabourne, Caistor; 4th, W. Hatliff; h.c., Rev. W. F. Goffe, Thoresway, Caistor.

*Twelve 1-lb. Jars Extracted Honey (Open Class).*—1st, W. Hatliff; 2nd, R. Brown; 3rd, W. Patchett; 4th, A. W. Weatherhogg; h.c., C. Hill, Willoughton Cliff, Lincs.; F. Chapman, Andover; R. Allen, Bicester, Oxon.

*Twelve 1-lb. Sections (County and Members Lincs B.K.A. only).*—1st (and Silver Medal Lincs B.K.A.), W. Patchett; 2nd, C. Hill; 3rd, A. W. Weatherhogg; 4th, Miss A. Morley, Lincoln; v.h.c., G. W. Saundby, Holton-le-Moor, Lincs; D. Seamer; and T. Sells, Uffington, Stamford.

*Twelve 1-lb. Jars (Light-coloured) Extracted Honey (County and Members Lincs B.K.A. only).*—1st, and Silver Medal Lincs B.K.A., W. Hatliff; 2nd, W. Patchett; 3rd, C. Hill;

4th, W. Cook, Market Rasen; v.h.c., Mrs. Walter Cooke, Navenby, Lincs; H. Pears, Mere, Lincs; and A. W. Weatherhogg; h.c., F. W. Gelder, Lincoln.

*Twelve 1-lb. Jars (Other than Light) Extracted Honey (County and Members Lincs B.K.A. only).*—1st, Jesse Househam, Huttoft; 2nd, F. W. Gelder.

*Twelve 1-lb. Jars Extracted Honey (Novices only).*—1st, W. Cook; 2nd, A. R. Heselwood, Tetford; 3rd, G. W. Saundby; v.h.c., F. W. Gelder, and J. G. Green, Horncastle.

*Twelve 1-lb. Jars Granulated Honey.*—1st, A. W. Weatherhogg; 2nd, Miss A. Morley; 3rd, Rev. H. Goffe.

*Beeswax (not less than 3 lb.)*—1st, Jno. Berry, Llanrwst, North Wales; 2nd, W. Patchett; 3rd, T. Sells; h.c., W. W. Davy, Spalding.

*Observatory Hive (stocked with Bees and Queen).*—1st, E. H. Taylor, Welwyn, Herts; 2nd, B. C. Blackburn, Billingham; 3rd, R. Godson, Tothill, Alford; h.c., J. W. Seamer; c., R. Brown.

*Collection of Hives and Appliances.*—1st, W. P. Meadows, Syston, Leicester; 2nd, E. H. Taylor.

*Complete Hive for General Use (price not to exceed 25s.).*—1st, E. H. Taylor; 2nd, W. R. Garner, Dyke, Bourne; 3rd and h.c., W. P. Meadows.

*Complete Hive for General Use (price not to exceed 12s. 6d.).*—1st, E. H. Taylor; 2nd, W. R. Garner; 3rd, W. P. Meadows.

*Bee-appliances Recently Introduced.*—Certificate of Merit to W. P. Meadows, for combined wax-extractor and uncapping strainer.

Interesting lectures were given in the beent to appreciative audiences by Mr. W. Herrod on both days.

## HUNTS BEE-KEEPERS' ASSOCIATION.

### ANNUAL SHOW.

The twenty-first annual honey show of the above Association was held on July 15 in the admirably appropriate surroundings of Buckden Towers, near Huntingdon, the seat of Colonel Sir Arthur W. Marshall, Chairman of the Association.

The exhibits, though not numerous, were of first-class quality. Mr. Peter Scattergood, Stapleford, Notts, officiated as judge, and made the following awards:—

*Observatory Hive (with Queen and Bees).*—1st, Richard Brown, Somersham, Hunts.

*Six 1-lb. Sections (White).*—1st and B.B.K.A. Silver Medal, Allen Sharp, Brampton, Hunts; 2nd, Richard Brown; 3rd, Mrs. Allpress, Broughton, Hunts; h.c., Mrs. Allpress; c., M. Childs, Alconbury.

*Six 1-lb. Sections (Yellow).*—1st, Richard Brown; 2nd, Allen Sharp.

*Six 1-lb. Jars Extracted Honey.*—1st and

B.B.K.A. Bronze Medal, Richard Brown; 2nd, J. Osborne; 3rd, J. Collyer, Buckden.

*Six 1-lb. Jars (Medium Coloured) Extracted Honey.*—1st, M. Childs; 2nd, Mrs. Spencer, Holywell Manor, Hunts; 3rd, J. Osborne, Buckden.

*Three Shallow-frames Comb Honey for Extracting.*—1st and B.B.K.A. Certificate, J. Collyer; 2nd, J. Osborne; 3rd, J. Howland, Brampton.

*Beeswax (Light Colour).*—1st, Allen Sharp; 2nd, J. Howland; 3rd, Richd. Brown.

*Beeswax (Dark Colour).*—1st, J. Howland; 2nd, J. Collyer.—(Communicated.)

## Correspondence.

*The Editors do not hold themselves responsible for the opinions expressed by correspondents. No notice will be taken of anonymous communications, and correspondents are requested to write on one side of the paper only and give their real names and addresses, not necessarily for publication, but as a guarantee of good faith. Illustrations should be drawn on separate pieces of paper. We do not undertake to return rejected communications.*

*Communications relating to the literary department, reports of Associations, Shows, Meetings, Echoes, Queries, Books for Review, &c., must be addressed only to "The Editors of the British Bee Journal," 17, King William-street, Strand, London, W.C." All business communications relating to advertisements, &c., must be addressed to "THE MANAGER, 'British Bee Journal' Office, 17, King William-street, Strand, London, W.C."*

### NOTES BY THE WAY.

[5180.] We have now had nearly a month of fine weather in this district, and how much of the apicultural work of the year has been crowded into those twenty-eight days only the bees and their owners know. In my own hive records I find an entry: "June 20, 1 lb. syrup." In fact, feeding had to be constantly done till the longest day; then the change came, and the bees worked as they only can and do work when real bee-days come. Stocks which a week previously were on the verge of starvation were soon rolling in a wealth of honey. Supers were rapidly filling, and thus repaying us and all bee-keepers for the care and attention given in the dull, wet days of early June. The period of swarming was very quickly over with us; it came with a rush, and finished abruptly as it began, while there were very few "smarts" or casts. This arose mainly, I believe, from many of the stocks having already superseded or were about to supersede their queens; thus some top swarms were headed by 1903 queens instead of those of the year previous. In this way, stocks having sent out a good size top swarm (in fact, some swarmed themselves nearly clear of bees), settled down without any further swarming. Then as the fields of bee-pasturage were laid by the mower, there was a great falling off in the honey-income, which again reduced the swarming instinct, and the cessation of income continued till the



limes bloomed (a full week later than usual), this also reduced the chance of two swarms.

*Bees Shaking Themselves.*—In reply to the remarks of "Bridgefield" (5,161, p. 272), I have, on opening hives for examination, many times seen bees shake themselves on the combs, and have always taken it to be the bees' method of showing resentment, at my having invaded the privacy of their home. A slight puff of smoke causes the bees to cease their "shaking," but when the effect of the smoke is gone the bees will commence running and shaking themselves like a naughty child in the "tantrums."

*Insurance for Bee-keepers.*—Without wishing to cavil at the method of insurance, I feel sure that if each apiary had been allowed to insure for benefit up to a certain sum in case of damage or accident, and the scale of payments had been from 1s. per year for small apiaries, 2s. 6d. medium, and five shillings for large apiaries, that the amount paid in premiums would have been larger than at present; in fact, I believe if the premiums had been "pooled" by the B.B.K.A. that we could have insured ourselves, as in a few years—if we had been fortunate in having only small demands on the fund—our aggregate sum would soon have accumulated. Thus giving us not only a compensating fund, but also a reserve fund; the existence of which would act as a deterrent on those claiming compensation, because they would know we should possess the "sinews of war" if they were in a fighting humour. Under the present system of insurance I may be told that if several cases had come up for compensation during the year they would all have been met, and probably the one case may have overlapped the premiums actually paid. But that would not, in my opinion, solve the matter, as the "insurer" would not care to risk the insurance if there was not a reasonable chance of some profit to be derived out of the transaction. Our Editors say: "It is expected the number of hives insured will be doubled this year," if so, will the amount of compensation be doubled also? and if the estimate of 50,000 be reached at 1d. per hive the nice little premium of £208 6s. 8d. will be ready to hand over to the enterprising member of "Lloyds," or whoever the gentleman may be who is ready to take the risk? Is it not time that our parent association took the matter into their own hands, and held the insurance premiums as a fund against possible contingencies?

*A Wider Standard Frame.*—Will those who have given these a trial also give their experience for the benefit of their brethren? For myself, having orders for more swarms than I could spare, I am unable to give the wide frames a really practical test. I have, however, two "casts" hived on six of Abbott's wide frames, all of which are worked out, and the top parts of comb sealed. These are built out beautifully flat and even. Had I been able to spare a good swarm for myself, and hived them on ten wide frames during the

honey-flow, I feel sure I should have secured frames of comb flat as a board, such as would have delighted the heart of any bee-keeper who loves to see bee-work finished in the highest style.—W. WOODLEY, *Beeton, Newbury.*

## OUR FAILURES.

### COMBINATION HIVES.

[5181.] In answer to "R. F." (5150, page 257), who asks for information as to the best way of managing a combination hive, I must begin by remarking that no one hive can be expected to possess all the virtues, and that the bee-keeper's aim should be to get the best value out of his hive of which its construction permits. It seems well to consider in what points the combination may be said to be at a disadvantage as compared with the "W.B.C.," and then how best to meet the objections. The points are as I take it: (1) Lightness, and consequent ease in handling; (2) shade from the outer case in summer, and consequent coolness; (3) power of working section and shallow-frame supers at the same time, and exchanging them at will; (4) facility in disinfection.

To meet them (1) have the roof and lifts made as light as possible;  $\frac{3}{4}$ -in. board is quite enough, and cover the roof with the thinnest zinc procurable. Zinc roofing is often quite needlessly thick. The loose hinges supplied by Mr. Baldwin, which are of much the same pattern as those described by Cheshire in "Bees and Bee-keeping" (Vol. II., p. 63), will be found advantageous for the roofs and lifts. The long hive-body must needs be heavy. I have found that two full-sized, shell-shaped metal handles, screwed on to each side, are a great convenience in lifting, and do away with the necessity, so formidable to the casual assistant, of catching hold close to the entrance. (2) Place your hives in partial shade, natural or artificial, paint the roofs white, and on the approach of summer raise the hive bodies by means of wedges. (3) By using the hanging-frame section supers now made by more than one maker, and reducing the length of the ears, or lugs, of his shallow frames, anyone can devise for himself interchangeable supers. (4) With due care any hive can be disinfected. Do not scorch the interior lining boards of the hive sides while still damp, or they will crack.

The "Combination" bee-keepers should not fail (1) to utilise the many advantages of being able to expand or contract the brood-nest, especially in meeting the wants of very fertile races, such as Carniolans, and he should bear in mind that he can add to or diminish the number of frames, or supply stored combs in time of need, without disturbing the supers. (2) When inspecting the brood-nest he can isolate any special frame by placing it behind the dummy. (3) In uniting colonies, the extra space will give advantages that need

not be explained in detail. By adding an entrance at the back of the hive, a nucleus may be made at any time and kept warm through the winter. (4) Feeding behind the dummy is best done by having an entrance cut in it, to be closed either by a slide working downwards, or by adding a second entire thin dummy behind the other. Combs can be more surely got cleaned out and repaired after extraction in this way than in any other, and without disturbance.

I have never found any disadvantage in having frames parallel to the entrance. Three square-cut strips of wood over the frames in winter make all safe. They should be bevelled downwards at the ends, so as to let the soft covering (calico and felt quilting) fit close down at the edges of the brood nest, and prevent unwelcome draught.

It has been suggested to me since writing on "Our Failures" that a feature in combination hives is the extension of the hive walls above the level of the top bars of the frames, with the idea of protection from the wind during manipulation. Such a method of construction would be very objectionable, and the object desired can easily be obtained by using a special 3-in. lift.

I beg to add that I have no wish to figure as the champion of any particular hive. A beginner should choose the one he thinks best suited to him, and set himself to make the best of it.—H. J. O. WALKER, Lieut.-Col., *Budleigh Salterton, Devon, July 18.*

#### THE "RYMER SYSTEM."

[5182.] Mr. Rymer has demonstrated that bees give more clover honey in the Levisham district with a brood-nest of twenty frames than when restricted to a brood-nest of ten frames. This, it seems to me, is the most significant feature in Mr. Rymer's successful experiments. If bees at Levisham succeed better on twenty combs, why should not similar results follow in more favoured districts? Everything appears to depend on the prolificness of a young queen. Mr. George Wells, of Aylesford, demonstrated the same thing, with the difference that he extended his brood-nest laterally and made use of two queens in each hive. If it is a fact that queens can lay 3,000 eggs per day, a queen will soon fill a ten-frame brood-nest, and if given, in addition, ten sheets of brood-foundation, either at the sides or top of the brood-nest, she could fill those additional ten frames in three or four weeks. I cannot speak from experience, but it seems that "Wells" hives might be more successful with one good queen than with two, and they would swarm less.

When the present standard hive was adopted brood-foundation had not been invented, or, at least, was not in general use; and without the aid of brood-foundation Mr. Rymer's twenty-frame hive would have been

impossible. I have often noticed the present size of the standard brood-nest criticised in the BEE JOURNAL, and it may be that the matter will not rest where it is for ever. [There is no "Standard hive" and no "standard brood-nest."—EDS.] Mr. Rymer was surprised to find that his clover-crop increased with a twenty-frame brood-nest, but he deprives them of ten frames three weeks before the heather harvest. Is it not possible that there would be another pleasant surprise in store for Mr. Rymer if he allowed the twenty-comb brood-nest to remain intact throughout the heather harvest? If the Rymer system does not lead to a twenty-frame brood-nest all the year round, but continues as at present with its difficult manipulations to be performed—in July to restrict the queen, and in early August to take out ten of the combs—I think it may be found that a brood-nest extended laterally would be easier to manage, as the queen-excluder could be dropped in the centre of the twenty combs without looking for the queen. The hive afterwards to be prepared for the moors by taking out ten combs, moving the then reduced brood-nest to the centre, and filling the side spaces with surplus receptacles, as well as placing surplus-chambers on the top of the restricted brood-nest. If a swarm came out of a single queen "Wells" hive such as I suggest, how easy it would be to hive the swarm in the usual way, divide the twenty frames by inserting a "Wells" dummy, and thus get (by taking the necessary precautions) two young queens mated, and send a two-queen "Wells" hive as well as a good swarm to the moors.—JOHN N. KIDD, *Stocksfield, Northumberland, July 17.*

[We print the above communication as written, but we cannot ourselves recall any part of Mr. Rymer's system as applying to a clover district or to clover honey at all. It seems to us that the whole of his efforts are devoted to preventing swarming and breeding bees right up to the middle of July, at which time the clover harvest has ended. Again, with regard to the "Wells" system, we do not remember having heard of Mr. Wells allowing a brood-nest of more than ten standard frames to one queen.—EDS.]

#### LANTERN SLIDES FOR LECTURES.

[5183.] You have more than once permitted me to use your valuable columns for the purpose of making requests to our brethren of the bee-keeping craft, and the kindly response I have hitherto received emboldens me to again address myself to those who have the interests of sound bee-keeping at heart. The object for which I wish to enlist help is the enlargement and renovation of the stock of lantern slides belonging to the British Bee-keepers' Association. Those now in use were good years ago, but time, wear and tear, accident, and other causes have made serious inroads on

their number and usefulness, and it is now desirable to thoroughly renovate them. Of late years the study of bee-keeping and the practice of photography has become so general that there must be in the country a large number of most interesting lantern-slides or photographic negatives from which lantern slides could be made. It will greatly assist the Council if owners of slides or negatives of special interest, which they are willing to part with either by gift or purchase, will kindly communicate with me (by letter only), giving full particulars, which I can place before a committee. Examples of every branch of the subject will be acceptable, scientific or practical. Good illustrative slides of handling bees in proper fashion will be very welcome.

Thanking you for the kindly hospitality of your columns,—THOS. I. WESTON, Vice-Chairman, B.B.K.A., 3, *Balham Park Mansions, London, S.W.*

### PROFITABLE SWARMS.

[5184.] Reading in this week's issue of Mr. Lowth's profitable swarm (2,177, page 285), I thought it might be interesting to give an account of work done by a swarm I had last year. The swarm in question issued on June 19 and weighed 8 lb. I hived them on nine frames, four of which had drawn-out comb. The swarm was placed on the stand of parent stock and I gave them a rack of sections fitted with full sheets of foundation. Seven days later I gave them second rack of sections, fitted as before. On July 1 I put on a third rack with starters only, and on the 5th took off the first two completely filled with white clover honey, some of which took first prize at our local show. On July 28 I took off twenty more sections and two frames of honey from brood-chamber, weighing 8 lb., making a total weight of 70 lb. surplus honey in rather less than six weeks, besides leaving enough for them to winter on. The stock came through very well, but in May I found them queenless, so that I had to unite the bees to another stock. I think this would take some beating in a district where the honey-flow only lasts about six weeks; in ordinary seasons from the beginning of June till the middle of July. My average for four frame-hives last year was 48 lb.; this year has so far been disappointing, for with ten hives I shall get but little more. I have had no swarms this year, but in 1902 I was troubled with them exceedingly, all my stocks swarming; but the swarms were all returned, including the one mentioned above, but they issued again next day. One swarm decamped during my absence from home.

So far this season I have up to now only taken off thirty-six sections, which are not up to show standard, though well filled. The capping resembles a mosaic pavement in the multitude of tints.

My bees are gathering just now some honey

which, when held up to the light, looks a greyish tint in cells, but tastes all right. Have you any idea what source it is likely to be from? Would it be beans? There are several acres of these within a quarter of a mile of my apiary. [We should say, Yes.—EDS.]

I enclose my name, while signing myself,—  
"MID OXON," July 17.

### "A FOUL BROOD DUMMY."

[5185.] At the outset, and in self-defence, I would say that I have been unable to take the letter of your correspondent, G. F. Gilliland (5,179 p. 286), upon this subject other than seriously—how seriously may be judged from the fact that I am moved, perhaps by the "Spirit of the Hive," to comment upon this further addition to the ranks of our "dummy" army, the latest number by the right upon the B.B.J. file.

I was at first tempted, I must confess, to swallow the new remedy *cum grano salicylicis*, but after digestion and the mature, if light, reflection—which is supposed, X-ray fashion, to help the process—I have been convinced, not only of the serious intentions of the remedial inventor, but of the absolute, even above proof, purity of the spirit of the mediatorial inventory.

It is, however, with exceeding diffidence that I take a hand in this new game of "dummy," fearing lest tricks of speech be taken seriously and that the gentle creature turn and rend me with my own clause, leaving not wherewith to patch or dispatch, as with more fear I venture—unprotected even by a "Burkitt glove"—to soothe and operate upon this poisonous affair, which, if indeed its mouth be bound and muzzled and dumb, has yet the breath of a dragon, flavoured with sting of a bee even unto three places of decimals!

Speaking for the "dummy" is a somewhat thankless task, at least verbally, and one in which, if one's tongue is not tied in a knot of negative virtue, the most one can say is that it has not a good word to say for itself, whence perhaps, it may be argued, the more necessity for a *Vox mutorum*.

To be still serious, either or both, and to avoid further vapouring, if such a state be possible in such a formic atmosphere, is it not possible that the remedy may be worse than the disease, and that our plague of rabbits may give place to a plague of cats—a not unheard-of substitution even in this part of the world?

Is it not also possible, knowing as we do the effect of the natural vapour upon the temper of these Amazons, that, by its continued suggestion, they may be assiduously stirred to do doughty deeds, their very bandsmen working wonders of tattoo upon the drums of our person?

Or conversely, that the "odour of wrath" being, poecrlike, always with them, they may

be so used to its adversity that they would suffer pillage and wreck with impunity, their nostrils being superhabituated to the scent of the drawn weapons of the guard?

I have no desire to brand myself as some youthful scoffer of many scoffs, but yet—and yet—youth must have its fling, even at a dummy, which may not have been put up—Aunt Sally fashion—merely to be knocked down, and I fear that a belated apology would appear very much the attitude of the lad who cries “stop” after he has struck the only blow. Yet, lest I should dissuade any from testing what may be of value, and lest my criticism should be taken too seriously by an inventor, who, for all I know to the contrary, may be as serious as I am myself, I would label the foregoing *Seulement pour rire*.

A little knowledge is a dangerous thing, but its terrors are too far from me to be apparent, and I would fly rather from the wotted evils and insecurity of a little ignorance; even to jumping from the dark blackness of the frying-pan into the blinding light of the fire of scathing criticism; a badly bitten biter, need I say after this, mataphorically speaking.

In the case, however, of an article recommended for sale, one is justified in asking for its credentials, and in the present case there is every need for detail as to the experimental cures already accomplished.

It has been stated in the past that formic acid is a deterrent of foul brood, but it is doubtful if it has ever had its value as a cure satisfactorily established, as honey containing that acid has been known to communicate the disease after long periods.

If the spores will retain their vitality when exposed to the direct action of the acid, can it be possible that an extremely dilute gas can purge the hive, whilst even the rigorous formaldehyde treatment, from which we are hoping so much, is open to the possible objection that it may fail to reach spores embedded in the comb?—L. S. CRAWSHAW, *Ukley*.

#### A SWARMING INCIDENT.

[5186.] Is not the following incident unusual? On Monday last I was asked by a bee-keeper to go and hive a swarm for him. I agreed, and found the swarm had clustered at the top of a high tree. I procured a ladder and mounted the tree, then shook all the bees I could into the skep and secured a good part of them, but the main part of the swarm took wing and decamped. I followed them over several fields and gardens till they again clustered, and I promptly hived them and secured the queen this time, then carried them back to the owner. After five o'clock in the evening I picked out and killed another queen, and returned the swarm to parent hive.

On Wednesday (July 15) I was sent for by another bee-keeper, who also had a swarm, and wanted the queen taken away. This was about three o'clock, and the bees had been

clustered on a tree since ten in the morning. I shook them into the skep, and, to my surprise, I saw two queens, both of which I secured in a match-box. I then saw several others, and in all I took out five queens. I then left the bees, thinking they would return to parent hive, but to my surprise they have started work and stopped in skep; so you see they must have had six or more queens! This is a fresh experience to me.—A. B. B., *Essex*.

#### SECTIONS FOR HEATHER HONEY.

[5187.] My reply to Mr. J. Walton (page 274) should read—“I have no doubt that the long sections as used by himself are made strong enough, but might not be so made by another beekeeper using the same.” Mr. David Raitt writes me to say he does not make a long section, but sends an address where I may be able to obtain them, to which I have written.—GEORGE M. SAUNDERS, *Keswick*.

[By a printer's error Mr. Walton's name was printed “Walker” on pp. 244 and 276.—EDS.]

#### THE B.B.J. IN THE ANTIPODES.

[5188.] I became a subscriber to your valuable paper through our local bookseller at the latter end of last year, the first number I have being September 4, 1902, so that if complete volume for that year is not available, should be glad of as many numbers as are obtainable for the weeks preceding that date back to January.

Though out here in the Antipodes, and only a novice in apiculture, I read your paper with a great amount of pleasure and profit, and through its medium have learned many valuable hints to apply in these parts. Thanking you in anticipation,—A. D. KENWORTHY, *Lanunceston, Tasmania, June 8, 1903*.

[We are pleased to have your appreciation of our journal, and have forwarded back numbers to complete the volume for January to August as desired.—EDS.]

#### PRICES OF FOREIGN HONEY.

[5189.] The following item, taken from the *Manchester Guardian* in its report of the Liverpool Produce Market of yesterday, may be of interest:—

“Honey.—Fair sales of Jamaica have been effected at 20s. per cwt.”—W. R. W., *Northenden, July 15*.

#### WORKING FOR HEATHER HONEY.

THE RYMER METHOD.

(Continued from page 287.)

Now comes the sequel in obtaining a large crop of heather honey in the twelve or fourteen days given in which to gather it. About July 15 I take off all finished sections and also extract the honey from all unfinished ones

This generally occupies two days. The next thing, I first drive down—by smoking—all the bees I can out of the top brood-chamber into the bottom one. I then lift off the top one, and, after removing the queen-excluder from top-bars of the latter and setting it on those of the bottom brood-chamber, each comb is lifted and the remainder of the bees brushed from them on to a board in front of the hive before replacing the fames and setting the extra brood-box above the queen-excluder now on top of the ten original brood-frames left in the lower hive. Thus, the extra brood-chamber now stands above the zinc and the queen is confined below. After remaining on the hive for three weeks—to allow all brood to hatch out—the extra box is then taken off each hive and replaced by "W.B.C." section-racks. It will be readily understood that it takes two or three racks to accommodate the enormous lot of bees in each hive. The heather is in full bloom about August 12, so that every hive is so strong in bees that given a fair chance on the heather, every colony so prepared will give a good account of itself.

It is now clear to my mind that every "W.B.C." hive is a non-swarming hive of the very best kind if the bee-keeper chooses to make it one, and certainly no other hive at present on the market so completely lends itself to my system of working. Just see what a scope one has in securing plenty of bees by means of this additional brood-chamber!

I also make it a point to renew the brood-combs in each hive every fourth year, and to do this the hives that are on turn for re-combing are specially dealt with. Instead of setting the extra ten frames on the top as described above, the brood-nest is lifted off the floorboard, and the box of new frames takes its place at the bottom. The old brood-combs are removed when the time comes. Then there are the new frames of comb removed from the hives in August. Why, they are a veritable gold mine to a bee-keeper! If you wish to extend your apiary, all you have to do is to get a few lots of driven bees, put them into your brood-boxes filled with honey taken off in August, and you have an established stock immediately the bees are run in. Or you can re-comb other hives just as you please, and no feeding required. I use those combs for my "Wells" hives, giving to each four new combs every year. I have stated above that the combs of all my single hives are renewed every four years; but I am thinking seriously of doing it every second year, as I find those with new combs nearly always do the best. In writing as above there is no attempt to say that my system would be a profitable one in every district. Each bee-keeper must make himself fully acquainted with the bee-flora of his locality, and the time when the main honey-flow may be expected; this done, he should work accordingly. To those situated like myself, who are in posses-

sion of the proper hive, I would say, give my system a trial, and at the end of the season send on your experience to the B.B.J., and I think you will be satisfied. To my readers in the south, whose honey harvest comes much earlier than ours, try a shallow-frame box on the top of the brood-nest; let the queen have free access to this box, and note the result.

The only thing further that requires mention is a slotted adapting-board of my own devising, one of which boards is provided for every hive, and remains on at all times, being placed overhead with the slots running across top-bars of the brood-nest proper. When the second brood-chamber is added in May, the "adapter" is then between the two. But when the extra brood-chamber is removed for the heather season, the "W.B.C." section-racks are placed over this board and all excluder-zinc removed, so that the bees have free access into the sections. And when all this is cleared off at the end of the season, the board left on forms one of the best winter passages possible. It also prevents any brood combs between the two brood-chambers during the swarming season. Anything not clearly understood, I shall be glad to try and explain through the B.B.J.

Briefly stated for the use of those who care to try my plan, I may say:—These adapting-boards (made of thin wood) are  $17\frac{1}{2}$  by 16 in., and there is a plain margin of  $1\frac{1}{2}$  in. all round. The slots, or passage-ways, of which there are ten in all, are 13 in. long and  $\frac{1}{2}$  in. wide. They run parallel with the shortest side of the board, *i.e.*, 16 in. outside measure.—J. RYMER, *Levis-ham Station, Yorks.*

## Queries and Replies.

[3165.] *A Beginner's Difficulties.*—I shall be grateful if you will advise me what to do with an apiary that has just come into my possession? I am totally inexperienced in bee-keeping, but have a great desire to learn, and already feel a great interest in the pursuit. There are six hives in all. No. 1. A frame-hive into which a swarm from No. 3 was put early last summer. They were left undisturbed at the time, but fed a little during the winter. The bees seem numerous and strong, and a swarm issued at end of June last. There is a rack of sections lately placed above the frames. No. 2 is a frame-hive tenanted by a swarm from No. 3, hived at end of June, and this stock also seems strong and busy. No. 3 is a straw skep into which a swarm was put in May, 1901, and it has been undisturbed ever since, except by giving food during winter, and at end of June it sent out the swarm now hived in No. 2. No. 4; also a skep tenanted by a small swarm, June 16, 1902, and undisturbed since. No. 5, a skep tenanted by the swarm from No. 1, named above as coming at end of June. No. 6, a

skep in which a wandering swarm was hived about a fortnight ago. I have also a small box containing a rack of fifteen sections for placing on a skep as a super. This then is my "stock in trade," and I ask—1. Had I better use the super at once, and, if so, on which hive should it be put? 2. How can I get the bees out of No. 3? I do not wish to have more than four hives for a year or two; indeed, three would be as many as I could manage properly. I have Mr. Cowan's "Guide Book," and mean to take in the BEE JOURNAL regularly. For the rest I have a large stock of patience to draw upon; but I want to start fair, so if you would be good enough to advise me, I shall be deeply obliged. I enclose name, while signing BYNEA (A Lady Bee-keeper), *Cardigan, S. Wales, July 17.*

REPLY.—On the general question of reducing the number of stocks in your charge by one-half, viz., to three hives, we should advise selling the surplus ones outright if a purchaser can be found. As a matter of choice you had better retain the stocks numbered 1, 2, and 3, and sell the others. In reply to the queries enumerated we answer: 1. It is of little use giving surplus chambers so late in the season as this. 2. You might drive the bees—as directed in "Guide Book"—and unite them to No. 2, after removing the old queen from the latter.

[3166.] *Re-queening Swarms.*—Kindly advise me in next B.B.J. on the following:—I hived a swarm a fortnight ago, and, on examining the frames yesterday, I found no trace of any brood in combs. By this I presume the stock is queenless, though the bees have been storing honey well, and are very strong. I therefore ask: 1. If I insert a comb of brood from another hive, in the centre of the swarm, will they rear a queen for themselves? 2. If the brood given is all capped over, will it do? or must there be eggs and also uncapped brood. My sight being bad, I could not see the eggs; but, in case there must be both uncapped brood and eggs, would there not be a better chance of having the eggs in a frame that has little capped brood? If they would rear a queen from such, I would prefer their doing so to my having to purchase a queen and introduce her. 3. The swarm are natives, but the brood I propose to give would be Italian; would this make any difference?—F. JELLICO, *Mountmellick, Ireland, July 18.*

REPLY.—1. If the swarm hived a fortnight ago is really queenless (which is not certain) the bees will rear a queen on having a comb of suitable brood given them. 2. Bees cannot rear queens at all from capped brood or from larvæ more than three or four days old at most. In selecting a frame of brood select one with eggs and plenty of unsealed larvæ, from the tiny grub only just hatched to those of larger growth. 3. None at all.

[3167.] *Transferring from Skeps to Frame-Hives.*—In the spring I transferred three skeps into frame-hives according to directions on pages 140 and 141 of the "Guide Book." The colonies are now very strong, and are working hard. The old combs in the skeps, so far as can be judged from looking through the feed-hole at the top, are filled with honey and sealed over. I have never examined the hives since transference, and therefore ask if you advise me to remove the skeps and to see what honey there is in them? Also should I take away the American cloth above the top-bars and place a queen excluder between frames and skep before replacing the latter, or would you leave them alone till after the honey-flow? I thank you for your former courtesy in answering my very elementary questions.—NEMO, *Kent, July 16.*

REPLY.—In view of the brief time remaining before honey-gathering ends for the season, it will be the best course to leave the skeps on as they are, and, when the harvest closes, remove them and extract contents.

## Bee Shows to Come.

*A nominal charge of 2s. 6d. is made for notices in this column, which covers cost of insertion from order till date of show. Cash should accompany orders for insertion.*

July 29, at Wallop, Hants.—Honey Show of the Broughton and Wallop Branch of the Hants and Isle of Wight Bee-keepers' Association.

July 29, at Henbury, near Bristol.—Annual Show of the Henbury District Bee-keepers' Association in connection with the Horticultural Society's Exhibition. Several open classes with good prizes (two classes with free entry). Schedules from I. Atkin Waller, hon. sec., Pen Park, Westbury-on-Trym, near Bristol. Entries close July 24.

July 29, in Swanmore Park, Bishop's Waltham.—Honey Show of the Swanmore Branch, Hants and Isle of Wight B.K.A., in connection with the Bishop's Waltham Horticultural Society. Local Classes for Comb and Extracted Honey, Honey Trophy, &c., and Classes for Sections and Extracted Honey Open to Members of the County B.K.A. Schedules from Miss Martin, Secretary, Swanmore, Bishop's Waltham.

July 30, at Yeovil.—Annual Show of the Yeovil and District Bee-keepers' Association. Three prizes in open class, 15s., 10s., and 5s. Schedules from the Hon. Secs., Everton Watts, Mansion House, Yeovil, and G. W. Perry, 81, Middle-street, Yeovil.

July 30, 31, and August 1 and 3 at Old Trafford, Manchester.—Annual Show of the Royal Lancashire Agricultural Society. Liberal money-prizes are offered for honey along with silver and bronze medals of the B.B.K.A. and also of the Society. Open classes for Honey-Trophy, Sections, Extracted Honey, Beeswax, Honey-Confectionery, Bee Flowers, Instructive Exhibits in Bee-Culture, &c.

August 3 (Bank Holiday), in the Walled Meadow, Andover.—Honey Show in connection with the Andover and District Horticultural Society. Class for single 1-lb. jar of extracted honey (with no entry fee). Also classes for sections, extracted honey (light and dark), and beeswax. Schedules from the Hon. Sec., Dr. Gillett, Elvin House, Andover. Entries close July 28.

August 3 (Bank Holiday) at Melton Constable Park. Annual Show of the North Norfolk B.K.A. Schedules from the Hon. Sec., C. J. Cooke, Edgefield, Melton Constable. Entries close July 27.

August 4, at Leamington.—Tenth annual show of the Leamington St. Mary's Horticultural Society.

Three open classes for Six 1-lb. Sections, Six 1-lb. Jars "Light," and Six 1-lb. Jars "Dark" Extracted Honey, respectively. Liberal money prizes. Schedules from P. W. Smith, Secretary, 22, Leam-street, Leamington. **Entries close July 30.**

**August 6, at Nantwich.**—Honey department of the Cheshire Agricultural Society's Show under the management of the C.B.K.A. Numerous classes for hives, honey, and wax. Money prizes and medals.

**August 6, at Kingsthorpe, Northants.**—Honey show of the Northants B.K.A., in connection with the Horticultural Society's Exhibition. Three open classes with special prizes, including one for single 1-lb. jar of honey. (*Entry free.*) Prizes 20s., 10s., 7s. 6d., and 2s. 6d. Schedules from E. Heford, Hon. Sec., Sunnyside, Kingsthorpe, Northampton. **Entries close August 1.**

**August 6 at Madresfield.**—Honey show of the Worcestershire B.K.A., in connection with the Madresfield Agricultural Show. Schedules from A. R. Moreton, Leigh, near Worcester. **Entries close August 1.**

**August 12, at Radstock, Bath.**—Honey show in connection with the annual show of the Radstock and District Horticultural and Fanciers' Association. Schedules from the Secretary, B. M. Clark, 1, Fox Hills Radstock, Bath.

**August 12, at Wye.**—East Kent Honey Show. Open Class for Single 1-lb. Jar Extracted Honey with no Entry fee. Prizes—1st, £1; 2nd, 10s.; 3rd, 6s. Schedules from Secretary, J. Tippen, Wye, Ashford, Kent.

**August 12, at Hardenhuish Park, Chippenham, Wilts.** Honey show in connection with the Chippenham and District Horticultural Society. Ten local classes for bees, honey, and beeswax. Open class for honey trophy. Prizes 20s. and 10s. Schedules from Wm. Small, Secretary, Market-place, Chippenham.

**August 12, in the Market Hall, Tavistock.** Devon B.K.A. annual show of honey, wax, bees, and appliances, in conjunction with the Exhibition of the Tavistock Cottage Garden Society. Schedules from E. E. Scholefield, Heathfield, Chudleigh, S. Devon. **Entries close July 31.**

**August 13, at Bath.**—Honey show in connection with the Annual Show of the St. Saviour's Horticultural and Industrial Society. Held in Kensington Meadows. Seven local and seven open classes (including one for single 1-lb. jar of honey with free entry), for six sections, six 1-lb. jars extracted honey, three shallow-frames comb-honey for extracting, and for collection of honey, also honey products. Also for collection of bee appliances and observatory hives with bees. Schedules from C. J. Calvert, hon. sec., 10, Eastbourne, Bath.

**August 13, at Goole.**—Bee and Honey Show in connection with the Goole and District Agricultural Society. Six open classes, including one for single 1-lb. extracted honey (with free entry). Schedules from J. Luddington and H. S. White, Secretaries, Lindum House, Goole. **Entries close August 8.**

**August 15, at Chorley, Lancs.**—Classes for six 1-lb. jars Extracted Honey and six 1-lb. Sections. Open to the county. Schedules from Peter Hodgkinson, Secretary, Chorley Agricultural Society, Town Hall-square, Chorley, Lancs.

**August 19, in the Great Western Park, New Swindon.**—Wilts B.K.A. County Show of Bees, Honey, &c. Fifteen classes in all, five open to all England. Schedules from the Hon. Sec., W. E. Burkitt, Buttermere Rectory, Hungerford, or from local Hon. Sec., S. W. Filtness, Market House, Marlborough-road, Swindon. **Entries close August 10.**

**August 19 and 20, at Shrewsbury.**—Annual show of the Shropshire B.K.A., in connection with the Shrewsbury Horticultural Society's Great Floral Fête. Seven open classes for honey. Schedules from S. Cartwright, hon. sec., Shawbury, Shrewsbury. **Entries close August 7.**

**August 22, at Hawkshead, Lancashire.**—Honey show in connection with the Hawkshead Horticultural Society. Open classes for Six 1-lb. Sections and Six 1-lb. Jars (medium or dark) Extracted Honey. Prizes 10s., 6s., and 4s., and medals of the L.B.K.A. Schedules from Dr. Allen, Hawkshead, Lancs. **Entries close August 15.**

**August 22, at Barnton, near Northwich.**—Honey department of the Flower Show. Local classes for light and dark honey, sections, and beeswax. Open for twelve 1-lb. jars extracted honey open to county and members of the Cheshire B.K.A. First prize,

silver medal of the C.B.K.A. and 15s. Schedules from Mr. S. Wade, Heathside, Barnton, Northwich. **Entries close August 15.**

**August 25, at Cartmel, Lancashire.**—Honey show in connection with the Cartmel Agricultural Society. Open classes for sections, extracted honey, and beeswax. Local classes for sections and extracted honey. Schedules from Wm. Cragg, Secretary, Cartmel, via Carnforth.—**Entries close August 13.**

**August 26, at Reading.**—Honey Show of the Berks B.K.A., in conjunction with the Annual Exhibition of the Reading Horticultural Society. Open classes for comb honey in sections and for extracted honey. Local classes include prizes of 20s., 15s., 10s., and 5s. for honey trophy. Also classes for owners of small apiaries. Schedules from D. W. Bishop-Ackerman, Hon. Sec. Berks B.K.A., 131, King's-road, Reading.

**August 27, at Llangollen.**—In connection with the fifth annual Flower Show. Open classes for Six 1-lb. Sections, Six 1-lb. Bottles Extracted Honey, and Beeswax. Schedules from Frank Little, Castle-street, Llangollen. **Entries close August 13.**

**August 27, at Montgomery.** in connection with Montgomery and District Horticultural Show. Open classes for Six 1-lb. Sections and Six 1-lb. Jars, Extracted Honey. Prizes in each class 10s., 6s., 2s. 6d. Entrance-fee 1s. each. Schedules from W. J. Jones, Secretary, Montgomery. **Entries close August 20.**

**September 5 to 12, at the Agricultural Hall, London.**—Honey show in connection with the Confectioners', Bakers', and Allied Traders' (11th) Annual Exhibition and Market. Numerous classes and liberal prizes for comb and extracted honey and beeswax. **Open to all British Bee-keepers.** Special attention is directed to the new **Honey-selling Classes with Free Entry.** Schedules (now ready) from H. S. Rogers, Secretary, Exhibition Offices, Palmerston House, Old Broad-street, London, E.C. **Entries close August 19.**

**September 17, 18, and 19, at Crystal Palace, Surrey, B.K.A.** Annual Exhibition of Bees, Honey, Wax, and Appliances, &c. Twenty-four classes (ten open to all). Increased prizes and medals. Schedules from F. B. White, Secretary, Marden House, Redhill, Surrey. **Entries must be made before September 1.**

**September 19 to 26, at the Agricultural Hall, London.**—Honey Show in connection with the eleventh Annual Exhibition and Market of the Grocery and Kindred Trades. Numerous classes and liberal prizes for comb and extracted honey and beeswax. **Open to all British Bee-keepers.** Special attention is directed to the new **Honey-selling Classes with free entry.** Schedules from H. S. Rogers, Secretary, Exhibition Offices, Palmerston House, Old Broad-street, London, E.C.

**October 6 to 9, at the Agricultural Hall, London.**—Show of Honey and Bee-product in connection with the British Dairy Farmers' Association. Numerous and liberal prizes for honey, &c., including the valuable Silver Challenge Cup of the B.B.K.A. Schedules from Mr. Wm. C. Young, Secretary, 12, Hanover-square, London, W.

### Notices to Correspondents & Inquirers.

*Letters or queries asking for addresses of manufacturers or correspondents, or where appliances can be purchased, or replies giving such information, can only be inserted as advertisements. The space devoted to letters, queries, and replies is meant for the general good of bee-keepers, and not for advertisements. We wish our correspondents to bear in mind that, as it is necessary for us to go to press in advance of the date of issue, queries cannot always be replied to in the issue immediately following the receipt of their communications.*

\* \* \* A correspondent writes:—Can any one tell me of a good town with 20,000 or over of population, within two or three miles of which is a good situation for bee-keeping? A town where good schooling could be

- obtained for children, and which has, if possible, tram lines running out of it into the country. The beehives should, of course, be within reach of bee-forage such as white clover and sainfoin.—AMATEUR BEE-KEEPER, *Gloucester*, July 16.
- T. L. C. (Chadwell Heath).—*Drone-Breeding Queens*.—There is no disease in comb, but queen is obviously a drone-breeder, seeing that all the sealed brood is drone larvae being reared in worker cells. The second stock mentioned as having either a fertile worker or a worn-out drone-breeding queen at its head may be requened with advantage by introducing the surplus young laying queen on hand. Once the young queen is accepted, the worn-out one, or the fertile worker—as the case may be, will soon disappear.
- “IGNORANT” (Bath).—*Ownership of Truant Swarms*.—It would help no one but yourself to publish replies to the queries sent without giving the descriptive particulars of what took place, as detailed in your letter. On the general question, however, of legal ownership of runaway swarms, it is, we think, defined by Blackstone as requiring the bees to be seen issuing from the hive, and kept in sight while followed till they enter the premises where they cluster, or enter a hive as the case may be. Thus followed—by the owner or some one on his behalf—the swarm can be legally claimed and taken possession of, the said bees being practically under such control as a runaway dog would be if followed by its owner. On the other hand, if the swarm is not kept in sight and claimed as stated, the bees become (in law) “wild bees,” *fera natura*, i.e., any one's property who happens to secure possession of them.
- D. M. CARNEGIE (Haddington).—*Chilled Pupa Cast Out*.—There is nothing “wrong,” more than the pupæ sent have got chilled to death just before hatching, and the bees, after removing the bodies, have cast them out from the hive.
- F. L. P. (Yorks).—*Buying Faulty Honey*.—The honey sent is decidedly fermenting and not fit for table use.
- E. EMERSON (Glos.).—*Dead Queen Cast Out*.—The dead queen sent is a Carniolan-Ligurian hybrid and obviously a virgin.
- H. C. MARSHALL (Collingham).—*Wiring Foundation*.—The sample of wire sent is too thick for wiring foundation in frames. “No. 30 tinned wire” is the most suitable, and no other should be used.
- A YOUNG BEGINNER (E. Dereham).—*Driving Bees from Wood Box*.—If you can fix a second box over that containing the bees they may be driven as from skep to skep.
- J. REAVELEY (Harrogate).—*Queen Cast Out from Swarm*.—1. The young dead queen cast out and the smallness of the swarm indicates that the hive referred to had sent out a swarm unseen, and that you hived the second swarm or cast. It is quite common for two or more young queens to accompany these after-swarms. 2. If our assumption is correct no further swarm is likely to issue.
- J. M. E. (Ross-shire).—*Decoy Hives*.—We will reply to your letter next week.
- R. L. S. (Formby).—*Re-queening Stocks*.—1. Queen cells should be started in three or four days at most after removal of parent queen. If none were seen six days after removal of old queen, as stated, it is certain the bees have no intention of requeening themselves at all. 2. Should you carry out the idea of taking away a second queen, give her to the stock first operated on. 3. It is rare for bees to make no effort to replace a queen taken away at this season.
- J. C. (Hants).—*Bees Refusing Foundation*.—We cannot accept the assurance that foundation sent is the genuine “Weed” make. Nor have we ever heard a case of the latter being refused by bees. Why not write the dealer who supplied you, and ask if it is guaranteed to be the genuine “Weed” as stated. He would hardly do this (knowing the contrary) if appealed to.
- EUCALYPTUS (Rugby).—We will reply fully to yours next week.
- G. H. L. (Devon).—*Sources of Honey*.—We think the honey is from mixed sources such as gorse and dandelion, or may be blackberry. It is dark in colour, but by no means bad in quality. A deal of the honey gathered this season is altogether different in colour to that usually secured, and the reasons for this difference are so varied as to make it impossible to explain every case.
- Suspected Combs.*
- J. W. L. (Keswick).—Though there is foul brood in comb, the case is one for treatment, if help could be got from an experienced bee-keeper in dealing with it. The sample of comb shows that you do not yet understand the nature of the disease or the effect of carbolic acid on the larva of the bee. Most of the dead brood in comb seemed to have been killed by spraying carbolic acid on them in some way, and much of the sealed brood was hatching out. Indeed, the greater part was in the pupæ stage, and if left in the hive would have hatched all right. A dozen or more bees had emerged from their cells in transit.
- W. M. W. (Kirkby Lonsdale).—Comb contains foul brood of old standing.
- J. V. C. (Cornwall).—Slight case of foul brood.
- F. LASHBROOK (Hants).—We find foul brood, but only in two cells of comb sent. Package was mislaid till to-day.
- A. B. C. (Herts).—Comb is affected with foul brood.

\*\*\* Some Letters and Queries are unavoidably held over till next week.



## Editorial, Notices, &c.

### GLAMORGAN B.K.A.

#### ANNUAL SHOW AT CARDIFF.

One of the finest and largest shows of honey and appliances ever seen in Cardiff was held at the Sophia Gardens, July 22 and 23, in connection with the Cardiff and County Horticultural Society. Though the season is somewhat backward, there were no fewer than 13 entries. The competition in light-coloured honey was exceedingly keen. The following awards were made by the Rev. W. H. A. Walters, and Messrs. R. T. Duncan and W. G. Preece, who judged the exhibits:—

*Twelve 1-lb. Sections.*—1st, C. Hood, Clevenstone, Bridgend; 2nd, G. H. Mitchell, Cardiff; 3rd, John Rees, Lisvane, Cardiff.

*Six 1-lb. Sections.*—1st, David George, Merthyr Mawr, Bridgend; 2nd, John Rees; 3rd, W. R. Ockwell, Peterstone.

*Three Shallow-Frames of Comb Honey.*—1st, R. Morgan, Cowbridge; 2nd, Harry Hunkin, Neath; 3rd, Wm. John, Pontypridd; 4th, S. Morgan, Cowbridge.

*Single Shallow-Frame of Comb Honey.*—1st, John Morgan, Pontypridd; 2nd, R. Morgan, Cowbridge; h.c., J. Boyes, Cardiff.

*Twelve 1-lb. Jars (Light) Extracted Honey.*—1st, J. Boyes; 2nd, David George; 3rd, John Morgan; 4th, C. Hood; h.c., J. Boyes; 5th, Harry Hunkin.

*Six 1-lb. Jars (Light) Extracted Honey.*—1st, John Morgan; 2nd, W. R. Ockwell; h.c., W. H. Williams, Llandow, Cowbridge; c. John Rees.

*Twelve 1-lb. Jars (Dark) Extracted Honey.*—1st, R. Morgan; 2nd, C. Hood and David George (bracketed); c., J. Meriman, Ynysybwl, and Wm. John.

*Six 1-lb. Jars (Dark) Extracted Honey.*—1st, C. Dare, Llanharan; 2nd, David George.

#### OPEN CLASSES.

*Trophy of Honey and Wax.*—No award.

*Complete Frame-Hive (price not to exceed 12s. 6d.).*—1st, G. P. Workman, Llanishen.

*Collection of Bee Appliances.*—1st, John Hibbert & Sons, Cardiff; 2nd, E. J. Burt, Gloucester.

*Observatory Hive, with Bees and Queen.*—3rd, Thomas Lattey, Wenool.

*Wax in Suitable Form for Retail Trade.*—1st, C. Lodge, Chelmsford; 2nd, J. Boyes.

*Articles of Food in which Honey is an Ingredient.*—1st, Ellen Lindross, Cardiff; 2nd, Mrs. Gunter, Cowbridge.

Mr. S. Jordan conducted an examination for the B.B.K.A. 3rd-class Expert Certificate, seven candidates presenting themselves.

Messrs. W. G. Preece, C. T. Jenkins, and J. Boyes gave lectures and demonstrations in the Bee Tent at intervals each day.

WM. RICHARDS, Hon. Sec., Glam. B.K.A.

## Correspondence.

*The Editors do not hold themselves responsible for the opinions expressed by correspondents. No notice will be taken of anonymous communications, and correspondents are requested to write on one side of the paper only and give their real names and addresses, not necessarily for publication, but as a guarantee of good faith. Illustrations should be drawn on separate pieces of paper. We do not undertake to return rejected communications.*

*Communications relating to the literary department, reports of Associations, Shows, Meetings, Echoes, Queries, Books for Review, &c., must be addressed only to "The Editors of the 'British Bee Journal,' 17, King William-street, Strand, London, W.C." All business communications relating to advertisements, &c., must be addressed to "THE MANAGER, 'British Bee Journal' Office, 17, King William-street, Strand, London, W.C."*

### AMONG THE BEES.

#### FRAMES, SECTION-FRAMES, AND SECTIONS.

[5190.] Lawyers are at times credited with bolstering up a weak case by attacking the opposite side, and obscuring their lack of argument by a cloud of words. I cannot help feeling that a good deal of what has lately been written on the subject of frames can be set down in the same category. Some of your contributors seem to me to have set up a man of straw in order to have the pleasure of knocking it down. Experiments and trials of different styles of frames are now going on, and the results, when recorded, should be of value in providing material for coming to some conclusion in regard to whether the present frame is really so defective that it requires to be superseded by another demanding either minute or fundamental changes.

*A Jury of Experts.*—I did not join in the late discussion on frames for the best of all reasons—my knowledge of the subject was too limited to be worth setting up as being of any practical value. I do not think it tends to edification to speak or write on a subject on which, by lack of practical experience, one is insufficiently informed. I refer to it now to make a suggestion. No body of men in our islands have more thorough practical knowledge of the subject than some of our leading experts. Let the B.B.K.A. select a jury of these gentlemen, who will twist and discuss the *pros* and *cons* of the several points under discussion in the light of their wide experience. I would have infinitely more faith in their decision than in the *ex parte* statements and special pleadings of those who desire to make them wider or thicker. Some of these widely-travelled experts might also tell us of the percentage of deaths in hives with large frames compared with those on the standard-size frames.

*Section-Frames.*—I see some of your correspondents have expressed a preference for section-frames. I never used them, but I know they have lived, been dead, and buried many years; and they are now being resurrected seemingly in the belief that they are some modern invention. I have three objections to them, though, perhaps, they may

not be considered very serious. They are *not* pleasing to the eye, they pack badly, and when parting them they frequently cause a smash and consequent mess not at all inviting. Bees certainly do not work in frames, and I am not prepared to deny that they do not do also the *best* work in frames, but they are practically unsaleable, and so I still hold by the section—and of all sections I have seen and used my preference is still out and out in favour of the  $4\frac{1}{2}$  in. by 2 in. It is in every way the best receptacle for comb honey now on the market. Yet I have an "open mind" for a better when it comes!

*The Tall Section.*—A Highland school-master, whose opinion I was asked to consult on a hair-splitting question of degree at an early stage of this controversy, wishes the following to appear in the JOURNAL:—I see the Rev. Mr. Lamb is still on the warpath. Might you not remind him of a fact pointed out in the original discussion regarding the tall thin section? It was then brought to his notice that, only a few years before, he looked on *extra thick* comb as the nearest possible approach to perfection in honey production. He owned he was wrong then. Now, if he was wrong once, is it quite certain that he may not be a second time, when he pleads so energetically for *thin* comb now? Nay, may it not be possible that the golden mean between the two extremes—the  $4\frac{1}{2}$  in. by 2-in. section in fact—is better than either extreme?

Their *only* advocate has advanced twenty reasons why we should adopt tall sections and discard square. I felt then and now feel that I could accept every one of the twenty if they included a *not*, but the reverend gentleman might call my logic weak, if I contented myself with such an argument. So I will enumerate twenty reasons adduced by several practical bee-keepers—not Highland, and not even Scotch—to show cause why the tall sections should not be adopted. : 1. After all he has written Mr. Lamb has not *proved* one point in their favour. 2. Nobody, comparatively, has ever given a repeat order for them. 3. In general they turn out light weight, say, 15 oz. 4. The section does not please the eye better. 5. It does not sell better. 6. It does not get filled quicker. 7. It does not turn out better finished. 8. Bees have more cells to build. 9. And therefore more to seal, both meaning more work. 10. Bees are further cut off from their brood. 11. They desert tall racks earlier in the season. 12. Are slower to take possession of extra racks. 13. They require more foundation, therefore the cost is greater. 14. They will contain more midrib. 15. Being deeper it will be more difficult to fix foundation true. 16. They will require new racks. 17. New dividers. 18. New market crates. 19. New lifts for hives. 20. More glass when glazing. 21. Our old dividers, &c., may go to the bee museum.

These tall sections appear to me to be making no headway. I have taken no notice

of them for over two years as, perhaps, I said sufficient then to show my opinion was decidedly in favour of the *status quo*. Tentative efforts have been made lately to bring them to the front again so I adopt my friend's homily, and am content to give it as my own.—D. M. M., *Banff*.

## "OBSERVATIONS"

ON BEES IN OBSERVATORY HIVES.

[5191.] In reference to "Bridgefield's" observation (5161, page 272) it may be said that bees shake themselves for various reasons, and in at least two different ways, between which it is easy to discriminate. There is the shake for cleansing purposes, concerning which I have written so often that I refrain from saying more, except that it is generally carried on for many minutes together, and that traces of pollen can as a rule be detected on the body of the shaker, whose thighs also often bear the well-known loads, and that it is always done with the wings closed.

The other "shake" may be called the shake repellent. It is a sign of disgust; the bee turning sharply round with a strong buzz of the wings, intended apparently to repel a displeasing odour. It can be produced by putting in the way of a bee sentinel any small object previously smeared with some essential oil, and notably by a portion of a recently dismembered wasp, of which the odour seems to be particularly offensive to bees. So sharp, in this instance, is the buzz with which the bee turns tail, that the offending object is often whisked away for two or three inches. As soon as the bee can summon up courage it will turn round again with the idea of removing the fragment, only to whisk round again as before, and this may occur several times before the bee can pull itself together and perform its duty. And yet another bee may come by, seize the bit of wasp as a matter of course, and walk off with it. From this it may be argued that the seat of the smelling organs seems to be somewhere in front, and that the sense of smell (if smell it is) is more highly developed in some individuals than in others.

In the case mentioned by "Bridgefield," I should imagine that for some reason or other the dead bee had become very distasteful to the individual who took notice of it, probably one of the highly sensitive. As to sentiment or sympathy in bee-life, one of the first things an observer learns is to cease to look for it. Bees are purely utilitarian.

In the same number of the JOURNAL, Mr. M. D. Hill (5164) is not, as it seems to me, justified in drawing any special conclusion from the fact that shortly after having been licked by the tongue of an attendant, his queen bee let fall an egg. Licking with the tongue is very frequent; it is, indeed, the common form of grooming. On the other hand, a queen overcharged with developed

eggs, will eject egg after egg, and sometimes as many as three or four at a time, when removed from the hive, so that it is difficult to see how contact of the abdomen with the bottom of a cell can have any effect on the laying.

The more one watches queens the more certain it seems to be that they are little more than egg-machines, and that where and when, and in what quantity, she shall lay are determined by the workers, something on the principle of the penny-in-the-slot; or, if you prefer to put it more poetically, you may say, with Maeterlinck, that the queen is guided by the "spirit of the hive." By confining the bees to two or three frames you upset natural conditions, and waste ensues.—H. J. O. WALKER, Lieut.-Colonel, *Budleigh Salterton, Devon.*

### LONG SECTIONS

FOR HEATHER HONEY.

[5192.] Referring to Mr. Walton's long section for heather honey, I wish to remark that I did not intend saying more on the subject, until the experiment had received another season's trial. But as the matter is still to the fore in B.B.J. I add a further brief note to say: One of the most valuable lessons taught by our B.B.J. is "Go Slow," and this advice is specially good when applied to new ideas about appliances.

Mr. H. Marrs (5,156, p. 265), tells us that he "finds nothing to equal the old two-way 1-lb. section, but so far he has not tried the new 'tall sections,'" so that without any experience of the latter he has judged the two sections and has found the tall one wanting. Why? Apparently I suppose because the subject has been so hotly discussed in theory and on paper that others have already condemned it. Undoubtedly, both sizes of sections have their good points, in theory, but practice, and practice alone, will prove which is the best. It is always pleasing to see new contributors to your pages, and we bee-keepers welcome their fresh ideas up to the practical point; this being so, I trust Mr. Marrs will accept my remarks in a kindly spirit, while hoping they will not deter him from writing again.

His use of the term "non-sectional," according to my view, is not exactly correct, as I shall endeavour to point out:—I regard a non-sectional super as simply a bottomless box having slats or bars nailed across the top. In each of these bars is fixed a strip of foundation extending the whole length of bar, which the bees draw out into comb and attach same securely to sides of the super. The combs are stored with heather honey, which is cut out in slabs and used as required. On the other hand, sectional supers are fitted with frames, consisting of top and side-bars, with or without bottom-bars, and these can be removed as suggested. This suggestion, however, caused so much friction amongst exhibitors of super-

honey that the Jedburgh B.K.A. and others were compelled to adopt very strict rules for the guidance of some who had previously been able to "doctor" a sectional super and show the same in a non-sectional class.

The non-sectional super has been in use for over twenty years in these counties, and many members of our N. & D. B. K. A. advocate the use of them for the storing of heather honey, and maintain that by the use of such supers the yield is about one-third more than that produced in 1-lb. sections. It has been found, however, these large non-sectional supers are not suitable for ready and safe handling, therefore Mr. Walton's idea of the 3-lb. section may prove better for commercial purposes, while at same time securing the benefit of the super and adopting the section-racks already in use.—JAS. WADDELL, *Wooler, July 22.*

### SWARMING VAGARIES.

[5193.] On Thursday, June 25, I had a swarm from one of my hives, and not requiring an increase of stocks I returned the bees to parent hive after cutting out all queen cells except one. On the following Sunday the hive again swarmed, about double the number of bees issuing this time. After hiving the bees in skep I again examined the frames, and found several more queen-cells, all of which I again cut out, save the one left before, and then once more returned swarm. Next morning I saw the bees carry out an immature queen, probably hatched from the cell I left; but the bees immediately took possession of super which they had deserted after swarming the first time. They have gone on all right ever since up to now. On looking at the alighting-boards yesterday morning I saw a dead queen at the flight-board of another hive, and which I send on by post for inspection. Is this another young queen, or is it the old one?—"FORESTER," *Cinderford, Glos., July 20.*

[Queen sent is a full-grown adult.—EDS.]

[5194.] I have among my hives one stock of Italians which sent out a very large swarm on July 17. I hived them exactly as I have done many English swarms, but about half of the bees came out of the hive and flew off. I followed the runaways for some distance but eventually lost them. On returning to hive the remainder of the swarm followed suit and flew off in the same direction as the others, and although I again followed, the second lot got away and was lost. This was the first swarm from that hive this season. Do you think it probable that there were two queens in the swarm or would the two remaining lots join together and become one vagrant swarm? Seeing that I have never yet lost an English swarm, I ask: Are Italians more difficult to hive than English bees? Also, does the Italian crossed with the common or brown bee make

vicious hybrid? I am anxious about this, my intention being to purchase some Italian queens for crossing with my ordinary bees.—W. L., *Kimbolton*.

[Our own experience of Italians is that they are more inclined to "vagaries" than the ordinary brown bee, but there has been so much of the "unusual" this year with regard to swarms with duplicate queens that the Italians are in no way exceptional. The same may be said of the hybrid cross between the Italian and the brown bee; they are sometimes very docile and easy to handle, but occasionally the hybrid named is very vicious.—Eds.]

#### SHALLOW-FRAMES UNDER BROOD-NEST.

[5195.] In the B.B.J. of July 23 (page 297) Mr. J. Rymer says: "To my readers in the south, whose honey harvest comes much earlier than ours, try a shallow-frame box on the top of the brood-nest; let the queen have free access to this box, and note the result."

Being myself a southerner—all being well—I will try it, but there are a few questions I would like to ask Mr. Rymer. 1. *Re* the contents of the shallow-frame box; would the frames now in use (drone comb and wide ends  $1\frac{1}{2}$  in.) from which I am extracting. 2. Would they answer your (Mr. R.) purpose, or should the frames be as those in the brood-nest, viz., ten in number, narrow ends and brood-foundation? Then, about the adapting-board:—In my case I can rest the bottom of the shallow-frame box directly on top of the frames in the brood-nest. Would the adapting-board be necessary in my case? I would not give so much trouble but for Mr. R. kindly saying: "Anything not clearly understood I shall be glad to try and explain through the B.B.J."; and so thanking him in advance for the desired information.—W. C. H.

#### THE RYMER METHOD.

[5196.] Referring to B.B.J. of July 16 and 23, and the question of stopping swarming, I have been much interested in the matter, being in a somewhat similar case. On page 286, Mr. Rymer says, "I tried working a box of shallow-frames under the brood-nest, and this reduced swarming to a certain extent, but finding the shallow-frames below often contained brood and eggs when removed to their place overhead, I altered my plan," &c. The above is exactly my experience with the same method, *i.e.*, box of shallow frames under the brood-nest, and swarming still takes place. This season I have three single hives and a "Wells" treated in this manner. Results:—On 22nd inst. examined them; in the "Wells" the bees made no use of added frames, either for surplus or brood, but one compartment of the bees swarmed. In the single hives (I will call them Nos. 1, 2, and 3)

No. 1 I found four out of the nine frames had hatched brood, worker and drone (no unsealed brood). I inferred from this that the queen had returned to the brood-nest. The other five frames were full of honey ( $18\frac{1}{2}$  lb.). In No. 2 there was brood, both sealed an unsealed, and less honey than No. 1. No. 3, judged from external appearances, was in the same condition. I let them alone for the present, to come out about three weeks hence.

I work for extracted, not section honey. There are two boxes of shallow frames on each hive, with queen excluder on the top of each brood-nest below the shallow frames. This thought occurred to me. Remove the excluder, and thereby give the queen access to the supers, which were empty (I had extracted their contents), and I did it at once—right or wrong. Should the queen lay in those combs (drone cells), what will the result be, worker or drone, or both? I have noticed drones being cast out.—W. C. H., *South Devon*.

[Worker bees are not likely to be reared in drone cells, so that you may look for drones only if eggs are laid at all.—Eds.]

#### A FOUL BROOD DUMMY.

[5197.] I do not think the duty devolves on me of defending the foul-brood dummy mentioned in BEE JOURNAL of July 16 and 23 (pages 286 and 295). Until the dummy has been fairly tried I think criticism is useless. I am using the dummy in a hive which is slightly affected with foul brood, and hope to let you know the result in due course. I should, however, like to add a line to say I neither claim nor contend that the dummy is certain in its results, but only that it should be worth a trial, as its inventor says he has had success with it.—G. F. GILLILAND, *Londonderry, July 25*.

#### LANGDON'S NON-SWARMING DEVICE.

In reply to former requests for copies of the B.B.J. of June 22 (Vol. 21), containing a description of the appliance known as "Langdon's Non-Swarming Device," we have several times had to explain that the number referred to is out of print. Similar requests having again reached us we reprint the article in question along with our remarks thereon as made at the time. It is, therefore, unnecessary to say more now beyond mentioning the fact that the "device" was found defective in America, and has fallen into disuse there, while it never found favour in this country. The article originally appeared as under headed.

#### A NEW NON-SWARMING DEVICE.

In bee-matters the wise man "makes haste slowly"—at least, such is our view, and this renders us chary in advising the too-ready adoption of new contrivances intended to serve

certain purposes or to accomplish certain results until such trial has been made as will test their capabilities in fulfilling all that is claimed for them. But we must not carry our reservation too far, or some one will be a loser, and so, without further preface, we here publish some particulars regarding a device intended to entirely do away with the swarming of bees, if the bee-keeper so desire it.

Mr. H. P. Langdon, an American bee-keeper and honey-producer, has now made public a method of swarm-preventing, which it is his intention to introduce to the notice of British bee-keepers so soon as certain patent rights have been completed. Mr. Langdon, in a pamphlet now before us, after giving reasons why bee-keepers require something which will lessen cost and increase production, tells of his own invention, and goes on to say: "The mode of operating the device is as follows:—The

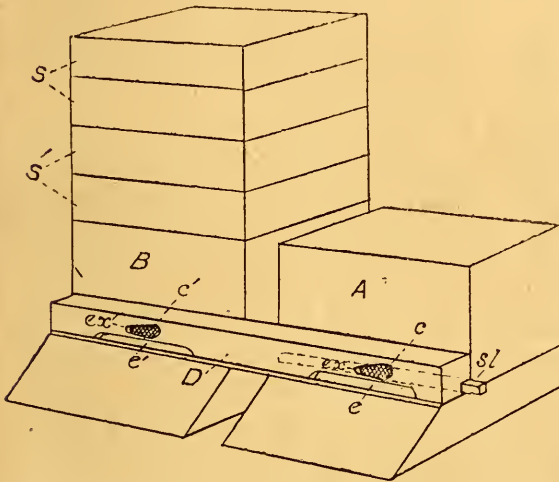

Beehives with Langdon non-swarmers attached: A, B, hives; S, S' supers; D, non-swarming device; e, e' entrances corresponding to hive entrances; sl, slide for closing entrance; c, c' conical wire cloth bee-escapes; ex, exits of same.

hives must be arranged through the yard in pairs, preferably on stands, each holding two hives. Before the swarming season begins, attach the device to the front of each pair of hives with two screws through the small holes in the device, with the entrances arranged to correspond with the entrances of the hives, and an inch hole in the end of each hive to correspond with the exit cones of the device. In case the hive has closed-end frames, nail a half-inch rim on the device, to set it off from the hive that distance, and no hole in the hive will be needed.

The bees are now going out and into the hives through their respective entrances, paying no attention to each other.

Now, call the hive at the right A, and the one at the left B. When the sections are ready to go on, put them all on the hive con-

taining the least number of bees, B, for instance, and insert the slide *sl* into the end of the device so as to close the inner entrance at hive A—the one not having any sections on. This shuts all the flying bees out of hive A, and when they go into the outer entrance *e* of the device on their return, they are attracted along the gallery of the device to the entrance of hive B with their loads unmolested by the guards of the hive. All flying bees in the closed hive A are allowed to come out at the cone exit, *ex*, and they, too, are led into the hive on their return.

All bee-keepers know that bees will not swarm unless they are booming with honey and are in the height of prosperity, such conditions as favour a good crop of comb or extracted honey. This withdrawal of the working force reverses this condition of prosperity very decidedly in the closed hive A, and no queen-cells will be built, or if they have been started they will promptly be torn down.

In the meantime the field forces of both colonies are *hard at work* in the supers on hive B, without any interruption.

At this stage of the proceedings, with a double force of bees and with a large amount of honey going into hive B, that colony will soon begin to build queen-cells and prepare to swarm. So, in a week or ten days from the closing of hive A, or before the colony in hive B can get cells far enough along to swarm, put a case of sections (or more if needed) on hive A, take off all finished cases from hive B, and set the remaining ones, bees and all, over, on to hive A, with those containing the honey at the top. Remove the slide, thus opening hive A, and insert it in the other end of the device, so as to close the inner entrance to hive B. This runs all the flying bees the other way into hive A, which now holds all the supers,

and brings the colony in hive B into the same poverty-stricken condition that hive A was in before. At the same time the field bees of both hives are working uninterruptedly in the supers on hive A.

In about a week the supers are again placed upon hive B, the finished ones removed and empty ones given if necessary, the entrance to which is opened, while that of hive A is closed. In another week another transfer is made back to hive A, and so on during the honey season.

This alternation of the working bees and the transfer of the supers so disturbs the plans of the nurse-bees, by depopulating the successively closed hives, that complete organisation for swarming is *impossible*, hence no swarms issue, and the field bees of both hives work *unitedly* and *without interruption* through the entire

honey season, bringing about the conditions desired and spoken of by Mr. A. I. Root, as follows:—*'If we can entirely prevent swarming, and keep all the bees at home storing honey all the season, we shall get enormous crops from a single hive.'*—*A B C of Bee-culture*, 1891, p. 289."

We shall leave readers to judge of the article from the inventor's description, one of the main merits, in our eyes, being the fact that he 'worked the plan' on a hundred colonies of bees in 1892. Were it not for this plain announcement, we should have been inclined to wonder how several things would 'work out' in practice. At present, all we can say is, it promises well—*very well*. The 'arrangement' costs little, is easily applied, and, if our American friend has really produced an appliance which will accomplish all he claims for it, bee-keepers will owe him a debt of gratitude, and, we hope, will fill his pockets with dollars in payment.

## Queries and Replies.

[3168.] *Decoy Hives and Decamping Swarms.*—May I ask your advice in regard to the following matter? A certain bee-keeper in this district indulges in the reprehensible practice of leaving open hives in which the bees have died, and these hives seem to be irresistibly attractive to all the swarms of the neighbourhood. In June last a swarm issued from a skep in a small apiary some distance away, and, instead of clustering in the usual way, took wing and decamped. The owner was from home, but his sister and a neighbour bee-keeper followed the runaway swarm, and found it entering one of the "decoy" hives. The owner of these latter was then told what had happened, and requested to deliver up the runaways; but he refused, on the plea that the hive was tenanted previous to the swarm's arrival. The neighbour mentioned above, being a practical bee-man, thereupon took out the frames, and pointed out that they were absolutely destitute of brood or stores, and that, if bees were seen entering the hive, they must have been "robbers," on the look-out for booty. This did not satisfy the "decoy hive" owner, who explained that he knew nothing much about bee-brood; but he maintained that bees were seen going into the hive, and point blank refused to deliver up the swarm. The rightful owner was, of course, greatly annoyed by the attitude thus taken up, and accordingly instructed his solicitor to write a letter demanding its return, failing which, legal proceedings will be taken. Should this case go on, it will, no doubt, be of general interest to bee-keepers, and I should feel greatly obliged if you can see your way to give any information likely to help the man to either recover his swarm or its fair value from the person who now has the

bees in his possession. I send name and address, while signing, "A SCOTCH BEE-KEEPER," *Ross-shire, July, 1903.*

REPLY.—We are not clear with regard to Scotch procedure on the subject of runaway swarms, but according to English law, as defined in Blackstone, the owner of the swarm in question would have a clear case for claiming the bees or fair value for same. The bees were seen leaving the hive by two persons, and not lost sight of till they entered the "decoy" hive; then claimed on behalf of the rightful owner. This fulfils all the conditions laid down by the great legal authority named above, and would probably decide the case in Scotland. Regarding what are called "decoy hives" the case is different, and it is simply a matter of fairness and honesty between man and man. He who prepares his hives for swarms, and leaves doorways open in order to induce his neighbour's bees to enter them is, to say the least, not honest; but since the "decoys" may only be prepared to avoid runaway swarms from his own apiary it is not a *legal* offence, however unjust it may be to his neighbours.

[3169.] *The Troubles of Beginners.*—I am a regular reader of the B.B.J., and also possess the "Guide Book," and having noticed the kind assistance given through your columns to beginners with bees, I venture to write for advice. I have but one hive, and am troubled with foul brood. My single stock is a last year's swarm, now on eleven frames and busy building out a super of shallow-frames. Before the last cold spell there was an abundance of sealed brood in the hive, and early in June I started a nucleus by putting three frames of comb (out of thirteen) in one end of a hive with a side entrance, one comb had two queen-cells started on it. Four days afterwards I examined both hives and found in nucleus several dead dark-coloured larvæ (perhaps chilled), and some few brown and sticky. I also noticed the patchy appearance of brood in parent hive, and saw therein a number of diseased larvæ. I destroyed the worst combs, inserted remaining two, after cutting out queen-cell, in parent hive, and gave about a pint of syrup along with eucalyptus oil sprayed with a syringe into all the combs, especially filling the two frames of comb above referred to. Four days after I poured eucalyptus oil all round bottom of hive, between inner and outer walls, repeating the dose of syrup a few days later, and put a few drops of oil in the hive. Many bees came out on to floor board, but soon returned. I now find the two old combs quite evenly sealed over, and several frames have large healthy patches of brood. There are, however, far fewer eggs and larvæ than ever before, and still some larvæ lying on their backs and turning brown. The two combs above referred to returned from nucleus are now clean and healthy. I have repeated dose of

syrup, sprinkling promiscuously so as to make the bees take it, and have destroyed one bad comb. I therefore ask:—1. What had I better do? I now have no new queen maturing. If I buy a queen and make a swarm of the bees I lose all the unhatched brood. 2. If I take part only, how can I finally cure the remainder? Although the present laborious treatment is successful so far, I may have a worse time before winter. If, however, I make a swarm of the bees now I inevitably lose any surplus for this year it seems. 3. How do I get rid of old combs without losing bees and not having an extractor? If I place them in centre of hive they always contain brood. If I place them outside the brood they get stocked with honey. 4. Can I melt out honey any way before melting up combs in a muslin bag under water? I send name, &c., and sign,—“EUCALYPTUS,” *Rugby*.

REPLY.—Before replying to the queries enumerated, we may say that (as a beginner) you have begun at the wrong end of bee-keeping by venturing on items of management quite beyond a novice whose lack of knowledge is so candidly and straightforwardly put before us. Moreover, there is no warranty for what has been done in the pages of the “Guide Book.” The kindest and best advice we can offer is to leave off spraying combs with eucalyptus oil or putting a few drops of it in the hive in treating foul brood as stated, and defer “nucleus forming” till more experience has been gained. To put the case broadly, you are—while possessing only a single colony of bees—endeavouring to increase stocks by nucleus forming, secure surplus honey, cure foul brood, and do other things, not by closely following the directions in “Guide Book” but by departing from the methods there laid down for guidance. For the rest we reply—1. Send sample of comb that we may judge if foul brood is being dealt with. 2. If the bees are to be treated as a swarm and re-queened, there must be no dividing into two lots with the idea of making two stocks of them. 3. Old combs can only be got rid of by melting down for wax, if worth it, or destroying by burning if not worth saving.

[3170.] *Destroying Swarm Located in Stone Wall*.—Will you please help me with your valuable advice in the following case? A swarm issued from one of my hives and took possession of the hollow part of a loose stone wall, about 3 ft. thick, that divides my garden from the small farm of my neighbour. I have tried to dislodge them by smoking into the other side of the wall, but that only sent them to a different part of it. I cannot take any part of the wall down, as it is built of large stones on the outside and rubble inside, all loose. It is where this has fallen out or not been quite filled in that the bees are. Unfortunately the haystack will be about one yard off the wall, just behind the place the

bees occupy, and the hay cart will draw up only about three or four yards from it—the bees' entrance being on my side the wall. Would it be possible to destroy the bees in any way? I am most anxious, if possible, to do this, as the swarm came from a stock that has foul brood. I suppose my neighbour could claim damages from me if his cattle or poultry, &c., got injured by the bees? Thanking you in anticipation, I send name, &c., and sign myself,—R. E. M., *Wales*.

REPLY.—Failing the use of some such powerful agent as cyanide of potassium—which would soon kill the bees if you know how to use it—an opening might be arranged in the wall so as to place an ounce or two of powdered sulphur in a tin lid and if set alight by means of a red-hot cinder, the bees will soon perish from the fumes.

[3171.] *Uniting Swarms*.—1. I will be much obliged if you will inform me through your valuable paper if I have done right in the following case:—One of my hives sent out two strong swarms to-day, which I united after removing one queen. I also transferred the super from parent hive and placed it over swarm. The spare queen which I took from swarm I returned to the parent hive after removing the queen-cells, which I have used to form nucleus hives. 2. Does it injure brood to extract honey from comb containing unsealed larvæ? Thanking you in anticipation.—DOUBTFUL, *Leeds, July 25*.

REPLY.—1. Yes, but we assume that the hive which “sent out two strong swarms” in one day had already swarmed a week or so previously, seeing that—under normal conditions—only one queen accompanies the first or “top swarm.” It may be that the top swarm came off unseen, and owing to some accident the parent queen got lost or was unable to fly. In this case the bees would return to the hive, and eight or nine days later the bees would swarm again, this time headed by a young queen, as a second swarm always does. 2. Yes, never extract from such combs if it can be avoided.

[3172.] *Swarming Vagaries*.—I want to ask the following question, and hope for reply in B.B.J.:—I have the “Guide Book” and have taken in your journal since beginning of this year, and am greatly indebted to you for such excellent and practical advice as I find therein. As a novice I also find the “Guide Book” very useful. I obtained my first stock in a skep on March last, and they were in a weak condition when received. I fed the bees all through the cold weather, after which they increased in numbers, but on July 2, they came out in large numbers covering the front of the hive, hanging under the floor-board for the whole day, but went in again towards night. Nothing unusual happened up to July 8, but on July 9 and two following days again clustered outside as on July 2, but have since settled down without having swarmed, to my knowledge. A neighbouring

bee-keeper told me on July 9 to put a skep on the top of stock to see if the bees would commence building combs above. Then if the queen went up and started breeding, remove her to a hive of her own and leave the old stock to raise a queen for themselves. I wanted to have had a swarm from them this year in order to establish another stock.—*ANXIOUS, Middlewich, Cheshire.*

REPLY.—The plan of securing increase proposed by your neighbour would assuredly fail at this season, because if the bees took possession of the upper skep at all (which we very much doubt) it would be simply as a super for storing honey in, while the queen remained below. If increase is urgently desired you might drive part of the bees and queen into the second skep as an artificial swarm, unless the parent hive has swarmed unseen already, in which case the skep would hardly be strong enough in bees to allow of taking bees for an artificial swarm from it. It would almost appear as if the old queen had been deposited by the bees and the skep requeened, in which case it will be best to let well alone.

[3173.] *Galvanised Iron and Honey Extractors—Storing Honey.*—1. My extractor is showing slight signs of rust inside, and not being able to get it retinned I should be obliged if you would let me know whether the ordinary process of galvanising is detrimental to honey? 2. I wish to keep two or three dozen shallow-frames through the winter for home consumption, and should like to know about the heat required to prevent granulation, and also if the honey should be excluded from the air or the box be perforated. The "Guide Book" says 80 deg. for ripening; but if granulation will take place below this heat, attempting to preserve honey in its natural state through the winter is, of course, out of the question. I have worked almost exclusively for honey in shallow and deep frames and find the bees take to them ever so much quicker and swarm less than in sections; in fact, the only swarms I have had (not including skeps) are two from section-supered hives.—*HAMLIN H. PERHAM, Somerset.*

REPLY.—1. Galvanised iron is not suitable for use in honey extractors, it has an injurious effect on the honey; we should much prefer to remove the "slight rust" by washing before use. 2. If the shallow-frames contain well ripened honey in liquid condition when stored away, the boxes containing them need only wrapping carefully in paper to keep out moths and storing in a warm dry cupboard near a stove or fire so that a temperature of about 60 deg. Fah. might be maintained. Thus dealt with they will be in condition for a long time. No necessity for providing a perforated box for storing in.

[3174.] *A Beginner's Queries.*—Having lately bought some hives, and being desirous of learning bee-keeping, I should be much obliged if any one would kindly answer the following questions:—1. What is the best

time for stopping cracks in and painting frame-hives, and can this be done while the bees are in them? 2. Should the brood frames, which seem to have very old combs, in colour from yellow to black be cleaned out and supplied with new brood foundations? If so, when? 3. How many frames should be left in the bottom box of the hive for the winter, and should they be closed up together, or how much space should be left between them? 4. What should be done with the frames taken out, and should they be put back in the spring or summer as they are, or should new foundations be put into them? 5. When are the brood frames free of eggs and larvæ? 6. How is one to know whether there is enough honey left in the brood box for winter use? 7. How can one know when the honey flow is over, and when should the hives be left for the winter; should any alterations be made on mild winter days and snowy and frosty days? 8. Should the hives be cleaned out; if so, when?—*COLONEL B.-B., Cheltenham, July 25.*

REPLY.—1. The *outsides* may be painted while hives are occupied. 2. Yes, combs need renewing when old and black. 3. As many as the bees cover well in autumn. 4. Store them away. 4. In depth of winter. For remaining queries and for other items, which are essential to ensure success, refer to "Guide Book."

## Bee Shows to Come.

*A nominal charge of 2s. 6d. is made for notices in this column, which covers cost of insertion from order till date of show. Cash should accompany orders for insertion.*

July 30, 31, and August 1 and 3 at Old Trafford, Manchester.—Annual Show of the Royal Lancashire Agricultural Society. Liberal money-prizes are offered for honey along with silver and bronze medals of the B.B.K.A. and also of the Society. Open classes for Honey-Trophy, Sections, Extracted Honey, Beeswax, Honey-Confectionery, Bee Flowers, Instructive Exhibits in Bee-Culture, &c.

August 3 (Bank Holiday), in the Walled Meadow, Andover.—Honey Show in connection with the Andover and District Horticultural Society. Class for single 1-lb. jar of extracted honey (with no entry fee). Also classes for sections, extracted honey (light and dark), and beeswax.

August 3 (Bank Holiday) at Melton Constable Park. Annual Show of the North Norfolk B.K.A. Schedules from the Hon. Sec., C. J. Cooke, Edgefield, Melton Constable.

August 4, at Leamington.—Tenth annual show of the Leamington St. Mary's Horticultural Society. Three open classes for Six 1-lb. Sections, Six 1-lb. Jars "Light," and Six 1-lb. Jars "Dark" Extracted Honey, respectively. Liberal money prizes.

August 6, at Nantwich.—Honey department of the Cheshire Agricultural Society's Show under the management of the C.B.K.A. Numerous classes for hives, honey, and wax. Money prizes and medals.

August 6, at Kingsthorpe, Northants.—Honey show of the Northants B.K.A., in connection with the Horticultural Society's Exhibition. Three open classes with special prizes, including one for single 1-lb. jar of honey. (*Entry free.*) Prizes 20s., 10s., 7s. 6d., and 2s. 6d. Schedules from R. Hefford, Hon. Sec., Sunnyside, Kingsthorpe, Northampton. Entries close August 1.

August 6 at Madresfield.—Honey show of the Worcestershire B.K.A., in connection with the Madresfield Agricultural Show. Schedules from A. R.



Moreton, Leigh, near Worcester. Entries close August 1.

August 12, at Radstock, Bath.—Honey show in connection with the annual show of the Radstock and District Horticultural and Fanciers' Association. Schedules from the Secretary, B. M. Clark, 1, Fox Hills Radstock, Bath.

August 12, at Wye.—East Kent Honey Show. Open Class for Single 1-lb. Jar Extracted Honey with no Entry fee. Prizes—1st, £1; 2nd, 10s.; 3rd, 5s. Schedules from Secretary, J. Tippen, Wye, Ashford, Kent.

August 12, at Hardenhuish Park, Chippenham, Wilts. Honey show in connection with the Chippenham and District Horticultural Society. Ten local classes for bees, honey, and beeswax. Open class for honey trophy. Prizes 20s. and 10s. Schedules from Wm. Small, Secretary, Market-place, Chippenham.

August 12, in the Market Hall, Tavistock. Devon B.K.A. annual show of honey, wax, bees, and appliances, in conjunction with the Exhibition of the Tavistock Cottage Garden Society. Schedules from E. E. Scholefield, Heathfield, Chudleigh, S. Devon. Entries close July 31.

August 12, at Chew Magna, near Bristol.—Bristol and District B.K.A. Annual Honey Show in connection with the Chew Magna Horticultural Society. Open and gift classes, liberal money prizes and certificates. Schedules from James Brown, Secretary, 31, Bridge-street, Bristol. Entries close August 6.

August 13, at Bath.—Honey show in connection with the Annual Show of the St. Saviour's Horticultural and Industrial Society. Held in Kensington Meadows. Seven local and seven open classes (including one for single 1-lb. jar of honey with free entry), for six sections, six 1-lb. jars extracted honey, three shallow-frames comb-honey for extracting, and for collection of honey, also honey products. Also for collection of bee-appliances and observatory hives with bees. Schedules from C. J. Calvert, hon. sec., 10, Eastbourne, Bath.

August 13, at Goole.—Bee and Honey Show in connection with the Goole and District Agricultural Society. Six open classes, including one for single 1-lb. extracted honey (with free entry). Schedules from J. Luddington and H. S. White, Secretaries, Lindum House, Goole. Entries close August 8.

August 15, at Chorley, Lancs.—Classes for six 1-lb. jars Extracted Honey and six 1-lb. Sections. Open to the county. Schedules from Peter Hodgkinson, Secretary, Chorley Agricultural Society, Town Hall-square, Chorley, Lancs.

August 19, in the Great Western Park, New Swindon.—Wilts B.K.A. County Show of Bees, Honey, &c. Fifteen classes in all, five open to all England. Schedules from the Hon. Sec., W. E. Burditt, Buttermere Rectory, Hungerford, or from local Hon. Sec., S. W. Filtness, Market House, Marlborough-road, Swindon. Entries close August 10.

August 19 and 20, at Shrewsbury.—Annual show of the Shropshire B.K.A., in connection with the Shrewsbury Horticultural Society's Great Floral Fête. Seven open classes for honey. Schedules from S. Cartwright, hon. sec., Shawbury, Shrewsbury. Entries close August 7.

August 22, at Hawkshead, Lancashire.—Honey show in connection with the Hawkshead Horticultural Society. Open classes for Six 1-lb. Sections and Six 1-lb. Jars (medium or dark) Extracted Honey. Prizes 10s., 6s., and 4s., and medals of the L.B.K.A. Schedules from Dr. Allen, Hawkshead, Lancs. Entries close August 15.

August 22, at Barnton, near Northwich.—Honey department of the Flower Show. Local classes for light and dark honey, sections, and beeswax. Class for twelve 1-lb. jars extracted honey open to county and members of the Cheshire B.K.A. First prize, silver medal of the C.B.K.A. and 15s. Schedules from Mr. S. Wade, Heathside, Barnton, Northwich. Entries close August 15.

August 25, at Cartmel, Lancashire.—Honey show in connection with the Cartmel Agricultural Society. Open classes for sections, extracted honey, and beeswax. Local classes for sections and extracted honey. Schedules from Wm. Cragg, Secretary, Cartmel, via Carnforth.—Entries close August 13.

August 26, at Reading.—Honey Show of the Berks B.K.A., in conjunction with the Annual Exhibition of the Reading Horticultural Society. Open

classes for comb honey in sections and for extracted honey. Local classes include prizes of 20s., 15s., 10s., and 5s. for honey trophy. Also classes for owners of small apiaries. Schedules from D. W. Bishop-Ackerman, Hon. Sec. Berks B.K.A., 131, King's-road, Reading.

August 27, at Llangollen.—In connection with the fifth annual Flower Show. Open classes for Six 1-lb. Sections, Six 1-lb. Bottles Extracted Honey, and Beeswax. Schedules from Frank Little, Castle-street, Llangollen. Entries close August 13.

August 27, at Montgomery, in connection with Montgomery and District Horticultural Show. Open classes for Six 1-lb. Sections and Six 1-lb. Jars, Extracted Honey. Prizes in each class 10s., 5s., 2s. 6d. Entrance-fee 1s. each. Schedules from W. J. Jones, Secretary, Montgomery. Entries close August 20.

September 5 to 12, at the Agricultural Hall, London.—Honey show in connection with the Confectioners', Bakers', and Allied Traders' (11th) Annual Exhibition and Market. Numerous classes and liberal prizes for comb and extracted honey and beeswax. Open to all British Bee-keepers. Special attention is directed to the new Honey-selling Classes with Free Entry. Schedules (now ready) from H. S. Rogers, Secretary, Exhibition Offices, Palmerston House, Old Broad-street, London, E.C. Entries close August 19.

September 9 and 10, at Derby.—Derbyshire B.K.A. Twenty-second Annual Show of Hives, Bees, and Honey on the show ground of the Derbyshire Agricultural Society. Schedules from R. H. Coltman, Hon. Sec. D.B.K.A., Station-street, Burton-on-Trent. Entries close August 22. Double fees to August 29.

September 17, 18, and 19, at Crystal Palace. Surrey, B.K.A. Annual Exhibition of Bees, Honey, Wax, and Appliances, &c. Twenty-four classes (ten open to all). Increased prizes and medals. Schedules from F. B. White, Secretary, Marden House, Redhill, Surrey. Entries must be made before September 1.

September 19 to 26, at the Agricultural Hall, London.—Honey Show in connection with the eleventh Annual Exhibition and Market of the Grocery and Kindred Trades. Numerous classes and liberal prizes for comb and extracted honey and beeswax. Open to all British Bee-keepers. Special attention is directed to the new Honey-selling Classes with free entry. Schedules from H. S. Rogers, Secretary, Exhibition Offices, Palmerston House, Old Broad-street, London, E.C.

October 6 to 9, at the Agricultural Hall, London.—Show of Honey and Bee-produce in connection with the British Dairy Farmers' Association. Numerous and liberal prizes for honey, &c., including the valuable Silver Challenge Cup of the B.B.K.A. Schedules from Mr. Wm. C. Young, Secretary, 12, Hanover-square, London, W.

### Notices to Correspondents & Inquirers.

*Letters or queries asking for addresses of manufacturers or correspondents, or where appliances can be purchased, or replies giving such information, can only be inserted as advertisements. The space devoted to letters, queries, and replies is meant for the general good of bee-keepers, and not for advertisements. We wish our correspondents to bear in mind that, as it is necessary for us to go to press in advance of the date of issue, queries cannot always be replied to in the issue immediately following the receipt of their communications.*

WEST LEICESTER (Leicester). — *Artificial Swarming*.—1. If a laying queen be given to the queenless portion as directed, and both portions of the hives operated on are fed up well while building out foundation all will go on well. 2. Reference to page 251 of B.B.J. for June 25 last shows that the third-class certificate was awarded, and at the last meeting of the Council the document would be signed, so that it will

probably now be in your hands. Thanks for returning the mis-addressed p.c.

MEL ROSAE (Yarmouth).—*Eating Comb-honey*.—1. Some consumers swallow the comb along with the honey, others reject the very small portion of wax left in the mouth. It is merely a matter of choice. 2. The word propolis (or bee glue) is usually pronounced prop-olis, the accent as in the word "proper," but some insist on calling it pro-po-lis, accentuating the second syllable "po" as in pole. "Webster" gives it both ways.

F. W. GUERIN (Guernsey).—*Varieties of Heather*.—The sprig sent is from the Scotch heath or bell heather (*Erica cinerea*), and yields rich honey plentifully when the season is favourable.

P. PERPLEXED (Yorks).—*Cross-Built Combs in Frame-Hive*.—With the "hive boiling over with bees" as stated, it will be beyond "a novice" to straighten the combs so as to render this workable in the frames. The best course, under the circumstances, will be to provide another body-box, and after fitting the frames with full sheets of foundation, set this below the present brood-chamber, and allow the bees to work down, and transfer the brood-nest into the new frames below. Then as brood hatches out from the crooked combs the cells would be filled with honey, and at close of season could be removed for extracting, leaving the stock in a new set of straight combs.

"DRONE BEE" (Norfolk).—*Sealed Food for Wintering on*.—If the most suitable combs are selected from the nine hives when reducing them to four for winter, there will be no need to extract the unsealed honey. Uniting is a very simple operation as directed in "Guide Book," using flour instead of syrup. 2. By means of a super-clearer bees are easily removed from supers.

#### Honey Samples.

C. H. (S. Leicester).—Honey is good and saleable, and, but for being a little dark in colour, probably from blackberry, we see nothing wrong with it.

E. W. (Tavistock).—No. 1 sample is very good indeed, and would stand well on the show bench. No. 2. is also good, but does not equal No. 1; besides, it is just beginning to granulate, and would need heating a little in warm water to clear it.

H. W. (Newnham, Daventry).—Though dark in colour and of rather poor consistency, the honey is not very bad in flavour. It is probably from the source you name, with an admixture of blackberry or bramble.

J. P. (Bracknell).—1. The honey is so thick and so singularly tenacious that it will be impossible to extract it other than by slicing up the combs and placing them on

muslin stretched across a milk pan in front of a fire, the honey will when warm strain through. The extractor would be of no avail in such a case. 2. The colour is poor, being dark and not at all clear. 3. No use at all for showing unless you wish to take the "wooden spoon." It might be fairly saleable after granulating, but not as liquid honey.

#### Suspected Combs.

*Special Notice to correspondents sending queries on "Foul brood."*

*We urgently request that all letters sent with samples of suspected comb be put outside the box or tin containing the sample. Also that no more than a couple of square inches of comb be sent, taking care to neither crush the comb nor probe the cells before despatching.*

*In urgent cases (and where possible) we undertake to "wire" replies as to F.B. if six stamps are sent to cover cost of telegram. All letters should be addressed "Editors," not "Manager."*

MINSTER (Yorkshire) and "A. B. C." (Cornwall).—There is no disease in comb, the dead brood therein being only "chilled."

JAS. D. NEILL (Kilkenny).—1. The indications point to chilled brood only, and we think you will find it so. But in any case the disease known in America as black brood is far less contagious than *Bacillus alvei*, or foul brood. 2. With regard to Italian bees and foul brood, our experience points the other way. The worst trouble we ever had in combating the disease was connected with Italian bees, nor have we ever seen stocks so badly affected as those from imported queens.

T. M. (Sutton).—Referring to the bees of "Miss C.," the hive from which sample of comb was taken, it is a bad case of foul brood, and we are much surprised to hear that the bees are strong in numbers. We should at once remove the two affected combs and burn them, and leave the others till later on. If the brood all hatches out, the bees may be wintered on the six combs, but if more disease is found, we should get the bees off combs and hive them (after usual precautions) on full sheets of foundation and feed with medicated food. Your letter was mislaid, hence delay in reply.

A. W. (Croydon).—Comb is affected with foul brood.

ANXIOUS (Fife).—Seeing that the comb sent is affected with foul brood of long standing, it was unfortunate that you risked a valuable swarm and queen on old combs of doubtful character, since bees had already died on them. We should certainly get the bees off present combs if clean ones are available. Of course, the usual precautions must be observed.

A. M. (Dudley).—Only a very slight trace of disease in comb, but latter, being black and very old, sadly needs renewing.

*\*\* Some Letters and Queries are unavoidably held over till next week.*

## Editorial, Notices, &c.

### THE COMING HONEY SHOWS

AT THE ROYAL AGRICULTURAL HALL.

As will be seen by the announcement this week in our advertising pages, the two important autumn honey shows at the Agricultural Hall, London, held in connection with the Confectioners', Grocers', and Allied Trades will be held respectively from the 5th to 12th of September and the 19th to 26th of the same month. Very liberal money-prizes are again offered, along with the silver and bronze medals and certificate of the B.B.K.A., together with the handsome diplomas of the Exhibitions. We also note a new departure this year connected with the Selling Classes for comb and extracted honey, which should commend itself to bee-keepers who have surplus honey to dispose of.

As will be seen from schedule, no entry-fee is charged in the three classes referred to, but the exhibits, consisting of six 1-lb. sections in class O13 and six 1-lb. jars of extracted honey in classes O11 and O12, staged as samples of the honey for sale, become the property of the Directors to dispose of in any way they deem fit. This removes outlay for return carriage to exhibitors, and at no cost beyond value of samples and a small commission on sales, honey may be sold in large or small quantities through the agency of the Directors for delivery direct from producer to the tradesman who deals in it. The entries for the Confectioners' close on August 19, and for the Grocers' on the 29th. Early application for schedules, containing full particulars, is therefore desirable.

### INTERNATIONAL EXHIBITION AT LUXEMBOURG.

We are requested to invite the attention of readers to the International Exhibition, which includes Bees and Appliances, to be held by the Grand-Ducal Agricultural and Horticultural Society, on the occasion of the fiftieth anniversary of the Society, at Luxembourg, on August 29 next, continuing to September 7.

British manufacturers of bee-appliances and bee-keepers in this country desiring to exhibit or to attend the exhibition will be cordially welcomed, and all particulars supplied, on application to—

CHARLES SIEGEN, Secretary,  
Luxembourg, France.

### HANTS AND ISLE OF WIGHT B.K.A.

(SWANMORE BRANCH) ANNUAL SHOW.

This show was held on July 29, in Swanmore Park, in connection with that of the Bishop's Waltham Horticultural Society.

About 900 lb. of honey was staged, and a general improvement in the "get up" of section-cases proved that a word recently dropped by one of the Hon. County Secretaries on this point had not been thrown away. A feature of the show was the somewhat unusual proportion of dark honey, but the quality appeared to be generally excellent. Mr. W. G. Hedges' "display" (over 200 lb. in weight) deserves special mention. Mr. T. Giles, Cowsfield, Salisbury, acted as judge, and made the following awards:—

*Twelve 1-lb. Sections.*—1st, Miss Martins; 2nd, W. G. Hedges; 3rd, E. Ainsley.

*Six 1-lb. Sections.*—1st, Miss Martin; 2nd, A. Roys, jun.; 3rd, E. Ainsley.

*Three 1-lb. Sections.*—1st, E. Ainsley; 2nd, Miss Martin; 3rd, W. G. Hedges.

*Single 1-lb. Section.*—1st, Miss Martin; 2nd, E. Ainsley; 3rd, W. G. Hedges.

*Three 1-lb. Sections (Novices).*—2nd, C. T. Hedges. No 1st or 3rd awarded.

*Display of Honey from One Apiary.*—1st, W. G. Hedges; 2nd, E. Ainsley; 3rd, E. Hedges.

*Extracted (Light) Honey (12 lb. in 1-lb. or 2-lb. Jars).*—1st, W. G. Hedges; 2nd, E. Hedges; 3rd, W. Cooper.

*Six 1-lb. Jars Extracted Honey and six 1-lb. Sections.*—1st, W. G. Hedges; 2nd, E. Ainsley; 3rd, W. Cooper.

*Three 1-lb. Jars Extracted Honey and Three 1-lb. Sections.*—1st, Miss Martin; 2nd, W. G. Hedges; 3rd, E. Sandal.

*Single 1-lb. Section and 1-lb. Jar Extracted Honey.*—1st, Miss Martin; 2nd, E. Ainsley; 3rd, W. G. Hedges.

*Three 1-lb. Jars Granulated Honey.*—W. Cooper and F. Sparksman equal, 2ad. (1st and 3rd not awarded.)

*Two Shallow-frames Comb Honey of 1903.*—1st, W. G. Hedges; 2nd, E. Hedges; 3rd, Not awarded.

The foregoing open to bee-keepers within ten miles of Swanmore:—

*Twelve 1-lb. Sections and Twelve 1-lb. Jars Extracted Honey (Members only).*—1st, W. G. Hedges; 2nd, E. Sandal; 3rd, E. Hedges.

The last-mentioned awards also carry the silver medal, bronze medal, and certificate respectively of the County Association.—(Communicated).

### HONEY SHOW AT HELSBY, CHESHIRE.

In connection with the annual Flower Show an Exhibition of Honey and Wax was held on Saturday, August 1. Considering the unfavourable season, the entries (eighty-five) must be considered very fair, while the majority of the exhibits were of good quality. Mr. H. Potts, Sutton, Warrington, officiated as judge, and made the following awards:—

*Six 1-lb. Jars Extracted Honey (open to all Cheshire).*—1st, J. Griffiths, Alvanley; 2nd, Miss Milligan, Frodsham; 3rd, J. M.

Haenaman, Alvanley; h.c., A. Newstead, Ince, and J. Rowland, Runcorn.

*Three 1-lb. Sections.*—1st, Rev. E. Charley, Ince; 2nd, J. Griffiths; 3rd, Dr. Briant, Helsby.

*Three 1-lb. Jars Granulated Honey.*—1st, O. Dutton. (No other award.)

*Beeswax.*—1st, Dr. Briant; 2nd, Rev. E. Charley.

*Six 1-lb. Jars Extracted Honey (Local).*—1st, J. Griffiths; 2nd, J. M. Haenaman; 3rd, A. Newstead; h.c., Dr. Briant.—(Communicated.)

## Correspondence.

*The Editors do not hold themselves responsible for the opinions expressed by correspondents. No notice will be taken of anonymous communications, and correspondents are requested to write on one side of the paper only and give their real names and addresses, not necessarily for publication, but as a guarantee of good faith. Illustrations should be drawn on separate pieces of paper. We do not undertake to return rejected communications.*

*Communications relating to the literary department, reports of Associations, Shows, Meetings, Echoes, Queries, Books for Review, &c., must be addressed only to "The EDITORS of the 'British Bee Journal,' 17, King William-street, Strand, London, W.C." All business communications relating to advertisements, &c., must be addressed to "THE MANAGER, 'British Bee Journal' Office, 17, King William-street, Strand, London, W.C."*

### DESTROYING WAX-MOTH.

#### A SWARMING INCIDENT.

[5198.] I have been badly troubled with the bee-keepers' pest, wax-moth, and all I could do did not clear my hives of it. Last spring, however, it occurred to me to use "Hall's Sanitary Distemper," which is a water paint, and a very strong disinfectant. I gave one hive a good coat (inside) throughout, and, although I have carefully watched, the result is that not a single moth has so far appeared. Thinking this might be of some use to others I send it on for what it is worth if they care to try it. The distemper completely fills up all cracks and corners, and sets as hard as the wood itself. I am now treating seven or eight more hives in the same way and will report results.

We have often heard in your pages of the strange doings of the bees. Here is another case:—On July 15, about noon, I was passing through one of our main streets, and found a lad, who had charge of a grocer's truck, in great trouble, for a very strong swarm of bees had taken possession of the truck as he was wheeling it along, and the bees very soon were masters of the situation. A crowd soon gathered round, including five or six police. It was very amusing to hear them telling the poor boy to take his truck off out of the way, taking good care to keep back out of harm's way themselves. I asked for them to be left alone while I brought a hive. This I quickly did, and soon had the bees in it without getting a single sting, much

to the astonishment of the onlookers. In half an hour I had them home all safe and sound, and they are now doing very well on seven frames.—C. PAY, *Croydon.*

### BUYING HONEY FOR EXHIBITION.

[5199.] It is a help to bee-keepers, and a saving of trouble and expense, besides, to be able to state a price at which exhibits may be sold at a show, and such sales often bring more orders. But about five years ago I found out that there were purchasers anxious to buy prize exhibits with the object of staging them as their own produce at other shows, and since that time I have made it a rule to have all my exhibits returned to me.

My own observations during the last few years clearly proved that there is a deal of dishonesty going on in connection with shows, while the audacity displayed in the adoption of these practices is wonderful, and I think that when viewed in the light of the present day admittedly better education of all classes, as compared with the time (twenty-five years ago) when modern bee-keeping was in its infancy, an additional amount of dishonesty attaches to them.

I have just returned from a county show, where I was approached by a bee-keeper for the purpose of buying from me supplies of honey for exhibition as his own produce. Another offered to give any price that I like to mention for my exhibits at the show referred to. These, too, were wanted for exhibition, and I declined to sell at any price.

In bringing these practices to your notice, I shall not hinder honest exhibiting, but simply put others on their guard against practices which do bee-keeping and honest bee-keepers a serious wrong, and I know that other well-known exhibitors have been approached for the same purpose.—WM. LOVEDAY, *Hatfield Heath, Harlow.*

### THE RYMER SYSTEM.

[5200.] The system pursued by Mr. Rymer is, to my mind, the most satisfactory known. I have obtained splendid results this season by its adoption, and have entirely prevented swarming. Twenty frames are not too much for a young queen, and it does not pay to keep old queens.

The use of the Rymer honey-board is not plain to beginners. I may say that, when it is used between shallow-bodies, it prevents the bees joining the upper and lower together, and making one continuous comb of the frames in the two bodies, as will happen when the board is not used.

A young queen and abundance of room is the great secret of success in bee-keeping. The best packing to induce bees to go into supers is plenty of bees.

The season in Cornwall has been a peculiar one—much bad weather—yet, despite it all,

we have done extremely well. The clover is now out in great profusion, and bees are bringing in honey very fast.

On July 17 I put a shallow-body on, making a note in my bee-book that I did not expect it filled. It is now fairly on its way to completion, though the weather was extremely bad, and the colony a small one comparatively, being a newly-made one.

I find that the bees, if confined to their hives by bad weather, will soon seal over combs which would have been further drawn out if the weather were fair. I believe that, when strong in numbers, they will seal all supers, even if only partly drawn out, should the season close before they can be entirely filled.

I use Wells hives of the "W. B. C." type, made by Mr. Meadows. They are excellent.—W. J. FARMER, *Truro*.

## SWARMING VAGARIES

### AND "HIVING" TROUBLES

[5201.] On July 15 a large swarm issued from one of my hives; a week later, a second swarm came off; and, on the 26th, a third—this last also being quite a good one. The parent queen is a Carniolan cross, and the bees are decidedly Carniolan in appearance. The hive was strong in the spring, and I added a box of shallow-frames to the brood-chamber to try and stop swarming, but with the above result. They still have no sealed honey in the super. The first swarm I put in hiving skep and left till the evening, when I threw them on to a sheet in front of new hive. Nearly all had run in, when suddenly they started coming out again; and though it rained all that night, and most of the next day, I could not get them to stop in the hive till I inserted a frame of brood. I thought the queen was lost, but it was not so. In a week's time several frames of foundation were drawn out and full of eggs, and I saw the queen.

The second swarm I gave to a friend in the hiving-skep, and he had just the same trouble in getting the swarm to stop. Every time he put them in the hive they came out again, and I think in the end were a practical failure.

The third swarm I watched carefully. I placed a brood-chamber fitted with six frames over them, and the bees soon began to run in; but the young queen appeared, to say the least, very frivolous. She kept flying about, and although I got her on a piece of stick on which she walked, and put her on the frames, she came out again. However, every one went in well ultimately, and in the evening I moved them to their stand (new) in the apiary. They remained in all night, and next morning being wet they were perfectly quiet. When I went back in the afternoon (still wet) the whole lot were outside again, some running about excited all night. On the

following morning I got a frame of brood, and spooned them in. I found the queen on the ground, three parts dead, chilled; I put her on the floorboard; but they dragged her away and dropped her overboard again. All the swarms settled in the same place, on the under side of a rail, and were in from two to four clumps.

I cannot understand this behaviour of the swarms, and do not know what is the right thing to do. As a constant reader of your very useful JOURNAL I hope you will give me the benefit of your advice.—FRANK T. PAUL, *Hoylake, Cheshire, July 29*.

[We cannot account for the vagaries detailed above beyond saying that the bees referred to are obviously of a very excitable strain, and will always be difficult to control so far as regards swarming. Excitability is, however, a known characteristic of the Carniolan bee. We have ourselves known a pure Carniolan stock to start swarming (while we were quietly giving the bees a surplus-chamber) without having even started queen-cells. We should always give a comb of brood when hiving a swarm of the bees in question; this would probably save further trouble.—EDS.]

## A GOOD SEASON IN ESSEX.

### UNKNOWN LARVA IN HONEY-COMB CAPPING.

[5202.] I am sorry to trouble you again, but, as you know, whenever I go to my hives I am on the look-out for something fresh. I have sent you one of my sections of new honey for inspection, and if examined closely, you will notice just under the capping what appears to me to be the work of a very minute insect, similar in nature to that of the wax-moth. It may not be anything worth troubling you about, but I should like your opinion of it. The sections were only in the hive about twenty days, and six days wet prevented me from taking them off before. At present I have taken forty-seven sections from this hive, which we consider good for our district. The present season, although it started so late, has been the best I have known for years. One beginner I am helping has taken 190 sections from four hives, and the bees are still working in sections. I had one rack filled in seven days, they were put on July 9. You see I am trying the tall sections, but like the square ones best for several good reasons. I can sell all my sections and screw-top nominals at 1s. each.—A. B. B., *Brightlingsea, Essex, July 27*.

[There is no doubt that the indications of damage to under side of capping is caused by the unknown larva mentioned by Mr. F. W. L. Sladen on page 205 of our issue for May 22 last. The comb-cappings there illustrated show the damage more plainly than in section now sent, but the insect is obviously the same.—EDS.]

## A FOUL BROOD DUMMY.

[5203.] With further reference to this subject, I would tender my apology to the writer of No. 5179 (*vide* page 304 last week), if the bounds of reasonable criticism have been in any way overstepped.

Such criticism is, however, in no sense personal, and, indeed, the mention of Mr. Gilliland's name is due to the editorial pen.

Whether it be less courteous to refer to a correspondent by his title or simply as "that man" is, of course, open to question, and I have no desire to disown courtesy.

At the same time, my remarks refer solely to the device, and their expression in such fashion is not intended to constitute an attack.

As I have, without evidence, simply expressed my own opinion that the device would fail of its object, let us by all means hear from the inventor, for if a hive may be cured of foul brood for a shilling, it is a shilling well spent.—L. S. CRAWSHAW, *Ilkley, August 3.*

## A SWARMING INCIDENT.

[5204.] Is not the following incident unusual? On Monday last I was asked by a bee-keeper to go and hive a swarm for him. I agreed, and found the swarm had clustered at the top of a high tree. I procured a ladder and mounted the tree, then shook all the bees I could into the skep and secured a good part of them, but the main part of the swarm took wing and decamped. I followed them over several fields and gardens till they again clustered, and I promptly hived them and secured the queen this time, then carried them back to the owner. After five o'clock in the evening I picked out and killed another queen, and returned the swarm to parent hive.

On Wednesday (July 15) I was sent for by another bee-keeper, who also had a swarm, and wanted the queen taken away. This was about three o'clock, and the bees had been clustered on a tree since ten in the morning. I shook them into the skep, and, to my surprise, I saw two queens, both of which I secured in a match-box. I then saw several others, and in all I took out five queens. I then left the bees, thinking they would return to parent hive, but to my surprise they have started work and stopped in skep; so you see they must have had six or more queens! This is a fresh experience to me.—A. B. B., *Essex.*

[It seems quite a characteristic of the present season for more than one queen to accompany swarms.—Eds.]

## LONG SECTIONS.

[5205.] Under the above heading (5,192, page 303), Mr. Waddell takes me to task for having expressed my opinion as to what kind of section I thought was best; but surely expressing an opinion need not be considered as condemnation of another's opinion. My

experience of sections extends to nearly twenty years, and I expressly added that I had not tried the tall sections, so that I should not be misunderstood. I am not a new contributor to your pages, having done so for many years under a *nom de plume*.

Mr. Waddell's point is therefore lost, *re* "fresh ideas up to practical point!" Neither is my term non-sectional super incorrect. What he describes as a non-sectional super is exactly what I use, namely, a bottomless box with bars screwed to top. I prefer these supers about 12 lb. capacity, but have had them up to 20 lb., and which have been sent from here to Jedburgh, when it took first prize, and to several other shows without any mishaps. In fact, I have had no more breakdowns with these supers than with sections, though they are certainly not so easily disposed of.

I am hoping for your editorial remarks about the formalin cure for foul brood, also for the result of Mr. Saunders' experiment with the same.

Bees have been storing very well here up to two or three days ago, but weather is very broken again, with cold nights.—H. MARRS, *Newtonards, Dumfriesshire, August 3.*

## DECAMPING SWARMS.

## AND COMB-HONEY IN FRAMES.

[5206.] If "D. M. M.," Banff (who writes on page 301 of B.J., July 30), will send me his address, I will be pleased to forward him specimens of the special shallow-frames needed for comb-honey, used with separators, which, when filled, are pleasing to the eye, pack well, and when parting them do not smash nor make any mess. But Mr. Walton (mentioned on page 303) has kindly sent me samples of his long sections, 12 $\frac{1}{2}$  in. by 4 $\frac{1}{4}$  in., which it would be difficult to beat for the same purpose. They fit an ordinary section-rack, or a "W. B. C." hanging section-frame. "D. M. M." can then state his opinion of them.

Referring to Mr. Jas. Waddell's reply to Mr. H. Marrs (page 303) as to being a "new contributor" to the B.B.J., might I be allowed to say that Mr. Henry Marrs is a bee-keeper of old standing, a leading member of the South of Scotland B.K.A., and a certificated expert of the B.B.K.A.?

With reference to the question of decamping swarms dealt with on page 306 I heard of a farmer who had to give up the chase after a swarm as he was done up, but his sheep-dog still followed the swarm, and the farmer following at his leisure was met by a neighbour, who told him that his dog had got them safe, and so he found them, the swarm on a hedge and the dog sitting facing it.

Now, supposing that swarm had been claimed by the owner of the land it was on, would the farmer be considered to have

legally kept it in sight by his deputy, the dog? Common sense says yes! But what about the Law?—GEORGE M. SAUNDERS, *Keswick*.

[We fear the law will hardly take dogs into account.—EDS.]

SMALL HONEY JARS.

[5207.] Replying to a recent query in your columns I would say that Mr. R. H. Barrett, glass bottle manufacturer, the Oval, Cambridge Heath, E., makes 6 oz. ( $\frac{1}{2}$  lb.) glass jars at 16s., and  $\frac{1}{2}$ -lb. jars at 13s. per gross, fitted with a patent metal cap superior to the common screw-cap.—"EUCALYPTUS," *Rugby*.

WEATHER REPORT.

WESTBOURNE, SUSSEX,  
July, 1903.

Rainfall, 3.35 in.	Minimum on grass, 32°, on 8th.
Heaviest fall, 1.13, on 25th.	Frosty nights, 0.
Rain fell on 15 days.	Mean maximum, 67.7°.
Above average, .88 in.	Mean minimum, 51.6°.
Sunshine, 221.9 hours.	Mean temperature, 59.6°.
Brightest day, 1st, 14.4 hours.	Below average, 0.9°.
Sunless days, 4.	Maximum barometer, 30.41°, on 10th.
Below average, 11.6 hours.	Minimum barometer, 29.64°, on 17th.
Maximum temperature, 78°, on 9th.	
Minimum temperature, 42°, on 7th.	

L. B. BIRKETT.

Queries and Replies.

[3175.] *Dealing with Queenless Stocks and with Foul Brood.*—On July 15, a warm, bright morning, the loud noise of a number of drones attracted my attention to one hive. On opening it, I found nearly every frame completely filled with sealed honey and pollen, but there was no trace of brood. I found a capped queen-cell, and thought no doubt a queen would hatch out in the course of a few days. This, however, has not been the case, for on the morning of July 22 I found the queen-cell still capped over. Feeling sure that something must be wrong, I inserted a frame from another hive, containing a queen-cell just sealed over, and removed five of the eleven full frames of honey, so that the bees might store more readily in the supers; but in the last week of June a large swarm issued from the hive, so that I cannot understand what its present condition will be. According to the time when a second swarm might be expected, the hive should now be full of brood, instead of stores. The

bees seem busy, and from their activity one would not have judged them to be queenless! Could you explain the matter? I am interested because of never having seen a similar instance of this before. I rather suspected this hive of having traces of foul brood, and possibly the cell contained a diseased queen. Should I insert a frame of two or three days' old brood from another hive? I have successfully treated one hive suffering from foul brood on the starvation system, and the bees now seem strong and well, and I can find no trace of disease. I am sure that most cases of foul brood could be cured in this manner, providing the queen be healthy. When the honey-flow is over I hope to carefully examine each hive for traces of disease. Would it not be wiser to allow all diseased colonies to winter on the stores they now have (where they are abundant as in the case of all my hives), and then cure them in the spring? You recommend in the *JOURNAL* autumn treatment, but this would, in my case, necessitate the waste of much bee-food. I should think it wiser to allow hives with abundant stores to winter on what they have.—(Rev.) A. H. M., *Shrewsbury*.

REPLY.—It is evident that the original or parent queen of the colony has met with some mishap prior to June 15, and that the queen-cell seen on that date was an abortive one. It also seems clear that there were one or more queen-cells left which had escaped notice and that from one of these a queen has hatched out. This young queen would, in the natural order of things, leave the hive with the swarm which issued at end of June, and would no doubt leave a successor behind. Without quite being able to follow your details as given above, this is the most feasible explanation we can offer. But you may set the matter at rest by again examining the combs for a queen, or eggs, or brood. Regarding foul brood, it can never be a wise plan to winter bees on stores known to be infected with foul brood. On the other hand, if the affected honey is got rid of and replaced with medicated food, it must be advantageous in any efforts made to cure the stock. We shall be glad to hear result later on.

[3176.] *Beginners and Queenless Stocks.*—Will you please answer the following query? I got a swarm of bees in the summer of 1902, which did very well and—as I thought—came out all right last spring, for, having then seen the queen, I felt sure the stock was safe. However, as weeks passed on I never discovered any brood, except an odd cell here and another there, and I have come to the conclusion that there is a fertile worker in the hive, for I cannot find a queen. The question is—What will be the best thing for me to do with them? I send name, &c., and sign—A BEGINNER, *Ripponden, Halifax, July 29*.

REPLY.—If the bees lost their queen so long ago as stated, and afterwards failed to raise a

successor, the stock will be now worthless, as containing only old bees, which must inevitably soon die off. In endeavouring to account for the bad result, we rather fear you have been overhauling the frames too frequently in the early summer. It so often happens that, in their eagerness, beginners cause the death of queens by unseasonable and too frequent manipulating hive. This is the only possible explanation we can give of the stock's present queenless condition, coupled, of course, with the adverse season.

[3177.] *Sending Hives to the Heather.*—As an old bee-keeper and subscriber to the BEE JOURNAL, I ask your advice. Twelve months ago I re-commenced bee-keeping, and set down a stock which seemed fairly strong. When the time arrived I placed on a super of shallow-frames of drawn-out comb, but only 12 lb. of honey were stored therein. Rather than extract such a small quantity, I cut out the centre, or honey-bearing portion, and set the super aside for use this year. There would be about 1 in. to 2½ in. of comb left all round those frames from which the comb had been removed. I gave the same stock this super at the commencement of June, but up to now the bees have made no attempt to enter it, although the stock seems very strong, and brood plentiful, and yet I hear of other bee-keepers near who are placing on their third supers. As the clover-flow is practically over, I ask:—1. Would you advise me to send my hives to the heather 30 miles away? I should add a line to say that this hive swarmed on June 26, but from all indications the bees must have returned to the old hive again, as the stock did not seem to be reduced at all. They swarmed again on the 30th, and I hived the swarm on the old stand, and removed parent hive to new location. On examination of swarm, I found queen's wings much mutilated and one leg broken, so I destroyed her, and gave the swarm a comb of brood with queen-cells, and also comb of stores from the parent hive. A week ago I saw that they had hatched out a new queen, but she seems to be unfertilised. I examined again yesterday, and found plenty of stores in the hive, but no sign of brood. They are only on six frames (which they cover). 2. Would you advise taking three or four frames out of each hive, and giving fresh frames with foundation, and taking both hives to the heather? Also, would you advise supering with sections or shallow-frames if for sale?—"NOVICE," *Bramhall, Stockport, July 26.*

REPLY.—There seems to be a fair chance of securing some surplus at the heather by sending the parent hive there, if weather keeps fine and bloom is abundant, because of the bees being now "very strong and brood plentiful;" but with regard to the swarm of June 26, it would be a waste of money to take it to the heather, after all it has gone through, and being now broodless and bees only on six

frames. 2. We should give the bees no comb-building to do at the heather or elsewhere this year; it is too late in the season for that work.

[3178.] *Beginners and Swarm-Chambers.*—Reading your replies to queries in B.B.J., I am encouraged to trouble you with one or two difficulties. I purchased the "Guide Book" in February last—having previously read "A Modern Bee-Farm"—and decided to commence bee-keeping. I purchased a "Twentieth-century Hive," also a stock of hybrid bees, which reached me on March 15. When hiving the bees I noticed the combs seemed dark coloured, not the clear, pale yellow I had expected, the exception being the two which were apparently new and not fully drawn out. A week later I examined the frames, and found them about the same in colour, but the cell-cappings were sunk, and in some of the cells there was what appeared to be the "coffee-coloured substance" mentioned in the "Guide Book." I was undecided whether this was chilled or foul brood, but concluded it must be chilled, as the bees were busy carrying pollen when weather was good. On examining on July 4, I found all ten frames quite covered with bees, and for the first time saw the queen. The "swarm-chamber" under brood-body was also about half full of bees, nine of the shallow-frames being fully drawn out, and almost all stored with honey. One feature of this is likely to prove troublesome. The bees have built up from the top-bars of these shallow-frames to the bottom of brood-frames; these brace-combs I, of course, broke loose in examining frames and found that some larvæ was then exposed. Would these be queen-cells or drone brood? They had not the appearance of queen-cells as they are described. The cappings on the frames in brood chamber, in irregular places, stood out about one-eighth of an inch, sometimes singly and others three or four together. I have had a section-rack on now for a month, but it is only within the last week that bees have commenced working in these. I found several of the bees had a little parasite on them, reddish brown in colour. What are these? Under the excluder-zinc in the slit of the top-bar of frame I found the enclosed. What is it? Is not my colony what is called strong? At 11 a.m. I found ten frames fully covered, also bees in shallow-frames, seven out of ten covered and sections half covered. Will you please say through B.B.J. (1) If the specimen sent is wax moth and if there is any remedy? (2) What remedy is there for the parasite? (3) Would you advise doing away with "swarm chamber" and using the shallow-frames in a lift under sections? (4) What is the cause or reason for raised capping? Is it a fertile worker, and if so, how can I identify it? The query and reply column is to me the most valuable part of our journal.—H. L., *Halifax.*

REPLY.—1. The "specimen" was a wax-



moth larva. The "remedy" is to keep stocks strong, and moths have less chance of getting a foothold in hives; then destroy any chance moth or grub when seen. 2. The parasite referred to (*Braula ceca*, or blind louse), does not thrive in this country. It may be smoked from combs on to floor-boards and then brushed on to the ground; but most bee-keepers allow it to die off naturally. 3. Yes, by all means, at least until you get beyond the beginner stage. 4. If drones are being raised in worker-cells, the presumption is that either the queen is failing or a fertile worker is taking on maternal functions. There are no means of recognising a fertile worker.

[3179.] *Dealing with Vicious Bees.*—Might I ask for your kindly advice as to what is best to be done with vicious bees? One of my stocks (English bees) will tolerate no one within twenty yards of their hive; and so I ask:—Should I re-queen this autumn on the chance of introducing a gentler strain, or is the sulphur-pit the only remedy? The stock is a very strong one. Unfortunately, I have mislaid a recent copy of the B.B.J. which dealt with a similar difficulty.—M. D. H., *Windsor, July 24.*

REPLY.—By all means re-queen, and if a young Carniolan is obtainable introduce one. You would then alter the disposition of the stock entirely.

[3180.] *Dealing with Foul Brood.*—On examination I find I have several stocks of bees slightly affected with foul brood, and so I ask (1) would you advise brushing the bees off diseased combs, and after running them into a new home put the combs on the top for the brood not affected to hatch out? I may say there is considerable brood in them. 2. Or should I put the combs in question on another diseased stock to hatch and treat them as set forth in "Guide Book" later on. I am sorry to trouble you about the matter, but have been advised to try the first plan, and should like to have your valuable opinion before operating? I enclose my card while signing myself—BOBS, *Weston-super-Mare.*

REPLY.—1. On no account would we put the diseased combs in the clean hive, it would simply nullify your attempt to effect a cure. 2. The second plan is far preferable if there are bees enough in the hives to which the brood is to be given to maintain the needful warmth and prevent chilled brood.

[3181.] *Uniting Bees to Weak Stocks.*—I wish to ask if I have done right under the following circumstances:—The season has been very backward here; we have scarcely had a fine day. No hawthorn bloom about, nor flowers on sycamore trees, and very little apple blossom, so that our bees have had really nothing to gather honey from until now, when, at end of July, there is an excellent crop of white clover flowers all

round. I had a good swarm, and later on two casts from the same hive, a stock I bought in June from one of your advertisers. The top swarm is doing well, filling a super now, but the two casts I united with two of my weakest hives last week. The added bees seem to have cured their weakness, and I have put supers on both hives. The clover honey-flow is a fortnight later than I ever knew it before in these parts. One good thing the very wet season of this has done, that is, destroyed most of the wild bees. They were a perfect nuisance here last year. I am glad to hear that Dr. Jones, our former well-known Lancashire bee-expert, is coming back to live in his old house again. He used to have forty hives.—W., *Freckleton, Lancs.*

REPLY.—You have taken the best course under the circumstances, seeing that, if your "weak stocks" were not diseased, they will now be headed by young queens of a new and evidently good strain of bees from the purchased stock. At same time we can hardly think you will have time to get surplus-honey this year from the last-named hives, and only August clover-bloom to rely on. If they provide winter stores it will be doing well. The top swarm, we fear, must therefore do the surplus-storing for the year.

[3182.] *Beginners and Bee-driving.*—A cottager in this neighbourhood keeps bees in skeps, and annually some are destroyed for the honey. This year two skeps are condemned, and I have asked the owner to allow me to drive them and take the bees. He agreed, and this being my first attempt to secure driven bees, I would be much obliged for a reply to the following queries:—1. Can the bees of both skeps be driven into one and the same empty skep? 2. As I am a beginner I cannot distinguish the queen in a crowd of bees, and if both queens entered the empty skep would that matter? 3. On taking the driven bees to their new home, could they at once be thrown in front of an empty frame-hive to crawl in and hive themselves? 4. The distance between their old home and my place is one mile. Is there any danger of the bees returning to the old stand, and, if so, how can I prevent it?—J. CHIP, *Bulpham, July 30.*

REPLY.—1. They can be so driven, but it is not advisable for a beginner to risk it. For preference provide two empty skeps, and get both lots driven before uniting the bees, or your first attempt at bee-driving may end badly. We also hope you have seen how an experienced hand at such a task goes to work, in order to prevent any harm coming to your cottager neighbour's other skeps. It needs to be cautious in this respect, otherwise robbing and consequent serious mischief may ensue. 2. You had better let the queens settle their differences themselves under the circum-

stances. 3. Yes. 4. No danger at all in that direction.

[3183.] *Weight of Stores for Winter.*—As a beginner, I am anxious that my hive should be made right for the winter, and the "Guide Book" says (on page 112) the hive must contain about 30 lb. of sealed stores. It also says that the hive should have about 2 super. ft. of sealed honey. The two opposite sides of a standard frame, and one side of another, would be about 2 super ft., I think; but that surely would not contain 30 lb.? 1. Please give me the information needed to make this clear. 2. What precautions should I take to prevent a hive being blown over in the winter? I ask because here in winter we get all the winds that blow. 3. Should feed-hole in quilt be in middle or a little forward?—MEL ROSA, *Yarmouth*.

REPLY.—1. Two superficial feet of sealed stores, as mentioned in "Guide Book," includes the cells on both sides of comb, not, as you suppose, one side only. Besides, seeing that combs are never filled with sealed stores from top to bottom, it may be calculated that it takes four to five well-filled Standard frames of comb to make up 30 lb. in weight of actual stores. 2. The simplest device for securing hives from being blown over in winter, is to drive a stout stake in ground on one side of hive and attach a cord to this with heavy stone at other end; then place cord across hive roof to weight it down. 3. The feed-hole is usually cut in centre of quilt, but it is a simple matter to have a spare quilt with feed-hole at side to meet cases where bees cluster away from centre in winter.

[3184.] *Bees Refusing to Work in Sections.*—I should be much obliged if you could explain the following in this week's JOURNAL: My bees were very strong in May so I put on a rack of sections, which the bees entered at once, but, owing to my having fitted the sections wrongly, I removed it three weeks later and substituted a "W. B. C." section-rack with sections correctly fitted, but the bees did not go up into it. This was on June 12, and four days later the hive swarmed and since then have not seen a bee in sections, though they were very plentiful in hive below, the queen-excluder taken off and the rack exceedingly well covered up. I did not remove the sections and feed with syrup after the swarm issued, as I suppose ought to have been done. Still, as there has been a month of good bee-weather since, can you tell me: 1. Why the bees have not gone up into the rack? 2. The question is, what should I now do? Ought I to take off the rack and feed up for wintering, or keep the rack on a little longer?—H. C. B., *Foots Cray, Kent*.

REPLY.—1. You do not say what work was done in the sections during the three weeks prior to June 12, but if the bees had stored surplus up to date of removal and then suddenly refused to work in sections, the in-

ference is that there was something wrong in fitting the second rack given, and that the bees swarmed instead. On the other hand, we know of numerous cases in Kent where bees did absolutely nothing in sections owing to adverse weather all through the month of June. So this may explain the bees not working in the sections. With regard to what has taken place since the hive swarmed on June 16, there is nothing unusual in bees refusing to enter sections after swarming; indeed, it is only in very good seasons that stocks in the south which have swarmed so late will do any work in sections during what remains of the honey-gathering time. 2. We should remove the rack at once and let the bees have all the surplus obtainable for winter stores. This at least may save some of the feeding for winter.

[3185.] *A Skep Apiary in Villa Garden.*—Would you be good enough to advise me in the following matters? 1. I have about twenty stocks of bees (mostly straw skeps) and intend bringing them to my back garden which is situated behind my house (a half villa). The garden is about forty yards long with gardens all round it and villas as well. It is on the outskirts of the town and bees do well enough so far as honey is concerned, but I am a little doubtful if so many skeps there would not be an annoyance in any way to my neighbours. 2. I am proposing building a wooden house to cover them in with closed sides and back but open in front. Is this to be preferred to a house with closed front and closed all round with flight-boards only projecting out in front. I am informed that such a closed in house draws damp, and the open front prevents damp. What would you advise? Please reply through the medium of your paper to AYRSHIRE, *Kilmarnock, August 3*.

REPLY.—1. It would need some skill, as well as care, to keep so many as twenty stocks of bees in a suburban villa garden, surrounded by other villas all round. We think if a house is built at all, it should be a regularly closed in house, with only openings for bees to pass in and out by. In this way all bee-work could be done under cover, with less chance of causing an upset outside, while manipulating the hives, than when the latter are in the open. 2. If it is decided to erect an open-fronted shed only, we would have the hives in two tiers and swing doors at back, capable of being raised when wanted, in order to do all bee-work in the rear.

## Bee Shows to Come.

A nominal charge of 2s. 6d. is made for notices in this column, which covers cost of insertion from order till date of show. Cash should accompany orders for insertion.

August 12, at Radstock, Bath.—Honey show in connection with the annual show of the Radstock and District Horticultural and Fanciers' Association.

Schedules from the Secretary, B. M. Clark, 1, Fox Hills Roadstock, Bath.

**August 12, at Wye.**—East Kent Honey Show. Open Class for Single 1-lb. Jar Extracted Honey with no Entry fee. Prizes—1st, £1; 2nd, 10s.; 3rd, 5s. Schedules from Secretary, J. Tippen, Wye, Ashford, Kent.

**August 12, at Hardenhuish Park, Chippenham, Wilts.** Honey show in connection with the Chippenham and District Horticultural Society. Ten local classes for bees, honey, and beeswax. Open class for honey trophy. Prizes 20s. and 10s. Schedules from Wm. Small, Secretary, Market-place, Chippenham.

**August 12, in the Market Hall, Tavistock.** Devon B.K.A. annual show of honey, wax, bees, and appliances, in conjunction with the Exhibition of the Tavistock Cottage Garden Society. Schedules from E. E. Scholefield, Heathfield, Chudleigh, S. Devon. **Entries closed.**

**August 12, at Chew Magna, near Bristol.**—Bristol and District B.K.A. Annual Honey Show in connection with the Chew Magna Horticultural Society. Open and gift classes, liberal money prizes and certificates. Schedules from James Brown, Secretary, 31, Bridge-street, Bristol. **Entries close August 6.**

**August 12, at Wye.**—East Kent Honey Show in connection with the Fifteenth Annual Show of the Cottage Gardeners' Horticultural Society. Ten Classes, with Liberal Prizes, for Honey, Beeswax, Honey Cakes, &c. **Open class (with free entry)** for Single 1-lb. Jar Extracted Honey. Prizes, 20s., 10s., 5s.

**August 13, at Bath.**—Honey show in connection with the Annual Show of the St. Saviour's Horticultural and Industrial Society. Held in Kensington Meadows. Seven local and seven open classes (including one for single 1-lb. jar of honey with free entry), for six sections, six 1-lb. jars extracted honey, three shallow-frames comb-honey for extracting, and for collection of honey, also honey products. Also for collection of bee-appliances and observatory hives with bees. Schedules from C. J. Calvert, hon. sec., 10, Eastbourne, Bath.

**August 13, at Goole.**—Bee and Honey Show in connection with the Goole and District Agricultural Society. Six open classes, including one for single 1-lb. extracted honey (with free entry). Schedules from J. Luddington and H. S. White, Secretaries, Lindum House, Goole. **Entries close August 8.**

**August 15, at Chorley, Lancs.**—Classes for six 1-lb. jars Extracted Honey and six 1-lb. Sections. Open to the county. Schedules from Peter Hodgkinson, Secretary, Chorley Agricultural Society, Town Hall-square, Chorley, Lancs.

**August 19, in the Great Western Park, New Swindon.**—Wilts B.K.A. County Show of Bees, Honey, &c. Fifteen classes in all, five open to all England. Schedules from the Hon. Sec., W. E. Burdett, Buttermere Rectory, Hungerford, or from local Hon. Sec., S. W. Filtness, Market House, Marlborough-road, Swindon. **Entries close August 10.**

**August 19 and 20, at Shrewsbury.**—Annual show of the shropshire B.K.A., in connection with the Shrewsbury Horticultural Society's Great Floral Fête. Seven open classes for honey. Schedules from S. Cartwright, hon. sec., Shawbury, Shrewsbury. **Entries close August 10.**

**August 22, at Hawkshead, Lancashire.**—Honey show in connection with the Hawkshead Horticultural Society. Open classes for Six 1-lb. Sections and Six 1-lb. Jars (medium or dark) Extracted Honey. Prizes 10s., 6s., and 4s., and medals of the L.B.K.A. Schedules from Dr. Allen, Hawkshead, Lancs. **Entries close August 15.**

**August 22, at Barnton, near Northwich.**—Honey department of the Flower Show. Local classes for light and dark honey, sections, and beeswax. Class for twelve 1-lb. jars extracted honey open to county and members of the Cheshire B.K.A. First prize, silver medal of the C.B.K.A. and 15s. Schedules from Mr. S. Wade, Heathside, Barnton, Northwich. **Entries close August 15.**

**August 25, at Cartmel, Lancashire.**—Honey show in connection with the Cartmel Agricultural Society. Open classes for sections, extracted honey, and beeswax. Local classes for sections and extracted honey. Schedules from Wm. Cragg, Secretary, Cartmel, via Carnforth.—**Entries close August 13.**

**August 26, at Reading.**—Honey Show of the Berks B.K.A., in conjunction with the Annual Exhibi-

tion of the Reading Horticultural Society. Open classes for comb honey in sections and for extracted honey. Local classes include prizes of 20s., 15s., 10s., and 5s. for honey trophy. Also classes for owners of small apiaries. Schedules from D. W. Bishop-Ackerman, Hon. Sec. Berks B.K.A., 131, King's-road, Reading.

**August 27, at Llangollen.**—In connection with the fifth annual Flower Show. Open classes for Six 1-lb. Sections, Six 1-lb. Bottles Extracted Honey, and Beeswax. Schedules from Frank Little, Castle-street, Llangollen. **Entries close August 13.**

**August 27, at Montgomery,** in connection with Montgomery and District Horticultural Show. Open classes for Six 1-lb. Sections and Six 1-lb. Jars, Extracted Honey. Prizes in each class 10s., 5s., 2s. 6d. Entrance-fee 1s. each. Schedules from W. J. Jones, Secretary, Montgomery. **Entries close August 20.**

**September 5 to 12, at the Agricultural Hall, London.**—Honey show in connection with the Confectioners', Bakers', and Allied Traders' (11th) Annual Exhibition and Market. Numerous classes and liberal prizes for comb and extracted honey and beeswax. **Open to all British Bee-keepers.** Special attention is directed to the new **Honey-selling Classes with Free Entry.** Schedules (now ready) from H. S. Rogers, Secretary, Exhibition Offices, Palmerston House, Old Broad-street, London, E.C. **Entries close August 19.**

**September 9 and 10, at Derby.**—Derbyshire B.K.A. Twenty-second Annual Show of Hives, Bees, and Honey on the show ground of the Derbyshire Agricultural Society. Schedules from R. H. Colman, Hon. Sec. D.B.K.A., Station-street, Burton-on-Trent. **Entries close August 22.** Double fees to August 29.

**September 17, 18, and 19, at Crystal Palace.** Surrey, B.K.A. Annual Exhibition of Bees, Honey, Wax, and Appliances, &c. Twenty-four classes (ten open to all). Increased prizes and medals. Schedules from F. B. White, Secretary, Marden House, Redhill, Surrey. **Entries must be made before September 1.**

**September 19 to 26, at the Agricultural Hall, London.**—Honey Show in connection with the eleventh Annual Exhibition and Market of the Grocery and Kindred Trades. Numerous classes and liberal prizes for comb and extracted honey and beeswax. **Open to all British Bee-keepers.** Special attention is directed to the new **Honey-selling Classes with free entry.** Schedules from H. S. Rogers, Secretary, Exhibition Offices, Palmerston House, Old Broad-street, London, E.C.

**October 6 to 9, at the Agricultural Hall, London.**—Show of Honey and Bee-produce in connection with the British Dairy Farmers' Association. Numerous and liberal prizes for honey, &c., including the valuable Silver Challenge Cup of the B.B.K.A. Schedules from Mr. Wm. C. Young, Secretary, 12, Hanover-square, London, W.

### Notices to Correspondents & Inquirers.

*Letters or queries asking for addresses of manufacturers or correspondents, or where appliances can be purchased, or replies giving such information, can only be inserted as advertisements. The space devoted to letters, queries, and replies is meant for the general good of bee-keepers, and not for advertisements. We wish our correspondents to bear in mind that, as it is necessary for us to go to press in advance of the date of issue, queries cannot always be replied to in the issue immediately following the receipt of their communications.*

J. C. (Ramsay, Hunts).—*Insurance for Bee-keepers.*—As stated on page 281 of our issue for July 16 last, members of County Associations should write to the Hon. Secretary of their own B.K.A. for particulars required, and non-members may obtain same from Mr. E. H. Young, Secretary B.B.K.A., 12, Hanover-square, London, W.

F. H. H. (Wroxhall, I.W.).—*Varieties of Heather.*—The sprig of bloom sent is from

the Bell Heather (*Erica cinerea*), or Scotch Heath. The "six or eight acres" of such fine blossom as sample should give a very good yield in suitable weather.

A. P. (Wells, Som.).—*Joining B.B.K.A. and Exams. for 1st Class Experts' Certificates.*—Applications regarding membership of the B.B.K.A. must be made to the Secretary, Mr. Edwin H. Young, 12, Hanover-square, London. The exams. for 1st class certificates are held once a year in London, usually in the month of May.

J. W. P. (Crowland, Lincs.).—*Preventing Granulation of Honey.*—There are no means of preventing pure liquid honey from becoming solid in course of time. Granulation may, however, be delayed by keeping it in a warm room, at a temperature of 60 to 70 deg. Fahr. The honey you complain of as "granulating while going to the shows" is probably from the flower of the mustard, grown so extensively in your county. Honey from this plant granulates quickly—sometimes in a few days after removal from the hive. The jars should be immersed in warm water for a few hours to remove cloudiness before staging.

SAINFOIN (Grantham).—*"Honey and its Uses."*—This pamphlet can only be had from the author, the Rev. Gerard W. Bancks, Green Street Green, Dartford, Kent.

J. L. WOOD (Richmond, Yorks.).—*Fluffy Material Cast Out of Hive by Bees.*—The "brown stuff" you mention as cast out of hive reminds us of the fluffy material with which mice line their nests. We have seen just such "stuff" in the cosy nest built by a mouse among the warm coverings on top of a hive. In the present case it is, we think, the "touzled-out" remains of some bagging, or of woollen material the bees themselves have tugged to pieces in order to remove it. An examination of the hive-interior would, perhaps, explain the matter. It is certainly not the product of an insect, as you suppose.

P. C. (Glam.).—*Clearing Honey for Showing.*—1. If the honey is cloudy or shows signs of granulation, the jars must be inserted in warm water for a few hours till it becomes bright and clear. 2. The art of securing sections with few or no pop-holes at corners is only acquired by practical experience. There is no rule of thumb to go by in these matters.

HEATHER HONEY (Great Haywood, Staffs.).—*The Coming Confectioners' and Grocers' Exhibition at the Agricultural Hall.*—The date "1902" in class for heather honey is obviously a printer's error, and we have no doubt that 1903 is intended.

TYKE (Llangollen).—*Beeswax for Showing.*—Sample sent is very good on all points, and fit for any show.

PERPLEXED (Walthamstow).—*Dysenteric Drones.*—The trouble may arise from long confinement owing to bad weather, though

sometimes drones will void their excreta through excitement. An examination of the hive will show if there is any dysentery among the workers by "speckings" on combs.

W. F. HARRISON (Huddersfield).—*Feeding Late Swarms.*—1. There is nothing in dead bee sent to indicate cause of death. 2. Unless weather keeps fine and there is bee forage near, it will be necessary to feed the swarm of last Saturday. With August here the bees could hardly comb the hive without help by feeding. 3. Glad to have your appreciation of "Guide Book."

X. Y. Z. (Andover).—*Honey for Showing.*—All three samples of honey are good and well fitted for showing, but as they are showing slight signs of granulating it will be necessary to apply a little heat by immersing in warm water in order to remove the cloudiness and brighten the honey.

A. WAKERELL ((Croydon).—*Bees Changing Markings.*—1. The queen of the "native" stock has evidently been crossed with a ligurian drone, and so caused the yellow bands, but your sample-bees were so smeared with honey in post as to be beyond recognition. 2. Lavender is a good bee-plant. 3. It is too late now for queen raising.

#### *Suspected Combs.*

T. B. S. (Studley).—1. The comb sent shows foul brood clearly developing in a few cells, but we cannot decide if it is a "bad case" or not from small sample. 2. If the disease has got no further towards the spore stage in other combs, there will be no risk in using the box of shallow-frames on another hive. 3. It is useless to give surplus chamber to a stock containing "only about a quart of bees." In fact, such a stock known to be affected with foul brood should be destroyed at once.

DOONFOOT (Ayr).—Brood is all right and in normal condition, except in two cells, the larvae in which shows distinct indications of disease in the incipient stage.

M. H. (Haverstock-hill, N.W.).—1. Though one or two cells in comb have a suspicious look, the dead brood is only "chilled," not diseased. 2. Beeswax as sample would do if staged in the class for cakes suitable for commercial purposes, but in a class where quality of wax only is considered, it is not up to show standard.

#### *Honey Samples.*

F. H. L. (Nuneaton).—Sample is of good consistency, but only fair in flavour. The flavour and colour preclude the idea of its being "chiefly from white clover," as stated; it is from mixed sources, and could only be shown in a class for honey of "medium" colour.

\*.\* We are compelled to hold over a number of queries and replies till next week.

## Editorial, Notices, &c.

### HONEY IMPORTS.

The value of honey imported into the United Kingdom during the month of July, 1903, was £5,716.—*From a return furnished to the BRITISH BEE JOURNAL by the Statistical Office, H.M. Customs.*

### ROYAL LANCASHIRE AGRICULTURAL SOCIETY.

SHOW AT OLD TRAFFORD, MANCHESTER.

The above show, held on July 30 and three following days, was again a success, the attendance being very large, and the Society provided for a big show in the honey department by offering very liberal prizes in money and medals.

Fortunately the display of honey was an excellent one, with numerous entries both in the open and the county classes, which was very satisfactory considering the backward season we have had this year. The trophies, of which there were seven staged in the two classes, made a splendid show of themselves. The confectionery, &c., was also a good and interesting show.

Messrs. T. D. Schofield and Jas. Cragg officiated as judges of the exhibits, and made the following awards:—

#### OPEN CLASSES.

*Twelve 1-lb. Sections* (20 entries).—1st (£2 and B.B.K.A. silver medal), A. W. Weatherhogg, Willoughton, Lincoln; 2nd (£1), W. Woodley, Beeton, Newbury; 3rd (10s.), Miss Helena Ratcliffe, Barthomley, Crewe; res., W. Patchett, Caistor, Lincs.; v.h.c., Rev. M. W. B. Osmaston, Goodneston, Dover; h.c., E. C. R. White, Newton Toney, Salisbury; c., J. Stone, Little Cubley, Derbyshire.

*Twelve 1-lb. Jars Extracted Honey* (21 entries).—1st (£2 and B.B.K.A. bronze medal), W. Patchett; 2nd (£1), Mrs. E. Sopp, Crowmarsh, Wallingford; 3rd, (10s.), T. S. Holdsworth, Kirton Lindsey, Lincs.; res., Rev. R. M. Lamb, Burton Pidsea, Hull; v.h.c., A. G. Preen, Nesscliffe, Shrewsbury, and Miss E. S. Hole, North Taunton; c., Jas. Ball, Hesketh Bank, Preston.

*Trophy of Honey* (5 entries).—1st (£3), J. Stone; 2nd (£2), T. R. Ford, Burbwell; 3rd, Geo. Rose, Linden House, Ormskirk.

#### COUNTY CLASSES.

*Twelve 1-lb. Jars Extracted Honey* (17 entries).—1st (£1 10s. and L.B.K.A. silver medal), H. Fenney, Lea Green, St. Helens; 2nd (10s. and L.B.K.A. bronze medal), J. Jones, Wegber Quarry, Carnforth; 3rd (5s.), F. Sharples, Rainhill; res., Mrs. Jas. Stirzaker, Moss Side, Poulton-le-Fylde; v.h.c., R. Rymer; c., R. Iddon, Hesketh Bank.

*Twelve 1-lb. Sections* (10 entries).—1st (£1 10s.), Robt. Rymer, Hesketh Bank; 2nd (10s.), J. Jones; 3rd (5s.), John Hale, Croston, Preston.

*Trophy of Honey* (2 entries).—1st (£2 and society's silver medal), Messrs. Cook & Rymer; 2nd (£1 10s.), Geo. Rose.

#### OPEN CLASSES.

*Twelve 1-lb. Jars Dark Extracted Honey* (nine entries).—1st (£1 10s.), John Helme, Weobley, Herts.; 2nd (10s.), Jas. Gorst, Morecambe; 3rd (5s.), C. Lodge, High Easted, Chelmsford; res., E. C. R. White.

*Twelve 1-lb. Sections Heather Honey* (2 entries).—1st (£1 10s.), Jas. Waddell, Wooler, Northumberland; 2nd (10s.), Wm. Dixon, 5, Beckitt-street, Leeds.

*Bees Wax in Suitable Form for Shop Sale* (14 entries).—1st (15s.), Hugh Berry, Scotland-street, Llanrwst, N. Wales; 2nd (10s.), Jno. Berry, Llanrwst; 3rd (5s.), E. C. R. White; res., Charles Lodge; v.h.c., J. Berry and J. Pearman; h.c., F. W. Fruther, Crowland, Lincs.

*Exhibit of Confectionery, &c., in which Honey is Used* (2 entries).—1st (£1 10s.), J. Gray, Long Heaton; 2nd (15s.), Wm. Dixon.

*Display of Cut Flowers Visited by Bees.*—1st (£1), Geo. Rose.

*The Champion Prize for the Best Exhibit of Honey in the Show.*—The Royal Agricultural Society's silver medal was awarded to Messrs. Cook and Rymer, Lynwood Tarleton, near Preston, for their trophy of honey.—(Communicated.)

### STAFFORDSHIRE B.K.A.

#### ANNUAL SHOW.

The annual show of the Staffs. B.K.A. was held at Lichfield, on July 15 and 16, in conjunction with the annual show of the Staffs Agricultural Society. The supply of honey was smaller than usual, the season in the locality being very late; but the quality was very fair. During the afternoons lectures were given by Mr. R. Cock, F.R.H.S., and County Council lecturer and expert to the Association, which were well attended. The judges were the Rev. E. Charley, Vicar of Ince, and Mr. T. W. Jones, Etwell, Derby, who made the following awards:—

*Trophy of Honey (not to exceed 100 lb.)*.—1st, G. W. Buttery, Wheaton Aston, Stafford; 2nd, John Beach, Burntwood.

*12-lb. Sections.*—1st, G. W. Buttery; 2nd, John Lucas, Fradley Junction.

*Twelve 1-lb. Jars Extracted Honey.*—1st, Wm. Hutchinson, Leek; 2nd, G. W. Buttery; 3rd, Joseph Tinsley, Eccleshall.

*Twelve 1-lb. Jars (Dark) Extracted Honey.*—1st, W. Sproston, Shugborough; 2nd, F. F. Upton, Rugeley; 3rd, John Stubbs, Rickerscote.

*Six 1-lb. Jars Granulated Honey.*—1st,

G. W. Buttery; 2nd, Joseph Tinsley; 3rd, John Lymer, Stone.

*Three Frames of Comb Honey, for Extracting.*—1st, G. W. Buttery.

*Observatory Hive, with Queen and Bees.*—1st, Edward S. Lord, Stoke-on-Trent; 2nd, John Beach.

*Beeswax (not over 3 lb.).*—1st, F. F. Upton; 2nd, D. H. Bird, Whittington; 3rd, Joseph Tinsley.

*Twelve 1-lb. Sections (novices).*—1st, Miss L. Lowe, Tamworth; 2nd, J. Thurstans, Pattingham; 3rd, Miss Blore, Rugeley.

*Twelve 1-lb. Jars Extracted Honey (novices).*—1st, Miss L. Lowe; 2nd, Miss Lloyd, Lichfield; 3rd, J. Thurstans.

*Twenty-four 1-lb. Jars Extracted Honey (open to the County only).*—1st, J. Tinsley; 2nd, J. Stubbs; 3rd, G. W. Buttery.

*Twelve 1-lb. Sections (Cottagers only).*—1st, W. Tildesley, Stone; 2nd, G. H. Mytton, Lichfield; 3rd, T. Taylor, Pattingham.

*Twelve 1-lb. Jars Extracted Honey (Cottagers only).*—1st, C. Sharman, Fotherley, Shenstone; 2nd, W. Tildesley; 3rd, J. Croome, Weeford.

*Six 1-lb. Ditto (Cottagers only).*—1st, W. Tildesley; 2nd, J. Lymer; 3rd, W. W. Dempster, Lichfield.

*Twelve 1-lb. Sections (open).*—1st, W. Woodley, Beedon; 3rd, W. Thomas, Rugeley. (No 2nd awarded.)

*Twelve 1-lb. Jars Extracted Honey (open).*—1st, T. S. Holdsworth, Kirton Lindsey; 2nd, S. Cartwright, Shrewsbury; 3rd, W. Woodley.

*Collection of Hives and Appliances.*—E. H. Taylor, Welwyn, Herts.—(Communicated.)

## HANTS AND ISLE OF WIGHT B.K.A.

### HONEY SHOW OF THE BROUGHTON AND WALLOP BRANCH.

This show was held on July 29 in the grounds of Wallop House, in connection with the annual show of the Wallop Cottagers' Horticultural and Floral Society. Being the first honey show held in this district, it created a great deal of interest, and it is hoped will encourage local bee-keepers to start bee-keeping on more modern methods. Mr. Jas. Lee, of Monk's Acre Apiary, Andover, kindly acted as judge in the unavoidable absence of Mr. Bellairs. Mr. Lee also showed an observatory hive and other appliances, which aroused a great deal of interest.

The awards were as follows:—

*Three 1-lb. Jars Extracted Honey.*—1st, Chas. Pearcey, Wallop; 2nd, Mr. Cable. No third awarded.

*Three 1-lb. Sections.*—1st, Chas. Pearcey; 2nd, Mr. Cable. No third awarded.

*Prize for Skep Honey, exhibited by cottager or small farmer.*—Chas. Pearcey.

*Six 1-lb. Sections.*—1st, A. Joyce, Stockbridge; 2nd, T. Blake, Broughton; 3rd, S. G. Leigh, Broughton.

*Six 1-lb. Jars Extracted Honey.*—1st, G.

Ingram, Broughton; 2nd, Chas. Pearcey; 3rd, T. Blake.

*Best Shallow-frame for Extracting.*—1st, G. Ingram; 2nd, A. Joyce; 3rd, S. G. Leigh.

*Six Sections, total weight not over 12 lb. or less than 6 lb. (open to Hants and I.W.B.K.A.)*

—1st (and bronze medal of county B.K.A.), S. G. Leigh; 2nd, Mr. Earwicker, Andover; 3rd, Chas. Rogers, Broughton.

*Single 1-lb. Section (open).*—1st, Mr. Earwicker; 2nd, C. Lodge, Chelmsford; 3rd, G. Ingram.

*Single 1-lb. Jar Extracted Honey (open).*—1st, W. Patchett, Cabourne, Lincs.; 2nd, Miss Hole, N. Tawton, Devon; 3rd, G. Ingram.—(Communicated.)

## NORTH NORFOLK B.K.A.

### ANNUAL SHOW.

The tenth annual show of the N.N.B.K.A. was held in connection with the Melton Constable Horticultural Society's Exhibition in Melton Constable Park, on Bank Holiday, August 3.

The management of the honey tent was very efficiently carried out by Mr. C. J. Cooke, Hon. Sec., assisted by Mr. J. Platten, expert, and other members of the committee. Owing to the boisterous wind it was found impossible to erect the bee-tent, to the regret of many who sought to combine instruction with pleasure. The total entries numbered 105, and the competition was extremely keen. The classes for extracted honey were well-filled and remarkably even in quality. Sections, though numerous, were not so good, several of the best exhibits being disqualified for overlacing. The classes for beeswax were well filled, but the quality was unequal in several of the exhibits. A novel feature of this year's show was the competition for a £5 5s. silver challenge cup for the best exhibit in the first four classes, which was won by Mr. W. Towler, of Edgefield, with a fine sample of extracted honey.

Dr. T. S. Elliot acted as Judge, and made the following awards:—

*Twelve 1-lb. Sections (13 entries).*—1st, O. Goddard, Reepham; 2nd, H. W. Woolsey, Edgefield; 3rd, J. Mayer, Hemblington; v.h.c., H. W. Lingwood, Hindringham.

*Twelve 1-lb. Jars Extracted Honey (15 entries).*—1st, O. Goddard; 2nd, G. W. Woolsey, Edgefield; 3rd, H. W. Woolsey; v.h.c., J. Platten, Briston.

*Six 1-lb. Sections (9 entries).*—1st, W. Towler, Edgefield; 2nd, J. Nicholls, Shipdham; 3rd, E. Ridout, Langham; v.h.c., Mrs. C. Crafer, Langham.

*Six 1-lb. Jars Extracted Honey (10 entries).*—1st and "Challenge Cup," W. Towler; 2nd, E. Mann, Hempstead; 3rd, G. W. Woolsey; v.h.c., Miss F. Webb, Bacons-  
thorpe.

*Beeswax (8 entries).*—1st, J. Nicholls; 2nd, S. J. Mayer, Hemblington.

## OPEN CLASSES.

*Twelve 1-lb. Sections* (3 entries).—1st, S. J. Mayer. Others disqualified for overlacing.

*Twelve 1-lb. Jars Extracted Honey* (8 entries).—1st, O. Goddard; 2nd, G. W. Woolsey; 3rd, H. W. Woolsey; 4th, W. A. Bush, Whitwell.

*Single 1-lb. Jar Extracted Honey* (19 entries).—1st, W. Patchett, Caistor, Lincs.; 2nd, H. W. Woolsey; 3rd, W. Towler; 4th, W. Fake, Great Massingham.

*Single 1-lb. Section* (14 entries).—1st, S. J. Mayer; 2nd, S. Mayer, Senr., Hemblington; 3rd, O. Goddard; 4th, J. Mayer.

## HONEY SHOW AT NANTWICH.

The Honey Department of the Cheshire Agricultural Society's annual show, which was held at Nantwich on Thursday, August 6, was, as usual, under the management of the Cheshire B.K.A. Owing to the very unfavourable season in the county, the entries were only seventy-five in number, and a good many gaps were visible in the various classes. Some of the exhibits were, however, of excellent quality. Under the auspices of the County Council the Rev. T. J. Evans, M.A., gave a bee lecture and demonstration in the Association's tent to a large audience. The judges, Mr. E. P. Hinde, Heswall, and the Rev. E. Charley, Ince Vicarage, Chester, made the following awards:—

*Complete Frame Hive* (open).—1st, George Rose, Liverpool; 2nd, E. H. Taylor, Welwyn, Herts.

*Twelve 1-lb. Sections* (open).—1st, R. S. Marshall, Far Cross, Woore; 2nd, W. Ratcliffe, Barthomley; 3rd, J. Carver, Wellington, Salop; res., Wm. Woodley, Newbury.

*Twelve 1-lb. Jars Extracted Honey* (open).—1st, W. Woodley; 2nd, J. Carver; 3rd, J. Churton, Market Drayton; res., J. Astbury, Kelsall, near Chester.

*Beeswax* (members only).—1st, W. Ratcliffe; 2nd, G. Lambert; 3rd, H. Potts, Preston Brook.

*Six 1-lb. Sections* (members only).—1st, R. S. Marshall; 2nd, W. Ratcliffe; res., Rev. T. J. Evans, Tarvin, Chester.

*Twelve 1-lb. Jars Extracted Honey* (Members).—1st, P. H. Rawson, Market Drayton; 2nd, R. Podmore, Market Drayton; 3rd, A. Thorpe, Wistaston; res., Rev. T. J. Evans.

*Two Shallow-Frames of Comb Honey* (Members only).—3rd, Miss Surridge, High Leigh Vicarage. 1st and 2nd not awarded.

*Six 1-lb. Jars Extracted Honey* (District).—1st, P. H. Rawson; 2nd, R. Podmore; 3rd, A. Thorpe.

*Three Sections* (District).—1st, A. S. Marshall; 2nd, W. Ratcliffe; 3rd, R. Podmore.—E. CHARLEY, Hon. Sec. Cheshire B.K.A.

*The annual shows of the Leicestershire B.K.A. and the Northants B.K.A. are in type, and will appear next week.*

## Correspondence.

*The Editors do not hold themselves responsible for the opinions expressed by correspondents. No notice will be taken of anonymous communications, and correspondents are requested to write on one side of the paper only and give their real names and addresses, not necessarily for publication, but as a guarantee of good faith. Illustrations should be drawn on separate pieces of paper. We do not undertake to return rejected communications.*

*Communications relating to the literary department, reports of Associations, Shows, Meetings, Echoes, Queries, Books for Review, &c., must be addressed only to "The Editors of the British Bee Journal," 17, King William-street, Strand, London, W.C." All business communications relating to advertisements, &c., must be addressed to "THE MANAGER, 'British Bee Journal' Office, 17, King William-street, Strand, London, W.C."*

## AMONG THE BEES.

"THE WRATH OF THE BEE."

[5208.] A "High Priest" of Apiculture wrote a prose idyll in last year's August number of *Harper's*, wherein he propounded the theory that the poor hives in spring supply the irate bees whose wrath works woe and sorrow, if not death, to the bee-keeper who manipulates them. Presumably, the poorer they are the more degenerate they become, and the greater becomes the danger that their fierce anger and deadly venom will prove their owner's undoing. On the contrary, the full hive supplies the quiet, gentle, and tractable bee, overbrimming with love and liking for manipulation. Its very wealth and amplitude of riches may, nay will, soothe it of its fretfulness, deprive it of its spirit of combativeness, and make it amenable to whatever discipline its lord and master desires to subject it. Those hives with luscious, heavily laden cells, brimming over with the sweet nectarious juices derived from countless buds of Flora's fair flowers, garnered with such industrious care, after an infinite number of visits from diaphonous wings which bore their owners in erythmic flight to and fro in life's glad summer day to claim their sweet essence, can be handled with impunity.

Poverty, according to this theory, raises the ire to fever heat. It acts as an irritant which tries the temper, rouses the anger, and implants the instinct to kill or be killed. Want of food causes a species of desperation amounting, indeed, to suicidal mania. Insufficient nourishment would seem to supply a fictitious strength, generating an animus and hatred sufficient to increase the power of the sting and make its action more deadly. Famine rations would seem to give new and added virulence, and additional penetrative force to the weapon which prepares the way for the injection of the acid from the poison sac, along those tubes which convey it into the blood of the victim, there to work its deadly mission. Its noxious, malignant venom numbs the muscle, deadens the nerve, and paralyses the flow of the blood through artery and vein, bringing on a cessation of life's bringing energy.

I, an acolyte, have my doubts of the soundness of the doctrine, and would seek in some other source the cause for the deadly termination to this particular bee-keeper's manipulation of his bees. My own experience of weak and foodless colonies in spring is that they have no energy left in them for aggressive attack, and that their hearts seem too sore and their lives too bitter for warfare against mankind, other bees, or even insects, however weak and puny. I have never seen them display any rash or militant spirit, but, on the contrary, have manipulated them with perfect impunity. I would be inclined to give more weight to the suggestion that it is some fault or shortcoming on the part of the bee-keeper—some poison in his blood that lends itself to the subtle and mischievous influence of the injection from the sting.

*Transporting to the Heather.*—With the admirable special hives now provided by several of our appliance dealers, the labour of carrying bees to the moors should be a light one. Provided as these are with ample means of ventilation, and being mere square boxes, with no porch, no flight-board, no plinths, and no projecting parts of any kind, they lend themselves to close and safe packing in whatever vehicle they are being transported. Everything being made taught and snug before setting out, bees and hives can be set down at the heather as if they had been simply shifted from one site to another. Common hives and makeshift appliances, however, require some care to prevent an upset on the way to the moors. I am fortunate in having heather in close proximity to my hives, so that no shifting is required. The transporting of extra powerful colonies, referred to on page 264, seemed as the result of an enlarged breeding space, would be a serious undertaking, and one that only necessity would compel me to undertake. If I had it to do, I would make a "shook swarm" of the bees and queen, leaving only as many bees in the hive as would tend the brood, wrapping the body box warmly to save a chill. The bees would be carried in a swarm-box apart from the hive, and run in immediately on arriving at the heather, choosing preferably the early morning or late afternoon as the best time for the operation. Such a vast assemblage of bees could not be sufficiently ventilated to carry them safely in the body-box, as not only would they themselves be almost certainly suffocated, however well provided with ventilation, but the excessive heat would injure both the capped and uncapped brood if the journey were a lengthy one. We can safely infer this from the appearance of brood in even a fairly populous lot which has travelled in hot weather, as the greater part, if examined after arrival, will be found a dull, grey, flabby mass. They have been asphyxiated, and are later thrown out in large quantity. I would anticipate the results in the large populations under consideration, if carried in the hive with

even the best ventilation possible, would be disastrous. Even with moderately populated colonies this takes place more frequently than their owners are aware; and I have often heard expressions of astonishment from beekeepers when they have discovered a strong stock, which at much pains they had carried to the moors, return greatly depleted of bees; and, worse still, dwindling away by spring to a mere handful. My theory explains what to them was inexplicable. What should have resulted in a splendid batch of late brood, to prove the mainstay and support of the colony in winter and spring, has perished in the infantile stage from inhaling irrespirable gases.

*Rain, Rain, Rain!*—Yes, the rain it raineth every day. Our local paper gave statistics to prove we have had the wettest July for over thirty years, and the first week of August is no better. Yet the famine experience of last year has not been repeated. Bees are working in one, two, and even three racks. Every hive is fit, being crowded with bees and ready for the heather which is now coming into bloom.—D. M. M., Banff.

[ERRATA. — In my last "Notes" two printer's errors need correcting. In second paragraph on page 301, thirteenth line, for "twist" read "test;" and on page 302, fifth line from top of column, "do not work in frames" should read "do most work, &c."—D. M. M.]

#### TRUANT SWARMS.

[5209.] A few weeks ago a truant swarm of bees took up their abode in a hollow wall, close to the roof of my house. As the entrance to their new home is very close to the windows of two bedrooms, it is desirable to evict them. I have unsuccessfully tried various means to do this, and as their position is such that it would be a costly matter to take out sufficient brickwork, &c., to get at them at close quarters, I propose to adopt the following plan:—

Having prepared a small makeshift hive, with a frame of comb containing food, eggs, and brood, and four or five frames of brood foundation, I shall fix it to the wall of my house, close to the small opening in the brickwork through which the bees enter. I shall connect this opening and the hive by an enclosed passage, so arranged that the only way the bees can get out of the wall will be through the hive. Where the passage joins the hive I shall fix a Porter's bee-escape, so that though the bees will be able to leave their present residence they will not be able to return to it. After having fixed the temporary hive, as above described, I shall leave it undisturbed for, say, three days, when I hope to find most of the flying bees in it. I shall then wait about another week on the chance that "her majesty" may follow her subjects into the home I have prepared for them; but if she does not then her doom will



be sealed, for the hive will be removed, her means of egress will be closed with Portland cement, and she will be left to her fate.

I have a spare queen, and it might be as well to at once cage her on to the comb, so that should the present queen remain immured, there will be another ready to reign in her stead, and that one known to her people.

I presume the occurrence above narrated is not an isolated case, and therefore it may be of interest to some of your readers, if you expressed your opinion on the plan I propose, and should that opinion be unfavourable, if you would suggest a better one.—W. ALFRED DAWSON, *Cobham, Surrey, August 10.*

[Whatever may be the outcome of your proposed plan it is well worth trying, and we have no doubt that readers, along with ourselves, will be interested in the result. The only suggestion that occurs to us is that if a nucleus colony was made up in the "Make-shift" hive, with a spare queen at its head, it is certain that the bees of the truant swarm would make themselves at home in the nucleus, and that as bees hatched out from the comb in wall they also would be secured. This is, in principle, simply making a nucleus swarm.—EDS.]

#### THE RYMER METHOD.

[5210.] In reply to "W. C. H." (5195, page 304), I would say drone-comb and 1½-in. wide ends would not answer the purpose. Either worker-comb or foundation must be used. Re-adapting Board: Either this board or its equivalent must be used, or there is a danger of the frames being joined together; besides, the board entirely does away with any brace comb.—W. RYMER, *Lewisham, Yorks, August 8.*

## Queries and Replies.

[3186.] *Transferring Bees from Odd-sized Frames to Standards.*—Some little time ago I bought several stocks in skeps and frame-hives to oblige the widow of a lately deceased bee-keeper. The frames in the hives are movable, but not same size as the "standard" frame, being 13½ in. wide by 8 in. deep, with top-bars 14¼ by ⅜. They are very strong and well made but close-ended, and therefore self-spacing (I send specimen). The hives are of the "Combination" shape, holding sixteen frames, but are not in good condition. I have worked them this season as Combination hives by supering at the back, putting excluder over front frames and working the ordinary shallow-frames above, but I want to get the bees into hives taking standard frames as soon as possible. I may add that the present combs are in such bad condition as not to be worth transferring to standard frames.

Would you therefore advise me which of the following plans to adopt? 1. Should I put the present brood-frames into a super over standard frames fitted with foundation and allow the bees to transfer themselves below? Could I do this now, or should I wait till, say, next April? 2. Or could I prepare a hive with standard frames fitted with foundation or comb and with a queen excluder, and then set on top-bars of prepared hive a special super—made to take the present frames—with queen excluder between: I propose then to shake or brush off all bees—including queen—from the present brood-frames and run them into the new hive, and to put the frames containing brood into the special super above. After twenty-one days all bees would be hatched out, and I should then remove the special super, shake all bees off combs at hive entrance, take off excluder, quilt down the hive, and feed up. Would this be safe at this time of the year, or would the queen be likely to injure herself trying to get into the top hive? The bees are now strong, covering sixteen frames, so that they ought to easily draw out a few frames of foundation. Accept in anticipation my best thanks for your assistance.—E. A. HUTTON, *Hargrave Vicarage, Chester.*

REPLY.—First let us say there is no "standard hive," and we have deleted the term from your "copy." For the rest we reply:—1. We advise wintering bees on present combs and transferring as proposed next spring. It is the safest course and will save trouble, risk, and expense. 2. There is always a risk (specially warned against on page 141 of "Guide Book") to queens in your second plan, moreover it takes a good deal out of bees to give them all the work of comb-building, storing, &c., at this late season, and on the whole we advise your adopting the course advised above.

[3187.] *A Beginner's Various Queries.*—The single stock of bees I purchased last spring has exceeded expectations as regards the pleasure to be derived from studying these interesting little creatures, and by careful observation, coupled with a perusal of the "Guide Book" and your JOURNAL, I am now far better acquainted with the bees than at the commencement. There are, however, a few points which, with your kind indulgence, I should like cleared up:—1. Six weeks ago I put on a rack of shallow-frames, which, upon examination a month later, were found to be full, or nearly so. I then inserted another rack with full sheets of foundation between the first one and the brood-chamber, but these latter have not so far been touched by the bees, while work in the upper frames seems to have been suspended. I therefore ask:—Will the honey which has not yet been sealed damage the remainder when extracted? and should I remove the untouched rack and lower the first on to its original place as soon as possible? 2. Observing that the brood-

chamber is, apparently, full of honey, some of which I am anxious to extract, but unable to do so in the ordinary way—as the combs are very irregularly built, rendering uncapping difficult. The question, therefore, is: What is the proper course to pursue, seeing that I am anxious to obtain new combs, which would be much easier to manipulate? 3. I have a spare hive, which has been thoroughly cleaned and repainted. Do you advise transferring bees now, and how should it be done? 4. I am not clear as to what is meant by the mention on page 161 of "Guide Book" of "an abundance of sealed stores." On page 112 we read: "Hives should contain 30 lbs. of food," and on same page we are told that "about 2 sq. ft. of sealed honey should be left in the hive." 5. Am I correct in assuming that 2 sq. ft. of honey should be supplemented by syrup and candy to the extent of 30 lbs. in all? 6. Who are the publishers of "Root's A.B.C. of Bee Culture"? Thanking you in anticipation, also for past favours.—F. P., *Alverstoake, Gosport, August 8.*

REPLY.—1. The refusal to work in second rack of shallow frames is, we imagine, accounted for by the failure of honey income. The second rack should, therefore, be removed at once as suggested. The unsealed honey might be thrown out in extractor first if thin and unripe, otherwise we should uncup and extract all at once. 2. If the badly-built old combs are to be replaced by new and straight ones, you must make the best job possible of the uncapping and extracting and have the new combs each built between two straight ones, one or two at a time. 3. The new combs may be built in the old hive and transferred to the new one when satisfactory. The latter operation is simply done by lifting out frames from one at a time and putting in new one. Beyond giving a puff or two of smoke no instructions are needed for this, so simple is the task. 5. It is "two superficial" (not square) feet of sealed honey that is mentioned on page 113; and this would represent about 30 lb. judged by the superficial area of a 1-lb. section. 6. The A. I. Root Co., Medina, Ohio, U.S.A.

[3188.] *Drone Pupae Cast Out.*—I have a very strong early swarm hived in a deep milk-case. The bees are always very busy at work, and, apparently, in a healthy condition, the present weight (gross) being 40 lb. Yesterday (August 9), for the first time, I noticed young bee-grubs being carried out of the hive, and this morning there were about fifty or sixty of these white grubs on the alighting-board which had evidently been cast out during the night. I am quite at a loss to know the cause. I should be glad if you would kindly inform me through the B.B.J. whether it is disease, or if the brood has been attacked and killed by some insect, as the head and fore part of body in some appears to have been partly eaten. I enclose a few

for inspection, and sign myself "BEE-KEEPER," *Surbiton.*

REPLY.—There is no cause for alarm. The "grubs" cast out are drone pupae, and it merely indicates that the swarming season is over and honey-income failing, consequently the bees are ridding themselves of useless drones.

[3189.] *A Lady Beginner's Queries.*—I only commenced bee-keeping this summer, with no previous knowledge, but I have read the "Guide Book," and began taking the B.B.J.:—  
1. I see by the former that it is necessary to guard against "robbing," and would be glad to know how to detect it. 2. I notice there are two division-boards to one of my hives, but the other has only one. How, therefore, am I to reduce number of frames in the latter? Ought I to have a second division-board? 3. How many combs of sealed honey should there be for a strong colony to winter on? I see I am directed to put empty combs for the bees to cluster on. 4. How shall I know when the honey-flow ceases, and I should begin feeding? Thanking you in anticipation for your replies.—B. S. (A Lady Bee-keeper), *Harpenden, August 5.*

REPLY.—1. On page 155 of "Guide Book," in the chapter on "Robbing," the method of detecting it is clearly and fully described. 2. With only one division-board the reduced frames are pushed to one side of the hive. Two dummies are not absolutely necessary, except for nucleus forming. 3. We can add little to what is said in "Guide Book" on the amount of stores required for wintering a stock on. "About 30 lb. of food" is the weight given on page 161, and this is stated on another page to represent about two superficial feet of sealed comb, but only an approximate guess can be given as to the sealed stores in each comb, as only the upper portion is occupied with sealed food. 4. Only observation and experience will soon enable you to judge when honey has ceased to be carried in by the bees. The indications cannot well be set down in words.

[3190.] *Dark Honey for Feeding Bees.*—I am sending you a section of honey-comb, and I shall be much obliged if you can tell me the cause of the extremely dark colour of the honey in comb? I cannot part with it, nor do I know whether it is even fit to eat. I have two stocks of bees in frame-hives. They wintered in a large garden nearly three miles from where they now stand. I brought them to my present home the last week in May, and in the garden at the time was a mass of cabbage plants in full bloom, the bees being greatly attracted by it. I put a rack of sections on at once, but owing to the wet June little storing was done. But foundation was, however, rapidly drawn out and sections filled as the weather became finer. My cottage is surrounded by a park which is now a mass of white clover bloom. Both hives have done

well. I have already taken a well-filled rack from each hive and expect to have two more. The second rack contained dark honey, but it is saleable, and it secured me the 1st Prize in our Flower Show last week, the comb being beautifully white and well sealed. Can you tell me if it is possible to clarify the honey, if extracted, as at present the twenty-one sections are useless? I suppose it is not advisable to use such dark honey to feed the bees with?—M. T., *Cheam, Surrey.*

REPLY.—First let us say the section reached us smashed into pulp in post and honey running out through not being in suitable condition for travelling. Sections must be filled and comb attached to the wood on all sides to go safe by post. Yours was not more than half completed and broke away very easily with the disagreeable result stated. The honey was unfit for table use, but good enough as bee-food. It was of poor flavour and had an admixture of honey-dew in it. There is no means of making dark honey light by clarifying.

[3191.] *Taking up Bee Culture.*—I am desirous of taking up bee culture, and am at the present time looking out for a suitable piece of land for that purpose. I therefore should feel much obliged if you would kindly let me know how much I should probably require in order to raise on an average say £30 worth of honey a year, and the approximate number of hives for that purpose? Of course I am presuming that in an agricultural district I should have to provide most of the honey-making material for my bees.—W. H. T., *Denmark Hill.*

REPLY.—If by "having to provide most of the honey-making material" is meant growing your own bee-forage, you should give up that idea at once; and in any venture of the kind proposed you must locate the hives where honey-producing forage can be had without cost or trouble for the bee-keeper. With regard to the number of hives, it largely depends on the bee-man and his ability to manage them. It is also misleading to give figures taken from the results of a good bee season, when so much of success or failure depends on that most fickle of all things the "weather." Our advice is invest in a "Guide Book," and read it carefully. The possibilities and probabilities of bee-keeping are there stated with moderation and fairness, so that a good idea may be formed of what bee-keeping is likely to realise in the hands of a capable man. Above all things remember that bees can do little good in places where bee-forage is plentiful and of the right kind for producing good marketable honey.

[3192.] *Requeening Hives and Bees Refusing to Work in Sections.*—I should be very greatly obliged to you for your help in the following circumstances. In April last I found one of my stocks was queenless, but pretty strong in bees. I, therefore, gave the

queenless lot a frame of brood from my best hive to see if a queen would be raised; but, after some little time, seeing no signs of queen-cells, I gave another and similar frame of brood, but as this also was apparently resultless, I inserted a frame of foundation in the best hive, and after three days the foundation was drawn out nearly full of eggs, and this comb was transferred to the queenless stock. On examining after sufficient time had elapsed for queen-raising, I found plenty of brood in the other combs, thus proving the presence of a laying queen. Some time after I put on a rack of sections, but the bees did not work in the section at all. However, I still thought that when good bee-weather came and the new queen got well into work, the bees would begin surplus storing in the section. But they did not, and so on August 6 I removed the rack and examined the combs, and found in them patches of brood all just hatching out, and all the empty cells were full of unsealed honey, while on one frame there were two queen-cells empty. I assume, therefore, that about a fortnight ago some accident happened to the queen, and that a young queen may have been hatched, and got lost in some of the many sudden showers we have had. I therefore ask:—1. Can you tell me why the bees never took to sections, and what I had better do? This has been a very bad season here; my crop up to date is not the weight I had at this time last year. The heather, however, is in fine bloom now, but there is never a whole good day to work at it. 2. Another point on which I should like your opinion is why the bees this year and last build some sections crooked, and build brace combs, and stick them to the dividers? They never did this with me before. With many thanks for former valued assistance.—"SLIEVE DONARD," *co. Down, Ireland, August 7.*

REPLY.—1. The refusal of bees to occupy sections, if bees are strong and bee-forage is right, usually arises from some fault in management, so the cause cannot be judged from a distance by an outsider. 2. The same may be said of brace combs built against dividers and crooked combs. There is a fault either in the appliance used or in the man using it, but which to blame we cannot tell.

[3193.] *Rapid versus Slow Feeders.*—1. The only feeder I have is an inverted bottle, with a zinc cap perforated with nine small holes. It holds about 1 lb. Can I make this feeder do for my one hive when I may want to feed up rapidly for winter? 2. My bees have built comb between the side of the hive and the division-board, thus making division-board a fixture. What should I do now, please, to remove the difficulty, and how prevent such a thing in future? Please reply in B.J.—MEL ROSE, *Yarmouth, I. of W.*

REPLY.—1. Remove the zinc cap, and tie a piece of muslin or cap net over bottle mouth

(after filling the latter full with the syrup); then invert the bottle, and place over feeder. This will make the nearest approach to a rapid feeder from an ordinary slow feeder. 2. Pass a long-bladed knife between hive and division-board to sever the attachment; then cut away all brace-combs, and allow no more than  $\frac{1}{4}$  in. between division-board and hive side.

[3184.] *Bee-keeping in China—A Good Honey Yield in Suffolk.*—Could you oblige by a word in reply to the following in your next issue?—1. Is bee-keeping a profitable pursuit in China (Tientsin)? 2. I have taken the supers of my hives, and have about eleven combs in each brood-nest. I am therefore intending to extract the two end frames in each and put back empty in centre, and then feed slowly with syrup. Is this a good plan? 3. I had eleven colonies to begin the season, which by swarming increased to fourteen. From the whole I have taken 901 1-lb. sections and 150 lb. extracted honey. Is this considered good or extra-good yield?—ENQUIRER, *Suffolk, August 8.*

REPLY.—Not having any personal knowledge of bee-keeping in China, we will be glad if any reader better informed will kindly answer this question. 2. Yes; but don't defer it till too late in season. 3. You have been exceptionally fortunate in securing so good a result this year.

[3195.] *More Swarming Vagaries.*—I should like to ask your opinion about the following incidents in connection with my bees:—1. The hive in question (then my only one) sent off a strong swarm on June 1. On the 24th, as there were no signs of the presence of a queen, I gave the bees a frame containing eggs and young brood, and on July 1, I found they had constructed a queen-cell. I then went away for nearly three weeks, and on my return was surprised (on July 21) to find the centre combs already full of brood, much of which was sealed over. I can only presume that the queen who was seen emerging from her cell on June 6, had not, as I supposed, got lost, but had been in the hive all the time, but without commencing to lay until after July 1. Do you think this likely? 2. Last Wednesday, (August 5) the gardener saw a cast issue from the same hive, but as it was rather late they returned. I was not astonished therefore yesterday morning to hear that there was a cluster of bees in the hedge close to the hive, but was very surprised on trying to take them to find that the bees had already constructed several combs. I decided to leave them till the evening, and then take the bees, destroy the queen, and return the rest to the parent hive. But when I went to look at them a couple of hours later, the bees had all decamped with the exception of a few stragglers, who were crawling on the comb. One of the combs had fallen into the basket I had left just beneath them, and in the evening, as the bees did not

return, I cut down the rest. In them I found eggs (two in some of the cells) and grubs which, from their size, must have been hatched at least three or four days, so that the cluster must have been in the hedge for about a week. I presume they must have come from the hive in question, as another cast was seen to issue from there, and also because, on examining it to-day, I find no eggs or very young brood, so that I suppose the queen left behind has not yet begun laying. Is not this building in an absolutely unprotected hedge rather unusual? 3. Can you also explain why the bees have deserted the comb which they had constructed, and which was filled with eggs and young brood? Thanking you in anticipation for the answers to my queries.—E. R. H. *Brondebury Park, London, N.W., August 9.*

REPLY.—1. Yes, it is the natural conclusion to arrive at. 2. Building in the open is unusual, but not very rare. Some stocks have lived and bred on combs so built, till quite late in the autumn. 3. The desertion is on a par with the previous proceedings and only show that "bees do nothing invariably."

[3196.] *Artificial Swarming and Queen Raising.*—On May 9 last I discovered a newly-made queen cell in one of my hives, and the following day I swarmed it artificially. Just a week later I looked at five frames (half the hive) and found five queen cells containing grubs. Although I left all these in there was no second swarm. On July 4 I chanced to be examining the same stock and found eggs in queen cells, which I cut out, at the same time giving more room, a new section-rack under the one already on. Nevertheless, on July 11 they sent off a swarm that took wing and was lost, and on July 23 a cast came out. 1. Will you be good enough to say whether it is not unusual for a hive to send off two prime swarms, as distinct from casts, in the same year? 2. Whether the method of artificial swarms in which the old hive is moved and the new one put in its place always prevents casts? I send card and sign myself—A LONDON BEE-KEEPER.

REPLY.—1. It is, we should say, very rare for stock to swarm naturally during the same season in which it has been swarmed artificially. 2. We seldom hear of a hive that has had an artificial swarm taken from it attempting to swarm again that season.

[3197.] *Joining up Stocks in Autumn.*—I have had bees for this last five years, but owing to lack of time early in spring I have not had my stocks strong enough to secure much surplus when honey flow came. This season, having more time, I had all my hives (six in number) pretty strong, but as an experiment I ran two swarms together (minus one of the queens) in the end of May, into a hive containing eighteen standard bar-frames, with a queen-excluder inserted at the tenth bar. Thus leaving the remaining eight bars as a surplus chamber. I also had a rack on

the top containing eighteen shallow-frames, which are now well filled and nearly all sealed over. This is the only hive I am likely to get any surplus worth speaking of from this season. I would be glad of your advice in the following:—1. Should I run the remainder of my stocks together into a similar hive now, or should I keep them as they are till spring and then put together? 2. Is there any danger in putting two queens into a hive so constructed? 3. Would you advise me to keep all bees in an ordinary hive of ten standard frames?

I have read the "Guide Book" and also your paper for four years, but I cannot remember seeing anything to assist me in this matter, so I have ventured to write you. I may say the whole of my knowledge about bees (which is not great) I have learned from the "Guide Book" and your paper. Thanking you in anticipation.—INQUIRER.

REPLY.—If bees are strong now it would be best to defer "doubling up" till spring. 2. If queens are not kept apart by some device, one will be destroyed and even parted by excluder zinc. It is undesirable to have two queens in one hive, except on the "Wells" principle. 3. Yes; with ten to twelve frames, according to district.

[3198.] *Bee-keeping in South Africa.*—I am shortly likely to go to South Africa, and, being a bee-keeper for three years, feel I should like to continue this most pleasing and profitable hobby. Could you answer through your next issue of the B.B.J. the following queries, viz.:—1. Is bee-keeping managed similar in Cape Colony as in England? 2. Can bee-keeping be carried on in Cape Colony with profit? 3. Would it be best to take two or three stocks out with me, or can they be obtained reasonable in the Colony? 4. Should any Custom fees be charged, and to what amount.—I send name for reference and sign ANXIOUS, *South Africa.*

REPLY.—1. Much the same, but climatic conditions are somewhat different, *i.e.*, very hot days followed by extreme cold at night. 2. This is a question beyond our personal knowledge, though we have many readers out there. 3. No. You can get queens, bees, and appliances at moderate prices in South Africa just as here. 4. This calls for no reply.

[3199.] *Artificial Swarming by Beginners.*—Kindly reply to the following questions in the columns of the B.B.J., of which I am a constant reader for about two years, but (worse luck) I do not preserve the old copies as I ought for future reference. A month ago I artificially swarmed a crowded hive of bees. I left the frame with queen, brood, and honey on the old stand, and removed all the other combs and in another hive to a new stand, as per "Guide Book." The one with queen has got on all right, and has increased to eight frames, five of which are now well covered with sealed brood, but have very little honey stored. The other lot raised a queen, which

hatched out all right about ten days ago. I am sure of this, as I cut out the cell to preserve in a small museum. There were four other queen-cells—three empty, and not sealed over, and one very small one, sealed. Thinking I would prevent a swarm coming off, I cut away these cells. To-day I examined the hive, thinking to find eggs and brood, but I failed to see any; neither did I see the queen. I found two partly-formed queen-cells on one frame, but, of course, they were empty. So I am afraid something has happened to the queen. I have given this hive another comb of brood eggs and in different stages, and determined to write to you for advice. There are hardly any stores in this hive either. My questions are these:—1. Have I done right so far? 2. Is it now too late to raise a queen? 3. If so, had I better introduce one, or can I buy a skep of driven bees with 1903 queen and unite them? 4. Had I better start feeding rapidly now, or wait a few weeks, and feed slowly now. There is very little heather here, and we have had a miserable season for honey. I hope I have put the questions clearly. I send name, &c., but please answer "CARDI, WALES."

REPLY.—1. The correct thing would have been to leave the parent hive severely alone, without cutting out queen-cells. 2. It is now too late to raise queens. 3. The last-named plan will be best. 4. Feed slowly now, to stimulate brood-rearing; then finish off by rapid feeding in September.

## Bee Shows to Come.

*A nominal charge of 2s. 6d. is made for notices in this column, which covers cost of insertion from order till date of show. Cash should accompany orders for insertion.*

August 15, at Chorley, Lancs.—Classes for six 1-lb. jars Extracted Honey and six 1-lb. Sections. Open to the county. Schedules from Peter Hodgkinson, Secretary, Chorley Agricultural Society, Town Hall-square, Chorley, Lancs.

August 19, in the Great Western Park, New Swindon.—Wilts B.K.A. County Show of Bees, Honey, &c. Fifteen classes in all, five open to all England. Schedules from the Hon. Sec., W. E. Burkitt, Buttermere Rectory, Hungerford, or from local Hon. Sec., S. W. Filtness, Market House, Marlborough-oad, Swindon. Entries closed.

August 19 and 20, at Shrewsbury.—Annual show of the Shropshire B.K.A., in connection with the Shrewsbury Horticultural Society's Great Floral Fête. Seven open classes for honey. Schedules from S. Cartwright, hon. sec., Shawbury, Shrewsbury. Entries closed.

August 22, at Hawkshead, Lancashire.—Honey show in connection with the Hawkshead Horticultural Society. Open classes for Six 1-lb. Sections and Six 1-lb. Jars (medium or dark) Extracted Honey. Prizes 10s., 6s., and 4s., and medals of the L.E.K.A. Schedules from Dr. Allen, Hawkshead, Lancs. Entries close August 15.

August 22, at Barton, near Northwich.—Honey department of the Flower Show. Local classes for light and dark honey, sections, and beeswax. Class for twelve 1-lb. jars extracted honey open to county and members of the Cheshire B.K.A. First prize, silver medal of the C.B.K.A. and 15s. Schedules from Mr. S. Wade, Heathside, Barton, Northwich. Entries close August 15.

**August 25, at Cartmel, Lancashire.**—Honey show in connection with the Cartmel Agricultural Society. Open classes for sections, extracted honey, and beeswax. Local classes for sections and extracted honey. Schedules from Wm. Cragg, Secretary, Cartmel, via Carnforth. **Entries close August 13.**

**August 26, at Reading.**—Honey Show of the Berks B.K.A., in conjunction with the Annual Exhibition of the Reading Horticultural Society. Open classes for comb honey in sections and for extracted honey. Local classes include prizes of 20s., 15s., 10s., and 5s. for honey trophy. Also classes for owners of small apiaries. Schedules from D. W. Bishop-Ackerman, Hon. Sec. Berks B.K.A., 131, King's-road, Reading.

**August 27, at Llangollen.**—In connection with the fifth annual Flower Show. Open classes for Six 1-lb. Sections, Six 1-lb. Bottles Extracted Honey, and Beeswax. Schedules from Frank Little, Castle-street, Llangollen. **Entries close August 13.**

**August 27, at Montgomery,** in connection with Montgomery and District Horticultural Show. Open classes for Six 1-lb. Sections and Six 1-lb. Jars, Extracted Honey. Prizes in each class 10s., 5s., 2s. 6d. Entrance-fee 1s. each. Schedules from W. J. Jones, Secretary, Montgomery. **Entries close August 20.**

**September 8, at Woodstock.**—Oxfordshire B.K.A. Honey show. Open classes (with free entry) for single 1-lb. section and single 1-lb. jar extracted honey. Prizes 7s. 6d., 5s., and 2s. 6d. in each class. Schedules from H. M. Turner, Hon. Sec., 4, Turl-street, Oxford.

**September 5 to 12, at the Agricultural Hall, London.**—Honey show in connection with the Confectioners', Bakers', and Allied Traders' (11th) Annual Exhibition and Market. Numerous classes and liberal prizes for comb and extracted honey and beeswax. Open to all British Bee-keepers. Special attention is directed to the new Honey-selling Classes with Free Entry. Schedules (now ready) from H. S. Rogers, Secretary, Exhibition Offices, Palmerston House, Old Broad-street, London, E.C. **Entries close August 19.**

**September 9 and 10, at Derby.**—Derbyshire B.K.A. Twenty-second Annual Show of Hives, Honey, and Honey on the show ground of the Derbyshire Agricultural Society. Schedules from R. H. Coltman, Hon. Sec. D.B.K.A., Station-street, Burton-on-Trent. **Entries close August 22.** Double fees to August 29.

**September 17, 18, and 19, at Crystal Palace, Surrey, B.K.A. Annual Exhibition of Bees, Honey, Wax, and Appliances, &c.** Twenty-four classes (ten open to all). Increased prizes and medals. Schedules from F. B. White, Secretary, Marden House, Redhill, Surrey. **Entries must be made before September 1.**

**September 19 to 26, at the Agricultural Hall, London.**—Honey Show in connection with the eleventh Annual Exhibition and Market of the Grocery and Kindred Trades. Numerous classes and liberal prizes for comb and extracted honey and beeswax. Open to all British Bee-keepers. Special attention is directed to the new Honey-selling Classes with free entry. Schedules from H. S. Rogers, Secretary, Exhibition Offices, Palmerston House, Old Broad-street, London, E.C.

**October 6 to 9, at the Agricultural Hall, London.**—Show of Honey and Bee-produce in connection with the British Dairy Farmers' Association. Numerous and liberal prizes for honey, &c., including the valuable Silver Challenge Cup of the B.B.K.A. Schedules from Mr. Wm. C. Young, Secretary, 12, Hanover-square, London, W.

### Notices to Correspondents & Inquirers.

Letters or queries asking for addresses of manufacturers or correspondents, or where appliances can be purchased, or replies giving such information, can only be inserted as advertisements. The space devoted to letters, queries, and replies is meant for the general good of bee-keepers, and not for advertisements. We wish our correspondents to bear in mind that, as it is necessary for us to go to press in advance of the date of issue, queries cannot always be replied to in the issue immediately following the receipt of their communications.

\*\* Referring to the mention of *Small Honey Jars* in our last week's issue (page 315), Mr.

Geo. Rose, Great Charlotte-street, Liverpool, writes:—"I missed seeing the previous inquiry, mentioned by 'Eucalyptus,' but, in common with other leading bee-appliance dealers, I regularly catalogue a full line of small honey jars, in different shapes, holding from 1 oz. up to 18 oz."

J. B. W. (Gelli Lydan).—*Heavy Sections for Showing.*—If the schedule states that sections are "reputed lb." or "approximating 1 lb.," there can be no question of disqualifying sections for being a little over or under that weight. You are therefore quite safe in staging them. On the other hand, we are not aware of sections being disqualified for being over 16 oz.

E. W. L. (King's Lynn).—*Earwigs in Hives.*—*Unfinished Sections.*—1. Most bee-keepers keep earwigs from becoming a nuisance by simply brushing the insects off—whenever found in clusters—into a vessel containing water and then destroying them. Messrs. Jas. Lee & Son stock an iron cup for hive legs that will effectually keep earwigs out of hives. 2. The subscription to B.B.J. is printed in every issue. 3. Bees cannot finish off sections unless honey is to be had in the fields. Probably too much surplus room has been given for the season. We should remove one rack of sections, and leave on only those that are nearly sealed.

J. C. (Staindrop).—*Old Manuscript Book on Bees.*—We regret having overlooked this, through press of work, but hope to be able to peruse it ere long, and will then write.

### Suspected Combs.

R. P. (Epsom).—Comb contains foul brood of old standing.

ARTHUR (Bridgnorth).—*Bees and "American Blight."*—We are unable to afford any information as to cause of death of bees; but are making inquiries, and hope to have some information later on.

J. SWALES (Sleights).—*Development of the Honey Bee.*—Some years ago Mr. R. A. H. Grimshaw contributed a series of articles on this subject to our pages. The whole series, extending over a whole year's issue of the B.B.J. Mr. Grimshaw also wrote a paper on the "Bee's Sting as an Ovipositor," so that the whole subject has been fully dealt with.

### Honey Samples.

W. C. H. (Newton Abbot).—Honey is from mixed sources. It seems about medium in colour, but we cannot well judge as sample is sent in a bottle of green glass. Flavour not good; in fact, it is of rather poor quality on the whole.

\*\* Some Letters and Queries are unavoidably held over till next week.

## Editorial, Notices, &c.

### NORTHANTS B.K.A.

#### ANNUAL SHOW.

The annual show was held at Kingsthorpe on August 6, in connection with the Kingsthorpe Horticultural Show, and considering the very unfavourable season, a very good display was made by about forty exhibitors. Several additional exhibits were sent "not for competition," which added to the attractive appearance of the tent, Mr. Burnett showing a crown worked in comb, and Mr. Pilgrim a large frame of photographs of bee subjects. Several supers were also staged.

The Rev. W. C. Richardson and Mr. J. R. Truss judged the honey and wax, while Mr. G. Hefford the honey cakes. The following awards were made:—

*Twelve 1-lb. Sections.*—1st, James Adams, West Haddon; 2nd, W. Todd, Oundle; 3rd, G. S. Pilgrim, Northampton; 4th, G. Page, Holcott.

*Twelve 1-lb. Jars (Light) Extracted Honey.*—1st, W. Manning, Northampton; 2nd, E. Morris, Gretton; 3rd, G. Page; 4th, W. H. Williams, Overstone; h.c., W. Todd.

*Twelve 1-lb. Jars (Dark) Extracted Honey.*—1st, J. Adams; 2nd, H. Williams; 3rd, W. Manning; 4th, J. Bubb, Bugbrooke.

*Six 1-lb. Jars Granulated Honey.*—1st, F. J. Old, Piddington; 2nd, W. Manning; 3rd, J. Adams.

*Three Shallow-frames Comb Honey.*—1st, W. Todd; 2nd, C. J. Burnett, Northampton; 3rd, J. Adams; 4th, G. S. Pilgrim.

*Beeswax (not under 1 lb.).*—1st, C. Wells, Oxendon; 2nd, Mrs. Wells; 3rd, W. H. Williams; 4th, Mrs. Bubb.

#### NON-PREVIOUS WINNERS CLASSES.

*Six 1-lb. Sections.*—1st, W. Todd; 2nd, H. J. Norman; 3rd, J. R. Abrahams, Kingsthorpe.

*Six 1-lb. Jars Extracted Honey.*—1st, W. Todd; 2nd, F. E. Norman; 3rd, E. Morris.

*Super of Comb-Honey.*—1st, E. Morris; 2nd, T. Norman; 3rd, F. E. Norman.

Mr. Capell's prize of frame-hive for most merit in above three classes was awarded to W. Todd.

#### SPECIAL PRIZES IN OPEN CLASSES WITH FREE ENTRY.

*Single 1-lb. Jar Extracted Honey.*—1st, J. S. Holdsworth, Kirton Lindsey; 2nd, W. Rodwell, Driffild; 3rd, A. G. Preen, Nesscliffe; 4th, C. Lodge; 5th, W. Cook, Market Rasen; h.c., Miss S. Hole and W. Patchett.

*Single 1-lb. Jar Extracted Honey (Work-house Class).*—1st, J. T. Holdsworth; 2nd, C. Lodge; 3rd, E. Morris; 4th, G. Page; h.c., G. Hill, Comberton, Cambridge.

*Honey Cake.*—1st, Miss Whiteside, Kingsthorpe; 2nd, Mrs. Hefford; 3rd, Mrs. Sharmar; 4th, Miss E. Burnett, Langham Place; h.c., Mrs. Bubb.—*Communicated.*

### LEICESTERSHIRE B.K.A.

#### ANNUAL SHOW.

This Association held its annual honey show in connection with the Abbey Park Flower Show at Leicester on August 4 and 5. The weather was all that could be desired, and the whole exhibition was a great success. Some idea as to its popularity may be gathered from the fact that over 33,000 visitors passed the turnstiles in one day alone. The honey department was about up to the usual average and reflected great credit upon those who were responsible for the arrangements. Lectures and demonstrations were given on both days by Mr. P. Scattergood, Notts, and Mr. Riley, Leicester, who also officiated as judges of the bee and honey department. The manipulations in bee-tent were carried out by Mr. W. W. Falkner, Market Harboro'. List of awards:—

*Observatory Hive with Bees and Queen.*—1st, Sir Humphrey De Trafford, Bart., Hill Crest, Market Harboro'; 2nd, A. Beadmore, Woodhouse Eaves.

*Twelve 1-lb. Sections.*—1st, W. W. Falkner, Market Harboro'; 2nd, F. Pickersgill, Withcote; 3rd, H. Dilworth, Shanton.

*Twelve 1-lb. Jars Extracted (Light) Honey.*—1st, J. Waterfield, Kibworth; 2nd, J. Orton, Enderby; 3rd, G. J. Levers, Loughboro'; 4th, W. Wesley, Desford.

*Twelve 1-lb. Jars Extracted (Dark) Honey.*—1st, A. Smith, Walton Grange; 2nd, E. A. Jesson, North Kibworth; 3rd, W. W. Falkner.

*Twelve Bottles Granulated.*—1st, J. Waterfield; 2nd, H. Dilworth.

*Display of Honey.*—1st, J. Waterfield; 2nd, Miss S. J. Cooper, Leicester.

*Six Bottles Dark Honey (Novices).*—1st, A. Jesson; 2nd, C. Timlock, Leicester.

*Six 1-lb. Sections (Novices).*—1st, H. Willey, Gilmorton; 2nd, Sir Humphrey de Trafford, Bart.

*Six 1-lb. Jars Light Honey (Novices).*—1st, Mrs. J. Orton, Enderby; 2nd, Hy. Bradbury, Kirby Musloe.

*Honey Beverage.*—1st, Mrs. Waterfield; 2nd, A. Brown, Loughboro'.

*Honey Cake.*—1st, Mrs. Waterfield; 2nd, Mrs. Falkner, Market Harboro'.—(*Communicated.*)

### BRISTOL AND DISTRICT B.K.A.

The above association held its annual show in connection with the Chew Magna Horticultural Society on Aug. 12, the entries numbering seventy, and the quality of the exhibits staged was well up to the general average of the season. The arranging and staging of the exhibits were well managed by Mr. James Brown, secretary of the B.K.A., and a committee consisting of the following:—the Rev. and Mrs. Carpenter, Mr. and Mrs. Waller, and Messrs. G. Kirby, J. W. Leat, and W. Morris.

Mr. Herbert F. Jolly, Bristol, and Mr.

J. W. Brewer, Bath, officiated as judges, and made the following awards:—

*Trophy of Honey of any Year.*—1st, G. W. Kirby, Bristol.

*Twelve 1-lb. Jars Extracted Honey.*—1st, W. Woodley, Newbury; 2nd, A. H. Lyons, East Harptree; 3rd, G. W. Kirby.

*Twelve 1-lb. Sections.*—1st, W. Woodley; 2nd, J. Coates; 3rd, G. W. Kirby.

*Single 1-lb. Jar Extracted Honey.*—1st, W. Hatcliff, Lincoln; 2nd, S. Gibbs, Wells; 3rd, W. Patchett, Caistor; v.h.c., A. H. Lyons.

*Single 1-lb. Section.*—1st, W. Woodley; 2nd, E. Meade; 3rd, G. W. Kirby.

*Collection of Bee Appliances.*—1st, Brown & Sons, Bristol.

*Six 1-lb. Sections.*—Silver medal, Jas. Coates; bronze medal, G. W. Kirby.

*Six 1-lb. Jars Extracted Honey.*—Silver medal, G. W. Kirby; 2nd, Mrs. Waller; v.h.c., J. Coates.

*Three Shallow Frames Comb Honey.*—1st, G. W. Kirby; 2nd, A. H. Lyons.

*Three 1-lb. Jars Granulated Honey.*—1st, R. Flower; 2nd, J. Coates; 3rd, A. H. Lyons.

*Beeswax.*—1st, R. Flower; 2nd, G. W. Kirby.

*Six 1-lb. Sections (novices).*—1st, M. A. Exon; 2nd, A. H. Lyons; 3rd, Mrs. Waller; h.c., Mrs. Carpenter.

*Six 1-lb. Jars Extracted Honey.*—1st, M. A. Exon; 2nd, S. Gibbs; 3rd, A. H. Lyons; v.h.c., Mrs. Waller.

*Six 1-lb. Jars Extracted Honey (shown in square Jars).*—1st, A. H. Lyons; 2nd, Chas. Harris; 3rd, Mrs. Carpenter.

*Display of Honey and Honey Products.*—1st, G. W. Kirby.

#### NOVICE CLASSES.

*Three 1-lb. Sections.*—1st, S. Gibbs; 2nd, C. Harris.

*Three 1-lb. Jars Extracted Honey.*—1st, S. Gibbs; 2nd, C. Harris.—(Communicated).

### THE RAMSEY (ISLE OF MAN) HORTICULTURAL SOCIETY.

This Society held their second annual show in the Palace, Ramsey, on Wednesday, August 12, under most favourable circumstances. J. D. Clucas, Esq., M.H.K., congratulated the promoters on the very excellent display of fruit, flowers, and honey, and wished continued success to the Society. The show of honey, considering the year, was good, some sixteen exhibits being staged. Mr. T. Fragher, Douglas, judged, and made the following awards:—

*Six Jars Light Honey.*—1st and special, P. W. Brooke; 2nd, T. Wetherall.

*Six Jars Dark Honey.*—1st, P. W. Brooke.

*Three Jars Light Honey.*—1st and special, T. Wetherall; 2nd, W. E. Vondy.

*Three Jars Dark Honey.*—No entries.

*Six Sections.*—1st, T. M. Vondy; 2nd, T. Wetherall.

*Three Sections.*—1st, T. Wetherall; 2nd, C. S. Vondy.

Two well-finished "Standard" frames were exhibited, the total weight being 11½ lb.

The judge remarked he found some difficulty in placing the awards, owing to the equality of the exhibits.

### LANCASHIRE BEE-KEEPERS' ASSOCIATION.

#### HONEY SHOW AT CHORLEY.

The first honey show in the history of this Society was held on the 15th inst., in connection with the Chorley Agricultural Society. The entries in the extracted class were very good in every respect. There was not, however, a large exhibit of sections, but the prize winners were of excellent quality. The awards were:—

*Six Jars 1903 Extracted Honey.*—1st, Henry Fenney, St. Helen's; 2nd, George I. Johnson, Southport; 3rd, Robert Rymer, Hesketh Bank; Reserve, Frederick Sharples, Rainhill; v.h.c., C. J. H. Walmesley, Bretherton; h.c., J. Partington, St. Anne's-on-Sea; h.c., J. Dickinson, Addington.

*Six Sections (1903) Honey.*—1st, Robert Rymer; 2nd, J. Jones, Caunforth.

Silver and bronze medals presented by the hon. Treasurer, Mr. Frederick H. Taylor, of Cleveley, were respectively awarded to Messrs. Fenney and Johnson for their exhibits of extracted honey.

Mr. Frederick H. Taylor acted as judge. Owing to the inclement weather, the demonstrations and lectures in the bee tent could not be given.

### DO DRONES KEEP THE HIVE WARM?

I notice that Mr. Hasty criticises my position on the drone question. He says: "It is not quite *always* that we can have the warming presence of the drones answered by the workers just as well. The first night after swarming finds workers reared in the drones' place mostly all gone, while most of the drones are where they are needed." Then he adds: "Will 50,000 bees in the flush of the season feel quite satisfied in their own minds if no drones are among them?"

There are no rules without exception, and I will grant that if a swarm happens to issue on a certain day, and the weather changes suddenly that same day from hot to cool, the drones, if they have not gone in part with the swarms, may prove a little help for a night. After the first night there are enough young bees hatched out to keep up all necessary heat.



But swarms rarely issue when the weather is cool, or when there are sudden atmospheric changes. Swarms are usually cast when the weather is hot and likely to remain hot. Drones pay no attention to the brood. They prefer to stay on the honey, so as to be able to help themselves without moving.

A colony which has cast a swarm has usually a sufficient number of worker-bees in the field at the time the swarm issues to keep the combs warm—the brood-combs at least—in a cool night, for those bees are all back to the hive for the night, though they were away when the swarm went off. Those drones not only do not care to keep the brood warm, but they do not care where they are, so they are warm themselves, and they are usually nested away in the upper part of the combs if the weather is cool. Then please bear in mind, it will bear repeating, that those drones have all been reared at a time when the hive needed warmth to keep its brood warm, when it took valuable worker-bees to nurse and hatch all the brood.

Mr. Hasty thinks the bees will be satisfied in their own minds if there are no drones among them in the flush of the season. Well, I believe he is right, but I never have been able to keep a colony from rearing any drones at all. Only if we can keep the breeding of these drones down to a few hundred instead of a few thousand, I think we will have achieved a great saving, and will also have helped prevent the most promiscuous swarming, for I have repeatedly observed that the colonies which were allowed to rear the greatest number of drones were the ones which swarmed the most.

To me, natural swarming is a hindrance to success. I want to control it, and do in a great measure. If we want increase we can always make it artificially from choice queens and from colonies which would produce so little surplus that it is all gain to make the increase from them. In order to do this we must ascertain the best methods to avoid natural swarming, and the prevention of drone-rearing is one of the requisites.

But there will always be in any hive a few drone-cells—a corner, here and there, where the bees will find place for a few large cells, and there will be drones enough reared to let the bees know that they are there, for they are so noisy and clumsy that I imagine they are only *tolerated*, most of the time, just like a lot of noisy children in a busy place.

What I hold and want to impress on the beginner who reads the *American Bee Journal* is the advisability, in a state of domestication, to regulate the production of drones by removing the drone-comb and replacing it with worker-comb, just as much as possible, in every hive from which we do not particularly care to get reproducers. I hold that in a state of absolute freedom, each colony of bees is induced by Nature to rear a large number of drones for the sake of the young queen that

must meet one in her wedding-flight. In a state of domestication, when we congregate fifty colonies in one location, it is our place to regulate this over-production of drones, for it becomes an over production when we gather the colonies in one spot, the drones of one or two colonies being amply sufficient to mate with the fifty young queens that may be reared.

In a state of entire freedom a colony of bees will not continue to store honey away till it amounts to tons. It will rear drones enough to eat its surplus, *at some time or other*. This in a general way. A colony that is ill-supplied with honey will kill its drones much sooner than one that is rich in stores, or "fat," as the French call it. The rich colony will also rear drones much earlier in spring, and will thus use up its surplus. But our domestication of the bees will not be thorough if we do not learn to save on the breeding of drones, and cause our bees to produce only enough of them for the absolute needs of the apiary.

If drones had been intended at all for warmth, they would have been kept when the weather is cold in the spring. But the reverse is the case. Let there be a few weeks of warm weather early drones will be reared, then let a cold spell come when the brood needs care and warmth, and at that very time you will see the workers persecuting the drones, driving them out, mercilessly, one by one, to tolerate them again when the heat returns.—C. P. DADANT, in *American Bee Journal*.

## Correspondence.

*The Editors do not hold themselves responsible for the opinions expressed by correspondents. No notice will be taken of anonymous communications, and correspondents are requested to write on one side of the paper only and give their real names and addresses, not necessarily for publication, but as a guarantee of good faith. Illustrations should be drawn on separate pieces of paper. We do not undertake to return rejected communications.*

*Communications relating to the literary department, reports of Associations, Shows, Meetings, Echoes, Queries, Books for Review, &c., must be addressed only to "The Editors of the 'British Bee Journal,' 17, King William-street, Strand, London, W.C." All business communications relating to advertisements, &c., must be addressed to "THE MANAGER, 'British Bee Journal' Office, 17, King William-street, Strand, London, W.C."*

*\*.\* In order to facilitate reference, Correspondents, when speaking of any letter or query previously inserted, will oblige by mentioning the number of the letter as well as the page on which it appears.*

## NOTES BY THE WAY.

[5211.] At time of writing we are in the middle of the harvest month, and the continuous unsettled weather is altogether unsuitable for the ingathering of the crops, one day warm and bright with a cloudless sky, the next a veritable downpour of rain, making our hops as unstable as the barometer. This variability has also had its effect on the bees and their work. Had the past three weeks

of August been fine and warm we should in this district have seen a good finishing to a poor season. The limes blossomed late, and the earlier heavy rains brought every root of white and every bramble bush clover into profuse blooming, making an excellent breadth of forage, and this has been a great help to the bees even under the adverse weather conditions; but had they been able to take full advantage of the bountiful forage, we should have redeemed the poor start and finished up nearer the average. It would appear that much of the honey gathered is darker in colour than usual, probably owing to the blight on the plants, and I hear that our friends in the north have had so poor a season as to make it trying and disheartening, especially to those who have only just taken up with bee-keeping. All this makes us hope the heather harvest will compensate them in a measure for the loss of the flower honey.

*New Appliances.*—The introduction of new appliances proves that we are still hoping to excel and advance on our previous work. I have myself this season tried the new Shepard-Howard wire dividers (both single and double) with bee-space between each row of sections. With regard to the single wire dividers, I tried them in racks of sections, half the rack with ordinary slotted tin, and the other half with the single wire, and in each case the slotted tin divider was away ahead of the woven wire, seeing that at least 25 per cent. of the sections in the latter had attachments built to the wire dividers, while not one of the sections were attached to the tin. I therefore fear that these wire dividers will be left out of use next season in my case. On the other hand, with the double bee-space between the wire dividers, there was only a single section with the comb attachments, but although put on one of my best stocks there was not a "show" section in the whole rack. They were, as a rule, nicely capped, but not filled out to the wood, although extra time was given before second rack was put on. The second rack (on same time), fitted with slotted tin or zinc dividers, had its sections well built out, in fact, had the quality been equal to those in the first crate, I could have had a prize dozen out of the twenty-one sections.

The lesson proved that in my case these new appliances are no advance on the old, tried ones used for the same purpose; and, again, had I embarked on enough to fill 100 racks, I should have been 300 sections short—three sections in each rack, or eighteen instead of twenty-one—for my expenses and trouble. Possibly, had I delayed work with 100 hives in order to give the bees extra time to finish the sections well, as I did in this case, it might have meant another 500, more or less, sections, and thus proved a very costly "fad." I must defer a further trial of the tall sections till 1904. The hive on which they were placed swarmed and cast; consequently, I have no tall sections to report upon.

*Trouant Swarms.*—Referring to Mr. Dawson's idea, on page 324, of fixing a temporary hive to catch the bees coming from the hole in the wall, I would suggest that he makes a metal or wood tunnel from the hole in the wall by which the bees may pass out right under the entrance to the nucleus hive; the said tunnel to have a cone-end of perforated zinc. If this fails to dislodge the bees, sulphur fumes from the smoker blown in will kill them.

*Starving Bees.*—I can endorse Mr. D. M. M.'s remarks *re* starving bees. There is not much fight left in them when food runs short; and in moving bees long distances to the heather, I have no doubt that the jolting of the conveyance displaces a lot of brood, in various stages of growth. The fact that the hives are placed in position, and left, in a measure, to take care of themselves, with but little supervision, may account for the fact that these hives are not observed as they would be if in the bee-yard at home.

*Making the Most of the Season.*—As bees are disinclined for comb-building at this period of the year, I have placed two extracting-combs at the back of brood-nests in some of my strongest colonies, and they are storing in them (when weather permits). The Combination style of hive gives ample room for this system of enlargement of brood-nest, and it encourages the bees to greater efforts. The shallow-frames from which the early honey has been extracted are just the thing for this dodge of securing a little surplus after the usual harvest, but do not rob the winter stores in so doing.—W. WOODLEY, *Beeton, Newbury.*

(Correspondence continued on page 336)

## HOMES OF THE HONEY BEE.

### THE APIARIES OF OUR READERS.

In Mr. R. C. Blundell, whose apiary—along with himself—is shown on next page, we have a country bee-keeper of the best type, one whose active sympathy with the craft extends outside his own admirable bee-garden, which latter has, to our knowledge, been the scene of some notable functions, all tending to promote the good of bee-keeping.

We hope our friend's active connection with Association work will long continue; such practical form helps the backbone of the industry and materially assists its progress.

The following "Notes," written at our request, are useful and interesting:—

"I started bee-keeping, in the spring of 1886, by purchasing two stocks in straw skeps which had swarmed the previous year. I next bought a frame-hive, and enlisted the services of an expert to transfer the bees into the latter, which he did by uniting both lots as one strong stock. Up to this time I knew little about bees, though my father had kept them on the old skep system; but during the

operation of transferring I was greatly astonished at the manner in which the expert handled the bees, and also at the information he gave me respecting them. Everything went well afterwards, and ere long I had two racks of sections on the hive, from which I took altogether sixty well-filled ones. During the following year my stocks were increased to six, and in the autumn of 1888 I bought three stocks in "Cowan" hives, which in the following year gave me a good yield of extracted honey. In this way my apiary has gone on increasing till it now consists of thirty stocks. The photo does not take in all the hives; they are somewhat far apart, as I am not cramped for room. It soon became plain to

keepers' Association for the purpose of outdoor demonstrations and lectures given by the Association with the generous aid of the Surrey County Council. These demonstrations, &c., were always well attended. The Surrey B.K.A. have also used my apiary on two occasions for holding examination of candidates for the third-class expert's certificates of the British Bee-keepers' Association, the examiner on both occasions being Mr. W. Broughton Carr, whom it always affords me very great pleasure to meet. I took an active part in the resuscitation of the Surrey Bee-keepers' Association, and have been a member of the executive council since the reorganisation. The Association, mainly owing to the untiring energy



MR. R. C. BLUNDELL'S APIARY, "BENHAMS," HORLEY, SURREY.

me that practical experience was the surest way to acquire the art of bee-keeping, and in gaining this experience I frequently availed myself of a day's outing with an expert when the latter was visiting clients. I also accompanied him on bee-driving expeditions for securing driven bees. In this way I spent many enjoyable days, and got valuable hints which have been advantageous to me in my later bee-work.

I have also been a reader of the BEE JOURNAL for many years, and from its pages have gathered a large amount of useful information. It has at all times afforded me great pleasure to help the bee-keeping industry by giving assistance to neighbouring bee-keepers and by placing my apiary at the disposal of the Surrey Bee-

keepers' Association, Mr. F. B. White, is now in a flourishing condition, and doing good work in forwarding the best interests of the industry throughout the county. I am also a member of the council of the B.B.K.A.

I work principally for extracted honey, as I find a better sale for it than in sections, and, although not located in a good honey district, I have taken several prizes at various shows. Our chief yield is from lime and clover. I have found bee-keeping not over profitable but instructive and enjoyable, and besides being a most health-giving occupation. With apologies for occupying so much of your valuable space, I trust that with the advent at last of warm bee-weather members of the craft will have a good season for 1903."

## CORRESPONDENCE.

(Continued from page 334.)

FORMALDEHYDE *v.* FOUL BROOD.

[5212.] In reply to Mr. H. Marrs (5,205, page 314), for the result of my experiment, I am sorry to say it was spoilt by the bees themselves objecting to being experimented with. They were run on to starters, in a clean hive, to be starved, whilst their combs were being fumigated; but on trying to run them back on to their combs next day, we found that they had joined a neighbouring hive. It is doubtful if the stock was not queenless. The gas is very strong indeed, but we found no unpleasant after effects from breathing it; though it is best to operate in an outhouse. I purpose experimenting again on the first opportunity.

I notice in an extract from the *Bee-keepers' Review* (American) that Professor Harrison, of Ontario Agricultural College, has made a good success of this treatment for foul-brood, and states that no growth of the germ was obtained after one hour's influence under the gas. He used the liquid formalin, and mentions that the pressure obtained might help in the result; but the pressure obtained by 3 oz. or 4 oz. of liquid evaporating into a comparatively large chamber would be a mere nothing. It is a choice between this small pressure, or the stronger gas without any pressure, when using the solid formaldehyde, with its more penetrating properties.

I used two tablets (which according to instructions, will fill 100 cubic ft. with gas), taking five minutes to evaporate, and I plugged up the gas-hole before it was quite all evaporated, so that air might not be injected.

Professor Harrison adds "that the expense of his method of disinfecting with formalin is trifling." The combs of 300 colonies can be disinfected at an annual outlay of about 10d.—GEORGE M. SAUNDERS, *Keswick*.

## HEATHER PROSPECTS.

[5213.] The heather in this district is looking well, and given a week of fine weather will be fully out. The bloom promises to be the best for several years, and if only the atmospheric conditions were favourable there would be a race between it and the bees, as to which came out at the top. Stocks that are headed by young queens are to-day carrying in pollen freely, which causes not only the occupants to hum, but also hive-owner, who is very happily looking on. From what I have seen there are not so many hives at the moors as usual, which perhaps the disastrous season of last year and the bad weather of this may account for. With plenty of sunshine, however, there is every prospect of the bees that are there reaping a rich harvest.—R. T. TENNANT, *Thirsk, August 17, 1903.*

## Queries and Replies.

[3200.] *Keeping Bees in India.*—Can you tell me whether I am likely to be able to start and maintain an apiary at Karachi, India? Any information you can give me I should be most grateful for, as I should take out some apparatus with me if bees are likely to prosper there. I should be grateful for an early reply, as I start for India in October.—E. M., *Colchester, August 5.*

REPLY.—Not having any personal knowledge of the district named, we forwarded your query to Mr. F. W. L. Sladen, of Dover, knowing that the latter gentleman had travelled in India, and was conversant with the subject in question, asking if he could afford any information. In reply, he writes:—

"Replying to your correspondent who asks about maintaining an apiary at Karachi, India, I think my letter in the B.J. of May 17, 1900, gives the required information, and I have nothing to add to it except to say that I think your correspondent will find it less easy to keep bees at Karachi than in the Himalayas, but know of no reason why he should not succeed in keeping the local bee there by using a little care."

[Somewhat condensed, Mr. Sladen's letter in Vol. 28 reads as under.—EDS.]

"Colonies of European bees have been sent successfully to India on several occasions, but the conditions do not seem to favour them, and sooner or later they become weak, dwindle, and die. Failure has generally been attributed to the bees' inability to resist the attacks of various birds and insects which prey on them and reduce their numbers faster than they can be maintained by breeding, but probably faulty management has also had a good deal to do with it. The chances of success are greater in the hills than in the plains.

About fifteen years ago there was a great stir about bee-keeping in India, chiefly through the exertions of Mr. J. C. Douglas, of the Indian Telegraph Department, who unfortunately died without seeing his labours crowned with success. With considerable effort and expense Mr. Douglas introduced the Italian bee into India. His colonies did well for a time, and he was able with great pleasure to present to the wife of the Viceroy the first fruits of his work in the shape of a fine glass of honey in the comb. The bees bred with rapidity, but it appears that insect and other enemies carried them off at a greater rate, and so the colonies diminished in numbers. At this critical moment Mr. Douglas died. A few of the remaining stocks were sent to Darjeeling and other hill districts, but whether from an uncongenial climate or flora, or through enemies or diseases, or through neglect caused by ignorance of management, the

Italian bee soon disappeared from India, both in the hills and in the plains.

On the whole I should recommend your correspondent not to attempt to do anything with English bees in India, but to try the native bees and take out only the hives and such appliances as are best got in England. A large apiary of a good strain of native bees is kept at the jail, Darjeeling, where stocks and swarms could doubtless be purchased at moderate prices. In the hill country of the North-West Provinces they can be obtained from the natives, who keep them in rough hives in the walls of the houses. In other parts of India they may be found wild in the jungles, in cavities of trees, &c. The natives generally know where the nests are to be found. The only bee at present admitting of cultivation is *Apis mellifica*, variety *Indica*, various races of which occur in the hills and plains, and in Ceylon.

Articles that should be got in England are hives (in the flat), a good honey extractor, and various small appliances. In selecting appliances, it must be borne in mind that the Indian bees are smaller than ours. It would, therefore, be useless to take out brood foundation or queen-excluding zinc of the patterns used in England. Our ordinary brood foundation, if given to Indian bees, would be drawn out by them into comb for raising drones. Foundation of the correct pattern is obtainable from Gunesham Nath Mistry, Nushkarpore, Behalla Post Office, near Calcutta, if he still supplies it."

[3201.] *Improving Flavour of Honey.*—I have a large quantity of granulated honey from mixed sources that I cannot sell; consequently I intend getting the bees to work it into sections. And so I ask (1) could you give me any recipe to improve the flavour of it while feeding it to the bees? 2. Could you give a recipe to impart a heather flavour? I send name, &c., while signing—VERACITY, Co. Wexford, August 9.

REPLY.—1. Our correspondent has been somewhat singular in his choice of a *nom de plume*, but we have too much regard for "Veracity" to advise any "doctoring" of the honey in question, such as is suggested. We may, however, assure him that if he carries out the proposal to feed back the honey to bees in order to sell it as comb honey in sections, he will find it does not pay, and he will never try it a second time. 2. We hope, and believe, there is no recipe for imparting a heather flavour to honey other than taking the bees to "the hills where the purple heather grows," and this is a fact that few level-headed bee-keepers will regret.

[3202.] *Swarms Clustering Outside after Hiving.*—I shall be glad of your advice to the following queries through the medium of your paper. On July 29 a large swarm issued from one of my hives. I got the bees hived all right that afternoon, and was out of town from then till August 6. On my return I

found the bees underneath the floorboard clustering together in a chilled condition. I therefore returned them to the hive and gave them a little diluted honey lukewarm, but so far they have not started to take it. What I wish to know is—1. Can you suggest any cause for bees leaving hive and going under floorboard (I am certain the queen was inside hive at first)? 2. Do you think chilled condition of bees is the cause of their refusing syrup? 3. How should I act now in the circumstances?—INQUIRER, *Kilmarnock, Ayrshire, August 11.*

REPLY.—1. It is hardly worth while guessing at the cause of bees refusing without a chance of forming an opinion from inspection. There must have been something wrong with the hive or its fitting up, because bees do not do such things in practical hands. 2. Undoubtedly it would, seeing that chilled bees are about half-dead. They should have been warmed up to make them active, and then fed. 3. Once the bees take the food offered they will go on all right.

[3203.] *Swarming Vagaries.*—I was much puzzled the other day through the following:—I had a good swarm of bees, and a week afterwards I removed all queen-cells from the parent hives. About eight days later another swarm came out, and I got the bees into a skep and left them till the evening. Then I saw that the bees were leaving the skep and going back to the old hive. In a short time there were only a few left in the skep, so I let it alone thinking the stragglers would all go back. In about three days, however, I found there was a small piece of comb built and eggs laid in it, but there seemed to be no queen. I got Mr. Garner to come up from Altrincham and look at them, and he thought there was a fertile worker among them. If so, I am very glad to have got rid of her out of the hive; but I should be interested to know if this is likely, if you would be so kind as to tell me some time. I am almost certain I did not leave a queen-cell in that hive.—M. K. S., *Cheshire.*

REPLY.—The last-named swarm was a second swarm, and might easily have been accompanied by more than one queen, and the probability is that the few bees left in hiving skep would seem to have had a queen with them. It is not at all probable that the eggs found were laid by a fertile worker.

[3204.] *Transferring from Skeps to Frame-hives.*—Will you kindly advise a beginner under the following circumstances:—In April last I purchased three stocks in straw skeps, which I will call A, B, and C. I drove A and B, placing the bees, respectively, in bar-frame hives, and left the skeps full of comb (and at that time of brood) on the top of the bars, with queen-excluder beneath. I left skep C as it was, except that I put a super on the top. Having been away and ill, I was unable to inspect the hives until a few days

ago. In A I found three frames filled with bees and brood, and the comb in the skep only partially filled with honey. In B the same, except that four frames were in use. The bees in C have made no attempt to go into the super. The question is: What ought I to do now? It has not been favourable weather for the bees in these parts, as they lost the fruit bloom. I send name, &c., and sign myself "BEGINNER," Newark-on-Trent, August 14.

REPLY.—With regard to A and B you will need to take steps at once either to purchase half a dozen built-out frames of comb or else cut out the best of combs in skeps and tie them into frames, so that each frame-hive may have five or six frames of comb to winter on. Then feed up rapidly till sufficient food is stored in them for winter use. The skep "C" should have its super removed without delay, and be prepared for winter by feeding till it has 20 lb. or so of stores for wintering on. It is no use leaving supers on hives at this late season unless you have heather near.

#### WORKING WOMEN AND BEE-KEEPING.

The summer festival at the College for Working Women, Fitzroy-square, was held on July 9. The occasion served as a réunion of the students, and addresses on women's work in various fields were given, which were followed by a distribution of prizes, while last of all a number of nosegays of fresh flowers were handed to the members of the college. The Countess of Bective presided, and in her opening remarks said that any undertaking that had education for its object was worthy of support. To-day a woman realised that the interest of life would be increased by the enlargement of her point of view. Another point in favour of the college was the fact that it was for grown-up people, who could take advantage of it as their powers of appreciation were ripened. The college was doing its work in an admirable and hardworking manner. She urged on them the necessity of always studying, no matter how tired with the day's work. The increase of education among women was one of the most striking features of the day, and at the college also it was a free gift. She assured them of her sympathy with their work and of her admiration. Lady Susan Byng spoke on the subject of "Rural Occupations for Women," particularly in the direction of poultry-farming and bee-keeping, at the same time pointing out the advantages to be gained by emigrating to the Government farms in South Africa. Miss Sorabji gave a very charming address on "Women in India." The prizes were then distributed by Lady Bective, who was cordially thanked on the motion of the Rev. J. L. Davies, chairman of the council. A similar compliment was paid

to the teachers and workers on the motion of Miss Frances Martin, the hon. secretary, and acknowledged by Mr. Frank Morris. — *Morning Post*.

#### SELLING HONEY.

SOME EXCELLENT SUGGESTIONS TO THE BEGINNER.

Producing a lot of honey is but half the battle, and to many the easier half, while selling it to the best advantage is often far from easy. Salesmen are born, not made, but even if one is not born a salesman one may, by forethought, care, and perseverance succeed far beyond our expectations.

When I first began to produce more honey than could be consumed at home, I sold it to the neighbours. I just went about among them, and sold it as I had sold berries under a small boy. I knew them and they knew me; if they liked honey they bought. That was simple, but a little later, when I sought a city market, I found very different conditions. The merchants were prejudiced against "strained" honey. All sorts of mixtures had been dumped upon them, and their customers declined to be dosed any more. Each store visited only added to the seeming hopelessness of the case. At last I went to a grocer I knew well and got him to let me put in two dozen 1-lb. bottles, I agreeing to take them away if not sold, and giving him 25 per cent. commission on all he did sell. It was a heavy per cent., but the business was a small matter, and in a way a bother to him. He agreed to keep the honey in a conspicuous place and to recommend it to his customers.

Very slowly it went, but at last it was all gone, and I put in more. Then I tried another grocer on the same lay but on a smaller commission, and after several visits succeeded in getting them started. As soon as I had them secured I went to other grocers again, said "So and So" are handling my goods, &c., and finally got customers enough to take all I had to sell. I tried to estimate about how much each store would need, and reserve enough honey to supply them until the next crop. The honey was good, its sale increased, and I soon found I must buy if I was to hold my trade. So I bought, trying to get a flavour as near as possible to my honey. It was not like it, and I came near losing the whole trade. It took a lot of explaining and a lot of special labels telling the kind of honey, difference in flavours of honeys from different sources, &c. After that I took to blending honeys, and found it most satisfactory. The only trouble lay in putting together honeys of different specific gravity. I found it necessary to warm them almost to the limit of safety, stir them well, and then they would mix perfectly, otherwise the bottled "blends" looked streaked and there was trouble quick.

I well recall one suspicious grocer who

catered to the German trade—he was a German himself. The slightest sign of a streak meant war. I finally won his confidence and he became my largest customer. His trade preferred basswood honey, and most of them wanted it granulated hard. I had to sell to him at a low price, but he took large lots, large packages, and I never had to take back granulated honey. To-day, grocers of this city offer jars of granulated honey without hesitation or explanation. The public are educated to it.

The honey business was a "side line" with me, and soon called for more time than I could spare, so I sold it out, confining myself to producing honey for home use, selling any surplus to the man who bought my business.

To the beekeeper who is just commencing to sell honey I would say, sell only really fine honey, keep the flavour as uniform as possible by blending the different kinds, put the honey in neat packages and have them absolutely free from stickiness or dirt. Approach the customers in a frank, straightforward manner, and if you get "turned down," take it pleasantly and call again later. Patience and perseverance are prime essentials to a salesman.

—ARTHUR C. MILLER, *American Beekeeper*.

## Bee Shows to Come.

*A nominal charge of 2s. 6d. is made for notices in this column, which covers cost of insertion from order till date of show. Cash should accompany orders for insertion.*

**August 22, at Hawkshead, Lancashire.**—Honey show in connection with the Hawkshead Horticultural Society. Open classes for Six 1-lb. Sections and Six 1-lb. Jars (medium or dark) Extracted Honey. Prizes 10s., 6s., and 4s., and medals of the L.B.K.A. Schedules from Dr. Allen, Hawkshead, Lancs. **Entries closed.**

**August 22, at Barnton, near Northwich.**—Honey department of the Flower Show. Local classes for light and dark honey, sections, and beeswax. Class for twelve 1-lb. jars extracted honey open to county and members of the Cheshire B.K.A. First prize, silver medal of the C.B.K.A. and 15s. Schedules from Mr. S. Wade, Heathside, Barnton, Northwich. **Entries closed.**

**August 25, at Cartmel, Lancashire.**—Honey show in connection with the Cartmel Agricultural Society. Open classes for sections, extracted honey, and beeswax. Local classes for sections and extracted honey. Schedules from Wm. Cragg, Secretary, Cartmel, via Carnforth.—**Entries closed.**

**August 26, at Reading.**—Honey Show of the Berks B.K.A., in conjunction with the Annual Exhibition of the Reading Horticultural Society. Open classes for comb honey in sections and for extracted honey. Local classes include prizes of 20s., 15s., 10s., and 5s. for honey trophy. Also classes for owners of small apiaries. Schedules from D. W. Bishop-Ackerman, Hon. Sec. Berks B.K.A., 131, King's-road, Reading.

**August 27, at Llangollen.**—In connection with the fifth annual Flower Show. Open classes for Six 1-lb. Sections, Six 1-lb. Bottles Extracted Honey, and Beeswax. Schedules from Frank Little, Castle-street, Llangollen. **Entries closed.**

**August 27, at Montgomery,** in connection with Montgomery and District Horticultural Show. Open classes for Six 1-lb. Sections and Six 1-lb. Jars, Extracted Honey. Prizes in each class 10s., 5s.,

2s. 6d. Entrance-fee 1s. each. Schedules from W. J. Jones, Secretary, Montgomery. **Entries close August 20.**

**September 8, at Woodstock.**—Oxfordshire B.K.A. Honey show. Open classes (with free entry) for single 1-lb. section and single 1-lb. jar extracted honey. Prizes 7s. 6d., 5s., and 2s. 6d. in each class. Schedules from H. M. Turner, Hon. Sec., 4, Turl-street, Oxford.

**September 5 to 12, at the Agricultural Hall, London.**—Honey show in connection with the Confectioners', Bakers', and Allied Traders' (11th) Annual Exhibition and Market. Numerous classes and liberal prizes for comb and extracted honey and beeswax. **Open to all British Bee-keepers.** Special attention is directed to the new **Honey-selling Classes with Free Entry.** Schedules (now ready) from H. S. Rogers, Secretary, Exhibition Offices, Palmerston House, Old Broad-street, London, E.C. **Entries closed.**

**September 9 and 10, at Derby.**—Derbyshire B.K.A. Twenty-second Annual Show of Hives, Bees, and Honey on the show ground of the Derbyshire Agricultural Society. Schedules from R. H. Coltman, Hon. Sec. D.B.K.A., Station-street, Burton-on-Trent. **Entries close August 22.** Double fees to August 29.

**September 17, 18, and 19, at Crystal Palace, Surrey, B.K.A.** Annual Exhibition of Bees, Honey, Wax, and Appliances, &c. Twenty-four classes (ten open to all). Increased prizes and medals. Schedules from F. B. White, Secretary, Marden House, Redhill, Surrey. **Entries must be made before September 1.**

**September 19 to 26, at the Agricultural Hall, London.**—Honey Show in connection with the eleventh Annual Exhibition and Market of the Grocery and Kindred Trades. Numerous classes and liberal prizes for comb and extracted honey and beeswax. **Open to all British Bee-keepers.** Special attention is directed to the new **Honey-selling Classes with free entry.** Schedules from H. S. Rogers, Secretary, Exhibition Offices, Palmerston House, Old Broad-street, London, E.C.

**October 6 to 9, at the Agricultural Hall, London.**—Show of Honey and Bee-produce in connection with the British Dairy Farmers' Association. Numerous and liberal prizes for honey, &c., including the valuable Silver Challenge Cup of the B.B.K.A. Schedules from Mr. Wm. C. Young, Secretary, 12, Hanover-square, London, W.

## PRESS CUTTINGS.

### THEFT OF HONEY.

At the Police-court, Bedale, Yorks, a farm labourer, named Jno. Rushworth, was charged with stealing two crates, containing forty-two sections of honey, value 25s., belonging to Mr. Stephen Thackeray Jones, jun., from Winterfield, Hornby Park, between 9.30 p.m. on the 18th, and 11.30 a.m. on August 10. Mr. Jones said he saw his hives all right on Saturday, and on Sunday morning he found the tops had been removed, and two racks, containing forty-two sections of honey. He gave information to the police. The two crates of honey produced were his. Inspector Shields said he went to West Appleton, and after making enquiries, he suspected the prisoner. Charging him, he first denied it, and then afterwards he admitted it. After accompanying him two hundred yards, he showed him where the honey was hid under the rubbish in the hedge. Prisoner admitted to Mr. Jones that he had taken the honey. He was very sorry, but he was very drunk at the time. Wm. Smith, of West Appleton, gave evidence. Mr. Jas. Greaves, jun., stated that the defen-

dant had been in his employ for three years, and he had no occasion to find fault with him in any respect. He had had the whole charge of the stock, and he had never been guilty of any act of dishonesty, and he had been most painstaking in his work. He pleaded he had a wife and young family, and he hoped the Bench would deal with him under the First Offenders Act. The Chairman said that owing to his previous good character they dealt with the defendant under the First Offenders Act, and he would be bound in his own recognisances for six months.

#### BEES AND THEIR WAYS.

A curious place for swarming has been chosen by a hive of bees at Arcot Hall, near Newcastle, the seat of Mr. Howard Pease. The bees had swarmed up an apple tree, and the gardener, on going up a ladder to examine, was startled by observing a green linnet fly out of the middle of the swarm. Closer investigation revealed its nest with two eggs in, the queen bee having settled on the nest with her attendant hosts, the green linnet meanwhile calmly sitting on her eggs. With great care the gardener cut off the bough of the apple tree—swarm, nest, and all; and, after having smoked the bees off, he carefully stuck the bough up again. The linnet returned to her nest, and is now sitting on four eggs.—*Globe*.

#### BEE-CULTURE AS AN INDUSTRY IN FRANCE.

Fruit-culture and bee-culture have both been recommended to the distressed British agriculturist; and perhaps the advice has sometimes been supererogatory. It is permissible, however, the *Illustrated Scientific News* points out, to draw attention to the way in which the honey industry has advanced in France during the last few years. In ten years the output of honey has increased from 7,000,000 kilogrammes to 8,500,000 kilogrammes. The increase is due less to an increase in the number of hives than to the greater yield of each hive, which has now risen to about 500 grammes, or 11 lb. a hive. What is more gratifying (to the French producer) is that owing to the scientific methods of bee-farming the yield each year has become more constant and less affected by vicissitudes.—*Westminster Gazette*, June 9, 1903.

A novel sight at the Hayward's Heath (Sussex) market, a short time ago, was a swarm of bees which came over like a cloud in the afternoon, and settled on the wall at the Station Hotel, close to the base of the bracket of one of the large outstanding lamps in front of the building. A Mr. Ford essayed to take the swarm in a box, but they escaped from this receptacle and swarmed again on the wall, finding an orifice which led to beneath the floor of the sitting room in the hotel. In the evening Messrs. Sands, Small, and Jolly, took up a board or two of the floor, and secured about half a bushel of the bees.

Yesterday there was again a large number of them on the hotel wall, but not in the swarming mass which appeared on Tuesday. It was described as a very fine swarm indeed.—*Sussex Daily News*.

#### Notices to Correspondents & Inquirers.

*Letters or queries asking for addresses of manufacturers or correspondents, or where appliances can be purchased, or replies giving such information can only be inserted as advertisements. The space devoted to letters, queries, and replies is meant for the general good of bee-keepers, and not for advertisements. We wish our correspondents to bear in mind that, as it is necessary for us to go to press in advance of the date of issue, queries cannot always be replied to in the issue immediately following the receipt of their communications.*

\*.\* Referring to the case of foul brood mentioned in B.B.J. of July 30, by "A. M., Dudley," Mr. Joseph Price, 117, Haden Hill, Old Hill, Dudley, writes: "Being expert in the district mentioned, I should be pleased to assist your correspondent if he will send me his address, as I am always anxious to keep this neighbourhood as free from foul brood as possible."

*Royal Lancashire Show (a Correction).*—In the class for heather sections the prizes should have read as follows:—1st, W. Dixon, Becket-street, Leeds; 2nd, J. Waddell.

E. JACKSON (Cambs).—*Medicating Honey for Bee-Food.*—If the honey is diluted with warm water to the proper consistency, it may be dealt with precisely as syrup food in medicating with naphthol beta.

J. H. H. (Harborne).—*Comb-Building in Late Autumn.*—It is quite too late now to think of getting a box of shallow frames filled with comb for use next year in the stock you are feeding-up for winter.

FAITHFUL READER (Hayle).—*Honey Sample.*—Your sample is of good quality, and only needs clearing by slightly heating in warm water to make it fit for any table, or even for the show bench. It is, however, beginning to granulate.

MRS. BOSANQUET (Lewes).—The hon. secretary of the Kent & Sussex B.K.A. is Mr. H. W. Brice, 88, Brigstock-road, Thornton Heath.

F. J. M. (Bowbridge).—*Honey for Showing.*—Sample No. 1 is good in consistency, aroma, and flavour, though it is, perhaps, a shade dark for light honey class. No. 2 is inferior to No. 1 in both aroma and flavour, but is good in other respects. The samples appear to have been gathered from different sources.

#### *Suspected Comb.*

IN DOUBT (Banbury).—Comb is badly affected with foul brood.

\*.\* *Some Letters and Queries are unavoidably held over till next week.*



## Editorial, Notices, &c.

### A WORD IN SEASON.

The bee season of 1903, now rapidly drawing to a close, has been a disappointing one to all concerned. Full of promise at the outset, the end records the heaviest total rainfall of the past thirty years, and, in consequence, bee-keepers have good reasons for feeling a bit sore, because the inevitable result is a honey season of comparative failure. But it is equally certain that the interest in bee-craft has rather increased than diminished, and this is where our regret comes in, seeing that the honey shows of the year have perforce been, as a rule, badly supported, so far as entries, and where good displays on the show benches were hoped for, the entries in too many cases were less than the number of prizes offered for competition. This fact induces us to say a word with regard to the few important shows still "to come," in order to "wake up" the few fortunate ones who have secured the good honey of the year, and induce them to enter a dozen pounds of it, so that liberal money prizes may not literally go a-begging for winners. A glance over our "Shows to Come" column and show advertisements in this issue will explain all we desire to say, and will, we hope, introduce new prize winners at the shows in London and elsewhere next month. We therefore close with that useful adage *verb. sap.*

### DEVON BEE-KEEPERS' ASSOCIATION.

#### ANNUAL SHOW.

The sixth annual honey show of the D.B.K.A. was held at Tavistock on August 12, in conjunction with the show of the local Cottage Garden Association. Previous shows had been held at Exeter, but at the last general meeting it was decided that it would be to the advantage of bee-keeping to visit important towns in other parts of the county. Entries were very satisfactory, and the various displays were good both in appearance and quality, heather honey being well represented. Mr. S. Jordan, Bristol, acted as judge, and made the following awards:—

*Twelve 1-lb. Sections.*—1st, W. E. Brooking, Kingsbridge; 2nd, C. T. Wilson, Slapton; 3rd, J. Seldon, Umberleigh; v.h.c., Rev. T. Adey, Kingsbridge; h.c., W. C. Cavey, Launceston; c., H. Patey, Kingsbridge.

*Three Standard or Shallow Frames of Comb Honey for Extracting.*—1st, J. Seldon; 2nd, E. Warran, Tavistock; v.h.c., J. B. Houle, Chittlehampton.

*Single 1-lb. Section.*—1st, W. E. Brooking; 2nd, W. C. Cavey; 3rd, Rev. T. Adey; 4th, C. T. Wilson; v.h.c., J. Seldon; h.c., H. Patey; c., T. H. Short, Dunsford.

*Twelve 1-lb. Jars (light-coloured) Extracted Honey.*—1st, E. E. Scholefield, Chudleigh;

2nd, Mrs. H. H. Woosnam, Kingsbridge; 3rd, Miss S. Hole, North Tawton; v.h.c., C. Squire, Morteheo, Woodbury; h.c., J. M. Cann, Brixham; E. Warran, and J. B. Hole, Chittlehampton.

*Twelve 1-lb. Jars (medium-coloured) Extracted Honey.*—1st, C. Squire; 2nd, E. E. Scholefield; 3rd, E. Warran.

*Twelve 1-lb. Jars (dark-coloured) Extracted Honey.*—1st, E. E. Scholefield; 2nd, C. Squire; v.h.c., R. Furze, Woodbury; h.c., W. H. Piper, Sidmouth; c., J. Seldon.

*Six 1-lb. Jars Granulated Honey.*—1st, C. Squire; 2nd, H. Patey.

*Beeswax.*—1st, J. M. Cann; 2nd, E. E. Scholefield; h.c., C. Squire.

*Trophy of Honey.*—1st, W. J. Cavey; 2nd, J. Seldon.

*Frame Hive* made (of new or used material) by amateur, member D.B.K.A.; cost not to exceed 7s. 6d.).—1st, W. C. Stone, Wellington; v.h.c., W. H. Piper; h.c., F. W. Palmer, St. Budeaux, and W. C. Cavey.

Messrs. Burgess & Son, Exeter, showed a fine collection of hives and appliances, and were awarded a certificate of merit.

Mr. Jordan gave a practical lecture on bee-keeping in the Town Hall, which was much appreciated.—(Communicated.)

### SHROPSHIRE B.K.A.

#### ANNUAL SHOW.

The above show was held on August 19 and 20, in connection with the Shrewsbury Horticultural Society's great floral fête in The Quarry, Shrewsbury. It was the finest exhibition of flowers, plants, fruit, &c., ever seen at Shrewsbury, or, probably, at any similar show in the kingdom, the total entries exceeding those of last year by 300. On the opening day the weather was beautifully fine, but the rain, which fell pitilessly on the second day, converted the ground into a quagmire, and, of course, considerably lessened the attendance.

The honey show was very successful, considering the adverse season, some splendid samples of both comb and extracted honey being staged. As will be seen by the prize-list, local exhibitors were able to hold a good position against all comers. A pretty collection of bee flowers was shown by Mr. J. Bradley, not for competition. The arrangements of the show were carried out by Miss M. E. Eyton, Hon. Treasurer; Mr. S. Cartwright, Hon. Secretary; and a committee, of which Mr. Roff King was chairman.

The Rev. E. Charley, Ince, with Messrs. F. H. Taylor, Chorley, and J. Thomas, Hereford, officiated as judges of the Honey Section, and made the following awards:—

#### OPEN CLASSES.

*Twenty-four 1-lb. Sections.*—1st, S. Cartwright, Shawbury, Shrewsbury; 2nd, J. Clay, Wellington, Salop; h.c., A. Hamer, Llandilo.

*Twelve 1-lb. Sections.*—1st, R. S. Marshall, Woore, Salop; 2nd, W. Ratcliffe, Barthomley, Crewe; 3rd, J. Carver, Wellington.

*Twelve 1-lb. Sections (other than 4½ in. by 4¼ in.).*—1st, J. Clay; 2nd, S. Cartwright; h.c., J. Carver.

*Twenty-four 1-lb. Jars Extracted Honey.*—1st, S. Cartwright; 2nd, J. Clay.

*Twelve 1-lb. Jars Extracted Honey.*—1st, W. Patchett, Caborne, Lincs; 2nd, J. Carver; 3rd, W. Woodley, Beedon, Newbury; J. Griffiths, Alvanley; A. G. Preen, Newcliffe; v.h.c., A. Hamer; h.c., C. A. Miller, Audlem.

*Twelve 1-lb. Jars (medium-coloured) Extracted Honey.*—1st, J. Carver; 2nd, J. W. Whitehurst, Shrewsbury; h.c., A. G. Preen, and G. M. Tune, Llangollen.

*Single 1-lb. Jar Extracted Honey.*—1st, W. Patchett; 2nd, S. Cartwright; 3rd, J. Carver.

## MEMBERS' CLASSES.

*Twenty-four 1-lb. Sections.*—1st, J. Carver; 2nd, R. S. Marshall; h.c., J. Clay.

*Twelve 1-lb. Sections.*—1st, J. Carver; 2nd, R. S. Marshall; h.c., J. Clay.

*Twenty-four 1-lb. Jars Extracted Honey.*—1st, S. Cartwright; 2nd, J. Clay; v.h.c., J. Carver.

*Twelve 1-lb. Jars Extracted Honey.*—1st, J. Carver; 2nd, J. Clay; 3rd, A. G. Preen.

*Twenty-four 1-lb. Jars (dark-coloured) Extracted Honey.*—1st, F. W. Norris, Cardington; 2nd, P. Jones, Church Stretton.

## ARTISAN MEMBERS' CLASSES.

*Twelve 1-lb. Sections.*—1st, J. Churton, Wollerton; 2nd, E. Brookfield, Myddle.

*Twelve 1-lb. Jars Extracted Honey.*—1st, L. Powell, Cold Halton; 2nd, J. Churton; h.c., E. Brookfield.

*Six 1-lb. Jars Extracted Honey.*—1st, E. Brookfield; 2nd, L. Powell.

## COTTAGER MEMBERS' CLASSES.

*Six 1-lb. Sections.*—1st, T. Croxton, Hope Bowdler; 2nd, J. Jones, Church Stretton; 3rd, T. Hailshorne, Broseley.

*Single 1-lb. Section.*—1st, F. Croxton; 2nd, Mrs. Powell, Cold Halton; 3rd, J. Jones; h.c., F. Hartshorne.

*Three 1-lb. Sections and Three 1-lb. Jars Extracted Honey (Mr. Roff King's prizes).*—1st, Mrs. Powell; 2nd, J. Jones; h.c., F. Croxton.

*Twelve 1-lb. Jars Extracted Honey.*—1st, Mrs. Powell; 2nd, G. Butter, Blow Heath; 3rd, J. Bright, Cardington.

*Six 1-lb. Jars Extracted Honey.*—1st, Mrs. Powell; 2nd, J. Stanton, Basford; 3rd, J. Bright; h.c., F. Croxton.

*Single 1-lb. Jar Extracted Honey.*—1st, Mrs. Powell; 2nd, J. Bright; 3rd, T. Croxton.

*Single 1-lb. Jar Extracted Honey (Mr. A. G. Preece's prizes).*—1st, Mrs. Powell; 2nd, J. Bright.

## OPEN CLASSES.

*Honey Trophy.*—1st, W. H. Brown, Shrewsbury; 2nd, A. Hamer; 3rd, J. Bradley, Yockleton.

*Complete Frame Hive.*—1st, E. H. Taylor, Welwyn, Herts; 2nd, W. P. Meadows, Syston.

*Collection of Bee Appliances.*—1st, E. H. Taylor; 2nd, W. P. Meadows.

*Honey Beverage.*—1st, J. Bradley.

*Beeswax (Salop only).*—1st, A. G. Preen; 2nd, J. Cawer.

*Honey Vinegar.*—1st, W. H. Brown.—(Communicated.)

## YEovil AND DISTRICT B.K.A.

The Yeovil and District Bee-keepers' Association held their annual show at the Penn Hill Grounds, Yeovil, on Thursday, July 30, in conjunction with the annual garden fête.

A good number of people made a point of visiting the honey show, which comprised nine classes, two of which were open to all. Owing to the adverse bee season the quality of the honey in local classes was not up to the usual standard. There was a small entry for beeswax, but the quality was excellent. The display of bee appliances was very good indeed, including an observatory hive showing the bees at work. The show arrangements were ably carried out by the Hon. Secretaries, Messrs. Everton Watts and G. W. Perry.

Mr. F. Chapman, Andover, judged the exhibits and made the following awards:—

*Standard Frame of Comb Honey.*—1st (and special prize of 7s. 6d.), D. Hullet, West Coher; 2nd, G. W. Perry, Yeovil.

*Six 1-lb. Sections.*—1st (and special prize of 7s. 6d.), Everton Watts, Yeovil; 2nd, G. W. Perry; 3rd, D. Mitchel, East Coher.

*Bell Glass (over 10 lb.).*—2nd, G. Richards, Sutton Bingham; 3rd, W. A. Pavitt, Barwick. (No 1st awarded.)

*Bell Glass (under 10 lb.).*—2nd, W. A. Pavitt. (No 1st awarded.)

*Six 1-lb. Jars Extracted Honey.*—1st (and special prize of 10s. 6d.), F. Axe, Closworth; 2nd, S. Dicks, Yeovil; 3rd, G. H. Cook.

*Super of Honey.*—2nd, G. Richards, Sutton Bingham. (No 1st awarded.)

*Beeswax.*—1st, G. Richards; 2nd, F. Axe.

*Single 1-lb. Section (open).*—1st, J. Trebble, Romansleigh, South Molton; 2nd, A. V. Trebble, Romansleigh, South Molton; 3rd, R. Addison, North Petherton.

*Single 1-lb. Jar Extracted Honey (open).*—1st, F. Trott, Sotnell Leigh, Sherborne; 2nd, P. B. Govett, Tideford, Cornwall; 3rd, F. Power, Andover.—(Communicated.)

## LANCASHIRE B.K.A.

## HONEY SHOW AT CHORLEY.

This show was held on Saturday, August 15, in St. George's Park, Chorley, in connection with the Chorley Agricultural Society's annual show. Being the first honey show held in the district the entries were not numerous, but some exceedingly good exhibits were staged, including the prize lots from both classes at

the Royal Show at Manchester. It is hoped that this first effort will encourage bee-keeping and add to the membership of the Association.

Mr. F. H. Taylor, expert B.B.K.A., officiated as judge of honey, and had the weather been favourable should have given two lectures on bee-keeping, but owing to heavy rain at the time the bee demonstration had to be given up. The awards were as follow:—

*Six 1-lb. Sections.*—1st, R. Rymer, Hesketh Bank; 2nd, J. Jones, Carnforth.

*Six 1-lb. Jars Extracted Honey.*—1st (and silver medal L.B.K.A.), H. Fenny, St. Helens; 2nd (and bronze medal L.B.K.A.), J. Johnson, Southport; 3rd, R. Rymer, Hesketh Bank; reserve, F. Sharples, Rainhill; v.h.c., J. H. Walmsley, Bretherton; h.c., J. Dickinson, Adlington, and — Partington, St. Anne's-on-Sea.—(Communicated.)

## WILTS BEE-KEEPERS' ASSOCIATION.

### HONEY SHOW AT SWINDON.

For some years past the low state of the funds prevented a "County Show" being held; this year, however, a liberal grant from the Swindon Horticultural Society, supplemented by donations (to the amount of £5) from friends of the Association, made it possible, and a successful honey show was held in the Great Western Park on August 19, when prizes to the amount of £8 were offered. The day being fine, a large number visited the tent, and a considerable amount of honey was sold. Owing to the unfavourable season the amount of honey staged was less than usual, but the quality was remarkably good. The judge was, as usual, appointed by the B.B.K.A.

Mr. W. D. Bishop-Ackerman, Hon. Secretary, Berks B.K.A., officiated as judge, and made the following awards:—

*Honey Trophy* (members only).—1st, S. W. Filtness; 2nd, E. C. R. White, Newton Toney; 3rd, W. E. Burkitt, Buttermere.

*Twelve 1-lb. Sections.*—1st, E. C. R. White; 2nd, W. G. Kight, Chisledon.

*Twelve 1-lb. Jars Extracted Honey.*—1st, E. C. R. White; 2nd, W. E. Burkitt; 3rd, S. W. Filtness.

*Six 1-lb. Sections.*—1st, E. Giles, Little Hinton; 2nd, E. C. R. White; 3rd, W. E. Burkitt.

*Six 1-lb. Jars Extracted Honey.*—1st, W. G. Kight; 2nd, G. Newport, Oxenwood; 3rd, W. E. Burkitt.

*Two Shallow Frames of Honey.*—1st, E. C. R. White; 2nd, S. W. Filtness; 3rd, Miss Hatch, Salisbury.

*Beeswax.*—1st, E. C. R. White; 2nd, S. W. Filtness; 3rd, E. Gibbs, Little Hinton.

### COTTAGERS ONLY.

*Four 1-lb. Sections.*—3rd, G. Newport. (No 1st or 2nd awarded.)

*Four 1-lb. Jars Extracted Honey.*—1st, G. Newport; 2nd, G. W. Smith, Rodbourne.

### OPEN CLASSES.

*Twelve 1-lb. Sections.*—1st, E. C. R. White.  
*Twelve 1-lb. Jars Extracted Honey.*—1st, E. C. R. White; 2nd, S. W. Filtness; 3rd, R. Spring, Stratton.

*Six 1-lb. Jars Granulated Honey.*—1st, W. G. Kight; 2nd, S. W. Filtness; 3rd, E. C. R. White.

*Single 1-lb. Section.*—1st, E. C. R. White; 2nd, M. Norris, Bradford-on-Avon; 3rd, G. Newport.

*Single 1-lb. Jar Extracted Honey.*—1st, W. Cook, Market Rasen; 2nd, E. C. R. White; 3rd, W. G. Kight.—W. E. Burkitt, Hon. Sec., Wilts B.K.A.

## Correspondence.

*The Editors do not hold themselves responsible for the opinions expressed by correspondents. No notice will be taken of anonymous communications, and correspondents are requested to write on one side of the paper only and give their real names and addresses, not necessarily for publication, but as a guarantee of good faith. Illustrations should be drawn on separate pieces of paper. We do not undertake to return rejected communications.*

*Communications relating to the literary department, reports of Associations, Shows, Meetings, Echoes, Queries, Books for Review, &c., must be addressed only to "The Editors of the British Bee Journal," 17, King William-street, Strand, London, W.C." All business communications relating to advertisements, &c., must be addressed to "THE MANAGER, 'British Bee Journal' Office, 17, King William-street, Strand, London, W.C."*

*\*.\* In order to facilitate reference, Correspondents, when speaking of any letter or query previously inserted, will oblige by mentioning the number of the letter as well as the page on which it appears.*

## AMONG THE BEES.

### ON THE HILLSIDE.

[5214.] I have climbed the lower slopes, all one exquisite sheet of purple bloom, and may now be at an altitude of nearly 3,000 ft. above sea level. Trees, shrubs, and vegetation of all kinds have been left below, until only this single plant, glorious in its profusion, and fair in its loveliness, is left to grace and adorn the rough, rugged, and weather-worn sides of what seems an endless succession of peak on peak, culminating far away in the hazy distance. In some of Scotia's giant Bens towering crag, and black tarn, and cleft chasm, may intervene, but distance dims them so that away far as the eye can reach one grand sea of almost illimitable bloom adorns each succession of heights, and dresses them up in a mantle fair as Nature even in her bounty and profusion ever decked the fairest landscape. Here I lie on this heather bed, as some song writer has described it, "Sae cosy and sae canty," drinking in with all my heart and soul the exquisite beauty and unmatched grandeur of the noble surroundings. Far from the madding crowd I am alone with Nature, and can thoroughly indulge in the luxury of doing nothing, or at least lie enjoying a dreamy repose. The magic eerie silence of the ever-

lasting hills is everywhere around me. We have it differing in degree and what I may call intensity. There is the solitary grandeur of some out of the way recess, deep among the rocky precipices, where Nature itself seems asleep at times. And there is the solemn silence by deep dark tarn, or in the quiet retired green corrie, where man hardly ever wanders, and where bird and beast are rarely seen or heard. These two must be experienced to be fully understood or appreciated. Lower down here on the open hill-side there is a gentle hush of calm. A kind of Sabbath Day's peace prevails; but the absolute silence is left behind, for here the listening ear can distinguish a concord of sweet sounds. Soft, harmonious melody pervades the air, for many insects sail through the atmosphere on diaphanous wings, breaking the absolute stillness with their soothing hum. The beetle wheels his lazy, monotonous, "droning flight"; the hum of the humble bee emits a dull and slumbrous sound; large flies pipe a sharp, shrill interlude; while smaller insects of all kinds hum a melody in all degrees of varied perfection. No rest or stay for any of them, for the busy, restless lot of man is theirs, and they, too, have to work to live. The soothed ear accepts all these sounds, blended harmoniously, as a part of the stillness. Nor are these sounds the only ones heard, for the listening ear detects first one and then another. The rippling breezes and the trickling of water rather soothe than disturb the almost slumbering sense, for the cadence is soft, sweet, and tuneful, blending with the ethereal calm, and seeming a part of it.

The larger stream goes dancing down tossing over rocks and stones, its waters sparkling in tiny wavelets like so many gems of purest crystal; joined in its tortuous or mazy windings by the tiny brooks or trickling rills which meet it, each curling along singing a sweet and murmurous medley or chanting a soft and slumbrous song, its soft cadence lulling the listening ear like a melodious melody. Scarcely perceptible, a sighing, gentle breeze, starts up as an accompaniment, and its sweet symphony accords in sweet harmony, blending with and becoming a part of the other sounds. At times it sighs along, then sobs gently through the waving heather or rustling rushes, and then as suddenly sinks into an eerie moan or a gentle sigh. Then, as an almost imperceptible zephyr, it floats along so gentle in its movement as to be definitely discernible only by the sweet scent of flowers which it wafts along on its odorous breath, though their perfume is faint from the distance it has floated, and because their finer and more delicate scent is almost overpowered by the very pronounced, because wider diffused fragrance from the sea of heather spread all around. Often it is very silent on the mountains. A great hush of calm seems to prevail as we lie on our heather bed admiring

the very fine striae with which the sky overhead is marked. What an exquisite, if evanescent, reflection they display! Waving shadows flit and pass from the darker clouds, chequering the hill-side with an ever-shifting panorama. The light and shade seem to chase each other over the purple slopes, with occasional dark splashes of heavy gloom almost blackening the luxuriant sea of bloom. Nothing lasts, each scene floating away almost instantaneously. They convey a lesson to us, for do not our hours and days pass away in a moment like the cloud-made shadows on the heath, leaving often as little of permanent good behind.

Lower down the joyful hum of the hive-bee is everywhere in evidence, as they on this day of bright sunshine revel in the glory and luxury of those millions of fair florets, each with its tiny drop of sweet nectar, which it is willing to bestow for the asking. How many thousands of visits must be paid to garner one single pound of honey? Yet the bees, in that indefatigable spirit of busy industry which is so admirable a trait in their character, ply their task with such assiduity that it mounts up to, it may be, 100 lb. or more for each colony. To-day the glad sound of their coming and going delights the bee-man's ear as few melodies can. And he feels an intense pleasure, which is added to and intensified by the sweet breath of the balmy air, the beauty and profusion of nature's floral bounty, the happy enjoyment of animate creation revelling in the sun's bright beams, and the happy concord of all his surroundings.—D. M. M., *Banff, N.B.*

#### FORMALDEHYDE V. FOUL BROOD.

[5215.] Referring to the letter of Mr. Geo. M. Saunders (5212, page 336), I fail to see (if the colony on which he experimented was not queenless) why the bees refused the combs after fumigating with formaline. I have practised fumigating both hives and combs with formaline and, so far, have had no difficulty in getting the bees to accept combs so fumigated.

My method of working is as follows:—I have an air-tight fuming-box which will take one hive with combs, &c.; in this I place hives or combs or both as the case may be and fumigate with one teaspoonful of formaline mixed with two of water placed in a metal dish and evaporated to dryness with methylated spirits. I keep the box closed for at least four hours, then take out the combs or hive and expose to the air for at least twelve hours (in sunlight if possible) before again using. This airing is, perhaps, what Mr. Saunders failed to observe, consequently the bees refused to take to the combs. I have found that bees will not take to combs that have been subjected to the fumes of salicylic acid, unless the combs have been exposed to the air for many days, in order that all the

crystals may be evaporated. If Mr. Saunders will air combs on next attempt, he will be successful. Personally I prefer the liquid formaline to the tablets, it is more easily used and requires no special lamp to evaporate it; any fumigating lamp will do for the liquid, but it *must* be evaporated to dryness.

If there is anything more Mr. Saunders would like to know as to the uses of formaline in bee-keeping I shall be pleased to answer any of his questions.—BLACKWOOD, *County Durham*.

## PREVENTING SWARMING.

### IS IT DESIRABLE?

[5216.] For several years past I have been a follower of the non-swarming cult, and when I tell you that in 1902, from my twenty-seven hives, only one swarm issued, you will say that I was fairly successful, but so heavy has been my trouble with "spring dwindling," that I have begun to ask myself if the game is worth the candle? It seems to me that in thwarting Nature—because that is what preventing swarming really is—she makes us pay the penalty in some other direction. Anyway, this is the conclusion I have arrived at from careful observations, and find that a stock which has not swarmed for, say, three years gets lifeless, loses its energy and inclination for work. This must be known to all bee-keepers, as well as the fact that no bees, not even our very best stocks, work with the same energy and *vim* that a newly-hived swarm does. I should be interested to know if other readers of the B.B.J. have had a similar experience?—WM. CASTLE, *Ampleforth, Aug. 19*.

## HONEY JUDGING.

### COLOUR GRADING.

[5217.] I know from personal experience that it is sometimes a very difficult matter to decide which exhibit is to take 1st prize when the competition is exceptionally keen, but in going round the honey-tent at Shrewsbury Show on August 20, I was puzzled with the 3rd prize award, in the class for medium-coloured honey. The prize in question went to an exhibit of honey much below the darkest shade allowed for that of "medium colour," while another exhibitor got a high commend for a sample of the lightest shade of "medium" (according to the official glasses), and yet a good sample of honey, the colour of which was just between the two, was ignored altogether. This led me to wonder if the judge had not yet procured the coloured glasses sent out by the B.B.K.A. for grading the different shades of colour in the extracted honey classes? Having been connected with bees and honey from a boy, and made a study of it, besides having acted as a judge for seven years successively at our shows, the awards which I have referred to were unaccountable, if the judge

had no knowledge of the honey or of ownership. Let us judge the honey on its merits, and award the prizes accordingly. I apologise for this long letter, but I could not let so glaring an error pass by without calling attention to it.—J. S. LAWTON, *Bridgnorth*.

[We have, for obvious reasons, omitted names and addresses from the above communication, and, without knowing anything whatever of the subject commented on, beyond what appears in print, we would simply remind our correspondent that the correct grading of colour in classes for extracted honey is only one point among many which a judge has to consider. In other words, the *colour* of an exhibit may be perfect, but the flavour, &c., so inferior as to put the sample out of the competition altogether. It is therefore only fair to suppose that the fuller opportunity a judge has of testing the sample than any onlooker is supposed to possess will afford the explanation desired and account for the awards.—EDS.]

## SWARMING VAGARIES.

[5218.] Referring to Query 3203 (page 337) on "Swarming Vagaries," in which my name occurs, I think I ought to further explain the matter. When I was called up I found that the second swarm in skep after being left out in the garden a day or two had been removed from its stand and carried into an adjoining field; and, on turning skep over, I found there was only about two handfuls of bees left in; with a small piece of comb about the size of the palm of my hand. This comb was all drone-cells with about a score of eggs in but I could find no queen at all, and therefore, took the bees and gave them a frame of brood and eggs from which they raised a queen. I am sure the eggs first seen were laid by a fertile worker.—G. H. GARNER (Expert, B.B.K.A.), Local Sec., C.B.K.A., *Altrincham*.

## VAGARIES OF SWARMS.

[5219.] While on a recent visit to a bee-keeping friend, and standing by the side of his hives, a swarm unexpectedly issued, and settled in a currant bush close by. While preparing a hive for them—which took about one hour—we found the swarm had taken wing and disappeared. Feeling almost sure the bees had gone back to the parent hive, I was determined to find out, and on examining the frames soon found the old queen. I also saw a queen-cell uncapped, and a young queen in it with her wings stuck fast to the side of cells. The examination revealed the fact that the hive was badly affected with foul brood, and we wanted to put the swarm into a straw skep for two days before being housed in a frame-hive. I should like to know by what instinct the old queen with swarm was

induced to return to the old hive? It makes one wonder if bees have a language by means of which to express their views of what is best for them. Thinking this might interest others, I send it on, and sign myself—*EXCELSIOR, Cheshire, August 22.*

### WOMEN'S DRESS FOR BEE-WORK.

I am not used to writing for publication, and it has seemed quite a task. I fear you will feel like I do myself, and will dump this in the waste-basket. However, I shall make the effort.

I think the Sisters department fine, and enjoy the contributions, particularly the *dressy* ones.

Lake Winnebago is less than a mile from us, and we have a fine view of it from the porch. There are about 1,200 apple, cherry, and plum trees in the orchards, and my bees have an ideal home, as well as myself. I have thirty-six colonies. I moved thirty-nine colonies fourteen miles last December, and put them into the cellar without a flight, or even taking the screens off the top of the hives, and so many of them came out and died on the cellar floor that I told my family I would be glad to find half a dozen alive in the spring; but they all lived through. I found a great many broken combs, and have had a great deal of work mending them, and clipping queens' wings.

I number my hives with a crayon, and keep a book with a short record of the condition of each colony, and then I have some idea which ones need looking after first. They are all strong, but none of them have swarmed, nor do I want them to do so. Several are, or have been, at work in the supers, and I have taken off a few nicely sealed sections of dandelion honey, but the last two days we have had a cold north-east wind, and to-night it feels as if we might have snow.

I have kept a few bees twenty years. We found our first colony clustered on an oak tree. For a few years we thought we did well if we got honey enough for our own use. The men did not care for the bees as I thought they ought to, and for the past fifteen years I have taken all care of them. I only have to have them carried into and out of the cellar.

I buy my hives in the flat and nail them myself. I find that if I care for thirty colonies I have enough to keep me busy. Last year I had twenty-three colonies, spring count, and increased to forty-one. I had nearly 3,000 sections of very nice honey and found two colonies had been robbed, and the worms had eaten the combs. I doubled up some of the weakest. Just as the blossoms were opening I carried the weakest colony, after catching their queen, and put them above the one I wished to unite them with, with a piece of

strong paper between in which I had punched a hole large enough for one bee at a time to pass through at night, and in the morning I saw they were carrying out dead ones and having a general war. I used a spray on both hives, using sweetened water with violet perfume, and mixed them all up, putting the frames that had no brood in the upper hive, and I have had no more trouble since then. I have united two more without the loss of a bee, so far as I could see.

I wear a sailor-hat, with black lace stitched fast to the brim, and let it fall loose on my shoulders. If a bee gets in I just raise my veil and let it out. I like an extra hat-pin to pin my veil down in front if I am bending over a hive, and find it handy to pick out a worm if I should happen to see one.

I use a pair of asbestos gloves, such as fire-men and engineers use. They do not get scorched on the smoker, and if I get them covered with honey, as I often do when cutting out drone-comb, I take a cloth and wash them off, and they are as soft as ever after they are dry. I clip off the ends of the fingers and thumbs. I like a clean, well-starched cotton-dress, or, if cool, a shirt-waist and heavy skirt.

When cutting out drone-comb I crush all empty-waste comb in my hand into a ball and throw it into a basket or bag with the scrapings and all waste, and after the season is over I take a day and melt it out in the oven. If I have pieces with brood in them I throw them out to the chickens; they are so fond of it, and they will come around the hives waiting for it while I am at work, until the bees get after them, when they soon forget what they were after.

Now, if this finds the way into the waste-basket I shall not be surprised, as I do not think I have given any new ideas, for I think I have seen it all in the *American Bee Journal*; but I should be delighted to give you a chance to become better acquainted with me, if you should ever come to this vicinity—right here at "The Orchards."—*ELIZABETH M. SMITH, Winnebago Co., Wis. (American Bee Journal).*

## Queries and Replies.

[3205.] *Grading Honey at Shows.*—I write to ask if there is any rule under which the coloured glasses sent out by the British Beekeepers' Association for grading honey must be used by judges at local shows. The reason of my asking is:—At the last Cardiff show in the class for light honey the exhibit that took 1st prize was a shade darker than water, and in the dark honey class the sample that got first place was a shade lighter than black ink!—*AN EXHIBITOR, South Wales.*

REPLY.—The coloured glasses referred to are, we believe, used by all judges who are

informed that honey of different colours have classes for each kind. At the same time it should cause no surprise that the judges gave first honours to a sample "a shade darker than water," if the sample was best on other points. Our own choice of colour is pale golden, but to be still lighter than that is no appreciable fault if good on other points. No doubt the same rule influenced the judges in the dark honey class, because the flavour, &c., was best; they bore in mind the fact that it was dark honey they were judging.

[3206.] *Loss of Queen in August.*—I shall esteem your valuable advice on the following case:—Having foul brood in one of my hives, I brushed all the bees off frames into a box, and kept them confined therein for forty-eight hours, burning all frames of brood, &c. I then put six new frames with foundation in, and returned bees to the clean hive, feeding them on medicated syrup. The bees are very strong, but yesterday I noticed robbing and fighting going on, and found the enclosed bee (dead) outside the hive. I take it to be the queen. To-day being fine and warm, I examined the hive, and, as expected, saw no queen. I therefore ask:—Has the queen sent died from accident or otherwise, and should I at once procure another?—F. LASHBROOK, *Andover, August 22.*

REPLY.—Bee sent is an adult queen, and evidently the mother-bee of the hive. She may have been damaged during the operation of getting the bees off combs, or it may be that the bees have "balled" her for some reason. In any case, you had better procure a young queen and introduce her without delay.

[3207.] *A Lady Beginner's Queries.*—I should be so glad of a little assistance from you on the following:—I had two swarms of bees given to me this spring; the first lot swarmed on June 12, the others on the 24th. I put them in my garden, where they have apparently been working very well. Both swarms are hived in straw skeps. Being anxious to manage them properly, I ask: 1. What must I do when, a little later, they will cease working? Will they want feeding? 2. Can I take any honey from the hives this autumn? 3. How can I ascertain if the bees are healthy and quite free from foul brood, &c., of which I hear so much? 4. What is meant by the "honey-flow?" These are the first bees I have had anything to do with, and you will no doubt see by my questions that I am totally unacquainted with them. I send name and full address, while signing—(Mrs.) MAY-BEE, *Gillingham, Dorset, August 18.*

REPLY.—1. The question of feeding must be ruled by the weight of food now in the hives. Each skep should weigh not less than 25 lb. gross to be safe for winter, and if less heavy must be made that weight by feeding. 2. We should say no. 3. A beginner has a poor chance of deciding as to healthiness, or

otherwise, when bees are in straw skeps. 4. The time of honey-flow means when honey is plentiful in the fields. We add a line to say you should do two things in the coming winter in order to be successful with bees:—First, procure and carefully peruse a good text-book on bee-keeping, without which success is next to impossible; secondly, prepare for having the bees transferred from their skeps into movable frame-hives.

[3208.] *Building up Stocks from Driven Bees.*—I am having sent me several lots of driven bees, about September 10, and have not sufficient drawn-out combs in Standard frames to put them on. I also fear that the season will be too far advanced to expect the bees to draw out foundation and to store syrup before the cold weather comes. I therefore ask: 1. Do you advise me to put sufficient shallow-frames in the body-box, leaving the space between the bottom of these and the floor open? or 2. Should I put a box of shallow-frames on the top of brood-nest, and let the bees winter on these? There will then be the whole space of the brood-nest empty, which might cause the cold air to collect and keep down the temperature. I have plenty of drawn-out shallow-frames. Your advice on the subject will be esteemed and acted upon. I send name, &c., and sign myself—YEOMAN, *Wellington, August 22.*

REPLY.—1. You might winter the driven bees on drawn-out shallow-combs, as proposed, and in early spring, or when the shallow-frames in box are well covered with bees, raise the latter and substitute a body-box of Standard frames (fitted with full sheets of foundation), and put the shallow-frames above. The bees will then transfer their brood-nest below, and the shallow-frames may remain as a surplus-chamber for extracting later on. 2. It would have the effect of cooling the brood-nest to have so large a vacuum below.

[3209.] *Dead Brood in Combs.*—I shall be glad if you can tell me in the next issue of the B.B.J. what has caused the death of the larvae in the enclosed piece of comb. The hive from which it was taken has seven or eight strong seams of bees and plenty of food, so it cannot be that the brood is chilled. Dead and shrunken larvae occur on several combs, in the middle as much as on the outside, and a young queen was dead in a queen-cell. A newly mated queen which had just filled the hive with brood disappeared about three weeks ago, and the young queen I speak of was raised in her place. There were several queen-cells; and I found a normal healthy virgin queen outside the hive a week ago, and there is plenty of healthy brood hatching out, so it is only a part of the brood that is so affected, and all of it either capped or ready for capping. The bees have carried a few larvae out. There is no sign of foul brood. Is it possible that the newly mated queen died of this disease? The bees themselves

seem healthy and vigorous.—S. K. S., *Birmingham*.

REPLY.—1. The very small bit of comb sent affords little assistance in diagnosing the case put before us. Some of the few cells contain the dried-up remains of brood, but it is impossible to guess the cause of death. If the stock is strong and doing well, with plenty of brood hatching, the best course is to keep a watch on it and hope for the best.

[3210.] *Poultry versus Bees*.—I must thank you for answering my numerous questions, and I hope I am not troubling you too much in again asking for help in the following:—A few days ago I noticed one of my little ducks in great distress, and behaving strangely. On catching it and examining it, on opening its beak, about a quarter of an inch within the upper lip, I found a bee-sting. I removed the sting with a pair of forceps, and after seeming dull and listless for an hour or two, it was all right again. In snapping up that bee the duck evidently caught a tartar. I keep turkeys, fowls, geese, and ducks, and will be glad to know:—1. What poultry are enemies to bees? 2. I want to move my hive of bees a distance of about a hundred yards. Please tell me the best time to do it, and what precautions to take?—MEL ROSÆ, *Yarmouth, Isle of Wight*.

REPLY.—1. We are not aware that poultry of any kind are regarded as enemies of bees. 2. The best time will be after the bees have been confined to the hive for several weeks through cold weather.

[3211.] *Transferring Bees and Combs from Skeps to Frame-hives*.—I have three modern hives with frames fitted with full sheets of foundation. I have also some stocks in skeps and want to drive the bees from latter and put them in frame-hives. In fact, I have already driven two lots and united them in one of the hives. I cut out the combs that contained brood and tied them in two frames, adding six more frames with full sheets of foundation. Will you therefore please tell me if the bees will build out enough combs to contain a full supply of stores for the winter if fed liberally? I could no doubt manage to get enough brood-combs from the other skeps to fill three frames in each of the other hives, and by uniting two driven lots and picking out the best brood-combs of two skeps I could stock each of the frame-hives nicely. I asked for some naphthol beta to-day at our local chemist's, but he had none in stock, and said naphthaline answered the same purpose for bees. He then mixed some naphthaline for me just as we are told to do with naphthol beta, but being uncertain about this, will you say if I can use it? I am a regular B.B.J. reader and send name while signing myself.—SOUTHERNER, *Sussex, August 22*.

REPLY.—If you are content to have patched-up old combs in the new frame-hives instead of new and straight ones, it will be all

right to transfer the old brood-combs as proposed, but we prefer letting the bees transfer themselves from skeps to frame-hives and build new combs below. It will, however, help you in wintering to use ready-built combs as suggested. Select the nicest combs and pack them nicely and tightly in the frames so that they will not fall out and make a mess of your task. Regarding the use of naphthaline in bee-food in lieu of N. beta, we should say the bees will refuse to take syrup so "medicated" (?), and if it does not poison the bees it will certainly not be of the slightest use for the intended purpose.

[3212.] *Queen Mating*.—I send herewith two bees (a queen and a drone), and will be pleased if you could say: 1. Whether or not the drone has fertilised a queen, or does its condition arise from other causes? 2. Also, if queen has been mated? I know the dead insects are getting rather dry, but you may be able to tell. 3. What is the limit age for queen mating?—D. A. S., *Darlington, August 20*.

REPLY.—1. The drone sent had evidently mated with a queen. 2. Dead queen had all the appearance of a virgin, but was too dry for *post-mortem*. 3. Mating has occurred nearly a month after birth, but it rarely exceeds fourteen days.

[3213.] *Dealing with Skep Honey*.—I have just taken the contents of a straw skep, from which I had previously driven the bees, and have obtained from it 5½ lb. of honey by mashing up the combs and allowing the honey to drip through a fine hair-sieve. I find it is not very clear, and I suppose fine particles of wax have filtered down as well. How can I clarify it to make it fit for home consumption, or what other use can I make of it? Will it do for feeding purposes?—BEGINNER, *South Wales*.

REPLY.—Strain the honey through fine muslin in front of the fire for table use. For bee food dilute with warm water to the usual consistency of sugar syrup.

[3214.] *Moving Bees*.—1. I am about to remove to another district, and wish to take my bees with me. They are in a "W.B.C." hive, with floorboard fixed to stand. Should I get a loose floorboard same size as body-box and fasten on bottom, and put perforated zinc on top of frames, as per "Guide Book"? I suppose it would not be necessary to pack outer case with body-box? 2. Would the bees travel all right without outer case? I should be pleased for any advice.—NOVICE, *Devon*.

REPLY.—No properly made "W.B.C." hive has a fixed floorboard, such floors being an abomination to its designer. 1. The floor being fast to body-box, it only needs perforated zinc over entrance and top-room over frames, as advised in Guide Book. 2. The outer case



may be left behind for that matter, or packed separately in cart for transit.

[3215.] *Suspected Queenlessness and Uniting.* After being away from home a fortnight, on examining my stock of bees in a frame-hive I find no eggs or unsealed larvæ in the combs, though there is sealed brood, both worker and drone, and plenty of honey, and so I ask: 1. Do you think the queen is dead, and, if so, would you advise my uniting a stock which I have in a straw skep about 20 ft. away? 2. If you advise it, should I drive the bees from skep into the frame-hive, and place the skep on the top of frames, with excluder, till the brood is hatched? 3. The stock in skep is a strong one. Should I cage the queen, if I can catch her, while driving, or should she run in with bees?—H. J. POPE, Bristol, August 22.

REPLY.—1. We advise you to make sure the queen has disappeared before uniting. Sometimes queens cease egg-laying in autumn. 2. If stock is really queenless, the course proposed will be right. 3. Should a chance occur of catching the queen when "driving," cage her for twenty-four hours; but if the bees are dusted with flour when uniting, there is very little risk to queen.

## Bee Shows to Come.

A nominal charge of 2s. 6d. is made for notices in this column, which covers cost of insertion from order till date of show. Cash should accompany orders for insertion.

September 5, at St. Mary's Hall, Dumfries.—South of Scotland, B.K.A. Eleventh Annual Show of Bees, Honey, and Appliances. Seven Open Classes, viz.: (1) Three 1-lb. Sections. (2) Three 1-lb. Jars Extracted Honey. (3) Beeswax. (4) Complete Frame-Hive. (5) Single 1-lb. Section. (6) Single 1-lb. Jar, and (7) Single 1-lb. Sections and 1-lb. Jar Extracted Honey. Free entry in the last three classes. Schedules from S. McVie, Hon. Sec., Essex Park Cottages, Dumfries.

September 5 to 12, at the Agricultural Hall, London.—Honey Show in connection with the Confectioners', Bakers', and Allied Traders' (11th) Annual Exhibition and Market. Numerous classes and liberal prizes for comb and extracted honey and beeswax. Open to all British Bee-keepers.

September 8, at Woodstock.—Oxfordshire B.K.A. Honey Show. Open classes (with free entry) for single 1-lb. section and single 1-lb. jar extracted honey. Prizes 7s. 6d., 5s., and 2s. 6d. in each class. Schedules from H. M. Turner, Hon. Sec., 4, Turl-street, Oxford.

September 9 and 10, at Derby.—Derbyshire B.K.A. Twenty-second Annual Show of Hives, Bees, and Honey on the show-ground of the Derbyshire Agricultural Society. Schedules from R. H. Coltman, Hon. Sec. D.B.K.A., Station-street, Burton-on-Trent. Entries close August 29.

September 17, 18, and 19, at Crystal Palace.—Surrey, B.K.A. Annual Exhibition of Bees, Honey, Wax, and Appliances, &c. Twenty-four classes (ten open to all). Increased prizes and medals. Schedules from F. B. White, Secretary, Marden House, Redhill, Surrey. Entries must be made before September 1.

September 19 to 26, at the Agricultural Hall, London.—Honey Show in connection with the

Eleventh Annual Exhibition and Market of the Grocery and Kindred Trades. Numerous classes and liberal prizes for comb and extracted honey and beeswax. Open to all British Bee-keepers. Special attention is directed to the new Honey-selling Classes with free entry. Schedules from H. S. Rogers, Secretary, Exhibition Offices, Palmerston House, Old Broad-street, London, E.C. Entries close Sept. 7.

October 6 to 9, at the Agricultural Hall, London.—Show of Honey and Bee-produces in connection with the British Dairy Farmers' Association. Numerous and liberal prizes for honey, &c., including the valuable Silver Challenge Cup of the B.B.K.A. Schedules from Mr. Wm. C. Young, Secretary, 12, Hanover-square, London, W.

## Notices to Correspondents & Inquirers.

Letters or queries asking for addresses of manufacturers or correspondents, or where appliances can be purchased, or replies giving such information, can only be inserted as advertisements. The space devoted to letters, queries, and replies is meant for the general good of bee-keepers, and not for advertisements. We wish our correspondents to bear in mind that, as it is necessary for us to go to press in advance of the date of issue, queries cannot always be replied to in the issue immediately following the receipt of their communications.

\* \* We are requested to say that in consequence of the adverse honey season and lack of entries for the annual show of the Derbyshire B.K.A., to be held at Derby on September 9 and 10, the date of closing entries is extended to August 29, at ordinary fees. Six open classes with liberal prizes. See "Shows to Come."

\* \* A correspondent asks for the address of a few Scotch bee-keepers who have heather honey to dispose of. We confess ourselves unable to help in the required direction, but will forward particulars should any Scotch reader have honey to offer.

SOCRATIS (Co. Wexford).—*Packing Sections for Transit.*—The safest method is to use a box large enough to allow of plenty of soft packing (hay or broken straw) between and around each layer of sections, and to take care that no sections are sent save those with comb attached to the wood on all four sides. The sections are, of course, packed as they stand on the hives, and labelled "Comb honey with great care" on top of box in which they travel. A hundred or more sections, if properly packed, will travel more safely than a dozen, for they cannot so readily be tossed about.

C. R. WYMER (Greenwich).—*Immature Drones Cast Out.*—The "young bees cast out dead" from your hive are immature drones, and need cause no alarm. It simply indicates the end of season, and consequent uselessness of drones, the pupæ of which are thrown out of the hive before reaching maturity.

J. ANDERSON (Selkirk).—"Balled" Queen.—The queen has, for some reason, been "balled" by her own bees. There is no sign of physical injury, and it may be that

the bees are already raising a successor, which at this late season would stand a small chance of mating. You should, therefore, procure a small lot of driven bees with young queen, and get the latter introduced to the queenless stock without delay.

**INQUIRER** (Walton, Liverpool).—*Best Time for Driving Bees*.—It is incorrect to say that "bees can only be 'driven' from skeps in the morning." They may be driven at any hour when weather is sufficiently warm to render the bees active on the wing.

**L. B. W.** (Herefordshire).—*Bee Anatomy and Physiology*.—1. Our Senior Editor will be returning to town shortly, and we will consult him with regard to the information you wish to obtain. 2. *Micro-slides of Bee Anatomy*.—We rather think there are no micro-slides of the respective digestive systems of the queen, drone, and worker bee published in this country, but we will inquire later on.

**F. H. H.** (Leicester).—*Feeding Bees in Skeps*.—It will be necessary to cut a hole in top of skep for feeding purposes. This is a very simple job if a sharp, pointed knife is used. The simplest feeder is a wide-mouthed glass bottle holding about 2 lb. ; when filled with sugar-syrup, tie a piece of fine muslin tightly over its mouth, and invert the bottle quickly, and insert the bottle in the feed-hole already made, then wrap the junction well with a roll of newspaper; this will keep the bottle steady, and prevent bees getting at the food from the outside. When fed up for winter the skep should weigh about 25 lb. Write us again in early spring, when we will advise you about transferring the bees to a frame-hive, as proposed.

**SPEYSIDE** (N.B.).—*Packing Bees for Transit*.—To first query we reply *no*; and with regard to second one, the bees might *possibly* travel without being suffocated, but the chances would be a hundred to one against them doing so.

**BUMBLE** (Boroughbridge).—*Varieties of Heather*.—Sprig of bloom sent is *Erica vulgaris*, or common ling. If weather is favourable, and the "four or five acres" of bloom is on high ground, it should yield honey plentifully. But the weather now is all against honey gathering on the moors.

**W. WILLIAMS** (Coleford, Glos.).—The heather bloom sent is that of *Erica cinerea*, or bell heather. It is a good honey plant if grown on hills or high moorlands.

**IGNORANT** (Wimborne).—*Driving Bees for Building up Stocks*.—The "Guide Book," of which you are "just possessed," will furnish all the information needed with regard to driving bees and building them up into stocks in frame-hives. We need only add that a beginner had better have each lot in a separate skep, and unite them after reaching home, or when "joining up" the driven bees in frame-hives. You need not

trouble about killing surplus queens; leave that to the bees themselves.

#### *Suspected Combs.*

**ENQUIRER** (Wilts).—The comb has a suspicious look, but you will need to send a small piece containing *worker brood* before we can diagnose the case. Drone brood is not suitable for the purpose.

**J. C. T.** (Leicester).—Comb is affected with unmistakable foul brood; and, bearing in mind your healthy stocks near by, it will be safest and best to destroy the diseased lot entirely.

**FAITHFUL READER** (N. Wales).—The comb sent is affected with foul brood, but if sample is a fair specimen of combs in the hive it seems a recent outbreak.

**KENNEDY** (Prestwick).—Comb contains nothing worse than fresh-gathered pollen.

#### *Honey Samples.*

**G. F. O'FLAHERTIE** (Harlow).—We do not detect any honey dew in sample. The colour is "medium"—as graded by the B.B.K.A. colour glasses—and the same term applies to its quality, which is fairly good. With regard to your question, "Is it fair to sell it as honey?" we should say decidedly yes.

**J. H. S.** (Devon).—Owing to absence from town your sample did not reach us till 24th inst., and was covered with mouldy fungus growth when opened. So far as we judge there is no disease in comb, but if a fresh sample is sent, we could answer more definitely.

**C. G. S.** (South Norwood).—Sample is certainly very dark in colour, as honey is this year in many districts. Quality very fair. There is no sign of honey dew in its flavour or aroma.

**MRS. GELLATLY** (Essex).—Honey is altogether too dark and coarse in quality for table use, but will do very well as bee food. It is an unfortunate feature of the present season that much of the honey in several districts is dark and unsuitable for the table.

**F. ALLEN** (Sussex).—Colour of your sample is "medium." It is from mixed sources. Quality fair, nor do we detect any honey dew in it.

**HAZEL** (Atherstone).—No. 1 is good in colour, but rather thin. Flavour fairly good. No. 2, though a shade darker, is better in flavour and consistency than No. 1. We cannot give a better idea of prices than our "Prepaid Advertisement" Column affords.

**J. HUMPHREYS** (Ruthin).—1. Sample is good in colour and flavour; the consistency, though not first-rate, is fair. 2. Read what appears on front page with regard to "showing."

\* \* \* *Some Letters and Queries are unavoidably held over till next week.*

## Editorial, Notices, &c.

### IMPORTANT NOTICE.

#### REMOVAL OF "BRITISH BEE JOURNAL" OFFICES.

Owing to expiration of lease the offices of the BRITISH BEE JOURNAL and the *Bee keepers' Record* will, at the end of the present month, be removed to larger and more convenient premises, No. 10, Buckingham-street, Strand, about fifty yards from Charing Cross Station. All communications after the 28th inst. must therefore be addressed as above.

The new premises are on the ground floor, and being only two minutes' walk from our present offices, no difficulty will be experienced in reaching the new address.

#### MARRIAGE OF MR. WM. HERROD.

Mr. W. Herrod, apiarist and lecturer to the British Bee-keepers' Association, was married on August 25 to Miss Annie Hunt, and has now entered into a house and several acres of land at Old Bedford-road, Luton, Beds, where a large apiary will be formed.

To one so well known and deservedly popular among bee-keepers of all classes as Mr. Herrod, we are sure that BEE JOURNAL readers, along with ourselves, will heartily wish long life and happiness for himself and his good wife. He has made troops of friends through his bee-work for the B.B.K.A., and in connection with his lectures and apicultural teaching for several years past at the Horticultural College, Swanley, Lady Warwick's Hostel, Reading, and elsewhere. Among the numerous wedding presents was a very handsome silver salver from the past and present students of the College at Swanley.

#### LANCASHIRE B.K.A.

##### HONEY SHOW AT CARTMEL.

The above show was held on August 25 in the midst of picturesque scenery and blessed with a beautiful day, and was very successful. For a season such as the present, when very few hives (here in the North) have yielded any surplus at all, an entry of over forty exhibits was very creditable to the Misses Wilson and Mr. W. G. M. Townley, the prime movers, who have also been instrumental in raising the money prizes awarded in the local classes.

Mr. F. H. Taylor, Chorley, judged the exhibits, and also gave two lectures—with bee-demonstrations—in the bee-tent.

##### AWARDS.

*Six 1-lb. Sections* (open).—1st, W. Patchett, Caistor, Lincs.; 2nd, S. Wright, Macclesfield; reserve, J. Jones, Wegber; h.c., T. Walker, Eskthwaite; c., D. R. Baines, Coniston.

*Six 1-lb. Jars Extracted Honey* (open).—1st, W. Patchett; 2nd, J. Stirzaker, Stal-mind; reserve, F. Sharples, Rainhill; h.c., J. Jones, Wegber, H. Fenny, St. Helens, and W. Lowe, Rainhill.

*Beeswax* (open).—1st, T. Walker, Eskthwaite; 2nd, W. Clark, Grange-over-Sands; reserve, W. Patchett; h.c., Miss I. Wilson, Morecambe, Miss M. Hunter, Newley Bridge, and J. Pearman, Derby.

##### LOCAL CLASSES.

*Six 1-lb. Sections*.—1st and 2nd, W. Clark; 3rd, R. Hill, Grange; 4th, F. Thompson, Grange.

*Six 1-lb. Jars Extracted Honey*.—1st, W. G. M. Townley, Grange-over-Sands; 2nd and 3rd, W. Clark; 4th, F. Thompson.

##### PRESENTATION PRIZES.

*For best Exhibits from County*.—1st (Lancs. B.K.A. Silver Medal), J. Stirzaker; 2nd (Bronze Medal), J. Jones.

Bee-hive (Mr. George Rose's prize) for best sections in district, W. Clark.

Bee-hive (given by Grange members of L.B.K.A.) for best extracted honey in district, W. G. M. Townley.

Thanks are due to the Lady Evelyn Cavendish, Lady Hibbert, Misses Arkwright, and Miss L. Wilson for the local prizes. Miss Wilson exhibited an observatory hive which attracted much attention.—(*Communicated*.)

#### HONEY SHOW AT ADLINGTON.

An exhibition of honey and wax formed one of the departments of the Adlington and District Agricultural Society's Show on August 5. The Rev. E. Charley, Ince, officiated as judge, and made the following awards:—

*Six 1-lb. Sections* (open).—1st, W. Ratcliffe, Barthomley; 2nd, R. S. Marshall, Moore, Staffs.

*Six 1-lb. Jars Extracted Honey* (open).—1st, Stanley Wright, Macclesfield; 2nd, H. Booth, Adlington; 3rd, G. W. Carr, Checkley, Hereford.

*Beeswax* (open).—1st, W. Ratcliffe (only exhibit).

*Six 1-lb. Sections* (district).—1st, Stanley Wright; 2nd, Septimus Wright, Wilmslow.

*Six 1-lb. Jars Extracted Honey* (district).—1st, Stanley Wright; 2nd, H. Booth; 3rd, F. Dale, Adlington.

*Beeswax* (district).—1st, Septimus Wright; 2nd, J. Turner, Bramhall; 3rd, Stanley Wright.—(*Communicated*.)

#### HONEY SHOW AT LLANGOLLEN.

The above honey show was held on August 27 in connection with the Llangollen Fruit, Flower, and Vegetable Show, and was very successful, both the quantity and quality of the exhibits being all that could be desired.

The competition in the open classes was very keen, an extra prize being awarded in the section class. The Rev. E. Charley, of Ince, Chester, acted as judge and made the following awards:—

OPEN CLASSES.

*Six 1-lb. Sections.*—1st, S. Cartwright, Shawbury, Shrewsbury; 2nd, J. Carver, Wellington, Salop; 3rd, Wm. Ratcliffe, Crewe; 3rd (special), Jas. Clay, Wellington.

*Six 1-lb. Jars Extracted Honey.*—1st, Wm. Patchett, Cabourne, Lincs; 2nd, S. Cartwright; 3rd, J. Carver.

*Beeswax.*—1st, Jno. Rowlands, Pwllheli; 2nd, M. Morgan, Cowbridge.

LOCAL CLASSES.

*Six 1-lb Sections.*—1st, Dr. E. Williams, Minffordd; 2nd, G. M. Turie, Roncysyllte; 3rd, Harvey Birch, Cherry Tree.

*Six 1-lb. Jars Extracted Honey.*—1st, Foulkes Jones, Arosfa; 2nd, Albert Williams; 3rd, Dr. E. Williams. — FRANK LITTLE, Secretary.

## Correspondence.

*The Editors do not hold themselves responsible for the opinions expressed by correspondents. No notice will be taken of anonymous communications, and correspondents are requested to write on one side of the paper only and give their real names and addresses, not necessarily for publication, but as a guarantee of good faith. Illustrations should be drawn on separate pieces of paper. We do not undertake to return rejected communications.*

*Communications relating to the literary department, reports of Associations, Shows, Meetings, Echoes, Queries, Books for Review, &c., must be addressed only to "The Editors of the 'British Bee Journal,' 17, King William-street, Strand, London, W.C." All business communications relating to advertisements, &c., must be addressed to "THE MANAGER, 'British Bee Journal' Office, 17, King William-street, Strand, London, W.C."*

### NOTES BY THE WAY.

[5220.] The weather is still unsettled in our district, wet and dull as I write, lamps required before 6 p.m., and this on the closing day of August! Our farmers are in doleful dumps with their harvest prospects, as well they may be with some of the fields in "shock" for nearly a month, and corn not in condition to garner all through August. With every rise of the barometer comes a hope that the remaining weeks of harvest will be heralded by suitable weather for the ingathering. The bee-keeper's harvest has, I fear, been on the whole a light or short one. Attention should now be turned to the important job of preparing for winter by examining in order to ascertain the amount of stores in brood-chambers, and, if short of the required quantity, feed rapidly with good thick syrup as early in September as possible, so that the bees may seal it over.

*Driven Bees.*—These may be built up into good stocks if large lots are obtained, and can

be hived on fully-built combs, or extra-store-combs given from other hives. A few of these combs can generally be spared if the full number of ten or eleven is in use in body-boxes, or with the "combination" hive can be produced by the bees ready when required by giving strong colonies one or two full sheets of foundation towards the close of the season. In the hands of careful bee-keepers driven bees may be built up on sheets of foundation and with the aid of rapid-feeding, but late comb-building very much undermines the stamina of the bees, and unless it is done early, so that young bees are bred to take the place of the older overworked ones in the economy of the hive, these stocks often "dwindle" in the spring, and so all the labour is lost.

*Wax Extracting.*—The solar wax extractor has certainly not worked wonder this summer; it may be those too frequent spots on the sun, or, perhaps, a multitude of icebergs in the Atlantic Ocean that has interfered with the shining of Old Sol in all his glory; in any case, we have had to return to the saucepan and strainer to reduce the old comb to wax and prevent the wax-mot forestalling us. I notice in the American bee-papers that the German wax-extractor is considered to be the most efficient on the market. Do our appliance-dealers make or supply these German wax-extractors? We want to get every ounce of wax out of the melted combs, but I think, with the present system of draining, much is wasted. It appears that the screw-pressure of the German machine forces out the wax while at boiler heat.

The season just closing has been a trying one to the bee-keeper. A cold spring retarded growth of brood-nests, and as so much of our success depends on having rousing colonies just when the honey flow commences, it was only by continued feeding that bees were kept breeding and brought up to the required condition for the short spell of summer weather we had in the last week of June. But results have again proved that a job is worth doing at all it is worth doing well. My home apiary has this year produced more honey in proportion than the out apiary, whereas in other years I have considered the out apiary to be the best in both quality and quantity. I attribute this result entirely to the fact that the bees at home got more constant attention than those two miles away, as the frequent rainy days continually altered one's plans, and intended visits for feeding purposes were often put off till next day. Thus the out-apiary bees were fed intermittently, while those at home had attention daily. Readers will however, please remember I do not advise, or practise, spring-feeding to stocks amply provided with food for their needs, but only such as are known to be short of stores, or when the weather is unsuitable for honey gathering.

in the natural way, as the bees do in most seasons, late in May and early in June. This season I was feeding some colonies up till June 21, and but few supers were on till June 17, while the majority of my stocks were not supered till after midsummer.—W. WOODLEY, *Beedon, Newbury.*

P.S.—In "Notes by the Way" on page 334 of B.J. for August 20 (fifth line from top of column) a printer's error makes it read, "and every bramble bush clover," &c. Please correct this to "*white clover and every bramble bush,*" as I wrote it.—W. W.

## THE LONG AND THE SHORT OF IT.

(A MATTER OF PRONUNCIATION.)

[5221.] Amongst the few scientific terms with which the ordinary expert must make himself familiar two present themselves in Latin; *Bacillus alvei* and *Propolis*. Whereas, to my personal knowledge, these three words are a stumbling block to many good men whose young days were spent in pursuits of more immediate advantage than a struggle with dead languages, I trust that my fellow experts will bear with me if I extend a helping hand, as one who has himself been through the classical mill, to those (and to those only) who need it. To avoid confusion, it is important that all who have to address chance audiences should in this case adopt a uniform pronunciation, which may just as well be the correct one. There should be no hesitation over unfamiliar words, as that at once weakens the confidence of a listener. Let us all pull together, and pull straight.

First, then, *Bacillus alvei*, the Bacillus of the hive. The *ac* should be sounded exactly like the same two letters in the word *acid*. The stress of pronunciation is on the second syllable, as shown by this little couplet:—  
"Kind Sir," said the bees, "you may just as well kill us,  
As leave us a prey to this dreadful Bacillus."

In *alvei* the stress is on the first syllable, and the *al* is sounded as in *alcohol*. The *e* is quite short, and the word might be rendered in English *alveyi*; not on any account *alveei*.

Propolis is derived from two Greek words, *pro* (before) and *polis* (a city), all the vowels being short. The ancient Greek naturalists had noticed that the bees use this glue for stopping up undesired crevices and passages, and sometimes to fortify the entrances of the hives, the city gates. The Latin writers who followed them, and are indebted to that source for most of their bee lore, took the word into their own language, and handed it on to us. It is now almost English, and to show the pronunciation may be divided thus, *prop-o-lis*, the stress being entirely on the first syllable, and all the vowels short.

To prevent misunderstanding I must mention that I have sought to convey the usual English pronunciation, which is the best for our present purpose. We are in some sense alone in our treatment of Latin, and a Scot or

an Irishman might prefer to give the vowels a more Continental sound. This, however, does not affect the main point at issue, the proper syllabic stress. The words in question must always be *bacillus, alvei, propolis*; and to pronounce them otherwise (as, for instance, *bassilus, alveei, propolis* or *propolis*) is to commit a grievous classical blunder.—H. J. O. WALKER (Lieut.-Col.), *Budleigh Salterton, S. Devon.*

## A BEE NOTE FROM HANTS.

TALL SECTIONS.

[5222.] My note in a recent issue of B.B.J. indicated a promising opening of the honey season, but within a few days the weather broke, and when an improvement took place the swarming fever set in with an energy that no efforts could do more than partially check. In most cases I returned swarms after depriving them of the queens, and the final result is better than last year by some 10 lb. or 12 lb. per hive. From eight stocks I have taken over 380 lb. of honey, contained in some 425 sections, of which only about 300 were of full weight. My best stock yielded 91 lb., and my worst 17 lb. As far as I can gather, this is decidedly better than the average for this district. The quality is uniformly good. A considerable proportion is of medium colour, but I have no very dark honey.

My experience of the tall sections is not such as will induce me to use them again. I gave two racks of them to one of my best stocks. They were fairly well filled, but the bees were longer in entering and slower in completing them than ordinary sections. The only noticeable point in their favour seems to me that the comb is built out all round flush with the edges of the wood, making them, perhaps, neater for show purposes than the old form. This appears a trifling advantage to set off against many shortcomings and the alterations they necessitate in racks, &c.—A. ROYDS, JUN., *Soberton, Hants, August 25.*

## BEE-KEEPING IN SHROPSHIRE.

[5223] On account of the continued wet weather, the past season in this part of Shropshire has been the poorest for many years for honey production. Most beekeepers who live near me have had the same experience as myself, and have taken very little surplus honey. For years past I have always had an abundant supply of section honey, sufficient for home use, for sale, and for presents to friends. During the winter of 1902-3 a series of excellent lectures on "Bees and Bee-Keeping" (provided by the Shropshire County Council) were given in our village school-room. Although the lectures were both interesting and instructive the attendance was not so numerous as one could have wished. One lecture was illustrated by lantern slides, and amongst the pictures were

several in which our Junior Editor, Mr. W. Broughton Carr, was introduced to us. One thing I notice is the lack of interest shown in bee-keeping by farmers and the larger occupiers of land. Probably this is due to the fact that a certain amount of technical knowledge is required in order to make the industry profitable, and they are unwilling to give the time for acquiring this knowledge. Very few of our cottagers, I notice, keep bees. This, I believe, is due in a great measure to the uncertainty of tenure of their cottages. In Shropshire, and in many other agricultural districts in England, the cottages are let with the farm, and it is a familiar sight, especially at Lady-Day of each year, to see the labourers moving from one district to another, with all their goods and chattels piled high upon the waggons, the mother and younger children riding on the top, while father and the older boys and girls walk alongside. These continuous changes would make it difficult for a family to remove their hives, and so they do not care to commence keeping bees. To me the industry has afforded endless pleasure, and I am always ready to read and learn more. One of my recently acquired books on this subject is that charming work entitled, "My Bee Book," by the Rev. William Charles Cotton, written a good many years ago. It was given to me by a lady, and I certainly have enjoyed reading the quaint stories, and the accounts of what others wrote and did in the years that are past.—(Rev.) A. H. M., *Uffington, Salop.*

#### FORMALDEHYDE V. FOUL BROOD.

[5224.] I was sorry to read that the experiment of Mr. G. M. Saunders (5212, page 336) with the above germicide was not successful, as I had been anxiously waiting to hear the results. Will your correspondent "Blackwood" (5215, page 344) kindly say which time of the year he considers most suitable for fumigating combs, autumn or spring? I ask this because it seems to me that much disease may be covered by pollen and honey in autumn. Again, ought every capped cell to be uncapped, whether healthy or diseased? because we know that whenever treated some healthy brood must be sacrificed; and also does he extract the honey? Any information will be gladly received as to the uses of formaline in bee-keeping, especially if it will help to keep down "the enemy." I am anxious to give it a trial, and would like to know the best way to proceed. I send name, &c., and sign myself—A WORKER BEE, *Oxfordshire, August 29.*

#### FORMALDEHYDE

FOR FUMIGATING COMBS.

[5225.] In reply to "Blackwood" (5215, page 344), I would say the combs were not refused by the bees as your correspondent

supposes; when my friend was ready to run them on the latter he discovered that there were no bees in the temporary hive; they had already joined the next stock. If your correspondent will kindly refer to page 282, he will see that I know about airing the combs, but any information not there contained, I should be very glad of. Why *must* the liquid be evaporated to dryness? Surely it would be better to have more liquid and remove whilst still discharging gas? According to what I have read, the adding of water would cause the gas to polymerise, and thus weaken it. I would further ask: Has "Blackwood" fumed combs with diseased brood, pollen, and *heavy stores*, and given them back to the bees, without a return of disease?

I would also mention that the gas attacks iron and steel, so that these should be avoided in making the fuming chamber.—GEORGE M. SAUNDERS, *Keswick, August 29.*

#### PREVENTING SWARMING.

[5226.] Your correspondent Wm. Castle (who writes on page 345) does not say whether in working the non-swarming system he took care that each hive had a young queen every third year. Unless he attended to this important point "spring dwindling" would be the inevitable and only result to be expected. Artificial swarms should do about as well as natural ones when once established.—W. J. FARMER, *Truro, August 28.*

#### THE SEASON IN SUSSEX.

[5227.] Considering the season we have had, I think I have done well with my bees, nearly 700 lb. from nine stocks; from one hive alone I have taken over 100 sections. My stocks were very strong for the short period of fine weather we had in July, having been checked from swarming by the previous bad weather, and the late clover harvest helped them on a lot.—F. W. MOORE, *Worthing, August 29.*

#### HONEY JUDGING.

COLOUR GRADING.

[5228.] I note your remarks on the comment I sent (5217, page 345) regarding the judging of exhibits and awarding of certain prizes at the Shrewsbury show, and while quite agreeing with you that colour is only one point to be considered in judging honey I must explain that I did not write on the subject from the mere onlooker's point, as you suppose, but, by permission, I examined the exhibits on other points required, and thus arrived at my decision. I should never think of commenting through the B.B.J. on such a question without knowing the full details and merits of the case. I notice, from the report on page 342 of B.B.J., the prize referred to has been withheld.—J. S. LAWTON, *Bridgnorth.*

## HOMES OF THE HONEY BEE.

THE APIARIES OF OUR READERS.

The apiary seen below is one we have peculiar pleasure in illustrating in our beegarden pictures as belonging to a working gardener of thirty-four years' experience, and as affording an object lesson which we hope will be taken to heart by all who follow the same occupation as our friend Mr. Whitmore. It only needs to read the following notes of his experience with bees since he began, eight years ago, with one hive purchased for his employer, to explain what we mean, and we therefore add nothing thereto. He says:—

"My first experience with bees was eight years ago, when I purchased for my employer

the hives were made by myself during winter evenings, and they have separate floor-boards and stands, with roofs covered with zinc; this makes the roof waterproof, and the increased weight makes it less liable to be blown off by wind.

Bee-keepers about here have to depend upon the white clover for their honey, of which there is a great abundance during June and a part of July.

There are only about eighteen or twenty hives of bees kept in this village, when the number might be at the least 150; and with this number of hives well managed, divided among the cottagers, it is easy to see how much better off they would be, and all through a pleasant; pastime. Speaking for



MR. H. WHITMORE'S APIARY, DAVENTRY, NORTHANTS.

a stock of bees in a modern frame-hive from a bee-keeper that was leaving the village.

I had the usual fear of bees at the start, but I soon overcame this, and, procuring a 'Guide Book,' I began to study the principles of bee-management as detailed therein; and operations which appeared very difficult before were made plain and easily accomplished, so that bee-keeping soon began to be a real pleasure. Being a gardener by occupation, I also had a good opportunity of studying the habits of the bees.

This first hive was soon increased to three belonging to my employer, and this is the number it stands at now.

The small apiary seen in the picture is my own, and stands in my cottage garden; it consists of eight hives—one not showing. All

myself, I feel certain that, in the near future, bee-keeping in rural districts will become more general, and be one of the attractions to keep our young men from leaving the villages for the towns, and I quite believe young fellows would prefer a country life, if they could see a way of getting a fair living the year round. But as things are at the present time, many are compelled to seek employment elsewhere. Although bees are to some extent kept in towns, I should say only the best results can be attained in the country villages, and bee-work could easily be added on to many employments necessarily taken up for the purpose of obtaining a living, and would considerably add to the income. As an instance, take the small farmer, market gardener, or dairyman occupying two or three

fields; why, any of these might increase his income by half, or more, by keeping a score or so of hives. Then, again, bee-keeping and fruit-growing go well together, and might be made very profitable in combination. But whoever takes up bee-keeping must be thorough in his management, and follow strictly the instructions given in 'Guide Book,' for if he does not attend to all points carefully, loss and disappointment might easily result, instead of pleasure and profit.

In the spring of 1902 I had six hives of bees, and one of them gave me two swarms, which brought up my total stocks to eight. The other five colonies also sent off large swarms, but these were all returned the same evening after cutting out queen-cells.

The five colonies gave me over 3 cwt. of extracted honey, and I found a ready sale for it at 6½d. to 8d. per lb.

When I have finished taking up the honey, I open all hives and notice what stores each colony has got. I then put on the feeders, and feed each one according to its stores, slowly at first, afterwards faster, and always at that time of the year when the bees have done flying for the day, the feeding being finished by the middle of September.

This may seem a lot of trouble to go to, but when I pack the hives down for winter, and see how well they are packed with bees, I feel myself compensated for any little extra trouble I may have gone to in caring for my little labourers."

#### GARDENERS AND BEE-KEEPING.

The Bristol and District Gardeners' Mutual Improvement Association held its monthly meeting at St. John's Rooms on Thursday, August 27, Mr. E. Poole, F.R.H.S., occupying the chair. The lecture for the evening was on "Bees," and was given by Mr. Jordan, of the Bristol Bee-keepers' Association, who, in a very able manner, described the best methods of modern bee-keeping as against the old-fashioned and barbarous ways of our forefathers; showing that by the use of the frame-hive and modern methods bees can be handled with impunity and examined at will, while securing the fullest and best results from their labours. He advised gardeners to make a special study of these industrious insects, which would help them considerably to become successful bee-masters. Besides, gentlemen were also becoming more interested in apiculture, and were realising the advantages of keeping in their gardens a hive or two of bees for fertilising the flowers and fruit.

The time at the disposal of Mr. Jordan was unfortunately too short for such an interesting subject, and he was asked to address them again at some future date, which he has promised to do. A discussion followed, and a cordial vote of thanks was passed to the lecturer after a most enjoyable evening.—(Communicated.)

## Queries and Replies.

[3216.] *Sulphur for Disinfecting Hives and Appliances.*—1. Would you or any of your readers kindly give an opinion as to whether the fumes of burning sulphur is a sufficient disinfectant for a hive and appliances which have contained foul brood? If an amateur might be allowed to venture an opinion I should think it was equal to formaldehyde for pungency and penetrating power. I must thank you for reporting on the comb I sent a few months ago. I have destroyed the two stocks from which that comb was taken by submitting them to the "sulphur pit" process, and have taken from them a good quantity of honey—perhaps 50 lb. 2. I suppose this is quite good for human food? May I also say I prefer the sulphur pit to the paraffin oil can as a means of destroying bees?—X. Y. Z., Cornwall, August 27.

REPLY.—1. It cannot be too widely known that the fumes of burning sulphur, which are so effective in destroying life, have no effect whatever on the spores of foul brood. This is a matter quite beyond dispute. 2. The honey in question is quite good for table use.

[3217.] *Stray Swarms and Foul Brood.*—I am forwarding you a sample tin of what I believe is foul brood, as it corresponds exactly with the description and illustration in "British Bee-keepers' Guide Book." If you would kindly give me a word of reply I shall be very thankful, as I have never seen foul brood, though I have been a bee-keeper for the last thirteen years. I may say that I am going to destroy the bees this evening, and, also, shall I burn the hive? I am going to burn the frames and combs. I suppose it would make a clean job to burn the lot, as the hive is seven or eight years old. I may say the bees are a stray swarm that came into my garden on July 11 last. I put them in a frame-hive on five frames, as they were not a very large swarm. I looked at them a few days later, and the comb, of which I have sent a portion, was filled with eggs, and fortnight later filled with brood, as was also another comb; and they were storing honey. To-day I looked again, with the result—fewer bees, and what I think is foul brood in an advanced state. I shall be very careful of stray swarms in the future. The hive I put them in was thoroughly cleansed, and had been freshly painted this summer. I am a member of the Surrey B.K.A., but the expert lives a long way from here or I would not have troubled you.—W. E. H., Cobham, Surrey, August 29.

REPLY.—We publish your query in full, as showing the danger which may even possibly attend the hiving of a stray swarm, and how useful it is to be on the safe side by using preventives against disease. The sample is



badly affected with foul brood in virulent form, and under the conditions named we should burn hive and all.

[3218.] *Grading Honey for Showing.*—Will you kindly give me your opinion of the honey sample enclosed? 1. Would you class it as a 'light' or 'dark' honey? It is much darker than I expected, considering there are twenty or thirty acres of hybrid clover from 1 to 1½ miles from here. 2. What is its probable source? 3. What is its quality for show-bench, or for commercial purposes? 4. Does borage yield light honey? This is my first honey season, hence my ignorance. Thanking you in anticipation of your usual kindness and courtesy, I send name and sign—DILIGENCE, *Saltby, Birmingham, August 29.*

REPLY.—1. As seen in small phial sent, your sample is just within the "light" colour grade, but in a 1-lb. honey jar it would be "medium" in colour. 2. It is from slightly mixed sources, but mainly from the hybrid clover mentioned. 3. It would stand well in a class for "medium coloured" extracted honey on show bench, and for sale across the counter. 4. Borage yields honey much the same in colour as your sample.

[3219.] *Foul Brood and Large Apiaries.*—I have been unable to reply to your kind letter referring to foul brood, so I now write to thank you for it. The comb in question was taken from a lot of driven bees imported from a neighbouring village in September last year. The combs could not be old, and, consequently, foul through age alone. The bees have done remarkably well, having filled the hive (a skep) and another box below, and had commenced a few combs in a third hive placed as a super.

We have driven the bees into this third skep, and taken away the other two and burnt them. The apiary has been in existence nearly fifty years, and numbers now over 100 stocks.

It therefore makes me very anxious about those remaining hives, as I have never had, to my knowledge, such a thing before. We have been examining the hives again this week, and found healthy combs in all except one lot, from which I am sending a sample for your further opinion. I should feel obliged if you would tell us if it is advisable to destroy this stock? The bees seem now quite strong and vigorous, and have been carrying in pollen. I send name, &c., and sign myself—ENQUIRER.

REPLY.—We regret to say there is distinct foul brood in scattered cells here and there in sample. Therefore, in view of the danger to so many healthy colonies standing contiguous to the diseased ones, we should at once get the bees off combs, if really worth saving, and destroy the whole contents of the affected hives, including bees, combs, and frames. A few bees cannot count for much in an apiary of "over a hundred stocks." We would,

therefore, not run any risk for the sake of saving the bees in question.

[3220.] *Bees on Cross-built Combs Transferring Themselves in August.*—Having two stocks in frame hives, on old frames with brace-combs, &c., so built that it is impossible to remove the frames, I, about ten days ago, put another body-box beneath the brood-nest, with ten frames fitted with full sheets of foundation, and stimulated by feeding with medicated syrup. I shall be grateful to hear if the bees will transfer themselves below at this late period of the year, so as to be able to destroy the old black combs. If I have done wrong, should I leave them on the old combs for the winter and transfer in the spring. The stocks are strong. Regretting having to trouble you,—T. W., *Maidstone, August 31.*

REPLY.—It is quite certain that the bees will not transfer themselves below so late in the season as the last week in August. The food given will be simply stored in the "old frames with brace-combs," on which they will winter all right, and transferring can be deferred till next spring.

[3221.] *Space Below Frames in Hives.*—I have been making twelve frame hives on the "W.B.C." plan, but with frames hanging parallel with the entrance, and now I find through some error on my part there is quite a full ½ in. space below frames, and as I cannot very well alter the body-boxes now, I ask would this make any difference, or would the bees extend the combs below bottom-bar of frames and joining them to floor-board, thereby rendering it difficult to manipulate them? If you will kindly help me in the difficulty I will be much obliged.—W. P., *Hants.*

REPLY.—A full ½-in. space below bottom bars of frames will cause no trouble at all; in fact, we would rather have a little over than under the orthodox ½ in. below bottom-bars.

[3222.] *Bumble Bees and Lime Bloom.*—Under some of the lime trees about here are a great number of dead bumble bees, most of them with the head or body eaten away, as though by birds; although, as far as I have been able to ascertain, this was done after death. Is it usual for the flower of the lime to have this toxic effect? I have found no dead hive bees, although numbers resort to the trees.—P. J. WINNER, *Congleton, Cheshire.*

REPLY.—We are not aware that feeding on the lime blossom had any such effect as you mention, though it is known that bees are frequently found on the bloom of thistles in a dazed state at night, and remain so till the warmth of next day's sun revives them and restores their activity. Is it not possible that the bees found have been caught by birds on the wing, and mutilated as in specimens?

[3223.] *Driving and Uniting Bees.*—Will you kindly advise me on the following?—I have a colony of bees in frame hive which,

however, are queenless, and have been for two months. The numbers are naturally gradually dwindling, though there is plenty of honey in the hive (nine frames of comb nearly full), in addition to which the bees have filled ten 1-lb. sections, which I have now removed. In about a week or so I shall be able to obtain a few stocks of condemned bees from cottagers' skeps, and in order to make the colony in question very strong I intend to "drive" and unite the bees from two skeps and thus to form one strong colony, as the two lots when joined will, no doubt, winter better than the bees from a single skep, leaving the few bees at present in the hive out of the question. I therefore ask:—1. When driving, if unable to see both queens, will it be safe to risk the bees settling the question themselves, as naturally I do not wish to run any risks of losing both queens in the struggle for supremacy which will naturally take place? With regard to uniting the two lots, a friend who is an accomplished bee-master will undertake that part all right. 2. Before uniting shall I place a frame of brood from my other hive into the one to receive the bees? The latter will come from a village two miles away. 3. Considering that I have only a few hundred bees in hive, will it be best to sprinkle both lots with scent before uniting, and will it be necessary to "unite" same evening. I thought it best to "drive" in evening, when all bees are at home, but it may be too dark to "unite" after a two miles walk home. I could "unite" next morning provided there was no risk with both queens remaining in skep over night. 4. I presume there would be no need to scent the two lots when "driving" into one skep. 5. If I was uniting only one colony to the frame-hive, should the skep of bees be put on top of the bars in hive and let them go down that way to hasten the process, or would you in any case advise letting the bees run in by way of the entrance? If this was done I might be able to see both queens easier if the board to run up on was a large one, or do you think the question of supremacy would have been settled during the transit.—J. H. V., *Cornwall, August 24.*

REPLY.—1. Quite safe; in fact, unless you can make choice of the best queen, it is best to leave it to be settled by "survival of the fittest." 2. If convenient, you might do this; but it is not essential. 3. Don't use scent or scented syrup at all in uniting. Dust all the bees with flour from a dredger; this is far better than scenting on the other plan. 4. No. 5. Not on any account; the driven bees in skep might be killed if this were done. Dust the bees on frames with flour, then throw the driven lot in front of entrance, and dredge them lightly with flour as they run in.

[3224.] *Is Re-queening always Necessary?*—Being a reader of your valuable BEE JOURNAL for nearly five years past, I am asking you my

first question with regard to my little apiary, consisting of half-a-dozen frame-hives. My present space does not allow of my keeping more, or else I should do so, as I find it not only a pleasant and interesting occupation, but profitable too. I have 123 finished and 50 partly-filled sections from two of my hives this year, the other four having done equally as well, only I work them for extracted honey. I am away from home more than half of my time or else I might have had still more surplus. My hives are rather large ones, made by myself, so I can enlarge the brood nest as much as is required. I have not had a single swarm for the last two years and some of the hives have not swarmed for four years past. I want to re-queen all my stocks and so ask:—When would be the best time to do so, and how would you advise being done so late in the season? I should have re-queened them before, but being away from home I could not do so. Do you advise re-queening with Italians, or is there no advantage in them over the native sort? I was rather taken up with the Italian strain on seeing some the other day. I send name, &c., whilst signing myself—QUEECRY, *Ringwood, Hants, August 25.*

REPLY.—We strongly deprecate the proposal "to re-queen all your stocks." It would be worse than foolish to do so, after your exceptional success in the present poor honey season, and the result might easily be a less satisfactory strain of bees in your apiary. Some of the stocks have doubtless re-queened themselves, and so we only advise re-queening where queens are *known* to be old and waning in their fecundity.

## HONEY EXHIBITS.

THEIR VALUE AND ADVANTAGES.

(*Read at the Minnesota Bee-keepers' Convention.*)

BY WALTER R. ANSELL.

The title of my paper might suggest that I propose telling you how to prepare for and put up a honey exhibit, but such is not my intention. I should find myself up against too many conflicting methods in the former, and for the latter I possess no qualification. I wish to touch more on the general principles of exhibits and, with a view to discussion, to suggest to you some reasons in support of my belief that honey exhibits are helpful to beekeepers, and instructive to them as well as to the general public. And I should like to invite your attention to some methods for facilitating and increasing such exhibits.

Exhibitions, besides their educational value, are very useful as advertisements, and I also want you to view them in this light. If honey could be produced as cheaply as sugar, it might sooner be classed amongst the necessities

of life, and, as such, would require no especial advertising; and even now it runs sugar so closely in price that, its superiority over the latter for many uses considered, it is conceivable that if placed prominently, attractively, and frequently before the public eye, it would not be long in commending itself more than at present to the public palate.

That is just what we want, and we must not neglect any of the means at our disposal for effecting this object. Of course, we could all sell more honey if we could get it, but I want to see both the demand and the price improve; and one will assuredly follow the other.

Without organised exhibitions the public would be dependent upon the exhibits in their local grocers' stores; alas! too often a sorry recommendation.

I want them to get to know what honey ought to be, both comb and extracted. I want them educated in a nice discrimination between clean honey and dirty honey; between thick and thin honey; between pure and adulterated honey, as you and I are educated. Then they will refuse the leaky or travel-stained combs, the thin, badly extracted or adulterated honey; a greater uniformity of excellence will result, because we shall all be on our mettle to send our honey to market in the best possible condition, and the adulterator will sooner be discovered. Then will the demand for good honey increase, and the slipshod bee-keeper or dishonest trader be left out in the cold, or have to amend his ways; and then we may confidently speculate on higher and more uniform prices.

We can also ourselves learn a great deal from honey exhibits, and, alas, for poor human nature, more especially from competitive exhibits. I have no doubt that if the number of honey exhibitors at State and county fairs could be multiplied, it would conduce to far greater excellence in all kinds and grades of honey. This, as I have endeavoured to show, would give us bee-keepers better times; and, as the prosperity of a people is made up of the prosperity of its units, so would the State be benefited.

And here I would touch on the encouragement which should be given to honey exhibits by the State. I am not competent to enter into a consideration of the objects and the means at the disposal of our State Agricultural Society. I only wish to throw out the suggestion that the more inducements they can offer honey exhibitors, the greater number of exhibitors will they attract; and, possibly, by an inconsiderably increased expense, an important advance in their objects might be achieved.

An exhibitor's expenses are not light, especially if he has to ship his honey from a distance. And when the value of his time is considered, I am not surprised that many shrink from the risk.

A fairly large exhibit can scarcely be put up

by a country bee-keeper at our State fair under an outlay for freight, cartage, and help, of about 30 dols. to 50 dols., irrespective of the bee-keeper's own time; at least, such is my own experience. Of course, we must not expect a guarantee of indemnification; I only suggest that the State might help us a little more if we are willing to help ourselves.

To those of you who have not yet become exhibitors at the State fair, let me throw out the suggestion that you just try once. Not necessarily a large exhibit, but an excellent one. You could send up a case or two of different kinds of comb honey, or a box of extracted honey in glass at the expense of about a dollar; you need not come yourself, though, of course, we should all be glad to see you, and you might gain 10 dols. or 20 dols. in premiums. Then you would come next year yourself with a much larger show, and I can assure you of a great welcome from present exhibitors.

If there were more entries made, we should certainly receive greater recognition from the Fair Committee.

As I think there must be some here who are not well acquainted with the various classes of the products of the apiary in which they can compete for premiums at the State fair, I have brought some of this year's premium lists, which are here on the table, and entirely at your disposal. Mr. Gordon, superintendent of our building, who I am glad to see is here, will, I am sure, with his usual good nature, answer any question for your guidance.

But there is another kind of exhibition which I feel sure we might try on our own account; and that is a permanent honey exhibit in the city. In fact, a Honey Exchange where honey would be bought and sold, wholesale and retail, at fixed prices for various grades of honey, with the assurance of obtaining the best possible prices, and an advance if needed. There would be full security for his honey to the producer and to the buyer for the purity of the honey. I can assure you it is no infrequent thing to see a farmer bee-keeper bring up a load of excellent honey with his team, and, after applying at two or three grocers' stores, sell the lot to one of them at 20 per cent. less than he would get if he took it to a reputable commission firm.

Or our honey exchange might take the form of a honey department in connection with some large grocery concern; and, in either case, my proposition is distinctly a business one, and one that would be readily backed by a bank.

I feel sure that if this Association would appoint a really live committee we could have a honey exchange, a permanent honey exhibit, established in time to receive next year's Minnesota crop. Branches would, of course, be established at some of the larger provincial towns to receive the near-by crop, but in all cases exhibition would be our advertisement, combination our strength, and good management our salvation.—*American Bee Journal.*

## Echoes from the Hives.

*Brook Hall, Londonderry, August 30.*—The season has been bad here, both in the lowlands and heather districts. In the latter places bees have done nothing for the last month, and the condition of those in the lowlands is not much better. Owing to this many stocks are short of stores, and require feeding, as the queens are still laying. The harvest has begun in most places, but the general outlook is gloomy. I understand the weather is even worse over in England.—  
G. F. GILLILAND.

## Bee Shows to Come.

A nominal charge of 2s. 6d. is made for notices in this column, which covers cost of insertion from order till date of show. Cash should accompany orders for insertion.

**September 5, at St. Mary's Hall, Dumfries.**—South of Scotland, B.K.A. Eleventh Annual Show of Bees, Honey, and Appliances. **Seven Open Classes**, viz.: (1) Three 1-lb. Sections. (2) Three 1-lb. Jars Extracted Honey. (3) Beeswax. (4) Complete Frame-Hive. (5) Single 1-lb. Section. (6) Single 1-lb. Jar, and (7) Single 1-lb. Sections and 1-lb. Jar Extracted Honey. Free entry in the last three classes. Schedules from S. McVie, Hon. Sec., Essex Park Cottages, Dumfries.

**September 5 to 12, at the Agricultural Hall, London.**—Honey Show in connection with the Confectioners', Bakers', and Allied Traders' (11th) Annual Exhibition and Market. Numerous classes and liberal prizes for honey and beeswax.

**September 8, at Woodstock.**—Oxfordshire B.K.A. Honey Show. Open classes (with free entry) for single 1-lb. section and single 1-lb. jar extracted honey. Prizes 7s. 6d., 5s., and 2s. 6d. in each class. Schedules from H. M. Turner, Hon. Sec., 4, Turl-street, Oxford.

**September 9 and 10, at Derby.**—Derbyshire B.K.A. Twenty-second Annual Show of Hives, Bees, and Honey on the show-ground of the Derbyshire Agricultural Society.

**September 17, 18, and 19, at Crystal Palace.**—Surrey B.K.A. Annual Exhibition of Bees, Honey, Wax, Appliances, &c. Twenty-four classes (ten open to all). Increased prizes and medals.

**September 19 to 26, at the Agricultural Hall, London.**—Honey Show in connection with the Eleventh Annual Exhibition and Market of the Grocery and Kindred Trades. Numerous classes and liberal prizes for comb and extracted honey and beeswax. **Open to all British Bee-keepers.** Special attention is directed to the new **Honey-selling Classes** with free entry. Schedules from H. S. Rogers, Secretary, Exhibition Offices, Palmerston House, Old Broad-street, London, E.C. Entries close Sept. 7.

**October 6 to 9, at the Agricultural Hall, London.**—Show of Honey and Bee-produce in connection with the British Dairy Farmers' Association. Numerous and liberal prizes for honey, &c., including the valuable Silver Challenge Cup of the B.K.A. Schedules from Mr. Wm. C. Young, Secretary, 12, Hanover-square, London, W.

## Notices to Correspondents & Inquirers.

Letters or queries asking for addresses of manufacturers or correspondents, or where appliances can be purchased, or replies giving such information, can only be inserted as advertisements. The space devoted to letters, queries, and replies is meant for the general good of bee-keepers, and not for advertisements. We wish our correspondents to bear in mind that, as it is necessary for us to go to press in advance of the date of issue, queries cannot always be replied to in the issue immediately following the receipt of their communications.

**R. TUFLY (Minchinhampton).**—*Insect Nomenclature.*—Insect sent is included in the list of those which are injurious to trees. It is the female *Giant Sirex*, and deposits its eggs in the trunk of pine or fir trees, boring a hole through the bark for the purpose. Being, as its name implies, a large insect, and the maggot or larva feeding in the solid timber, much injury is in consequence done to the trees in which the *Sirex* deposits its eggs.

**E. B. (Wakes-Colne, Essex).**—*Monthly Prices for Honey.*—The difficulty of obtaining anything in the shape of reliable monthly prices for honey is so great as to make it impossible for us to attempt to publish same in our JOURNAL.

**J. D. W. (Lower Edmonton).**—*Photos for Printing.*—Much obliged for particulars connected with interesting photos, from one of which we are having a tone-block engraved. Will send "proof" when ready (prior to insertion).

### *Suspected Combs.*

**R. R. (Cheltenham).**—1. Comb is affected with foul brood. 2. Bee sent is a queen.

**L. M. B. (Hailsham).**—There is pronounced foul brood in a good few cells, though bees were hatching out freely in others. It seems a case for getting bees off combs and treating as a swarm (if a few built-out combs are available), and feeding up after treatment, as described in "Guide Book."

### *Honey Samples.*

**J. ROWLANDS (Great Crosby).**—All six samples are good in colour and flavour, but too thin (owing to not being well ripened) for the show-bench at any other than a local show. The samples marked "Nice Blundell" are slightly better than the others, being brighter in appearance; in fact, No. 3 from Great Crosby is starting to granulate.

**J. S. (Burrow).**—Sample is fair in quality for so poor a season as this. Though by no means first-class, it is quite fit for table use at home.

**F. S. R. (Leicester).**—Like much of this season's honey, "the consistency and quality" of yours are by no means good; but being quite wholesome, it will, of course, do for table use at home where the palate is not too fastidious.

\*\* Some Letters and Queries are unavoidably held over till next week.

## Editorial, Notices, &c.

### THE CONFECTIONERS AND ALLIED TRADES' EXHIBITION.

HONEY SHOW AT THE AGRICULTURAL HALL.

The eleventh annual International Exhibition and Market of the Confectioners and Allied Trades opened on September 5 at the Royal Agricultural Hall, London, and continues till end of the present week.

As a whole, the Exhibition is a very fine one, as may naturally be expected when the amount offered in cash and other prizes reached the aggregate value of £11,000, which is claimed to be the largest amount ever offered at a trade Exhibition.

The interest of bee-keepers in the show will, of course, be centred in the honey section, admirably located on the ground floor of the Hall, and here the effects of the adverse bee-season were very evident. Admirable samples of honey were staged, both comb and extracted. But the number of entries was painfully small compared with what we hoped to see, and it will be matter of serious concern for the whole bee-industry if the directors of these exhibitions should be regretfully compelled to give up the honey section simply from lack of support. We cannot control honey seasons, and a short crop means sparse entries, but it does seem to us a little odd—in view of the good honey we know has been secured in not a few places—to find those who have it so difficult to “wake up” when a chance occurs.

To make our meaning clear, let us take the Trophy class at the show in question. There have been good exhibits of honey trophies at earlier shows in various parts of the country, and more or less of keen competition for comparatively small prizes. At the “Confectioners’” four trophies were staged, for which the combined entry fees of the four competitors amounted to 10s., and they carried off between them £10 in prizes! Not that we begrudge the reward of their enterprise, but what about the lack of support for future opportunities?

Mr. W. Broughton Carr, London, and Mr. T. J. Weston, Wickham Bishops, Essex, officiated as judges, and made the following

#### AWARDS.

*Display of Honey (comb and extracted) and Honey Products, shown in suitably attractive form for a tradesman's window* (4 entries)—1st (£4 and B.B.K.A. Silver Medal), Jas. Lee & Son, Martineau-road, London, N.; 2nd (£3), H. W. Seymour, Henley-on-Thames; 3rd (£2), R. Brown, Somersham, Hunts; 4th (£1), W. Woodley, Beedon, Newbury.

*Twelve 1-lb. Sections* (20 entries).—1st (£2 and B.B.K.A. Bronze Medal), A. W. Weatherhogg, Willoughton, Lincoln; 2nd (£1 10s.), J. Clay, Wellington, Salop; 3rd (£1), P. B. Govett, Tideford, St. Germans, Cornwall; 4th

(10s.), W. Woodley; 5th (5s.), A. Barber, Comberton, Cambs.; v.h.c., R. Brown; h.c., R. S. Marshall, Far Cross, Newcastle, Staffs; and E. C. R. White, Newton Toney, Salisbury.

*Twelve 1-lb. Heather Sections* (5 entries).—1st (£1 5s.), J. M. Balmбра, Alnwick, Northumberland; 2nd (£1), F. A. Kent, Dorchester; 3rd (15s.), J. Waddell, Wooler, Northumberland; 4th (10s.), H. Rowell, Hook, Winchfield.

*Three Shallow Frames Comb Honey for Extracting* (9 entries).—1st (£1 5s.), E. C. R. White; 2nd (£1), Jas. Lee & Son; 3rd (15s.), H. W. Seymour; 4th (10s.), F. A. Kent; v.h.c., W. Woodley; h.c., R. Brown.

*Twelve 1-lb. Jars Light-coloured Extracted Honey* (24 entries).—1st (£2 and B.B.K.A. Certificate), J. Clay; 2nd (£1 10s.), R. Brown; 3rd (£1), J. Smart, Andover, Hants; 4th (10s.), W. Patchett, Cabourne, Caistor, Lincs.; 5th (5s.), Jas. Lee & Son; v.h.c., C. H. Bocock, Ashley Apiaries, Newmarket; A. W. Weatherhogg; W. Woodley; H. Oldfield, Throapham, Rotherham; E. Warren, Tavistock; P. B. Govett; G. Jeffries, Appleshaw, Andover; and Emily Sopp, Crowmarsh, Wallingford.

*Twelve 1-lb. Jars Medium-coloured Extracted Honey* (14 entries).—1st (£1 5s.), F. A. Kent; 2nd (£1), Jas. Lee & Son; 3rd (15s.), H. W. Seymour; 4th (10s.), J. Clay; v.h.c., E. C. R. White.

*Twelve 1-lb. Jars Dark-coloured Extracted Honey* (6 entries).—1st (£1), R. Brown; 2nd (15s.), A. Barber; 3rd (10s.), H. W. Seymour; h.c., E. C. R. White.

*Twelve 1-lb. Jars Heather Honey* (6 entries).—1st (£1 5s.), T. Richards, Church Greasley, Burton-on-Trent; 2nd (£1), W. Sproston, Great Haywood, Staffs.; 3rd (15s.), E. C. R. White; 4th (10s.), Jas. Lee & Son.

*Twelve 1-lb. Jars Granulated Honey* (8 entries).—1st (£1 5s.), W. Woodley; 2nd (£1), A. W. Weatherhogg; 3rd (15s.), P. B. Govett; 4th (10s.), R. Brown.

*Beeswax in Cakes, Quality of Wax, Form of Cakes and Package, suitable for retail counter trade* (5 entries).—1st (£1), E. C. R. White; 2nd (15s.), H. W. Seymour; 3rd (10s.), Jas. Lee & Son; 4th (5s.), J. Waddell.

*Beeswax, judged for quality of wax only* (9 entries).—1st (£1), F. Harris, High Ferry, Sibsey, Boston; 2nd (15s.), W. Patchett; 3rd (10s.), Allen Sharp, Brampton, Huntingdon; 4th (5s.), J. Clay; v.h.c., H. W. Seymour.

#### HONEY-SELLING CLASSES.

*Extracted Honey in Bulk by Sample with price* (3 entries).—Certificate of merit awarded to C. H. Bocock.

*Extracted Honey in 1-lb. Jars—by Sample with price*—(6 entries).—Certificate of merit awarded to S. P. Soal, Rochford, Essex.

*Comb Honey in Sections—with price per dozen*.—Certificate of merit awarded to R. Brown.

## A WORD OF THANKS.

Under date September 7 Mr. W. Herrod writes:—"Dear Sirs,—May I use the medium of your valuable paper to express my thanks to the numerous friends who have sent their good wishes since the notice of my marriage appeared in last week's B.J.?"

I should have liked to write and personally thanked each one, but the task is beyond me while so busily occupied with the London shows at the Agricultural Hall now running. I had no idea that my friends were so numerous in all parts of the country; but if the good wishes and beautiful presents received count for anything, the life of my wife and self will indeed be a happy and prosperous one. I hope, therefore, that our good friends will accept this expression of our sincere thanks.—W. HERROD, *Old Bedford-road, Luton, Beds.*"

## Correspondence.

*The Editors do not hold themselves responsible for the opinions expressed by correspondents. No notice will be taken of anonymous communications, and correspondents are requested to write on one side of the paper only and give their real names and addresses, not necessarily for publication, but as a guarantee of good faith. Illustrations should be drawn on separate pieces of paper. We do not undertake to return rejected communications.*

*Communications relating to the literary department, reports of Associations, Shows, Meetings, Echoes, Queries, Books for Review, &c., must be addressed only to "The Editors of the British Bee Journal," 17, King William-street, Strand, London, W.C." All business communications relating to advertisements, &c., must be addressed to "THE MANAGER, British Bee Journal Office, 17, King William-street, Strand, London, W.C."*

*\*.\* In order to facilitate reference, Correspondents, when speaking of any letter or query previously inserted, will oblige by mentioning the number of the letter as well as the page on which it appears.*

## AMONG THE BEES.

## INTERCOMMUNICATION IN THE HIVE.

[5229.] In the dark interior where so many magic changes are wrought, and where so much that is germane to the well-being of the community goes on daily unobserved by the prying eyes of man, no subject is more fascinating than an observation of the "bee talks" carried on during the progress of great events. In common everyday occurrences bees seem to be so intent on duty, and so energetically engaged in the transaction of the daily dull routine that they seldom delay to give even a passing nod. Each one, even the junior member just emerged from its dark cradle bed, seemingly knows not only what to do, but how to do it, without any direction or instruction from its elders. But in the great events which mark an epoch in their life's history, more united efforts, perhaps, are necessary, when combination alone can lead to the desired goal. Then it is that we can see a

bee convention, when, by some mysterious means unknown to us, certain motions are proposed, seconded, and forthwith carried into actual accomplishment under some mystic spirit which regulates and controls the wise and prescient internal government. At first, when any hindrance or obstruction to their movements is introduced, order gives place to a species of chaos; their sensitive feelings of methodical arrangement seem outraged, and consternation follows. Soon, however, we observe a mutual intercrossing of those wonder-working antennæ. Thousands of these super-sensitive organs of touch are called into play, and a regular conversation carried on by which the whole community seems to be instructed as to the cause of the disorder, and the most effective means by which it can be remedied. Each wise little creature, acting as if one single mind directed the movements of the several thousands of units, proceeds without impeding or obstructing its fellows to do its utmost to remedy what is wrong, and restore the orderliness which is with them a second nature.

Perhaps the observation of a colony made suddenly queenless gives the best opportunity for studying this interesting spectacle. Wild alarm prevails for a time, followed by dull lethargy, and then there succeeds a wail of deep grief and sorrow, while later there ensues a frantic running to and fro, and a searching of every nook and corner. Each bee inquires "Where's mother?" and when it is found that she is really gone there strangely follows a hush of calm—not merely silence, but a silence that may be felt—while those delicate and sensitive organs deliberate about future plans on the successful carrying out of which depends the future well being and prosperity, and, indeed, the very existence of the community. Again, the teeming thousands act as if composed of "unnumbered bodies with a single mind," and each thought and aim works towards the single indispensable and necessary act of creating a queenly successor to the one who has so mysteriously disappeared.

A colony about to swarm also displays an unwonted amount of conversational crossing of those mysterious feelers, whereby it seems that the news of the projected trek is promulgated so widely that every single insect is instructed in its duty. Certain bees know that they must desert their comfortable home and give themselves up as hostages to future, wholly ignorant, and as entirely ignoring, whether the future brings them good or bad fortune; while others know that duty calls on them to remain at home to carry on the sober and serious obligations of life in the interior, now almost destitute of active movement. In each case they act as if "Theirs not to reason why," because what is for the good of the community as a whole must be for the good of each single member, or, at least, all behave as if this were really so—acting as if the post of duty were the post of honour.

When danger threatens, the well-known angry burr seems to act as the rallying cry. Irritability finds vent in this sound, which is heard only when their loved home and dear domestic hearth are threatened with invasion. The "piping" of the queen shrill and suppressed, the peculiar sound when comb-building is going on, the hum of content when any store is tapped, are only occasional interludes, and convey no general intelligence. All other sounds seem only the result of motion, so it is presumed, sagely so I hold, that the chief, and possibly the only organ of intercommunication in the way of "speech" is this mystic and magical antenna—pliable, flexible, super-delicate in the sensation of touch and feeling, directly connected with the ganglionic mass of brain matter, it seems to be a centre for generating intelligence, and carrying each thought and intent of the wise little head directly or indirectly to even the remotest corner of the hive interior.—D. M. M., *Bunff*.

#### FORMALDEHYDE.

[5230.] In reply to "A. Worker Bee" (5224, page 354), the most suitable time for fumigating combs with formaldehyde is when foul brood is in growth, *i.e.*, in the spore stage. My practice is to fume all combs removed from stocks before returning.

In using formaldehyde for fuming care should be taken to have no brood in combs, as it kills the brood, even when capped; and this brood has to be removed by the bees, which wastes a lot of time. I first remove all cappings, and if the comb contains two or three pounds of honey, I extract this. It is quite evident that I read Mr. Saunders's first letter (5212, page 336) on same, wrongly, owing to his not mentioning that he aired the combs, consequently I thought he had not done so. In reply to his letter (5225, page 354), if he will mix a little formaldehyde with twice its volume of water, and evaporate in a test tube—smelling the gas as it is evolved—it will be found that when heating the tube after the liquid has evaporated a very powerful gas is still evolved. There is also a sediment which nearly all evaporates on further heating. The same thing takes place with formaldehyde without water, only the residuum left is black. I am quite aware that formaldehyde attacks iron and steel, but only to a limited extent, and when a layer of oxide is formed on the surface of the metal it ceases to attack the metal, owing to the oxide protecting the metal. With regard to the addition of water causing the gas to polymerise, that will not injure its properties as a disinfectant, even if it did so. Acetic acid and lactic acid are polymers, and water is added to these, but does not alter their uses, and so with formaldehyde. Mr. Saunders asks, "Have I fumed combs with diseased brood pollen and heavy stores, and given them back

to the bees without a return of the disease?" Yes, I have done so. That is, I have so fumed combs, and have not so far seen any return of disease.

I have only been experimenting with formaldehyde last year and this, consequently I am not in a position to give any definite information as to results this autumn, but hope to be able to do so sometime next year. I have not been able to complete my experiments on foul brood this year owing to such a poor season, but hope to do so next, when I shall be pleased to publish them in this journal.—BLACKWOOD, Co. Durham, Sept. 7.

#### THE BEE SCOUT.

[5231.] The sentinel bee has often figured in literature, and has even attracted poetic notice in our own journal of June last, but how many writers have ventured so much as a passing remark upon the bee scout? Yet she is a living and very active reality, especially in the late summer and early autumn season, when, indeed, her attentions are apt to become more *pointed* than pleasant. There seems no reasonable doubt that the duties of the scouting bee are as clearly defined and deliberately assumed as are those of the sentinel, though the elusiveness of her movements, owing to the fact that they have to be performed on the wing, may lead to the notion that she is nothing more than a chance member of the community whose temper has become upset and habits of industry in consequence temporarily diverted from their usual peaceful course. In spring and early summer it is true her numbers are insignificant, and her special duties can then scarcely be said to have been taken up in earnest; but as the season advances the ranks of the bee scout become recruited, and their attitude towards supposed intruders more aggressive. This remark may not wholly apply to cases where undue irritation has been brought about by accident or awkward handling, but in a well-managed apiary it is interesting to note the strictly limited area within which the aggressive attentions of the bee scout are observable. Her function is to circle around within a few yards of the hive, and unless actually following up an attack, her threatening attitude is scarcely exhibited beyond the prescribed limits. To the writer it appears that the zone of the scout's greatest activity lies within a distance of perhaps from two to seven or eight yards of home, and what is more striking, she seems, as a rule, to pay little attention to anyone standing close against the hive, as, for instance, in an act of manipulation. The fact that hives are often kept close to cottage doors and much frequented garden paths without becoming sources of annoyance, need not suggest the absence or inactivity of the scout. Bees acquire with marvellous rapidity a kind of un-

conscious, but accurately familiar, knowledge of their surroundings, and those belonging to hives so placed having from the first become accustomed to moving human objects without associating them with danger, it follows that the scouting members will not readily attack such objects unless for the reasons already suggested.

In spring and early summer, when the number of scouting bees is small, the writer, when working near the apiary, has repeatedly obtained immunity from attack for the remainder of the day by simply killing two or three bees that have approached in a menacing manner. This can easily be done by standing quite still and catching them between the palms as they hover in front of the face or body. Such trifling incidents, constantly repeated, have convinced him that the duties of the scout among bees are as regularly and exquisitely ordered as are those of the better known sentinel at the hive entrance.—A. ROYDS, JUN., *Soberton, Hants, September 5.*

#### BEEES IN HERTFORDSHIRE.

[5232.] I started this season with seven frame-hives and a small hive with a spare queen, which I wintered all safe. I say "started" the season, which I consider really begins in September, and if the bees are packed down right for the winter I do not lose a stock. From the above my total year's harvest is 3 cwt. 2 qr. 8 lb. (400 lb.) in sections and extracted, and I have increased to fourteen hives, all with this year's queens; twelve of them are good working stocks, the other two being nucleus hives with young queens, in case I should lose a queen in winter. I have also two skeps with this year's queens, for which I hope to make frame-hives this winter for transferring the bees in the spring. Will you please give me your opinion on the enclosed sample of honey for the show-bench? It has been slightly heated to liquefy it, but I have some screw-caps granulated hard and white.—PONICA, *Bishop's Stortford, September 5.*

[Your sample of honey is very good in flavour and colour; the consistency is less dense than it might have been if more carefully warmed to liquefy it, but taken all round, it is a good honey and quite fit for the show-bench. In re-liquefying granulated honey, it should always be done in warm water, not by dry heat as in an oven.—EDS.]

#### VARIETIES OF HEATHER.

[5233.] I am sending three varieties of heather numbered 1, 2, and 3. Will you kindly give me names of same and which is the best for honey producing? No. 1 comes

into bloom about middle of July, No. 2 about the end of same month, and No. 3 has been in bloom about ten days now. If fine, can I expect anything from No. 3? Thanking you in anticipation.—NEW FOREST, *Hants, September 2.*

[Several other correspondents also having recently sent springs of heather bloom for identification and honey-producing qualities, we reprint the illustrations below, together



Fig. 1.—*Erica, or Calluna, vulgaris.* (Ling.)

with authoritative botanical descriptions of the three kinds of *Erica* (common heaths) usually found on the hills and moorlands of these islands. We place them in their order of merit as honey-producing plants, but bearing in mind that as *E. tetralix* (Fig. 3) grows only on damp bog-land, it cannot be regarded as of any practical value to the bee-keeper. The enlarged blossom of each variety, together with illustrations of the anther, stigma, pollina, &c., at sides of each cut, are introduced to make plainer the structural parts of the flower and its fertilisation by bees.

1. *Erica, or Calluna, vulgaris* (Ling), Fig. 1.—A low, straggling shrub, seldom growing more than a foot high. Leaves very small and short. Flowers small and of a purplish pink colour, often pale approaching to white. *Erica vulgaris* is the most widely distributed of all the heaths and very abundant.



Fig. 2.—*Erica cinerea, or Bell Heather.*

twice terminal racemes. Covering immense

2. *Erica cinerea* (Scotch Heath), Fig. 2.—More bushy and fuller than *Erica vulgaris*, leaves finer and more pointed, usually three in a whorl, with clusters of small leaves in their nails. Flowers a reddish purple, in



tracts of country on the Scotch, Irish, Welsh and some of the Western English moors.



Fig. 3.—*Erica tetralix*.

3. *Erica tetralix* (Cross-leaved Heath), Fig. 3.— Generally lower than *E. cinerea*, bushy at base; short, erect flowering bunches, leaves in form shorter and less pointed than in preceding. Flowers rather larger and more pink in colour, forming little terminal clusters or close umbels. Ranges all over Britain, and very common in the West.

By preserving these illustrations, readers

will be enabled to distinguish between the several heathers by comparing a sprig of bloom with the cuts. Elevation and soil, however, have apparently much to do with the quality of heather-honey, that from the Scottish Highlands being undoubtedly best.—Eds.]

#### A BRIEF NOTE FROM TRURO.

[5234.] In Cornwall, as elsewhere, the sky has wept copiously during the past season—indeed, we probably got more rain here than fell in the Northern or Midland districts, though we are specially noted for an extra rainfall in ordinary years. Considering the character of the season, it is amazing that the very good average of 57 lb. per hive has been secured in this district by those bee-keepers who kept their bees forward by stimulative feeding and had good queens. Others, who neglected to feed, failed to reap a satisfactory harvest.

The honey secured has been of very nice flavour, of medium consistency, and very light in colour, almost crystal; the earlier honey, however, was more highly coloured, as was also a small portion of the later, which contained a slight admixture of blackberry honey. Now that the season is over, the bees are bringing in "jam" from a neighbouring factory. I found about 8 lb. of this stored in a super which I had put on to give the bees room to live in a crowded hive.

This food asset, however, is more than counterbalanced by the number of bees which meet their doom at the factory, where they are, of course, very unwelcome visitors.

My bee-keeping friends express themselves

as well satisfied with their results in all cases where the bees were properly managed.

We have various races here: one, a rather small, quite black bee, does very well indeed; as also its hybrids, but probably our English bee does as well as any, if well managed—the great thing, as has often been remarked, is to have young queens, a matter in which a local bee-keeper of long experience quite concurs.—W. J. FARMER, *Truro, September 7.*

#### A BRIEF REPORT FROM STAFFS.

[5235.] In response to your request for brief reports as to the past honey season, I send a few lines from our district as far as I can judge from my own experience and that of others I know. The first honey extracted was very dark, though of fair flavour, and the forecast looked gloomy. Since, however, the honey has been very good in quality and light in colour. White clover bloomed abundantly hereabouts, but the weather was against the busy bee, and in consequence our "takes" of surplus have not come up to the average. It proved disappointing to myself, seeing that with plenty of built-out combs I have secured an average of 25 lb. per stock. But I am content, and better off than some, and, as usual, look forward for a better time next year. Sales are brisk. I send name, &c., while signing myself—B., *Stafford, September 3.*

#### PRONUNCIATION.

[5236.] May I ask our Editors to note an error in my communication on page 253 in last week's B.B.J. on the subject of pronunciation? The second of the two words composing the combined word Propolis should have been "polis" (a city), not "polio."

It would have been better to place the accents on the following words thus:—Bacill'us, al'vei, pröp'olis.—H. J. O. WALKER, (Lieut.-Col.), *Budleigh Salterton, S. Devon.*

#### A YOUNG BEGINNER.

[5237.] I started bee-keeping last year on the recommendation of a friend, who had kept the *busy little hummers* for about ten years and who supplied me with a stock, after I had carefully read through Mr. Cowan's valuable "Guide Book" (in parenthesis, I might say that, since my initiation into the mysteries of bee-keeping, although I have read several books on the subject, I always come back to the "Guide Book" and B.B.J. for good, sound information). Last year from my one hive I took 40 lb. of section honey; a swarm, which I purchased later, only being able to store enough for its own use for winter. This year a swarm issued from each of the two hives as early as May 22-24. One of the swarms I retained and disposed of the other. One of my

hives gave off a cast which I was unable to secure as I am engaged in the city during the day, and the only one of my household who takes a great interest in the bees is my young assistant (aged four years), whose photo I send you. But, as I have not yet educated him up to taking a swarm (or cast), he was unable to save them for me. However, he is wonderfully observant during all my manipulations of the hives, and is really of some little assistance in holding or handing me different things whilst I am working. He is not at all nervous of the *little mites of winged honey*, so that I think he has the making of a good bee-master. He was wonderfully pleased when I showed him this year's take of 115 lb. to 120 lb. in the comb and sections, and quite agreed with me that *we* had done well, notwithstanding

its medicinal properties, as well as being very palatable, and should be produced by every market-grower, whether of flowers or vegetables, while to the fruit-grower bees are absolutely essential for remunerative crops. In the economy of nature bees play an important part in fertilising flowers. Bees need no special knowledge; the beginner need serve no apprenticeship before starting; he can get plenty of people willing to assist him. The BEE-KEEPERS' JOURNAL will give gratuitous advice of a valuable character. Any intelligent person, with a determination to obtain knowledge, can in a very little time get much pleasure from the bees, and a large amount of success. Bees do not require the best soil of the garden or farm. English honey is in good demand, and is a commodity

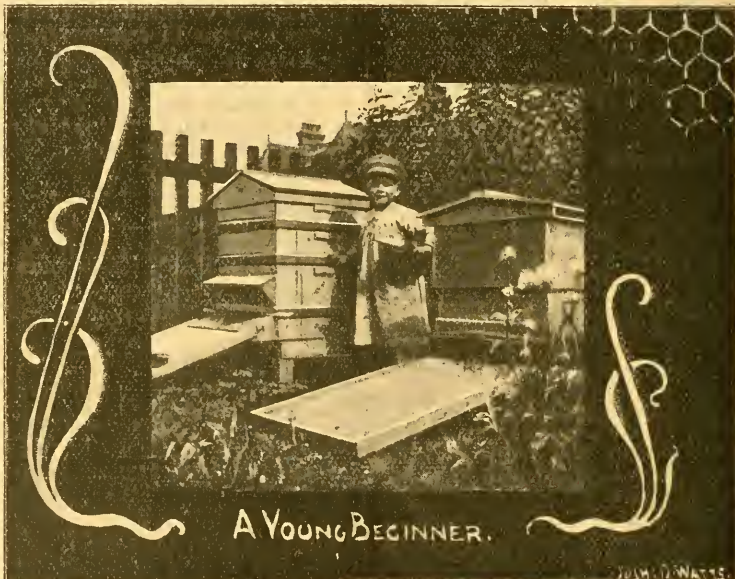

the adverse weather and the fact that both hives gave off a swarm.

In closing I have to thank you for the bright and instructive little B.B. JOURNAL, the publication of which is eagerly looked forward to each week by me. Wishing both it and its monthly cousin, the *Record*, every success.—  
JOSH. D. WATTS, Lower Edmonton.

#### HOW TO MARKET OUR PRODUCE.

At the recent show of the Horticultural Society at Terrington, Norfolk, a prize was offered for the best essay on "How to Market Our Produce." The prize was awarded to Mr. W. J. Belderson, Terrington St. Clement, an occasional contributor to our columns. After dealing with flowers, fruit, vegetables, butter, eggs, and poultry, he concludes with the following remarks on marketing honey:—

"Honey is an article useful for food and for

of which, like many others, it may be said the supply creates the demand. To be successful attention to details is necessary as in other walks of life; briefly, the necessities are a good set of appliances including an extractor and one "Guide Book." Do not have two guides; one may contradict the other and bewilder the learner. Well strain the honey; bottle it in best jars, of uniform size and shape. Always label with your own name and address, to guarantee its purity.

Sections should be well sealed, spotlessly cleansed, glazed, or put in cardboard cases. Half-filled ones should be extracted. Pack all bottles or sections in strong wood boxes, and use a good white tissue paper as well as hay, wool, or other material. Old newspaper may be cheap, but it does not look nice, while an additional 1d. per jar or section realised will more than pay for the extra cost of the material."

## WEATHER REPORT.

WESTBOURNE, SUSSEX,  
August, 1903.

Rainfall, 5.52 in.  
Heaviest fall, 1.32, on  
24th.  
Rain fell on 17 days.  
Above average, 3  
in.  
Sunshine, 216.3 hours.  
Brightest day, 7th,  
13.5 hours.  
Sunless days, 1.  
Above average, 3  
hours.  
Maximum tempera-  
ture, 73°, on 8th.  
Minimum tempera-  
ture, 42°, on 26th.

Minimum on grass,  
32°, on 26th.  
Frosty nights, 0.  
Mean maximum,  
65.6°.  
Mean minimum,  
52°.  
Mean temperature,  
58.8°.  
Below average, 0.8°.  
Maximum barometer,  
30.36°, on 26th.  
Minimum barometer,  
29.34°, on 15th.

L. B. BIRKETT.

## Queries and Replies.

[3225.] *A Novice's Troubles.*—Will you, through the B.B.J., kindly tell me where I've been wrong with regard to my bees under the following circumstances, and if not asking too much, will you put me right? In July, 1901, I got a swarm and put them in a frame-hive. The bees built a little comb, and I managed to keep them alive through the winter by feeding with sugar and candy. In the spring of 1902 they seemed fairly strong and worked well, filling up the nine frames the hive contained. I put on a rack of sections, but for a long time the bees took no notice of them. Towards the end of summer they began to draw out some of the foundation, and managed to fill one side of a single section only with honey. After removing the section-rack I fed the bees with candy through the winter. During the spring of this year they seemed very strong and worked well, but it took them up till June to fill the hive with bees and honey again, which they must have cleaned out through the winter. However, on June 26, a swarm issued, which I safely secured and put in another frame-hive. In a day or two after swarming I again put the rack of sections on the parent hive, but they have only worked a little in them up till now. The swarm seems to have filled their nine frames with comb, but will not look at the sections. This is the result of my three seasons' bee-keeping, and my questions are:—1. Should each section be divided by a small square of glass such as I have got? 2. How many frames should I leave in each hive for the winter? 3. When should sections be put on and taken off to be successful in getting bees to work in them? By giving me the desired information you will greatly oblige—A NOVICE, *Milton, near Portsmouth.*

REPLY.—It is unfortunate that your start with bees should be followed by two bad

honey years in succession, and so postpone any chance of seeing what bees can do when weather is favourable for honey gathering. It is therefore to be hoped that 1904 will make amends for the poor beginning. It seems evident, however, that you are not conversant with the needs of the bees or the methods of working modern bee-appliances, and by way of preliminary to next season's work we advise the purchase of a good text-book on bee-keeping—and study it well. You will then know "what to do and how to do it." For the rest, we reply to questions as enumerated: 1. Sections must be worked with separators of wood or metal between; the "squares of glass" mentioned are, we presume, those used for glassing the sections for sale after being filled with honey. 2. Bees are sometimes wintered on all the ten frames and sometimes on five to seven only, according to the strength of the colony. 3. When the hive is nearly full of bees and honey coming in from the fields is the time to give surplus room.

[3226.] *Troubles of "Bee Driving."*—I find much trouble when driving bees through the nuisance of "robbers," and I scarcely know how to prevent it, because the bees which are driven seem to be as big robbers as those of the untouched stocks. Can you say why this should be so?—AN AMATEUR, *Gloucester, September 7.*

REPLY.—By adhering closely to the instructions given for bee driving in "Guide Book" (page 138) there will be no such trouble from robbers as you mention. The skep to be driven is taken to a quiet, shady spot, some distance away, and an empty skep put on the old stand to receive the returning bees. So that there is nothing to induce robbing by the bees of other stocks if the driving is done quite away from them.

[3227.] *Suspected Foul Brood.*—I wrote you concerning some suspected comb, of which I sent a small specimen, but your reply (on page 348) stated that sample was too small to help in diagnosing the case. As stated in my query (No. 3209), I saw no sign of foul-brood, but I have looked at the hive again to-day, and fear that after all it may be a case of foul brood, as one or two larvæ have deliquesced. But the dead larvæ are so few in number and so scattered, that it is not possible to include more than one or two in a piece of reasonable size; and so, as I am extremely anxious, I send two standard frames of comb, and shall be most grateful if you will carefully examine them, and let me know the result. I understand that in urgent cases you are willing to "wire" reply, on receipt of stamps for cost of telegram, I therefore enclose 6d. My apiary now contains fifteen stocks, which I have been acquiring during the past four years, with a view to making a small business of bee-keeping, and have spent a good deal of money and time over it, and I am willing to take any pains to stamp out the disease if

it should be present, but as it is getting so late in the season there is no time to be lost. I have been a regular subscriber to the B.B.J. since I began bee-keeping.—S. K. S., *Birmingham, September 3.*

REPLY.—As already notified by "wire," we find no disease in the widely-scattered sealed cells in frames of comb sent. Consequently, there is no reason for alarm with regard to the healthy stocks. It may be well, however, to keep a watchful eye on the brood of stock in question when breeding starts next year.

[3228.] *Moving Hives to Improved Bee Pasturage.*—I should be glad if you would kindly let me have a reply to the following in the BRITISH BEE JOURNAL:—For some years I have kept a few hives of bees in Beckenham, Kent. I am now thinking of going in for bee-keeping on a somewhat larger scale, and should be glad if you would tell me what district within ten or fifteen miles of Beckenham would be the most profitable for small bee farm? Would Shirley Hills (heather) be suitable, or could you recommend a better place? Also, do you consider that by thus moving my hives I should obtain substantial increase of honey?—J. R. T., *Beckenham, September 7.*

REPLY.—To have an apiary located in a good honey district means all the difference between success and failure, and there lies within fifteen miles of Beckenham some good bee-pasturage, such as would add considerably to the amount of surplus honey likely to be gathered by the bees. The country between Orpington and Sevenoaks would be a favourable location, we should say.

[3229.] *Feeding Bees for Completing Sections.*—This has been a miserably wet season for honey-gathering, so that the heather crop has been a failure through the heavy rains. In consequence of all this I have a lot of unfinished or partly sealed sections on each hive, and there is little prospect of weather improving. I therefore ask: Should I give my bees a little syrup in order to get them to finish sealing the sections? They are all drawn-out and nearly full of honey. I have not an extractor, and would therefore like to have them finished.—CAIRNBAUN, *N. B., September 7.*

REPLY.—In the first place, it is against all honest bee-keeping to give bees sugar-syrup with the object of completing sections or supers of comb-honey. It has also been found that feeding bees in order to fill supers is an unprofitable game to play. You had better spend 3s. 6d. in the purchase of a small extractor suitable for sections, and remove the contents to sell as liquid honey. It will save you cash, labour, and good name to do so.

[3230.] *How to Preserve Queens of Driven Bees.*—I shall be driving a lot of skeps thi-

month, and I will be glad to know how to treat and carry home young queens. I want to ward off chills on one hand and prevent suffocation on the other, and so ask: Can queens be carried in my vest pockets without harm? I send name.—MELOR, *N. Wales.*

REPLY.—If you possess an ordinary queen "introducing cage" it needs only to put half-a-dozen or so workers along with queen, and a tiny bit of comb with a cell or two of food, to make safe a young queen for several hours, if carried in the inside breast-pocket of coat. Some carry queens alone safely in a matchbox in waistcoat-pocket.

---

## Echoes from the Hives.

---

*Icombe, Gloucester, September 7.*—The present season for honey-gathering has been prolonged beyond any in my experience, or that I can remember. I have a 15-acre clover field which, although it has been first "folded off" by sheep and then mown for hay, is now a mass of white blossom, in which the local bees have been revelling as if it were June during the very few hours of sunshine lately. Notwithstanding the terribly wet summer, I believe that bees around here have done fairly well. I made artificial swarms from each of my three stocks. They have produced 66 lb. of comb-honey, and the six have 50 lb. each of stores, which may go to prove that the three stocks would have produced 52 lb. each of comb-honey had they not been swarmed.—AN AMATEUR.

---

### PREVENTION OF SWARMING

WHEN WORKING FOR EXTRACTED HONEY.

It is asked in *Gleanings*, how swarming can be prevented if the colony is worked for extracted honey, and whether the forced-swarm method can be used or not. I know a number of plans for this purpose, and which one will be the best, depends upon the location.

I use very large hives, and they prevent swarming to a great extent, but not under all circumstances. In my locality the bees commence breeding early, and it depends on the condition of the spring at what time the colony will develop to their full strength. As soon as the main honey-flow commences, all danger of swarming is past. This is so in every location if the honey-flow is fast and good, while a slow flow is favourable to swarming. During a poor spring my colonies develop slower, and the queen is increasing egg-laying till the main flow commences; consequently, I get no swarms from the large hives, while ten frame-hives may swarm a short time before the honey-flow. During a favourable spring the colonies

develop much faster, and sometimes I found that a month or more before the main flow some of the queens laid 4,000 eggs daily with a light honey-flow still continuing. Under such circumstances this colony will soon swarm, even if kept in the largest hive. In this case I use artificial increase, and use the plan recommended by Doolittle. Brush or shake colony A on empty combs or foundation on the old stand (for comb-honey on starters). The brood-combs, without any bees, are set on the place of colony B, and this receives a new stand, C. A fertile queen is introduced to B, or if such is not on hand, a ripe queen-cell. Under such circumstances these three colonies will give more surplus honey than two colonies if we had them undivided.

I never extract any unripe honey or any honey from the brood nest, but always give plenty of super room. During a light honey-flow the bees will carry the honey to the supers to make room for the brood. The fast and good honey-flows contract the brood nest; if not enough supers are given.

If the colonies are getting of such a strength that swarming is to be expected for some days before the main flow commences, or if the main flow is not so good as to prevent swarming, other plans can be used.

1. If queen cells are already started we can easily tell when the first cell will be capped; then it is time to manipulate. We remove the hive from the old stand a few steps, and set in its place a hive with empty combs or foundation. From the brood-combs the most of the bees and the queen are brushed or shaken into, or in front, of this hive with the empty combs. The brood-combs and some of the bees which remain on them are returned into the old hive, and this is set close to the side of the other hive. (It can be set on top or behind it just as well.) As this colony will remain weak for some time, the first queen which hatches will destroy the other cells. Now we can unite again. Of course, one of the queens must be removed. If we are willing to remove the virgin queen, it is not necessary to hunt her up. At evening the places of the two colonies are changed. One hour later, when the bees have ceased to fly, we change the places again. The old bees which have entered the hive with the young queen, will kill her during the night in nine cases out of ten. (It is a case of handling hives instead of frames.) The next day this colony is set on top of the forced swarm, a wire cloth between the two, which can be removed six hours later. The whole manipulation is finished in six or seven days.

2. If no queen-cells are started, the first young queen will hatch in ten or twelve days. During this time the colony will get strong, and very probably would send out an after-swarm. Some of the bees will be old enough to do field work, and could work to better advantage in the forced swarm, which is now getting weaker every day. For this reason we remove the

colony with the queen-cells in about eight days to the other side of the swarm, and, if necessary, we brush or shake some of the bees in front of the swarm. As soon as the queen-cells are destroyed we unite again as above.

3. We find the queen of the colony, and set one brood comb with the adhering bees—but *without* the queen in the hive A—on the old stand; about half of the bees are shaken into this hive. The other brood combs, with the queen, are placed in hive B, on the side of hive A. B is hereby weakened so much that the queen-cells are destroyed by the bees in about five or six days. Now we destroy all the queen-cells in hive A, and about half an hour later the two colonies are united as above. This plan takes less time; but the old queen must be found, and a strong swarm on the old stand will do better in honey gathering than this colony without a queen.

4. A few days ago I received a letter from a bee-keeper in California, in which he gives another plan, which I think is worth experimenting with. With some modifications the plan is as follows:—We make a forced swarm as at one and two. On top of this story we set a board with openings closed by double wire screens; the hive with the brood-combs, and enough bees to protect the brood on top of this. If no ripe queen-cell is on the combs, such a one can be introduced. This hive has its separate alighting-hole. When the young queen is out she will get fertilised over the double screen. Now the two colonies can be united again by removing the board. As they have the same scent this will not be difficult. One of the queens will be killed by the bees. Whether this will always be the old one, as my correspondent hopes, or not, I am not able to tell; but it seems probable to me. This plan can probably be used when comb-honey in sections is produced.

In this way the forced-swarm method can be used for extracted honey, and can be done with less trouble than for comb-honey, as the old combs can be used. In my locality I do not need such manipulations. Either I get no swarms at all from my large hives, or I increase my colonies some time before the main honey-flow, making three out of two *à la* Doolittle. If more increase is wanted the following is a good plan in my locality in a favourable spring.

Some colonies are divided into small nuclei, giving a ripe queen-cell to every one. From the other colonies forced swarms are made as above. Eight days later, all the bees are shaken and brushed to the swarm from the brood-combs. These contain now capped brood only, and are used for strengthening the nuclei. Of course, the queen-cells on them must be destroyed. With such brood-combs containing capped brood, a small nucleus can be raised to a strong colony in about two weeks.

I could give the reasons for all these pro-

cedures, but our "practical" bee-keepers and editors do not like "theory," and I have learned that our best men cannot understand "theory" from lack of preliminary knowledge, so I had to be very prolix and take much space. For this reason we continue to manage our bees according to "prescriptions," and without knowledge. If the conditions are somewhat different, then prescriptions are "no good." Please do not blame me.—L. STACHELHAUSEN in *Gleanings* (American).

## Bee Shows to Come.

A nominal charge of 2s. 6d. is made for notices in this column, which covers cost of insertion from order till date of show. Cash should accompany orders for insertion.

September 17, 18, and 19, at Crystal Palace.—Surrey B.K.A. Annual Exhibition of Bees, Honey, Wax, Appliances, &c. Twenty-four classes (ten open to all). Increased prizes and medals.

September 19 to 26, at the Agricultural Hall, London.—Honey Show in connection with the Eleventh Annual Exhibition and Market of the Grocery and Kindred Trades. Numerous classes and liberal prizes for comb and extracted honey and beeswax. Open to all British Bee-keepers.

October 6 to 9, at the Agricultural Hall, London.—Show of Honey and Bee-produce in connection with the British Dairy Farmers' Association. Numerous and liberal prizes for honey, &c., including the valuable Silver Challenge Cup of the B.B.K.A. Schedules from Mr. Wm. C. Young, Secretary, 12, Hanover-square, London, W.

### IMPORTANT NOTICE.

REMOVAL OF "BRITISH BEE JOURNAL" OFFICES.

Owing to expiration of lease the offices of the BRITISH BEE JOURNAL and the *Bee-keepers' Record* will, at the end of the present week, be removed to larger and more convenient premises, No. 10, Buckingham-street, Strand, about fifty yards from Charing Cross Station. All communications must therefore be addressed as above.

The new premises are on the ground floor, and being only two minutes' walk from our present offices, no difficulty will be experienced in reaching the new address.

### Notices to Correspondents & Inquirers.

Letters or queries asking for addresses of manufacturers or correspondents, or where appliances can be purchased, or replies giving such information, can only be inserted as advertisements. The space devoted to letters, queries, and replies is meant for the general good of bee-keepers, and not for advertisements. We wish our correspondents to bear in mind that, as it is necessary for us to go to press in advance of the date of issue, queries cannot always be replied to in the issue immediately following the receipt of their communications.

\*.\* We are requested to ask if any reader with experience of the country round Southampton will be good enough to furnish information as to whether that district is favourable to bee-keeping. Also, will any bee-keeper who has tried the sections

(formerly made by a Northampton naturalist, who dealt in bee-appliances, I believe) with glass in grooves in each side of the section, in place of the ordinary divider, say whether such sections are a success?

\*.\* *Scotch Heather Honey*.—Referring to the notification on page 349 of B.B.J. for August 27, we are obliged to several correspondents for writing and have forwarded their communications to the proper quarter.

HOLMAN (Penarth).—*Feeding Driven Bees on Unrefined Sugar*.—If by "dark pure cane-sugar as used by jam-makers" is meant raw, unrefined sugar, it should on no account be used for building up stocks from driven bees in autumn. Only white crystals, from which the molasses—or treacle—have been removed by refining, are suitable for the intended purpose. Raw sugar is too relaxing to be wholesome for bees during the long confinement of winter.

THOS. PEARSON (West Cumberland).—*Honey Presses*.—We think Mr. W. P. Meadows still makes the "Garstang" press; but as a marked advance has been made in this appliance since the "Garstang" came out, we are not sure who still stocks the latter machine.

A. W. C. (Chingford).—*Raw Sugar for Bee-Food*.—The sample sent (unrefined Mauritius cane-sugar) is quite unsuitable for making syrup-food for bees; in fact, the sample of syrup sent made from it is more like black sweetened water than bee-syrup.

W. C. (Pewsey, Wilts).—*Exams. for Experts' Certificates*.—Particulars regarding these can only be had from Mr. Edwin H. Young, Secretary B.B.K.A., 12, Hanover-square, W. The exams. for 1903 are, however, now nearly over for the year.

#### *Suspected Combs.*

M. J. (Hailsham).—Comb contains chilled brood only; no disease. Any frames containing dead brood should be removed and replaced by the drawn-out combs you have on hand.

W. D. (Nuneaton).—Brood in comb is chilled only, nor does there appear to have been any disease in hive from which the bees have died.

#### *Honey Sample*

S. S. (Lincs).—1. The sample is, we think, rather light in colour for "medium" class, but it is difficult to judge from a sample under 2 oz. The "colour grading" glasses issued by the B.B.K.A. may be had for a few coppers on application to the Secretary, Mr. Edwin H. Young, 12, Hanover-square, W., and thus "colour" could be decided with accuracy. 2. The "special flavour" is a rather unpleasant one, which tends to spoil a good clover honey as sample is, but for the flavour referred to by yourself. 3. Yes. 4. It is worth sending to show in question, but could hardly win in an average competition.

## Editorial, Notices, &c.

### OXFORDSHIRE B.K.A.

#### HONEY SHOW AT WOODSTOCK.

The above show was held in conjunction with the annual exhibition of the Agricultural Society on September 8.

One of the chief attractions was the honey show of the Oxfordshire Bee-keepers' Association, a space of 20 ft. being devoted to the exhibits. It is several years since the association was in a position to hold a show, but the revival was fully justified by the excellence of the exhibits, and, despite a cold, wet, and unfavourable season generally, there was a really first-class display of honey. There were six classes for honey and wax, all of which received good support, the greatest number of entries being forthcoming for a single jar of extracted honey. Mr. C. N. White, St. Neots, Hunts, was appointed by the B.B.K.A. as judge of the Bee department.

Mr. White also conducted an examination of candidates for the expert's certificate of the British Bee-keepers' Association. The practical work was done in the apiary of his Grace the Duke of Marlborough, and the thanks of the association are due to Mr. Garrett, the head gardener, for the kind assistance he gave to the committee.

The awards were as follows:—

*Twelve 1-lb. Sections.*—1st, J. Turney; 2nd, Mrs. Wastie.

*Twelve 1-lb. Jars Extracted Honey.*—1st, C. J. Eden; 2nd, P. Scarsbrook, Kirklington; 3rd, J. Turney.

*Three 1-lb. Sections and Three Jars Extracted Honey.*—1st, Thos. Axtell, Yarnton; 2nd, Isaac Axtell, Yarnton; 3rd, Thos. Harris.

#### OPEN CLASSES.

*Single 1-lb. Section.*—1st, W. Patchett, Cabourne, Lincs.; 2nd, T. E. Harris, Steeple Aston; 3rd, Mrs. Barnes, Banbury.

*Single 1-lb. Jar Extracted Honey.*—1st, W. Patchett; 2nd, T. G. Hillier, Hurstbourne, Hants; 3rd, T. Thompson, Binbrook.

#### MEMBERS' CLASSES.

*Six 1-lb. Jars Extracted Honey.*—1st, J. Vernon, Stoke Talmage; 2nd, P. Scarsbrook; 3rd, Mr. Hancox, Deddington.

*Six 1-lb. Jars Light-coloured Extracted Honey.*—1st, R. T. Foster, Stokenchurch; 2nd, H. Edgington, Goring Heath; 3rd, R. Allen, Tusmore; v.h.c., H. M. Turner, Northleigh.

*Six 1-lb. Sections.*—1st, R. Allen; 2nd, G. Jordan, Steeple Aston; 3rd, T. E. Hancox, Steeple Aston; v.h.c., C. James, Hardwick; h.c., W. G. Worth, Oxford.

*Beeswax.*—1st, P. Scarsbrook; 2nd, C. T. Edens; 3rd, H. Edgington.—(Communicated.)

### DERBYSHIRE B.K.A.

#### ANNUAL SHOW.

The twenty-second annual show of bees, honey, &c., of the Derbyshire Bee-keepers' Association was held in the Cattle Market, Derby, in connection with the Derbyshire Agricultural Societies annual County Show on September 9 and 10.

There was a good display of honey both in the local and open classes, and some very good exhibits were staged. The five trophies were a distinct feature of the show, and the winner of the silver Challenge Cup had taken special pains with his exhibit, while the arrangements for the display of all the exhibits left nothing to be desired.

The duties of judge in the bee section were undertaken by Mr. P. Scattergood, Stapleford, Notts, and Messrs. Burgin and Rowland ably officiated as stewards of the department. The following were the awards:—

*Unicomb Observatory Hive with Bees and Queen.*—1st (15s.), A. H. Dawson, Burton; 2nd (10s.), J. Pearman, Derby; 3rd (5s.), T. Richards, Church Gresley.

*Observatory Hive with Bees and Queen.*—1st (15s.), J. Spencer, Ashleyhay; 2nd (10s.), S. Durose, Burton; 3rd (5s.), J. Bakewell, Burton.

*Trophy of Honey in any Form.*—1st (challenge cup and 10s.), J. Pearman; 2nd (7s. 6d. and silver medal D.B.K.A.), S. Durose; 3rd (7s. 6d. and bronze medal D.B.K.A.), J. Spencer; 4th (7s. 6d. and certificate), H. Hill, Ockbrook; 5th (2s. 6d.), T. Austin, Alvaston.

*Twelve 1-lb. Sections.*—1st (10s. 6d. or silver medal D.B.K.A.), J. Stone, Cubley; 2nd (7s. 6d.), J. Pearman; 3rd (5s.), T. Richards.

*Twelve 1-lb. Jars Light Extracted Honey.*—1st (10s. 6d. or silver medal D.B.K.A.), T. Duckmanton, Langwith; 2nd (7s. 6d.), A. H. Dawson; 3rd (5s.), S. Durose; v.h.c., J. Pearman.

*Twelve 1-lb. Jars Dark Extracted Honey.*—1st (10s. 6d. or silver medal D.B.K.A.), T. Richards; 2nd (7s. 6d.), S. Durose; 3rd (5s.), H. Hill.

*Exhibit of Honey Products.*—1st (7s. 6d.), J. Bakewell; 2nd (5s.), J. Pearman.

*Beeswax.*—1st (7s. 6d.), J. Pearman; 2nd (5s.), H. Hill; 3rd (2s. 6d.), J. Spencer.

*Exhibit of Run Honey (labourers only).*—1st (5s. and silver medal D.B.K.A.); 2nd (5s. and bronze medal D.B.K.A.); 3rd (5s. and certificate).

#### OPEN CLASSES.

*Twelve 1-lb. Sections.*—1st (5s. and silver medal D.B.K.A. or 15s. 6d.), A. Weatherhogg, Lincs; 2nd (10s.), W. Patchett, Lincs; 3rd (5s.), W. Ratcliffe, Barthomley; 4th (2s. 6d.), G. Hills, Comberton.

*Twelve 1-lb. Jars Extracted Honey.*—1st (5s. and silver medal D.B.K.A. or 15s. 6d.), W. Patchett; 2nd (10s.), T.

Holdsworth; 3rd (5s.), R. Brown, Somersham; 4th (2s. 6d.), F. Powers, Andover.

*Twelve 1-lb. Jars Granulated Honey.*—1st (10s. 6d.), A. H. Dawson; 2nd (7s. 6d.), S. Durose; 3rd (5s.), J. Stone; 4th (2s. 6d.) J. Berry, Llanrwst, N. Wales.

*Single 1-lb. Section (entry free).*—1st (4s.), A. Weatherhogg; 2nd (3s.), W. Patchett; 3rd (2s.), J. Stone.

*Single 1-lb. Jar Extracted Honey (entry free).*—1st (4s.), T. Hillier, Andover; 2nd (3s.), W. Hatliff, Lincs; 3rd (2s.), W. Patchett.

*Collection of Appliances.*—1st (£2), R. H. Coltman & Co., Burton-on-Trent.—(Communicated.)

## NOTTS. BEE-KEEPERS' ASSOCIATION.

### ANNUAL SHOW.

The above show was held at Moorgreen on September 8 in connection with that of the Agricultural and Horticultural Societies. Unfortunately, the day was a very wet one, but in spite of this some thousands of people were present. Mr. P. Scattergood, Stapleford, was the judge, assisted by Mr. R. J. Turner, Ratcliffe-on-Trent, and their awards were as follows:—

*Collection of Hives and Appliances (1 entry).*—No 1st prize awarded; 2nd (£1), G. H. Varty & Co., Colwick.

*Complete Frame Hive for General Use (1 entry).*—1st (10s.), G. H. Varty & Co.

*Trophy of Honey in any Form and of any Year (2 entries).*—1st (15s. and N.B.K.A. silver pendant), Geo. Hayes, Beeston; 2nd (10s.), G. Marshall, Norwell.

*Six 1-lb. Jars Light-coloured Extracted Honey (19 entries).*—1st (10s. and B.B.K.A. silver medal), Geo. Hayes; 2nd (5s.), G. H. Pepper, Farnsfield; 3rd (2s.), Miss H. Bingham, Clipstone; h.c., Miss E. de J. Morris, Worksop.

*Six 1-lb. Jars Dark-coloured Extracted Honey (12 entries).*—1st (10s. and B.B.K.A. bronze medal), Miss H. Bingham; 2nd (5s.), Geo. Hayes; 3rd (2s. 6d.), G. Marshall; h.c., J. Bee, Southwell.

*Six 1-lb. Sections (6 entries).*—1st (7s. 6d.), Geo. Marshall; 2nd (3s. 6d.), G. H. Pepper.

*Six 1-lb. Jars Granulated Honey (11 entries).*—1st (7s. 6d. and B.B.K.A. certificate), Miss H. Bingham; 2nd (5s.), A. G. Pugh, Beeston; 3rd (2s. 6d.), H. Merryweather, Southwell.

*One Shallow Frame of Honey for Extracting (3 entries).*—1st (5s. and N.B.K.A. silver pendant), G. H. Pepper; 2nd (2s. 6d.), G. Marshall; h.c., Jesse Smith, Kimberley.

*Six 1-lb. Jars Extracted Honey (novices, 3 entries).*—1st (7s. 6d.), G. Hopkinson, Newark; 2nd (5s.), R. C. Cooper, Eastwood; 3rd (2s. 6d.), P. Francis, Dunham.

*Six 1-lb. Jars Extracted Honey (local class, 3 entries).*—1st (7s.), G. M. Bolton, Eastwood; 2nd (4s.), W. Brooks, Eastwood; 3rd (2s.), R. C. Cooper.

*Honey Vinegar (1 entry).*—1st (3s. and N.B.K.A. certificate), Geo. Hayes.

*Observatory Hive with Bees and Queen.*—1st (15s.), R. Mackender, Newark; 2nd (10s.), H. Mackender, Newark; 3rd (7s. 6d.), D. Marshall, Cropwell Butler; 4th (5s.), Cecil Hayes, Beeston; h.c., G. Hopkinson, Newark.

*Beeswax.*—1st (7s. 6d.), G. A. Hill, Balderton; 2nd (5s.), Geo. Hayes.—(Communicated.)

## HONEY SHOW AT BRAMHALL.

The Bramhall and Woodford Horticultural Society held their fourteenth annual show on September 5 in the archery ground at Bramhall Hall, by permission of Charles H. Nevill, Esq., J.P.

There was an admirable display of plants, vegetables, fruit, and honey, and the show being favoured by fine weather, the attendance was very good.

The exhibits in the honey section were less numerous than usual, but the quality was above the average.

Mr. W. Bradburn, Brooklands, officiated as judge of honey and wax and made the following awards:—

*Twelve 1-lb. Sections (open).*—1st, Wm. Ratcliffe, Barthomley, Crewe; 2nd, J. Pearman, Derby.

*Twelve 1-lb. Jars Extracted Honey (open).*—1st, J. Pearman; 2nd, Stanley Wright, Macclesfield.

*Twelve 1-lb. Sections (local).*—No entry.

*Twelve 1-lb. Jars Extracted Honey (local).*—1st (and C.B.K.A. bronze medal), J. Turner, Bramhall; 2nd, Percy Bell, Davenport; 3rd, Mrs. Bull, Bramhall.

*Beeswax (local).*—1st, J. Turner; 2nd, W. J. Sharratt, Bramhall.—(Communicated.)

## BEE-PARALYSIS.

### SULPHUR CURE A SUCCESS.

Writing to the editor of *Gleanings*, Dr. C. C. Miller says:—

“MR. EDITOR,—I take pleasure in forwarding to you a letter received from O. O. Poppleton, and although intended only as a private letter, it is of such general interest that I am sure my good friend, Mr. Poppleton, will forgive me for giving it entire to your readers.”

The letter of Mr. Poppleton referred to reads as follows:—

“Dade Co., Fla., July 11, 1903.

Dr. C. C. Miller, Marengo, Ill.

MY DEAR FRIEND,—Will you grant me the privilege of hinting at a change which ought to be made in some of the answers to questions you have made within the last few months? I refer to the idea that there is no cure known for bee-paralysis, &c.

There is a certain cure known for the disease, one described by myself several years ago in the *Review*, and a couple of years



ago in the *American Bee-keeper*. I enclose a copy of the latter, which you will see touches on all the points raised by inquirers and writers in the *American Bee Journal* and *Gleanings* within the last few weeks.

Please notice how extensive my experiments were—some forty or fifty cases cured with considerably over a hundred untreated cases under observation; also the careful, thorough manner of conducting the experiments, by treating only a few cases at a time, and comparing them with other still untreated cases; then treating a few more at a time, and so on until all were cured. The result of this careful work was that every treated colony recovered in about the same number of days after treatment, while *all* the others remained diseased until treated. Handling as directed in the article prevents all loss of brood or brood-combs, and is a very important point.

If the condition of my eyes would allow, I would gladly write an article on this subject for either of the papers, which would fully answer all the inquiries lately made. In lieu of that I thought that perhaps calling your attention to what is already in print would give you a chance to help any future inquiries.—O. O. POPPLETON."

Mr. Poppleton's article, as it originally appeared in the *American Bee-keeper*, giving in full his treatment of the disease (somewhat condensed), reads as follows:—

"I promised some time ago that as soon as I knew the result of certain experiments not then finished, I would write out some of my experiences with bee-paralysis in my apiary.

The disease itself is exceedingly erratic—comes and goes without any apparent cause, and without strictly following any rules. Colonies in perfect health will sometimes be attacked suddenly, and in a very short time be reduced to a nucleus. At other times a diseased colony will suddenly recover without any known cause. For this reason no rule can be made by experiments with any one or even a few colonies. And now, after a personal experience with over 200 diseased colonies, I more than ever realise how little we really know of the nature, causes, prevention, or of the disease. While I am satisfied that it is to a limited extent contagious, I do not know exactly how the contagion is communicated. Last season I made some experiments to learn whether combs, honey, or brood carried it, by taking away all the brood from what diseased colonies I had, and giving them to certain nuclei. I built up six nuclei by giving them brood from diseased colonies, and so far (nearly a year afterwards) only one of these six colonies has shown any signs of the disease.

As several other colonies have taken the disease this spring, it is not very likely that this one took it because of these combs of brood and honey. That five out of six failed to take the disease after nearly a year has passed looks as if it will be safe to use all

combs of either honey or brood. This simplifies the problem of what to do with diseased colonies, and saves the loss of combs and brood, as in the cases of foul-brood.

Several years ago, nearly or quite one-third of my apiary was diseased, and the prospect was that I might have to abandon bee-keeping because of it, after nearly half of the diseased colonies had died. Experimenting with all the methods of cure I could hear of, the use of sulphur proved the only method of any value. This I applied to three or four colonies at a time, then in a few days to a few more. Then, after an interval, to more, and so on, until all had been treated. The result was the entire cure of each colony treated in the order of their treatment, while not a colony in the yard recovered until a certain time after treatment, showing conclusively that it was the treatment which effected the cure. I have used the same method more or less since then, but not to so great an extent. Out of some forty or fifty altogether which I have treated, all were cured by one treatment except three, which required a second trial each. As many have reported failures in treating diseased colonies with sulphur, it looks as if they must have misapplied the sulphur some way, and I think it will be best to give in detail the way I have used it.

I go to the diseased colony during the day, and take away all the combs containing brood, or at least unsealed brood or eggs, and give to some other colony; then when the bees have quit work for the day I proceed to dust sulphur over every comb in the hive, and, if possible, on every bee in the hive, using about a teaspoonful of sulphur to every three or four combs in the hive.

I do the work by taking what sulphur I can hold between my thumb and first two fingers and dusting same over first one side and then the other of each comb, bees and all. My aim is to have a thin dusting of the sulphur over every bee and every comb in the hive. The thinner the dusting the better, so it reaches everything in the hive. I carry back to the hives the same number of combs and brood as I have taken away.

The reason for taking away brood before dusting the combs, and returning again afterwards, is because the dusting not only kills all unsealed brood in the combs, but ruins the combs for brood-rearing. If such combs are left in the hive, all eggs deposited in them will hatch out all right, but the larvæ will die as soon as hatched. By giving these same combs to strong colonies, they will clean them out and use them all right, and no loss of combs or brood will result.

For a week after dusting a diseased colony with sulphur, fully as many or more bees will be dying as before the dusting; and this fact may lead some to think the 'cure' is not a cure. It will take a couple of weeks before one can tell whether the treated colony is cured or not.

Diseased colonies are usually very weak in numbers after being cured, and are of very little, if any more, value than a good nucleus. I have doubts whether it really pays to cure them, except such as can be treated very early in the season, before nuclei can be profitably made. For the last year I have adopted the plan of curing such colonies as needed it as early as the middle of February, or even earlier; after that I make as many nuclei as are needed for the purpose, and as soon as they have a young laying queen I take away the combs from the diseased colonies, giving the brood to these nuclei, thus building them up into good colonies, and destroy all the diseased bees with sulphur fumes.

In changing combs from diseased to other colonies, I am very particular to know that each comb is absolutely free from bees, especially of dead ones that may be in some empty cells. Diseased bees quite often crawl into empty cells to die.

### HONEY IMPORTS.

The value of honey imported into the United Kingdom during the month of August, 1903, was £3,433. — *From a return furnished to the BRITISH BEE JOURNAL by the Statistical Office, H.M. Customs.*

## Correspondence.

*The Editors do not hold themselves responsible for the opinions expressed by correspondents. No notice will be taken of anonymous communications, and correspondents are requested to write on one side of the paper only and give their real names and addresses, not necessarily for publication, but as a guarantee of good faith. Illustrations should be drawn on separate pieces of paper. We do not undertake to return rejected communications.*

*Communications relating to the literary department, reports of Associations, Shows, Meetings, Echoes, Queries, Books for Review, &c., must be addressed only to "The Editors of the 'British Bee Journal,' 10, Buckingham-street, Strand, London, W.C." All business communications relating to advertisements, &c., must be addressed to "THE MANAGER, 'British Bee Journal' Office, 10, Buckingham-street, Strand, London, W.C."*

*\*.\* In order to facilitate reference, Correspondents, when speaking of any letter or query previously inserted, will oblige by mentioning the number of the letter as well as the page on which it appears.*

### NOTES BY THE WAY.

[5238.] Work in the apiary will now mainly consist of preparation for the coming winter. In attending to this, first see that every colony has a prolific queen; second, that there are sufficient stores in the brood-combs to carry the bees through the winter months; third, provide winter-passages by laying three strips of wood,  $\frac{1}{2}$  in. thick and tapered off at the ends on top-side of each piece to a thin wedge, across the brood-nest on top of frames. This allows the quilts to lay flat on the frames round the outsides and prevents a current of air passing through the brood-nest. Finally,

reduce the entrance of hives to 1 in. or  $1\frac{1}{2}$  in., to afford the bees a better chance of defence against robber bees or wasps.

We are often told or reminded that the honey our bees gather costs us bee-keepers nothing, but I think most, if not all, of us are of a very different opinion. At least, we contend that if the nectar of flowers is obtained free of cost, like the air we breathe, the collection of that nectar and the conversion of it into honey by the bees is a somewhat expensive process. In other words, it will be now some nine months before a single pound of honey of 1904 will be obtainable, and meantime we shall be preparing for the ingathering of that pound of honey—spending money on bees, queens, and bee-food, giving careful attention and considerable time to the requirements of each individual colony of bees, in order that we may secure it. But throughout those intervening nine months our apiary and its inmates will require much care in order to prevent the intrusion of outside enemies to the bees when in a semi-dormant condition. We have also to guard against the rigours of winter and the fury of the elements, and our solicitude for the continued well-being of the bees—such as a further supply of food in the shape of a section of honey or a cake of candy, if required, and a dry wrap or cushion if dampness invades the hive. I could mention many other items, but these suffice to show that if we had to hire our districts of forage the little profits of our industry would be swallowed up, and bee-keeping on commercial lines would cease to exist.

Reducing the number of frames in hives during the winter months has been recommended by many in the past; but for myself, I may say it is many years since I removed a frame in the autumn to contract the size of brood-nest. Years ago I followed the advice, but only once or twice, as the combs became mouldy during the winter, and the honey in unsealed cells got very thin if not sour, so that these combs were not fit to be given to an ordinary stock in the spring. Very strong colonies only could do the repairs required to make them fit and useful combs for the following year; therefore, I now always leave the full number of combs in the care of the bees, and after many years' experience find no ill effects by the colonies having more frames than they cover, provided they are well wrapped up in rainproof hives.

Foul brood has scarcely been so prominent a subject this season among bee-keepers as in previous years. I hope there is a decline in its virulence, and that with the aid of the new disinfectant, "Formaline," we may eventually see its yearly decrease. If the spores are killed by formaline without the necessity of destroying the combs a very great stride forward will have been achieved, and the penetrating power of the germicide into contents of the cells of combs must be extra-

ordinary. In this district we have but little foul-brood, but are much troubled with wax-moth, and I shall be glad if "Blackwood" will tell us if Formaline fumes will destroy the larvæ and eggs of the wax-moth? I have used sulphur fumes, but unless continued for a long time it does not always kill the larvæ, and I think the eggs must escape the effects of the sulphur fumes, as I have known a second brood of larvæ develop after every larva had been killed and removed from the combs after being fumed with sulphur. I know this was so, because the combs remained in a box with a close-fitting lid, too secure to allow a moth to enter to lay eggs after the fumigating.—W. WOODLEY, *Beedon, Newbury.*

[Readers may rest assured without troubling "Blackwood" or any one that any fumes which will destroy the spores of foul-brood, as is claimed for Formaldehyde, will put an end to every trace of wax-moth.—EDS.]

#### A BEGINNER'S EXPERIENCE OF 1903.

[5239.] Continuing the statement of my experience as a beginner from the B.B.J. of May 14 (5109, page 194), I may now say the "take" of surplus from my five hives, spring count, has been seventy-seven saleable sections and 48 lb. extracted honey, or an average of 25 lb. per hive, which I consider very fair for the centre of a town in a medium district. My best stock yielded 44 lb., and my lowest (a late driven lot of bees built up into a stock in 1902) only 10 lb. The colour of the honey is uniformly good; one small lot of 12 lb. only being on the dark shade. Strange to say, however, my own people consider the dark honey best in flavour, it being slightly stronger than the light. I do not sell my bee-produce, deeming it quite as cheap, and infinitely better, than the better class jams. If, however, I am asked to part with any the price is 9d. for sections and 1s. for 1-lb. jars of extracted. Continuing the £ s. d. aspect of my bee-keeping, I consider that having regard to the season's yield, and going into winter quarters possessed of five colonies of bees, with two racks of sections for each hive (forty of the latter having drawn out combs) along with thirty drawn-out shallow-frames of comb, honey extractor, &c., I consider the bees owe me nothing, but promise to yield a handsome profit in the next campaign. As promised in my last "note," I beg to enclose photo of my little apiary if suitable for reproduction. While not so fortunate as many of your readers, because like most postmasters living over their office, I have no garden. Consequently my little plot is some five minutes' walk from home, which, of course, necessitates a deal of carrying to and fro.

I have just returned from a holiday at Tunbridge Wells, and during my stay walked and rode many miles around that town, but failed to see in all my rambles a dozen bee-

keeper's paradise—clover, heather, and lime trees abounding. Bees could be seen on Tunbridge Wells Common working side by side on ling and clover. It seems pitiful that such a district is not more appreciated.

The best thanks of bee-keepers are, I think, due to the B.B.J. for its most interesting and encouraging issues during the past trying and anxious season.—R. J. T., *Romford, Sept. 11.*

[Much obliged for photo, which will be used in our "Homes of the Honey Bee."—EDS.]

#### GOOD HONEY IN WALES.

[5240.] I should be pleased if you would kindly let me know in the next issue of B.B.J. what is the quality of the enclosed honey. No. 1 got first prize and No. 2 second prize at a local show held a fortnight ago. No. 2 belongs to my gardener. From my own two hives I have had over 100 lb. of extracted honey and a rack of twenty-one filled sections. My gardener had 17 lb. of honey and a swarm from his single hive. I have two other stocks of bees, but they are in skeps, and if I can keep them alive during winter, I shall transfer them to a frame-hive in the spring.

I wish we could get an expert to visit here, as I know that some of my neighbours' bees are affected with foul-brood, and my gardener lost one of his hives last winter through this plague. I burnt all the frames and quilts, cleaned the hive, and got a painter to scorch the inside with his lamp. My own hives have done much better than any one else's anywhere about here. I have no trouble in selling all the honey I wish to sell.—CYMRAES, *Anglesea.*

[Your samples of honey are very good indeed, No. 1 especially so. We should have been surprised if it had not won at your local show, for it is bright and clear, of good colour, and is very good indeed in flavour, aroma, and consistency; in fact, it is an excellent sample. No. 2 is darker in colour, but very good in flavour and well ripened. The air bubbles in it are a fault from which No. 1 is quite free, but both are good honies; and the weight of surplus taken from your two hives is exceptionally good in so poor a season as this.—EDS.]

#### FORMALDEHYDE

##### FOR DISINFECTING COMBS.

[5241.] I am much interested in the discussion going on in your valuable paper on the question of formaldehyde as a disinfectant for hives, combs, &c. We have foul-brood very bad round here, and I would like to disinfect all my section-racks, &c., before putting by for winter. I should like to know if your correspondent "Blackwood" would recommend fumigating the combs and appliances in a small bedroom without a fireplace, 11 ft. by 7 ft. If this would serve the purpose, wha

sort of lamp is best and cheapest, and how much formaldehyde would it require for that size of room?—W. L., *Lancaster, Sept. 16.*

## Queries and Replies.

[3231.] *A Beginner's Troubles in Transferring Bees.*—I am a subscriber and six months' old reader of B.B.J., and should be obliged if you will look at the bees which I send. The queen is among them. I gave 35s. in March to a well-known dealer for a stock of bees on six frames, and put them in a "W.B.C." hive. They were transferred by a man who has kept bees for eleven years. He lifted frames into new hive, but left about two handfuls of bees in the box, saying they would crawl in. That was at 11.30 a.m. At 6 p.m. I went to see if they had done so, and noticed at once the queen was among the bees still in the box. He laughed it off when I told him of this, and said there would be no harm, as I warmed the bees and queen and put them among the frames. The same man came and put my super on in July, and said it would not do to examine the frames as I suggested. He said they had drawn out the two frames of foundation which we added to the six, and would fill the supers. Last Sunday I saw many robbers and fights on the alighting-board, so I opened the hive and then found hundreds of bees dead at the bottom of the hive, no young brood, a very little honey in cells but none sealed over, four dead wasps, and a quantity of brown powder, colour of ground coffee; the dead queen among the others. Certainly it has been a bad bee-year here, but I am surrounded by fruit trees and clover fields, and a man half a mile away has taken 155 lb. from five hives. I find the two frames of foundation beautifully worked into cells, but empty, and in the centre frame are three queen-cells. In July drones were very plentiful about the entrance, and were often seen by me and others being killed. I must now make a fresh start with a swarm of this year offered me. I am very disappointed at loss of 35s., a year's time, and no honey, and want to learn by experience. My idea now is that the queen was so starved that day of early March that she has never laid well, and the stock has been dwindling all the summer. I have been most careful to keep them warm, and should have fed them as is often advised, but that I feared to let in cold air at night, only getting home at 6 o'clock. Please give me your idea of the affair in B.B.J.—CHAS. F. BUTTERWORTH, *Cheshire, September 14.*

REPLY.—According to your account of what took place in March last, the bee-keeper who transferred the stock was, to say the least, careless over his work. The dead queen sent has no doubt come to grief some time ago as shown by queen-cells on comb, but for

the rest there is no doubt that the hive has been robbed out in consequence of being rendered queenless in some way not apparent on the face of above description.

[3232.] *Rapid Feeding and Late Breeding.*—Will you kindly say—1. If it is possible for the queen to be crowded out by rapid feeding—that is, can she prevent the bees filling cells with syrup that should be reserved for eggs and brood? 2. I am making a fifteen-frame hive, to take shallow and Standard frames, and I would thank you to tell me the best and most economical way of getting a strong colony of bees next spring; so that I can reasonably expect to gather some surplus honey next season, weather permitting. I live in a good bee district.—A. H. W., *Four Oaks, September 14.*

REPLY.—1. There is no need for taking any precaution against occupying cells with food which should be occupied with eggs at this season. The only thing worth considering is that the bees may be able to cap the food over, instead of leaving them to winter on unsealed stores. 2. We advise you to order an early swarm in spring from some bee-keeper in the south, and give the bees full sheets of foundation when hiving.

## QUEEN REARING IN AMERICA.

BY J. M. HOOKER.

Since my arrival in the United States I have visited several apiaries, and taken a great interest in the way in which queen-rearing is carried out in this country. It has also been my good fortune to make the acquaintance of Mr. E. L. Pratt, of the "Swarthmore" Apiaries, who has revolutionised and done much to simplify the artificial rearing of queens in this country. Mr. Pratt has kindly allowed me a full opportunity of seeing all his methods, and I have his permission to make copious extracts from his "notes" for the purpose of this paper. There is a decided improvement in the American bred strains of Italian bees, not alone in colour, but in working qualities, prolificness, size, hardiness, and gentleness. Mr. Pratt's speciality is rearing what he calls "Golden all over Queens." He considers the introduction of the darker bees from Italy would be simply folly, so far as he is concerned.

To raise good, long-lived queens, we must follow the natural way as near as possible, and strive at all times to reach the conditions under which swarming generally takes place.

Three things are necessary for the construction of good queen-cells—viz., a large number of young bees, liberal supply of food, and the constant generation of heat. When starting cells artificially, stimulation must be maintained by constant slow-feeding, and the presence of a large number of young nurse bees, that have little else to do but feed and care for the rapidly-developing royal larvæ,

over which the mass should be thickly clustered all the while previous to the time of sealing the cells. The hives should have an additional covering of warm quilts, &c., during cold weather.

Mr. Pratt has introduced and uses wooden shells in which queen cell-cups are formed for compression; their removal is quite easy, without taking out the frames from the hive or in any way disturbing or coming in contact with the bees; and, in fact, without even opening the body of the hive.

These shells, or cups, are turned from hard wood to fit loosely into  $\frac{3}{4}$  in. augur holes. They are  $\frac{5}{8}$  in. long, and have a flange at top to support them in the holes in the nursery cage when in position. The centre is drilled out  $\frac{1}{2}$  in. diameter and  $\frac{1}{2}$  in. deep, into which melted wax is poured, being careful that no wax gets on the outside. The wax should be heated only a little above melting point, when there will be no shrinkage of the plug when cool. The wax in the shells is then compressed to form the base of the queen-cells by a forming stick, which is slightly tapered, and must be lubricated each time it is used. When pressed into the wax-plug, a perfectly smooth bottom of a queen-cell is formed ready to receive the larva. The pressure forces the wax out at the edges, which the bees will add to and form a perfect queen-cell. Where a number of these cups are required, Mr. Pratt has designed what he calls "The Grace Cell Compressor," for forming the wax in the cups, which it does admirably, making it perfectly smooth, exactly like a natural queen-cell. A dripper is made for putting the heated wax into the cups, of  $\frac{1}{2}$ -in. glass tubing 6 in. long, drawn to a point at one end, and, having a rubber bulb at the other end, forms a suction, on the principle of the fillers used with fountain pens, and is a ready way of putting the wax into the shells.

Transferring the larvæ into compressed cups is a delicate job, requiring good eyesight, and the plan of lifting the little larva into a queen-cup with a pointed quill or stick originated with Mr. Doolittle. The "Swarthmore" compressed cups are particularly suited for this purpose. There is no necessity to supply the cups with royal jelly.

A ventilated hive-body made to hold four frames, having the bottom covered with wire cloth, resting on pieces of  $\frac{3}{4}$ -in wood at the ends, gives the ventilation required. The frame to receive the cups is made as follows:—Cut off the top bar of an ordinary frame close up to the side pieces, and drop the piece removed down  $2\frac{1}{2}$  in. and nail it fast to the end bars. In the space below fix a piece of worker comb or a piece of foundation. Fasten the lags securely, so that the frame hangs like those to be placed on either side of it. In the  $2\frac{1}{2}$  in. space fix a cell bar, having  $\frac{3}{8}$  in. holes bored about 1 in. apart, into which the compressed cups are placed for the purpose of starting the cells. Cover the top of frames with two pieces

of enamelled cloth, leaving the tops of the cups exposed, the remainder closely covered. Thus the cells can be examined at any time without removing the quilt or disturbing the bees.

The hive being prepared, bees must be furnished from a populous colony. About ten o'clock in the morning shake the bees from three or four frames into this hive, being careful not to get the queen. Tack down the sheet and remove the confined bees to the house, and let them remain there undisturbed for six hours, ventilated as above described. The bees, finding they have no queen with them, will set up a piteous hum. At the expiration of that time the bees will have prepared the cups ready to receive the larva, which should be taken out one at a time. The larvæ is then taken from the cell of the selected comb, and placed in the bottom of the cup by a sort of wiping motion, so as to leave it in a similar position to that which it occupied when in the natural cell. Select none but just-hatched eggs (laid by a queen one year old preferably), and with the pointed stick or quill thrust under the larva where the two ends approach each other, when curled around naturally, unnecessarily disturbing the bottom of the cell will be avoided. When properly grafted, the cup is returned to the hole from which it was taken, and the others in turn are treated in the same manner. The moment the bees in the confined queenless hive are supplied with the larvæ, from which they can raise a queen, they resume their normal condition, and their mourning is turned into a joyful hum.

In about twelve to twenty-four hours the cells will have been partially drawn out and must be shifted into a "Swarthmore nursery cage," protected on one side with wire netting and the other with excluder zinc, through which the bees can pass to feed and care for the larvæ and complete the cells. This frame with cells must then be taken to the colony from which the bees were borrowed, and inserted in the centre of the brood nest, and the rest of the bees shaken in front of the hive, when they will gladly run in, after their confinement. Cover the tops of the frames with enamelled sheet divided down the centre, adjusted to completely close the bees inside, so that none can escape, but leaving the tops of the shells free for the convenience of drawing for examination, without the least disturbance of the bees, and without smoke or veil. Between the fifth and tenth days avoid all handling for any purpose. To prevent the bees filling the upper space with comb when not occupied by the nursery cages, dummy blocks are used, but the cages may be left in throughout the year.

If honey has not been coming in all the while, feed at once liberally during the entire time, and there should be queens in the nurseries in about twelve days, all fully equal to those raised at the time of swarming. The safest way is to draw the cells one at a time.

When sealed over, just before hatching, put them into nuclei to hatch, then to fly and mate. Virgin queens over ten days old are nearly worthless; they will seldom mate when older than fifteen days with any degree of certainty.

For those who have difficulty in properly grafting larvæ in the shells Mr. Pratt recommends the following plan of forcing the breeding queens to deposit eggs directly into the compressed cups:—For this purpose a small hive is used. These little hives are built to hold from six to eight small frames  $4\frac{1}{2}$  in. by  $8\frac{1}{2}$  in. outside measure, four of these will fill a "Langstroth" frame, the standard frame of the United States, and the combs are first drawn out in full colonies. Four saw cuts are made down each side-board near the centre of the small hive at intervals of  $1\frac{1}{2}$  in. to receive sheets of queen excluder zinc, so as to divide the little brood chamber into three parts. The centre compartment between the two sheets of zinc may be contracted to hold one or two combs by adjusting the zinc accordingly, and in this centre the queen is confined. Combs of honey and brood occupy the remaining portion of the hive. The frame in which the queen is desired to deposit eggs has to be filled with shell cups of small size. A special die is needed for preparing the wax in these inner shells, leaving the cell perfectly formed, of a depth in which the queen will lay eggs as in a worker comb, and the cups are then filled into one of the small frames. The frame is laid on a smooth soft surface to prevent the wax in the cups from being injured, the cups are then filled into the frame, back to back, and must be wedged securely so as to resemble a comb of large size. This frame is now hung in the royal compartment in which the queen is confined between the two zinc excluders, the brood combs are placed close up to the zinc on both sides; she will begin to deposit eggs in these cell cups which should be filled in about three days. A large number of queen cups prime for cell forming, can in this way be obtained each in a separate removable shell cup without all the fussiness of transferring the larvæ and dissecting the cells, and without the possibility of injury to the grub. These inner shells with eggs, only just hatched, must be drawn with a pair of tweezers, loosened with a twisting motion one at a time, and placed into a  $\frac{3}{8}$ -in. shell, which now acts as a holding shell, and is put in the starting bar as before explained and given to a strong colony.

*Forming Nuclei.*—The usual way of forming nuclei is by removing two or three full-sized combs of brood with honey, pollen, and the bees adhering to them, and placing them in a hive enclosed between division-boards. From other combs the bees are shaken into the nuclei. This is a plan which no queen-breeder could afford to adopt, and *small* nucleus hives are used containing two or three small combs

and about half-a-pint of bees. For over forty years Mr. Henry Alley, the veteran queen-rearer, has used nuclei with combs only 5 in. square. This simply goes to prove how few bees are necessary to spur a young queen on to flight. Feeding must be resorted to in order to hold the little colony together, for they will swarm out if not regularly and bountifully supplied with syrup.

*Fertilising Box-attachments.*—Mr. Pratt has devised a clever plan for attaching small boxes to the outside and inside of ordinary hives. A  $\frac{3}{4}$  in. augur hole is made through the sides and back (but not in the front) of the hive, covered with a piece of perforated zinc, forming a passage for the bees into the boxes, to tend the cells, and through a  $\frac{1}{2}$ -in. flight-hole to the open air, through which the queen will go on her wedding trip. The inside attachment of boxes is the most satisfactory for convenience and reliability at all times; they are protected from the weather, and the hive temperature is better maintained during cold spells, and little attention is required in order to keep them in good working order. In these hatching queen-cells may be safely inserted in any kind of weather with a reasonable assurance that every one will hatch perfectly and entirely without undue attention. In a super six to ten of these boxes may be used at one time, holding frames  $4\frac{1}{2}$  in. by  $5\frac{1}{16}$  in.; this is considered an ideal size; six of these will fill a "Langstroth" frame, in which they are placed into the brood-nest of a strong colony to draw out the foundation and fill with brood.

Mr. Pratt has kindly lent the use of the blocks, made from photographs I took for him, and his description of "How provision may be made for mating from forty to fifty queens by the bees of one strong colony," as practised by him at Swarthmore, reads as follows:—

#### FORMING SECTION-BOX NUCLEI.

It does not require more than a teacupful of bees to surround a young queen with the necessary environments for maternity-flight—the only question being how best to harness such a small force in order to get the best results with as little time and labour as possible.

We must bear in mind that it cannot be expected that very small nuclei will maintain themselves without assistance; therefore the hives should be of such construction as to be quite easily handled, either singly or in numbers—wholesale mating being the idea—in lots of twelve or twenty-five at a time.

Details of the fertilising-box I am now using, is as follows:—A simple box for holding two  $4\frac{1}{2}$  in. by  $4\frac{1}{2}$  in. section-box frames, having a  $\frac{1}{2}$ -in. flight-hole on one side, as shown, covered with the screen in the photograph on next page.

The frames are attached to the lid or roof board (which may or may not be divided) by means of staples driven part way into the

wood, and then bent at right angles over the frame, which holds the same securely, yet permits ready removal by a simple twisting motion. Standard  $1\frac{3}{4}$  by  $4\frac{1}{4}$  by  $4\frac{1}{4}$  sections, split in the middle, are used for frames. When

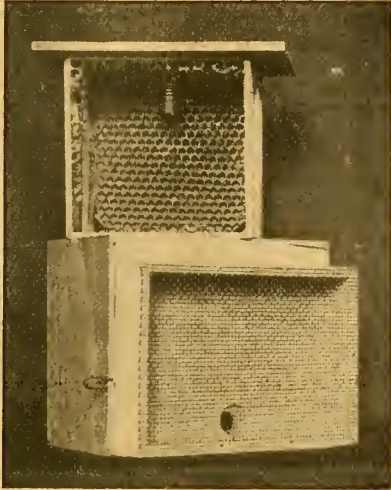

FIG. 1.

SWARTHMORE MATING-BOX FOR SETTING OUT.

the frames are dropped into place in the box, the top opening will be entirely closed, and the little frames will have a bee-space from the bottom and sides of the little hive.

A  $\frac{3}{4}$ -in. hole, coming directly between the two frames, is made in each lid for the purpose of inserting queen-cells or feeders.

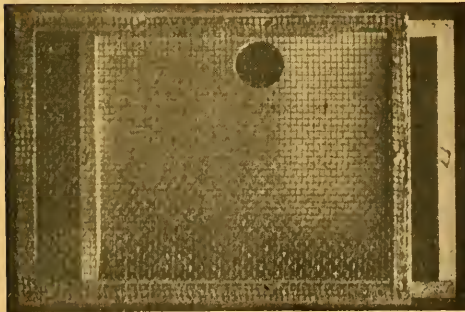

FIG. 2.

SWARTHMORE CONFINING SCREEN FOR FORMING NUCLEI.

Foundation is fixed into these small frames, and eight of them are then fitted into a Langstroth frame, and several such are hung in large hives to be drawn out and supplied with honey, after which they are removed as

wanted, and fixed two frames in each box, as shown in the photograph above (fig. 1).

It is always better to have some brood in the combs; but brood is not imperative when making up isolated nuclei. Of course there is some chance of failure without brood, but of such small consequence that the loss is hardly noticeable in the end. However, stocks of brood, honey, and pollen may be held always in reserve by keeping a nucleus colony of three to five frames constantly upon small combs fitted into "Langstroth" frames.

Supply twelve mating-boxes at a time, each with two nicely drawn combs well supplied with honey; then run into each box a teacupful of bees in the following manner:—

Twelve confining-screens (shown attached to a box in fig. 2) of peculiar construction are to be at hand.

Two rims are made, of  $\frac{1}{2}$ -in. strips,  $4\frac{1}{4}$  in. by  $5\frac{1}{2}$  in. One rim is covered with wire cloth, while the other is covered with a thin board. A  $\frac{3}{4}$ -in. hole is cut in the centre of the thin boards, from side to side, but close to the lower rail of the rim. Small staples driven into the board-covered half, one at each end, and then forced into the screen-covered half, serve to hold the parts together. If for any reason it is necessary to cast the bees from the confining-screen, as in strengthening nuclei on their stands, simply separate the parts, jar out the bees, and replace. Staples serve very well for holding the screens in place, although some prefer wire nails driven in diagonally at either end. If for any reason it is desired to confine bees in the screens, a Swarthmore shell will just fit the escape-hole. These screens are very useful for transporting bees for strengthening purposes.

(Conclusion next week.)

## Bee Shows to Come.

A nominal charge of 2s. 6d. is made for notices in this column, which covers cost of insertion from order till date of show. Cash should accompany orders for insertion.

September 17, 18, and 19, at Crystal Palace.—Surrey B.K.A. Annual Exhibition of Bees, Honey, Wax, Appliances, &c. Twenty-four classes (ten open to all). Increased prizes and medals.

September 19 to 26, at the Agricultural Hall, London.—Honey Show in connection with the Eleventh Annual Exhibition and Market of the Grocery and Kindred Trades. Numerous classes and liberal prizes for comb and extracted honey and beeswax. Open to all British Bee-keepers.

October 6 to 9, at the Agricultural Hall, London.—Show of Honey and Bee-produce in connection with the British Dairy Farmers' Association. Numerous and liberal prizes for honey, &c., including the valuable Silver Challenge Cup of the B.B.K.A. Schedules from Mr. Wm. C. Young, Secretary, 12, Hanover-square, London, W.

## IMPORTANT NOTICE.

## REMOVAL OF "BRITISH BEE JOURNAL" OFFICES.

Owing to expiration of lease the offices of the BRITISH BEE JOURNAL and the *Bee keepers' Record* will, at the end of the present week, be removed to larger and more convenient premises, No. 10, Buckingham-street, Strand, about fifty yards from Charing Cross Station. All communications must therefore be addressed as above.

The new premises are on the ground floor, and being only two minutes' walk from our present offices, no difficulty will be experienced in reaching the new address.

*Notices to Correspondents & Inquirers.*

R. J. T. (Romford).—*Preventing Moth in Store-combs.*—The fumes of flake naphthaline, if used for above purpose, would disappear after exposure to the air for a few days before using again. Personally, however, we prefer a rack for protecting store-combs when not in use, such as has been described and illustrated in a former issue of this journal.

NOVICE (Tavistock).—*Bee Nomenclature.*—The three specimens were smashed flat in post, and consequently quite unrecognisable.

JOHN J. KER (Ware).—*German Foul-Brood Remedies.*—If you could procure us a sample bottle of the "German remedy" mentioned, we will possibly be able to form an opinion on its usefulness, prior to which we do not care to say anything about it in print unless in advertisement columns.

JNO. A. LOWSON (Beckenham).—*Starting Bee-keeping.*—1. In reply to your request for advice on "the best way to set about keeping bees," the first requirement is a good guide-book on bee-keeping, which will not only give you names of bee-appliance makers, but what is still more important, viz., full instructions on the subject of bee-keeping. To buy a hive and bees first is to begin at the wrong end, and might easily lead to failure. 2. Spring or early summer is the best time to buy a stock of bees. Starting with what you call "a swarm of driven bees with queen" in the month of September is not a wise beginning by any means. 3. The Secretary of the B.B.K.A. is Mr. E. H. Young, 12, Hanover-square, London, W.

M. A. J. (Malvern).—*Bee Remedies.*—Naphthol beta and beta naphthol are synonymous terms, and your sample may be all right for the purpose, but we cannot accept responsibility for anything not sent out from our own office.

M. WAND (Leeds).—*Fertile Queen Wanted.*—Reference to our prepaid advertisement columns will show where queens may be

obtained. We cannot recommend any special advertiser to the exclusion of others.

ALEX. PATULI (Forfar).—*Entries for Honey Shows.*—The names of secretaries of shows at the Crystal Palace and Agricultural Hall respectively, to which you refer, are now omitted from list in "Shows to Come" because the entries are closed, and, in consequence, it is too late to apply for schedules. The Dairy Show still remains. Why not enter for that?

B. CLEATOR (Cumberland).—*Débris in Hives.*—The substance sent is not brood of bees at all. It resembles the cocoons of some insect.

CONSTANT READER (Devon).—*Charges for Bee-Work.*—We cannot undertake to put a value on your services for doing bee-work, such as is named in your letter. The fairest course is to work at so much per hour with third-class railway fare added. Some men's time is far more valuable than that of others, and we cannot, of course, judge for you in this respect.

MRS. ALDER (Northumberland).—*Starting Bee-keeping.*—By perusing the chapter on "Bee Diseases" in "Guide Book," which, as stated, you already possess, it will be seen how dangerous it is to be in the least careless in dealing with foul brood. You should, therefore, on no account add purchased bees to a stock that is in the slightest degree affected with that disease. It would be folly to do so.

*Suspected Combs.*

UBIQUE (Mortlake).—The small bit of comb received was not suitable for judging with regard to foul brood. The three sealed cells contained chilled brood only, the remaining cells being quite empty. There is no valid ground for alarm, as bees may have simply died out from queenlessness.

LIGURIAN (Speyside).—Comb is affected with foul brood of pronounced type.

*Honey Samples.*

B. E. B. (Bedford Park, W.).—Sample is far too dark in colour for white clover honey. It is from mixed sources, clover among the rest, no doubt; the consistency is good, but the predominating flavour is certainly not that of clover honey. Most likely the abundant bloom of flowers grown for market close to will account for the somewhat rank flavour. It is perfectly good for home use, though hardly so for market, where good honey is sought for.

BUMBLE BEE (Abergele, N. Wales).—No. 1 is good on all points, except that the air bubbles it contains would tell against it on the show-bench. No. 2 is less ripe than No. 1, and is beginning to granulate; hence its "cloudy" appearance.

\*.\* In consequence of upset in removing our Offices some Letters and Queries are unavoidably held over till next week.



## Editorial, Notices, &c.

### BRITISH BEE-KEEPERS' ASSOCIATION

The monthly meeting of the Council was held at 105, Jermyn-street, on Wednesday, September 16, the chair being occupied by Mr. T. W. Cowan. There were also present Miss Gayton, Dr. T. S. Elliot, Messrs. D. W. Bishop-Ackerman, R. T. Andrews, W. Broughton Carr, W. F. Reid, H. G. Morris, T. I. Weston, and the Secretary. Letters regretting inability to attend were read from Messrs. W. H. Harris, J. B. Lamb, and C. N. White.

The minutes of the previous meeting were read and confirmed.

The following new members were elected, viz.:—Major A. Perkins, D.S.O., East Court, Wells, Somerset (life member); Mrs. E. E. Ford, 1, Ealington-road, Leyton; Miss K. M. Hall, 13, Chalcot-gardens, Haverstock Hill, N.W.; Mr. T. W. Lewis, Bontnewydd, Trelewis, Treharris; and Major E. Montagu, Oxford-road, Colchester.

On behalf of the Finance Committee, Mr. Weston reported that the accounts to date had been duly examined, the balance at the bankers to the Society's credit being £121 11s. 9d. Several accounts were presented for payment and the Report approved.

Reports were received from examiners of candidates for third-class certificates in the following counties:—Berkshire, Cheshire, Devonshire, Glamorganshire, Kent, Lancashire, Lincolnshire, Wiltshire, and Worcestershire. It was decided to grant certificates to the following:—Mrs. Mercier; Misses Abercrombie, Barratt, M. T. Batten, Bennett, Bevington, Billing, H. Bowden, Britten, Callender, Charlsworth, E. Colson, Cross-Brown, Davies, Eley, K. Enraght-Mooney, E. Fogo, G. Fogo, Fotheringham, Grierson, M. K. Hammond, Ivers, Jaszowska, E. Langmore, E. K. Little, H. Lloyd-Davis, P. Lomax, C. Maddock, Martin, I. May, M. Neville-Wyatt, M. Peers, Pollard, H. Radcliffe, Robinson, Seymour, Smith, Stewart, Strachan, J. Swindale, E. M. Thompson, Wace, White, Williams, Jean Wilson, and Woodriddle; Messrs. R. S. W. Andrews, John Arthur, Job Astbury, Eric Bennett, Thomas Beers, R. H. Chadwick, Fredk. Coates, Geo. Cook, J. Coombs, Geo. Deadman, A. J. Dover, Gordon Dunn, R. Gray, A. H. Greenslade, T. Head, A. R. Heselwood, John Owen Jones, James N. Kilvill, A. Mackie, Mitchener, Chas. Mosley, T. E. Paice, A. T. Parrish, W. H. Paterson, W. H. Piper, Chas. Radway, Wm. Richards, Thos. Rouse, Norman Russell, Wm. C. Stone, Harry Swift, Tabor, Thomaset, H. Tinley, W. Wadham, Western and G. E. Willoughby; also to the Rev.

Henry Morgan, Rev. King, and Dr. E. Walpole-Simons.

### CONVERSAZIONE AND MEETING OF COUNTY REPRESENTATIVES ON OCTOBER 8.

It was decided to hold a meeting of representatives of County Associations at 105, Jermyn-street, S.W., on Thursday, October 8, at 4 p.m., the Secretary being instructed to forward notices of the proposed meeting to the various affiliated Societies. The Conference will be followed by a *Conversazione* of members, to commence at 6 p.m.

The next meeting of the Council was fixed for Wednesday, October 21.

### THE GROCERS AND KINDRED TRADES' EXHIBITION.

#### HONEY SHOW AT THE AGRICULTURAL HALL.

After an interval of a week only the "Confectioneries" was followed by the eleventh annual International Exhibition and Market of the Grocery and Allied Trades at the Royal Agricultural Hall, London, which opened on Saturday, September 19, and continues to the end of the present week.

The transformation effected in the whole exhibition, as differing from the "Confectioners'" was remarkable, seeing how short was the interval between the two shows. Everything was, however, in good order for admitting the public on the first day.

The bee-section was somewhat less fortunate in its position this time, the exigencies of space compelling its removal from the ground-floor to the gallery above; but it was nicely placed upstairs, and looked very neat. The increased entries, which numbered fifty-eight over those at the "Confectioners,'" helped the display, and with five good trophies staged along with excellent samples of honey in the principal classes, it made a show that was most creditable to the industry in so adverse a season as the present one.

Mr. W. Broughton Carr, London, and Mr. Thos. I. Weston, Wickham Bishops, Essex, officiated as judges, and made the following

#### AWARDS.

*Display of Honey (comb and extracted) and Honey Products, shown in suitably attractive form for a tradesman's window (5 entries).—*1st (£4 and B.B.K.A. Silver Medal), F. W. Woodlev, Camp Stores, Compton, Newbury; 2nd (£3), A. E. Waller, Grove-street, Halliwell, Bolton; 3rd (£2), C. W. Dyer, Compton, Newbury; 4th (£1), J. Waddell, Wooler, Northumberland; c., F. R. Ford, County Apiary, Burwell, Cambs.

*Twelve 1-lb. Sections (25 entries).—*1st (£2 and B.B.K.A. Bronze Medal), C. W. Hill, Willoughton Cliff, Lincoln; 2nd (£1 10s.),

W. Patchett, Cabourne, Caistor, Lincs.; 3rd (£1), J. Waddell; 4th (10s.), F. W. Woodley; 5th (5s.), C. W. Dyer; h.c., Burrell Bros., Great Barton, Bury St. Edmunds; S. Bailey, Stichingfield, Horsham; E. C. R. White, Newton Toney, Salisbury; and W. E. Brooking, Marlboro', Kingsbridge, Devon.

*Twelve 1-lb. Heather Sections* (5 entries).—1st (£1 5s.), E. Middlemass, Stamford, Alnwick; 2nd (£1), W. Thompson, Wooler, Northumberland; 3rd (15s.), W. G. Walton, Central Buildings, Windermere; 4th (10s.), Jas. Lee & Son, Martineau-road, London, N.

*Three Shallow Frames Comb Honey for Extracting* (9 entries).—1st (£1 5s.), J. Waddell; 2nd (£1), A. E. Waller; 3rd (15s.), W. Loveday, Hatfield Heath, Harlow, Essex; 4th (10s.), W. Blakeman, Ovington, Alresford, Hants.

*Twelve 1-lb. Jars Light-coloured Extracted Honey* (35 entries) 1st (£2 and B.B.K.A. Certificate), J. Waddell; 2nd (£1 10s.), C. W. Dyer; 3rd (£1), P. H. Rawson, Market Drayton, Salop; 4th (10s.), T. S. Holesworth, Kirton-in-Lindsay; 5th (5s.), W. Cook, Binbrook, Market Rasen; v.h.c., P. S. Soal, Rochford, Essex; H. E. Rampton, Bishops Sutton, Alresford; and H. R. Walpole, Woodham Ferris; h.c., D. Seamer, Erighowgate, Grimsby; and Mrs. E. Soop, Wallingford.

*Twelve 1-lb. Jars Medium-coloured Extracted Honey* (28 entries).—1st (£1 5s.), J. Waddell; 2nd (£1), C. W. Dyer; 3rd (15s.), J. Kerr, Dumfries; 4th (10s.), Miss M. Pittis, Uplyme, Devon; v.h.c., A. E. Waller; J. Helme, Norton Canon, Weobley, R.S.O., Herefordshire; G. Ingham, 17, Rectory-lane, Broughton, Stockbridge; and P. B. Govett, Tideford, St. Germans.

*Twelve 1-lb. Jars Dark-coloured Extracted Honey* (9 entries).—1st (£1), J. Kerr; 2nd (15s.), G. Hills, Comberton, Cambs.; 3rd (10s.), A. E. Waller.

*Twelve 1-lb. Jars Heather Honey* (9 entries).—1st (£1 5s.), J. Berry, Llanrwst, N. Wales; 2nd (£1), J. Waddell; 3rd (15s.), W. Dickson, 5, Beckett-street, Leeds; 4th (10s.), W. G. Walton, Central Buildings, Windermere; v.h.c., T. Hood, White Heather Apiary, Pickering.

*Twelve 1-lb. Jars Granulated Honey* (13 entries).—1st (£1 5s.), F. W. Woodley; 2nd (£1), J. Waddell; 3rd (15s.), C. Lodge, High Easter, Chelmsford; 4th (10s.), W. Norris, Wraxall Lodge, Bradford-on-Avon; v.h.c., C. W. Hill.

*Beeswax in Cakes, Quality of Wax, Form of Cakes and Package, suitable for retail counter trade* (13 entries).—1st (£1), W. Pearman, Penny Long-lane, Derby; 2nd (15s.), A. E. Waller; 3rd (10s.), H. Berry, Llanrwst, N. Wales; 4th (5s.), L. Jacobs, Cedars-road, Beckenham; h.c., C. W. Dyer; and F. W. Woodley.

*Beeswax, judged for quality of wax only* (18 entries) 1st (£1), A. E. Waller; 2nd (15s.), W. Loveday; 3rd (10s.), E. C. R. White; 4th

(5s.), J. Berry; h.c., G. Lambert, Comberbach, Northwich; and F. W. Woodley.

#### HONEY-SELLING CLASSES.

*Extracted Honey in Bulk—by Sample with price* (1 entry).—Certificate of merit awarded to J. M. Best, Trewoon Apiary, St. Austell, Cornwall.

*Extracted Honey in 1-lb. Jars—by Sample with price*—(6 entries).—Certificates of merit awarded to J. H. Seabrook, Longfield, Kent; and Rev. A. Headley, The Rectory, Alresford.

*Comb Honey in Sections—with price per dozen* (2 entries).—No certificates awarded.

#### HENBURY DISTRICT B.K.A.

##### ANNUAL SHOW.

The fifth annual show of the Henbury District Bee-keepers' Association was held at Henbury on July 29, in conjunction with the Horticultural Society of that district.

The show was a most successful one, showing a steady increase of entries as compared with former years. Notwithstanding the adverse season, the various displays were very good, both in appearance and quality.

The schedule comprises sixteen classes, with prizes amounting to over £11, six of which are open to all, with two medals presented annually by Mrs. Todd; also an extra award of merit given this year by the Bristol and South Gloucester Association.

The show arrangements were carried out by the Hon. Secretary and Treasurer and the Committee, of which Mr. H. Jolly was chairman. Messrs. Brown and Jordan officiated as judges, and made the following awards:—

##### OPEN CLASSES.

*Display of Honey.*—1st, Mrs. Waller, Henbury.

*Twelve 1-lb. Sections.*—1st, W. Woodley, Newbury; 2nd, E. C. R. White, Newton Toney; 3rd, H. F. Jolly, Clifton; h.c., — Wilmot, Westbury-on-Trym.

*Twelve 1-lb. Jars Extracted Honey.*—1st, W. Woodley; 2nd, E. C. R. White.

*Single 1-lb. Section.*—1st, W. Woodley; 2nd, Edwin Meares, Henbury; 3rd, E. C. R. White; v.h.c., Miss Edwards, Hampshire; h.c., E. R. Nash, Smarden.

*Single 1-lb. Jar Extracted Honey.*—1st, Miss Edwards; 2nd, Miss Rodwell, Driffild; 3rd, W. Cook, Market Rasen; v.h.c. and r, W. Hatliff, Caistor, Lincs; v.h.c., Ernest Hart, Caistor; h.c., W. Woodley; c., Wm. Fake, King's Lynn.

*Beeswax.*—1st, E. C. R. White; 2nd, Mrs. Waller; 3rd, C. A. Newman, Henbury.

*Collection of Queen Wasps.*—1st, James Davis; 2nd, Thos. Denham; 3rd, — Angel.

##### MEMBERS' CLASSES.

*Twelve 1-lb. Sections.*—1st, Mrs. Todd; 2nd, Mrs. Waller; 3rd, H. Jolly; c., Mrs. Hignell.

*Twelve 1-lb. Jars Extracted Honey.*—1st, Mrs. Waller; 2nd, A. Baker; 3rd, H. Jolly.

*Six 1-lb. Sections.*—1st, Edwin Meares; 2nd, Mrs. Todd; 3rd, Mrs. Waller; v.h.c., Mrs. Butler; h.c., W. Castell; h.c., H. Jolly.

*Six 1-lb. Jars Extracted Honey.*—1st, J. Hodges; 2nd, Mrs. Waller; 3rd, W. Board; h.c., H. Jolly.

*Three Shallow-Frames of Honey.*—1st, Mrs. Todd; 2nd, Mrs. Hignell; 3rd, A. Baker; c., W. Board.

*Three 1-lb. Sections.*—1st, Mrs. Waller; 2nd, Edwin Meares; 3rd, Mrs. Butler; v.h.c., Mrs. Todd; h.c., H. Jolly; c., A. Baker.

#### COTTAGERS' CLASS.

*Three 1-lb. Jars Extracted Honey.*—1st, Charles Thompson.

*Three 1-lb. Jars Extracted Honey (novices).*—1st, Henry Withehell; 2nd, John Joyner; 3rd, A. Baker.

*Three 1-lb. Sections (novices).*—1st, Henry Withehell; 2nd, Mrs. Colson; 3rd, E. Davis; c., A. Baker.

#### MEMBERS' SPECIAL PRIZES.

*Silver Medal.*—Mrs. Waller.

*Bronze Medal.*—Mrs. Todd.

*Diploma.*—Mrs. Waller.—(Communicated.)

#### LEICESTERSHIRE B.K.A.

##### ANNUAL SHOW.

The sixty-fifth annual exhibition of the Loughborough Agricultural Society was held on September 16 at Southfield, Loughborough, by permission of W. B. Paget, Esq. The honey department was, as usual, under the management of the L.B.K.A., and great credit is due to those who were responsible for the arrangement of the different classes of bee-produce. For a season such as this has been the Association is to be congratulated upon having members who will rise to the occasion and place upon the show-bench such a representative display of the work which the industrious little bee is capable of doing. The first three classes were open to all members of the L.B.K.A., and the remainder only to members residing in the Loughborough district. Mr. W. P. Meadows, Syston, officiated as judge, and made the following awards:—

*Twelve 1-lb. Jars Extracted Honey.*—1st, J. Waterfield, Kibworth; 2nd, G. J. Levers, Loughborough; 3rd, A. Ward, Great Bowden.

*Twelve 1-lb. Sections.*—1st, Sir H. F. de Trafford, Bart., Market Harborough; 2nd, W. W. Falkner, Market Harborough.

*Single 1-lb. Jar Extracted Honey.*—1st, J. Waterfield.

*Six 1-lb. Jars (Light) Extracted Honey.*—(No 1st awarded); 2nd, G. J. Levers; 3rd, A. Brown, Loughborough.

*Six 1-lb. Jars (Dark) Extracted Honey.*—1st, Miss Wadkin, Wymeswold; 2nd, W. Baldock, Loughborough.

*Six 1-lb. Sections.*—(No 1st awarded); 2nd, G. J. Levers.—(Communicated.)

## Correspondence.

*The Editors do not hold themselves responsible for the opinions expressed by correspondents. No notice will be taken of anonymous communications, and correspondents are requested to write on one side of the paper only and give their real names and addresses, not necessarily for publication, but as a guarantee of good faith. Illustrations should be drawn on separate pieces of paper. We do not undertake to return rejected communications.*

#### AMONG THE BEES.

##### LOSS OF BEES IN TRANSIT.

[5242.] I have had quite a number of communications lately on this subject which reveal a state of matters grave in the extreme. Several who cater for swarm-providing, and the sale of driven bees, seem to think that any package is suitable for their dispatch, and that bees can travel safely in any kind of receptacle. Then, when the purchaser objects to pay for dead bees he is asked to claim from the railway company or carrier, thereby laying the onus of blame on wholly innocent parties. The company deny all liability, and point to a receipt signed by the carrier. Even if the party to whom the bees are consigned calls for them, he cannot open them and examine the contents at the railway station. In the nature of things it is impossible to tell the condition of the bees until he carries them to his apiary and throws them out of the box, when, of course, it is too late to make any claim likely to succeed. The seller contents himself with asserting that he consigned them safely to the hands of the company: the consignee claims that he received them dead. The question arises—*Are we to pay for these dead bees?* Out of this question there arises another. Why should travelled bees ever arrive in bad order? I unhesitatingly reply to this that they should not, and that when they do it must, in ninety-nine cases out of a hundred, be a result of bad packing. Any one who has seen the packages in which bees travel to this country from abroad, or those used by our own best houses, will agree that a swarm when in transit can scarcely have too much ventilation. This is where our packers, or, rather the class now under review, err. The cubic capacity of the travelling-box is not so much to blame, as a rule, as the almost utter want of proper ventilation. A common box with, perhaps, a tiny hole often in the wrong place, covered over with perforated zinc, and the top almost hermetically sealed with a piece of rough sacking, the interstices of which are clogged up with often foul-smelling obstructions, is thought sufficient. The result is just what any reasonable man would anticipate. The bees arrive in a sad condition, all dead or moribund. I again ask why this cruelty to animals should be. The BEE JOURNAL should show these transgressors the error of their ways and educate them to a higher and better state of matters.

I have not inquired, but I am certain if I

had queried, say, Messrs. Howard, Taylor, or Lee, as specimens of our better class of packers, if they ever have any such complaints, the answer would be in the negative. These gentlemen understand their business, and know what bees require to ensure their travelling safely. Further, I am certain these, and dealers of their class, would not make any man pay for what he had not received. We get a guarantee of safe arrival, and even of safe introduction, with queens sent by reliable queen-rearers, and we want such a guarantee with swarms and driven bees. Any man who is not prepared to grant this should mention the fact when advertising in the BEE JOURNAL, and let customers know that they must pay for bees alive or dead. Such advertisements, of course, would be largely patronised!

Now I am about to describe a box thoroughly efficient, I consider, of the simplest design and construction, which can be made at home by any one who can use tools, but any dealer will supply the materials at a merely nominal cost. The ends of the one sent out are  $\frac{3}{8}$  in., but they would be better  $\frac{1}{2}$  in. in order to grip the nails of side pieces better and make the whole stronger. They are 12 in. by 12 in. deep. The side pieces are  $\frac{1}{4}$  in. thick and 18 in. in length, but—and this is a most important feature in their efficiency—nearly 1 in. less in depth. The bottom piece is also  $\frac{1}{4}$  in. thick, and it should have a fair sized hole covered with perforated zinc. It should never rest on any other object, but be raised by two slots  $\frac{1}{2}$  in. or  $\frac{3}{4}$  in. thick. One end, at least, should also be ventilated. The top should be covered with cheese cloth neatly tacked on, and over this should be nailed two slats raising any other box, temporarily placed above,  $\frac{3}{4}$  in. from the actual covering, and, owing to the reduced sides, allowing a free play of air around the clustering bees. Foul smelling and almost impervious sacking is an abomination which should never be used as a top covering. What I have described is a cheap, simple, but efficient travelling box, where the larger, more expensive, and elaborate swarm-boxes used by most large dealers are not on hand, and should prove safe even on a long journey. I have, only partly, stated one side of the case, but I should like the matter further ventilated, and especially desire an answer given to my query—*Should we pay for dead bees?*—D. M. M., Banff.

#### THE £ s. D. OF BEE-KEEPING.

[5243.] We live under a social system which has competition for its law, and for its leading rule "Buy in the cheapest and sell in the dearest market." Now, I am not absolutely in love with the competitive system, nor do I believe in the rigid observance of its rule; but the stern fact remains that we are under the

system, and if we are to live we must "play" within reason "by the rules of the game."

I certainly do not believe in buying in the cheapest market if the goods are produced unjustly under a sweating system; nor do I hold with always selling at the very highest price. There are circumstances of equity to be considered; but, as a general rule, we must, if we are to hold our own, observe the recognised principles of the system under which, whether we like it or not, we at present live.

A producer of honey is a business man; sometimes he has a most prosperous season; at other times he has dead losses, and in order to pay his way it is necessary for him to make such a price in the fat years as will cover the losses of the lean ones.

Some bee-keepers, of course, are so fortunately placed that they always have a fair surplus; but, as a general rule, the foregoing remarks apply.

I frequently notice bee-keepers offering honey at comparatively low prices in the JOURNAL, such as 50s. per cwt. in the present poor season. Now, if the honey be of good quality, and the producer a man of energy and ability, he can realise at least 56s. per cwt. clear for it, and without any difficulty either. I think all bee-keepers should get 6d. clear as a minimum price per pound, for in the event of no produce a second season the price is reduced to 3d. per lb. on the two years' average.

Bee-keeping involves some considerable expenditure of time and trouble, especially time, as, in spite of an impression to the contrary, to get good results the bee-master must be ever watchful over his stocks; the labour of extracting and bottling is not a little either, and a man cannot work for nothing, especially overtime work, after the ordinary day's labour is ended. Bee-keepers, while acting fairly towards others, require to act fairly to themselves and their fellow bee-keepers. Some follow the pursuit as a hobby, and it is a matter almost of indifference to them what price they get; but they should remember that price is a very important matter to most bee-keepers, and act with consideration to the general body of craftsmen, and should therefore not undersell others.

When we bear in mind the fact that in our large cities the retail price is never under 1s. per lb., it will at once be seen that if we sell it to the wholesalers at 6d. per lb. in returnable packages, carriage to be paid by buyer, we are giving the wholesaler and retailer an ample margin of profit, and there is no necessity to offer our honey for less. If we sell it in bottles we should add the extra cost of bottles, labour, and labels.

If the bee-keeper can get a better price, let him do so by all means; but 6d. per lb. should be the minimum for the honey pure and simple, packages to be charged extra, also carriage. Honey is one of the most saleable

things in the world, especially British honey, and producers should stick out for their fair share of the retail value.

While honey is a saleable product, the demand for it would be still further increased if the Bee-keepers' Associations would spend a little money in advertising its merits as a food; many newspapers would gladly publish an interesting article on the subject if it were supplied to them. There is no doubt that honey is a downright valuable food; it appears to digest other foods. I have myself this season experienced its value as a restorative. I had been much run down by a year of constant pressure in an office, but directly the honey was available I began to fetch up my lost vigour; and whether I always have bees of my own or not, I am determined to lay in a stock of honey each year I live. We do not produce anything like enough honey for the demand that might be created for it. "Bread and honey" should be as essential to the people as "bread and butter" is; and it should fetch as good a price as butter too, for it is much scarcer. Ordinary sugar is not a bad food, but it is much less wholesome than honey. Honey causes no disease, but cures many when taken in moderation, as all things should be taken.

People pay fancy prices for extract of this and extract of that, however nauseous the extracts may be; but let us teach them instead that Nature's foods will do them more good, and be just as palatable as the others are disagreeable. Honey is much neglected by the masses simply because it is so seldom offered for sale. How many shop-keepers in our cities stock honey? Very few indeed; and yet withal bee-keepers are offering their produce at prices that are much below the market value, provided the honey is pure and good.—W. J. FARMER, *Truro, September 14.*

#### BEGINNERS NEEDING ADVICE.

[5244.] Being only a beginner with bees (in my second year), I should like to hear from yourselves or fellow-readers what are the advantages of shallow-frames above the full-sized standard frames for use in surplus-chambers. In my case I find myself with a number of worked-out shallow-combs on hand, and wishing to increase my stocks by building-up some new ones from driven bees, these combs are useless to put them on. I had, therefore, either to give them foundation (which you condemned) at this season, or to have the trouble to remove side and bottom bars, replacing them with those of the full or standard size. This I did, and as the combs were "wired" in the frames I was able to make a very fair job of them, but even then they were not so good as if built by the bees earlier in the season.

My intention, therefore, is (unless convinced that it is wrong) to alter all my shallow-frames and surplus-chambers into

deep ones, and only work the full-sized standard frames in future. I shall then have combs on hand suitable for all purposes, and hope this plan will meet with your approval.—E. HAWKINS, *Derbyshire.*

[It is a curious but well-known fact that beginners—ourselves included, in the far-off days when we made our start with bees—know far more than the most experienced bee-keeper who ever lived. We need, therefore, do no more, by way of explaining why a shallow-frame is just as useful for its own purpose as is one of larger size in the same direction, than say it is open to any beginner to improve on known and tried methods whenever he can.

But with regard to our "approval" of the plan with which our correspondent closes his interesting note, we advise him to gain a little more experience (or procure a copy of the "Guide Book" and read it) before altering the frames as proposed; because he would, by so doing, be simply taking a retrograde step which would land him in the conditions of ten or fifteen years ago, instead of being "up-to-date" in his bee-keeping.—Eds.]

#### BEEES IN MID-CORNWALL.

[5245.] The season here has been very short, but very *sweet* while it lasted. We have had an abundance of white clover, which came into bloom nearly a month later than its usual time. The honey-glut came on about July 1, and I never knew bees store faster than they did during the next fourteen days; but on St. Swithin's Day the weather broke up, and after that very little was done in this district. Those who, by careful stimulative feeding all through the inclement spring up to the end of May, managed to build up strong colonies, were able to take advantage of the short flow, and were well repaid for the time and trouble. On the other hand, those who neglected that most important part of work in the apiary missed the chance entirely. My strongest colony covered thirty-two standard-frames, and then there were bees enough to cover another ten frames could I have managed to erect the fourth story. I allowed twelve frames for the brood-nest, and gave two supers of ten standard-frames each, placed slightly wider apart than in the brood-nest. From the supers thirty frames beautifully filled and sealed were extracted, and two more from the back of the brood-nest; and had the fine weather continued a fortnight longer, I should have beaten my record take from one hive.

Stocks have gone into winter quarters unusually strong in numbers, probably owing to the fact that the brood-chamber was not overcharged with honey, as is often the case in July and early August. Late swarms are badly off, and are causing a little trouble by robbing.—J. O. CLEMMOW, *Ladock, September 22.*

## THE SEASON IN DERBYSHIRE.

[5246.] As you have not yet printed any reports from this district, I send you the following.

So far as I can learn, most stocks survived the winter of 1902, but the spring proved very trying, many colonies dwindling away instead of getting strong. One neighbour of mine lost five out of seventeen stocks, another two from five, and a third one out of two. I have also heard of other losses. For myself, on June 1 (our real first bee-day), I found the queen of one hive alive, but barren. I therefore united the bees to another stock.

The cold and wet then returned and continued till June 22; then for several weeks it became apparently suitable for honey gathering, and I expected great things. The bees were strong, the clover bloomed well, and plenty of it, but the yield (20 lb. per hive) was disappointing. This was all the more remarkable, seeing that our 1902 season lasted but ten days, and I had a crop of over 40 lb. per hive. Since mid-July we have had damp, cold winds with an odd nice day or two. Taken altogether, our weather has been a queer mixture of cold and wind and wet.

I am pleased to say that so far as my own knowledge goes we are for several miles round clear of foul brood.—E. H., *Chesterfield*, September 20.

## PACKING BEES FOR WINTER.

RESERVING BOTH QUEENS IN "WELLS" HIVES.

[5247.] Now that the time has come when we are about to prepare our bees for the winter, I think it will not be out of place to say a word as to packing of "Wells" hives so as to preserve both queens and save the disappointment that so often occurs of losing one queen during the winter, as I myself have experienced it. My plan is as follows:—Take out the closure board from one end of hive, draw all the ten frames back to outer end, then place the closure board removed from the end in the middle beside the "Wells" dummy, pack down snugly, and all goes well. Other methods may be used, and one that might suit many better than the above would be to have a dummy board to take the place of the "Wells" dummy, which is removed altogether, but either plans will prevent the queens worrying one or other to death, or the bees killing one or other, as the case may be, when they are clustered so closely in winter. That is the main point, and the bees do not lose much warmth by it, as they still have a warm board to cluster on.—CHAS. GARNER, *Soham, Cambs*, September 16.

[Without being over-sanguine with regard to the efficacy of Mr. Garner's plan we will be glad to have the results after a further trial. The loss of one queen in winter is a very weak spot in the double-queen system.—EDS.]

## QUEEN REARING IN AMERICA.

BY J. M. HOOKER.

(Concluded from page 379.)

Nearly every bee-keeper nowadays starts his cells by taking up a few bees in a screen-covered or ventilated hive-body; and, after the cups are well under way, said bees are returned to the hive from which they were borrowed, the cups being given to full colonies to be completed.

[The illustration below, which did not reach us in time for last week's issue, shows the "Grace Cell Compressor" mentioned on page 377; also the "Swarthmore" Nursery Cage in which the queens are raised.—EDS. B.B.J.]

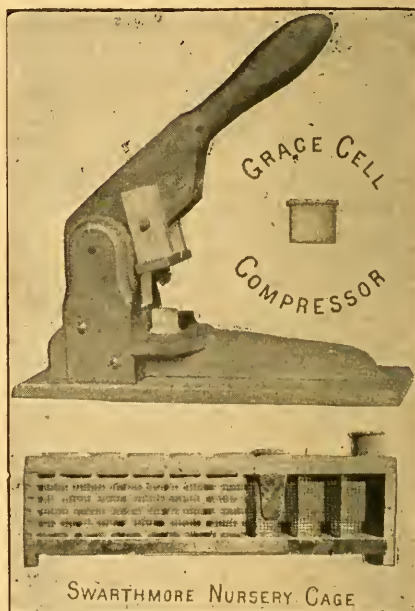

Instead of returning such bees to the loaning colony they may be used in forming small nuclei by using the screen shown on page 379 (fig. 2); and at the height of the season the loss will not be felt by any strong colony.

At one end of your screen-covered hive-body bore a  $\frac{3}{4}$ -in. hole and provide a cork which can be quickly drawn and replaced in said hole at will. Remove the started cups at about 10 o'clock in the forenoon, and by noon (or before) the bees will be wild to escape from their confinement in the screen-covered hive-body.

Place the escape-hole toward the light, and darken all other openings. Now place a confining-screen above the escape-hole; and as you draw the cork, slide the screen downward and over the hole, in alignment with the hole, into the hive-body. The bees will imme-

diately pour out of the hive-body into the confining-screen. It is like drawing honey from the extractor. Let them fill the screen quite full, then slide it up, and at once cork the hole. Place the thumb over the hole in the confining-screen (keeping the wire toward the light), and at once clap the screenful on to the front of a nucleus-box, as shown in the photograph (fig. 1); attach it there by the use of

however, any bee-keeper can run his boxes for months without loss, and at a minimum of expense.

If a handhold-like slot is cut directly over the escape hole, on the inside of the hive-body, covered with a strip of drone-excluding zinc, any undesirable drones will be sifted out as the bees pass from the hive-body into the confining screens.



THREE HUNDRED "SWARTHMORE" MATING-BOXES AT WORK.

staples, as plainly shown. Now bring on another screen, and another, until all the bees have been drawn from the hive-body. If any are left they can be returned to the hive from which they are borrowed, in the usual way.

After all the boxes have been supplied, drop a just-hatched virgin into each box, or supply a hatching cell through the hole in the lid, and at evening set out the boxes and remove the confining-screens.

In the photograph seen above the mating-boxes are set out singly, but they may be grouped in twos and fours as illustrated in *Gleanings* by Mr. Greiner. Each is provided with a little stand and covered with a board. Feeding is done by means of vials covered with muslin or screw-tops, or candy forced into a cage inverted on top of each hive.

Remove all queens as soon as mated, and in three days drop in another just-hatched virgin or a ripe cell.

If testing is desired, cover the flight-hole with a bit of zinc to prevent the queen from leaving the box after fertilisation.

When any of the nuclei show signs of weakness, take the queen and brush the bees into the next box three days later, and on the next round restock the empty boxes. It is just as easy to run bees into screens in this manner as to return them to the hive; therefore any losses from any cause may be quickly and cheaply made up. With a little experience,

## Queries and Replies.

[3233.] *Bee Farming in Canada.*—A friend and myself are thinking of going to live in Canada. We have private means between us amounting to about £400 per annum, and propose establishing a bee-farm. I therefore ask:—1. Is Manitoba suitable? 2. Is the climate generally favourable to bee-keeping? 3. What chances are there of our success? My friend is an able hand at carpentry, and I have been keeping bees for about a year, though not more than six stocks, for want of time; but I am enthusiastic in my interest in them. We should be able, therefore, to make things "hum" between us. I shall feel much obliged for your advice. 4. Would a little time spent on a bee-farm here in England be an advantage before leaving? I send name, &c., for reference, and sign—CANADA, *Bristol*, September 18.

REPLY.—1 and 2. Manitoba is not comparable to Ontario for bees or bee-farming, the former place being mainly a corn-growing province, with but little bee-forage available. 3. There are some extensive bee-farms in Ontario, and honey is more freely used there than in England as an article of daily food. 4. It would be far more advantageous to spend a few weeks on a Canadian bee-farm, where the Colonial methods of working could be

studied. We could put you in communication with a suitable bee-farmer if it is decided to go out.

[3234.] *Preparing Bees for Wintering.*—I am much indebted for former kind advice; and, being only a beginner in bee-keeping, I should feel helpless without it. I am now feeding up my bees according to directions but have not been able to get soluble phenyl, from the local chemist's, so I have to give them ordinary sugar syrup prepared as recipe in the "Guide Book." Will that answer the purpose? I was told at the chemist's that they did not know what soluble phenyl was. I therefore ask:—1. Is soluble phenyl a necessary ingredient in syrup food? Please say where and how I can obtain it. 2. As regards wintering bees, I do not quite understand the instructions for packing the hive with chaff. I have two frame-hives, each of which contains only one dummy. If I put chaff between that and the outer side, a chaff-cushion or two or three warm quilts above the body-box, and telescope the two lifts down over it, will there be sufficient protection from the cold? I have had very little honey this year, so am anxious to keep the bees in good condition to start work early next season. I am waiting for favourable weather in order to complete the uniting of two stocks. One, a driven lot, temporarily housed in a frame-hive, is decidedly a small one, but the other seems very strong; in fact, the hive seems full of bees (it has been swarmed from this year). 3. Is it possible there will be too many when united? Thanking you in anticipation. — COUNTRY WOMAN, September 10.

REPLY.—1. It is considered useful and desirable to medicate syrup-food given to bees for wintering on, otherwise it would not be recommended in the "Guide Book." Soluble phenyl may be had from Messrs. Morris, Little, & Co., wholesale chemists, Doncaster, price 1s. per bottle. 2. Some bee-keepers do not trouble to pack hive-sides at all for winter. Your proposed protection will be ample. 3. There is no risk of over-stocking your hive by uniting the two lots.

[3235.] *Carniolan Bees and Dark Honey.*—I am forwarding you two samples of honey. The light, No. 1, was gathered by native or brown bees; No. 2, dark, was gathered by Carniolan bees, the queen of which I purchased two years ago. Having had several swarms, all of which gathered dark honey, I ask—1. Can you tell me whether it is the experience of other bee-keepers who keep Carniolan bees? 2. Also do you think the light honey is suitable for show if entered in the medium class? The past honey season has been a very poor one here. Stocks were strong in the spring, and only wanting fine weather, which we had a few days in June, when we hoped some good work would be done, but instead of gathering, swarming was the rule, and by the

time the bees had settled down all the fine weather had gone. We had a splendid lot of white clover the end of July and beginning of August, but the bees were unable to gather from it owing to the wet weather. I should be glad to know what is your opinion of the honey. — WEST SOMERSET, September 23.

REPLY.—1. The colour of No. 1 sample is just on the line between "light" and "medium," but it should be entered in the latter class. The colour of honey is not influenced at all by the race of bees that gather it, and we have never heard it said that Carniolans are different from other races in this respect. 2. Much of the honey secured this year is unusually dark in colour. Your No. 1 should, as stated above, be shown in the "medium" class.

[3236.] *Bee Paralysis or Foul-Brood?*—I shall be pleased if through columns of BRITISH BEE JOURNAL you will advise me as to enclosed frame of brood—if there are any signs of foul brood in combs? The bees have been dying off from the hive nearly all summer; they seem to stagger out of the hive and roll off on to the ground and crawl about until they die. There are still about seven frames covered with bees, but they have very little sealed honey, and had none taken from them this season. There is nothing like it at any of my other hives. All the centre frames are similar to the enclosed as regards brood. I send name and address for reference, and sign—PUZZLED, Sheffield, September 11.

REPLY.—There is no trace of disease in comb, all brood appearing in normal condition and hatching out right. It seems a probable case of the disease known as bee-paralysis, and we reprinted an important article from the *American Bee-keeper* on page 372 last week dealing fully with the subject.

[3237.] *Removing Skeps after Transferring.*—During this season I have been allowing the bees of three skeps to transfer themselves into frame-hives by placing the skeps over the top bars. Now I wish to remove the skeps and extract what honey there may be in them. 1. Shall I do so by first driving the bees, according to the "Guide Book," and then running them into the frame-hive? 2. I may say that I tried to clear one of the skeps by placing it over a "bee escape" board. But the bees stuck to their skep, though I left them the whole night. Was that because the queen happened to be in the skep at the time? 3. Can you give me the name and address of the visiting expert for this neighbourhood? I enclose my card and sign—NEMO, Kent.

REPLY.—1 and 2. The bees may be driven from skep and run into frame-hive as stated; but had the super-clearer been left on long enough the bees would have gone down, unless the queen is still breeding in skep. This could be ascertained only by examining the combs in



skep after driving the bees. 3. If you are a member of the Kent B.K.A., write the Hon. Secretary for name of expert.

[3238.] *Removing Granulated Honey from Shallow Frames.*—1. Is there any way of getting honey that has granulated out of comb without breaking the combs? 2. Which is the best foundation to use for extracting, brood or section? 3. Is it advisable to wire shallow-frames when fitting them with full sheets of foundation? 4. There are acres of *Erica vulgaris* and *E. cinerea* growing around here, but the bees never gather enough honey from it to store in sections. Can you tell me the reason why? We are nearly 900 ft. above sea-level, and so it is, perhaps, too cold. The bees, however, work on the heather a good bit.—F. DEWDNEY.

REPLY.—1. No; the combs will need melting in a vessel, which latter is immersed in hot water. When the honey becomes liquefied the wax will rise to the surface, and may be lifted off in a cake after cooling. 2. Brood foundation. 3. There is no need for wiring shallow-frames. 4. We cannot understand bees not storing freely from the heaths named if weather is favourable for honey-gathering. The high altitude should rather be favourable than otherwise.

[3239.] *Dealing with Unfinished Sections.*—I have three frame-hives, and on one of them I put two racks of sections, and the stock was seemingly doing well when the weather was good in July, but the whole of August was so entirely bad for honey-gathering that the bees stopped working, and at date of writing the sections in top rack are unfinished. One or two sections appear to be filled, and the rest are full of comb, but no honey. 1. Should I take these away now or leave them till the end of September? 2. Shall I feed with candy or syrup? If the former, must it be placed on top of section rack? 3. The bees are throwing out a few white immature bees and grubs to-day; what is the cause of this? I have kept bees for some time now, but only in square boxes, and got nothing from them, but as I have now obtained the proper hives I am going to give them more attention. I have got the "Guide Book," and also take the *JOURNAL and Record*. I send name for reference, and sign myself—ARDRUNDEL, *Islay, N.B.*

REPLY.—1. If there is any heather in your district the sections may remain till end of the month if wrapped up warmly, but not otherwise. 2. No feeding at all must be done while sections remain on. We assume that you know this. 3. It indicates the cessation of honey income, and rather points to removal of unfinished sections as desirable.

[3240.] *Soluble Phenyl for Bee-Food.*—I am in a quandary. I made up some syrup for my bees; but they refuse to take it down. I have made it exactly as prescribed in "Guide

Book" except that I have used *phenol* instead of *phenyl*. The chemist of whom I got it assured me the only difference was in the name. Can you say what is the reason of the bees refusing it and what I am to do? I put about half teaspoonful of phenol to a quart of syrup. I have tried giving it to them cold, and also warm, but they will not have it. 1. Can you say why? 2. Also say if I must raise my "Cowan" hive off the ground for winter, and if so what sort of stand I ought to put it on? You will, of course, gather from queries that I am but a novice; but may I say how grateful I am for your little paper. Its notes and queries are a mine of interesting and useful information, and I, at all events, read with [very great enjoyment the articles of your correspondents, "D. M. M., Banff," "W. Woodley, Beedon," "L. S. Crawshaw, Halifax," &c. 3. Will you kindly also let me know the name of the secretary of the Norfolk Bee-keepers' Association?—H. P., *Norwich, September 18.*

REPLY.—1. Soluble phenyl is entirely different from phenol, the latter being used in bee-food only in the small proportion of 1 in 500 (see reply to "Country Woman," page 388). 2. If hive stands on the ground raise it on four bricks. 3. The Hon. Sec. of the Norfolk B.K.A. is Mr. J. G. Cooke, Melton Constable.

[3241.] *Building up Stocks from Driven Bees.*—Will you kindly advise me regarding the following? On August 15 I bought three lots of driven bees, two lots of which had been already united in a skep, and we threw down these and the third lot together in front of a "W.B.C." hive (fitted with full sheets of foundation in frames), dusting the bees with flour as they ran in. Unfortunately it was late (7.15 p.m.) when the bees arrived, and not being able to distinguish either of the queens, we had to leave them to settle the matter of supremacy amongst themselves. They seemed to have quietened down nicely next day, but a few days afterwards I noticed the bees were running about the alighting-board and not working like two other lots of driven bees I had hived a few days before; however, as some were carrying in pollen occasionally, I did not disturb them. On September 1 (a nice warm day) I opened the hive to see how matters were progressing, and found queen-cells on two of the frames, six or seven altogether; next morning I found five or six newly hatched young queens cast out on the alighting-board. I therefore ask—1. What do you think happened to the old queens that made the bees depose them? And also, if the queens were killed at the time of uniting, how did they procure eggs to hatch the young queens? 2. Do you think there is any chance of the young queen getting mated so late in the year; and, if not, would it be advisable to get a nucleus of Carniolans and unite them after destroying the young queen; or should I have too great a difficulty in finding her if un-

mated? I have been feeding them every evening since I got them with half-a-pint of syrup medicated with naphthol beta. I send name and sign—PERPLEXED, *Newton Abbot, September 11.*

REPLY.—1. The obvious conclusion is that both queens have disappeared, the second one evidently coming to grief a few days after uniting when the disturbance was noticed. 2. No chance at all. You had best purchase a young fertile queen and introduce her. These may now be had cheap (see advertisement columns).

## Bee Show to Come.

*A nominal charge of 2s. 6d. is made for notices in this column, which covers cost of insertion from order till date of show. Cash should accompany orders for insertion.*

October 6 to 9, at the Agricultural Hall, London.—Show of Honey and Bee-produce in connection with the British Dairy Farmers' Association. Numerous and liberal prizes for honey, &c., including the valuable Silver Challenge Cup of the B.B.K.A. Schedules from Mr. Wm. C. Young, Secretary, 12, Hanover-square, London, W.

### Notices to Correspondents & Inquirers.

*Letters or queries asking for addresses of manufacturers or correspondents, or where appliances can be purchased, or replies giving such information, can only be inserted as advertisements. The space devoted to letters, queries, and replies is meant for the general good of bee-keepers, and not for advertisements. We wish our correspondents to bear in mind that, as it is necessary for us to go to press in advance of the date of issue, queries cannot always be replied to in the issue immediately following the receipt of their communications.*

\*.\* A correspondent, who dates from Wolverhampton, writes us regarding what he calls "a case of fraud committed by means of an advertisement in our paper." We rather fear our correspondent does not realise the serious liability attaching to the use of the word "fraud" applied to the advertiser in question, and having no intention to share the liability, we cannot print the particulars given. Moreover, we happen to know the advertiser in question as a respectable man, and have no doubt that the fault complained of is capable of full explanation. Anyway, we are writing him on the subject.

\*.\* A correspondent writes:—"Will some experienced bee-keeper—such as Mr. W. Woodley, for instance—kindly tell me how many stocks of bees a man can look after, provided he gives his whole time to it, with the object of securing a livelihood by bee-keeping?"

D. B. (member Devon B.K.A.).—1. A series of papers on "Our Wild Bees," by Mr. F. W. L. Sladen, appeared some time ago in our columns, and may be had on applica-

tion at usual price. 2. Books on the subject with coloured illustrations are naturally costly, and if price is no object may be had from Messrs. Lovell, Reeve, & Co., publishers, London.

P. BARRY (Burwash).—*Raw Sugar for Bee-Food.*—Raw unrefined sugar as sample is quite unsuitable for making winter bee-food, and would be very likely to cause dysentery.

E. W. APPLETON (Walthamstow).—*Purchasing Queens.*—We have had many complaints similar to your own, due no doubt to the difficulty of attending to the number of orders received by the advertiser, whom we know as a reliable man. On the other hand, there is no connection whatever between "Expert" and the B.B.J. office.

W. T. C. (Ilford).—*Extracting Granulated Honey from Shallow-Frames.*—There is no means of extracting granulated honey from shallow-frames of comb other than melting the latter down and allowing the wax to rise to the surface for removal when cold.

#### Suspected Combs.

ANXIOUS (Beddington).—1. There is no disease in comb sent. It contains chilled drone-brood in worker-cells. 2. Honey as sample is of poor quality only, and would not be very suitable for market.

J. S. (Cambs).—So far as we can judge from the crushed sample sent, there is no disease in comb; but a proper piece of comb should be supplied, and full name and address given for reference.

F. B. (Dorking).—Comb is badly affected with foul-brood, and we should destroy the stock from which it was taken. With regard to the others suspected, you should deal with them as directed in "Guide Book," treating them according to condition after a full examination of the combs.

A. T. (Balcombe).—Comb is badly affected with foul-brood of old standing. We advise entire destruction of the stock it came from.

NOVICE (Devon), and J. MILLS (Yorks).—There is foul-brood of old standing in samples of comb sent.

J. C. (Glam., Wales).—No disease at all in comb sent.

F. W. (Addlestone).—There is decided foul brood in comb sent.

R. B. (Devon).—Comb is affected with foul brood.

#### Honey Samples.

F. R. C. (Newton Abbot).—No. 1 is good in colour and consistency, but has a pronounced "tack" in flavour, which tends to spoil it as a table-honey. No. 2, though a little darker in colour, is of nice flavour, and will do well for market or table use.

\*.\* Several Letters and Queries are unavoidably held over till next week.

## Editorial, Notices, &c.

### SURREY BEE-KEEPERS' ASSOCIATION SHOW AT CRYSTAL PALACE.

The annual exhibition of the Surrey B.K.A. was held in the large concert-hall in the Crystal Palace on September 17, 18, and 19, and, notwithstanding the past unfavourable season, the show was a great success, and a record one, resulting again in the largest display of honey and honey produce, bees, hives, and appliances staged at any show held this year. The total entries in the twenty-four classes numbered 283.

Favoured by fine weather, Mr. C. T. Overton gave lectures and demonstrations each day in the Association's bee-tent in the grounds to large audiences.

The honey staged made a fine display, both in the local and open classes, the honey being of very high character. The trophies were a distinct feature, as was also an interesting and instructive exhibit connected with bee-culture and of bee-products, which attracted much attention, and was awarded the bronze model of the Warwick Vase.

Fine collections of hives and appliances were staged by Messrs. Lee & Son, E. H. Taylor, C. T. Overton, and C. J. Greenhill.

Messrs. F. Brett and A. J. Carter officiated as judges, and made the following awards:—

#### MEMBERS' CLASSES.

*Twelve 1-lb. Sections.*—1st, C. W. Palliser, Wandsworth Common; 2nd, C. T. Overton, Crawley; 3rd, E. Bontoft, Caterham Valley; h.c., G. B. Bisset, Wallington, and Mrs. Cokayne, Putney Heath.

*Six 1-lb. Sections.*—1st, C. W. Palliser; 2nd, T. Earl, Crawley; 3rd, H. Sayers, jun., Chessington; v.h.c., D. H. Welch, Wray Park, Reigate; h.c., J. Bradford, Wimbledon; H. A. Carey Ligh, Reigate.

*Six 1-lb. Sections of Heather Honey.*—1st, G. Chandler, Eversley; 2nd, A. Seth-Smith, Cobham; 3rd, E. P. Betts, Camberley; v.h.c., W. E. Hackett, Cobham.

*Three Shallow-Frames Comb Honey for Extracting.*—1st, E. Bontoft; 2nd, T. H. E. Watts-Silvester, Surbiton; 3rd, J. Kachler, Croydon; v.h.c., R. C. Blundell, Horley; h.c., G. F. Saunders, Holmwood, Dorking.

*One Shallow-Frame Comb Honey for Extracting.*—1st, A. Watkin, New Malden; 2nd, H. Sayers, jun.; 3rd, E. Bontoft; v.h.c., T. Earl, h.c., T. H. E. Watts-Silvester, G. Saunders.

*One Standard-Frame Comb Honey for Extracting.*—2nd, E. Bontoft (only one prize awarded).

*Twelve 1-lb. Jars Extracted Honey (Light).*—1st, C. W. Palliser; 2nd, W. Sole, Wimbledon; 3rd, E. Bontoft; v.h.c., G. Saunders; h.c., F. Silvester, Capel.

*Six 1-lb. Jars Extracted Honey (Light).*—1st, C. W. Palliser; 2nd, L. Vidler, Rye; 3rd,

E. Bontoft; v.h.c., C. H. Willatt, New Malden; h.c., J. Bradford, W. Sole.

*Six 1-lb. Jars Heather Honey.*—1st, G. Chandler; 2nd, E. P. Betts; 3rd, E. Walker, Maybury, Woking; h.c., A. Brightwell, Liss.

*Six 1-lb. Jars Extracted Honey (Dark).*—1st, H. Dann, Wallington; 2nd, A. E. Mumford, Redhill; 3rd, E. Bontoft; v.h.c., C. T. Overton; A. H. Hamshar, Bramley; h.c., R. C. Blundell, T. H. E. Watts-Silvester, T. Earl; T. Peed, Streatham.

*Six 1-lb. Jars Granulated Honey.*—1st, W. Sole; 2nd, M. J. Lamboll, Chiddingfold; 3rd, A. Brightwell.

*Display of Honey and Bee Products (exceeding 100 lb.).*—1st, F. B. White, Redhill; 2nd, C. T. Overton.

*Beeswax.*—1st, H. A. Carey; 2nd, G. Chandler; v.h.c., J. Kachler; h.c., J. Davis, Cranleigh.

*Articles of Food containing Honey.*—1st, T. Earl; 2nd, A. Seth-Smith.

#### OPEN CLASSES.

*Six 1-lb. Sections.*—1st, A. W. Weatherhogg, Willoughton; 2nd, C. Lodge, Chelmsford; 3rd, S. Cartwright, Shawbury, Shrewsbury; v.h.c., L. Bailey, Itchingfield, Horsham; h.c., F. A. Kent, Dorset; Miss N. J. Taylor, Stevenage, Herts.

*Six 1-lb. Jars Extracted Honey (Light).*—1st, W. Cook, Market Rise; 2nd, W. Patchett, Caistor; 3rd, T. G. Hallier, Andover, Hunts; v.h.c., J. Jones, Caraforth; S. Cartwright; G. W. Kirby, St. George, Bristol; h.c., C. Squire, North Devon; A. G. Praen, Nesscliffe, Shrewsbury; Jas. Lee & Sons, Andover.

*Three Shallow-Frames Comb Honey.*—1st, Jas. Lee & Son; 2nd, F. A. Kent; 3rd, E. R. Nash, Smarden, Kent; h.c., Rev. M. W. B. Osmaston, Goodnestone, Dover.

*One Shallow-Frame Comb Honey.*—1st, F. A. Kent; 2nd, Rev. M. W. B. Osmaston; 3rd, E. R. Nash; h.c., R. C. Blundell.

*Beeswax.*—1st, C. Lodge; 2nd, A. G. Preen; 3rd, G. Leeding, Sherborne, Dorset; v.h.c., F. J. Old, Piddington, Northampton; J. M. Cann, South Devon; C. Squire; G. W. Kirby; h.c., W. Patchett.

*Interesting and Instructive Exhibit connected with Bee Culture.*—1st, F. B. White.

*Observatory Hive with Bees and Queen.*—1st, A. E. Mumford; 2nd, E. H. Taylor, Welwyn, Herts; 3rd, C. T. Overton.

*Collection of Hives and Appliances.*—1st, C. T. Overton; 2nd, E. H. Taylor; 3rd, C. L. Greenhill, Wimbledon.

(NOTE.—Messrs. Jas. Lee & Son's exhibit did not arrive in time to be put up for judging.)

*Complete Frame-Hive for General Use.*—1st, E. H. Taylor; 2nd, C. T. Overton; 3rd, C. L. Greenhill.

*Outfit for Beginner in Bee-keeping.*—1st, E. H. Taylor; 2nd, C. T. Overton.—(Communicated.)

## GROCERY EXHIBITION.

## THE HONEY MARKET.

The *Daily Telegraph* devotes a long and interesting article to the Honey Section of the late Show at the Agricultural Hall, from which we quote the following:—

“As an article of food honey takes a place far less important than it should enjoy on its merits, but the fact that a distinct department is devoted to it at the Grocery Exhibition at Islington may do something to vindicate its undoubted claims. Recognising the necessity alike for the encouragement of apiculture and of establishing a thoroughly reliable standard of merit for honey, the British Bee-keepers' Association, under whose auspices this competitive display is being held, has done a great work in organising the industry, and from Mr. Herrod, the lecturer and demonstrator on this subject at the Horticultural College, Swanley, it is satisfactory to learn that bee-keeping upon sound and intelligent lines is rapidly extending in the country. Ladies in particular are taking it up, and are finding it a profitable addition to poultry rearing or fruit and flower growing, and it would seem that the demand for honey of whose purity there is no doubt is likely to increase widely. In a number of the sanatoria for the outdoor treatment of tuberculous disease honey is playing a large part in the prescribed dietary, and is even found to be a substitute for cod-liver oil, while it has been proved that sufferers from dyspepsia can use it with impunity in place of sugar with coffee. The consumer very naturally asks by what means he or she may secure a genuine English and unadulterated product, and it may, therefore, be stated at once that county associations in affiliation with the British Bee-keepers' Association have been called into existence throughout the land. To these local societies the individual owner of hives pays a nominal subscription, and is visited by an expert, who helps him to grade and classify the honey. Labels bearing his registered number are supplied to him, and should the buyer into whose hands the honey ultimately comes have reason for complaint, the source can be traced, and the offender suitably dealt with.

It is a fact, however, that the consumer is still in need of education as to the characteristics of good honey. Current prejudice is decidedly in favour of a clear, light, and ungranulated honey. The palest honey comes from the white clover and the sainfoin flower, though the latter in the comb is distinguished by the more golden tint of the wax. The average purchaser would probably hesitate before the slightly green tint which the lime flower imparts to the honey, yet this nectar possesses a peculiarly delicate and delicious flavour. The rich deep tone which belongs to the product of the heather is to the uninitiated a disadvantage, though there is no finer honey than that drawn from the breezy stretches of

heath. Again, there is a distrust of the granulation, or solid formation of honey, though this natural process is merely due to exposure to the light, and its appearance should be accepted as proof of the purity of honey. Wherever glucose—which, though not in itself unwholesome, is a very cheap and inferior substitute for the real thing—is admixed, granulation will not take place. This fact has in the past led cautious retailers to make the simple test before ordering, but the wary adulterator now meets this by introducing a little fine oatmeal, and triumphantly points out that the accepted sign of genuineness is already beginning.

Whatever may be claimed by other countries in respect of their honey, there is none in the world finer than that from our own countryside. The Swiss honey that reaches these markets is notoriously adulterated, so much so that in many instances it is frankly labelled as blended with sugar. Nor does that from Jamaica bear a high character among experts. The present season has not been at all a favourable one in England for the bees, though in certain districts the harvest of the hives has been exceptionally abundant and high in quality.”

## Correspondence.

*The Editors do not hold themselves responsible for the opinions expressed by correspondents. No notice will be taken of anonymous communications, and correspondents are requested to write on one side of the paper only and give their real names and addresses, not necessarily for publication, but as a guarantee of good faith. Illustrations should be drawn on separate pieces of paper. We do not undertake to return rejected communications.*

*Communications relating to the literary department, reports of Associations, Shows, Meetings, Echoes, Queries, Books for Review, &c., must be addressed only to "The Editors of the 'British Bee Journal,' 10, Buckingham-street, Strand, London, W.C." All business communications relating to advertisements, &c., must be addressed to "THE MANAGER, 'British Bee Journal' Office, 10, Buckingham-street, Strand, London, W.C."*

## PACKING BEES FOR WINTER.

PRESERVING QUEENS IN "WELLS" HIVES.

[5248.]—Referring to the letter of Mr. C. Garner (5247, page 386) in which he gives his plan for preserving both queens in "Wells" hives, I scarcely think that the loss of one queen is caused through her being killed by the queen next door. As a rule, the bees propolise the perforations in "Wells dummies," consequently the queens cannot reach each other. In my opinion it is entirely unnecessary and undesirable to use perforated dummies at all; a thin  $\frac{1}{4}$ -in. unperforated dummy will do better and save the bees' time in closing up perforations. It should be metal-bound to prevent warping. Except that "Wells" hives are too large for one man to lift, they possess many advantages over single ones. Small lots of bees build up quickly in them. I got an average of 58 lb

per colony from my "Wells" hives this year, and the bees had all the comb to make too, being new lots. They had only foundation supplied them, and were, of course, fed in the early part of the season. I had only five colonies in them in working order for the present year's honey-flow, and these five gave me 288 lb. of honey in shallow-frames. The remainder was obtained from small "casts" which have now in these hives worked up to the position of established stocks.

*Painting Hives Inside and Outside.*—Some time ago a correspondent recommended "Hall's Sanitary Distemper" for painting the interior of bee-hives. I have just tried "Hall's Washable Distemper" for outdoor use. I painted my six "Wells" hives with it in three hours with a fair-sized painter's brush, using the colour known as "Portland cement." It is much easier to use than ordinary paint, and only requires mixing with warm water, the brush, after use, simply needing to be washed in water. All colours can be obtained, and I intend to paint the alighting-boards of my "Wells" hives each a different tint to prevent the queens mistaking their own hives when returning from the mating trip. If this "Distemper" paint stands as well as is stated, it should be the best paint for hives that I know of, and the cheapest for the purpose.

*Bee-Work in Cornwall.*—Down here in Cornwall many operations in bee-keeping which would be then unsuitable up north may be performed very late in the year. Queens mate all right in August, and bees may be fed with liquid food to a much later period than is advisable elsewhere. We get plenty of wet weather but not much cold, and for that reason bees need a larger supply of winter stores because of their remaining active much longer. They also require to be kept breeding as late as possible, such, at least, is my experience.

I have obtained my bees from four different counties because I think a mixture of blood strengthens the race and helps to prevent foul brood. Anyway, I am well satisfied with my present stocks and should have a splendid strain of bees for the future work. With one lot purchased in straw skeps the wax-moth was imported in great plenty, but I think I have cleared them out now by constantly overhauling the colonies and killing the grubs. I cannot find any more. I do not, however, intend to buy any more bees in skeps without personal examination first, and not then if I can help it as skeps are a very great nuisance in every way.—W. J. FARMER, *Truro*, September 25.

## CLARIFYING DARK HONEY.

AN INTERESTING EXPERIMENT.

[5249.] With regard to very dark or black honey, of which I have, along with many others, a good quantity on hand this season, it may interest you to know that I gave a bottle

of quite black honey to a friend of mine to experiment with, with the object of removing the blackness. He subjected the bottle of honey for about three hours to ozone from an electrical machine, and returned it to me perfectly clear and bright. I have not gone very fully into the matter, but if in your opinion it would be of importance to the craft I would do so. I am told that the cost per cwt. is trifling.

It would appear that the effect of the ozone is to cause all the black matter to rise to the surface and then it is skimmed off.—R. D. GALBRAITH, *London, E.C., September 24.*

[We will be very glad to have further particulars as promised, and still more pleased if a sample of the honey in both conditions—*i.e.* dark and clarified—was sent us for inspection. There can be no doubt with regard to the interest of the subject to all who are honey producers if the action of ozone and electricity combined should in any appreciable measure bear out the promise of the above experiment without impairing the flavour of the honey.—EDS.]

## A QUESTION OF PRONUNCIATION.

"PRO," "PROP," OR "PROPO"—WHICH?

[5250.] In the second September issue of the B.B.J. there is an interesting criticism by Lieut.-Colonel H. J. O. Walker (5221, p. 353) on the pronunciation of, amongst several others, the term, Propolis.

As I do not pronounce this word as decreed by Colonel Walker, being thus convicted of a "grievous classical blunder," I have consulted a number of authorities on the subject, with a somewhat interesting result, as, whilst aware that the said authorities differed, I was ignorant of the extent of their disagreement.

The result of the investigation may be briefly put thus:—

Pro'po-lis.—Funk & Wagnall (1), Webster (1), Imperial, Worcester, Buchanan (Dic. Science), Annandale (Concise Eng.), Nuttall.

Prop'o-lis.—Funk & Wagnall (2), Webster (2), "Century," Stormonth, Eng. Encyclopaedia.

Prop'ō-lis.—Chambers' Eng. Dic.

If I have not taken too much for granted that the vowels in the second list are all short, it will be seen that there are here three distinct forms, and perhaps also that the weight of authority lies with the first mode of pronunciation. There may be others for aught I know, as I have merely consulted those lexicons which were conveniently to hand, and several of their covers were drawn blank!

It would appear that the first form is at least equally good from an etymological point of view, and where one has already adopted this, I should think it a labour of love, unnecessary almost to the verge of pedantry, to attempt a change, whilst even prop'ō-lis might be treated with a little toleration, for where

philological doctors differ to the above degree, one may almost be forgiven a quack diagnosis.

But I, too, am only anxious to assist the good cause, not to hinder it, and as it is a matter of some delicacy to attempt to correct at the time a word misused or wrongly handled, it would be well to have the question definitely settled, so that at least we may not be caught tripping over our own shibboleth!

There is no doubt that the English—or should it be the American—language is etymologically wealthy to an extraordinary degree, and whilst to a plain man, otherwise a man of plain speech, uniformity of orthoepy might be a boon, it would be a pity to easily lose the semblance of derivation, which in the present case would appear to be better retained in the pronunciation *Prōpōlīs*.

One might easily compile a lengthy list of commonly misused words. Amongst bee-keepers, for instance, Ligurian and Cyprian do not always get their correct emphasis.

I know one man of parts who insists with scholarly explanation upon the length of the Italian vowel in the penultimate syllable, thus, *Ligures'an*, and the second word *might* be *Sip'rian*, seeing that the bees are named from their native land of Cyprus, and not Kuprian from any fancied resemblance to burnished brass!

The cold-blooded dictionaries, however, insist upon *Ligu'rian* and *Sip'rian*, and their dictum must, I presume, be respected, although they do not always agree upon terms which would seem to permit no dispute.

Chitine, for instance, is rendered "*Ki'tin*" and "*Kit'io*," though I believe the former pronunciation to be the more generally used.

In spite, however, of such differences, scientific terms do not usually allow of much variation, and while there are no doubt many words which present difficulty to the student for the first time, much difficulty and divergence of opinion would be avoided if such were at once referred to a competent authority, which, in these days of Carnegie and the *Times*, is so easy of access.—L. S. CRAWSHAW, *Ilkley*.

#### A NEW APIARY AND FRUIT FARM.

[5251.] The recent personal announcements you have kindly made regarding myself and my recent change of residence having brought me a good many enquiries for particulars, may I be allowed space to say that I have now got settled in my new abode, and, in conjunction with Mr. L. McNeil Stewart, have established an apiary and fruit farm in Bedfordshire.

The apiary at present contains fifty colonies of bees, and it is intended to increase the number to over a hundred stocks next year. Fuller particulars referring to the "business" side of my new enterprise will in due course be found in its proper place—viz., the advertisement columns; but I specially wish to offer a word of explanation with regard to the

name by which our apiary will be known. After much persuasion, Mr. W. Broughton Carr has acceded to my earnest wish that our place shall be known as the "W.B.C." Apiary, but only on the condition of its being made known that he has no pecuniary interest whatever in the venture; and it is mainly for this purpose that I ask space to state the fact, while gratefully acknowledging his kindness in allowing me to use initials so well known in the world of bee-keeping. I need not say more beyond adding a line to the effect that private letters to me should be addressed, "W.B.C." Apiary, Old Bedford-road, Luton, Beds. Business letters to Herrod & Stewart, as above.—WM. HERROD, *September 28*.

#### A WORD ON JUDGING AT HONEY SHOWS.

[5252.] I have been a reader of your valuable *BRITISH BEE JOURNAL* for over ten years, and in its columns I have also read Mr. Jas. Waddell's letter explaining the super and non-sectional super for show purposes in *B.J.* of July 30, page 303. In my opinion Mr. Waddell is quite correct. At a local show in Midlothian I was surprised to see that the judges of honey awarded first prize to a bell-glass in the non-sectional class, also to a straw "top," which, according to schedule, was to be "not under 10 lb.," but was barely 5 lb. in weight, and not fit for the show table. The exhibitors were not in ignorance of "non-sectional," as I had told all interested in the honey class. The class for straw top read thus: "Straw top of honey not under 10 lb. No advantage given to any weighing over 10 lb.' A judge with show schedule in hand, and no interest in exhibitors, and awarding first prizes in such manner was doing a great injustice to other members.—FAIRPLAY, *Midlothian*.

#### "LOSS OF BEES IN TRANSIT."

[5253.] I think that many thanks from bee-keepers are due to your contributor, "D. M. M., Banff," for his interesting letter (5242, page 383) on "Loss of Bees in Transit." I have myself had experience more than once in the same direction, and he puts the matter in a very clear way in asking, "Shall we pay for dead bees?"—ROBERT MILLER, *Ayrshire, September 28*.

(Correspondence continued on page 396.)

#### HOMES OF THE HONEY BEE.

##### THE APIARIES OF OUR READERS.

The apiary on next page shows the beegarden of still one more gardener who is an enthusiastic bee-man. After twenty years' bee-keeping he is, we learn, always pleased to lend a helping hand to a beginner in the craft.

And we have in Mr. Evans a gardener who not only looks after the bees of his employer, but owns a neat little apiary of his own, in which the hives seen are all of his own make. This is the type of gardener we cannot too often commend as the best of friends to our craft, for they can—and not seldom do—arouse the interest of their employers in the bees. The “notes” he sends speak for themselves. He says:—

“I commenced bee-keeping as a hobby in the year 1883, my interest in the subject being aroused by a friend informing me of the pleasure and profit to be derived from the pursuit. From the same source I learned of the Bucks Bee-keepers' Association, and soon became a member. Naturally I began in a

for miles, driving bees to save them from the sulphur-pit, and bring them home on my ‘bike.’

There are no ‘big takes’ of honey in this district, such as those I read of in other parts of the country, perhaps the locality is more suitable for the rearing of ducks than for honey raising, as we are situated in the Vale of Aylesbury six miles from the county town. Nor is the demand for honey very large in these parts. As an instance of the truth of this assertion one of my customers (a lady who keeps her hunter) requested me to supply her with ‘half a section of honey.’ As it is not my custom to sell ‘split sections’ I need hardly say this ‘large order’ was politely refused.

With regard to foul brood, I am pleased to



MR. THOS. EVANS' APIARY, WADDES DON, AYLESBURY, BUCKS.

very small way, my stock at first consisting of a couple of skeps; but I gained experience by driving my friend's bees. Later on, and as experience was gained, I carried out my hobby on a slightly larger scale by purchasing a frame-hive and stocking it with bees, and as the need for more hives arose I began to make my own on the same principle, and soon discovered that frame-hives were far better than skeps.

I follow the occupation of a gardener, but for the last twelve years I have tended the bees of the late Baron F. de Rothschild. I am always ready to lend a helping hand to my fellow bee-keepers, and should any of these residing at a distance pass my way I should be pleased to receive a call from them. In the ‘driving’ season I scour the country around

say it troubles me very little. Most years I buy queens for introducing to my stocks. Last year's harvest was not very productive, and I fear that most bee-keepers, like myself, will not have a better honey season this year, so generally bad has been the weather during the gathering time.

The photograph sent shows my allotment apiary. The centre figure is myself, and that on my right is my cousin, who interests himself a great deal in bee-keeping and in the sale of honey. Before concluding allow me to add my tribute of praise to the B.B.J. I have been a regular subscriber for the past fourteen years, and have found it of the greatest help in many ways. May it continue to flourish for many a year to come for the benefit of bee-keepers.”

## CORRESPONDENCE.

(Continued from page 394.)

## PACKING BEES FOR TRANSIT

FROM THE SELLER'S POINT OF VIEW.

[5254.] In reference to the question of packing and despatch of bees, whether swarms or "driven lots," raised by your correspondent "D. M. M." in last week's JOURNAL (page 383), I cannot withstand the temptation to trouble you with a few observations. I am well within the mark in saying that the many articles which have appeared in your pages above his initials have been most welcome to readers as well as myself, being at once sympathetic from the point of view of both beekeeper and the bees, and, besides being interesting, are always clearly set forth. The matter is an important one for both buyer and seller, and I venture to write from the standpoint of the latter. With regard, then, to the question whether the buyer should "pay for dead bees," there can only be one answer, "No," for they are certainly not what he ordered; but whether seller or carrier should bear the loss can only be determined by considering each case on its merits. The fault may be with packer, and it may equally rest with carrying company or companies. Railway companies are a much abused people and certainly are not above suspicion, but common justice requires that such perishable consignments as "live bees" should be suitably packed and labelled; also that instructions on such labels be carried out. The most suitable package for the purpose, in my opinion, is one about 12 in. square by 10 in. deep, having perforated zinc 3 in. wide running the whole length of two sides, also pieces of the same 4 in. square in top and bottom, the box raised from the ground by strips  $\frac{3}{4}$  in. thick, and should be labelled: "Live Bees. Don't cover up. Keep in shade." Bees thus packed will travel hundreds of miles in safety, which has been proved over and over again. I have myself despatched over thirty lots, so far, this autumn (the proceeds of driving about seventy skeps) with only one minor complaint of condition on arrival; but if these most necessary instructions are disregarded, or there is unreasonable delay in transit, either party should be entitled to recover from the carrier in fault. I should like to point out before closing that the receptacle described by your esteemed correspondent hardly meets the case, because the strainer-cloth would be almost certain to get torn by the corners of other packages, and the consequent escape of bees would be disastrous; it is also open to doubt whether a railway company would accept such a package. I was almost invariably asked when I began sending bees by rail, "Are they secure?" or "Can they get out?" Trusting this subject will receive ventilation in more ways than one, I send name, &c., for reference and sign—H. D. D., *Beccroft, Basingstoke, September 26.*

## Queries and Replies.

[3242.] *Loss of Queen in Transferring.*—During August a skep of this year's bees had to be moved to a new location, and all the combs were unfortunately broken down in transit, and not being able to remove the broken combs, the bees were left to repair damages and reinstate themselves. But as great numbers of bees remained outside they were collected in another skep and placed above the original one, and in doing this the queen was seen and caught with the intention of running her in at the entrance of the old skep and thus inducing the crowds of bees outside to re-enter along with the queen. However, in the act of returning, she took flight and could not be traced. I therefore ask:—  
1. Would she be likely to return, the surroundings of spot being, of course, entirely strange to her? It would, I suppose, be too late to get the bees to raise a new queen, and useless even if one was reared. 2. What advice would you give?—M. W. D., *Clevedon, September 25.*

REPLY.—1. With regard to the chances of the queen returning to the hive, after taking wing, it is not only possible but probable that she did return unnoticed, unless those who watched for her return were experienced in such contingencies. It requires practically little more than a glance at the "surroundings" to enable a queen-bee to return to the spot from whence she takes wing. 2. The chances of your getting a queen mated will have probably been decided before this reply is in print, but, seeing that the mishap occurred last month, you should not have delayed writing till near the end of September. However, owing to the breakdown it is impossible to examine the combs in skep for evidence of the queen's return or of queenlessness, and the stock must therefore be left to take its chance of being still headed by the old queen or by a young one, fertile or otherwise, as the case may be.

[3243] *A Beginner's Difficulties.*—As a beginner I will be glad of a little advice under the following circumstances:—I bought a swarm of bees that came off about July 10 last and had them put in a frame-hive. About six weeks later the bees began turning out drones, and on my getting a bee-keeper to examine the stock and report its condition, he failed to find the queen, but said it was a good healthy colony with plenty of young brood in combs, so the queen, he said, must be there. I have since bought a copy of Mr. Cowan's "Guide Book," and after reading it carefully through, I have made two examinations myself, and have been unable to find the queen. Not only so, but there is now no brood in the combs. I have not noticed the bees acting in the way the "Guide Book" says they do on loss of queen. I was, in



consequence, thinking it likely that the queen was an aged one, and might have died off through old age. There was hardly any honey stored in the combs a fortnight ago; so I made syrup-food according to recipe No. 6, and, having fed the bees liberally, I examined them yesterday expecting to find most of the frames stored with syrup and capped over; but there are only about three filled and capped half-way down. I therefore ask:—1. Do you advise my purchasing a queen for introduction at once, or should I leave them alone till spring? 2. In the chapter on Queen-Rearing in "Guide Book" it says:—"To secure best results it is advisable always to have on hand a supply of fertile queens to meet contingencies." This being so, I ask:—If I purchase one now, how am I to keep her through the winter without introducing her with the bees? You will, no doubt, realise from the above that I am a beginner only, but anxious to learn. I send name for reference, and sign myself—NOVICE, *Knutsford, Cheshire, September 25.*

REPLY.—1. We advise deferring the purchase of a queen till the combs have been carefully examined by a competent bee-keeper, because it is not very unusual to find breeding for the year to be stopped early in poor seasons like the present one. With regard to food stored in the combs, no mention is made of the quantity of syrup given in feeding, but all not consumed is, no doubt, in the hive, sealed or unsealed. 2. The "contingencies" referred to in "Guide Book" as intended to be met by having fertile queens on hand are such as occur during the ordinary working season, and such queens are preserved for use till wanted in nucleus hives. It is not supposed that queens can be kept alive all winter in this way, but only during the summer and early autumn.

[3244.] *Trouble through Extracting Honey in the Open.*—The other day I was extracting some honey, rather near the house and, after completing my task, put it all away safely as I supposed, but next day we had a quantity of bees entering all the sitting rooms, and when I returned in the evening found many bees dead on the ground and a good number of others torpid. The servant said she had used the smoker to try and overcome the trouble caused by the bees. I am at a loss to know why they were in that state of commotion, and what is the reason of them causing such an upset? I put some out on flowers and they still seem in the same dazed state, and I thought possibly you might be able to explain matters. I am rather a novice with bees and was told that it was possibly caused by loss of the queen, but the bees seem to be flying round the hive as usual, which is about half an acre from my house, and it strikes me these troublesome bees are not my own at all. I have taken about 40 lb. of honey, which, according to your JOURNAL, is not so

bad for the season. I only have the one hive with bees in it, and bought another ready for a swarm, which probably, owing to bad weather, never came off. The county expert inspected my stock and said it was one of the best lots he had seen, as I fed them up well. Trusting to receive a reply in the B.E.J.—(Mrs.) G. L., *Weybridge, September 23.*

REPLY.—There is no doubt that the trouble referred to was caused by your extracting honey in the open at a time of the year when the utmost precaution is necessary to prevent an outbreak of robbing. In the autumn, or just after the honey season closes, bees are constantly on the alert, and the scent of newly extracted honey excites them to begin prowling about weak or queenless hives in order to start plundering. You may be certain that while this kind of work goes on young bees join in and remain outside till they become chilled in the cool evening and unable to return to their hives. Those found on the ground would be in that condition, not dead as supposed.

[3245.] *Brood in Surplus Chambers.*—I should esteem it a great favour if you would kindly let me know what to do under the following circumstances:—On removing surplus-chambers to extract the honey, I found the three middle shallow-frames full of brood, although I carefully placed queen-excluder on top of body-box before supering. I extracted the frames of honey on each side, and returned same to be cleared out, and removed excluder-zinc; and now ask:—1. Is it wise to let the shallow-frame super containing brood to remain on during winter. If not, how must I proceed in removing same? 2. I may add that my bees are in what is known as the "Birmingham Non-swarmer Hives"; also that the bees in one of them never worked in in non-swarmer chamber at all, although they apparently took possession of same early in season; nor have they made any surplus honey. Can you account for this?—(Mrs.) D. R., *Upper Norwood, September 17.*

REPLY.—1. The super should remain on till all brood has hatched out, then be removed in the usual way. 2. Non-swarmer hives are not at all suitable for beginners with bees. The probable reason of the bees not working in non-swarmer chamber is the adverse weather and consequent poor honey season.

[3246.] *Dealing with Foul-brood.*—I am sending you a fair sample of comb, and I should be much obliged if you would kindly let me know through your "Queries and Replies" column what to do with the hive from which it is taken. The circumstances are as follow:—In the spring of 1902 I purchased four stocks of bees. Early this year an expert informed me that three of the hives were infected with foul-brood. Of these three hives he made one colony, putting them on new frames, and the bees have since done

well, no trace of foul-brood remaining. In the fourth hive, which had remained untouched, I soon discovered traces of foul-brood, and did my best to prevent the disease increasing by feeding bees with medicated syrup, &c. When I examined this hive to-day I found all the combs were as enclosed sample (viz., cells here and there dried up and capped over, while some contained a dark, sticky matter); but, nevertheless, the bees were very strong. Should I destroy the bees and combs, having regard to the fact that this hive is situated within a yard or so of two healthy stocks; and, if so, what is the best method of doing so without injuring the hive as well? Also, do you consider that a hive can be sufficiently disinfected by means of a blow-lamp?—M. C. T., *Beckenham, September 14.*

REPLY.—The stock from which the sample was taken is unmistakably affected with foul-brood, and in view of the healthy colonies close by it is best not to attempt a cure at this season. We therefore advise total destruction of bees, combs, and coverings. The hive may be disinfected as proposed by using a painter's lamp and painting inside and out.

[3247] *Building up Stocks from Driven Bees.*—As a young bee-keeper and reader of B.B.J., would you kindly give me your advice on the following? An old skeppist in the village was going to take some honey by destroying bees over sulphur pit, so I begged him to let me drive them instead, which I did according to instructions given in the "Guide Book." I brought one lot home and put them in a frame-hive on eight frames—i.e., five fitted with full sheets of foundation, the other three filled with built-out combs (clean) taken from a skep belonging to another friend. The bees were then fed on syrup made as per "Guide Book." Three days afterwards I drove another lot, and united them to first lot in the said hive. I intended to kill the queen as she ran in, but did not see her enter the hive, so have left the question of supremacy to be settled by the bees. This was last week, and I have continued feeding them as above. Are the bees likely to draw out any comb this year, or will they fill comb given them with syrup, and how can I feed them, and on what, to ensure keeping them through the winter? I do not mind any amount of trouble with them, and I have a good reserve of patience, and am anxious to keep them if possible, having saved them from one certain death. Your advice will be strictly adhered to by (name enclosed for reference)—WORKER, *Ollerton, Notts.*

REPLY.—The question of building out combs largely depends on the number of bees in the hive. If the whole eight combs are thickly covered with bees, if feeding is liberal, and a rapid-feeder is used, it is very likely that some at least of the five frames of foundation will be built out. On the other hand,

the three combs given will be filled with syrup, and the cells facing the foundation probably lengthened out, before being capped over. This is the one drawback in mixing up combs and sheets of foundation in building up driven bees into stocks in frame-hives. You must feed freely with good warm syrup, and keep a watchful eye on the progress made in comb-building; then when packing down for winter give a good sized cake of soft candy.

[3248.] *Suspected Foul-brood.*—I write to give you a few particulars re suspected case of foul-brood sent on Saturday last from an apiary of two hives near here. No. 1 is a stock which swarmed this year, fairly strong, and, as far as I could see, free from disease. No. 2 is the hive from which the sample was cut. This was an empty hive, filled with drawn-out comb, which a swarm took possession of last July, and the bees only cover six frames. I would be glad of your answers to the following:—1. Is it possible the disease was brought by the swarm; or was it more likely in the old combs when the swarm took possession? 2. As there is a fair amount of brood in several of the frames, would you advise burning the worst combs, giving clean drawn-out ones, feeding with medicated syrup, and leaving until next spring; or is the lot not worth saving? 3. If the bees and hive fittings are destroyed, I suppose it will be safe to use the hive again, after being well cleaned and scorched with a painter's lamp? 4. Is there much risk of the other stock catching the disease, the hives being two yards apart, and the entrance of diseased lot closed up to a one-bee way?—F. H., *Warrington.*

REPLY.—Your sample must have miscarried in post or been improperly addressed, for we cannot trace it, unless it was a standard frame of comb received without name or address of sender. This was, in consequence of "no ownership," inadvertently destroyed the day after receipt. We may, however, reply to queries as enumerated, and if necessary, another sample (a small one) could be sent. 1. It is almost certain that the disease (if any) was in the old combs. 2. You might test the sealed cells of dead brood yourself by probing with a match, and if contents are found as described in "Guide Book," remove and destroy all such combs; otherwise defer operations till spring. 3. Yes. 4. By this time you may judge if there are any signs of robbing at entrance of suspected stock; and if the slightest sign of this is seen, close the entrance at once and destroy the stock.

[3249] *Bees and Preservation of Honey.*—I was asked to-day if bees, prior to sealing over their honey, deposit in the cells a substance of a preservative nature, capable of keeping the honey in a sound condition for an almost unlimited period. I could not answer the question. Will you kindly say if such is the case, and if so, please inform me what the

nature of the substance is? I send name, &c., and sign—BANAKA, *Swinton, September 26.*

REPLY.—It is perfectly certain that a salivary secretion is added by the bees to the nectar gathered from flowers, and this secretion affects the chemical change in the product which converts it into honey in the full sense of the term. Indeed, nectar is not honey until this change has been brought about by the action of the bee. We rather think that the "substance of a preservative nature" of which you have heard is believed by your informant to be formic acid; but this idea is a myth, and has no foundation in fact; nor is it true that anything is added by the bee just before sealing the cell, which preserves the honey for all time. In fact, it is known that if honey is not well ripened—*i.e.*, all superfluous moisture evaporated—it will not keep for any great length of time.

#### THE SEASON IN NORTH PERTH-SHIRE.

In 1888—that disastrous year for British bee-keepers—the Editor of the *BRITISH BEE JOURNAL* showed, by the law of probabilities, that two bad seasons could not follow each other. On that occasion the surmise was correct, yet the falsity of the reasoning is evidenced by the season just closing. That last year's failure and the resultant poverty of stocks have affected the present year goes without saying, as many "colonies" died during the winter. This mortality increased with the cold, raw spring months, and May found surviving hives ill-prepared to enter upon the summer's campaign. Clover did not begin to show until the end of July—a month later than usual. When full out, the "frosts" of that month put a stop to the honey flow from that source. Lime showed beautiful flourish, but it also had to go the way of the clover, and that from the same cause. Heather, which is so much depended on in these high latitudes, was in excellent bloom. On it, bees would have done well; but when it is stated that the rainfall in Blair-Atholl for the month of August was 5·2 in., with the barometer never rising above 29 in., it is surprising that anything has been done in the way of surplus. From returns obtained from the Vale of Atholl and conjoining glens, the season appears to have been very poor.

In Pitlochry, more than the half of the bees are reported dead, while even where there has been a little surplus it will only average about 10 lb. per hive. Glentilt, so famous in the past for its honey, reports bees all dead as far down as Gilbert's Bridge. Pittagowan, which it will be remembered had the fine total average of 40 lb. per hive in 1901, has, in the present season, fallen to nil. In some favoured spots the bees have done fairly well. The lower end of Glencrochie, although only a few miles distant from the last-named place

has about the best return we have heard of, one bee-keeper taking two cases of 18 lb. each off several of his hives. Strathtummel, which has ever held a place in the front rank of honey-producing districts, has done almost nothing. Bee-keepers possessing seven or eight hives report that "bees never entered supers." Rather better is that of Mr. Cameron, Aldcharmaig, who owns between forty and fifty colonies worked on modern lines. He is fortunate in having about 10 lb. per hive. Neither Kinloch Rannoch nor Dalnacardoch have sent in replies, but considering the altitude above sea level of the districts, coupled with the bad season, their silence is ominous. Blair-Atholl, situated as it is with a protecting bulwark of mountains, is able to show slightly better than the other districts, although 10 lb. per hive will be about the outside of the season's yield. Taking the returns for the whole of North Perthshire, the average yield will not be more than 5 lb. per hive.

The only bright feature of this gloomy report is the quality of the honey. Owing to the frost destroying clover and lime, all supplies have been gathered from the heather. The honey is fine in colour, of pure texture, and excellent in quality. Prices vary from 1s. 6d. to 2s. 6d. per lb. If bee-keeping as an industry is not to go down, apirians will have to look well to their "stocks," as the coming winter is almost sure to claim a number of the weaker colonies as its own.—(*Communicated.*)

#### BEEES EMBALMING A DEAD MOUSE.

The question is asked in a former number of *Gleanings*, 'Would bees hermetically seal a dead mouse found in their hive?' I reply. Yes, they will. Some years ago I put a strong swarm of bees in a hive with an entrance large enough to admit a mouse. Some days after, while working opposite this hive, I espied a mouse inside and near the entrance. As it remained quiet, of course I supposed it to be dead, and thought I would remove it at once; but some business of a pressing nature claimed my attention, and I forgot about the mouse. Some days after, while passing through the bee-yard, I thought of the little rodent. The bees seemed to be working all right. I looked in at the entrance, and saw a small mound. I made an examination, and found that they had furnished him a casket, or hermetically sealed him up. I removed the bees to another hive, and took the board containing the casket and kept it a long time as a curiosity. Finally I broke it open. The composition was in colour a bluish grey. The outside was rough, but the inside was nicely polished, and no part of it touched the mouse. His hair was smooth; and his tail, folded closely by his side, looked as though he was enjoying a pleasant sleep. Not the least offensive smell could be detected.—F. C. Ross in *Gleanings* (American).

## Bee Shows to Come.

*A nominal charge of 2s. 6d. is made for notices in this column, which covers cost of insertion from order till date of show. Cash should accompany orders for insertion.*

October 6 to 9, at the Agricultural Hall, London.—Show of Honey and Bee-produce in connection with the British Dairy Farmers' Association. Numerous and liberal prizes for honey, &c., including the valuable Silver Challenge Cup of the B.B.K.A. Schedules from Mr. Wm. C. Young, Secretary, 12, Hanover-square, London, W.

October 28 to November 11, at Newcastle-on-Tyne.—Honey Show of the Northumberland and Durham B.K.A. in connection with the Tyneside Grocers' Exhibition, St. George's Drill Hall, Newcastle. Open classes for sections and extracted honey. Members classes for sections, extracted honey and beeswax. Schedules from the Hon. Sec., Jas. Waddell, Wooler, Northumberland. Entries close October 27.

### Notices to Correspondents & Inquirers.

*Letters or queries asking for addresses of manufacturers or correspondents, or where appliances can be purchased, or replies giving such information, can only be inserted as advertisements. The space devoted to letters, queries, and replies is meant for the general good of bee-keepers, and not for advertisements. We wish our correspondents to bear in mind that, as it is necessary for us to go to press in advance of the date of issue, queries cannot always be replied to in the issue immediately following the receipt of their communications.*

SCOUT (Tydbrook).—*Bee Districts for Bees.*—There is no special district in England (or Scotland either, for that matter) better than all others. Good bee-forage is found in Essex, Hampshire, Berks, Kent, Lincs, and elsewhere; but much depends on the particular location in each county, as also on the season. If possible, it is best to locate where both flower and heather honey is available to the bees as giving two sources of supply. It is this feature that gives Scotland an advantage over the South of England in some seasons; but with regard to your question "Is Scotland a better bee country than England?" we fancy the present season's reports are all against our Northern friends.

BUSY BEE (Methwold).—*Bee-keeping in South Africa.*—There are several districts in South Africa where bees can be kept with profit, and we have some subscribers to our journals in that part of our colonies. Not only so, but bees and bee-appliances are obtained without difficulty on the spot. It will be seen from our advertising pages that one of our leading manufacturers has an agency in Johannesburg. There have also been displays of honey and bee-produce at some of the agricultural shows in the colony, so that bee-keeping is not a novelty there.

CARNIOLAN (Co. Cork).—*Cheshire's "Bees and Bee-keeping."*—We are not aware that a new edition of this work is in preparation; in fact, a well-known dealer, in his catalogue of bee appliances, makes an announcement tending to the contrary. Mr. Geo. Rose, of

Liverpool, has, we believe, a few copies on hand for sale.

F. J. (Mountmellick).—*Melting Down Old Combs for Wax.*—The simplest way of dispensing with a wax-extractor is to tie the combs in a canvas bag and insert the whole in a washing-boiler, weighting the bag down while melting in hot water is in process. The wax is removed from surface of water when cold, and the débris remains in the bag.

A. PATULLO (Forfar).—*Displaying Honey at London Shows.*—Regarding your request for "information as to the way honey is displayed at London shows," we can only say there is practically no difference between your important shows in Scotland and those in England—London included. Therefore, if you have exhibited at, or seen, a good show on your side of the Border, as we have, there is not much to be learnt from London shows that Scotch bee-keepers do not already know.

BARAKA (Swinton).—*Disinfecting and Store Combs.*—The disinfection of your house in consequence of a "scare" with regard to infectious disease can do no possible harm to the "combs stored away in a spare room," and you may use them with perfect safety to bees and your household:

G. F. GILLILAND (Londonderry).—*Introducing Valuable Queens.*—If the Italian queen was properly caged, as stated, for forty-eight hours before releasing, there is no known reason for her being thrown out dead; and so, without wishing to cast discredit on the "expert who examined the hive and pronounced it queenless," we advise a thorough examination of the combs before going further into the matter. It is sometimes most difficult at this season to find queens so that an expert bee-man may be easily misled.

### Suspected Comb.

APIS (Nuneaton).—Comb contains nothing worse than old mouldy pollen; all cells being full of this useless material, they are of no use for breeding or storing purposes. From details given we should say the stock has been queenless for some time past; and, not being worth re-queening, it had better be destroyed at once.

\* \* ERRATA—*Soluble Phenyle v. Phenyl or Phenol.*—By a printer's error the word *phenyle* was last week (pages 388 and 389) printed "phenyl," which latter word entirely misrepresents what we intended to convey. Phenyl is analogous to phenol, or pure carboic acid, and for bee-food can only be used in very minute proportions (1 in 500). On the other hand, "soluble phenyle," as recommended in the "Guide Book," will be taken freely by the bees, having practically neither offensive taste nor odour to render it objectionable to the bees.

## Editorial, Notices, &c.

### THE DAIRY SHOW.

The British Dairy Farmers' Association held their twenty-eighth annual show at the Agricultural Hall, London, on Tuesday, October 6, and three following days. The honey section, in which our readers are mainly interested, was staged in the Minor Hall, and although an adverse honey season militated against a large display, some very fine honey was shown. The brief time at disposal before going to press only allows for insertion of prize list. Further comments must therefore be reserved till next week.

Col. Walker, Budleigh Salterton, Devon and Mr. W. Broughton Carr undertook the duties of judging and made the following awards:—

*Twelve 1-lb. Jars Light-coloured Extracted Honey.*—1st, Samuel Cartwright, Shawbury, Shrewsbury; 2nd, Jas. Lee & Son, Martineau-road, Highbury, N., and Andover, Hants; 3rd, J. Jones, Wegber Quarry, Carnforth; v.h.c., Richard Brown, Somersham, Hunts; W. Patchett, Cabourne, Lincs; Henry Fenney, Lea Green, St. Helens; Charles H. Bocock, Ashley Apiaries, Newmarket; h.c., H. W. Seymour, Henley-on-Thames; John Smart, Andover; W. Woodley, Beeton, Newbury; c., P. B. Govett, Tideford, St. Germans, Cornwall; John Helme, Norton Canon, Hereford.

*Twelve 1-lb. Jars Medium-coloured Extracted Honey (other than Heather).*—1st, Charles Squire, Mortehoe, North Devon; 2nd, E. C. R. White, Newton Toney, Salisbury; 3rd, H. W. Seymour; 4th, John Carver, Wellington, Salop; h.c., James Lee & Son; John Hookway, Wellington, Somerset; Rev. W. E. Burkitt, Buttermere Rectory, Hungerford; Fred. A. Kent, Dorchester, Dorset.

*Twelve 1-lb. Jars Dark-coloured Extracted Honey (other than Heather).*—1st, Richard Brown; 2nd, H. W. Seymour; c., John Carver.

*Twelve 1-lb. Jars Extracted Heather Honey.*—1st, J. M. Balmбра, Alnwick, Northumberland; 2nd, James Lee & Son; h.c., Wm. Sproston, Shugborough, Great Haywood, Staffordshire; c., Thomas Richards, Church Gresley, Burton-on-Trent.

*Twelve 1-lb. Jars Granulated Honey of 1902 or any previous year.*—1st, W. Woodley; 2nd, Chas. Lodge, High Easter, Chelmsford; 3rd, P. B. Govett; v.h.c., E. C. R. White; h.c., H. W. Seymour; Philip H. Rawson, The Brand, Market Drayton, Salop; Fred. A. Kent; c., Richard Brown.

*Twelve 1-lb. Sections (size 4½ by 4½).*—1st, A. W. Weatherhogg, Willoughton, Lincs; 2nd, John Carver; 3rd, W. Woodley; v.h.c., H. W. Seymour; h.c., P. B. Govett; c., E. C. R. White.

*Twelve 1-lb. Sections (other than 4½ by 4½).*—1st, John Carver; v.h.c., H. W. Seymour; c.,

Rev. R. M. Lamb, Burton Pidsea Rectory, Hull.

*Twelve 1-lb. Sections Heather Honey.*—1st, J. M. Balmбра, East Parade, Alnwick, Northumberland; v.h.c., E. Middlemass, Stamford, Alnwick.

*Display of Comb and Extracted Honey.*—1st, W. Woodley; 2nd, H. W. Seymour; v.h.c., James Lee & Son.

*Beeswax (not less than 3 lb.), Extracted and Cleaned.*—1st, John Berry, Llanrwst, North Wales; 2nd, Alfred G. Preen, Nesscliffe, Shrewsbury; v.h.c., Chas. Lodge; Ernest E. Scholefield, Heathfield, Chudleigh, South Devon; h.c., E. C. R. White; John Carver.

*Beeswax (not less than 3 lb.) in Marketable Cakes Suitable for the Retail Trade.*—1st, H. W. Seymour; 2nd, John Carver; 3rd, John Berry; v.h.c., James Lee & Son; E. C. R. White; h.c., G. W. Kirby; c., Chas. Lodge.

*Interesting and Instructive Exhibit of a Practical Nature.*—2nd, H. W. Seymour. (No 1st awarded.)

## Correspondence.

*The Editors do not hold themselves responsible for the opinions expressed by correspondents. No notice will be taken of anonymous communications, and correspondents are requested to write on one side of the paper only and give their real names and addresses, not necessarily for publication, but as a guarantee of good faith. Illustrations should be drawn on separate pieces of paper. We do not undertake to return rejected communications.*

*Communications relating to the literary department, reports of Associations, Shows, Meetings, Echoes, Queries, Books for Review, &c., must be addressed only to "The Editors of the 'British Bee Journal,' 10, Buckingham-street, Strand, London, W.C." All business communications relating to advertisements, &c., must be addressed to "THE MANAGER, 'British Bee Journal' Office, 10, Buckingham-street, Strand, London, W.C."*

### AMONG THE BEES.

#### REMINISCENCES.

[5255.] *Sold!*—They were an eager, anxious group of interested young faces who stood round the apiarist as he dilated on his hobby, and the subject under observation was the interesting one of opening a ripe queen cell, with the object of liberating the fair young virgin from her infantile cradle. The various metamorphoses undergone by the inmate, since she had been sealed from the prying eyes of man by the porous covering of wax and propolis, were graphically described. Her beauty, grace, and elegant shape had been lovingly dwelt on; and the change brought about by the copious feeding with royal jelly and the wonderful enlargement of the cell had been lucidly explained. Now, the auspicious moment had arrived when the expectant group should behold with their own eyes the fruits of the magic change, and all were on the tiptoe of expectation as the learned bee-man adroitly cut the capping of the cell to liberate the fair inmate. She was expected to walk

gracefully forth, and march with slow and majestic steps along the operator's palm. But, on the incision being made, no fair virgin appeared, and no signs of life whatever were visible. The eager, anxious faces of the young folk visibly lengthened, and even the hardened visage of the veteran exhibited signs of chagrin, which deepened to mortification when, on the cell being opened still further, there appeared—only a doubled-up, attenuated, dead worker-bee!

*My First Swarm.*—In hiving my first swarm, acting on the advice given me by various bee-books, I parted the frames, shook down the bees from the straw skep, and tried to rearrange the internal fittings and lay on the quilt. But the bees were far too clever for me, and boiled up in such an outrageous manner that I was glad to throw on the coverings somehow, and place on the roof as quickly as possible, as a thunder shower had just come on. Consequently, my bees were found next day snugly ensconced in the roof, where they quite contentedly began to build comb. Displacing the bees, and re-hiving them, was to me then a work of danger and difficulty, and I went about it with a considerable amount of dubiety and trepidation. I, however, succeeded, and from then till now when I want to do anything about bees I just go and do it. I reasoned it thus.—“Others do it; why should not I?” The novice should take a lesson from this and make up his mind to do whatever is required for his bees' comfort and well-being, and brace his nerves for whatever manipulation is necessary. It is all, I hold, a question of nerves; and the man whose nervous system is sound can handle bees, provided he is careful and gentle in his treatment of them, with perfect impunity.

*Stung!*—The pain and agony attending the injection of the poison from a single sting is a terror to many beginners, if not, indeed, to all. The sharp tingling sensation seems to shoot out from one central point to the most remote extremes of the system almost instantaneously. Then there follows the heavy swelling and the tight tension of the muscles almost to the yielding point, and after, at times, complete or semi-prostration. Have we not all endured the dreaded sensation, and declared that, in spite of our love for the bees, we would give them up? But our fears evaporate with the effects of the poison, and we make one attempt after another, to find that, curiously, each succeeding injection seems more and more to work its own cure and leave us ultimately almost sting-proof. Even now stings come our way, although less frequently, but generally they tell so little on the system that ten minutes after it is impossible to discover the point stung. The old pain and the evil effects produced are things of the past, and now remain with us only as memories of the early years of our novitiate.

*The Good Old Prices.*—My own connection with bee-keeping began far too late to realise such a price as 2s. 6d. per lb. for comb honey

as our Junior Editor records he received in the days of long ago. All I can boast of obtaining was 1s. 6d.; but I got it for several years, and have still pleasurable recollections of a southern swarm yielding me 80 lb. of fine heather honey, which sold at the latter price. Any one can figure out the total, after deducting £1 as the price of the swarm—for it was a swarm—and then answer the query at times propounded in your columns—“Do bees pay?” This and last year I was well-nigh securing the “good old price,” as I sold none under 1s., and all my heather produce went off readily at 1s. 3d. per section. Properly managed, most emphatically, bees *do* pay. Good as I considered my prices this year, they are put altogether in the shade by a report from Blair Athole, where it is recorded that the good old price of 2s. 6d. has been obtained this year for heather honey. The fact was so interesting that I immediately sent the cutting to the JOURNAL office for insertion last week.—D. M. M., *Banff*.

#### A MATTER OF PRONUNCIATION.

[5256.] I beg that no one will forget that my suggestions as to proper pronunciation were advanced for the assistance of those only who might be in doubt, and as an attempt to secure uniformity. Too much faith should not be placed in dictionaries. They do but pretend to give whatever pronunciation the compiler may believe to be the common usage, and the word “Propolis” has no common usage; it is not sufficiently in the mouths of the public. Hence, probably, the uncertainty reported by Mr. Crawshaw (5250, page 393).

It should not be too late for bee-keepers to decide how they will pronounce a word that forms part of their special vocabulary. Propolis wears no English garb. It comes to us with the same number and the same arrangement of letters as in the pages of Aristotle, and any one who will take the trouble to look it up there will find that the vowels are short; as, indeed, was a necessity owing to the derivation, which I have already explained. It is, therefore, no overstatement to say, while the word remains in its original form, that any tampering with the vowels, any lengthening of a short syllable, is, from a classical point of view, a “grievous blunder.”

The variation *Propolis* is horrible. In my early school days any boy who had been so ill-advised as to give the Greek equivalent for *city* as *polis* would have at once regretted it.

I had no intention of starting a philological discussion in the columns of our JOURNAL, where it is somewhat out of place, and I shall do nothing more to prolong it. But I hope that experts generally will adopt one pronunciation of the three words to which I called attention, and that as regards the last they will plump for Prop'olis.—H. P. E. WALKER (Lieut.-Colonel), *Budleigh Salterton, October 2.*

## FORMALDEHYDE.

[5257.] Owing to pressure of business, I am sorry not to have been able to reply to "W. L., Lancaster" (5241 page 375), before his, but I now do so.

Your correspondent certainly may fumigate his appliances in any room, provided it can be made fairly air-tight. On experimenting, I find that one drachm of formaldehyde is required for every 30 cubic ft.; that gives the best results. In this connection I would say to "W. L.," in order to find the capacity of your room divide by thirty; that gives the number of drachms of formaldehyde required. Any metal dish made out of one piece will do for the formaldehyde, with a spirit lamp to evaporate the liquid.

If Mr. W. Woodley is troubled with wax-moth only, and not with foul-brood—as mentioned on page 375—he should try *Carbon bisulph.* which kills eggs of wax-moth and evaporates without heat, and is very cheap. In B.E.J. of September 24 (3234, page 388), I wonder what sort of a chemist your correspondent inquired of about soluble phenyl; he certainly was far behind the times if he did not know of it. I have used Little's soluble phenyle, also the standard article, phenol of commerce, and have had no difficulty in getting the bees to take either in syrup. In fact, I prefer the phenol made in a 90.9 per cent. solution, and used as the "Guide Book" recommends.

I am just now fixing up my bees for winter, and going carefully over each comb, and have not seen a trace of foul-brood; this fact speaks well of the uses of formaldehyde. It is very satisfactory, but I will have to wait till spring, 1904, for proof positive that I have effected a complete cure.—BLACKWOOD, Co. Durham, September 30.

[It may be well to mention that Carbon bisulphide is a dangerous drug to use, being inflammable, and not much less powerful than formaldehyde, so far as the fumes being sufficient to destroy every living thing within their reach.—EDS.]

## A LADY BEGINNER'S FIRST SEASON.

[5258.] As a beginner, I would be glad to give you an account of the take of honey I secured this season, which is as follows:—On May 29 I bought a strong stock of bees from Mr. Taylor, Welwyn, and on June 17 I put the first rack of sections on, and took off the last on September 3, and in that time I have taken seventy 1-lb. sections, besides a few unfinished ones, which yielded 4 lb. run honey. As to quality, nearly every one who has given one order has repeated it, saying the honey had such an excellent flavour. The first sections were rather dark in colour, but the later ones were of beautiful golden colour. Thanking you for the information I have gained from your paper and Mr. Cowan's

"Guide Book."—(Mrs.) B. SULLIVAN, *Harpenden, September 28.*

[You have every reason to be pleased with your first season's bee-keeping, very few having so good a return in the present year; and if the stock of bees is in condition for wintering without feeding heavily after taking 74 lb. from it, your success is very satisfactory indeed.—EDS.]

## BEE-KEEPING IN CANADA.

[5259.] I beg to thank you for your courteous reply in last week's JOURNAL to my queries of 18th ult., and for your offer to put me in communication with a bee-keeper in Ontario.

I am informed by the Canadian Commissioner for Emigration that fruit-growing is usually combined with bee-keeping, and am therefore hoping to go in for both; and shall be very grateful to you for the address of a bee-keeping fruit-grower who will be likely to offer either, each or either my friend and self employment for a while.—H. O. M., *Downend, Glos.*

[We are sending address by post of the bee-farmer in Ontario referred to in our issue of September 24 (page 387).—EDS.]

## CONVERSATIONS WITH DOOLITTLE.

## LATE-REARED QUEENS.

"How do you do, Mr. Doolittle? As the nights are getting longer I thought I would come over a little while and chat a few minutes with you on bees."

"Yes, the evenings are quite a little longer than they were, and I am reminded that the bee season for 1903 will soon be over. How did your bees do this year Mr. Brown?"

"I did not get much surplus, but find that the colonies, as a rule, have enough to winter on, for which I am thankful. It has been cold and wet nearly all summer, since the drought ended in June. Then the hard winds, heavy rains, and severe hailstorms have made the season unpropitious beyond any other season I have ever known."

"Yes, that is true. But what was the 'chat' to be about to-night?"

"I wanted to have a little talk about late-reared queens, as I wish to raise some during the last of this month. Bee-keeper Smith tells me that, if I so raise them, they will be of no use, as they will not find any drones thus late in the season, as the drones will all be killed off."

"If all drones are killed before any queen becomes old enough to be fertilised, and the season of the year is late fall, of course such a queen will become barren or a drone-layer."

"Why do you say barren? Smith said they would be only drone-layers, which would be even worse than no queen at all."

"I know some say drone-layers every time:

but my own experience has been that nearly or quite half of the queens which I have wintered over that were not fertilised never lay at all."

"Without discussing that part of the matter further, was Smith right in saying that a queen not fertilised in the fall would be of no use whatever?"

"Well, that depends on the size of the colony she is in. If it is merely a nucleus, with no prospect of wintering over, then I should say such a queen would be worthless. But should the colony be a good one, or one strong in bees and rich in stores, then I should consider an unfertile queen of some value, as my experience goes to prove that a colony having a queen, be she laying or otherwise, will remain much more quiet during the winter months than will a queenless colony; hence the colony having a queen will come out stronger in the spring, with less consumption of stores, than will one with no queen."

"Will such an unfertile queen be of any use in the spring?"

"Only in one way. She can be allowed to remain with the colony until we are able to procure a young laying queen from the South, and thus a good colony may be saved which otherwise might be lost. But even in such a case I should consider it much more desirable to purchase a queen from the South and introduce her to the colony having no fertile queen in the fall, where such is possible, than to try to winter over either a queenless colony or one having a virgin queen."

"Why?"

"My reason for so considering is this: Such purchased queen will commence to lay during February or March, and from her brood the colony will be materially strengthened before a queen could be procured in the spring, and thus the colony becomes ready to take advantage of the early honey-flows in the spring, which would be of little use to the colony which went through with a virgin queen, should she prove barren, and would be the means of having some of the combs filled with drone-brood, did the queen prove a drone-layer."

"Yes, I see that point; but a thought comes to my mind. How does any one know that all the drones are killed off in his section of the country previous to October 15 or November 1?"

"That is a question I have felt like asking several times. One or two years I have been quite sure there was not a drone within reach of my queen's flight, and yet the spring proved that every one of my late-reared queens had found drones from somewhere, as they were all prolific layers of worker-eggs. In fact, every time I have tried to winter over virgin queens, by way of experiment, all proved to be fertile in the spring, except in spring following a fall during which the weather gave the bees no chance for late flights; and only as I have clipped the wings of the queens for

these experiments, thus making it impossible for the virgin to fly out in search of any drone, have I been at all certain of success. From this experience I have ceased to worry over late queens failing to become fertile."

"Then you think there would be little risk in my trying to rear queens the latter part of September almost any year?"

"I so think. But no bee-keeper should try to rear queens late in the season unless several hundred drones are preserved from the very best stock he has in his apiary."

"But how are such drones to be kept? The bees are very persevering in killing drones in my locality after all of the honey-flows are over."

"It is quite an easy matter to keep choice drones, even as late as December 1, by taking frames of drone brood from choice colonies just before drone-rearing ceases, and putting said brood in a colony from which you now remove the queen. Ten days after the queen is removed, cut off all queen-cells, and such a colony will keep its drones as long as any are desirable in the fall."

"How is the strength of such a colony to be kept up as regards worker bees?"

"If a frame of sealed worker brood is given to these colonies occasionally, its strength will be kept up, also the flight of drones will be more profuse late in the season than would be the case if the workers became few in number. Then if an upper story, filled with combs of honey, be placed on the colony which is to retain the drones, the drones will fly still stronger, for, to fly strongly, drones need plenty of honey within easy access."

"Thanks for this last suggestion. Have you any more that would be of help to me?"

"If you do not think it too much trouble, drones can be made still more active by feeding the queenless colony containing them plenty of warmed syrup or honey at about noon the latter part of September, half-past eleven during October, and at eleven o'clock during November, feeding only on such days as bees can fly. If, in addition to this, you go to this drone-keeping colony on some day during the latter part of September, when it is still, and yet so cool that you will not be troubled by robbers, and carefully go over every frame in the hive, killing every drone that is at all inferior as to size, activity, length of wings, shape, marking, or in any other way, you will have something along the line of drones for your late-reared queens to meet that will very materially enhance the value of every colony having a queen which may chance to mate with such a drone."

"About what would be the chances, do you think?"

"My experience says about 50 per cent. in September, 75 per cent. in October, and 90 per cent. in November. During the latter part of October, and all of November, neither drones nor queens seem desirous of making long flights as in summer, and are not from



the hive more than a few minutes on their flights, hence the mating takes place almost in your own apiary, and where you are sure that you have no drones save those hand-picked and preserved by yourself, you are almost absolutely certain of results. The course I have outlined is the one I have pursued for the past few years, and I think it has paid me fully as well as any work I ever did in the apiary. If we are to keep up with the times and the close competition of these days we must strive for the *best* bees as well as the *best* honey, put up in the most marketable shape."

"Well, I must be going now, and I wish to thank you very much for this interview, Mr. Doolittle."—*Gleanings* (American).

### WEATHER REPORT.

WESTBOURNE, SUSSEX,  
September, 1903.

Rainfall, 4.13 in.  
Heaviest fall, 2.37, on  
4th.  
Rain fell on 12 days.  
Above average, 1.85  
in.  
Sunshine, 199.6 hours.  
Brightest days, 7th,  
and 14th, 11.5  
hours.  
Sunless days, 1.  
Above average, 19.1  
hours.  
Maximum tempera-  
ture, 77°, on 1st.  
Minimum tempera-  
ture, 36°, on 12th.

Minimum on grass,  
30°, on 17th.  
Frosty nights, 0.  
Mean maximum,  
63.7°.  
Mean minimum,  
50.8°  
Mean temperature,  
57.2°.  
Above average, 1.8°.  
Maximum barometer,  
30.55°, on 15th.  
Minimum barometer,  
29.60°, on 11th.

L. B. BIRKETT.

## Queries and Replies.

[3250.] *An Unusual Case of Foul Brood.*—I am sending by parcels post for your inspection a comb affected with foul brood which, I think, presents somewhat abnormal features. It is taken from a very strong lot which were perfectly healthy at the end of June, as were all my seventeen colonies. The source of contagion was a stock of bees which were given to me in May in a frame-hive, but which, owing to bad weather and other causes, I did not open for about three weeks afterwards, when, having found them badly affected, I destroyed bees and burnt everything except the outer hive, which now has a healthy stock of bees in it, the same evening. The hive this comb was taken from was very strong all through and gave me about 40 lb. of honey. On September 6, when I first found it affected, the bees were crowded on ten combs, and eight of them were each almost identical with the one I send. No cells perforated, except one in comb sent, extra thick cappings as if the

bees had added wax to seal up the disease, but every other cell throughout the hive quite bright and showing no trace of disease. I have burnt all bees, combs, &c. It would seem that these isolated cells, appearing as they did on nearly every comb in the hive, point to a pretty general condition of disease, throughout, but which has since from some cause, probably the presence of naphthaline, diminished to what we now see of it. Some fifteen years ago I had foul brood badly amongst my bees, but after seven or eight years' battling with it I finally cleared it out by burning everything and starting *de novo*. This is its first reappearance, and eight of my hives have been affected; two besides the above lot I have burnt, the other showing only a few diseased cells on one, or at most two, of the combs I am keeping, having removed and burnt the affected combs, and am feeding up rapidly with medicated syrup. I hope you will not think I have gone into unnecessary detail, but if my memory serves me well as to my former experience there appears to be a difference in the present attack from that of seven years ago. Then there was always dead brood in all stages, now there is only the sealed cells not perforated. In the other cases also, features new to me were presented. I noticed in the bottom of some cells what appeared to be the remains of grubs in the nymph stage, all the juices seemed to have been extracted, and the skin with legs, &c., complete, pushed down by the bees to the bottom very much as pollen is pushed down, the skin retaining its pearly whiteness. In adjacent cells were grubs in various stages and unnatural positions, some just turning a straw colour, a typical case of foul-brood. The spore stage was not reached in any of the affected lots except the one from which I am sending the comb, but I destroyed the two worst lots. If you would kindly examine the comb, and if you find anything abnormal or likely to be of general interest, will you kindly favour me with a comment in the JOURNAL? I shall be glad of your advice as to my crates of shallow-frames. How should I deal with them, after extracting those from the diseased lots at any rate? Do you think it will be necessary to destroy these, or can they be efficiently disinfected? I suppose there is no doubt they would contain spores. One difficulty is to get the supers from the destroyed diseased lots cleaned up, as it would be too risky to put them on healthy hives. I send name, &c., for reference, and, thanking you in anticipation, sign—PUZZLED, *Solihull*, September 28.

REPLY.—We have had several instances similar to that under notice in which combs were found in healthy stocks having a few scattered cells very thickly capped over, which latter contained distinct evidence of foul-brood. Such cases are, however, not common, and it would seem as if the extra thick covering in such cases is sufficient to seal up

and prevent the disease from spreading. We should cut out and burn the few sealed cells of combs in the affected stock you are keeping, and this, along with the use of preventives as before, will, no doubt, be effective. With regard to the shallow-frames of honey removed from the diseased stocks, it will be safest to melt them down for wax after extracting contents.

[3251.] *Identifying Swarms when Hiving.*—I have this year had great difficulty in telling from which of my hives a swarm had come from. The swarm was clustered on my return home, but after hiving the bees I could not find out which was the parent hive, and had not time to remove supers, and the bees seemed strong in the three hives my apiary consists of. I therefore ask, Is there no other way of examining combs for queen cells? If you can give any help it will oblige—JAS. FREEMAN, *Hants, October 1.*

REPLY.—The simplest plan we know of is that described by Col. Walker in B.B.J. of June 11 last, wherein while writing of swarming he says:—"It will be noticed that to carry out this scheme all swarms must be identified, and as this in itself takes time, and is not always an easy matter if the issue has escaped attention, I hope our Editors will allow me to repeat the method of identification that I sent them nearly nine years ago; not my own device, for the flouring of bees for recognition dates from the days of Aristotle. When a swarm must be hived, unless you are quite certain whence it came, take a flour-dredger with you as well as a skep. There will generally be a few bees somewhere outside the skep after turning it over; if not, detach a few from the cluster, and give them a thorough dusting; repeating it if necessary. Fothwith remove the skep, and place it where the bees are not likely to find it; it need not be taken far if well concealed. The dusted bees, disheartened by the flour, and having lost their fellow-swarmers, will before long make their way to the apiary, where they will be seen roaming disconsolately, like belated bee-ghosts. In from five to thirty minutes from their dusting they will be fanning vigorously on their alighting-board, and all doubts as to the parent hive will be at end."

[3252.] *Starting Bee-keeping: A Beginner's Queries.*—I hope to begin bee-keeping in the course of a few days, and I shall be very much obliged if you will, in the pages of your paper, give me a little advice. I am buying the bees from a distance, and they will arrive by train in a box, and the hive separately. The seller says they have two stone of honey, and in that case would it be safe for me to take away some of the honey and give them syrup instead? 1. If so, should the sugar used in making syrup be dissolved in water or in beer? I am told beer and treacle is the usual (old-fashioned) food for bees. I have a

sheltered garden, and fruit blossom, gorse, and heather within a quarter of a mile, and a market among friends for a good deal of honey, as no one keeps it for sale in the neighbourhood. 2. Is it well to let the hive stand upon the ground? And how can I best keep the bees warm for winter?

Later.—Since writing the above I have received the bees and must do what I can, but shall be thankful for advice. The hive came from a good distance away, and the bees immediately brought out more than 300 dead, but there still seems a great many bees left, if I can judge by the buzzing sound when I raise the roof, and they are also bringing in quantities of pollen. The upper story of the hive is quite empty, the bees being confined to the lower part by the ordinary coverings. 3. Is this as it should be? And in keeping them warm for winter ought the covering to be inside the super or over the top of the hive? 4. The hive needs painting. Could I do this with bees still in it? 5. How can I tell whether they have enough food to last them the winter, or whether they need feeding? 6. Can you tell me if there is any visiting expert in Worcestershire. I know in some counties the County Council sends one to examine hives if needed. I want to make a profit by bees, and am willing to take any trouble with them. I can sell any amount of honey, especially in sections.—L. A. T., *Catchems End, near Bewdley.*

REPLY.—1. The first advice we offer to beginners is to procure a "Guide Book" on bee-keeping (costing 1s. 6d.), without the help of which it is like groping in the dark with bee-operations. 2. Neither "beer nor treacle" is used in making bee-food, and if it is intended to raise honey for sale you must learn how to prepare it for market. All the other information asked for will be found fully detailed in the book named, but we cannot pretend to give instructions on all points in our "Query and Reply Column." There has evidently been some fault, either in packing or handling, to cause the death of so many bees in transit, but as the bees are apparently doing well and repairing the damage. 3. Remove super and put covers above top-bars. 4. Yes, if painting be done after bees have ceased work for the day. 5. Only by examining the frames and calculating, as nearly as may be, what weight of sealed and unsealed food there is in the combs. A 1-lb. section ( $4\frac{1}{2}$  in. by  $4\frac{1}{2}$  in.) is a ready off-hand guide for judging weight. There should be at least 25 lb. of food in the hive now, and if less, it must be supplemented by a large cake of soft candy placed over the feed-hole in quilt. 6. There are several experts in Worcestershire, and we have no doubt you would get such from the Hon. Sec. of the County B.K.A. by becoming a member.

[3253.] *Medicating Bee-Food.*—Would you kindly give advice on following?—I have made some syrup for feeding up my bees

according to directions in "Guide Book," viz., 1 oz. of vinegar,  $\frac{1}{2}$  oz. of salt, 1 tablespoonful of naphthol beta (got from your office) to 10 lb. of sugar, and the bees will not take it at all. I use the round tin-feeders with wood float. I have three hives and none of them take it. My brother, who keeps two hives, has not put any naphthol beta in the food and his are taking it all right. The sugar used is pure cane, so that I think it rather strange, and therefore ask—Can you say why the bees refuse the food? This is my first year with bees.—W. POLLARD, *Silsden, Yorks, October 3.*

REPLY.—We print particulars of the ingredients used in making the bee-syrup in question as written, but they are inaccurate in several respects, and not according to "Guide Book" recipe at all; and that is no doubt the reason why bees refuse the food so prepared. Surely you did not use "a tablespoonful of naphthol beta as got from this office to 10 lb. of sugar?" If you have we do not wonder at the result. According to the "Guide Book" one tablespoonful ( $\frac{1}{2}$  oz.) of naphthol beta solution is "just the right quantity for 10 lb. of sugar." Not only so, but the syrup so made has almost no taste of naphthol beta, and bees take it as freely as if not medicated at all. If, on the other hand, you have given a tablespoonful of naphthol beta "as got from this office" it means the whole 1 oz. packet which is sufficient to medicate 145 lb. of sugar.

[3254.] *Heather Honey and Air Bubbles.*—Herewith I send you a sample of honey, got from some uncompleted combs referred to in B.B.J. of September 10 (3229, page 368), and ask—1. Do you consider it a good sample and fit for showing? 2. How should I treat it in order to get rid of the air-bubbles seen? 3. Is it all heather honey? I am much pleased with the hints obtained from your valuable paper and will be pleased to have any suggestions about enclosed samples. I send name and sign—CAIRBAUN, *Orinian Canal, September 30.*

REPLY.—1. Sample is very good heather honey, quite fit for any show-bench. 2. As heather honey has, perforce, to be pressed from the comb it usually contains air-bubbles, and consequently is not adversely affected on the show-bench by them. 3. Yes.

[3255.] *Bee Parasites.*—To-day we were going through a hive before packing the bees down for the winter when we happened to catch sight of the queen. To our astonishment, at first she seemed to be covered with large red spots, but on catching her it was found that these seeming spots were insects which moved very rapidly. We took them off and killed them, finding the smaller ones were nearly white, while the larger were red, or rather a reddish brown. They were not confined to any one part of her body, but were all over. I should think we took off eight or nine. 1. Can you tell me what these insects

are, and if it is a common occurrence to find queen bees infested with them? 2. How can they be destroyed? I enclose two dead ones for inspection.—C. R. CLARK, *Winchester October 1.*

REPLY.—The insect referred to is a parasite known as the *Braula cæca*, or blind louse. Though pretty frequent in the South, it is not of common occurrence, and is usually imported with bees from warmer countries than ours. Fortunately it does not thrive in this country, but usually dies off through cold in winter, and if sent to the North soon ceases to exist. The method of ridding hives of it is by puffing tobacco smoke over the bees infested, when the braula drops on the floorboard, and may be brushed off, but only in cases where they are very numerous need any trouble be taken to destroy them.

[3256.] *Extracting Unsealed Honey in Autumn.*—1. Please say if it is necessary to extract all unsealed honey before packing for the winter; and, if so, should this be done at once? 2. I am now feeding my bees with syrup; how soon might I expect this syrup to be sealed over? 3. Would it be better to stop feeding now, and place candy over the frames? I may say each hive has now about 18 lb. of sealed honey in the combs of brood-nests. Your kind reply in BEE JOURNAL would much oblige—H. M. B., *Croydon, October 4.*

REPLY.—1. Not at all necessary, if there is not much unsealed honey in the hive. The reason for extracting unsealed stores at all is simply because uncapped food gathers damp in the hive in winter, and this may cause the food to become sour and unwholesome; but, as unsealed stores are used first, a small quantity does no harm. 2. When cold weather comes bees will not often cap food over, unless the hive is very full of bees. 3. With 18 lb. of sealed honey in each stock, we should make it up to 20 lb. with syrup, and then give a 2-lb. cake of soft candy to each on packing down for winter.

[3257.] *Bees Troublesome in Gardens.*—1. I find my bees are becoming, as they increase, somewhat troublesome in the garden, which is not large, and therefore ask: Do you think it would be a suitable place to keep them on the "leads," about 20 ft. from the ground? 2. Is there a really efficient swarm-catcher to be had from appliance dealers? I am away from home all day, and it is very difficult to find any one to hive a swarm if one comes off? Your advice will much oblige—R. B. DART, *Great Missenden, October 5.*

REPLY.—1. Many instances are recorded of bees being successfully kept on what you term "the leads," i.e., the roof of a building 20 ft. or so from the ground. 2. We do not undertake to guarantee perfect efficiency in any particular swarm-catcher so named, but there are some good ones on the market, and

no doubt any leading manufacturer would name one that meets with general approval from customers.

## WORKING FOR HONEY AND INCREASE.

AN AMERICAN BEE-KEEPER'S METHOD.

White clover bloom was fine, and yielded well. Basswood was a failure, but we did not need it. There is a little white clover yet. The Simpson honey-plant grows wild here, but is not very valuable; also motherwort, but it does not attract bees as does catnip. My bees are still storing honey in shallow extracting-combs, but are not doing much in supers where they have to build comb; this is mostly from catnip and sweet clover, and smartweed just beginning to bloom.

Now, I see that the question is often asked in your pages, "How can I increase my bees rapidly, and still get lots of honey?" As I started last spring with twelve colonies, and wanted both honey and increase, I formed a plan how to get both which worked well. This is how I did it:—

I found in early spring that my bees were nearly starving. I then fed them with candy until it was warm enough to give them syrup. The most of the colonies were weak in bees, with little or no honey. I gave them only about a half pint of syrup every evening, some less than that. White clover promised to be abundant. By the time fruit blossom came out I had nearly all colonies ready for supers. I then put on one super with shallow extracting-frames containing, for starters, 2-in. strips of foundation, with quilt above to keep warm. During a cold spell in fruit bloom I fed the bees again every evening for nearly a week, increasing the food as the bees became stronger, always above the brood nest and always just at dusk of evening. I also kept entrances contracted during cool weather. White clover and raspberry came in bloom about the same time, white clover being two weeks earlier than usual, and May 15 found me with a good honey-flow on from both white clover and raspberry, and bees enough to fill two supers in nearly all twelve colonies.

I then began to slip an empty super under the top one. By June 1, the brood-chamber of the 8-frame Langstroth dovetailed hive was nearly filled with brood, and from one-half to three-fourths of the super of shallow frames. I then gave some another super next to the shallow frames. Everything worked well until a rainy spell struck us, and for eight days we had three or four warm showers every day; as usual, under such circumstances, the swarming-fever struck the bees. They would work for dear life between showers, and swarm.

By this time most of the colonies filled three or four supers with bees, and were capping the first supers. I then put another empty super

on top, to give room, but the swarming still continued—nearly all swarmed three times, and I just let them swarm, but put back all fourth swarms. When two swarms would come out at once I would cover one hive up tight with a blanket, and, as Dr. Gandy says, they would immediately quit coming out, and would not then swarm until afternoon or the next day. These first swarms were hived on starters in brood-frames, and a super containing sections, and they filled it chock-full of bees. In two or three days I would slip another super under the top one, which would prevent pollen in sections; this I did until they all had three or four supers.

Now, as the old colonies had so much brood hatching, the second swarms were large enough to work in two supers, and to the third swarms I would give the extracting or shallow-frame super. This, of course, left the old colonies pretty weak, but as we had a good honey-flow on, several of these supers were capped, which I took off and put on the market 15 cents for a 3½ by 5 by 1½ section, which sold as fast as I could get it to the home market. It was nice and white, and no other honey on the market. I ornamented every section with my business card, by stamping with rubber stamp.

Then I took some unfinished supers off the old colonies and placed on new swarms to finish until I had only one super left on an old colony. This contracted their room, and when the young queen began laying she found lots of empty cells in the brood-chamber and bees enough to rear brood, but not to gather any surplus; but they have now built up so as to be able to fill two supers of bees and are storing surplus again, and are ready for the late autumn.

Several of the first swarms swarmed the second time. I put back these second swarms, but they would not stay back; so I hived them in shallow extracting supers, and set them on the parent hive the next day after taking away the queen. In some of them I could not find the queen, but they settled their own disputes and quit swarming. I also made a few nuclei in the spring, which have built up.

I reared my own queens from a colony of long-tongued bees. That colony did not swarm, as I used so much of her comb brood, and I believe I have taken off ninety sections of comb honey, and they are working slowly in ninety more sections and will soon have them completed. Some of the first swarms have nearly finished 150 sections and are working in four supers now. These shallow frames were moved up away from the queen, and as brood hatched out they were soon filled, extracted, and placed on the hives again.

So far this season I have taken off 1,400 lb. of honey, all comb but about 200 lb. I am taking off about three supers a day, using bee-escapes. I have about 1,000 lb. ready, or nearly ready, to take off, and fifty colonies

strong enough to fill from two to four supers with bees for the smartweed flow, which is just coming in.

Now, this plan would not work in some seasons, but this is a good year. I could have had much more increase, but I wanted honey also. Smartweed promises a fair crop. All queens seem to be prolific in a good season.

I have had a hard time to get hives and supplies, but I ordered an extra large supply early, so I managed to get along. I want to say right here that a certain bee-supply dealer beats the world to get a move on him, and can fill orders quick when he has the supplies; but when everybody wants a whole lot of all kinds of supplies, right away, quick, and he happens to be just out of almost everything, when we are liable to think him a slow poke. Let me give a little advice: Get your supplies early; then if you have to send after a lot of supplies right in the busy rush, and do not get them right away, nor hear from the supply-dealer, and you get plum stuck, write the supply-dealer a real sassy letter, just give him fits, call him lazy, slow poke, and call him everything you can think of, only do not swear. Write about twenty-four pages; spend a good half day at it, even if you are busy; ask him if he got your order; tell him he is a thief and a rascal, and is probably off on a drunk, and not attending to his business. When you have it finished, read it over carefully, and if you see where you can make it a little stronger, add at least ten more pages; then, when it is ready to mail, go out and chop for your wife an armful of wood, make a good fire in the kitchen stove, and then open the lid and quietly drop the letter in the fire, and you will feel lots better. And so will the supply-dealer.

When your neighbours come three or four times a day to get you to go home with them and bring an empty hive with you, and climb up to a tree top and get a swarm of bees that came there, and then hive them and give them supers with foundation, and show him what a queen looks like, and explain all about bee-keeping in general, then promise to help him cut all the bee trees he can find this fall, and bring empty hives and transfer them for him, and lend him your smoker and bee veil, and three or four bee-books, and it is "I'll hand you the money some time for the hives." Just say first, last, and at all time, that you are sorry, but you just cannot leave your own business, and cannot help him at all right now; and that you have not even time to talk to him. Then hand him a copy of the *American Bee Journal* and a catalogue of supplies, and bid him good-bye, and it is "Come over when I am not so busy."

This has been a good honey season, and the bee-keeper that attended to his own bees all right will have lots of honey. But hundreds of bee-keepers that neglected their bees will not have any more honey than usual. I asked

one bee-keeper how his bees were doing. "Oh, just fair," he said, "some have swarmed five or six times. I could not get hives, so they were put in boxes, some in barrels, and some were left." In fact, he got tired of hunting up boxes, and just let them go.

I asked him how much honey he had taken off, and he said, "Just a little bit; the old hives are full, I guess, or they would not have swarmed. They have had the supers on the upper story two or three years, so I guess they are full; they are so blamed cross I hate to do anything with them; I guess I will wait until cold weather. They tell me you are a good hand with bees. I wish you would take it off. I bet it is full of nice honey. I prised up the lid, but they got so cross I had to run, and did not get the lid down tight, and now they are so cross I don't dare go near them; and the bees are all over the hive. They say bees don't sting some people, but they just pop it to me."

I said I had all I could do with my own bees, and got all the stings I cared about at home.

My honey is selling for 15 cents per Ideal section, which is about 17 cents per lb. I get 12½ cents per section, the dealer 2½ cents. I advertise in different ways, and sell at home and near-by towns. People are better able to buy honey now than they were several years ago, and this locality, at least, will consume more than usual. Other eatables are high; butter is from 15 to 20 cents per lb. to the consumer, and honey should not be less, nor will mine be. Honey is not a perishable article to be dumped on the market right away, and if honey is sold cheap it is the bee-keeper's own fault. We do not often get a good crop; let us not be foolish and sell it for a trifle.—  
J. E. JOHNSON in *American Bee Journal*.

## Bee Shows to Come.

A nominal charge of 2s. 6d. is made for notices in this column, which covers cost of insertion from order till date of show. Cash should accompany orders for insertion.

October 6 to 9, at the Agricultural Hall, London.—Show of Honey and Bee-produce in connection with the British Dairy Farmers' Association. Numerous and liberal prizes for honey, &c., including the valuable Silver Challenge Cup of the B.B.K.A. Schedules from Mr. Wm. C. Young, Secretary, 12, Hanover-square, London, W.

October 23 to November 11, at Newcastle-on-Tyne.—Honey Show of the Northumberland and Durham B.K.A. in connection with the Tyneside Grocers' Exhibition, St. George's Drill Hall, Newcastle. Open classes for sections and extracted honey. Members classes for sections, extracted honey and beeswax. Schedules from the Hon. Sec., Jas. Waddell, Wooler, Northumberland. Entries close October 27.

### Notices to Correspondents & Inquirers.

Letters or queries asking for addresses of manufacturers or correspondents, or where appliances can be purchased, or replies giving such information, can only be inserted as advertisements. The space devoted to letters, queries, and replies is meant for the general good of bee-keepers, and not for advertisements. We wish our correspondents to bear in mind that, as it is necessary for us to go to press in advance of the date of issue, queries cannot always be replied to in the issue immediately following the receipt of their communications.

D. JONES (Cefo Mawr).—*Sugar for Bee Food*.—1. The sample of crushed lump—if pure cane—is by far the best for autumn feeding, crystallised Demerara (or yellow crystals) being more suitable for spring food. Bees always winter best on white sugar, either lump or crystals, from which the molasses has been removed by refining. 2. We cannot guarantee samples to be pure cane.

D. WITHER (Putney).—*Hastening Granulation of Honey*.—The only method we know of for expediting granulation is by inserting a small piece of granulated honey in each jar, and keeping the honey in a cool place.

G. W. (Sandiacre, Notts.).—*Dimensions of the "W. B. C." Hive*.—Correct dimensions and measurements (drawn to scale) of the hive named will appear in a new edition of the "Bee-keeper's Note Book," now being prepared for publication, and will be issued in a few weeks.

SEASIDE (Harwich).—*Painting Hives*.—We never heard of "red lead being recommended as a first coat of paint for hives." We should advise the use of "priming" in the ordinary way, followed by two or three coats of good oil paint.

G. F. GILLILAND (Londonderry).—As the bees of stock in which the Italian queen was killed are now united to another colony, the question of queenlessness cannot be decided; but we are still unconvinced as regards the stock being queenless when the foreign queen was introduced. Shaking the bees from combs, and watching them run in, is an unreliable test in difficult cases of queen-finding. 2. The method of getting rid of a fertile worker, followed by your local expert, is an old one, which has almost fallen into disuse and given place to better plans.

G. M. S. (Keswick).—*Book on Bee-keeping*.—Beyond saying that we have a copy of the book referred to, and hope to review it shortly, we cannot add anything to what you already know.

BUSY BEE (Doncaster) and H. D. D. (Basingstoke).—*Recipe for Making Honey Vinegar*.—The pamphlet on Honey Vinegar, published by the Rev. Gerard W. Bancks, Green Street Green, Dartford, contains the best information we know of on the subject.

H. P. (L. Umkomaas, Natal).—*Bees and Bee Appliances in South Africa*.—The BEE JOURNAL can be posted to you for 6s. 6d. per annum, same as in this country. We are,

as desired, sending copy of paper, and from it you will get names of advertisers who are leading appliance makers from whom you can procure catalogues. We are not dealers in bee goods at all.

#### Suspected Combs.

L. BURNETT (Eskdale).—1. The sample (a full standard frame) of comb sent has evidently had only one batch of brood reared in it, and as the whole—excepting five cells—has hatched out all right, it is not a case for causing great alarm, but only needing care and watchfulness. It is plain that the preventives used have kept foul brood well in check, seeing that only five cells in the frame of comb have failed to hatch out. 2. The dark colour of the brood-cells is simply caused by the cocoon or skin, left behind by every larva reared therein. 3. We need hardly say that a good bee-man always keeps a watchful eye on the brood whenever frames are being examined, and where a sealed cell or two fails to hatch they are probed and cut out if contents are seen to be in the least suspicious. This is all that should be done in your case, as the dead larvæ present none of the appearance of genuine foul brood.

HONEY BEE (Ayrshire).—1. We cannot trace any foul brood in your small sample, but every unsealed larva has been probed before sending, so that you have effectually prevented us from judging from the appearance. We repeatedly ask that samples be sent just as removed from hives "not probed." 2. Letters intended for B.B.J. should be addressed "Editors," not by name, unless for our monthly the *Bee-keepers' Record*.

#### Honey Samples.

M.P. (Enstone).—1. The section of comb-honey sent is of good flavour and colour, but, not being built to the wood of section, it was completely smashed in post. 2. Sample of extracted honey is rapidly granulating, and has a strong, rank flavour that we cannot recognise; but it deteriorates the quality for table use, while reducing its market value considerably. There must be some plant or weed which grows plentifully in your district to account for the peculiarity in flavour referred to.

J. M. (Middlewick).—Your sample is granulating, otherwise it is a very good honey indeed; capital on all points if it was carefully cleared by warming in water.

MAC (Asham, Yorks).—Sample is good in colour and flavour, but too thin to keep well; and we also fear you have used the carbolised cloth too freely in handling the honey.

\*.\* Several Letters and Queries are unavoidably held over till next week.

## Editorial, Notices, &c.

### BRITISH BEE-KEEPERS' ASSOCIATION CONFERENCE WITH COUNTY REPRESENTATIVES.

The second annual Conference of representatives of County Associations and the Council of the B.B.K.A. was held on Thursday, October 8, at 4 o'clock, in the Board Room of the R.S.P.C.A., 105, Jermyn-street. The Chairman of the British Bee-keepers' Association (Mr. T. W. Cowan) presided, and was supported by the following members of the Council and delegates from county associations:—Thos. W. Cowan, W. Broughton Carr, Thos. I. Weston, Ernest Walker, E. D. Till, R. T. Andrews, (Miss) M. L. Gayton, C. N. White (Hunts), A. W. Fair (Middlesex), R. Godson (Lincs), Percy Sharp (Lincs), F. J. Cribb (Lincs.), W. A. Dawson (Surrey), H. J. O. Walker (Devon), Walter F. Reid (Surrey), J. Waterfield (Leicester), T. Richards (Derbyshire), A. C. Clark (Derbyshire), Geo. Hayes (Notts), P. Scattergood (Notts), W. E. Burkitt (Wilts), T. H. E. Watts-Silvester (Surrey B.K.A.), J. B. Lamb (Middlesex), H. M. Turner (Oxford), Allen Sharp (Hunts), J. Collyer (Hunts), L. Belsham (Essex), W. V. Hatch (Wilts).

The Chairman, in opening the proceedings, said it would be remembered that last year delegates from the different counties were invited to attend a conference with the Council of the British Bee-keepers' Association with the object of drawing closer together the bonds of union between the parent body and the affiliated societies. They of the central association wished to ascertain the feelings of the county associations, and by the mutual interchange of ideas endeavour to further the interests of their provincial auxiliaries throughout the country and of bee-keepers generally. The meeting in 1902 was an encouraging one, and, although not able to be present at it, he (the Chairman) had read the report of its proceedings with much interest. He hoped the experiment had done some good, and had, in fact, brought a number of delegates here this year to repeat it. Several points were raised last year which had afforded subjects for the Committee's deliberations, the result of which the meeting would, no doubt, hear that day. Among other things, a member of the Council had prepared some interesting statistics in connection with the shows held during the present year which were well worthy of consideration.

The British Bee-keepers' Association was established as an educational body, its chief aim being to instruct and benefit the bee-keeping cottager. In pursuance of that idea it had brought out "Modern Bee-keeping" and other publications. It had also carried on a system of examinations for the qualification of experts in bee-keeping, who went about the

country instructing by precept and example all who were anxious and willing to gain a knowledge of apiculture. So far, he was glad to say, their efforts had met with success. During last year no fewer than 124 candidates had applied for certificates as experts of the Association, and out of that number 104 passed, so that there were only twenty who failed to secure the certificate. It was also very satisfactory to note that forty-five of the candidates were ladies. The Committee particularly desired to call the attention of the meeting to the educational schemes now being carried out by the different County Councils, in order to see whether it would not be possible to induce the latter bodies to get into closer touch with the county associations. Naturally, the central association wished to work through its county auxiliaries, and that would always be done wherever a county B.K.A. was in existence.

A few years ago the parent body and its affiliated associations were in close touch on the subject of foul-brood, but since that period they, unfortunately, had to some extent lost connection. That subject would be a theme for useful discussion. Another point had reference to exhibitions of honey and bee-appliances, and how far the present system could be altered or improved by some plan that would be more advantageous to bee-keeping in general. He (the Chairman) wished it to be clearly understood that there was no desire to restrict the course of debate; indeed, the Council would be glad to have ventilated any other subject of interest to the county associations or of use and advantage to the bee industry at large.

Mr. W. F. Reid, in opening the discussion, said: It was thought by some people just now that they were behind Continental nations, although doing all they could to get up to the level they wished to occupy. He considered this view had been overdone, and with regard to the industry in which they were all interested, he thought there was little to learn from foreign countries. He felt averse to saying anything very definite on the subject, but of this he felt sure, English bee-methods were not inferior to those of the Continent. The chief desire of the B.B.K.A. was to teach people how to keep bees and profit by them, and that such knowledge of apiculture should be acquired and disseminated on scientific lines. Latterly the Education Acts had been altered, or rather, a new Act had been introduced. Under the latter, County Councils now had power to give grants in aid of education on technical subjects; and he could think of no better subject for a grant by all County Councils, with the exception of a few (like London), which only included towns, than the promotion of bee-keeping. There were very few minor industries of greater interest to people living in country districts than bee-keeping. It was not an enterprise requiring much capital,

and certainly it could be easily learnt. In regard to teaching it was important that instruction should be given in such a way that no errors arising from antiquated systems should be perpetuated. They had found that the teaching given in some counties did not altogether convey a correct idea of the most modern methods of bee-keeping. The parent association had done what it could to correct this by issuing a circular to County Councils stating the objects of the B.B.K.A., and offering to assist those public bodies in advocating and promoting bee-keeping on thoroughly sound lines. He hoped that seed would bear fruit. Another point which concerned the subject was that from a purely educational point of view it might be said that bee-keeping and bees were a theme possessing interest for nearly everybody when put before them in a practical way. One might discourse on many topics, say, botany, as an instance, for a long time before arousing the enthusiasm of an audience; but he had found that their attention was generally absorbed in a lecture and discussion on bees, merely from the educational point of view, and that was quite apart from the commercial aspect. Few had failed to notice that the crowd always gathered round an observatory hive at a bee-show. Thus, the subject was well worthy of a place in the plan of lectures arranged by County Councils, and by this means cultured people who had never given a thought to bees might be induced to spend a little of their spare time in taking up the pursuit. There was not much competition in bee-keeping. A great deal more good honey was wanted than the market supplied at present, and the demand would be still greater if people were instructed regarding the value of honey as a nutritious and agreeable article of food.

In reply to Mr. Waterfield (Leicestershire), the Chairman said that the circular addressed to County Councils was sent out a month or five weeks ago.

Mr. Cribb (Lincolnshire) asked how that circular would affect the position of county associations, which had already applied for, and in many cases received, grants from County Councils. If there were two associations applying for grants, confusion and harm would no doubt result.

The Chairman explained that the B.B.K.A. had made no application for funds at all, and in order to show that this was so he called on the Secretary to read the letter in question, which was done, as follows:—

“TO THE EDUCATION COMMITTEE OF THE COUNTY OF (.....).”

GENTLEMEN,—The recent Education Acts having placed upon the County Councils the regulation of technical instruction in their several areas, the Council of the British Bee-keepers' Association desire to bring under your notice one branch of the work which for

the past twenty-eight years the Association has maintained in this country.

In 1874, when the practice of apiculture had reached its lowest ebb, the British Bee-keepers' Association was founded, first under the auspices of Sir J. Lubbock (now Lord Avebury), and since 1878 of the Baroness Burdett-Coutts, to teach by means of duly qualified lecturers and experts the modern methods of bee-keeping.

The Council, composed of practical bee-keepers, appoints examiners and issues certificates of proficiency in bee-keeping in accordance with the enclosed particulars.

As it is a matter of importance that only duly qualified persons should be recognised as technical instructors, the Council place these particulars before you, in order that you may be able to estimate the educational value of the certificates issued, and may be induced to require from any one applying for the position of an instructor in bee-keeping evidence of holding a British Bee-keepers' Association second-class certificate, or for important centres a first-class certificate.

The Council will at all times be willing to assist the efforts made by County Education Committees to give instruction in bee-keeping, and would also suggest the use of their sets of lantern slides for lectures, and of the last edition of 'Modern Bee-keeping,' as valuable means of imparting sound information on apiculture.

The Council hope, since technical instruction in the counties is now put upon a secure footing, that the important rural industry they represent may receive adequate encouragement.

Signed on behalf of the British Bee-keepers' Association, (.....)  
Chairman.

(ENCLOSURES)

1. Regulations for examinations.
2. Copy of 'Modern Bee-keeping.'
3. Copy of Expert's Visiting Book, with instructions to expert."

Mr. Reid said the object of that letter was, of course, to assist county associations where such existed, and not in any way to apply for grants. It contained no request of that kind, the communication being simply intended to point out to County Councils the best way of utilising the funds at their disposal, and to suggest that the money be placed in the hands of those who knew how to make the best use of it, viz., the County Bee-keepers' Associations themselves. Any replies from the County Councils coming to the Secretary of the B.B.K.A. would at once be referred to county associations where they existed.

Col. Walker (Devon) said the difficulty was that some County Councils handed this matter over to the Urban District Councils or to the Parish Councils. They exercised no discretion over the subjects taught nor the people required to teach them. Thus it was



left for the representatives of the County B.K.A. to bring what pressure they could on the various sub-Councils. Then another drawback was that in many places they had no local experts, certainly not a second-class expert, so that the business could be kept within their own county. The only remedy for counties was to try and pass as many experts as possible in the third class, and persuade these to study for the next higher grade of certificate.

Mr. Scattergood (Notts) said the subject was one that could be properly taught in every village in England at evening continuation schools. He held in his hand the "Board of Education Syllabus and List applicable to Schools and Classes other than Elementary." It was for the year extending from August 1, 1903, to July 31, 1904; and it contained a summary—fairly up-to-date—for teaching bee-keeping in English schools. The remarks in the syllabus were interesting, and if suitable persons to undertake the teaching could be utilised, much good might be done to young people, and in this fact a great future was assured for the bee-keeping industry. The difficulty was, however, that the village schoolmaster generally thought he knew everything. He (Mr. Scattergood) spoke from experience, and was sure that jealousy would be engendered if a stranger were called in who did not happen to be a qualified schoolmaster. He wished it were possible for the subject to be classed as an elementary science, and taught theoretically as well as practically to young men, who would thus be started on the road (if they cared to pursue it) to obtain expert certificates. A great effort should be made to get apiculture included in the syllabus of the counties. He was glad to say that in Notts they were spared the difficulty Col. Walker had described. The County Council made a grant direct to the County B.K.A., and had a representative on the executive committee thereof. The amount given was only £50, and it was generally admitted that the Association spent the money more economically than any other institution in the county did its grant.

Mr. Geo. Hayes (Hon. Secretary, Notts B.K.A.) said that at Kingston they had started a bee-keeping class embracing four counties, which was, he thought, a better plan than the schoolmaster's teaching of young people. He was glad to say they were in more fortunate circumstances as regards County Council work in Notts than some other counties were.

Mr. Cribb said they had a different system in his county of Lincs. The County Council asked the different districts what subjects they wished to take up. The lecturers were appointed by the County Council. As a lecturer himself he would relate a little personal experience. Upon entering the lecture hall he found forty or fifty children there making a great noise, and few, if any, grown-up people. After speaking a few words, however, he did not know that there were any children

in the room, so attentive had they become. He had found after a few years of lecturing, and also as local secretary of the Association, that it was difficult to get the working man to go out again after returning home from his labour. It did not matter whether the subject was poultry-keeping, gardening, or any other; but a lantern lecture on bee-keeping with a little singing would generally attract a good audience; but otherwise, a bee-keeper occupying a humble position in the village and possessing no influence would have little chance of securing a good attendance. He would, perhaps, get two or three of his friends to attend, and the schoolmaster would fill up with children. This was not to be wondered at when in some districts there were two or three inches of snow on the ground, but it was a common experience at all times. He (Mr. Cribb) quite agreed with Mr. Scattergood in his remarks about schoolmasters; but, independent of the objection raised, he thought that these gentlemen had quite enough to do to comply with the demands of the Education Act. Besides, a schoolmaster, even when he kept bees, was not always a suitable person to teach bee-keeping. One he knew had twenty hives, and no apiary in the district was so foul as his, and yet he would take no hints from experts.

Mr. Dawson (Surrey), remarked in reference to the circular sent to various County Councils that the matter came up for consideration before the Surrey Association, of which he was a member, when a fear was expressed that it might endanger the relationship of Associations to County Councils. The Surrey C.C. had given good support to bee-keeping in the county, and he believed the Association had returned good value for their money. As to lectures, no doubt they were most interesting to those who had a certain amount of knowledge on the subject, and were useful to any anxious to learn; but he believed that the man who had children and kept bees, could interest those children in his bees better than any lecturer could. Fathers and mothers should be induced to interest themselves in the subject. One half-hour with a practical bee-keeper at a hive was, he thought, better than any lecture. The BEE JOURNAL was always a good medium for advice, but apart from that, if a beginner took his difficulties to an expert he would be told in plain language the cause of this or that, and the remedy. This afforded more practical learning than a lecture, which could not be interrupted to settle points as they arose. More instructors were wanted—men who could be applied to, and sent about from place to place. Books were, of course, useful; they had a splendid one already, but he wished that it could now be supplemented and brought still further up-to-date so as to reach some of the cases and unforeseen circumstances well known to bee-keepers, but yet not touched on in the work.

Mr. Weston spoke as an examiner who had tried to help bee-keeping forward as much as lay in his power. At the instance of the Council of the B.B.K.A. he had gone here and there for the purpose of examining candidates for certificates, and by that means was able to learn something of the capabilities of men. Mr. Carr's work of a similar character had taken him a good deal among younger people. As a result of his experience he must say that the increase of an intelligent knowledge of bee-keeping was very marked within the last few years. The circular letter of the Association to County Councils was decided on because the latter were now the educational authorities of the kingdom. Until now the B.B.K.A. was the only body that set before itself the education of the country in bee-keeping as a desirable thing to be done; and as the County Councils had become the educational authorities, they should acknowledge this work as being part of their duty. The Wilts County Council had put the subject under their Agricultural Education Committee. They considered that bee-keeping was an agricultural employment which should be taught, and that a man to talk to and discuss points with was of more advantage to cottagers than lectures or books. A year or two ago an examination of candidates was held in Wilts without resulting in much success, but matters were improving there very much. The County Council wished to establish in various parts of Wilts men holding B.B.K.A. certificates, and who would be available for advice and instruction when applied to by the rural inhabitants.

Mr. Turner (Oxfordshire) said that some years ago the County Council gave the Oxon. B.K.A. a grant of £50 for apiculture, but owing to some misunderstanding withdrew the grant entirely, and partially renewed it after an interval by voting them £30. This was spent in lectures, expert visits, and demonstrations. The Association provided the experts, and the local authorities paid for the tent. There was always more interest in a demonstration at the local show than in a lecture given at a schoolroom. Another plan adopted in his district was to assemble those who were anxious to learn, and take them to any place in the neighbourhood where there was a decent apiary. Here the expert would give a demonstration. The subscriptions received by the Association, together with the £30 grant, enabled them to give instruction throughout the county. Without help from the County Council the Association could not do much, but by mutual assistance real good could be done.

In reply to Col. Walker, who asked what responses had been received from County Councils to the circular letter, the Secretary replied that seven or eight answers had been received, Middlesex, Oxford, and Wilts saying that they already made grants, and were en-

deavouring to carry out the Association's suggestions made by the parent body.

The Chairman endorsed Mr. Reid's statement to the effect that English methods were equal to any on the Continent, although probably no Government in the world did so little for the industry as our own. Germany had about thirty associations, nearly all of which published their own papers, the cost being borne by the Government, and this was sent gratuitously to all members. In Normal Schools bee-keeping was one of the branches of instruction which the future schoolmaster was required to teach.

The object of the circular sent to County Councils was to let the latter know that they could have qualified lecturers and experts if desired. It came to the knowledge of the B.B.K.A. that the grants were being used in some cases to pay non-qualified men—a fact proved by County Councillors who had attended the lectures. The Association was anxious that the Councils should know that it could supply men qualified to teach, and also what the qualifications were. Mr. Scattergood was quite right in saying it was the children they wanted to secure, or, at least, create in them an intelligent appreciation of apiculture. On the Continent it was taught in schools, so that those who wished could continue the study of bee-keeping later on, while all gained more or less knowledge of the pursuit. Mr. Hayes had said that in his county (Notts) the grant was given to the association. That was satisfactory, as the latter would be responsible for carrying out a work which it was always endeavouring to foster. The best body to dispense the money was undoubtedly the county association. With regard to the institutes mentioned as giving their own lectures, it was gratifying to know that four counties had joined in forming an Agricultural Institute. In America there were Farmers' Institutes, at which lectures were given and papers read, which were afterwards discussed. They recognised that theoretical lectures were as necessary as the practice which could be obtained on the farms, but it was only at the institute meetings that the science of farming was discussed. They also learned the results of various experiments tried by different agriculturists, and compared notes. He (the Chairman) was decidedly of opinion that theory must not be ignored. He was glad to hear what Mr. Cribb said with regard to lectures to children. Children would, no doubt, go a long way to see lantern demonstrations. Referring again to the circular, he said that it could not in any way prejudice the Surrey association with the provincial County Councils; nor, indeed, would it reflect on any county association, unless non-certificated experts were employed. It was a pleasure to know that the Oxford county association was doing well with the grant allotted to it, although the amount was a small one. Where larger grants were made, as in Surrey

and Devon, better results would, no doubt, be achieved; and they all hoped that the value of their industry would soon be recognised in this way. The debate was a very interesting one, and the Association would endeavour to carry out some of the suggestions made if possible.

(To be continued next week.)

### THE DAIRY SHOW.

The number of entries at this year's Dairy Show was—as mentioned in our hurried notice on page 401—a small one considering the importance of the occasion. There is no doubt a feasible explanation of the shortage in the fact that really good samples of this season's produce are scarce, and those who have had the good fortune to secure them are shrewd enough to realise the competitive value of choice lots for the show-bench in such a honey season as that just ended. But there is still another factor to be taken note of in connection with the show under notice, and that is the gradual "weeding out" of second-rate samples along with the gradual *grading in* of such as are really good, during the process of exhibiting all through the past year. In this way very few of the exhibits staged at the "Dairy" had not already won prizes at previous shows.

On the other hand, it might reasonably be supposed that the laudable ambition to secure a "win" at a show which brings up so many good bee-men to London each October, would stimulate entries by creating the wish among them to see their produce on view at the always popular Dairy Show. It is only by some such process that our ideal of the final big show of the year should be realised. No one will venture to say that the surroundings are not fully adequate to the occasion, and the prizes are worth competing for; but, apart from their money value, a "win" in such company is surely worth an effort if only for the general success of this annual gathering of bee-men.

The Show itself was good, but not large, as may be inferred from the number of entries (125). In the classes for  $4\frac{1}{4}$  in. square sections and for light extracted honey the winning exhibits were exceptionally good in both. The "tall section" class proved disappointing, both in entries and quality, and in consequence only one prize was awarded. The same may be said of heather sections. The trophy class with but three entries was entitled to only one prize, but on the recommendation of the judges a second prize was given. Beeswax produced a good display in both classes, that for marketable cakes being specially interesting and the competition very keen.

Mr. H. W. Seymour again secured the silver challenge cup of the B.B.K.A., though with a very modest number of fifteen points,

viz, one 1st, three 2nds, and one 3rd in the whole twelve classes. Mr. J. Carver followed with eleven points and Mr. W. Woodley with ten.

## Correspondence.

*The Editors do not hold themselves responsible for the opinions expressed by correspondents. No notice will be taken of anonymous communications, and correspondents are requested to write on one side of the paper only and give their real names and addresses, not necessarily for publication, but as a guarantee of good faith. Illustrations should be drawn on separate pieces of paper. We do not undertake to return rejected communications.*

### NOTES BY THE WAY.

[5260.] The unsettled weather of late has greatly retarded outdoor bee-work; but where the final tidying up has still to be done, the first chance should be taken to remove weeds and grass from about all hives, and placing broken tiles or slates under hive-legs to keep them dry and prevent decay. Hive-covers need also making waterproof, so that quilts and cushions may remain dry during winter. Where wood is cracked or shaky, leaky roofs should be covered with thin sheet zinc, and have the outside edges of the zinc turned well under eaves of roof and secured with  $\frac{3}{8}$ -in. tacks that will not pierce the outer side of zinc when driven home.

Stocks which may, from some cause or other, have been somewhat neglected by insufficient feeding, &c., will be better prepared for winter if a good-sized cake of candy be now given instead of syrup. Some, I know, boast of wintering their bees safely by giving syrup during the winter months; but I contend that bees should be fed up in proper time, so that they can have the food sealed over, then with a good-sized cake of candy to supplement the capped stores, a stock will come out stronger in the spring than one which has been continuously disturbed throughout the winter by feeding.

The modern bee-keeper has so many advantages over the old-style skeppist in nearly everything pertaining to the year's bee-work that success should be the rule and not the exception with the frame-hive man; yet, though his weekly or monthly journal may teem with advice of how and when certain work should be done among his bees, many persist in putting off till to-morrow work which should be done to-day; and so in a year or two we hear that he is tired of bee-keeping and "wants to sell out," generally because his "bees do not pay." My view is that the bee-keeper of that class should keep his bees as our great-grandfathers did, in straw skeps, and get a little honey sometimes with a minimum of cost and trouble; but to the man who will throw some energy and enthusiasm into his venture the frame-hive will not only pave the way to success, but become a storehouse of pleasure and a source of profit. As

time flies he will enrich his mind with new ideas and new facts, or new suggestions from others will present themselves through the JOURNAL, which, when worked out and perfected, will prove that there is always something new to be learnt on the practical, as well as the theoretical, side of bee-keeping.

*Insurance for Bee-keeping.*—It would be interesting if our Editors could give the approximate number of hives insured for the coming year; also the number of apiaries in which the hives are located. Thus if the number in each county were published there would, perhaps, be some emulation in trying to be at the top of the list; and, may be, secretaries of county B.K. Associations would push the insurance scheme. Experts, when on tour, might be instructed to keep the scheme to the fore; it ought to be the next item to membership—in fact, I think that many bee-keepers who are not members of associations would in their own interest insure against accident by their bees if the matter were put before them. My hope in this matter is that we may in the future—shall I say the near future!—be able to manage our own insurance with the foundation of hard cash, and thus be independent of underwriters.—W. WOODLEY, *Beeton, Newbury.*

## THE SEASON IN HEREFORDSHIRE.

### A GOOD REPORT.

\* [5261] The bee season just ended has been indeed disappointing, I fear, for most of those in the craft. For myself I thankfully confess to some improvement on last year, which was the worst I have known as a bee-keeper. My average surplus per hive (53½ lb.) this year, though only half the amount of my "record" year, is more than double that of 1902.

Very little work was done in supers here-about until the middle of June, and practically the whole of the surplus was gathered during the ensuing four weeks. Colour and quality of honey were very good; orders came in freely, and my stock is nearly exhausted, in spite of the fact that I advanced the price on some later wholesale orders. I have customers all the year round, and am never anxious to rush my produce upon the market; those who have had it once come again and again, and as I use a private label (from my own design) retail customers know when they get what they ask for at the stores. My best hive gave me 84 lb. of surplus, but this result was reached at the expense of the brood-nest, which was almost empty when supers were removed; but 25 lb. of good, warm syrup was at once supplied, and transferred below in as many hours. I only had one swarm, which gave me 48 lb. of honey, and stored its own "cupboard" to repletion. The hive from which the swarm issued (although moved to a new location, and robbed of some frames of brood) rapidly increased, and gave me 55 lb. of

surplus—a result I consider excellent in such an adverse season.

From the condition of my stocks I judge that breeding has gone on with unusual vigour long after the time when it generally begins to slacken. This is most likely accounted for by the late commencement of brood-raising in the spring. Hives a fortnight ago were brimming over with bees—a good omen for the coming season.—W. H., *Brilley Vicarage, Herefordshire, October 7.*

[Apart from "record" seasons, which will hardly be looked for in 1903, our reverend correspondent's report is one of the most satisfactory we have had so far, and we congratulate him on his success.—EDS.]

## FORMALDEHYDE AND "FOUL BROOD."

[5262] In reply to your correspondent, "Blackwood" (page 363), I have tried the following test-tube experiments, heating the tube with a spirit lamp:—

(a) *Formalin*, evaporated, leaving a white deposit (*i.e.*, paraform), which continued to give off gas until converted into a black deposit.

(b) *Formalin and water in equal parts*, with just the same result.

(c) *Paraform (in dry tablets)* gave off gas, leaving a very slight black deposit.

(d) *Paraform in water*, the paraform dissolved giving off gas, with very slight black deposit. (There was a mild explosion, in this case, not breaking the tube, but the gas is evidently ignitable.)

The smell from each of the above was of about the same strength, but it must be noted that in each case the gas combined with the products of combustion given off from the spirit lamp (which is the special point attained by the "Alformant Lamp." Attempts at smelling by quickly removing the tube away from the flame resulted in a broken test-tube, from sudden chill, in the case of the paraform test.)

When fumigating combs in a gas-tight box, the following are results of comparative strengths judged by smelling, and its effect on myself, at holes made at the top and bottom of the box. The gas comes off at the top hole first, and perceptibly later at the bottom hole, which points to the advantage of having two holes, the lower being closed last, after the gas is coming off at full strength, in order to drive out all the air:—

(1) *Formalin* ½ oz., water ½ oz., in an enamel iron cup. Gas very weak.

(2) *Formalin* ½ oz., in cup, gas a little stronger.

(3) One tablet of paraform, in cup, very weak. (In the above, the cup was pressed tight against the underside of the box, at a hole, the products of combustion of the spirit lamp not being able to combine with the gas.)

(4) One tablet of paraform in alformant lamp, overpoweringly strong.

(5) Half an ounce formalin in alformant lamp, overpoweringly strong.

No. 4 seemed a little the strongest at the time of generating, but No. 5 retained its strength the longest in the box, being almost as strong an hour after, probably owing to the moisture present holding the gas in solution, and slowly giving it off, so that in this case a longer airing of the combs would be needed, but does not prove that No. 4 may not be the most effective.

The lid of the box was luted on with a very carefully made *putty joint*, and the gas of Nos. 4 and 5 came THROUGH THIS JOINT, but not so in the other cases, which gives some idea of the strength of the gas!

As one tablet of paraform will disinfect a box of 50 cubic feet, and the cost of fifty tablets is 1s. 6d., the expense of the alformant lamp in using is almost nothing.

I am constructing a larger box, using "Willesden" 4-p.h. waterproof paper for the panelling, to be inverted on to a low table, also covered with "Willesden," with a rubber joint, and shall then further test its penetrating powers. I have made numerous inquiries but cannot get to hear of a reagent for this gas, but think I may be on the track of one which would be very helpful.

I have fumed some diseased combs, and will have to await results till the spring.—  
GEORGE M. SAUNDERS, *Keswick, October 12.*

#### A GOOD SEASON IN HERTS.

[5263.] Some of your readers may be interested in these few notes as to my third season with bees. I began the year with three frame-hives and close it with eight. During the spring I paid great attention to the bees' wants in the way of syrup, pea-flour, and water, and cannot complain of a bad season, as so many do, for I took 200 sections, and have doubled the number of my stocks as well. My total receipts amounted to £2 7s. 8d., and I have a dozen bottles of run honey on hand for home use.

I examined all my hives on September 4 and found one queenless. However, on September 7 I secured the queen of a swarm that had located itself in our parish church spire, and introduced her to the queenless hive. The bees were partially driven out from the church spire because repairs to the roof were being made, and the workmen preferred the bees' absence to their company; I had therefore cut out as much of their combs as were within reach, and the remaining bees were perforce driven out or got rid of.

The expert of the Bishop's Stortford B.K.A. called on me the day after my re-queening operation and pronounced all my hives healthy and very strong, and the queen above mentioned accepted.

*Bee Stings.*—These I have got quite used to this season; they vary much in intensity, but when stung badly I find no remedy better than simply sucking the place stung or pinching it hard if I cannot do the former.

Not many have heard, perhaps, of our Pelham's District Flower Show, but it may be interesting to note that we have three classes of exhibitors of honey—(1) amateurs; (2) tradesmen and mechanics; (3) labourers. This gives all a chance. I might suggest that county or district associations should have some classes open to all and separate classes for members only, according to the number of hives in use.—HERBERT NEWMAN, M.A., *Brent Pelham, Herts.*

#### PACKING BEES FOR TRANSIT.

[5264.] As a regular reader of the B.B.J., I have noticed some recent comments therein on the question, "Should we pay for dead bees?" and also on the subject of "Instructions as to how to pack bees for transit." Let me say, then, I bought a lot of driven bees a couple of weeks ago from a bee-keeper, and as they reached me at 7.30 p.m. (after dark), while they must have been in the box for about twenty-four hours before I got them, I had perforce to keep them in the travelling-box till the following morning. This would be thirty-six hours in all after sending off. Yet after putting the bees in the hive I saw only a couple of dead ones. This speaks well for the packing. We have had a very bad season here, and although the heather has blossomed well and been plenteous, the bloom was gone ere the fine weather came. During the best of the bloom the rain came down every day, and, in addition, it was very cold. During the early honey season (clover, &c.) it was also very wet, and nothing done. It makes one feel a bit disheartened. I had only had one swarm, and this came off when I was away from home for a day; consequently the bees decamped into the wood near our house, and although we searched high and low, they have never been found. After swarming the sections on the hive were deserted all the season afterwards.—A. H.

## Queries and Replies.

[3258.] *Dealing with Mildewed Combs.*—I have a large number of worked-out combs in standard frames, which I put away in boxes for the winter after having been cleaned by the bees. On looking at them to-day I found many of them covered with mildew. I shall feel obliged if you will kindly answer the following questions in your "Queries and Replies" column of the B.B.J., which I read every week:—1. How can I prevent mildew getting on worked-out comb when stowed away for winter? 2. Will the combs be fit to

give the bees next year if they have had mildew left on? 3. How can I remove the mildew from the comb? 4. Is it better to rinse the combs, after having been cleaned by the bees, in water with a little of Calvert's No. 5 carbolic in it, or keep them all the winter as the bees left them?—C. R. WYMER, *Greenwich, October 10.*

REPLY.—1. By seeing that the combs are thoroughly dry before storing away, and keeping in a cool, dry place. 2. If only slightly mildewed, the bees themselves may be allowed to clean the combs. 3. If very mouldy, we should clean by putting combs under a running tap for a few hours till the mildew is washed away, then dry them for use. 4. Do not use carbolic acid about combs intended for storing surplus honey in.

[3259.] *Porous Coverings for Hives.*—I have this summer been using American cloth for quilts. Will you kindly state in BEE JOURNAL whether they may remain on all winter, or must I replace them with something more porous? The season here has been wretched for the bees; yet from two hives (spring count) I have got 30 lb. of honey and increased to four stocks three of them with this year's queens, which I think satisfactory, considering the bad season.—A. Y. DANIEL, *Menston-in-Wharfedale, October 7.*

REPLY.—The utility of porous coverings is a moot point among practical bee-keepers, though the benefit of ventilation without through-draught cannot well be denied. On the other hand, we have the fact that bees will laboriously cover porous quilts with propolis if left to themselves. We prefer porous coverings, and plenty of them, then a newspaper over all; or the American cloth may be used above in order to retain the warmth. We do not find that the quilts underneath become damp in consequence of this.

[3260.] *The "Grace Cell Compressor"*.—Could you say if the "Grace Cell Compressor" (illustrated on page 386 of JOURNAL, September 24) is sold in this country, and, if so, the price, and where? I might say that my bees have done very well this season, considering the weather, my best stock giving me close on 80 lb. in the comb, and I have twenty good strong stocks for wintering.—S. S. CLEAR, *Cambs, October 7.*

REPLY.—We do not know who makes the above-named appliance in this country, but some information regarding it may probably be had from the advertiser who in our issue of September 24 mentions making "compressed queen cells and Swarthmore nursery cages" for sale. Messrs. Jas. Lee & Son also make similar "Swarthmore" appliances, we believe.

[3261.] *Bees "Robbing" in India.*—Can you advise me as to best way of stopping robbing? On the 6th, 12th, and 13th of September, I hived good swarms which covered six to eight frames each of founda-

tion, and the following day I, as usual, started feeding, but discovered that robbing had commenced though the entrances were closed to a bare  $\frac{1}{2}$  in., and the bee-escapes in the roof closed, and tin bee-tight feeders were used. I tried the wisp of wet hay in front of entrance for two days, but finding the fighting still continued hung a cloth wet with carbolic solution in front of the newly hived swarms, but even this has not stopped robbing, so I have now ceased all feeding. It is only the new swarms that are visited by the robbers and, as far as I can see, these villains seem to come from one of my best stocks with double brood-chamber and two racks of sections on. This hive sent out a very strong swarm on September 13, and I examined the hive, and cut out all remaining queen-cells save one. I then removed fourteen nicely sealed sections. Three days after I found a dead queen thrown out and therefore conclude that the one left in the cell had hatched out. There was plenty of honey sealed at top of brood frames besides surplus in the sections.

Our season here like that in England, has been very wet but when we did get a little sun bees worked well. What I would ask is: Do these very strong stocks with plenty of stores become robbers, or is it the wet weather that demoralises them? We had flowers in abundance, but the nectar was all washed out of them I imagine, and I am sorry to say I had one case of starvation pure and simple, only being able to save three frames out of a made nuclei of ten frames. I hope you received photos of the Downham Apiary sent last mail. I send name for reference and sign—QUERCUS, *Ootacamund, S. India, September 23.*

REPLY.—There is no doubt that strong stocks do at times start pillaging their weaker neighbours, not only at the close of the gathering season, but when adverse weather prevents the bees from reaching the more distant and legitimate foraging grounds in the fields. The best preventive of such trouble as is detailed above is to souse the robbers freely from a watering-can with water to which a little carbolic acid has been added. Do not make it too strong, just enough to render it distasteful to the bees, and repeat at intervals as needed. Photos not to hand so far.

[3262.] *Late Drones.*—I have two hives that had not killed their drones on September 23, on which date I examined them and found in both hatching worker-brood. I therefore let them remain, thinking perhaps the bees meant to re-queen themselves. To-day, October 7, I noticed one of the hives mentioned very busy, the bees carrying in pollen quite briskly, and some drones also going in and out. I have kept bees ever since 1873, and do not ever remember seeing anything like this before. Do not you think this

somewhat unusual?—S. S. C., *Royston, Cambs, October 7.*

REPLY.—Drones going in and out of hives in October indicates either actual queenlessness or an unmated queen heading the colony. In the latter case a short time only will be needed to make sure whether the queen is a drone-breeder by examining the brood in worker-cells after being capped over.

[3263.] *A Beginner's Various Queries.*—Your kind replies to my first letter encourages me to ask further questions as follows:—A few days ago I drove a skep of bees and found they were queenless. I united them to a stock in a frame-hive by simply throwing them out of skep on to a board and placing it level with alighting-board. A few puffs of smoke and the bees ran in, no flour or anything else being used, and they joined up beautifully and peacefully. 1. Was there anything unusual in this? 2. I want to make some "Cowan" hives, but am "fixed" over the dimensions. The "Guide Book" says (on page 37): "The front and back are reduced to 8½ in. high." Now, if this is so, seeing the measurement of standard frame is (from under top bar to extreme bottom of frame) exactly 8½ in., how do I provide the bee space between floor board and bottom of frame? 3. Which month do you consider would be best to re-queen two stocks of native bees with pure Italians? 4. Could you give me the address of nearest B.K. association I could join? Is there one in Lincoln? 5. How many pounds of candy (for seven frames covered with bees) would last a stock through the winter if packed down now, and

which have no stores in brood chamber? I enclose name for reference, and sign as before—*WORKER, Boughton, Notts, October 12.*

REPLY.—1. Nothing very unusual; but it would have been safer to adopt precautions, as the luck might easily have gone the other way. 2. Keep to the dimensions given in "Guide Book"; but do not omit noticing that the frames hang on metal runners, which raises the bottom-bar from floor-board as required. 3. Autumn is the best time for re-queening. 4. Mr. George Hayes, Beeston, Notts, is the Hon. Secretary of your County Association. 5. Your bees are badly prepared for wintering if they have no stores in the combs of brood-chamber in October. You would need to give cakes of soft candy (weighing, say, 2 lb. each), renewing as often as taken down by the bees.

[3264.] *Introducing Queens in October.*—I venture to trouble you once more for advice as to my bees. I have four stocks, one of which still contains a large number of drones, and in looking through the frames on Saturday, the 10th inst., I found three queen-cells, all apparently empty. I have never yet been able to find the queens in any of my stocks, except once, and in that case the stock was very weak, and eventually I lost it. At all other times I have looked the frames over in vain, so far as finding the queens. Do you think it likely that the stock having all these drones now are queenless? In any case, I think it would pay me to give a young queen to this hive, as the present one has headed the colony for two seasons. Are the young queens in the B.B.J. (Continued on next page.)

### BEES AS TEACHERS.

A correspondent, commendably desirous of assisting in promoting the sale of pure honey as a nutritious and wholesome article of food, forwards a copy of label, printed below, with the accompanying letter, asking our opinion thereon. It goes without saying that our correspondent's views are in the direction of total abstinence from alcohol, and in this there will, of course, be some difference of opinion among our readers, but on the chemical side

of the question the label is perfectly and technically accurate, and we have no doubt that the use of such a label will promote the object it is intended to serve. We therefore commend it to the notice of all concerned.

The letter is as follows:—

SIR,—I propose using the enclosed as a honey label. May I submit it to the judgment of yourself and readers of the JOURNAL generally? I believe the facts are as I have stated then, but I am open to criticism.—*A. W. BARKER, Torquay, September 29.*

## The Honey Bee—A Teacher of Total Abstinence.

Honey is taken by the bee from flowers in the form of "cane sugar." The bee converts this sugar into "grape sugar." This is the same change which is effected in barley by "malting." The sugar of the Vine is also grape sugar; and it is from grape sugar that alcohol is made, but it is made by the destruction of the sugar.

Grape sugar is a very valuable food. Honey, therefore, and grape juice are good Creatures of God. Men subject grape sugar to fermentation and so destroy its character as a food, in order to produce alcohol which is not a food. Bees take most elaborate precautions to prevent fermentation, and so retain the food value of the sugar, which is essential to their winter life and the continued existence of the community. Their sole requirement in winter is warmth; this is supplied by sugar, and would not be supplied by alcohol. They store the honey in small separate cells, they ripen it by evaporation, and they cover the cells with wax to exclude the outer air. Thus fermentation is prevented. The teaching of the Honey-bee, acting by the unerring guidance of instinct, in accordance with the laws of Nature, is that the production of Alcohol destroys a good creature of God, and substitutes an injurious "invention" of man.

advertisements at about 1s. 6d. each really suitable for introducing to stocks, or should you recommend a better one? I should be glad of your advice on re-queening, because if I got a young queen and could not find the old one, it would be necessary to run the young queen into the hive, and then I suppose the queens would fight, and if the new one was killed I should be no better off than before.—A. H., *Sheffield*.

REPLY.—It is fairly certain that the stock is queenless, and as the young queens referred to are cheap, you should procure one. It is hardly worth spending cash on a higher-priced queen for introduction to a not over strong colony.

### HONEY IMPORTS.

The value of honey imported into the United Kingdom during the month of September, 1903, was £1,095.—*From a return furnished to the BRITISH BEE JOURNAL by the Statistical Office, H.M. Customs.*

## Bee Show to Come.

A nominal charge of 2s. 6d. is made for notices in this column, which covers cost of insertion from order till date of show. Cash should accompany orders for insertion.

October 23 to November 11, at Newcastle-on-Tyne.—Honey Show of the Northumberland and Durham B.K.A. in connection with the Tyneside Grocers' Exhibition, St. George's Drill Hall, Newcastle. Open classes for sections and extracted honey. Members classes for sections, extracted honey and beeswax. Schedules from the Hon. Sec., Jas. Waddell, Wooler, Northumberland. Entries close October 27.

### Notices to Correspondents & Inquirers.

Letters or queries asking for addresses of manufacturers or correspondents, or where appliances can be purchased, or replies giving such information, can only be inserted as advertisements. The space devoted to letters, queries, and replies is meant for the general good of bee-keepers, and not for advertisements. We wish our correspondents to bear in mind that, as it is necessary for us to go to press in advance of the date of issue, queries cannot always be replied to in the issue immediately following the receipt of their communications.

J. H. HORN (Bedale).—*Dead Queen Cast Out.*—The queen bee sent is evidently a young one, but all pubescence has disappeared from the abdomen; the wings also have apparently been nibbled away by the bees, along with the hairiness on body, in process of "balling," which has no doubt been the cause of death.

REV. H. E. THURSBY (King's Lynn).—*North Norfolk, B.K.A.*—The Hon. Sec. of this Association is Mr. C. J. Cooke, Edgefield, Melton Constable.

E. J. P. (Alsager).—*Joining B.K. Association.*—The Rev. E. Charley, Hon. Sec. Cheshire B.K.A., Ince Vicarage, Chester, will give full information regarding membership and obtaining "expert" assistance.

T. K. (London, S.E.).—*Curious Experience in Hiving a Swarm.*—The man who was so badly affected by a few bees "settling on his arms and face while hiving a swarm" must surely have been stung! Otherwise the subsequent swelling and illness are almost beyond belief. The trouble could not even be caused by fright if the man had—as stated—"hived swarms for years past."

R. J. T. (Romford).—While much obliged for extract from *Le Petit Parisien*, we rather think the relation of such incidents connected with bees only tends to create needless alarm with regard to bee-keeping without serving any useful purpose. Anyway, we need not import them from the Continent; our own evening "speshuls" can supply all our needs in the sensational line, and, judging by our experience, the startling parts about bees we read therein usually contain modicum of fiction tacked on to minimums of fact.

A. G. L. (Bristol).—*Expert's Certificate.*—For particulars regarding these write to Mr. E. H. Young, Secretary B.B.K.A., 12, Hanover-square, London.

W. POLLARD (Silsden).—*Medicating Bee-food.*—We are glad you have now succeeded in medicating bee-food all right as per "Guide Book." Methylated spirit as used by french polishers would certainly spoil the recipe.

C. S. (Cardiff).—*Candy-making.*—There is no real need to add honey to bee-candy, and it increases the difficulty of making with no more advantage than rendering it attractive to the bees. But they will take well-made soft candy freely that contains no honey at all. Use the honey preferably in preparing syrup-food if you wish to utilise in that way.

### Suspected Combs.

ANXIOUS (Cockermouth), E. J. P. (Cheshire), and E. M. A. (Oxon).—Samples sent by all the above are badly affected with foul brood of long standing, and we advise drastic measures in each case. Everything loose about the hives should be burnt! In the first-named case the stock to which the diseased bees were united will need close watching in spring, it being probable that the trouble will break out therein. Referring to the case of "E. J. P.," no doubt he will take warning from the above and destroy bees and all, instead of uniting them to a healthy stock as proposed.

\*.\* *The Report of Bee-keepers' Conference occupies so much space in this issue that we are compelled to hold over several Letters and Queries till next week.*



## Editorial, Notices, &c.

### BRITISH BEE-KEEPERS' ASSOCIATION CONFERENCE WITH COUNTY REPRESENTATIVES.

(Continued from page 415.)

Mr. Weston had been asked to say a few words in introducing the subject of Exhibitions, because after the education of the bee-keeper, the exhibition of the produce that he brings to market is the one thing which will attract the attention of the public to the industry, and probably induce some to take up the pursuit, especially when they see there is something in it besides merely learning the ways of bees. When an inquiry into this question was suggested to him as a subject for discussion he wondered in what way it would be most likely to interest the general public in bees and honey, and he thought that probably few knew to what an extent honey-showing was carried on in the kingdom at the present time. Readers of the B.B.J. would from time to time notice reports of shows held in various places, and in many cases they merely turned over to the next page, because shows held outside the readers' neighbourhood had no interest for him. He (Mr. Weston) had therefore tried to find out what the country generally was doing about honey shows from what appeared in the B.B.J., which no doubt received advertisements of the principal ones in the kingdom; and he would here take the opportunity of thanking those ladies and gentlemen with whom he had corresponded for the kindness and courtesy with which they had answered all his questions.

During the season of 1903 the number of shows held he believed amounted to thirty-nine, reports of which had appeared in the B.B.J., and from three of these he had had no return of the value of the prizes offered. The total value of the money prizes awarded was £501 4s. 9d.—a sum much larger than might have been expected. Of that sum £183 had been given at the four shows held in London, viz., the "Royal," the "Confectioners'," the "Grocers'," and the "Dairy Show." The balance going to the remaining shows, a full list of which he had prepared for publication in the B.B.J. later on.

It would be found that the number of entries did not at all correspond with the value of the prizes offered. For instance, at the "Royal" £70 5s. was offered in prizes, yet there were only 203 entries for 106 prizes, and finally only eighty-one bee-keepers competed for these 106 prizes at "Park Royal."

At the Conference held in that room last year it was decided to arrange the counties in different parts of the Kingdom in groups, in order that the honey produced in various districts might compete on equal terms at the chief show of the year, viz., the "Royal."

This change involved an increased expenditure of about £30 in the amount offered in prizes.

He was afraid, however, this new departure was not very successful, for in some cases there had been no entry at all, while in others there were only two entries for three prizes. He felt they had not been supported by the county associations so heartily as they ought to be at the "Royal" Show of this year, and if friends of the cause would do their best to promote entries the number of exhibits staged, and the general results would be more encouraging to the B.B.K.A. and the Royal Agricultural Society, who helped them in their efforts would, no doubt, be grateful also. With regard to entries the show of the Surrey B.K.A. at the Crystal Palace had produced no less than 283 entries. There must be some special reason for that; no doubt the "Palace" was a splendid place to show in, and every exhibitor he believed was provided with a free entry. But, whether or no, the Surrey bee-keepers certainly did support their own show in a praiseworthy manner. The two heaviest amounts offered after the "Royal" were the "Confectioners'" and the "Grocers'" respectively, which, between them, gave £90 in money prizes, and had a total of 273 entries for the two shows. Another little matter he found worth looking into. It would be seen that a great many of the small shows had a class for 1-lb. jars of extracted honey and 1-lb. sections with free entry, but the exhibits became the property of the show committee. He wondered whether that was a useful class or not? and also if it was worth continuing? From the returns of eleven shows he found that £12 0s. 6d. was given in prizes for sections and jars containing a total of 229 lb. weight of honey. The entries were free in every case, so that the committees were actually distributing more money to the senders of these exhibits than the contents were worth!

It was also well known that many were deterred from entering into competition by the rules which allowed the same competitor to enter the same exhibit repeatedly at different shows. They say—"We have no chance against so and so," meaning, of course, the leading exhibitors. In the B.B.J. he found reports of thirty shows, and had noted names of the prize winners. The total number of prizes was 914, whilst the total number of winning competitors was only 357. Forty names occurred five times and upwards, and sixteen names ranged from ten times up to twenty-two successes. These facts only proved that those who made "showing" a study naturally enough won the prizes, and they came from all parts of the Kingdom, such as Lancashire, Cambs, the Midlands, the West of England, and the Home Districts. Locality therefore could hardly claim all the credit, but rather the bee-keeper himself. The question then arose whether they were spending their money in the best way to encourage bee-keeping by the present arrangements at shows

seeing how many classes were badly filled. Personally he wished more heather-honey could be seen on the show-bench. There were often barely enough entries to cover the prizes. He also asked whether it was worth while to retain the classes for very dark honey? He, as a judge—and having to taste samples—did not quite like going through all of it! Certainly the worst looking stuff was not always the worst honey; but was it worth while to give a prize for samples unfit for a tradesman's sale counter?

In reply to Colonel Walker, Mr. Weston said that the prize-winners' names were taken from the B.B.J., and the particulars of entries obtained by correspondence.

Mr. J. B. Lamb (Middlesex) having suggested that the dearth of entries might be owing to members not knowing about coming bee shows in their district,

Mr. Dawson (Surrey), in reply, said he thought that any bee-keeper who took a real interest in his hobby would invest a penny per week in the B.B.J., in which case he had only to look therein in order to find full information about "Shows to Come." Mr. Weston, he said, had referred to the want of support given to the "Royal," but he (the speaker) thought that, as in his own case, the date was fixed too early, and he had no honey to show. (A gentleman here remarked that honey of any year was eligible in all the classes at the "Royal.") No doubt the same names appearing as winners over and over again at shows had also a deterrent effect on any but first-rate bee-keepers. That he believed was the reason why shows were not more widely supported. On the other hand, the show of the Surrey B.K.A. received a large number of entries, because the members were numerous and the Association was blessed with an enthusiastic secretary, who was always importuning and stirring up the members to a performance of their duties, one of which was supporting the annual show, and thus in sheer desperation they were obliged to carry out his wishes.

Mr. Reid expressed his gratitude to Mr. Weston for the trouble he had taken in preparing such interesting statistics as they had heard. The fact that a number of exhibitors were accustomed to "sweep the board" at successive shows was well known to them. They would be very glad, if it were possible, to prevent exhibitors from wandering about from show to show to win prizes. For instance, he had seen the same samples of wax at four or five different exhibitions. It was, however, very difficult to frame a regulation against this, although judges would welcome a change if it could be effected.

Mr. Carr did not see how it would be practicable to exclude the same exhibit from appearing at different shows. He also thought that the trouble in this line was diminishing. Take Mr. W. Woodley, who had been a leading exhibitor for over twenty years, and had

maintained a very high standard for comb-honey during that time. But his methods had been copied by others, and his plan of glassing sections was now naturally followed by those whom he had taught by sending samples to. In this way Mr. Woodley's sections were not so different in appearance from others as formerly, and, judging by reports, he was not so uniformly successful in prize winning. The question arises, Is it advisable to prevent a man from staging winning exhibits more than once? Were they to deface or appropriate them? If so, the number of entries, the paucity of which had been a cause of complaint, would, he thought, soon be still greater. While heartily congratulating the Surrey Association on the splendid entry at the Crystal Palace—particularly in view of the small prizes offered, which made the result even more honourable than it would otherwise be—it was astonishing to think of the comparatively small entries at the London great shows. Why, at the "Confectioneries," in the trophy class, the four exhibitors who competed and each paid 2s. 6d. entry fee (10s. in all) between them carried off £10 in prizes! Moreover, almost the same thing again occurred at the "Grocers'" Exhibition later on, the trophy class only producing five entries for the same sum in prizes, and the B.B.K.A. silver medal thrown in for each first prize. This was a case of getting pounds for shillings, but it did not afford much encouragement to those who endeavoured to promote the bee-industry by establishing markets for honey. Good prizes were also offered at the "Dairy Show," and yet the entries were small. All this showed that nothing must be done which would, directly or indirectly, check entries, as they certainly would if they prevented exhibits from winning more than once. If a satisfactory way out of the difficulty could be found, he would welcome it; but he was convinced no step must be taken which would have any tendency to hamper competition.

Mr. C. N. White said his experience was that many bee-keepers would enter for shows but for the fact that they felt certain that someone who had become really expert in preparing his produce for the show-counter would "sweep the board." Bee-keepers with only two or three hives were naturally chary of competing in such a case. In his (the speaker's) association they had a plan of stamping sections, and he could show the value of the system by mentioning that there was a gentleman present whom he had met in the train coming up to town, and in the course of conversation, the former said—"I have just come from a show where I have given first prize to my own sections that took a first prize at another show yesterday." It appeared that these sections had been bought by someone, and re-exhibited under another name—an impossibility if the sections had been stamped.

Mr. Cribb thought the average number of

exhibitors compared with prizes came out at about three to one, roughly. If any one determined to show, it was generally worth while to enter in two or three classes. At their Lincs. County Show there was a class for dark honey, but on one occasion none appeared. Last year all the honey shown was dark. With regard to certain exhibitors "sweeping the board," there was at most shows the "County class" and the "Open class." Personally he did not think Mr. Woodley's sections had deteriorated in the slightest; it was only that others had done better than usual, and a magnifying glass was sometimes required to determine the best. As to the "Royal" Show, it was held too early for any one to exhibit unless he lived in the south, except in the class for granulated honey. The public seemed to look on the latter as honey "gone wrong," instead of recognising granulation as a proof of purity.

A delegate here remarked that Mr. Cribb could not have read the schedule of the show he was referring to, which stated that honey of any year was eligible for all the classes.

Mr. Scattergood said that competitors had to consider that besides entry fees, there was cost of conveyance to show, and that expense made them hesitate to enter, or when several fruitless attempts had been made they got disheartened. On the other hand, some exhibitions were not creditable to the bee-industry, which would be better without them, and at such shows competitors did not secure prizes because they did not earn them. He had judged at four or five county shows this year, where much of the extracted honey was excellent, while there were some exhibits having  $\frac{1}{4}$  in. of froth at the top of the jars, an evidence of slovenliness and carelessness in making ready for the show. He recommended that beginners in bee-keeping should be taken to exhibitions like the "Dairy Show," as the splendid specimens on view there would be likely to fill them with ambition to become successful on the show-bench. He was also strongly in favour of county labels, and had received a lot of letters on different occasions asking where honey could be purchased bearing the Notts County label, which showed that the label was a guarantee of quality, and the use of it a good advertisement. The plan could not be carried out in London, but might be enforced at all county association shows. He suggested more varied classes in appliances at county shows, not a huge class like they had at the "Royal"; also that there should be a class for a "Complete outfit for a beginner," not making the cost too high or too low.

Mr. Turner thought it was a question whether the amount of the prizes had any effect whatever on shows. The success seemed to depend more on an energetic secretary and strong committee. They of the Oxfordshire Association only gave prizes of 5s. and 2s. 6d., yet the entries were satisfactory.

Mr. Weston said that he and Mr. Carr were at variance regarding the repetition of the same exhibits time after time. He disliked this very much. The gentleman whose name had been specially mentioned as a successful exhibitor did not show the same samples anything like so often as some others who entered for small shows, and cleared the prizes at each. He contended that honey did not stand in the same category as most other exhibits. Live animals, for instance, were valuable for raising other stock to perpetuate their good points, while a sample of honey was supposed to be consumed and done with.

Mr. Carr observed that if winning exhibits were only to be staged once the "Dairy Show" instead of displaying the finest specimens of the year's produce and bee-work could only show the "failures" of all the exhibitions of the year.

Mr. Weston replied that an intending exhibitor at the "Dairy Show" could keep his honey for that purpose alone. One way of stopping the "pluralists" would be to buy in the exhibits. In the case of the £1 prize for 3 lb. weight of beeswax the latter might well become the property of the Show Committee. He noticed at the "Dairy Show" there was in the gallery a gentleman selling fairly good British (not English) honey, who, in the course of conversation, said there was not enough English honey available to make a market, and that if he wanted a ton he would not know where to obtain it. He (Mr. Weston) was of the same opinion, and believed there was ample room in this country for much greater production. The fact was that the big bottlers were obliged to bottle foreign honey, because they did not know where to look for enough English produce.

The Chairman, in summing up the debate, said that in addition to the £23 given as prizes at the "Dairy Show," there was a challenge cup valued at £25 offered as a prize. He quite agreed that the "Royal" Show of this year was disheartening from their point of view. The alteration in the schedule had cost the Central Association £30 over and above the usual sum to provide the extra prizes, and the result was not satisfactory. It would therefore be a question for the Council to consider whether the extra classes needed for the grouping of counties should be continued, although he thought the plan might be tried for another year, in the hope that now the grouping plan was understood county secretaries would use their best endeavours to get entries from among their members. The Surrey Association had 283 entries at their show, but he (Mr. Cowan) found that out of the five classes at the "Royal" specially set apart for the group in which Surrey could compete there was not a single exhibitor from Surrey. It could not be made too widely known that honey of any year was available; thus it was easy to keep sections or extracted honey with the object of exhibiting. With regard to

dark-coloured honey, it was well understood that every county did not produce it every year; but some counties generally had some good dark honey, and he hoped in future they would be induced to compete. The "Royal" had this year nine dark-honey classes, and yet in the whole of these there were only twenty-two entries; indeed, two of the classes did not produce a single entry. Another class received only two entries, and others only three, four, and five exhibits respectively. Every one would agree that it was most discouraging to offer prizes of 15s. and 10s. in order to get five entries at the most. The object was to enable bee-keepers located in contiguous districts to compete on perfectly equal terms amongst themselves that the grouping of counties was undertaken.

Regarding the question of prize-taking at various shows by the same exhibit, there was considerable difficulty in taking any steps to check this with all-round advantage. Much could be said on both sides, but where it was known that exhibitors sold their honey purchasers of the same should certainly be debarred from exhibiting the bought samples with the object of winning prizes. In the schedules of the B.B.K.A. it was expressly stated that the "honey must be the *bona-fide* property of the exhibitor, and produced by his own bees." Any offender against that rule ought to be disqualified from entering at all future shows. Mr. Scattergood suggested that there should be a class for "Beginners' outfits." There had been such a class every year for some time past at the "Royal," which stipulated that the value should not exceed £1 10s., but he and his co-judge had in their report this year recommended that this particular class should now be discontinued. There were several cogent reasons for their doing this. The same articles were exhibited year after year, and the competition resolved itself into a contest as to how much each exhibitor would put into thirty shillings' worth so as to obtain the prize, regardless of the total legitimate price of the "outfit." That became an abuse, because it was evident (one man had admitted it) that the goods could not be supplied for the money. He thanked Mr. Weston for his valuable statistics of exhibitions, which probably could not be digested at once, but would be read closely and with great interest when they appeared in the B.B.J.

He also wished to acknowledge their indebtedness and that of all at the meeting for the many useful suggestions thrown out by other speakers, promising that they would receive full consideration by the Council without needless delay.

The meeting then adjourned for a short interval, during which light refreshments were partaken of preparatory to the *conversazione* later on.

(To be continued next week.)

## Correspondence.

*The Editors do not hold themselves responsible for the opinions expressed by correspondents. No notice will be taken of anonymous communications, and correspondents are requested to write on one side of the paper only and give their real names and addresses, not necessarily for publication, but as a guarantee of good faith. Illustrations should be drawn on separate pieces of paper. We do not undertake to return rejected communications.*

*\*.\* In order to facilitate reference, Correspondents, when speaking of any letter or query previously inserted, will oblige by mentioning the number of the letter as well as the page on which it appears.*

### AMONG THE BEES.

#### AN ANCIENT BEE-MAN OF REPUTE.

[5265.] A reputation which holds good for the long period of about 2,000 years must have been founded on a stable basis. Judged by this text, the great work of Columella, "De Re Rustica," establishes him in the highest position amongst the most learned of Roman writers on practical agriculture. We are interested in this ancient "Book of the Farm" entirely because of his having dealt with the subject of apiculture—a subject which he treated copiously, and, considering the period at which he wrote, with wonderful accuracy in many respects. Judging by my reading of bee-books, ancient and modern, no other writer is quoted so frequently or so extensively as an authority worthy of all credence and dependence. His description of the best position and situation for an apiary might be set down as the production of some quite recent writer, so accurate is it in every detail. The hives should be placed facing the south, in a place neither too hot nor too much exposed to the cold or high winds. It should be in a valley, in order that the loaded bees may with greater ease descend to their homes with their heavy loads; it should be near the dwelling-house, on account of the convenience of watching them, especially at swarming time; so situated as not to be exposed to noisome smells, or to the din of men or cattle; it should be surrounded by a high wall or fence, situated near a running stream, or with water within easy reach, because they are not able to rear their young without water—yet the neighbourhood of ponds, lakes, or large rivers should be avoided as being destructive of bee-life; that the garden or surroundings should be plentifully furnished with bee-plants, and that the trees planted near should also be such as will aid in honey-production and provide bee-forage. All these directions are sound, practical, business-like. He enumerates quite a large number of plants suitable for this purpose, most of which we even now recognise as excellent honey-producers. In this connection he advocates, and quotes from more ancient writers to enforce his argument, something like the migratory bee-keeping we read of at later times, and distinctly lays it down as a law that, to secure the full benefit and

advantage of successive honey-flows, hives should be shifted to other districts or altitudes, much as we transport modern hives to the heather. He even gives directions how they ought to be examined and put in order so that they might reap the full advantage of the change.

The formidable list of bee-diseases and bee-enemies occupying so many pages of all ancient bee-books are mainly founded on his initial account; and, even at the close of the eighteenth century, we find all on which he had placed his imprimatur gravely recorded at length, and generally in all but his own words. Robbery and depredation must have been a vice inherent in *Apis mellifica* from the first of time; and, indeed, the dreadful battles he recounts would make one think that the smell of battle was their sole delight. Yet he was not afraid of bees, but manipulated them at will; and he gives explicit directions for conquering and overcoming them so that their domicile could be examined and cleaned at the desire of their master. He certainly deserves our thanks and gratitude for so persistently inculcating cleanliness in and about hives. Though his main object was the clearing away and extirpating of the dreaded wax-moth, yet his pleading would tell all round in securing the health and cleanliness of the stock. So soon as spring arrives, he advises that all the accumulated rubbish must be removed, and everything about the hive in any way offensive must be cleared away, "when the bees will apply themselves to work with the greatest diligence and resolution." This opening and cleaning is advised to be done repeatedly during the season; but on the approach of winter they should be left quite undisturbed, "as it is not proper to open them in winter."

Columella, even at the opening of the first century, gives particular directions for taking honey and wax by the more humane and judicious manner of saving the lives of the bees. He advises the cutting out of old combs, with the object of having them renewed, and is strict in his injunctions that none containing bee bread or young bees should be taken out. His system of running out honey is almost identical with the custom quite prevalent with skeppists of quite recent years as I have seen it practised. Amongst the enemies of bees he enumerates is dysentery, and I name it specially to note the cause he assigns for its origin, for he blames the honey obtained from the elm and spurge blossoms as the source of the evil; he says the bees feed so greedily on this inferior honey that they surfeit themselves and die if not relieved. The cure advised is rosemary and honey, diluted with water, but he failed to prescribe what even more ancient bee-keepers advised as the most effective cure, taking away the combs most soiled, or even changing their hive. He practised feeding his bees in a very ingenious manner, for, after thinning the honey in water, he sprinkled it on wool and left the bees to

suck it dry. So many bees at that time made their homes "within the hollow oak," as Virgil sings of their doing, that it is no wonder he gives a lengthy, precise, and elaborate system of discovering their homes by watching the bees when they were out foraging, and then attentively observing their line of flight and "lining" them to their hives. It, indeed, reads almost word for word, like the instructions given in a modern American work where the same practice is carried out as a fine art. Many other points might be touched on, but I have said sufficient to show that even in modern times Columella might be set down as a bee-man of repute.—  
D. M. M., *Banff*.

## THE VILLAGE SCHOOLMASTER

AND THE BEE-KEEPERS' CONFERENCE.

[5266.] I was sorry to read in your report last week of the Conference with county representatives what was said by some of the speakers regarding the village schoolmaster as a teacher of bee-keeping. Were not the speakers overlooking a powerful instrument in the advancement of modern bee-keeping in thus minimising the influence of the schoolmaster? And would it not be wiser to get these men—who from their professional and geographical positions are, perhaps the best possible missionaries of apicultural knowledge to the young people of the country districts—to take an interest in bees, and to evoke a similar interest in their scholars?

Mr. Scattergood, from his remarks on page 413, seems to fear that "jealousy would be engendered" on the part of schoolmasters who, he finds, claim a monopoly of skill in imparting knowledge. I do not believe that such a feeling or claim is at all general. He had, perhaps, in his mind a teacher who has come across an outsider—thoroughly acquainted, maybe, with his subject, but who lacked the power of interesting and controlling children—convert a class-room into a pandemonium. I would ask—Who is so competent as a schoolmaster to teach children? And surely he would not attempt to teach a branch of knowledge which he himself did not understand? And, again, to whom are children so likely to listen with respect as their own schoolmaster?

I have known schoolmasters give lessons to large classes assembled round opened frame-hives in the garden of the school-house, and believe that half an hour spent in this way is worth more than several County Council lectures. I cannot help thinking that lectures sometimes do much harm by stirring up enthusiasm and then leaving beginners in the lurch with their difficulties on hand, and in not a few cases these difficulties eventually cause them to throw up bee-keeping with feelings towards both the bees and lecturer which it would be difficult to express politely. The Worcestershire County Council has

recognised this deficiency, and three or four years ago appointed five or six schoolmasters—all holding B.B.K.A. certificates—to give courses of practical lessons at various centres, and also to visit individual apiaries where application was made for instruction.

Country schoolmasters are driven by their isolated position to rural hobbies, and if statistics were available, it would probably astonish some people to know how many of them take to bee-keeping. They are largely represented on the committee of our County Association, and can justly claim their share of any credit due to it for its work on behalf of beekeepers.—JOHN P. PHILLIPS, Hon. Sec. Worcestershire B.K.A., *Spetchley, October 19.*

### A SCHOOLMASTER'S BEE-KEEPING.

[5267.] I began in 1901 with a fine double swarm hived in a twelve-frame "Combination" hive. A neighbour had promised to hive them for me; but as he did not turn up to time, I did it myself. Knowing little about it, I got well stung! The bees did not run in so fast as I thought they should, and so to hurry them up a bit I gave them a hoist up behind with a wing. This "pushful" process they *sternly* resented, and commenced boring operations on my bare arms. I rather think those bees got more attention than most colonies do. They were syruiped, naphthalined, covered with blankets and cork-dust; supplied with pea-flour and water, shaded from the sun, and generally coddled. However, they rewarded me by filling forty-two 1-lb. sections.

The next year the hive sent out a swarm, and thus gave me another good stock; but besides this the school-children kept their eyes open for stray swarms, and having found one, rushed off to tell "master," so that by the end of the year I had four stray swarms whose owners could not be found.

Feeling now a little more at my ease with bees, I began experimenting by introducing foreign queens, and these I find very prolific; but their comb-honey is not so white as that of our natives. I have only bought two hives—the aforesaid "Combination" and a non-swarmmer. The latter is inconvenient, because ordinary sheets of excluder will not go in, nor will a "Porter" escape-board, let alone a Lee's or a "W. B. C." section-rack. All my other hives I made myself; some are "W. B. C.s," some non-swarmmers, while some are single-walled hives. The roofs I cover with cloth or canvas painted both sides. I have also made an extractor large enough to take four standard frames, and this I find most useful.

The photo I send you is of a home-made observatory hive which I have fixed in the school window, and in which my pupils take great interest. They now have practical lessons in hiving swarms, bee-driving, foundation-fixing, &c., &c., which it is to be hoped they will make a good use of in years to come.

And now let me say that I think Mr.

Scattergood's remarks at the B.B.K.A. *Conversazione* are altogether too strongly flavoured with prejudice. I presume he has met one or two conceited schoolmasters, and from that argues that we are all smitten in the same way. I hope that is not the opinion of my respected tutor, Mr. Jesse Garratt. Anyway, I think Mr. Scattergood should drop generalising and only state facts. Mr. Cribb, I notice, agrees with him, but what about Mr. Cribb himself? He is careful to let us know the wonderful influence his eloquence had on an assembly of fifty noisy children. I wonder if the sudden change to order and attention was due to his interesting address, or to the entry of a "conceited" village schoolmaster? What does our friend "D. M. M." think?—S. DARLINGTON, *Charing, Kent, October 17.*

### THE LATE DAIRY SHOW.

#### A WORD ON THE AWARDS.

[5268.] Will you allow me to call attention to the editorial remarks on page 415 last week referring to the winning of the Silver Challenge Cup? You say, "The 'tall section' class proved disappointing, both in entries and quality." This is certainly not correct in respect to the 1st prize lot, and I think will leave a wrong impression on bee-keepers who are now using these sections. For myself, I am sure they are the best size for bees, bee-keepers, and consumers, and, if they were properly encouraged, would eventually supersede the 4½-in. section altogether. In proof of this statement, Mr. W. Woodley admitted to me that my 1st prize exhibit in this class were the finest sections in the whole show, and I will be glad if he will verify this, if these lines should catch his eye. You also say the Trophy Class with only three exhibits was not entitled to more than one prize; but, on the judges' recommendation, a second one was awarded. It has occurred to me that this a bit hard upon some of the other exhibitors, as this thoughtful, not to say illegal, decision, in this and the last class in the schedule, gave the cup to last year's winner, as in the latter class there was only one exhibit, and I understand that no prize shall be awarded unless there are several exhibits staged. It is stated that the successful exhibitor gained the cup by four points, but if we deduct the six points given contrary to the rules, he would have occupied the third position instead of the first.

I am not bringing this matter to notice with any intention of interfering with this year's award, but for the guidance of exhibitors at future shows where the Challenge Cup comes in, and will be glad if others would give their opinion whether judges should break the rules to give any prize, seeing that, as happened in this case, they do not at the time know that their generosity is giving away, not "winning," the same. I am in no way antagonistic to Mr. Seymour, who is a bee-keeper. I have the greatest respect for him. But I should

like to know how far the rights of the judges go in doing these things?

I also think your remarks about the "modest number of fifteen points" out of a possible forty-eight make it appear an easy thing to get prizes at the Dairy Show, fifteen being one-third the points possible for any exhibitor to get. I consider it very good, in view of the competitors met with there. Some of the exhibits staged at the "Dairy" which had taken 1st at many shows did not get a commend there.—JOHN CARVER, *Wellington, Salop, October 17.*

[It will not be needful for us to say more than remind our readers, first, that exhibitors at a show are, as a rule, not the most competent critics; and, second, that judges are responsible only to those who frame the schedule for carrying out its rules as laid down. On the other hand, so long as the appointed judges do their best, without fear or favour, they may leave the rest to those who are entirely free from bias so far as awards.

With regard to the editorial remark on the class for "tall sections," our reference was to the class as a whole, which was obviously "disappointing;" seeing that but four exhibits were staged, and only one prize awarded.—Eds.]

#### BEEES AND TOTAL ABSTINENCE.

[5269.] I object to "A. W. B.'s" honey label (shown on page 419 last week), because it will neither promote the sale of honey nor advance the cause of truth. As to alcohol being an "injurious invention of man," I deny it—fully as I admit man's abuse of alcohol—but you will object to a discussion on Total Abstinence in the columns of the BEE JOURNAL. I would like, however, to quote an anecdote I lately heard on this subject by way of *reductio ad absurdum.*

A well-known clergyman at a banquet quoted Paul's advice to Timothy:—"Drink no longer water, but use a little wine for thy stomach's sake and thine often infirmities." A guest of "A. W. B.'s" persuasion insisted that the wine was to be taken externally. "In that case," said the host, "we must alter our customary formula. Gentlemen, fill your sponges and let's have another dab!"—E. D. T., *Eynsford, October 17.*

#### SWARM CATCHERS.

##### A BEGINNER'S EXPERIENCE OF THEM.

[5270.] With reference to the inquiry on page 407 in the B.B.J., as to a "really efficient swarm catcher," perhaps my experience with one, as a complete novice with bees, may be interesting. I may say that having to be away from home all day the swarm-catcher makes bee-keeping possible, whereas without it the risk of losing swarms when absent would render it, at least for me, inadvisable. The "catcher" I have is an "Edwards," and I

commenced bee-keeping this last spring by the purchase of a stock from Mr. Edwards, in a hive equipped with one of his "catchers." On one evening early in July, I found a swarm in the "catcher." I threw them out on to the alighting board and they returned to the hive. I then had all the queen-cells cut away. After this I went into Wiltshire for two days, and on my return I found the "catcher" again tenanted with a swarm, and the same procedure was gone through as before. The bees did not swarm again but settled down, and I had two racks of sections filled besides enough honey stored below for them to winter on.—A. H. P. CATON, *Eyfleot, October 17.*

#### MY BEE EXPERIENCES.

[5271.] I have kept bees for only about 5 years, but during that short time have had strange experiences and much trouble with foul brood. This season—usually supposed to be a bad one—two of my stocks have done so extremely well that perhaps a few notes about them may be of interest to your readers.

My hives are in a specially built house about 12 by 10 ft., so that I can do the work under cover, and I have no trouble in keeping the hives cool in summer and warm enough in winter. Last autumn I tried the experiment of treating one of my hives very liberally, and left them a super of shallow-frames full of honey, besides the usual brood box, which was also heavy with honey. I removed the queen excluder. Early in the spring I noticed a great increase of bees—no doubt the queen used both boxes—so I put another super of shallow-frames, with foundation. This was quickly occupied, and I then put on, one after another, no less than five racks of sections, still the bees increased rapidly and were soon filling all 8 boxes. The county expert (Brown, of Launceston) told me he had never seen anything like it, he considered it quite a record. In, I think, the month of June, I examined some of the racks and removed about 40 sections; later on, in August, I took more, and also the upper of the two boxes of shallow-frames.

I took, in all, from this one stock, no less than 119 well-filled sections, and the shallow frames gave enough good light-coloured honey to fill 29 bottles of 16 oz. each. The extracting was my boy's first attempt, and a good deal of honey was left in the combs; however, it was gladly welcomed by a weak stock which soon cleared what was left. I have now left the brood box, 1 box of shallow-frames all heavy with honey, and one rack of partly filled sections for this hive for the coming winter. The bees of this stock seem to be hybrids, as they are light in colour and are unusually well behaved. Then about another stock; when examined in the spring there was foul brood in nearly every comb in the brood box, so I removed the box and floor-

board, put clean box (with frames fitted with foundation), and floorboard in its place, and shook the bees off the old frames into new box. They quickly began work and soon filled their new house, so I gave them a box of shallow frames, and later on a second, all three boxes were filled with honey, and in August, I removed one super with about 30 lb. honey. I left the other super and the brood box untouched, with possibly some 60 to 80 lb. of honey. I have not examined either hive lately, but they have done so remarkably well that I think there can't be any foul brood. Neither of these hives swarmed, and it is perhaps needless to add, neither was fed artificially. If you care to hear of my future experiences with these hives, I shall have much pleasure in writing a few more notes.—W. R. G., *Cornwall, October 17.*

[Will be glad to hear from you again.—EDS.]

### THE PAST HONEY SEASON.

#### AN EAST YORKSHIRE BEE-KEEPER'S REPORT.

[5272.] Having just received my heather bees home from the moors, I may consider the season finished. It has not been a good one, but with careful feeding during the critical months of April and May my bees have done fairly well. I began work with nine stocks, have had five swarms, and by uniting at the close of the season have again reduced my number to nine, as I much prefer a small number of strong hives to a large number of weak ones. I have also fed unsparingly this autumn such stocks as needed it. All are now ready for the winter. I have taken about 180 lb. of honey; not a heavy crop, but things might be worse. One hive sent to Goathland has yielded a stone and a half of heather honey in shallow-frames, in which I find bees work more readily at the moors than in sections. I incline to think there is a good deal of waste of bee life at the moors, as the hives have a way of coming home much less thickly populated than they went. This is probably due to their being caught by storms, as I do not find many dead bees in the hives. To remedy this, I had a stock ready to unite with the heather hive on its return, and being supplied with combs stored with the rich moor honey they should come out well in the spring. On the whole, the season has been one to put the bee-keeper on his mettle. Where he has attended to his bees and used ordinary care, the apiary is in good condition and the store-cupboard comfortably filled. But where we hear of total failure of the honey crop, and even of hives perishing of starvation, we may not uncharitably presume that there has been some want of forethought on the bee-keeper's part, which in such a season as the past one has been is fatal to all hopes of success. Spring and autumn feeding, and systematic uniting of stocks at the close of the honey-flow, are two primary principles of good bee-keeping.

Though I have spoken of the season as closed at the end of September, there is one other crop which should not be forgotten. On the few sunny days of mid-October—"St. Luke's Summer," as they are called—a sudden awakening of the half-dormant hive: takes place; there is heard again the joyous hum of harvest; workers swing into the entrances with pollen-laden thighs. What is the cause of this new zeal? On the wall that shelters my apiary from the north wind, and on the larches which hang over it, the ivy is opening out its mealy yellow bloom. Myriads of tiny flies are dancing round it, and the bees are rejoicing that the spell of lassitude and enforced idleness which has hung over them since the limes went out of bloom has been broken by one more dash of active foraging before they succumb to the winter sleep.—WOLDBEE, *Hull, October 19.*

### THE PAST SEASON.

[5273.] The vast difference between the reports from apiaries as to the honey season this year tempts me to give my personal experience. First, from fourteen hives I took 8 cwt. of honey; about 3 cwt. of which was light clover honey, 4 cwt. medium, and the rest lime and dark honey, but all of good flavour and easily saleable. The highest amount from one hive was 135 lb. Of natural swarms I had a few only—four—but increased my stocks by artificial swarming. At no time did my bees want feeding, either in the spring or during the wet season—and we were well-flooded here—the autumn stores lasting well into the spring. I made a rule of giving each hive 30 lb. of syrup in September with a rapid feeder, whether I have taken any honey or not.

One thing I should like to suggest to our larger bee-keeping friends, and that is, a little more individuality about their honey labels, and not so much of the "stock" thing with "from the apiary of—." I enclose a sample small label of my own, which was designed in black and white and a zinc block made, which saves all typing in printing (electro of which I shall be pleased to send on if you think it worth reproducing). Each year I add to my stocks by buying driven bees, and every year I find that I could do with more honey; in fact, I should have no difficulty in selling three times as much as I ever get; but then I go to special trouble to hand my honey to customers packed in such a way that they can handle it without risk. Each dozen bottles is packed in a light wooden box in corrugated paper, and stencilled on the outside as to its contents, a nicely-printed postcard enclosed with every dozen. Sections I treat in exactly the same way, and I find that the extra trouble pays well in saving time in trying to find fresh customers.—ERNEST OETZMANN, *Slough, Bucks, October 17.*



## Obituary.

### DEATH OF MR. DAVID RAITT.

It was with something of a shock that we received the news of the death of David Raitt, which took place on Thursday last at his residence, Craig Roman, Blairgowrie. We had not even heard of his being unwell. It appears he was laid aside from active work for about five weeks, and had recently undergone two serious operations for some head trouble, in consequence of which he had been in a more or less comatose condition for three or four days before the end came. Mr. Raitt was born at Nairn about thirty-one years ago, and as a child accompanied his father, the late William Raitt—one of the most noteworthy and best known apiarists of his time—when the latter took up his residence at Blairgowrie and devoted himself to apicultural pursuits. The son was following in his parent's footsteps in most respects, having about eight years taken over the bee supply business founded in 1878 at Beecroft by his father, and carried on successfully till his death in 1889.

Our late friend had made considerable additions to the business for a year or two past, and moved into larger premises where he took up the manufacture of poultry appliances, &c. He had just embarked on a new branch of business with good prospects of success, viz., the pulping of fruit and jam making when suddenly laid aside by his fatal illness.

We gather from the local Press that Mr. Raitt was actively identified with various religious and temperance bodies, and was an office-bearer in the Y.M.C.A., and the Sabbath School Teachers' Union.

Bee-keepers will no doubt know him best as an appliance-dealer and contributor to our pages, his last important article on "Comb Foundation" appearing in our monthly, the *Record*, of June last, while his apiary and himself are depicted in "Homes of the Honey Bee" in the B.B.J. of last year. He leaves a widow and three children who will have the sincere and heartfelt sympathy of all readers, along with our own, in their sad bereavement.

The funeral took place at Blairgowrie Cemetery on Saturday, the 10th, and was very largely attended. On Sunday morning a memorial service was held by the local Y.M.C.A.

## Queries and Replies.

[3265.] *Suspected Disease in Bees—A False Alarm.*—I enclose two bees which I think are diseased; they were caught on the alighting board and afterwards killed. The hive is new and clean and the stock was quite healthy and strong last July, when it swarmed, but began to decrease in numbers early in September,

when I noticed one or two bees like enclosed. The diseased bees have a covering of white mealy dust over the back of the thorax, and some are also white on the back of their heads and on their bodies just below their wings. They fly in and out, as do their healthy sisters, but they have a ghost-like appearance, which is easily noticed. If the light-coloured patch is scratched with the point of a pin fine dust-like particles fall off, which, when magnified, appear to be semi-transparent and are lozenge shaped. I shall be glad if you will say:—1. Does this fungus-like covering result from some disease of the system or is it merely an external growth? 2. Is the disease infectious to other bees in the same hive and to neighbouring colonies? 3. Can it be cured, and, if so, how? Thanking you in anticipation for a reply, I enclose card for reference.—*BUMBLE, Boroughbridge, October 17.*

REPLY.—We expect the bees sent had simply been visiting the Canadian or Giant Balsam for pollen and honey, and after their journeys in and out of the pocket-like blooms of that plant they usually return home like dusty millers in appearance. The above reply covers all the queries enumerated, except to say there must be some other cause for decrease in numbers, if serious.

[3266.] *Utilising Queens from Diseased Stocks.*—On examining one of my hives, I found it to be queenless and have been talking to a friend who has a stock of bees badly affected with foul brood, and is going to destroy the bees in consequence. Now, supposing I got the queen and requeened my stock with it which is healthy, would it affect them in any way? I have been looking the *JOURNAL* through but cannot find anything relating to same. You must excuse my troubling you on the matter as this is my first year as a bee-keeper.—*J. H. D., Bardsby, Yorks, Oct. 17.*

REPLY.—On no account should we advise requeening with a queen from a stock such as is described. Besides, when young, healthy queens are advertised in our pages at about 1s. 6d. or 2s. each, it would be folly to use one that would probably be dear at any price.

[3267.] *Late Drones. (Re-queening?)*—Many thanks for answering my query on page 418 last week. I examined both the hives in which I noticed drones on September 23 again to-day (October 17) thoroughly, and in one I found two good patches of sealed worker-brood and larvæ three or four days old; and in the other, a good piece of sealed worker-brood and eggs apparently just laid, and saw on the alighting-board a drone being hunted about by a worker; this makes me believe both stocks have re-queened themselves since September 23, as now (October 17) there are scarcely any drones left in either, although drones were very plentiful on September 23. I therefore ask:—Do not you think that both stocks have hatched a queen since Sep-

tember 23, and that the queens have been mated by the drones specially left alive by the bees for that purpose?—S. S. C., *Cambis*, October 17.

REPLY.—If sealed worker-brood has been seen in the hives as stated, it is quite certain that queens have been reared and mated in both. There is no need to go into the question of dates since the result is all right.

## Bee Show to Come.

October 28 to November 11, at Newcastle-on-Tyne.—Honey Show of the Northumberland and Durham B.K.A. in connection with the Tyneside Grocers' Exhibition, St. George's Drill Hall, Newcastle. Open classes for sections and extracted honey. Members classes for sections, extracted honey and beeswax. Schedules from the Hon. Sec., Jas. Waddell, Wooler, Northumberland. Entries close October 27.

### Notices to Correspondents & Inquirers.

Letters or queries asking for addresses of manufacturers or correspondents, or where appliances can be purchased, or replies giving such information, can only be inserted as advertisements. The space devoted to letters, queries, and replies is meant for the general good of bee-keepers, and not for advertisements. We wish our correspondents to bear in mind that, as it is necessary for us to go to press in advance of the date of issue, queries cannot always be replied to in the issue immediately following the receipt of their communications.

JIM (Ipswich).—*Bees Suffocated in Transit.*—The letter from railway company, dated 13th inst., declining to entertain any claim in connection with the stock of bees destroyed in transit, only confirms the impression we had after reading yours of the 9th. As a matter of fact, you took far more pains than was really necessary to pack the bees well and safely, but the precautions were, unfortunately, in a wrong direction. Had provision been made for proper top-ventilation, and means afforded for expansion of bulk with regard to the bees, all would, no doubt, have gone on well. Three boards "fitting tightly on top of frames," as stated, even if spaced  $\frac{1}{2}$  in. apart, was a fatal error in the packing process. Had the directions in the "Guide Book" been followed, by fixing a frame made of wood  $1\frac{1}{4}$ -in. square above frame-tops, and covering the upper side of the frame with coarse cheese-cloth, or "scrim," the bees would not have been smothered for want of room or the combs melted down by the heat generated by the poor bees before death took place.

F. K. (Winchester).—*Troublesome Bees in House Roof.*—From the particulars given it does not seem feasible to destroy the bees from the outside. The best plan we can think of is to stop up the "very small hole" by which the bees enter the cavity in the roof. If the slates could be removed in order to get at the combs the task would be comparatively easy, but with a place so

difficult to reach as that described the only chance seems closing the entrance.

J. ELOM (Northumberland).—*A Beginner's Queries.*—We cannot possibly undertake to teach bee-keeping through our "Queries and Replies" columns, and your questions cover so much ground that they are best answered by advising the purchase of a copy of the "Guide Book," wherein will be found full instructions for candy-making, wax-extracting, feeding, uniting, &c., all of which are included in queries sent. In a word, all beginners who hope to succeed with bees should provide themselves with the means to that end, and the first requirement is a good text-book.

H. E. W. (King's Heath, Birmingham).—*Bees and the Cinematograph.*—We are obliged for particulars sent; but the same has been on view in London, Dublin, and elsewhere for some time past, and been visited by many bee-keepers. The exhibition will be travelling all over the country for many months to come, no doubt, and will stimulate bee-keeping among many who would otherwise never have heard of it.

AMATEUR (Stratford-on-Avon).—*Candy-making.*—Your sample is quite usable while fresh made; but we fear it will soon become hard if the bees do not take it down quickly. The grain is not smooth enough for a really good candy; it should be smooth and buttery, like the fondant sugars used in "chocolate creams." It is also, we think, made from yellow sugar, not from white crystals or from crushed lump, either of which is better than yellow crystals for bee-candy.

H. W. S. (Henley-on-Thames).—*Exhibits at Shows.*—Our comment was not intended to imply that you had shown in every class, but merely that twelve classes were available to exhibitors.

\* \* ERRATUM.—In the Rev. H. Newman's letter (5263, page 417) last week the "total receipts" given in first paragraph should have been £6 7s. 8d., not £2 7s. 8d. as printed.

### Honey Samples.

THETA (Selby).—The light-coloured sample might do for show-bench in local class, but would stand no chance in open class. The flavour is fair only, though consistency and colour are pretty good. Dark sample (No. 2) is not suitable for a tradesman's counter as honey for table use.

\* \* The large amount of space taken up with "Conference" Report compels us to again hold over several interesting items of correspondence already in type, among others, articles on "My Two Years' Experiences," and "Are You Ready for Winter?" together with some Queries, all of which will appear next week.

## Editorial, Notices, &c.

### BRITISH BEE-KEEPERS' ASSOCIATION

The monthly meeting of the Council was held on Wednesday, October 21, at 105, Jermyn-street, Mr. T. W. Cowan occupying the chair. There were also present Col. Walker, Dr. Elliot, Messrs. D. W. Bishop-Ackerman, W. Broughton Carr, J. B. Lamb, E. D. Till, E. Walker, T. I. Weston, T. H. E. Watts-Silvester, and the Secretary. Letters regretting inability to attend were received from Mr. W. H. Harris, Mr. H. G. Morris and Mr. W. F. Reid.

The minutes of the previous meeting were read and confirmed.

The new members were elected, viz., Mr. Frank Bate, Beechwood, Knutsford, Cheshire. Mr. A. Macindoe, High Bank, Sidmouth, Devon.

The Finance Committee reported through Mr. Weston that they had examined the Secretary's receipts and payments to date, and suggested that cheques be drawn in settlement of a number of accounts due. The report was approved.

The Examiners' report upon Examinations for Third Class Expert Certificates held at Chelmsford on September 12 and 26 was received, and as a result it was decided to grant passes to Major Montagu, Messrs. A. Gayford, W. H. Hales, J. Harris, J. Kitson, W. Turner and S. Wright.

Necessary arrangements were completed for the Second Class Examination to be held in various districts on November 13 and 14, for which a number of intending candidates have already sent in their names.

A large batch of letters was dealt with by the Council, and the Secretary instructed in regard to replies.

The next meeting of the Council was fixed for November 18.

### CONVERSAZIONE.

(Report continued from page 424.)

After a short interval, during which light refreshments were served, the company re-assembled in conversazione, when Lieut.-Col. Walker was voted to the chair by acclamation. He commenced the proceedings by asking the secretary to read the letter addressed to the latter by the secretary of the Cumberland Bee-keepers' Association, as follows:—

"DEAR SIR,—Not being able to attend the Conference to-morrow will you kindly bring this letter before the B.B.K.A. Council.

"I would suggest that examiners for expert certificates be appointed at various centres all over England, and thus save considerable expense to counties distant from London, and lessen the feeling which is growing, that the B.B.K.A. would be better named the London

B.K.A. Surely any bee-keeper who has passed his second or third exam. should be capable of taking these examinations. Such an alteration would tend to make more bee-keepers go up for examination, and thus indirectly help bee-keeping generally.

"I have had some correspondence with the Irish Bee-keepers' Association, and they are making great efforts to get a Foul Brood Act passed this Session. The Irish Board of Agriculture is moving in the matter, and they seem to have considerable hopes of getting an Act passed. Will you kindly inform me if the B.B.K.A. are joining in this?

"I do not think that simply because it has been attempted before and failed there is any reason for not trying again; but just the reverse, I believe more in a policy of 'We won't be happy till we get it.' And that is how the Irish have got so many concessions and advantages to their bee-keepers, which we in England have not, from the Government and County Councils.—Yours faithfully,  
GEORGE M. SAUNDERS, *Hon. Sec. and Treasurer, Cumberland B.K.A.*"

Mr. Cribb said there was certainly a feeling growing up that the B.B.K.A. would be better named the London Bee-keepers' Association. He found in bound volume of reports for 1901 that a letter had been sent to the parent body from the Somersetshire branch complaining of the scant courtesy received; and he had personally had his attention called to the fact that the British did very little for county associations. He, therefore, presumed to bring the matter before that meeting to see if something more could not be done. In counting up the number of members of the B.B.K.A. he found that, exclusive of life members, it was 271. That included 28 affiliated associations, besides which there were 18 life members in the country. The country members numbered 139, and the others, i.e., those from the home counties and Middlesex, amounted to 104, or less than half of the association's supporters. If he turned to the names on the Council list it appeared that only two members out of about 12 represented the counties. But if we looked at the subscription it would be seen that out of £97 4s. 6d. the affiliated associations provided £35 14s.; thus, £61 10s. 6d. only was subscribed by other members, both town and country.

On the first page of the report where associations were referred to, there was a note to the effect that hon. secretaries were honorary members of the parent body, and entitled to all its privileges except that of voting, so that they were excluded from any really active part in its management. By its constitution the association was national, but its council seemed to be all drawn from the home counties. Being originally a Londoner himself, he knew that his fellow-citizens were apt to regard London as the hub of the universe

and the provinces nowhere. Then with regard to medals. In the provinces—certainly in his own county of Lincolnshire—the members did not care about the medals issued, which they considered to be old-fashioned. Instead of these there might be handsome-looking medals of some up-to-date design, of various shapes, and with the names of recipients engraved thereon. Such a medal could be worn on the watch chain, and need not be large or gaudy.

There was also the question of experts. He thought these should form a useful army to the "British," but so far as he could learn when once the central body had examined an expert they let him go, and lost touch with him altogether. It was proposed some ten years ago that the B.B.K.A. should issue a set of instructions to experts, more particularly with reference to foul brood, but that had not been done. That army of experts if properly managed should form recruiting officers for the central association. And further, he would ask, what measures did the latter take to be represented in the counties? The "Cyclists' Touring Club" had "Vice-consuls" in all parts of the kingdom, who kept themselves always before the public. He was often asked the question:—"What advantage do I get from the British?" All he could say was that occasionally he received a circular on Saturday or Sunday to say that a meeting would be held on the following Wednesday. He also saw in the report that a "board of examiners" was referred to, and he sometimes wondered whether all the members of this board had been examined themselves? Had they secured their first-class certificate? Another point was—the B.B.K.A. had started an apiary at Swanley, and had a very good man there as expert, but the latter held only a second-class certificate. Would it not be an act of grace and justice to award that man a first-class certificate? Or did the laws of the Medes and Persians render it compulsory that he must write a lot of "stuff" which they were well aware that he knew thoroughly? He thought the examination paper for the third-class certificate should also be revised. Finally, he hoped the B.B.K.A. would find a means of coming into closer touch with the counties, some of which felt they had no part or lot in the central society, except that of paying their affiliation fee.

Mr. J. B. Lamb (Middlesex) repeated his view expressed at the Conference, that all members of County Associations should be advised of important shows in prospect. No doubt, members read the B.B.J., but they did not have time to examine every schedule, whilst if the local secretaries could be furnished with notices specially supplying such information, those gentlemen would, he believed, willingly send them out to their members at the expense of their local societies. He thought the parent society should have honorary local secretaries throughout Great Britain. He was himself secretary of a society with 5,000 members.

They had 300 or 400 representatives all over the Kingdom, who collected the contributions locally, and remitted to him in bulk at head quarters. He had certainly received a notice of the present meeting, but he thought it would be better if all meetings could be arranged at the beginning of each year, so that dates would be known a long time in advance, which was a consideration to busy men.

Mr. Scattergood thought Mr. Cribb was a bit at fault in his statements. He had misread or misquoted the number of country representatives on the council, by mentioning only his (Mr. Scattergood's) and Mr. C. N. White's names. There were more than that, nor was there the smallest objection he thought to any reasonable number, but natural impediments could not be surmounted. The B.B.K.A. should surely not be blamed for the misfortune that the Northern and Midland Counties were a long way off. If any representative of these associations could afford the time to come up to London and pay his own expenses to attend the meetings, he was sure the Council would give him a cordial welcome, just as they always did to him (the speaker). Not being a Londoner nor even a Home Counties man, he thought that fact answered Mr. Cribb's argument on the point. With regard to the medals being old-fashioned, Mr. Cribb could have found, upon inquiry, that the county associations had the choice of more than one kind of medal, including even some of the kind he appreciated. Then the subject of experts he thought—and he did not say it because of happening to hold a first-class certificate himself—that it would be inadvisable to make the certificates too cheap. He could only say, if he had not been compelled to work and study very hard for his certificate, he would not prize it as he now did. If a first-rate man did not possess the highest certificate, it was because he did not take the trouble to prepare himself for examination. So far as the reference made to Mr. Herrod and his first-class certificate, if he presented himself, he would, no doubt, be treated just the same as any one else. Then, as to "fixing centres," and allowing third-class experts to examine candidates, he thought that would be a great mistake. To place certificates practically at the disposal of men who did not know fully what they had to teach would be a danger, especially in view of the request made by their Cumberland friends, who were anxious that legislation against foul brood should be attempted. As to making a reduction in the membership qualification to branch subscribers, as had been suggested, he thought the present fee (5s.) was small enough. Surely the educational advantages alone were worth the subscription.

Mr. Weston thought the complaint about Mr. Herrod having no first-class certificate ought to stop. The matter had been thoroughly talked over in Council, and he considered the latter would not be worth its

salt if it gave a certificate to any one without an examination being passed. As a matter of fact Mr. Herrod, he believed, intended to present himself at the last examination for the first-class, but pressure of engagements at the time prevented him from coming to London to undergo that trial. The Council was perfectly satisfied with him, and doubted not that in due course he would undertake the examination. The delay was, therefore, neither the fault of Mr. Herrod nor of the Council.

Mr. Cribb explained that he did not know this matter had been threshed out at Council meetings. He could not be expected to know that, as the proceedings of that body were private.

The Rev. W. E. Burkitt, in referring to the remark made that county associations were not in sufficient touch with the B.B.K.A., said that if the local people would pay their representatives' expenses to attend the quarterly meetings, all cause of trouble would be removed. They did so for him in Wilts. His association had suggested that he should give up attending, but he promptly replied that if they refused to pay his expenses he would cease to have anything more to do with the association.

Mr. Cowan said it had been stated that the county associations were not adequately represented on the Council of the parent body, because of there being only two provincial members thereon, the others emanating from London and its neighbourhood. He thought Mr. Cribb must have drawn his information from an old report, because the fact was that this year there were several counties represented on the Council. Colonel Walker (Devon) was one, Mr. Morrell, M.P. for Mid-Oxfordshire, and Mr. Puck (Essex) were others, besides those Mr. Cribb had quoted. Some years ago that question was gone into, and an effort made to distribute the representation over the whole country. Gentlemen were elected from distant parts of the kingdom, and the result was that they were unable to, or did not, attend; and, in fact, in some cases, never appeared at a single meeting. Thus, the accumulating work that the Association had to do was left to a few who were able to be present at meetings. Could it be wondered at, then, that the Council felt that the plan, though excellent in theory, was a failure in practice? After that it was decided to elect only those who were able and willing to attend and could afford to pay their own expenses. It was obviously impossible to carry on the work of the Association unless there were sufficient members at meetings to form a quorum. The Council was divided into several committees, and each of those took its share of the work to be done. It was also beyond question that London was the central place from which all the work of the B.B.K.A. ought to be carried out. It would, no doubt, be quite a different matter if the county asso-

ciations paid their representatives' expenses, but, so far, he had heard no suggestion of that kind, except in the case of Wilts. The central association was, unfortunately, not in a position to bear such cost; but, if the country branches could suggest a way out of the difficulty, the Council would be only too pleased to consider it. Referring to the question of medals, he (Mr. Cowan) showed that Mr. Cribb's idea had already been anticipated, for the Council had been dealing with the matter for some time past, and on the table before them were samples of small, attractive medals which the county associations might have if they did not prefer the larger ones. With regard to revising the papers for the third-class examination, he might say that matter had already been discussed by the Council and was being attended to. Mr. Cribb had also referred to the "Board of Examiners," and asked if the members of this Board "had been examined themselves and held certificates"? In reply to this he would merely say that, in a work of the kind they were engaged in, there must always be a beginning. Before certificates could be granted, there must be persons to grant them; and the gentlemen—the original Board of Examiners appointed—were chosen (there being obviously no other way to do it) as being those who were supposed to know the most about examinations, viz.—Messrs. Raynor, Bartrum, W. H. Harris, and himself. There could be no question of holding certificates at the time, because no such thing existed. The gentlemen chosen took upon themselves to write papers and examine candidates; and, until now, the competency of the examiners first appointed had never been questioned. Since that time, the Council had always selected those whom they deemed most fitted to act as examiners, and never asked for, and did not require them to hold, certificates, and he challenged the impeachment of that system. They neither sold nor gave away certificates, which were only granted to those who asked for them and were able to pass the necessary examinations. As to their expert (Mr. Herrod), they knew he was quite capable of passing the examiner, and they were quite satisfied with him as a lecturer and demonstrator. They did not insist on his having a certificate, but if Mr. Herrod preferred to have one, it was needful, and by far the best, for him to go through "the mill" the same as other people. Concerning secretaries of county associations receiving notice of important shows, he could only say that all county secretaries had the schedules of the "Royal" sent them, but he believed very few of them circulated such information among their members, some of them evincing no interest whatever in any but their own county show. If members could induce their secretaries to make important shows known, it would be an excellent step. With regard to appointing representatives of the parent body in different

districts, the B.B.K.A. never liked to interfere with county branches, and if they were to appoint agents, as had been suggested, the local people might justly say that the B.B.K.A. was clashing with and interfering in their work. He thought that friends of the cause from all parts of the country ought to join in subscribing to the parent association; but, as to sending out representatives to recruit members and get subscribers, he felt that would be an undoubted interference with the privileges of the county associations. The B.B.K.A. had always encouraged the formation of branches, and had left these to work the counties in their own way. The only other point he need reply to was dates of meetings. These were held monthly on dates fixed at the beginning of each year, and the announcement of the next meeting was reported at the conclusion of each monthly report in the BRITISH BEE JOURNAL as published.

Mr. Till expressed his pleasure at seeing so many country members, and especially Mr. Cribb. Criticism was an excellent tonic, but if that gentleman had been able to come amongst them oftener, he felt sure that he would be more than satisfied at the amount of work undertaken and accomplished by the council and committees. He (Mr. Till) was rather ashamed of himself for his comparative slackness as measured against men like Mr. Reid, Colonel Walker, Mr. Weston, and Mr. Carr, all of whose labours were untiring. He (the speaker) wished there were critics in every county. The apathy of some members was a great mischief, but Mr. Cribb was certainly not open to such a charge, and although that gentleman's strictures were not always well founded, still he (the speaker) welcomed the energy and criticism of any one whose sole aim was the welfare of their industry.

Mr. Weston said that in his capacity as Vice-Chairman of the Council he had often urged the importance of increasing the membership of the B.B.K.A.; but this was very difficult to do without in some way trespassing on the preserves of the County Associations, which the central body did all in their power to support, although the latter received almost no help whatever in exchange except the affiliation fee of a guinea per annum. The Council gladly welcomed delegates from outside to their meetings, and were always anxious to know their experiences with County Councils, who were now the authorised educational bodies, and as such were constantly taking up work which otherwise had been done by the County B.K.A.'s. Mr. Cribb had stated that the Central Association examined and gave certificates to experts, who were afterwards cast aside. That was not so; the candidates came to them, and, after getting what they wanted, went away. Personally, he (Mr. Weston) would like the B.B.K.A. to keep in touch with every expert in the kingdom, and if some one could show how that was practicable the

Council would be very pleased. Referring to the matter of insurance for bee-keepers, which he had personally done something to promote, he could not refrain from asking what help he had the counties given to make the project a success? It was anticipated that secretaries would give their members all the advantages they could, and gladly distribute their proposal forms, but the mere halfpenny stamp for postage seemed to be the difficulty. It appeared to him that they would like to throw on to other shoulders the cost of postages as well as the trouble of writing the envelopes. He (Mr. Weston) had done it himself this year, but was not likely to repeat the performance. And yet, just look at the advantage given to the bee-keeper? Why, for the trifling cost of one penny per hive a man could be insured up to £30 against any damage his bees had done to strangers and their property. And, notwithstanding this advantage to the whole bee-industry, any help rendered had been done grudgingly! He thought, therefore, that Mr. Cribb's picture had a very palpable reverse side to it, and that, if the parent association did not find itself completely in touch with its children, it was not entirely the fault of the parent. Cumberland, for instance, was a long way off, and its representatives could not often come here, nor could the members of the Council go to Cumberland. It might be possible perhaps to establish a centre for examinations as far north as Manchester, which would probably be acceptable to the northern branches. On the other hand, if, and in order to increase the membership of the B.B.K.A., County Associations would look down their subscription lists and see who would be likely to join the Central Association for a 5s. subscription, and try to promote that result, he thought they would have no cause to regret it.

The Rev. Mr. Burkitt said he had enclosed a copy of the insurance scheme in every copy of the annual report sent to members of the Wilts B.K.A., and he also took care that every new recruit to the Wilts Association should have one. About 36 of their members had taken advantage of the scheme.

*(Conclusion of report next week.)*

## Correspondence.

*The Editors do not hold themselves responsible for the opinions expressed by correspondents. No notice will be taken of anonymous communications, and correspondents are requested to write on one side of the paper only and give their real names and addresses, not necessarily for publication, but as a guarantee of good faith. Illustrations should be drawn on separate pieces of paper. We do not undertake to return rejected communications.*

### ARE YOU READY FOR THE WINTER?

A WORD OF ADVICE.

[5274] "Winter? Winter? Ready for the winter? Yes, I suppose so." Friend, the very form of your answer betrays your unpre-

paredness. The summer has gone ; autumn is going ; and you are unready to face the rigour of what may at any time prove to be that much-talked-of apparition, "the hardest winter for fifty years."

"Wolf! Wolf!" you say. Yes, I know, but the frost-wolf may come—must eventually do so—and his icicle fangs are very long and very sharp. Are you ready and prepared to meet him?

It may be late to urge this matter ; it is late, *very* late ; but the fact remains that now, when it is late, and in the spring, when it is *too* late, is the time to force the matter to its logical conclusion, to rub in, as it were, the lesson that procrastination in bee-keeping does not pay!

Are you ready for winter? If not, why not? Winter is hard upon the beels of our apology for a summer ; and spring, the time of the revival of your interest in the bees, is following hard after. If you are well prepared for the winter, you may contemplate undismayed the dangers of the spring ; but that the harvest of the coming year depends largely upon the work of the present, is a fact which cannot be too often impressed upon the beginner in bee-keeping. It may be that he has heard it before, but it can do no harm to remind him, for although maxims—excellent maxims—are embodied in the text-books, they are sometimes, so far as their usefulness is concerned, allowed to be embalmed and buried there by those for whose guidance they were intended.

Don't forget them, friend. They are mostly the result of years of experience by the older hands, and the argumentative burden of many of them is this : Honey depends upon strong colonies at the *right* time, generally implying in *good* time ; and *early* strong colonies depend upon their owners' management, particularly of the preceding year. As he sows, so shall he also reap.

You remember that winter you lost so many colonies—or was it "only a few?" How you had looked forward to the return of the sunshine and the activity of the bees. You remember also your disappointment as you inspected hive after hive of the dead in your little cemetery, and the after trouble you had with the spoiled combs. Those combs which had escaped the fungus growth were packed, you remember, with dead bees, fifty to the cubic inch! You tried to extract the poor corpses with a pin, with two pins, with a variety of strange weapons ; and you finally gave the combs disinterestedly to the bees, only to find that they made about as good a job of the disinterment as you yourself. Then you bought some more foundation, which was, no doubt, "good business" for some one, but not for you, nor for the poor bees, whose business you had silenced for ever. Of the two deaths, the brimstone-pit were the most merciful. But you say you have enough, or too many, bees ; or you are losing your interest in them ;

"it is too much trouble to bother with the bees now ; they must do the best they can."

My good friend, if this be true, do, for the sake of the bees—your own and your neighbours—for the sake, even, of your own peace of mind, do give them up. Sell out! or give them away ; anything but continue what has ceased to be an absorbing pleasure to you. If you do not incline to part with them altogether, reduce their number until you can with comfort, in the small amount of leisure you are still able to devote to them, look after them well. Well, or not at all! *Are you ready for the winter?*

No apology is needed, I am convinced, for thus urging this matter in the strongest way, even *ad nauseam*. One need only scan the unanimous warning of several of the old hands—of whom the Editor is not the least—in this month's *Record*, to realise that they are fully aware of the importance of the subject ; and their wise words deserve to be, as friend "D. M. M." has it, "dinned" into the ears of those of us who have not yet attained years of discretion—who are, perhaps, apt to go to the extreme of self-confidence born of past success, and to imagine that, in our hands, at least, all will be well, even if we do not adhere too strictly to the rulings of our teachers. As a beginner who has made many mistakes, may I urge upon you, friend, that it is a mistake to ignore the teaching of the old hands in this matter? Experiment if you will, "otherhow," but prepare your stocks for winter as for a siege against the enemy already silently stealing to the gates.

*Are you ready for the winter?* If you are not, may I urge gently upon you that you complete this work without delay ; treat it as the most important matter in hand, and see to the comfort of your little labourers before that of your own. I know of one man who last winter lost all but three stocks out of thirty, and I could give many instances of complete loss through failure to prepare stocks for the period of rest. Briefly, in what does preparedness for the winter consist? Abundance of wholesome sealed stores ; sound hives, well packed up ; and, very importantly, strong colonies.

Strong colonies—that is the text-peg upon which most of the apicultural sermons are hung. Well, if you desire to strengthen your colonies for a honey-flow, you unite them. So, if you wish to strengthen for winter, you must apply the same practical measure. *Unite*, that is the watchword. "Do not cling to those miserable remnants of colonies," says one writer of experience. Pack a couple of them in the same hive for mutual protection. The bees will winter better together, and come out stronger in the spring. All you lose is one queen ; and that is not correctly a loss, as one queen favourably situated will rear more early brood than two not so well circumstanced. If you must save the queens, a trifling ingenuity on your part will pack the two small colonies

in one hive with a thin partition, and remote entrances. Is it necessary to add that, should you feel inclined to treat any neglected colonies in this way, do not put off the operation for a day; seize the first favourable moment, and do not procrastinate the work on account of its difficulty? "Funk" is the word which expresses this most nearly.

It is not, we are too well aware, so pleasant to handle bees late in the year; but if the work is done fairly late in the afternoon, and done expeditiously, there need be no trouble from robbers, nor any loss of bees.

First, remove the worse queen and all unnecessary combs, expose the bees to the light by separating the combs, and alternate these in one of the hives.

It is, of course, late to feed—I can never understand why "autumn feeding" should not be done in the summer; but the best-filled combs of the two colonies can be given to the united lots, with advantage to both, not least of which is a probable economy of consumption.

As to packing, crowd the bees to the number of combs they can well cover; do not be afraid they will be too cramped it is unlikely; fortify the sides of the dummies with warm material, if possible, and don't forget the top covering—that is the weak spot. Pack close, and always put on more than you think necessary! Don't forget the winter passage, and a good big cake of perfectly made candy, if you are at all short of stores.

May I urge upon you once more the necessity for promptitude in this matter, asking you once again that tiresome question,

*Are you ready for the winter?*

L. S. CRAWSHAW, *Ikley.*

#### BEE-KEEPING AND SCHOOLMASTERS.

[5275.] Will you kindly allow me also to add my strongest protest against the remarks of Messrs. Scattergood and Cribb at the late Conference of Bee-keepers held in London?

I am much more inclined to believe—especially after the bad taste displayed in their unjust criticism—that the fault is their own, and their experience with teachers is only what they deserved.

It is, to my mind, as absurd to judge the character of 60,000 teachers by the experience with a few of them, as to judge the character of a hive of 60,000 bees, after being stung by one or two, as in both cases a great deal depends on the "handling." I must conclude that the above gentlemen are not experts in handling schoolmasters, and hence the result.

I assure Mr. Scattergood that, although a second-class expert of the B.B.K.A., I do not claim to know "everything," or anywhere near it, on the subject of apiculture, but am still adding to that knowledge. As to "jealousy" when a stranger is called in, I can tell him that no one is so sure of a hearty welcome amongst us schoolmasters in this

county than our esteemed county lecturer, Professor Pickard, F.R.H.S.; and this feeling is, I believe, reciprocated; but perhaps this is because he has other inborn qualifications, besides those of a lecturer on country pursuits.

Again, with reference to the foulness of the apiary of a schoolmaster whom Mr. Cribb knew, he should remember that "one swallow does not make a summer," and also that there may be another side to the question. If he would mention the name of the schoolmaster referred to, that we may know to whom his remarks apply, it might enable us to give the delinquent a little fraternal advice.

In conclusion, I must say that I experienced a feeling of regret that this public accusation was not taken up by some one present, and was sorry I did not accept the invitation to attend. Where was our respected Junior Editor, Mr. Carr, who, from his ripe experience as an examiner, must have met many a country schoolmaster? Are we to consider his silence as signifying consent to our impeachment? I trust not. Whatever Messrs. Scattergood and Cribb may say, I am certain that the busy bee has no greater friend and admirer than the village schoolmaster.—H. SAMWAYS, *Maesy-bont, Llandebie, Carmarthen.*

[Whatever schoolmasters the speakers referred to may have had experience of, it is safe to say they were not of the type of our correspondent, seeing that both gentlemen had probably read the account of Mr. Samways' bee-work and seen his fine apiary depicted in our "Homes of the Honey Bee" last year,

So far as our personal opinion on the value of schoolmasters as useful and valuable promoters of the bee-industry, it has repeatedly been given in these pages, and we thought them quite able to uphold their own cause in print, as they seem fully competent to do.—W. B. C.]

#### BEE-KEEPING IN SCHOOLS.

INTERESTING THE CHILDREN.

[5276.] After reading through the account in B.B.J. of last week's meeting of the British Bee-keepers' Association, I thought your readers might be interested in our little effort. Bulwell is an outlying suburb of Nottingham, and although within the city boundary, is as it were a town in the country.

Taking advantage of this fact, and in view of the Board of Education's scheme of object lessons, Mr. Barker, the headmaster of the Coventry-road Council School, has arranged a list of object lessons, suitable for the neighbourhood. Among these are three lessons on bees, and as the "bee-man" it fell to my lot to give the instruction in question. The lessons are given on Wednesday mornings to over 100 boys in standards five, six, and seven, and the following Wednesday each boy writes an essay on the previous week's lesson. The first was entitled, "Hive Bees—Their Natural History." A fortnight later



we took "Hive Bees—Their Work in Nature," and last week we had "Hive Bees—Commercial Production." The boys have been keenly interested in these lessons, and the promise of a small jar of honey for the best essay on the last lesson, has spurred them on to great exertions.—W. DARRINGTON, *Bulwell, Notts, October 20.*

#### THE SEASON IN NORTH BUCKS.

[5277.] It is very rare to see a report from North Bucks in the B.J., so I venture to send one.

According to some of the reports in your pages, the season has been a most disappointing one for a good many. For myself, it has been above the average. From fourteen stocks I have taken 674 lb. of honey (the quality extra good) and 9 lb. of wax. Many of the failures are due, I fear, to want of care in the spring, for several bee-keepers round here have lost their stocks—some of them all they had—merely for want of a little feeding in May and June. I make a practice myself to go round mine once a week after April sets in, just to see how they are progressing, and feed where required. This I continue to do until the supers are put on. It takes very little time, there being no need to lift the frames out when examining—just a puff with the smoker; you can then see at once.

In addition to the above, I also gave some sealed frames to a late stray swarm, and some driven bees have been treated in the same way, so that all my stocks are well provided for the winter without any feeding. Although I secured more honey than usual, the whole of it has been sold out a long time, and I have been obliged to refuse several orders. On all my sections and honey jars I use my own private label. It may cost a trifle more, but it pays to do so. (I have enclosed one for you to see.) I have had repeated orders from shops when they have had other people's honey on hand; they have told me that mine sells the best. Hoping that 1904 may be a good year all round.—C. ADAMS, *Olney, Bucks, October 24.*

#### "NOT PASSIVE RESISTERS."

[5278.] The following may be of interest to readers of the BEE JOURNAL. When at Chard Junction Station last week I was shown a curious bees' nest that had been destroyed during the severe gale which occurred on the night of September 10 last. The nest was situated in the hollow trunk of a very old ash tree, growing about a hundred yards south of Chard Junction Station, in Somerset. The old tree, which overhangs the River Axe, was torn in halves, and many of the bees as well as a lot of honey fell into the water. Nevertheless, about 25 lb. of honey was secured by the farm labourers and others.

The bees in question, or their progenitors,

were known to have occupied this tree for more than twenty-five years, and on one occasion proved very active resistors when some boys attempted to dislodge them. I should have liked to send you a photograph of the tree, but it was in an awkward position.—JOHN B. MANN, *District Engineer's Office, Exeter Station, October 22.*

#### THE PAST HONEY SEASON.

##### BUYING AND SELLING HONEY WHOLESALE.

[5279.] Seeing that most reports respecting the honey season are so very poor, I thought you would be interested to know that I have had a very good year—in fact, next to the best during my eight years' experience. My average for seventeen stocks was 62 lb. per hive first-class honey. The three best hives yielded respectively 110 lb., 100 lb., and 92 lb. of surplus, and the three lowest 22 lb., 25 lb., and 27 lb. These latter, however, sent off prime swarms, all of which decamped. No less than six of my hives have performed this very annoying trick during the past summer, and I need hardly say that, but for these mishaps, I should have realised considerably more surplus honey. In my bee-driving excursions for 1903 I have found skeps vary in weight very considerably, though on the whole they were heavier, and certainly stronger in bees, than for several seasons. It seems to me that the bees being kept indoors so much through bad weather, they bred faster, and the working "death-rate" was not so high in consequence, so that where there were a few fields of good bee-forage close by the hives, the bees so situated were able to make good use of the little sunshine we had. On the other hand, apiaries with no honey-producing plants near the bees were very much handicapped. I can account for the great difference of the yield in no other way, the total area where good and bad returns are reported being comprised in a few miles. There are not many bee-keepers about here who work the frame-hive. I went to see one last week who has kept bees nearly thirty years, and he declared this has been the poorest honey season he has experienced for several years, yet he lives only two miles from me. Another, whose hives are located about the same distance from me in another direction, and who keeps, I think, more stocks than myself, says he has not taken a hundredweight of honey from the lot. A third bee-man, situated half a mile further away, has had a very poor season. It is, therefore, a bit remarkable that I have done so well. The worst year I have so far experienced was 1902, when my average only reached 30 lb. I never consider a season satisfactory that yields a less average than 50 lb. per hive. One year I came out with 100 lb.

*Buying and Selling Honey.*—If not occupying too much of your valuable space, I would like to say a word on the price of honey from

the buyer's point of view. I have been a pretty large buyer for the past seven years, and several lots advertised in the B.B.J. have found their way into my honey-room. I am situated in one of the best districts in the country for selling honey, being within easy distance of three fashionable watering-places, and the price I get from shop-keepers is from 8s. 6d. to 9s. per dozen for both 1-lb. sections and jars. I think all who know anything about honey-selling will agree that this is a very fair wholesale price. Anyway, it is as high as is paid to any seller in the district, and a great deal is bought at a cheaper rate. Now, I want to ask this question: How much should I pay for honey in bulk to sell at above prices? I make this inquiry because it seems to me that the price obtainable by the man who jars up and sells to shops should be a ruling factor in the price of honey in bulk. If the shop-keeper buys in bulk and jars up himself, he *could*, of course, afford to give more than I can, although in the towns mentioned above there are only four tradesmen who do that sort of thing, but they can buy in the same market as myself, and equally as cheap. Very few tradesmen, however, will undergo the mess and trouble of handling and jarring honey, and the few who do it need the extra profit to pay for their trouble. I observe that bee-keepers are often advised not to sell their honey in bulk so low as 6s. per lb. Now, were it not for the fact that I hope and intend some day to become a honey producer on a much larger scale than at present (I belong to the struggling ones, and cannot afford the cost of the necessary stock), I would rather sell my honey every year in one lot at 6d. per lb. than I would sell to shops as I do at 9d. But, as stated above, I intend to get my living entirely from the bees, and so, in view of the future, I must buy to keep my present customers well supplied, and for that reason it is worth my while to act as I now do. As regards the profit made from buying to sell again to tradesmen the game is not worth the candle, as I will endeavour to show in the following figures.—Say I buy 1 gross lb. of honey from the Midlands for £3 12s.; the carriage home costs another 5s. (probably more). I put up one-half into 1-lb. jars, and remainder into  $\frac{1}{2}$ -lb. (these  $\frac{1}{2}$ -lb. jars have now become quite a feature of the trade); a gross of  $\frac{1}{2}$ -lb. jars costs 17s. 6d. delivered, and  $\frac{1}{2}$  gross 1-lb. jars costs 10s. Then labels, packing, and carriage again into town, 4s. This makes a total of £5 8s. 6d. I have put down nothing for personal expenses attendant upon getting about to sell, or discounts which shop-keepers must have if an order of any size is given; but when I take £5 8s. for 12 dozen of honey which have cost me £5 8s. 6d. in hard cash, where does my profit come in? and where the greater part is wanted in  $\frac{1}{2}$ -lb. jars the loss is considerable. I therefore say that 6d. per lb. for honey in bulk is beyond the market value, and I cannot understand bee-

keepers telling me that they cannot sell honey in bulk under 6 $\frac{1}{2}$ d. per lb.; and yet the same bee-keepers have been advertising honey in 1-lb. screw-cap jars at 7s. 6d. per dozen! I do not wish readers to understand from the foregoing that I give 6l. or more per lb. for what I buy. I have written this according to what most bee-keepers "stick up" for. I have bought honey of first-rate quality (none other is of any use to me) for several years at from 45s. to 50s. per cwt., and now and then a small lot at 6l. per lb., carriage paid. I send name for reference, and sign myself—  
SUSSEX B., *October 22.*

#### BEE-KEEPERS AND INSURANCE.

[5280.] Mr. Woodley (on page 416 of B.B.J. for October 15) writes about the insurance scheme, and asks for the number of hives and apiaries insured. I can only speak about our own county of Lincs, and I must say that I am very disappointed that so few members of our association have availed themselves of this excellent scheme. I am sure all bee-keepers should be extremely grateful to the British B.K.A. for extending such a great benefit to our craft, and I hope as the scheme gets better known and the benefits derived therefrom, more bee-keepers will take out policies. The number of hives insured through me by our members is 699, in fifty-seven apiaries; this is an increase over last year, but I expected that quite 100 of our members would have insured. Mr. Woodley thinks that experts might help in the cause; no doubt this would be useful, but a local secretary that has the cause at heart can do far better than an expert. In one of our large districts the whole of the members insure; while in another district, with over forty members, there is not one that has taken out a policy; this is the difference between the two officials, both being excellent ones for our craft.—R. GODSON, Hon. Secretary, Lincs B.K.A., *Yothill, Alford.*

#### Queries and Replies.

[3268] "*W.B.C.*" *Hives.*—Would you please give me your advice on the following, which may be of interest to some of your readers also:—I have some "*W.B.C.*" hives, which are well packed and stored for winter, full of bees, and headed with queens of this year, which point me to swarms, if all goes well; but I have not got hives for increase, nor do I want any more lumber at present, owing to lack of room and weight when transporting. I therefore ask you the following question:—If I took off the outer wall, or case, of brood-nest, and fitted boards in the front and back of it to make it the proper size for standard-frames, the boards would be made to run in grooves, so that they could be put in whe-

required. Then on the event of an unexpected swarm, I would put in the boards as above, and transfer the frames and bees from the original nest into it and turn it round facing the other way (call this A); then fill the brood-box with foundation or comb, with one frame of brood, and set it under A, facing the usual way, to receive all flying bees (call this B); then shake the swarm into B and allow it to remain there until it can be seen if A will swarm again; if it does, return same, cutting out all queen-cells; then take the old queen from B and unite it to A by setting it above, giving the young queen full run of both. Then at the end of the season I would put them in the brood-box again as they are now, putting the boards between outer and inner box, or on top of nest, to keep them warm for the winter. Do you think that it would act? I have not mentioned the supers, as all will understand that they ought to be kept on top of parent hive, and on the top of all after uniting.—H. P., *Brompton, October 19.*

REPLY.—By turning the combs and bees of parent hive (A) "round facing the other way" as proposed, and leaving it in that position for a fortnight, you will almost certainly prevent the issue of further swarms for that year. In other respects your plan will no doubt work out all right.

[3269] *Starting Cottages with Frame-hives.*—Will you please send me two copies of "Modern Bee-keeping: A Hand-book for Cottagers"? There is a labourer living near me who has eight stocks of bees in skeps, and who would like to start frame-hives; but as his earnings are about 18s. a week, and he has a family, it is absurd to advise him to buy hives, &c. Could you give me any advice as to how he can, at the least possible cost, make himself hives, &c., and so start his bees in an up-to-date way?—G. H. FRIEND, *Canterbury, October 23.*

REPLY.—The hand-book sent will supply all the information necessary for the intended purpose.

[3270.] *Getting Combs Cleaned up after Extracting.*—As I am about to extract the honey from some of my combs, will you please inform me—1. Whether it is too late in the season to give empty combs to bees to clear up, and if I can do so how long must they be left in the hive? and also—2. What is the best time to put them in and take them away? 3. Will combs in which the cells are charged with pollen be good if kept till the spring?—BRIGHTON, *October 21.*

REPLY.—1. If the wet combs are given to a strong stock the bees will probably soon clean them up; but there should be no delay, as weather may suddenly become very cold, in which case they may refuse to enter the box containing them. 2. If bees are flying at all during the day, defer putting the wet combs overhead till evening, and remove them any

time when cleaned up. 3. Yes, but they will be kept in better condition if left in the hives all winter.

[3271.] *Candy Feeding in Autumn.*—Will you please explain the following? I fed up twelve stocks of bees with syrup (as per "Guide Book"), giving to each about 3 lb. candy when packed for winter. The bees had a fair amount of stores, average not less than six frames of sealed food. I placed candy on frames about September 25; and now find it is nearly all gone! I watched one hive and saw a bee fly away with a piece of candy in its mouth. All entrances are narrowed, leaving just room for one bee to go in. There has been no fighting and bees are working well.—INTERESTED, *Norfolk, October 17.*

REPLY.—There is nothing at all unusual in above. It is simply a case of unnecessary feeding, and the bees would no doubt go on consuming candy as long as given until cold weather confined them to the cluster below. Six frames of sealed food were ample for winter, and candy was therefore unnecessary, but bees will feed on it as seen, while leaving the sealed stores untouched. The bee seen carrying off candy would be simply removing the few granules left after the bulk was consumed.

[3272.] *Surplus of Syrup.*—I find I have about 20 lb. of autumn syrup in excess of any needs for the moment. What use can I make of this? Will it keep for spring feeding? My bees took down a quantity of syrup and placed it everywhere, but sealed only a little. Will they collect what is scattered all over the combs into the upper parts and seal it after the feeder is removed?—D. W. M., *Cleveland, October 26.*

REPLY.—If syrup is well made and kept in close jars, it should keep till spring without deteriorating. Then, when preparing for spring use, thin it down a little with water and heat till it just comes to the boil.

## FOUL BROOD LEGISLATION.

THE IRISH B.K.A. AND THE GOVERNMENT.

The following communication from the Irish Bee-keepers' Association appeared in a recent issue of the *Freeman's Journal*, and has been sent on by a B.B.J. reader with request for its insertion in our pages:—

*To the Editor of the "Freeman's Journal."*

SIR,—At a meeting of the committee of the Irish Bee-keepers' Association, held on the 24th ult., the following resolution was passed unanimously:—"Resolved: That this Committee regret that no steps have been taken by the Department of Agriculture and Technical Instruction for Ireland to promote the necessary legislation with the object of dealing with foul brood among bees. Although nearly three years have elapsed since this

Association laid all the facts of the case before the Department, and although, as is well known, the rapid spread of the disease is fast ruining the bee keeping industry in Ireland, and that the attention of the Irish Members of Parliament and the public generally be called to the alarming reports from the thirty-two counties, and to the statements of the case for bee-keepers, appearing in the October issue of the *Irish Bee Journal*, the official organ of this Association; and that copies of this resolution be forwarded to the Lord Lieutenant, the Chief Secretary, the Vice-President of the Department of Agriculture, and to the Press."

### Notices to Correspondents & Inquirers.

*Letters or queries asking for addresses of manufacturers or correspondents, or where appliances can be purchased, or replies giving such information, can only be inserted as advertisements. The space devoted to letters, queries, and replies is meant for the general good of bee-keepers, and not for advertisements. We wish our correspondents to bear in mind that, as it is necessary for us to go to press in advance of the date of issue, queries cannot always be replied to in the issue immediately following the receipt of their communications.*

\*.\* *Southampton as a Bee District.*—Referring to the inquiry regarding Southampton as a bee district, on page 370 of B.J. (September 10), a correspondent writes, dating from Woolston, near Southampton, in reply:

"Seeing the query in B.J. a few weeks ago, I beg to say that I came from New Barnet to this neighbourhood in March last, and started the season with three established stocks and a three-frame nucleus. I have taken 106 lb. of extracted honey, and increased my stocks by one. I have been greatly troubled by swarming, two of my stocks swarming at least a dozen times, and returning to the parent hive in each case, after clustering for a few moments. I had packed down for winter with a good cake of candy on each stock by October. Thanking you for kind replies to former questions, and trusting that 1904 has a good honey season in store for all bee-keepers."—  
W. ARNOLD.

W. H. (Royston, Herts).—*Destroying Bees by Sulphuring.*—We hardly think that sulphur fumes could be "carried upward through 1½-in. holes" with such effect as to destroy a colony of bees located between the joists of a floor. Nor do we think the alternative plan you propose would be any more effective. Cyanide of potassium might kill the bees if you understood its use; and the risks attached thereto. 2. *Utilising Driven Bees in November.*—If built-out combs are on hand, along with some stored with sealed food, you might build up stocks by uniting two or three lots together at this season, but not otherwise. 3. *Sending Driven Bees out in Autumn.*—If driven lots of bees are expected to be more than two days in transit, they should be fed before packing.

4. If your runaway swarm took possession of the hollow wall of a house, we should say you cannot claim them at all without becoming responsible for damage to the building in removing.

QUEICH (N.B.).—*Paid Officials and their Voting Powers.*—1. If we saw the rules by which your Horticultural Society is governed, it might be possible to form an opinion whether or not a paid secretary should have the power to vote at meetings. As it is, we think the matter should be decided by the rules, without any appeal to outsiders like ourselves. 2. If a three-frame observatory hive is well ventilated, we do not see any cruelty in keeping live bees therein for two days. It is, of course, preferable to allow the bees to fly where convenient.

J. A. P. (Halifax).—*Bees Depositing Queens.*—Your omitting to quote number of your former letter or page whereon it appeared, makes it difficult for us to reply, and we cannot trace it; nor can we answer queries now sent without this reference. From details now given it seems simply a case of bees superseding the old queen. Anyway, if the "fine-looking queen now parading the combs" is a recently hatched one, it will soon be seen whether it is safely mated, which we doubt at this late season.

ECONOMIC (Mohill, co. Leitrim).—*Re-queening Stocks.*—Dead queen sent is diminutive in size, and by no means maternally in appearance, being almost as slight as a virgin queen. There are none of the usual signs of old age, however, and the unprolificness may be simply constitutional.

JIM (Ipswich).—*Loss of Bees in Transit.*—The letter from railway company, declining to entertain any claim for compensation, is only what we expected.

F. C. H. (Twickenham).—*Drones in October.*—The turning out of drones at this season may mean that the stock has re-queened itself late in the year, and that the new queen is safely mated. The best course, under the circumstances, is to take advantage of the first fine day to examine the combs, when, if worker-brood is seen, all will be well. If, on the other hand, sealed drone-brood is found in worker-cells, the queen is worthless, and the stock needs re-queening at once to be of any use.

A. BEGINNER (Tunbridge Wells).—*Pollen-filled Brood Combs.*—There is no trace of brood, either foul or otherwise, in comb. The cells contain only fresh-gathered pollen. It looks as if bees had deserted the hive because of there being no breeding-space for queen.

BOX (Glos.).—*Queen Mating.*—Queen sent is a ligurian and apparently only just hatched. She has certainly never flown from hive, so cannot possibly have been mated.

\*.\* *We trust to be able to cope with some overdue Correspondence next week when Report of Conversazione will be concluded.*

## Editorial, Notices, &c.

### THE LADY WARWICK COLLEGE, STUDLEY CASTLE, WARWICKSHIRE.

To train educated women in what belongs to the lighter side of agriculture—namely, dairy-work, market-gardening, poultry farming, bee-keeping and fruit-growing—was the idea of the Countess of Warwick, and was carried out by the founding by her of the Reading Hostel in 1898. The success of this, and in consequence of more accommodation being needed, the students have now been transferred to a new and larger home at Studley Castle, Warwickshire. On Saturday, October 24, the first meeting of the Council of what is in the future to be called the "Lady Warwick College" took place on the newly-acquired property. The members of the Council and friends, who were invited for the occasion, were shown over the estate by some of the students, who gave all the information asked for. There is accommodation in the building for sixty students, and there are plenty of bath rooms, electric light, and all the necessaries of a modern house, which Studley Castle is, being only seventy years old. The rooms are lofty and airy, and in every respect suited for the purpose. The grounds and gardens have been well laid out, and there are some fine conifers and other trees; but the fruit trees have been sadly neglected, and will give full scope for trying the ability of the "Daughters of Ceres," as the Countess designates her students, to prune and re-graft some of them, and make them again productive. There is about 400 feet of glass, and the houses are stocked with chrysanthemums and tomatoes, which looked remarkably well. The apiary had not yet been moved from Reading, but the country round seems well suited to bee-keeping.

The meeting was held in the lecture hall, the Countess of Warwick presiding. The warden, Miss Bradley, read the report, which stated the difficulties experienced in moving from Reading, and the Countess explained that for some time she had been looking out for a small property having a large house, which was very difficult to find. The meeting had been called, and she had invited some friends, because it was necessary to justify their presence in Warwickshire. She gave an account of what had been done, and the success achieved by many of the students. Out of 225 who had passed through the "Hostel" at Reading, 33 had obtained posts with sufficient salary to constitute a living wage. Amongst those called upon to speak were Lord Coventry, Lord Hertford, Professor Hilyard, Mr. T. W. Cowan, F.L.S., and Mr. T. W. Sanders, F.L.S.

We congratulate Lady Warwick upon the success that has attended her efforts so far,

and cordially wish it prosperity in the future. There is no doubt that many women would be able to undertake the work taught at the college if they only knew how. Fruit-growing and bee-keeping must go together, and we know women can be successful in these branches, because we have seen some of the best results obtained by them. Undoubtedly there is a great opening in the Colonies, where women are scarce, but it is very little use any going out who cannot turn their hand to dairy-work, poultry keeping, or some of the other lighter forms of work on the land. The Countess of Warwick has spared nothing likely to make the college of real use to the students, and we feel sure she will have the hearty co-operation of all who are interested in the education of women.

### BRITISH BEE-KEEPERS' ASSOCIATION

#### CONVERSAZIONE.

(Continued from page 434.)

Mr. Cribb disclaimed the intention of implying that the council did nothing in support of the cause. But, there was in the Government an official known as the Colonial Secretary, whose duty it was to keep the mother-country in touch with its offspring, and if some similar tie could be established by the B.B.K.A.—which he thought should make itself more known, it would redound to the interest of both sides. Delegates or some of the council might visit some of the county shows and be introduced to some of the county people, which would help to advertise the parent body. He thought the insurance scheme one of the best he had ever known, and a leaflet thereon had been issued to their members; indeed, it was sent out to all readers of the *B.K. Record*. They had 58 districts in Lincolnshire, which was a large county, being 75 miles long by 25 broad. Then with regard to the board of examiners, he did not pretend to say that it consisted of incapable persons, but he merely thought that the names should appear in the reports of the parent association. Of course, the gentlemen named (as he now knew) would lend weight to any board or any scheme they might undertake relating to apiculture; but he believed that publicity was the best antidote to controversy in this case.

Mr. Cowan quite believed that Mr. Cribb's criticisms were intended in the friendliest spirit. He (Mr. Cowan) always regretted that county representatives had not attended the meetings and taken part in the work as it was hoped they would do. To show what support had been received from counties he would quote one little circumstance. The B.B.K.A. prepared a book of "Instructions to Experts" and had it printed at considerable cost. Nearly all the county associations approved of these instructions, yet no more than three copies of the book had been applied for. True, it was said Leicestershire was intending to do so

next year, so that would be four counties in all who had taken them for use. With regard to representatives visiting the country, he might say that had also been tried. The central body decided some years ago to appoint committees for North and also for the South to meet the county representatives annually, Mr. Cribb himself being on the northern committee; but that experiment proved a complete failure. One meeting was held at Shrewsbury, and he was sure the company would be astonished to hear that the attendance was so small and discouraging that the plan of holding meetings at a distance was not pursued further in view of the expense involved for no useful result. The members of the Council were already overburdened with work and personal expense without attending county shows, as had been suggested.

Mr. Belcham (Essex) asked whether a county representative was entitled to receive notice of monthly meetings. Through the kindness of the Essex committee he had been appointed to attend them for several years, but had received no notice except in the present instance.

The Secretary said that as a member of the society, he (Mr. Belcham) would receive the notices just prior to the annual meeting. There were only two meetings yearly.

Mr. Belcham asked whether county representatives were allowed to attend monthly meetings of the B.B.K.A. Council?

Mr. Cowan stated that Rule 3 of conditions and provisions of affiliation reads as follows:—

“Each affiliated association shall hold an annual general meeting, and elect two of its members (not necessarily residing within the county or district) to attend the quarterly conferences of representatives, one of whom (approved by the central society) being a member of the British Bee-keepers' Association, is an *ex officio* member of the council.”

Mr. Bevan would like that rule to be thoroughly understood. He had been a representative, but never received a notice.

Mr. Cribb thought that part of the misunderstanding arose from the fact that the rules were not printed in the report. Would it not be advisable to have them printed therein at least once every few years, because he believed the rule just read out was unknown or forgotten by the county associations.

Mr. Cowan apologised for rising so often, but as Chairman of the Council these points frequently came before him. There was also another clause dealing with “The advantages to be derived from affiliation,” which read as follows:—“The interchange of ideas at the Quarterly Meetings for the improved working of the Associations, and all subjects connected with successful bee-keeping, and a voice in the management of the British Bee-keepers' Association through the representative, who is an *ex officio* member of its council.” Some years ago, all that information used to appear in the report, but since 1896 it had

been omitted for reasons of economy. That was in consequence of the cost of the educational teaching, which became greater year after year; and it was decided that in future anyone requiring the full particulars could have them sent on application. Secretaries of associations were all supposed to have a set of such papers, and they were always supplied to new associations when starting.

The Chairman thanked Mr. Cribb for the useful discussion he had initiated, which had afforded an opportunity for the Council to answer all his criticisms and suggestions. He would say on the authority of the Chairman of the Council that all the recommendations offered that evening would be considered, and everything done as far as possible to meet the wishes of those who had brought them forward. He thought the rules might have to be altered to enable representatives to attend the monthly meetings, and vote. He thought secretaries and representatives ought to have some voting power, and he would be glad to promote that view. Possibly more attention might also be paid to the sending out of notices of meetings, and longer warning thereof given.

In replying to a general discussion in regard to the size, design, and cost of medals, Mr. Cowan drew attention to several samples of new medals on the table before them, and said they had been prepared in order to meet a desire for small medals, which might be worn on watch chains or in other ways. The designs were selected out of a large number submitted, not only from England but the Continent. These small medals were not intended to displace the large one, which could be had if desired.

General Sir Stanley Edwards had received a small quantity of honey from Oporto, and had brought a sample to show the company. He would be glad for them to taste it, and express an opinion on its quality. Perhaps some of the experts present would say from what it was derived, and whether it was good honey? The sample was passed round, and various opinions expressed as to its origin. Eventually, General Edwards said he believed it was gathered from the orange groves of Oporto.

Mr. Cowan said that probably some of them had seen a letter in the B.J. referring to some honey that had been clarified by ozone, produced by an electrical machine. He then showed a sample thereof, after treatment, along with some of the original honey that was almost black in colour, which had been sent by Mr. Galbraith. Of course, if the honey could be clarified without impairing its flavour, the invention would be a valuable one. Mr. Galbraith had stated in reply to an editorial comment in B.B.J., that he thought it could be done without deterioration; and, that if he could be supplied with 7 lb. to 14 lb. of the blackest honey, of good flavour, that could be procured, he would try the experiment with every hope of success. The cost of treatment was very small. If that honey could be

obtained by gift, he (Mr. Cowan) would be very glad to go and see the process carried out. The sample was passed round and freely tasted.

Mr. Reid said the discovery was a most valuable one, and highly interesting and important to bee-keepers. He had himself found by experiment, that honey could be bleached with ozone, which rendered it more like syrup than anything else. He had had a good deal to do with ozone, and was a director of a company that produced it. The difficulty he had always found in his experiments conducted some years ago, was that the flavour was destroyed by any process of the kind, and could not be recovered. There was no harm in using ozone with any article of food, and for some honeys that were not marketable at all it might be an advantage to use it. The cost of producing ozone was infinitesimal, and therefore the scheme was quite practicable if it would answer.

Mr. Cowan said there might be some gentlemen present now who witnessed a demonstration he gave some years ago in that room of the polarisation of honey. He at that time showed a sample of honey that he had bleached by filtering through animal charcoal. He diluted the honey with water, and after filtering it evaporated the water to get the honey to a proper consistency, but he noticed that the flavour of the honey had disappeared. He was not certain whether it was the evaporation or filtering that had produced this effect; but probably the charcoal had taken away the aroma. If it was a fact, as stated by Mr. Galbraith, that his method did not impair the flavour of the honey, then the invention would be welcomed everywhere, as a large quantity of otherwise worthless honey could be utilised. In any case the plan was worth a trial.

Mr. Carr thought the matter must be considered from a purely practical point of view, and the question was, had the honey altered in colour for the better and in flavour for the worse? The sample of black honey shown was abominable in flavour, and the lighter one not anything so bad.

The Chairman thought the clarified honey no doubt had been altered for the better.

Mr. Belcham asked whether the process involved any diminution of weight?

Mr. Reid replied that there ought to be no loss of substance. The honey would not granulate after dilution.

The debate was at this point continued in conversational form by Messrs. Carr, Scattergood, and Cribb.

Mr. Sladen, having then been called upon, said he had been much interested in the curious marks—which bore some resemblance to the ravages of the small wax-moth larva, in the capping of several sections recently placed under his inspection, one of which he held in his hand. He had observed there a minute larva, legless, and with a different kind of head from that of the ordinary wax-moth, and had

come to the conclusion that it was quite a different insect; but he had solicited more specimens in order to make further investigation. He believed the larva to be the puparium of a fly. It looked rather large at the bottom, and there was some webbing, which conveyed the appearance of the wax-moth; but it seemed to burrow only on the surface of the capping, and was exceedingly small compared with the wax-moth larva. The sections sent him in June and July generally contained this larva, and the appearance of the comb was considerably disfigured in consequence. He had seen it in sections sent from Kent, Oxford, Berks, and Surrey.

The Secretary of the B.B.K.A. then produced a small glass jar which had been exhibited at the Dairy Show and obtained a prize. It had been used for the purpose of sending cream round to wholesale houses. He asked the audience to note the sealing, and said that Mr. Herrod had kept this sample jar with its contents for forty-eight hours in an inverted position without any sign of leakage. The arrangement he considered a very neat and satisfactory one for application to honey. The jars cost 3s. 6d. per dozen and the wads 2s. per thousand, although he believed the price might be reduced. The smaller the bottles were the more expensive they would be in proportion.

Mr. Till said he was recently in the neighbourhood of Whitechapel, when he saw some large cases of wax in a shop. He accordingly went in and inquired about selling English wax to the shopkeeper, but the price offered was an impossible one. He (Mr. Till) said he could get 1s. 6d. per lb. for his wax from shopkeepers. That in question came from Gambia and Zanzibar. The latter was bought at £7 15s. per ton, and the former at £7 10s. None of this was guaranteed pure. Some of it looked like beeswax, but might be only vegetable wax. He then showed the different samples, which were passed round and examined.

Mr. Cowan said that a few months ago the question of dealing in English beeswax came up before the Council. Miss Gayton had been asked to bring a letter before the Council from a candle manufacturing company whose secretary was interested in bee-keeping and wanted very much to do some good to the British bee-keeper. The firm in question would have been glad to take British wax, but there was not a sufficient supply for the purpose. The price offered was 1s. 1d. or 1s. 2d. per lb.; and so long as foreign wax at that price, or cheaper, could be obtained there was no chance for English wax. The latter was principally wanted by bee-keepers for their own comb foundation.

Mr. Reid considered Mr. Till's experience very interesting. The so-called "vegetable" wax was often really a mineral product; but, the point of adulterating could always be tested very simply. Take a piece of blotting

paper, dip it into the melting wax, then set fire to it and blow it out, when a strong bituminous smell would be emitted if the wax were of mineral origin; while, if pure, there would, under the same circumstances, result an aromatic perfume. He had noticed that some of the foreign waxes were refused by British bees even when pure. He himself brought some from Brazil and made foundation with it, but his bees would not use it, although he was quite sure there was no mineral wax in it. Possibly his bees were protectionists! (Laughter.)

Mr. Cowan said, that in the days of the Stewarton hive, he had fitted a Stewarton super with strips of wax foundation, but the bees built their combs in between, using the sheets of foundation as separators. The wax in question was no doubt paraffin.

A new feeder for bees which had been sent by Mr. Wilkes of Birmingham was then exhibited and explained by Mr. Cowan. It consisted of a receptacle with three conical valves by means of which the flow of syrup could be regulated, and leakage absolutely prevented. It was also made with a shifting bottom, by means of which it was readily converted into a rapid-feeder when required. The price was 2s., without the adaptation for rapid-feeding, and complete 2s. 6d. The feeder was passed round and seemed to be approved of by those present.

Colonel Walker speaking about the ancient book sent by Mr. R. Brown, Somersham, said that it was written about 1623 to 1634. It was afterwards translated into Latin, in which language it remained for many years until some one, who apparently thought it a pity the book should be obtainable in Latin only, and decided to translate it into English, which was accordingly done, and this formed an amusing episode in the book's history.

(Conclusion of report in our next.)

## Correspondence.

The Editors do not hold themselves responsible for the opinions expressed by correspondents. No notice will be taken of anonymous communications, and correspondents are requested to write on one side of the paper only and give their real names and addresses, not necessarily for publication, but as a guarantee of good faith. Illustrations should be drawn on separate pieces of paper. We do not undertake to return rejected communications.

### AMONG THE BEES.

[5281].—*Brief Reports.*—Nothing at this season of the year forms more interesting reading in the pages of our bee newspapers than these records of the past honey season; and I should like to see a long list of them for some weeks to come. I note in our local dailies, as a sign of the times, that editors welcome them in papers not connected with the craft. A well-known Perthshire bee-keeper supplies an annual report, dealing with a large section of the

county: and we might have a series of these in the JOURNAL, showing on reliable authority how the season has affected the supply, and any interesting features connected with the industry. Looking over back volumes, I was struck with the number of these brief reports, and I trust the admirable practice of having as many as possible will be revived. A post-card to No. 10, Buckingham-street will do in many cases, and a very long article indeed will carry for a halfpenny if addressed to the Editor, and marked "Press Copy."

*A Queen up the Sleeve.*—This is what actually occurred to me just lately. I was examining a hive for a friend which he deemed was queenless. The day before he had examined it carefully, finding neither queen, brood, nor eggs, and on the strength of this he had ordered a new queen. On examining the second comb, however, I spotted a queen, small and not fully-grown, but so developed that I anticipated eggs should be somewhere; and so we found; for the frame on which she was discovered showed two small patches quite recently deposited. While looking closely at the reverse side, I felt a bee up my sleeve, and, on replacing the frame, gave a sharp downward shake to the arm, dislodging it on to a tuft of grass. Something in the shape and colour attracted our attention, and, on examining it closely, it proved to be the young queen. The incident is peculiar, if not indeed unique, and shows how very simply it is possible to make a colony queenless without being in the least aware of it.

*Ligurianising.*—Everything touching on the life history of the bee has a fascination for the student of apiculture. During early summer I had an opportunity of watching the gradual elimination of a stock of black bees consequent on the introduction of an Italian queen. The gradual steps in the process were very interesting, as the successive developments followed each other so rapidly that daily observation showed something new. The following figures may be worth placing on record as showing the short space of life enjoyed by the worker bee during the period of active work in the fields:—

		Days.
Queen inserted	... June 6	
Liberated	... " 7	1
Eggs seen	... " 11	5
Larvæ seen sealed	... " 19	13
First bee seen	... July 1	25
" " outside	... " 8	32
Acting as Guards	... " 10	34
Seen carrying Pollen	... " 19	43
" " Honey	... " 20	44
50 per cent. Italians	... " 22	46
75 " " "	... " 25	49
90 " " "	... " 29	53
A few Blacks still	Aug. 1	56
Blacks disappeared	" 6	61

It was marvellous to see how rapidly the blacks disappeared, especially during the last fortnight, when the decrease in numbers was



something extraordinary. I calculated that, when the queen was inserted on June 6, the colony numbered 30,000 blacks; yet in sixty days they had all died out, showing an average mortality of about 500 bees per day. In the earlier weeks it was much less so; in the later ones it must have been very considerably greater. The queen was a valuable one, imported from Italy, with a rest on the way just after crossing the Channel. She proved a credit to her race in the way of egg-laying, for before she was in the hive a month, every available cell was occupied, and she kept it up well until about the end of August, when she suddenly ceased ovipositing; so that by the middle of September there was neither eggs nor brood anywhere in the hive. Her progeny at that time was, however, numerous, and every comb appeared a solid phalanx of bees. Two other features were very noticeable. Their industry, unless on very fine days, was less marked than that of the natives, and apparently they were content with enough stores to keep the house going. They were very quiet and gentle under manipulation, and allowed a full investigation of the whole interior to take place without the use of smoke, lying close to the combs, and making no attempt to fly at the operator.

*No More!*—It was with profound regret I read the notice on page 429 of the death of Mr. David Raitt. Young, enthusiastic, energetic, with a sincere love for bee-keeping and bees, he had set a high ideal of life before him, and had he survived, he would have left his mark, and carried higher still the family name, which stands second to none in Scotland. He was proud of his father, and lately wrote: "Deep down in my being—greatly because of his deep love for them—I find myself in the true succession." Indeed, in a letter received from him not so long ago, this was the keynote of the aim he desired to secure as the result of his life's work. An insinuation that he was not worthy of his sire touched his sensitive nature to the quick, and brought out a noble and manly resolution to climb still higher. His few contributions to the JOURNAL breathe the same spirit the desire to obtain as near as possible to perfection; and his prayer for the brotherhood of man (vol. xxx., page 195) should animate us all. The sad refrain of "Lochaber No More!" comes into my mind, and we sadly feel that there is another gap in our ranks, and that one more good bee-keeper we shall see "No More."

*Encyclopedic Schoolmasters.*—I noted the particular point to which S. Darlington (5267) draws my attention when reading my B.B.J. of 22nd ult., but did not deem the case one worthy of a protest, as, like one of his colleagues, I considered "the gentleman's strictures were not always well-founded." Rather curiously, on putting the paper down to meditate, a certain parable came into my mind unsought: what the connection between the two all-righteous speakers may be I will leave

others to determine. Teachers, however, may solace themselves with the reflection that the two discordant voices—no more than the "tailors of Tooley-street"—cannot be set down as speaking for "the people of England" Not long ago I delivered a lecture on bee-keeping, and this is a sentence it contained:—"I have been a student of apiculture for over twenty years, and for fully a dozen have been writing to bee-newspapers and magazines about my hobby; but I am now only touching the fringe of the subject, and realising—not how much I know about bees—but how much I don't yet know." So your readers can see all schoolmasters don't hold the high estimate of themselves taken by the specimens discovered by the worthy clerk of the Notts. School Board out of, I think, his own inner consciousness.—D. M. M., *Banff*.

#### SOME EAST KENT NOTES.

[5282.] Along with the rest of bee-keepers I have to deplore the wet season, especially so the latter part of July and the first fortnight of August, and although May and three weeks of June were so wet that nothing in the way of surplus was stored, the few fine days during that period being only just sufficient for the requirements of the brood-nest, I am sure that the loss was more than counter-balanced by the wealth of bee-forage (the result of the early rain) available when the weather cleared. No honey was stored in supers until after June 21, and then for about a month, with the exception of a few cold, dull days, ideal bee-weather prevailed. Unfortunately the third week in July brought thunderstorms, followed by persistent and continuous heavy rains, with only intervals of a day or so on which field work could be done. To me this was particularly disappointing, as there were good second crops of sainfoin, and in a wood close by an abundance of wild sage blooming profusely, on which the bees were working vigorously whenever weather permitted. So that there were tons of honey—so to speak—waiting to be gathered and nothing between it and the supers but want of sunshine.

However, I ought not to complain, as 1903 has proved my best year, having secured an average of 106 lb. per hive; the produce of my little back-garden apiary yielding me a profit of about £10. Quality of honey and colour better than anything I have ever previously secured, all of it being "light grade" when tested by the B.B.K.A. coloured glasses. My "Ford-Wells" hive gave me five dozen shallow-frames of honey, amounting to about 140 lb., one half doing double the work of the other, the queens being unequally matched, one utilising the whole of the twelve standard frames for breeding and five of the shallow-frames in the lower sliding chamber, before the main honey flow, while the other did not enter the lower chamber

at all, and was late in filling the brood-nest proper; thus emphasising that with bees you may get honey, without them you never can. One twelve-frame single hive supered with standards gave me 120 lb. This hive has always given a good return, whether it is due to using standard size combs in supers, or to having twelve frames for brood-nest, or to its being a hive of the "W.B.C." pattern, or—and here's the rub—to its being stocked with a remarkably good strain of bees, I can't say; but the queen is a home-raised Italian each year getting the brood-nest packed with bees and brood before the main honey-flow. If we are to secure large surplus takes we must have a mighty army of foragers at the right time. I do not put any faith in the fact of having used standard size combs in supers, as I feel sure they would have done equally as well had shallow-frames been used.

*Profitable Swarming.*—Only one hive swarmed, and I felt rather annoyed at first, but it proved a blessing in disguise. June 17 was the date. On June 11, Col. Walker's article appeared in B.J. on "Swarms do the Work." So I decided to work the swarm on the principle described there. As for want of room my hives stand less than 2 ft. apart, it was impossible to operate as directed, by placing the hive for the swarm at right-angles to the stand from which it issued. So I did, in my opinion, the next best thing. In the evening I took five frames of sealed brood with the adhering bees from the old stock and put them in a hive that stood in the row, first cutting out all queen-cells; filled up with empty combs; took the super of shallow-frames off the old stock (almost empty) and put it on the hive for the swarm, covered down snugly with quilts, and then ran the swarm in. In ten days' time the 20,000 or so of bees in the five frames had hatched out; the bees that were adhering to the frames, being mostly young bees, stayed with the swarm and strengthened it in just the same way as if the swarm had been set on the old stand later, as suggested to catch the flying bees. The result was 60 lb. of honey, which would probably have been doubled had the weather held fine for another fortnight. The old stock "cast" —eight days after the top swarm—about three pints of bees. I put them into a hive on four frames and they and the old stock have worked up to established colonies, have stored their own "cupboard" to repletion, and gone into winter quarters in fine condition. I beg leave to tender to Col. Walker my best thanks for his practical and timely article on June 11.—ARTHUR H. HOMERSHAM, *Sturry, near Canterbury, October 24.*

#### SELLING HIVES TO COTTAGERS ON THE "EASY PAYMENT" SYSTEM.

[5283.] A letter appearing in last week's JOURNAL induces me to propose a scheme for supplying hives to those *bonâ fide* cottagers

that cannot well afford to pay the whole of the money down; and though I am an advocate of small profits and quick returns—being a working man—I understand some of the difficulties of the working classes. What I would propose is an "easy payment" system for the supply of hives. I think that a small instalment of sixpence per week for a hive costing about twelve shillings would come within the means of most of our cottage bee-keepers; or, as a weekly payment would involve some expense in postage, two shillings every four weeks, so that in a few short years the old-fashioned skep would be superseded by the frame-hive in our cottage gardens, to the advancement of the industry. Any correspondence on the subject will be welcomed by HARRY CLARKE, *Allesley, near Coventry, October 30.*

#### THE PRICE OF HONEY.

[5284.] Those who buy honey at 6d. in bulk, and sell it at 9d. in glass jars, do not make a great profit on the transaction. Considering the retail price, they might get 10d. per lb. for it; the grocer sells at 1s. or more, and 1½d. or 2d. per lb. is ample, seeing that he has so little trouble in the matter. It is obvious that bee-keepers who desire a good price must dispense with the middleman. But we must not disparage this individual; he is very useful in some cases, and I think it is fair to let him have the honey at a less price than we would sell it for to the grocer direct; but I certainly do think that those who possess the necessary business ability for selling their honey direct to the grocer, apart from the middleman, should get the best price for it.

The mischief of the low-priced honey, such as that advertised, is that it helps to reduce the price all over England, because a grocer seeing honey advertised in this paper at 45s. per cwt. is not likely to give a better price, nor to purchase from a middleman at a higher figure, and in this way the offering publicly of honey at a low price simply cuts the ground from under the feet, not only of the middleman, but of the great bulk of honey producers.

The evil is likely to become serious. Any amount of persons entirely lacking in business abilities are engaging in the honey industry, and are seemingly glad to dump their honey on the market at any price. I think the time has come for bee-keepers to devote as much attention to the sale of honey as they do to increasing its production. It is very easy to spread abroad the principles of apiculture, but it is rather a doubtful blessing to bee-keepers to flood the industry with a number of persons who are incompetent as business men, and merely reduce the profits of those already engaged, and that unfairly, because good honey is certainly worth more than these people offer it for in advertisements.

If the Bee-keepers' Associations are to be of any real use, they must grapple with this question, and devote more attention to the £ s. d. side of the business. Their members need educating on the point. Without this they will do harm and not good to the industry by adding to our ranks an incompetent class of persons, who are incapable of finding any method more original for the sale of their honey than the lazy expedient of offering it at a ridiculously low figure.—W. J. FARMER, *Truro, October 30.*

### B.B.K.A. CONVERSAZIONE.

[5285.] In reference to my letter brought before the Council of the B.B.K.A., and which appears quoted in the B.B.J. (page 431), did I not write—"Surely any bee-keeper who has passed his *first*, or even his *second and third* examinations should be capable of taking these examinations"? I ask because that is what I intended to write, nor did I mean to imply that *any* such bee-keeper should be allowed to so act, but only such as the Council deemed capable. Mr. Cowan goes farther (see second column of page 433) by saying that an examiner does not require a certificate at all. Besides, I only contemplated the giving of a *third* class certificate, and my chief point was intended to be that there must surely be suitable men in the North for doing so.

In reference to mention made of county associations paying representatives' expenses to go to London (with no vote when they are there!), it would be a heavy tax on the northern counties, with funds needed badly to carry on the county work, and this applies to what Mr. Weston suggests as to getting members for the B.B.K.A. As regards Cumberland, I would have been pleased to do so if I could have seen my way.

I am sure that Mr. Weston's proposal of a Manchester centre would be acceptable to the North.—GEORGE M. SAUNDERS, *Hon. Sec., Cumberland B.K.A., Keswick, October 31.*

[The letter on page 431 is printed *verbatim* as written by yourself.—EDS.]

### HIVING SWARMS.

#### NEW *versus* OLD METHODS.

[5286.] Now that the busy season is over, perhaps you can spare a little space in your valuable paper for a discussion on the above subject. With all our improvements in bee-keeping, we in this country seem to have stood still in the matter of hiving swarms. It is true swarm-catchers have been invented, but I believe they all, more or less, obstruct the hive entrance, and somewhat increase thereby the tendency of the bees to swarm, which we are all so anxious to prevent. Some also claim to be able to prevent swarming almost entirely, but most will agree with me that this is not possible in all districts. Every

year we hear of "truant swarms," and of swarms which cluster in awkward places. In the last issue of the B.B.J., October 29, "Sussex B" (5279, page 437) says that no less than six of his swarms decamped this season. This seems to be a result of the old method.

To come to new methods. Can any of your readers give me any information about the practice of clipping the wings of queens, which seems to find such favour in America, and prevents swarms decamping to a great extent? Why should it not work just as well in this country? I shall be very glad if any of your readers can answer the following questions:—

1. Is the process of "clipping" really painful to the queen? 2. How much of the wing is it necessary to cut off? 3. What are the disadvantages of "clipping"? And will those who have tried the plan say what ways they adopted in hiving the swarms?—L ILLINGWORTH, *Acton, London, W., November 2.*

[Any replies from readers to the above queries we will gladly insert, but so far as clipping queens being included in "new methods," it has been known in this country for ten or fifteen years past, but has never found favour.—EDS.]

### SCHOOLMASTERS AND BEE-KEEPERS.

[5287.] Referring to Mr. Scattergood's remarks at the London "Conference" on the "conceit" of village schoolmasters, may I say that, although a co-worker with Mr. Scattergood, I did not agree with him on this point, as evidenced by my remarks at that meeting? When supporting what was advanced as regards teaching children bee-keeping, I said that the best way of doing this was to get schoolmasters and schoolmistresses interested in the matter, and they in their turn would teach the children. I do not find schoolmasters so "conceited" as our friend would make it appear; in fact (as I have personally told him) my experience has been quite the reverse. We have in our association and on our various committees several schoolmasters, and have certainly no cause for complaint under that head. But, apart from this, I have had under my tuition in the "Rural economy" courses at the Kingston Agricultural Institute during the last summer, between 50 and 60 schoolmasters and schoolmistresses who never showed this characteristic if they possessed it, but were most interested and anxious to learn what they could of the subject in hand. I have also done a good deal of lecturing with the lantern, and not seldom has the schoolmaster brought some of his scholars to listen to the lecture, and in some cases, has, to my knowledge, previously instructed them to write an essay on the subject afterwards, thus showing his interest in bee-keeping as a subject for children.

. In my opinion, to further our cause, we must lay the foundation in the minds of the rising generation, and how can we better do this than through the medium of the schoolmaster or schoolmistress—even though we may come across one now and again who may show a little conceit.—GEORGE HAYES, Secretary, Notts B.K.A., *Beeston, November 2.*

## THE CONFERENCE OF BEE-KEEPERS.

### A VILLAGE SCHOOLMASTER'S CHALLENGE.

[5288.] It is always instructive, and generally a pleasure, to read of the doings of the B.B.K.A. at headquarters. It was, however, with indignation that I read the remarks made concerning the poor village schoolmaster. I had hoped that some one would have a word to say in his favour, either at the conference or at the subsequent *conversazione*, but I perused the report in the *JOURNAL* in vain. I, however, note that the Chairman drew attention to what is done in Germany, where bee-keeping is taught in Normal Schools, and which the schoolmaster was required to teach. He also said that it was the children they wanted to secure. Messrs. Cribb and Scattergood, however, will have none of the village schoolmaster, and they have a very poor opinion of him either as a lecturer or a keeper of bees. I wondered why our friend Mr. C. N. White, who, it seems, was present, did not break a lance on behalf of his old confrères?

To vindicate my class, and attempt to remove the aspersions cast upon an honourable calling, I should like to meet the two gentlemen in friendly combat. I propose that either or both of them shall deliver a lecture on bees at some accessible centre, and failing a more able exponent, I will do my best to show that even a village schoolmaster can give an interesting lesson on bees. Let the test be "A thoroughly interesting and up-to-date Lantern Lecture on Bees and Practical Bee-keeping," and as judges I would wish for none better than a body of local bee-keepers. As a suitable centre, and on neutral ground, I would suggest Sheffield or Leicester. They could deliver their lecture on one evening, and I would give mine on another. Will they accept my challenge? and will some committee make the necessary arrangements? I am prepared to pay my own expenses. Make good your words, gentlemen, and try to prove that where bees and bee-keeping are concerned the poor "dominie" must keep in the far background. The Editor can vouch for the fact that I am a *bonâ fide* VILLAGE SCHOOLMASTER.

## THE WORD "PROPOLIS."

### ITS PRONUNCIATION IN MODERN GREEK.

[5289.] Having resided for some years in European Turkey, in a district where the majority of the inhabitants are Greek, your readers may be interested in hearing how the

word "propolis" is pronounced in modern Greek. Now the derivation of the word is from *pro*, before, and *polis*, a city, which is, according to present-day Greek, *propôlē*, the accents on the vowels, as in Constantinopolis (Greek), in which the final "s" is not sounded and the "i" is pronounced "e," thus, Constantinôpolē, again, Adrianôpolē, Gallipolē.

Where I am living the methods of modern bee-keeping are as yet quite unknown. I commenced for the first time this year partly to gain experience myself, but more with the idea of getting the natives to take an interest in their stocks, and do away with the old-fashioned skep with the periodical fumigating and its accompanying slaughter.

In the autumn of last year I procured two stocks in wicker skeps, but as I had to make the first frame-hive myself, when I could spare the time, I was not able to put the bees into their new abode until May, when the fruit-blossom, which is the principal harvest here, was practically over. On April 24 a swarm issued from No. 1 skep, which I was able to capture in a spare skep. Six days later a cast issued from the same hive. On May 10 I drove the bees from No. 1 to a new skep, and after cutting out comb with brood sufficient to nearly fill the ten frames in brood-chamber of my new hive, 14½ in. by 14½ in., and tying same in with tape, I shook the driven bees into the hive, at the same time uniting the cast.

The new comb that the cast had already formed since April 30 I was able to make good use of for foundation in the two racks, containing in all forty-two 4¼ in. by 4¼ in. sections. I had two swarms issue from this hive during the month of July, one of which I have in a skep, the other I unfortunately lost. There is, however, about 30 lb. in the 4¼ in. sections ready to take.

My No. 2 skep I drove on May 31, uniting with bees the swarm from No. 1 skep, leaving the queens to settle their own differences. I have had no swarm issue from this hive, and on September 10 took about 40 lb. to 50 lb. of honey from ten frames over the brood-chamber, and on October 12 another 10 lb. from the small sections above. Both my hives are in a stronger condition than this time last year. In No. 2 hive I tied in brood-comb as in No. 1, but had not sufficient for foundation in surplus-frames. I therefore nailed strips of zinc along the top side of each frame; this was effectual in keeping the comb parallel and in the desired direction, but in some of the frames the bees built their comb round, embedding the zinc, and in the small sections commenced building on the zinc itself from the side. The whole of the frames extracted on September 10 were nicely sealed over with no appearance of brood having been placed in them, though I had not used excluder-zinc. A Greek friend of mine in a neighbouring village, to whom I made a present of a hive fitted with frames, has just informed me that

his bees have had to pay a special war tax of five piasters for each hive, irrespective of what they may contain.

As far as myself is concerned, I have, with the aid of your valuable journal and guide-book, gained a good deal of experience and pleasure from my first year's attempt. But it is easier to drive bees than to dissuade a Greek from the ways of his forefathers.—C. W., *Constantinople, October 18.*

### INSURANCE FOR BEE-KEEPERS.

#### NUMBER OF HIVES INSURED.

[5290.] I notice the request of two of your correspondents that the number of hives insured should be given in your pages. Up to this date the number is 7,030. I want to have at least 1,000 more, and should get them if bee-keepers realised at how slight a cost they can free themselves of responsibility to third parties for any damage done by their bees. I enclose a cutting from the *Canadian Bee Journal*, showing the dislike bees have to sweating horses, and the result of bringing such horses near the apiary.—T. J. WESTON, *Baltham Park Mansions, S.W., November 1.*

[The cutting referred to gives lengthy details of a mishap in Canada, caused by a team of spirited horses being injudiciously employed in carting grain close up to an apiary of 160 hives at a time when the bees were busy and inclined to sting. When attacked by a few bees the horses refused to move, and their assailants made a general onslaught. Eventually, the labourers having fled, the animals were nearly killed. As report states:—

"The poor brutes were literally stung over every inch of their bodies, and it was thought that they would certainly die. Salt was given to them as soon as possible, but owing to the way they kicked and plunged after being put in the stable hardly anything could be done by way of removing the stings. However they have pulled through, and to-day (a week after the stinging) they appear to be improving nicely although their bodies are covered with lumps full of pus which are now discharging."—EDS.]

### HONEY AND ALCOHOL.

[5291.] From Mr. A. W. Barker's honey label on page 419 we find that honey is grape-sugar, and that grape-sugar when subjected to fermentation is converted into alcohol. Will "A. W. B." kindly tell us if we are to understand from this that when honey ferments alcohol is produced? I would also say the wording of "A. W. B.'s" label does not convey the meaning very clearly. He states that the honey-bee, by ripening the honey and sealing it over with wax to exclude the air, prevents fermentation. Thus, if the bees had neglected these precautions fermentation would have taken place "naturally." How, then,

can what takes place naturally be an invention of man?—INQUISITIVE, *Nantperchellan, Kilgeran, October 28.*

### NOTES FROM WYCHWOOD FOREST.

[5292.] The bee season now closing has been on the whole a trying one in this locality, trying to the bee-keeper's patience at the earlier part, as to when the bees were eager to work, but got no chance to do so. Then when a short spell of fine weather did come work began with a rush for a day or two, then interruption again, and more exercise for one's patience; but taken together we have not fared so badly, some of the hives doing fairly well. Now all stocks have plenty of stores for winter, and we plenty of expectations for next year if spared; I say "spared" because we who know the old forest of Wychwood and Charlbury Park adjoining are all reminded by the recent fall of "the King of the Beeches," a tree planted under Evelyn's directions, and which has adorned the fine avenue and had assumed something like national importance as the finest specimen of a beech, tree in England. The renowned old beech, with its girth of stem 22 ft. and with a magnificent head, now lies prostrate, mighty though fallen, on the ground. So we shall come to an end!

*Packing Driven Bees.*—Your correspondents who wrote on this subject lately would do the craft a real service if the different methods employed were described. My way is to get a used box from my grocers, size about 1 cubic foot, when, after seeing that all joints are bee-proof, I empty bees into same, then securely nail on over the top some coarse strainer-cloth, put a strong cord around and across box for a handle, label "Bees with Care," and despatch; and if repeat orders spell "satisfaction," then my bees travel all right.

*Bees in Church.*—The other day when at the village of Great Tew about 7 miles from here, as I wandered round the fine old church I noticed two lots of bees located one on either side of a stone window in east end of the south aisle. The bees had found an entrance through a hole in a badly fitted scaffold pole.—JOHN KIBBLE, *Charlbury, October 22.*

## Queries and Replies.

[3273.] *Fermenting Honey for Candy-making.*—1. I have some sections of honey which show signs of fermenting, and therefore ask—Will you kindly inform me through B.B. Journal if these, when boiled, would be suitable for making bee-candy? 2. Also, how much sugar should be added to every pound of melted honey?—H. F. J., *Clifton.*

REPLY.—Though you write of "boiling" the sections, we assume that it is merely in-

tended to immerse a vessel containing the sections in boiling water till the wax melts and honey liquefies. This being so, the wax queen cold is removed in a cake, and the liquefied honey may be used in preparing syrup-food for the bees, but not for candy-making. You might utilise it by mixing with castor sugar till it forms a very stiff paste, as prepared in America, and known as "Goode's" candy.

[3274.] *Conference of Bee-keepers and Technical Education in England.*—I have read with great interest the report of the Second Conference of Representatives of County Associations and the Council of the B.B.K.A. in the B.B.J. (pages 411-414). For further details I am wishing to get:—1. The report of the First Annual Conference in 1902. 2. Regulations for examinations, quoted on page 412 (second col.). 3. Copy of expert's visiting book, with instructions to expert, on same page. 4. Board of Education: Syllabus and list applicable to schools and classes other than "Elementary," quoted page 413 (first col.). 5. A "Reid honey taster," as advertised in B.B.J. Please say how I may obtain the above.—EMILE ALLETTE, *Marseilles, Le Petit Oise, France.*

REPLY.—1. The three numbers of B.B.J. with report of Conference in 1902 can be had from this office for 4d. post paid. 2. For the items numbered 2 and 3 application must be made to Mr. Edwin H. Young, British Bee-keepers' Association, 12, Hanover-square, London. 4. Any London bookseller will procure this, or it may be had direct from Messrs. Eyre & Spottiswoode, Printers to H.M. Government. 5. This may possibly be sent by sample post; but, if not, it will cost 1s. post free from this office

[3275.] *Outfits for Beginners.*—I wish to begin bee-keeping, and have obtained Mr. Cowan's "Guide Book." I am also taking in your journal, but cannot gather yet what are the bare necessities for a beginner to obtain. The catalogues of makers of appliances are bewildering. Can you help me on with practical advice so that I may afterwards follow it up properly? Or if there be, as doubtless is the case, books suitable for beginners, I shall be glad if you will inform me. Reply to Query 3252 (page 406) of your journal treats of "Starting Bee-keeping," but does not actually enter upon the point of what a beginner needs to get.—E. D., *South Woodford.*

REPLY.—By calling on any leading dealer in bee-appliances you could at once see "A Beginner's Outfit" costing 30s., as staged on the show-bench in competition. Apart from this there is only a swarm of bees needed to start a beginner fairly on his way to success. No practical advice that we could offer in this column is needed, every item of bee-management being dealt with fully in the "Guide Book," which you already possess.

## WEATHER REPORT.

WESTBOURNE, SUSSEX,

October, 1903.

Rainfall, 9 35 in.	Minimum temperature, 32°, on 31st.
Heaviest fall, 1'13, on 11th.	Minimum on grass, 24°, on 10th.
Rain fell on 27 days.	Frosty nights, 1.
Above average, 5 78 in.	Mean maximum, 57·4°.
Sunshine, 102·75 hours.	Mean minimum, 47·1°.
Brightest day, 9th, 8 hours.	Mean temperature, 52·2°.
Sunless days, 7.	Above average, 2·5°.
Below average, 23·3 hours.	Maximum barometer, 30·16°, on 18th.
Maximum temperature, 64°, on 1st and 3rd.	Minimum barometer, 29·10°, on 12th.

L. B. BIRKETT.

*Notices to Correspondents & Inquirers.*

INQUISITIVE (Nantperchellan).—*Poisonous Honey.*—Honey which is poisonous to man has no ill effect on the bees which gather it. —2. Some foreign races of bees imported into this country are said to show a preference for certain flowers not favoured by the native, or common brown bee; but we could never see any evidence of this preference in our own experience of Ligurian and Carniolan bees respectively. In any case, the race of bee cannot possibly affect the quality of honey gathered from the same flowers.

H. SAMWAYS (Llandebie).—*Honey for Show-ing.*—The sample sent hardly equals that to which you refer as coming from Wales; nevertheless, it is very good. With regard to apportioning "marks" on points in your honey, we do not quite like to do this, seeing that the "standard of marks" sent is not the one we should care to judge or award marks by.

C. P. FORD (Leyton).—*Assisting Honey Sales.*—The article you have printed for distribution among grocers is interesting, and should be helpful in the direction indicated. Anything that stimulates the interest of tradesmen in honey and bees is desirable, and we will be glad to have a report of the result of your effort as promised.

BLACK "B." (Lancs).—*Experts' Certificates.*—

1. Particulars may be had from Mr. Edwin H. Young, Secretary, Bee-keepers' Association, 12, Hanover-square, London. 2. The examinations take place on various dates during the season, usually in connection with shows held in the county where candidate resides. 3. The papers containing questions are not published.

## Editorial, Notices, &c.

### BRITISH BEE-KEEPERS' ASSOCIATION

CONVERSAZIONE.

(Concluded from page 444.)

Mr. Cowan (in response to the unanimous wish of the meeting) related some of his apicultural experiences in California. After apologising for the frequency of his speeches that evening, he said that he had spent most of the last four years in the State named, whither he went for the benefit of his health and for rest. He, therefore, did not feel at all inclined to go in for bee-keeping, but as soon as his presence in the country was known, he received numerous cordial invitations to visit bee-keepers and to lecture about bees.

One of the first places he went to was Southern California. Professor Cook had asked him to speak on the "Fertilisation of Flowers by Bees" at a farmers' institute at Los Angeles, where there was to be a conference of delegates from all the Farmers' Institutes in the State, and at which the leading farmers as well as the principal professors from the University were to take part. Travelling in California is very different from what it was here, and the distances are great. The State is more than 900 miles long, and he had to travel over 400 miles to reach Los Angeles from where he was staying, in order to comply with Professor Cook's request and address the meeting. He afterwards attended the annual conference of the State Bee-keepers' Association, where he was welcomed and elected an honorary member. The total population of California is under 3,000,000, and it was evident that they must be very sparsely scattered over such an immense tract of country. Nevertheless, large numbers attended this meeting, and he was able to become acquainted with some of the leading bee-keepers, who pressed him to visit them. At this meeting he gave an account of the B.B.K.A. and what it was doing, and also spoke on foul brood.

There are some very large apiaries in California. One of the leading bee-keepers was Mr. McIntyre, who had 600 hives in one locality. In most parts of America it was impossible to keep so many hives together as this, from 100 to 200 being the number generally kept in one apiary, and others distributed in out-apiaries. Dr. C. C. Miller, he believed, had eight apiaries, while Captain Hetherington owned altogether 5,000 hives located in twenty apiaries. Mr. McIntyre's 600 hives could be seen at a glance, and formed a striking and pretty picture—situated as they were in a canyon, the sides of which as far as one could see were covered with sage bushes. Mr. McIntyre said he had no neighbours, and his bees had all the

pasturage, and this was why he could keep so many in one place. If any one started near him on a small scale he invariably failed, as 100 hives could not be run profitably; but 300 could be worked at the same cost. Mr. McIntyre was one of the largest producers of honey, and had obtained 17 tons of honey from 500 hives, besides increasing his stock to 600. The seasons were not always good, but he had taken as much as 400 lb. from one hive; some years he got nothing at all, and even had to feed. They never had two good years in succession; but a good average usually comes after dry years, because bees located in rocks and trees in neighbourhood die of starvation, and there is more for those that have survived. He considered as a good average 175 lb. all round for each hive one year, 50 lb. the next, and nothing the third year, and possibly feeding might be necessary. Therefore a total average of about 225 was obtained every three years. The rainfall varies from 7 in. to 41 in., and a very dry season comes every seventh year; but at least 14 in. is necessary for a yield of nectar; and if rain comes as late as March good crops are secured. If less than that amount falls during winter the crop is a failure. They obtained similar results as fruit-growers, and could reckon to have one very good season and two pretty good ones every seven years. The price obtained was from 3 to 6 cents a pound wholesale, but an average of 4 cents was considered sufficient to make it a paying industry. The Langstroth hive was here in use, and Mr. McIntyre had a Cowan extractor for eight frames driven by water-power. The principal pasturage was from white and black sage, but he also cultivated twenty acres of orange and other fruit trees. All the apiaries are not so well kept as that of Mr. McIntyre, for commercial bee-keeping in America is not carried on as the industry was in this country. There, of course, the object was to get as many dollars out of the bees as possible, and if time could be saved by kicking the top of the hive off in order to put on a super, that method would be employed without our sentiment regarding the destruction of bees. There was another extensive bee-keeper, Mr. Richardson, who had 1,400 colonies in apiaries of 300 to 400 together in the Simi Valley, and was able to produce 76 tons of honey, 30 tons of which was white sage. He also went to Mr. Lovering's apiary, who had an extractor for six frames, driven by water-power, and a pipe from the extracting-house led to a tank on a lower level, where the honey was allowed to settle and ripen, and was then drawn off into 60-gallon cans for market. He also visited the apiary of Mr. Martin, who kindly accompanied him to several others. They were mostly worked on the same principle, one hive on the top of another, extracting from the supers. Comparatively few sections were sold in the State, extracted honey being chiefly produced as being more easily marketed.

The apiaries were generally situated in mountain canyons far from railways, and the roads were often very bad; they were graded earth roads, and after rain the ruts were so deep that anything fragile suffered, so that there was considerable difficulty in transporting sections. A curious incident happened at one of the meetings where he was explaining why there was such a dislike to Californian honey in England, since so much of it had been brought by Messrs. Thurber to this country adulterated; how in 1879 Hoge, their agent, sent out placards stating that bald-headed gentlemen were wanted to advertise Thurber's honey; how, subsequently, Hoge at the Health Exhibition, after having endeavoured to get the B.B.K.A.'s educational exhibit of samples of his adulterated honeys, with the analysis of each, removed, was himself, together with his goods, turned out by the authorities for representing himself as purveyor to the Queen. After he (Mr. Cowan) had done speaking, strange to say a gentleman in the audience rose and said: "I was in London at the time, and what that gentleman has said is perfectly true; I saw the thing done myself." So that, although 6,000 miles away from home, he (Mr. Cowan) met some one who could corroborate what he had stated. During the honey season the bee-keepers lived in the canyons entirely by themselves. The accommodation, generally, was not suitable for women, and their companions besides the bees were rattlesnakes, of which there were plenty, and if near high mountains an occasional bear or mountain lion, which, however, were tolerably harmless, and would run away. These comforts were, however, poor substitutes for the company of ladies (laughter). The houses or shacks were primitive structures, made of boards brought there, and he had seen frame-houses simply covered with sacking. Mr. Martin ("Rambler," of *Gleanings*) had such a shelter, and used it when he stayed at his apiary. At the date of his visit to this apiary, January 13, bees were gathering from eucalyptus which was in full bloom. They did not trouble about wet very much, as for nine months out of twelve they had no rain; and it was only in the winter that it fell, and, as a rule, at night. An appointment could be made in California for any day with the utmost certainty of its being fine. Bee-keepers had to travel over great distances to see one another, and that incurred great expense; but they were granted cheap tickets to attend their conventions. A single ticket at full fare was supplied with a certificate, which had to be signed by the Secretary of the Association, stating that the bearer had attended the meeting, and, on presenting this at the station, a return ticket at one-third the fare was issued. Bee-keepers made the most of their opportunities at these meetings to exchange ideas, and after the necessary routine business was despatched, the rest of the time was spent in asking questions and

discussions—no papers being read. All the apiaries were very similar, although some were better kept than others, so what he had said would apply to most. One, however, was an exception: it belonged to Mr. Dayton, of Florence, who had 170 hives with entrances at top, thinking thereby to save bees some trouble. Mr. Dayton was absent and could not be questioned as to the management of his bees, but in the opinion of Mr. Martin, who accompanied him (Mr. Cowan), that gentleman was not very successful. The same method had been unsuccessfully tried in this country. The quality of white-sage honey both for consistency and flavour was first class; it was white and clear as water. He thought, however, English sainfoin and clover honey quite as good as this Californian sage honey. Despite the excellent flavour of the latter, he doubted if the English public would prefer it to sainfoin. Eucalyptus honey was not very palatable, and he did not like it. There was no doubt that if Californian honey was imported here pure it would be a serious competitor with ours, but prior to its arrival in England, even sometimes before it reached New York, it was adulterated to such an extent that bee-keepers, who are not guilty of such practices, were trying to obtain a law to punish the adulterators. The shippers and brokers contrived sometimes to make ten gallons out of one gallon of pure honey. In reply to Mr. Weston, who presumed that bee-keepers did not reside at their apiaries all the year round, Mr. Cowan said that the honey was generally all gathered by the end of June. It was hard work in June and July, but after that there was little to do until November, when the bees were visited. The periodical visits lasted for two or three days, except when the taking and extracting honey was in progress. Then the whole time and attention of the bee-keeper was required.

Mr. Scattergood moved a vote of thanks to Mr. Cowan for his able and interesting address, and incidentally remarked that he wished the Secretary could obtain from the railway companies, as was done in California, the "most-favoured-nation treatment" for members attending the bee-keepers' conferences here.

Mr. Sladen seconded the motion, which was also supported by the Chairman, and carried by acclamation.

A similar compliment was paid to the Chairman, after which the proceedings terminated.

## REVIEWS.

*Bee-keeping for Beginners.* By Walter Chitty, F.S.Sc. (London: Kegan Paul & Co. 2s.) This little book of only eighty-seven pages, the author tells us, "has been written primarily for schools and in accordance with the syllabus issued by the Board of Education." He has also "kept bees for about twenty-two years, and has taught the subject in the day school,



and therefore ought to have something to say on the subject."

The book consists largely of extracts from other works, a prominent feature in it being many well-known illustrations from manufacturers' catalogues. After quoting from Pettigrew on the profits of bee-keeping, the author goes on to explain the advantages to be derived from the pursuit, and occupies several pages with extracts from the Rev. G. W. Banccks' pamphlet on "Mead, and How to Make it." However good the various recipes may be, we cannot too strongly deprecate the giving of alcoholic beverages such prominence in a book intended for children, and we should be surprised if the Board of Education would approve of its use in schools.

On the whole the writer is sound in his knowledge of practical bee-keeping, although some of his descriptions are not quite clear, and frequent slips in grammar and punctuation show a want of care that we should hardly expect in a pedagogue. On page 13 perfect queens are said to be "produced on the fourteenth day after the eggs are put into royal cells," instead of the sixteenth, which is the usual time. It is also improper to speak of the queen and worker as "it" and "itself," both being females. Words are too often unnecessarily repeated. On page 17 the word "bees" occurs seven times in six consecutive lines; its mention once would have been sufficient. On page 16, of workers it is stated, "Besides doing all the work, they defend their stores when collected by means of their stings." On the same page they are said to "gather all the honey," nectar, no doubt, being meant. On page 24, speaking of the brood-chamber, we find it stated that it "is reserved for the use of the queen bee to lay her eggs and hatch the brood," but the queen does not hatch brood. No mention is made on pages 25 and 26 of subduing the bees before lifting the super and putting under it the calico, and it is hardly correct to say that they "never find the right place" to "enter the hive by the cones." It is also improper to call a frame "bar-frame," a name long discarded, and only applicable to the frame formerly used in the Woodbury hive. There are several misprints, one on page 35, where it is stated that "the super is full of sections filled with foundation," fitted being obviously meant; another on page 39—"the more tasteful honey is prepared for market" should have been tastefully. On pages 40 and 41, the recipes for preparing food for bees are quoted from the "British Bee-keepers' Guide Book"; but there are no instructions given for preparing the naphthol beta solution which forms one of the ingredients.

A similar omission is also observable on page 44, where a rag soaked in carbolic acid solution (a virulent poison) is recommended for laying over the frames to subdue bees. On page 62 nothing is said as to where the worker comb to be placed in centre of brood-nest is to come from; and on the next page we are told

in uniting to "mix up the bees and frames of one hive with the bees and frames of the other." On page 68, tits and ants are alluded to as being troublesome, and "to cure the birds, fasten a net over the hives, and let them hear a gun occasionally." A page and a half from Pettigrew's book, now long out of date, describing foul brood, is quoted with the author's approval, in which the statement is made, "we may be excused for saying that we are yet to be convinced that it is in its nature infectious or self-communicating, or that it is ever carried in honey from one hive to another." This theory is now conclusively proved to be absolutely incorrect.

The absence of an index makes it difficult for beginners to find the particular information they may require; and the price at which the book is published is high in comparison with the excellent works that are now to be had at less cost.

*The Book of the Honey Bee.* By Charles Harrison. (London: John Lane. 2s. 6d. net.)—Gardening and bee-keeping should go together hand in hand, and we are pleased to see the principle recognised by Mr. Lane, who publishes this, the latest English bee-book, as one of his series of "Handbooks of Practical Gardening." The book well fulfils its purpose. The instruction conveyed is sound and in accordance with the principles advocated in this journal, to which, as a practical bee-keeper, Mr. Harrison is naturally indebted. His quotation (on pages 89 and 90) of Mr. H. W. Brice's excellent system of queen-rearing for amateurs reminds us of the loss we suffer in the enforced absence of the latter gentleman as a contributor.

The photographic illustrations—which are an attractive feature—are clear and good; but a mistake is made in rendering some of them over natural size, as in the plates of "sealed worker and drone brood" and "queen cells." In each of these the worker cells do not run even four to the inch, and the bees are monstrous in proportion. The representation of the queen in another plate is not very successful; for, owing partly to foreshortening of the abdomen, her wings look too long in proportion to the body, which has altogether too dumpy an appearance.

There are a few slips that might well be corrected in a second edition. On page 7, worker cells are said to be about seven-eighths of an inch "in thickness"; on page 22 the name of a well-known Russian bee-keeper is misspelt; on page 24 the letters do not refer to the illustration of the "W.B.C." hive on the preceding page, but to one in the next chapter; on page 69, an omission in the last paragraph but one makes a sentence unintelligible.

Page 8: "The eggs deposited in the cells are of two kinds only, viz., worker eggs and drone eggs, and the queen invariably deposits each in its proper cell, the worker eggs in

worker comb, and the drone eggs in drone comb." What, then, of the numerous drones reared in worker cells? "Invariably" is a dangerous word to use in matters apianian.

The painted calico recommended as a roof covering on page 30 is doubtless a good one, but there is nothing so trustworthy or, in the end, so economical as zinc, and it was a pity not to mention it.

With regard to Chapter III., very few "standard" frames are now made with a bottom bar only  $\frac{1}{8}$ th in. thick, as in the original, the usual measure being from  $\frac{3}{16}$  in. to  $\frac{1}{2}$  in. The saw-cut in top bar is also ceasing to find favour with some. If, as recommended on page 36, a dummy is pushed "close in contact with the metal end of the last frame in the hive," the interspace is reduced too much. It is better to make the deficiency good by using a strip of wood, or some similar device, to prevent bees from attaching the outer face of comb, to the hive side. Although most bee-keepers like to have a bee-veil somewhere at hand, they will not readily agree that it "should always be worn when handling bees" (page 45).

Chapter IV.—"Removing Bees."—There are cases when it is positively necessary to move bees only a short distance, and time cannot be spared to do this by moves of only 2 ft. at a time. It would have been well to point out that this can be done safely by the employment of some obstacle to the flight of the bees from the hive; anything, in fact, that will induce them to take notice of their surroundings.

The second maxim in Chapter VII., "all feeding" is profitable, surely needs the qualification of the word *judicious*. Often enough feeding does more harm than good.

Mr. Harrison's departure from the orthodox method of arranging skeps for driving does not commend itself to us. "The skewers," he says on page 97, "should be inserted from either side of the hive, but only an inch or two apart, so as to form an extemporised hinge." As far as we can understand this sentence, and judging from what he says elsewhere, and from the adjoining plate, Mr. Harrison would have us invert the receiving skep over the already inverted colony, and then drive two big-headed skewers into the rims of both skeps from the outside. He would then proceed to arrange a kind of screen fixed between his driving irons. We much prefer a single small-headed skewer, or a 2-in. French nail, as now taught at Swanley, driven in from *inside* while the skeps are open and the bees in sight. By the time that a beginner had arranged Mr. Harrison's paraphernalia, he would possibly find that many bees, and perhaps the queen, had already gone up.

We have deemed it worth while to make the above criticisms, because the "Book of the Honey Bee," in spite of certain imperfections, is a good and useful work. It is well worth the modest sum charged for it.

## HONEY IMPORTS.

The value of honey imported into the United Kingdom during the month of October, 1903, was £1,894.—From a return furnished to the BRITISH BEE JOURNAL by the Statistical Office, H.M. Customs.

## Correspondence.

*The Editors do not hold themselves responsible for the opinions expressed by correspondents. No notice will be taken of anonymous communications, and correspondents are requested to write on one side of the paper only and give their real names and addresses, not necessarily for publication, but as a guarantee of good faith. Illustrations should be drawn on separate pieces of paper. We do not undertake to return rejected communications.*

*Communications relating to the literary department reports of Associations, Shows, Meetings, Echoes, Queries Books for Review, &c., must be addressed only to "The Editors of the 'British Bee Journal', 10, Buckingham-street, Strand, London, W.C."* All business communications relating to advertisements, &c., must be addressed to "THE MANAGER, 'British Bee Journal' Office, 10 Buckingham-street, Strand, London, W.C."

*\*.\* In order to facilitate reference, Correspondents, when speaking of any letter or query previously inserted, will oblige by mentioning the number of the letter as well as the page on which it appears.*

## NOTES BY THE WAY.

[5293.] After the late rains a week of fine weather has been very acceptable to both bee-keepers and farmers, for, in spite of short days, some part of the latter's harvest has been gathered in, though in such wretched condition as to be, I fear, almost valueless.

The improved weather has also enabled bee-keepers to straighten up the apiary for winter. The bees have had their final honey-flow from the ivy-bloom. I recently noticed hundreds of bees busy on the ivy, so busy, indeed, that an onlooker thought it was a swarm settling till closer inspection showed that the bees were only busy "improving the shining hour."

*The Dairy Show.*—The mention of my name at the "Conversation," and the reference on page 415 in connection with Challenge Cup, induce me to make a remark on the subject. First, then, as to the "Cup." Allow me to say that winning the Cup has never entered my mind as within the range of possibilities. When the giving of a Challenge Cup was first announced, as in the competition, I was ready and willing to enter the lists, but after reading the schedule, and noting the conditions of securing the prize, I saw that success was beyond my reach, and at once dismissed all thoughts of even trying to win. The fact that I won three prizes at the "Dairy" Show with four entries does not identify my name as a competitor for the Cup, as was done in the editorial report on page 415. I may add that the names of others engraved on its sides would so reduce its value in my eyes that I would hardly accept it as a gift—so that the contest this year was most decidedly between Messrs. Seymour and Carver

I was much surprised to see a 2nd prize awarded to the single exhibit in Class 88, as, to my mind, it consisted of nothing interesting to the practical bee-keeper or instructive to the student; it was simply 3 lb., 2 lb., 1 lb., and  $\frac{1}{2}$  lb. sections of honey of medium quality. The 3 lb. and 2 lb. sections are obsolete and unsaleable in the honey market, and the  $\frac{1}{2}$  lb. sections cannot be produced commercially at a profit. I consider the class ought to have been cancelled, according to rule. I hope Mr. Seymour will not consider above comments on Class 88 as personal.

As regards the Tall Section Class, as soon as Mr. Carver's dozen sections were staged I at once said they were the best sections in the show; but this in no wise converts me to the opinion that the tall sections are preferable to the square. Possibly, if placed side by side the tall sections may be preferred by some. Our Editor's remarks on the class were, in my opinion, fair comment.

As regards the square sections, the 1st and 2nd prize ones were better filled than the 3rd; but for transparency mine were far ahead.

As to the "Trophy Class," and the two awards to five entries, I do not think the judges exceeded the limit; in fact, I consider that each of the three staged was worthy of a prize. The fact that the whole of the prizes offered are not awarded in this class has done more to retard the entries than any other one point; and as the B.B.K.A. gives a good portion of the prize money in the honey classes, I think the Trophy Class should be exempted from the rules of the Dairy Farmers' Association. Regarding the number of entries, when we come to consider the labour, expense, and risk attending the staging of a trophy of honey of 1 cwt.—remember, the railway companies will not accept any responsibility for damage in transit, and the exhibit has to be staged by the owner or his representative—this entails one, and probably two long journeys to London, with its attendant expenses.—W. WOODLEY, *Beedon, Newbury.*

### THE PRICE OF HONEY.

[5294.] A letter appearing in your issue for last week, "The Price of Honey" (page 446), caught my particular attention. I feel sure a large section of your readers also noted the remarks made by our friend on this important matter. There may be, and I fear there are, a number of our bee-keeping friends apparently indifferent on this score, to the detriment of the bee-keeper at large; this class are in a measure responsible for the present low prices of honey. I can fully endorse all Mr. Farmer says on this point. Besides the pleasure and enthusiasm which all true bee-keepers evince in their bees, there is another aspect to the matter, which the great majority cannot afford to lose sight of. I refer, of course, to the financial side; this is now becoming a serious matter to them.

Mr. Farmer, I think, gives a very accurate detail of the prices obtained in general for the product from the producer to the retailer. From these figures it can be easily seen how small a margin there is in the business, and least of all to the producer, who, it can hardly be disputed, is entitled to the greatest, for has he not the risk and expense attendant on his stocks, the greatest amount of labour, and, the most important consideration of all, the irregularities of the British climate to contend with, which sometimes means total failure? Yet in spite of the failures in our crop, so strangely constituted is our honey market there does not appear to be an appreciable rise in our prices in such events. So the producer has to bear the full brunt of the failure, and content himself with the results of a good and bad year taken together. The honey market is unlike others in this respect.

The great increase in the quantity and improvement in the quality of honey due to modern methods in apiculture may possibly be regarded by producers in some instances as not fully compensating for the existing prices, but the consumer is clearly a gainer.

Up-to-date appliances represent an item in carrying out modern methods, and bad seasons, as in the present instance, provided for.

With all that has been done by the promoters of the craft for the extension and improvement of apiculture in every iota amongst us, it seems this difficulty they have been unable to grapple with. Our bee-keepers' associations surely have been successful in extending the art in general over the kingdom, and teaching us how to produce; but what a boon they would confer if they assisted us to sell to better advantage! They are evidently powerless in the matter, however, and I fear it is beyond their control.

There is another matter bearing very strongly on this question of prices which Mr. Farmer does not allude to, viz., foreign competition. We need only look at the statistics appearing from time to time in the columns of the *JOURNAL* under "Honey Imports." Much of this honey, we might assume, can be sold at half the price we could afford to offer ours for. The tempting offer is availed of by the merchant, and the public consume it—though in many cases it is classed as very inferior—and are satisfied. The British palate is not in general educated in the flavours of honey.

As to the question of adulterated honey coming into our markets, and so affecting prices, I am unable to offer any opinion; possibly that also may count as a factor.

I fear I have trespassed too much on your valuable space. There is really nothing new in what I have written, but I think giving prominence to these points might possibly produce some fruit.

I hope such of our readers as have honey on hands may not be too quixotic, but do as I intend doing—hold over for a fair price; by

so doing we assist in furthering the object in view.

With best wishes to our bee-keeping friends for season 1904.—C. BEE, *County Louth*.

### SOME YORKSHIRE NOTES.

#### HIVES ON SCALES.

[5295.] I have again weighed a hive at intervals throughout the past honey season, and send you the result. It is the same hive I weighed last year, and reported in B.B.J. of October 9, 1902:—June 20 to 26, increase 5 lb. 2 oz.; 26th to 29th, 3 lb. 12 oz.; 30th, 1 lb.; July 1st, 2 lb.; 2nd, 2 lb. 12 oz.; 3rd, decrease 1 lb.; 4th, increase 1 lb. 9 oz.; 5th, 1 lb. 3 oz.; 6th, decrease 11 oz.; 7th, increase 1 lb. 5 oz.; 8th, 2 lb. 4 oz.; 9th, 5 lb.; 10th, 3 lb. 12 oz.; 11th, decrease 1 lb. 11 oz.; 12th, increase 1 lb. 12 oz.; 13th, decrease 15 oz.; 14th, 7 oz.; 15th, increase 13 oz.; 16th, decrease 10 oz.; 17th, swarmed, swarm returned (scale re-balanced); 18th (weights tampered with—re-balanced); 19th, decrease 1 lb.; 20th, increase 2 lb.; 21st, 8 oz.; 22nd, 12 oz.; 23rd, 12 oz.; 24th, 8 oz.; 25th, 2 lb. 7 oz.; 26th, decrease, 1 lb. 2 oz.; 27th, 14 oz.; 28th swarmed—swarm returned again and supers (shallow-frames) extracted and scale re-balanced for the heather. Net increase, 31 lb. 7 oz. Increase gained at the moors, 9 lb. Total weight gathered, 40 lb. 7 oz.

Though the heather season was disappointing, some of the hives gained considerably more than this one, and all returned moderately stored for winter, and about half of them with a little to spare towards expenses. Taking the season throughout, the surplus from all sources will not be more than 18 lb. per hive, with an increase of one stock in nine. All other swarms returned. One hive lost a quantity of bees owing to that shiny, black disease, and some chilled brood. I should like some of our scientific men to further investigate these two troubles, which I call diseases, whatever others may term them. It would also be interesting to hear of further Yorkshire results.—GEO. DUFFIELD, *Harrogate*, November 2.

### WARWICKSHIRE NOTES.

[5296.] We have had a very poor honey season here, both as regards quantity and quality. I can only compare it for badness to that of 1879.

With us this year bees had to be fed up to mid-summer to keep the stocks strong, and even then they did not reach the point of "boiling over" with bees. Most of the honey was gathered early in July, but it came in slowly owing to cold nights, and the bees showed a decided preference for storing it in the drawn-out combs. I took off many racks of sections, in which the "bait"-combs put in were completely filled and sealed over, while the comb-foundation was not touched at all.

Much of the honey has been dark in colour, but fair in flavour, while a good deal was spoilt by the so-called "honey-dew."

Some light-coloured honey was got, notably in the Nuneaton district, the best of it being in the coal-mining districts around there. But while many in our county have had almost no honey at all, there are a few who have done well—indeed, better than last year.

Since the end of July bees have subsisted chiefly on their stores, and where not fed breeding ceased early, and it was the general rule not to find brood before the end of September. This fact made notable a little recent personal experience. I was examining eight skeps of bees with a view to saving four of them from the sulphur-pit, and found breeding going on in all the eight swarms and old colonies alike—and this without feeding.

Another notable feature of 1903 has been the loss of young queens; after hatching out all right they have simply disappeared. This has been my own experience, and many times in the apiaries of others I have found colonies that had sent out swarms queenless.—GEO. FRANKLIN, *Kenilworth*, November 9.

### INSURANCE FOR BEE-KEEPERS.

[5297.] An accident that occurred near here in August last may be of interest to bee-keepers as showing the need that exists for some method of reducing the responsibility of those who own a few hives of bees. This need has been capably met by the system of insurance devised by the British Bee-keepers' Association, whereby any one, for the modest sum of 1d. per hive, may rid himself of liability in any serious accident that *might* happen under any system of management.

In the case under notice the person (whom it must be confessed had not had very much experience with bees) bought two or three stocked hives of a neighbouring farmer. They were frame-hives, but had been much neglected, and many combs were built cross-wise of the frames. After getting them safely home the buyer was engaged in examining his purchases when one lot more vicious than the others caused him to beat a hasty retreat, which was not to be wondered at seeing that he possessed neither smoker nor subjugator of any kind, and was endeavouring to withdraw frames from these hives that had probably never been through the operation before. This was how matters stood when the baker on his rounds drew up his horse and cart on the scene, leaving his cart in charge of a small boy who was with him, and proceeded to the house as usual. The bees were flying round viciously, as the hives were not more than five or six yards away from the horse and cart with nothing but a low hedge between; it seems incredible that the bee-owner did not prevent the horse from coming so close to them seeing that he was there all the while. However, it was not long before

the horse was stung on the head, and, of course, started throwing its head about endeavouring to rid itself of the insect. This movement caused a general attack by the bees, and the poor brute narrowly escaped with its life, so severe was the stinging. It was with great difficulty that the horse was removed, as any helpers were quickly driven back by bees, and every one came in for a share of the stings. The horse's head suffered more than any other part of the body, and so severely stung were its eyes that the poor brute was blind for nearly a fortnight, and lost the sight of one eye altogether, decreasing its value considerably. This, with the consequent heavy bill for veterinary attendance, would make up a serious total. Of course, no one was really to blame, for the bee-keeper was ignorant of the danger exposed, but undoubtedly he would be held liable for damages. This shows the necessity, so often impressed by our Editors, of would-be bee-keepers obtaining a reliable guide-book on the subject, and making themselves conversant with the subject of which they all desire to become experts.—A. B. FAKIR, *Wisbech*, November 7.

#### ARE BEES TEETOTALERS ?

[5298.] The interesting little point raised by "A. W. B." in his honey label, page 419, and on which "E.D.T." has issued his pronouncement, or interlocutor as we might call it in Scotch law [5269], reminds me of some old recipes for making bee-food, tending to show that bees are not, strictly speaking, teetotalers. "Evelyn's Diary," even under the heading of January, says: "Turn up your hive and sprinkle them with a little warm sugar and *sweet wort*." I do not advise modern apiculturists to try this "feed," neither would I recommend the time nor the method, even although, as Evelyn advises, you *do it dexterously*.

The recipe, as well as the system, seems to have been in vogue in the time of Cromwell, for in Hartlib's "Commonwealth," 1655, we find much the same recommendation, if, indeed, both had not originally the same source. "Turn up your bees and throw in *wort* and water and honey twice or thrice, but let your water be warm." Even with attention to the last point no moderns should try it!

Cotton, in his "Bee Book," touches on this point; but, I think, bases his theory and conclusions on some very ancient bee literature. However, here is what he says on this point: "The bee-keeper must not be given to surfeiting or drunkenness (I agree entirely with him here, and am strengthened in taking such a stand by such diverse authorities as Mahomet and M. Maeterlinck.) "The best bee-master is a water drinker, for bees only drink water." ("Hear, hear!" I fancy Mr. \* \* \* calls out.) Yet he immediately flatly contradicts himself by adding—"Bees are *not* teetotalers, as I

have shown in my first letter, for *beer* and sugar is their best winter food, and a bee-keeper's breathing must be corrected by a cup of small beer." Here, undoubtedly, the flavour of seventeenth-century bee-keeping makes itself manifest, for Butler not only advises the bee-keeper who gives a swarm to drink of the best beer, but also says he should wet his face and hands in it. The saintly Mr. Butler, however, seems to contradict himself, too, for two of the advices he gives to prevent being stung are—first, avoid a stinking breath! and, second, the bee-keeper must not be given to drinking.

Are bees teetotalers?—D. M. M., *Banff*.

#### SCHOOLMASTERS AND BEE-KEEPING.

[5299.] In your condensed report of my speech at the delegates' meeting of the B.B.K.A. I notice you state that I quite agreed with the member from Nottingham B.K.A. in his remarks about schoolmasters. This is not correct. I said I agreed with him in his remarks about children, and emphasised that we had to look to them as the coming bee-keepers. I said that "the schoolmaster would be the best teacher if he could be got to do it, but feared that, with the present demands of the Education Department, he had quite enough to do," &c. I made these remarks *re* schoolmasters after a long experience with many of them. As most lectures are given in a schoolroom, the schoolmaster is nearly always in evidence, and I have always endeavoured to persuade them to take up bee-keeping themselves, but have either been met with the remark "that bees did not like them," or "that their time was so fully occupied that they could not." We have one schoolmaster in our Association with a first-class certificate, and several are local secretaries, and if we could get every schoolmaster to take up the subject in a practical way we should do so. With respect to the two schoolmasters in the last two issues who have so readily got their skeps in evidence, they certainly do not represent the majority of their profession, who are far more courteous and urbane, even if they do not keep bees.—F. J. CRIBB, *Lincs B.K.A.*

#### BEE-KEEPERS IN CONFERENCE

##### AND THE VILLAGE SCHOOLMASTER.

[5300.] As a village schoolmaster and bee-keeper, I wish to protest against the unprovoked and unjustifiable attacks made by certain delegates at the Annual Conference on the character of village schoolmasters generally.

I have been under the impression that the delegates attended the Conference to promote the interests of the B.B.K.A., and of furthering the cause of bee-keeping. It is, however, plainly evident that the line of conduct adopted by these delegates at the Conference

is totally in opposition to the aims of the Association.

Schoolmasters, viewing their profession in the proper light, are only too anxious to engage in any good work for the bettering of humanity. Mr. Rankine, H.M. Inspector, has recently spoken of the elementary teacher as being a missionary of the best kind.

Lord Rosebery has designated teachers as "captains and guides of the future democracy." In defence of my professional brethren, and in order to refute these statements regarding our character, I am open to publish a record of four years' services—three as a practical expert, and one as a certificated expert, rendered entirely free of charge during my stay in Devon—in promoting and furthering the cause of bee-keeping in this and adjoining parishes; and I invite Messrs. Scattergood and Cribb to publish their records of services similarly rendered.—K. D. FLOWER, Second-Class Expert, B.B.K.A., *Ilstington, Devon, November 3.*

#### POINTS IN JUDGING HONEY.

[5301.] In your reply to an inquiry of mine in your last issue (page 450), you state that the "standard of marks" sent was not one you would care to judge or award marks by. The standard alluded to was taken from the list of prizes of the Ayrshire Agricultural Association's 49th Annual Show, held at Kilmarnock on October 22 and 23, 1903. A note at the head of the honey class states that the honey will be judged according to the following standard of points, viz. :—

*Extracted Honey.*—Flavour, 20 points; consistency, 15 points; colour, 7 points; cleanliness and get-up, 5 points; aroma, 3 points. Total, 50 points.

*Comb Honey.*—Regularity of comb, 10 points; completeness of finish, 10 points; colour of comb, 7 points; flavour of honey, 10 points; consistency of honey, 10 points; colour and purity of honey, 8 points; cleanliness and get-up, 5 points. Total, 60 points.

A card showing the points awarded will be affixed to each prize lot."

Would you, Messrs. Editors, or any of your readers who have had experience in judging honey, kindly suggest an alternative "standard," as I believe the matter is one worthy of discussion in your columns? There are at present a large number of shows held, and a large number of judges employed, especially in the small local shows. It therefore follows that there must be a large number of standards of marks, as most judges have their own particular fancy standard.

Why could not the B.B.K.A. Council draw up an official standard of marks for judging honey, as they have done in fixing a standard of measurement for the movable frame, and get this printed in a prominent part of the next edition of the "Bee-keepers Guide Book,"

"Modern Bee-keeping," and also in the B.B.J. and *Record*?

That there is a need for this I believe the above "standard" supplies a striking illustration, and I am certain if every bee-keeper who has acted as a judge would publish his standard of marks, it would be very instructive, and it might be easily possible, from the information thus obtained, to draw up a standard for universal use.—H. SAMWAYS, *Maesybont, Llandeby, November 9.*

#### CLIPPING QUEENS' WINGS.

[5302] I notice in your last issue that you invite correspondence on this subject. I tried this American plan on one hive out of my forty stocks (I have two apiaries), but the swarm issued the week following, and after examining the stock a few days subsequently I found the stock queenless, and the queen, whose wing I had clipped, turned out. The queen was not injured in any way, but what I imagine took place was this. The old queen left the hive, and, finding that she was unable to fly, tumbled off the alighting-board, and the new queen took her place and left with the swarm. I tried this plan about six years ago, and met with no better success. The secret of success is giving plenty of room below the brood-chamber; and I find Simmins' "Conqueror" hive the best for this purpose, especially if you work for run honey on a large scale, as I do. I prefer the "W.B.O." hive for sections. I notice many bee-keepers complain of the bad season of 1903. Was it the fault of the weather or their masters? In nine cases out of ten I should say the latter. All my stocks were strong and ready for the first flow of honey, and between the showers the honey simply poured in. It has been my best season for years. My advice is: Keep your colonies strong and vigorous by introducing every year new blood; take no honey from the brood-chamber; only keep strong colonies (weak ones are worse than useless—they invite disease); feed *gently* in the spring until the honey-flow commences.—JOHN J. KER, *Southridge, Harlow, Essex.*

#### MOOT POINTS IN BEE-KEEPING.

[5303.] As an old bee-man of about thirty years' experience, I have long thought of writing to you on a few disputed points affecting the art and mystery of bee-keeping that the experts of the craft have not as yet authoritatively settled for us laymen. The last communication (5281, page 444) of your esteemed correspondent, "D. M. M.," has brought me up to the scratch. His observations on the Ligurianising of a stock are most interesting and, if accurate, surprising. The statement that "their industry, unless on very fine days, was less marked than that of the natives, and apparently they were content with enough stores

to "keep the house, going," is rather in the nature of a revelation. This, indeed, is "faint praise," amounting to a condemnation of Ligurians. If this is so, I shall still continue in the old track, content, as I have hitherto been, with the native British bee, though I have often thought I should like to Ligurianise one stock as an experiment.

I suppose, as progeny of a fertile Ligurian queen, they are pure Ligurians. Will the next generation, or first cross in the breed, be more energetic workers, and not so quiet and amiably disposed towards their master?

The second "moot point" I wish to call your and your readers' attention to is the question of quilts *in winter*. Some beekeepers advocate impervious damp and heat proof, such as American leather cloth, celluloid, or other similar material, as coverings, keeping the entrance open full width for ventilation. Personally I prefer porous materials, such as hair, felt, or flannel, with the entrance closed to half an inch opening. The next disputed point is as to syrup-making. Some maintain that there is no need to boil it, merely dissolving the sugar; and this is all that is absolutely necessary.

I admit these are minor matters connected with the craft. They may not mean complete success or failure whichever are adopted, but I think it will be granted that there is a right and a wrong way of doing most things, and that the wrong way means so many points below the highest standard of excellence that it is possible to attain in the direction of perfection, whatever may be the work that is undertaken.

I am pleased to be able to report that, considering the wet and unfavourable season, my five stocks gave me a return of 219 lb. of surplus honey, leaving the stock hives untouched full of sealed honey for the coming winter. The strongest stock yielded 78 lb. surplus in the shape of a super of eleven standard frames, 64 lb. 11 oz. gross, with a rack of twenty-one sections on the top—these were not all quite full. I attribute the result to careful attention in the early spring by stimulative feeding through one hole of the feeding-stage from February till about the end of May. I depend principally on lime-tree blossom which comes into bloom here about the middle of July or a little later, according to the season.—A WORCESTERSHIRE BEE-KEEPER, *November 9*.

## Queries and Replies.

[3276.] *Out-Apiaries and Short Stores for Winter*.—I have one home and two out apiaries; but, owing to an accident, have been unable to do anything since I took the supers off in August. At that time some of the stocks were so strong that I had to leave racks

of shallow-frames for their use. I have only now been able to get at them, and find that some of the bees are still in the supers left on, in which they have stored honey, although nearly all of them are short of supplies. It is too late to feed with syrup, and I cannot attempt to supply the out-apiaries with candy, as I am unable to see to them during the day. I have read somewhere about dry-sugar feeding. If I were to nail a board on each side of a brood-frame to within half an inch of the top, and fill in with sugar, would that answer the purpose? And, if so, what kind of sugar is most suitable, and how much should I have to give a stock of eight or ten frames, which only has about five or six pounds of stores? And what will be the best method of dealing with bees still in supers?—W. J. G., *York, November 9*.

REPLY.—Your best plan will be to see what amount of stores are really needed to carry each stock over winter. Unless this is done, it will be more or less guesswork in apportioning the supply to the separate colonies. With only 5 lb. or 6 lb. on hand, we should give the stock a 4-lb. cake of well-made soft candy, and this would suffice till February, when another inspection must be made. If you prefer to feed with "dry sugar," and use a feeder, as proposed, the frame arrangement named will work if placed close to the cluster of bees. Porto Rica sugar must be used.

[3277.] *Non-Swarming Hives, Transferring from Skeps*.—I am a beginner at beekeeping this summer, and have got three strong stocks of bees in straw skeps. In the spring I intend moving them into frame-hives, and I also want, if possible, to prevent them from swarming, and to confine them, for the first season at least, to the above number. I have been studying the description of non-swarming hives, both in the "Guide Book" and in makers' catalogues; but I must say that their construction and manipulation is not at all clear to me. Perhaps I shall make my difficulties more clear by putting the following questions:—1. Does the efficacy of a non-swarming chamber lie in its position below the brood-box, as opposed to an ordinary crate of shallow-frames placed above the latter? 2. On page 43 of the "Guide Book" we are told to remove the frames in the non-swarming chamber as soon as the bees are well at work upon them, to place them above the brood-box, and to substitute another set of frames. Does this mean that the non-swarming chamber is intended only for workers and the purposes of extracted honey, and not as an enlargement of the brood-box for purposes of brood-raising? If this is so, ought the queen to be imprisoned in the brood-chamber between two sheets of excluder, above and below?—J. P., *Walton-on-Thames*.

REPLY.—1. The principle involved in the use of a non-swarming chamber is to induce the bees to extend the cluster downwards, and

so prevent overcrowding the brood-nest. In doing this they begin comb-building in the lower chamber, and, when fairly started, the litter is removed and placed above frames of brood-rest, thus affording the "room in advance" that serves to check the swarming impulse. 2. The above will explain your second question.

[3278.] *Bees Refusing Comb-Foundation.*—Will you kindly give me your opinion of the enclosed sample of comb-foundation? It was fixed in whole sheets in grooved sections, but the bees simply gnawed it off on both sides and at top, and never attempted to draw it out or work on it in any way. I therefore ask—1. Is there anything used in its manufacture which would make it obnoxious to the bees? 2. Do you know of any other reason why the bees should treat the foundation in this manner? 3. Having a quantity of this same foundation left on hand, would it be wise or reasonable to use it next year?—EGMONT, Sutton.

REPLY.—1. We have examined the sample of foundation, and find that it is composed of beeswax; but the quantity sent is not sufficient to make a complete analysis. 2. White foundation sometimes contains traces of chemicals used in bleaching which are obnoxious to bees and cause them to refuse it. 3. It would scarcely be advisable to use this foundation next year, seeing that your bees have already refused it.

### Notices to Correspondents & Inquirers.

Letters or queries asking for addresses of manufacturers or correspondents, or where appliances can be purchased, or replies giving such information, can only be inserted as advertisements. The space devoted to letters, queries, and replies is meant for the general good of bee-keepers, and not for advertisements. We wish our correspondents to bear in mind that, as it is necessary for us to go to press in advance of the date of issue, queries cannot always be replied to in the issue immediately following the receipt of their communications.

T. EDWARDS (Ayrundel).—*Statistics on Honey Production in the United Kingdom, with Amount Imported.*—No statistics are available with regard to honey produced in England, Scotland, or Wales, but in Ireland returns are to be had from the Board of Agriculture (Ireland). The amount of foreign honey imported into the United Kingdom appears every month in our pages, and the total imports are published once a year. In this way we find the total value of honey imported in 1901 amounted to £42,837, and the total for 1902 was £27,116.

W. A. (Southampton).—*Making the "W.B.C." Hive.*—The new edition of the "Bee-keepers' Note Book" will contain full details of measurements to scale, along with plan and elevation. You had, therefore, better defer starting operations till the book appears. You will then need no help in this column.

QUEEN-REARER (Birmingham).—*Number of Hives in a District.*—So much depends on the bee-forage of a district that no general average can be arrived at. Some localities will support a hundred stocks of bees and yield surplus besides, while others would hardly keep alive the bees of a single hive. *Queen-rearing.*—The best book we know of is "Queen Rearing," by G. M. Doolittle. *Artificial Heating of Hives.*—The method of heating must depend on the hive used. Any means of raising the temperature may be adopted, so long as the heat can be safely controlled and regulated.

SUBSCRIBER (S. Wales).—*Non-Swarming Chambers in "W.B.C." Hives.*—1. The non-swarming chamber of the above hive is an addition which "W. B. C." can claim no share in devising. In fact, he has had no experience whatever of that method of preventing swarming. 2. If we possessed such a hive, we would remove the non-swarming chamber with its frames of comb, and pack them away indoors for winter, taking care to exclude moths. (See reply to "J. P.," on page 459.)

C. B. (Aylesbury).—*Transferring Suspected Stocks.*—1. There is no trace of brood or of disease in either piece of comb sent. The sample cut from skep is black and old, but seems perfectly healthy; and there is no need of fear in allowing the bees to transfer themselves from skep to a frame-hive in spring. 2. The other sample of comb cut from a frame-hive is new, and has never been bred in, the substance noticeable in some of the cells being only mildewed pollen. In future, please enclose letter along with samples, not in separate envelope.

DEAN (Kimbolton).—*Frames for Sections.*—Without specifying names we might say, if you procure samples of hanging frames from makers who have taken prizes at leading shows they will probably fulfil your "wish to have the best in the market."

### Honey Samples.

WESTBURY (Shrewsbury).—All your samples have granulated. No. 1 is very coarse in grain; flavour, fairly good; aroma, fair; colour, only medium. No. 2, smooth in grain; flavour, better than in No. 1; very little aroma; colour, very good. No. 3, fair in grain; flavour, only medium; colour, poor. No. 4, good in grain; flavour about equals No. 2; aroma, none; colour, same as No. 1. We class the samples as follows:—No. 2, 1st; No. 4, 2nd; No. 1, 3rd (if liquefied); No. 3, 4th.

\*.\* Several articles are in type and will appear next week, including "Bee Notes from South Africa," "Sending Queens to South Africa," and "Derbyshire Notes."



## Editorial, Notices, &c.

### HOMES OF THE HONEY BEE.

In response to inquiries relative to the absence of "Homes of the Honey Bee" for some weeks past, we beg to say it was owing only to the pressure upon our space through the report of proceedings connected with the British Bee-keepers' Association, and that the bee-garden pictures will be resumed next week and continued fortnightly as heretofore.

### BEE-KEEPING.

ITS EDUCATIVE INFLUENCES.

By *W. H. Harris, B.A., B.Sc., C.C.*

#### INTRODUCTORY.

Robert Louis Stevenson, in his charming sketch "An Old Scotch Gardener," tells us:—"In regard to bees he was rather a man of word than deed, and some of his most striking sentences had the bees for text:—"They are, indeed, wonderfu' creatures, mem," he said once. 'They just mind me o' what the Queen of Sheba said to Solomon—and I think she said it wi' a sigh—"The half of it hath not been told unto me."'" This is literally true even now, though for fifty years substantial efforts have been made in this country to extend a knowledge of bees and bee-keeping. The scientific and the commercial aspects of the subject have secured a large share of attention, chiefly through the careful and persevering work of the British Bee-keepers' Association and its daughter institutions. The parent society has been ably officered by men and women who have had at heart the welfare of the people in country districts. The general results have been the discarding of the old and wasteful methods of bee-keeping; an immense extension of the numbers of bee-keepers and their stocks; a manifold increase in the amount of honey and wax secured; and the establishment of considerable factories for apicultural apparatus in various parts of the United Kingdom. More than this, bee-keeping has been raised to a sufficiently important position among our minor rural industries for many County Councils to make annual grants for its promotion in the areas over which they hold jurisdiction. By means of such pecuniary help lectures are delivered in the smaller towns and villages; and visits by qualified experts are made to apiaries, to give instruction in modern methods of management, to offer advice on various practical matters, to point out the signs and existence of malignant disease in stocks, and to indicate means of cure or eradication.

At horticultural and agricultural and other industrial shows, bee produce and apparatus are exhibited, prizes are given, sales of exhibits

are effected, and numerous orders for larger consignments of goods are received. By these means, and by the weekly publication of an admirable journal, devoted entirely to the interests of apiculture, a very great stimulus has been given to both the science and the art of bee-keeping. And yet "the half hath not been told." As we have said, the economic and commercial aspects of the subject have been receiving a fair amount of attention and development. There is, however, another and by no means unimportant point which has not yet been duly recognised. We refer to the educative influences of bees and bee-keeping. At the present time, when the newly constituted Educational Authorities are realising that in several Continental countries apiculture holds a definite place in the curricula of the elementary schools, and when this example is being followed in many of our own rural parishes, it appears opportune to point out the almost unique position among outdoor pursuits which apiculture holds in the special direction to which we desire to call attention. Poultry-rearing, vegetable and fruit growing, the cultivation and marketing of flowers—all excellent occupations, and admirable means of gaining a livelihood or of adding to income—may also have by no means insignificant effects on the minds and characters of those who devote themselves to these pursuits; but in this respect we believe it can be shown that they must yield the palm to bee-keeping. If this be so, it will be of interest to education committees, to school managers, to teachers and to scholars to be shown that in fostering what is, on the one hand, a fascinating and useful hobby, they are, at the same time, giving and receiving physical, mental, and moral good. To the elucidation of this fact the following papers will be devoted.

From what has just been said it will be rightly inferred that our subject will have a special reference to young people. But while this is the case, it is by no means limited to them. Adults who, at very various ages, have taken up bee-keeping will be the first to acknowledge their obligations to its pursuit. They have found in it a welcome diversion from their usual occupations. They have enjoyed knowledge acquired from the simpler literature on apiculture. They have found much pleasure in their own observations and experiences among their hives. They have been interested in comparing notes with their fellow-craftsmen. They have had a wholesome spirit of emulation stirred within them by the remarkable successes of exhibitors at shows, or by those of their near neighbours. In many instances, they have had the satisfaction of distinct pecuniary profit, to say nothing of abundant supplies of honey for family use; and last, but not least, they have found opportunity for a never ceasing practice of the old proverbial saying, "Live and learn."

But with regard to boys and girls, it may be urged that little can be usefully done in

the way of apicultural instruction till their school-days are over. This is the greatest possible mistake. Experience proves that where teachers themselves possess a practical knowledge of bee-keeping, and are provided with proper apparatus for imparting what they know, children display great eagerness in learning, and soon desire to turn their knowledge to good account. Moreover, there is the additional advantage that bee-keeping is adapted equally well for girls and boys. The breeding of rabbits, fowls, ducks, geese, and pigeons will always have, in the eyes of parents, certain drawbacks for young children, but no such disability attaches to bee-keeping. From all points of view, as we hope to show, it is a thoroughly commendable subject of instruction and object of pursuit.

#### PHYSICAL EDUCATIVE INFLUENCES.

Were our subject the wider one of the *physical benefits* of bee-keeping, we should point out the fact of its being an outdoor occupation, and so, in its nature, conducive to health. This might be further emphasised by the consideration that it does not necessarily involve any exposure to bad weather, such as is entailed very often in poultry-rearing and in the growing of flowers, fruit, and vegetables. The bearing of these points on the practice of apiculture by women will be easily seen. A negative, but not unimportant, matter in this connection is the absence of worry as to regular feeding and keeping clean, which the care of most animals involves. Then another thing of consequence as regards health is that bee-keeping on a moderate scale leads to a certain amount of exercise, which need not be prolonged to downright fatigue. A further advantage is the restfulness of brain and nerve which comes from a pleasant hobby—a change from one's ordinary and absorbing occupation. We might go on to speak of the usefulness of honey as a nutritive and easily-digested food, and as a remedial agent of no mean value in bronchial and other pulmonary maladies. But we must remember our more restricted subject, and proceed to deal with it. First, *the keeping, the manipulation, and the management of stocks of bees educate both eyes and hands.* There is a scientific axiom that "the eye sees only what it is trained to see." The truth of this is exemplified in the fact that observations and distinctions which seem perfectly commonplace to experienced bee-keepers are very far from being plain and easy to the novice. For example, an ordinary onlooker would fail to recognise immediately drones from workers, and queens from both. The detection of a queen running into a hive in the midst of a swarm, or even the pointing to her as she rests or walks in the midst of her children on a crowded frame, requires considerable practice and sharp eyes. Then there are many points connected with swarms which serve for training in observation. Still further, there is much to be learnt as to the sources

which are being used by bees for nectar-gathering. This can be known by remarking the colour of the pollen-balls carried into the hives by the foragers. Yet again, the conditions of combs, the varieties of cells, with their differences in capping, furnish another field for observation. Beside these points, there are others afforded by eggs, larvae, pupæ, and freshly-hatched bees. All of these matters are quite within the power of children to learn, while to adults they will furnish pleasure of mind and growing skill in discernment. But all the points we have mentioned are only like the alphabet of apiculture. There are many others of importance connected with the presence or absence of queens; the rates of increase in different stocks; the times for giving or withholding extra room by "supers"; the filling and removing of the latter; the amount of stores in the hives, and the need of supplying food, or not doing so; the signs of various diseases to which bees are subject; and many another circumstance which only a well-trained eye can determine. But enough has now, we think, been said to show that bee-keeping affords a continuous education for the eyes. We might add that the ears also come in for a share of skilled exercise; for the experienced apiarian has to learn the differences in the flight-sounds of drones and workers, and in their "hum" the buzz of anger or the note of peace. Then there are the "pipings" of virgin queens; the sounds of contentment or of distress characteristic of swarms when being hived with or without their queen—all of which may be the means of training for our auditory organs.

Again, the manipulation of frames in fully-stocked hives will furnish opportunity for gaining neatness and skill in the use of fingers and hands. The furnishing of frames and sections with "foundation"; the uncapping of sealed combs preparatory to extracting their honey; and various other operations require considerable deftness and a fair amount of teaching and training for successful accomplishment.

All we have hitherto said applies equally to boys and girls, men and women, who may take up bee-keeping. There is, however, another class of operations specially suitable for youths and adults of the male sex. We refer to the making of hives and other apparatus. In the best handbooks relating to apiculture full particulars are given as to materials, dimensions, putting together, and all other points of importance. A little practice in the use of carpenters' tools, a careful eye to detail, and a patient following out of printed instructions are all that is necessary for a successful beginning. Pleasure and pride in one's own handiwork, coupled with the knowledge gained by mistakes, will soon tell in the production of constantly improving work, and all the time an educative process of distinct value will be going on. For those who may for the present be unable to use rule, and saw, and plane,

but who would like to have a hand in hive-making with a view to doing the complete work in the future, appliance-makers furnish wood already cut to the right dimensions, and needing only to be put together with nails or "dovetailing."

This matter of handiwork merits much attention. Its importance may be seen in various ways. It affords healthy exercise; it occupies spare half-hours or hours which might be either wasted or less usefully employed; it yields a very distinct pleasure, which increases with every advance in skill and accomplishment; it calls forth ingenuity and the power of planning; it frequently leads to thrift without sacrificing efficiency; and from every point of view it possesses much to commend it.

For girls, skill of fingers may be acquired and used in the putting together of frames and sections; in the fixing of "foundation"; in filling, labelling, and preparing for storage or sale screw-cap bottles; in cleaning propolis, &c., from sections, and glazing and otherwise getting them in good condition for marketing.

This much will suffice for "the physical educative influences of bee-keeping."

(To be continued.)

## Correspondence.

The Editors do not hold themselves responsible for the opinions expressed by correspondents. No notice will be taken of anonymous communications, and correspondents are requested to write on one side of the paper only and give their real names and addresses, not necessarily for publication, but as a guarantee of good faith. Illustrations should be drawn on separate pieces of paper. We do not undertake to return rejected communications.

Communications relating to the literary department, reports of Associations, Shows, Meetings, Echoes, Queries, Books for Review, &c., must be addressed only to "The Editors of the 'British Bee Journal,' 10, Buckingham-street, Strand, London, W.C." All business communications relating to advertisements, &c., must be addressed to "THE MANAGER, 'British Bee Journal' Office, 10, Buckingham-street, Strand, London, W.C."

\* \* \* In order to facilitate reference, Correspondents, when speaking of any letter or query previously inserted, will oblige by mentioning the number of the letter as well as the page on which it appears.

### AMONG THE BEES.

#### SOME WINTERING STATISTICS.

[5304.] How do we in this country stand in the matter of successful wintering of bees? Any man who asserts that, over a series of years, he pulls through anything like 100 per cent. of the colonies he has winter packed might not perhaps have his veracity questioned, but I should look upon him as a man to be envied. Bees during a long siege from cold, lasting it may be, with an occasional short flight, for six months, are subject to so many climatic and other vicissitudes, and bee life, like human flesh, is heir to so many ills, that accidents must be duly reckoned with. The whole success, and indeed existence, of the colony, depending as

it does almost entirely on one single unit, is subject to accidents which none of us can anticipate; and so I always reckon on a fair proportion of deaths when the time for the "roll-call" arrives. Glancing back for a series of years, I am inclined to consider 90 per cent. of survivals as a good, fair average. In the only available statistics I am able to produce, where we have reliable facts covering a wide area, I find, under varying and dissimilar surroundings, not only a wonderful uniformity, but also a strong confirmation of my own estimate. I find a drop of almost exactly 1,000 in every 10,000 hives in all the four Provinces of Ireland, and the figures work out to something like 11 per cent. of deaths over the whole island. Leinster and Connaught show about 10 per cent., and the other two Provinces nearly 12 per cent.

Comparing the number of hives winter-packed with those which have survived until the advent of spring has made it pretty certain that they may be safely reckoned on to prove valuable assets to their owners, we have the following:—

Province.	Hives Winter Packed.	Hives Spring Count.	Deaths During Winter.	Per Cent. of Loss.
Leinster ...	11,246	10,227	1,019	10
Connaught	5,161	4,666	495	10
Munster ...	10,668	9,423	1,245	12
Ulster .....	11,893	10,477	1,416	12
All Ireland	38,968	34,793	4,175	11

Although several counties show a considerable dissimilarity, it will be observed that in all the Provinces there is a remarkably uniform death rate.

It may be interesting to make a comparison between skeps and frame-hives. It is often claimed for the former that they are a safer home for the bees, and that they winter better and survive in greater numbers and in better condition than in wooden hives. I do not think the following tables will bear out the truth of the statement, as it will be seen there is a considerable discrepancy, telling largely in favour of the newer order of things:—

#### FRAME-HIVES.

Province.	Winter Packed.	Spring Count.	Deaths.	Loss per Cent.
Leinster ...	5,576	5,192	384	7
Connaught	3,350	3,122	228	7
Munster ...	4,742	4,220	522	11
Ulster .....	6,706	5,998	708	10
All Ireland	20,374	18,532	1,842	9

## STRAW SKEPS.

Province.	Winter Packed.	Spring Count.	Deaths.	Loss per Cent.
Leinster ...	5,670	5,035	635	11
Connaught	1,811	1,544	267	14
Munster ...	5,926	5,203	723	12
Ulster .....	5,187	4,479	708	13
All Ireland	18,594	16,261	2,333	13

In comparing the two tables, one or two points obtrude themselves on our observation. Ulster, with its 6,706 frame-hives and 5,187 skeps, has the same number of deaths, 708 in each case, with over 1,500 fewer skeps. What have the advocates of the old régime to reply to this? Connaught gives an even more emphatic denial to their pet theory, for its 3,350 frame-hives show a loss of only 228, or barely 7 per cent., while its 1,811 skeps succumb to the number of 267, or fully 14 per cent. Leinster shows a difference of over 4 per cent. in favour of the frame-hive, and Ulster approaches that number. In Munster the loss is pretty nearly equal. Taking the whole of Ireland, we find that bar frame-hives account for barely 9 per cent. of the deaths, while the straw skep has about 13 per cent. to its credit.

It might serve no wise purpose to analyse the loss in the various counties, but several of them show over 20 per cent. of deaths in straw hives, against barely 2 per cent. in the other class, amongst them being Leitrim and Kildare.

I had no preconceived notions in favour of the frame-hive when I started to investigate this question, and, indeed, had no idea that matters would turn out, as they have done, so very decidedly in favour of the more modern homes of the bees, but the more I looked into the subject the more convinced I became that, if statistics can teach us anything, they here prove that the straw skep is not all its advocates plead for it in the way of a favourable home for wintering bees. Put into bare bold figures, it stands on the wrong side as 13 to 9. In honey-gathering it lags behind its rival as 5 to 9, and in wax-producing it figures out at about 6 to 9.

I sigh for a time when we in Scotland, and you in England, may have statistics, somewhat similar to those I have been analysing, available to show us how bee-keeping is progressing in our countries; but that and the fostering care of the industry so widely diffused in the Emerald Isle are denied us. I feel that many parts of the Highlands of Scotland would be vastly benefited by a body like the Congested Districts Board supplying bees and bee-hives at cost price, while an expert drawing attention to the pursuit and

showing how it might be carried on profitably would prove a blessing to many. Meanwhile many proprietors might do a great deal of good by assisting their cotters, crofters and small farmers to start bee-keeping on proper lines. Of old the Royal Society and the Highland and Agricultural Society gave a considerable amount of fostering care to apiculture, but now they rather ignore it altogether or throw cold water on its promulgation.—D. M. M., *Banff*.

## BEE NOTES FROM SOUTH AFRICA

BY A BRITISH B.K.A. EXPERT.

[5305.] It is now some time since I saw any notes of bee-keeping in the B.B.J. from South Africa, and, with your permission, I would like to let my friends in the Old Country, through the JOURNAL, know that I am alive and well. It is not from want of thought or loss of interest in the craft that I have not written you before, but entirely from want of time. Though I spent a busy life in the Old Country, there is much more to occupy my time here. To succeed here in Africa, above all other places—especially in agriculture and pursuits connected with country life—very much depends on personal effort; and it is the all-round man who is likely to be successful. The great trouble here is to get reliable labour, and you must be prepared to turn your hand to anything that has to be done. Here at Bog Farm, which is near the coast, we have had a moderate rainfall; but at Wagon Drift Farm, our other place about twenty miles further inland, we have had very little rain for twelve months past; consequently, we had to pump water the whole time for irrigating purposes. But, notwithstanding all the disadvantages, life here is to me more interesting than at home. Our farm at Wagon Drift comprises twelve thousand acres, and what with sheep, cattle, ostriches, along with flowers, fruit, and vegetables, we have plenty to occupy our time.

The ostrich breeding season is on just now, and the birds require a lot of attention. We have a good deal of trouble with the jackals,—they are so apt to eat the eggs. The ostrich egg has an exceedingly thick, strong shell, but the jackal manages to break it by rolling the eggs one against the other. Again, when the egg safely hatches, we have to bring the chicks to the homestead, and generally put two or three broods under the care of one hen. At this age the ostrich chicks are very pretty and interesting to look at; but as they get older we have to cut or thin out the wing feathers. To do this we have to gather the birds on horseback and drive them into the kraal. When collected, the feathers are sorted and sold for use at home and abroad. In this way ostrich rearing is quite a branch of farming in itself. But I must come to the bees.

I notice, from what has appeared in the B.B.J. of late, many items of interest relating to what has been taking place at home. In

the first place, I see the insurance scheme ; and when my bees did wrong here, I thought what a misfortune I was not insured ! I was cautioned when first I came here to Bog Farm about putting the bees near the house and near the poultry runs ; they told me the African bees sometimes went mad ! and, without rhyme or reason, would at such times come out and sting anything living within their reach ; but remembering that our bees at home seldom proved an annoyance unless badly managed or disturbed unnecessarily, I thought it was the unskilful handling that made the bees vicious here ; but I had it proved to my cost that this was not so, as the following will show. One morning when I was away at market, from no cause that I could see, the bees came out of nearly all the hives and stung the poultry all over the farm, on all sides. When I arrived on the scene and saw the havoc—please forgive me, Mr. Editor, but I felt like piling the hives in a heap and burning the lot ! This feeling was, however, only temporary, and soon passed away. I moved the hives to a corner of the farm, a long way from the house and fowl-runs. But I found Bog Farm district to be a poor one for the bees, and, in consequence, they have not been a success. I am sorry for this, because there is a splendid sale here for comb-honey. I hope soon to remove the apiary to our Wagon Drift Farm, where I expect there will be better bee-foreage. Should it prove a good district, I will let you have some notes later on. Meanwhile, I have plenty to interest me.

I sent you a copy of the *African Poultry Journal* last week, with some notes on one of my dogs which I have trained to catch the fowls for market. I am also enclosing a newspaper cutting, wherein you will see that bee-keepers generally can adapt themselves to other pursuits besides bee-keeping.\* We were successful at four shows last year in winning 105 1st prizes, seventy-three 2nds, along with five cups and six specials. My only regret was that I had no honey to show. Just fancy seeing good prizes and almost no competition ! You know what would be an enthusiastic bee-man's feelings, and can guess mine.

I have been much interested in the discussion in the *JOURNAL* respecting the B.B.K.A. "Standard," compared with a deeper, frame, and have seen nothing in the argument to convince me that a deeper frame is an advantage ; and I would warn my brother bee-keepers at home to be very careful about changing without being quite convinced that the change meant substantial gain all round. The most irritating thing I ever had in my long experience of expert work in England was in dealing with hives fitted with frames not of "Standard" size. When I had to make an artificial swarm, or equalise the food in different hives, and the frames would not interchange, it was as annoying to myself as it was to the bees, and that is saying enough.

\* Not yet to hand.—EDS.

Regarding the tall sections now talked about, I fail to see any advantage either to bee-keeper or bee. I hear very little from my old association, the "Bristol and District B.K.A." I suppose it is still in existence, as I continue to send my annual subscription. Nothing would please me more than to turn up at one of their shows and have a chat with old friends.—JAS. MARTIN, late Expert, Bristol B.K.A., *Bog Farm, Walmer, Port Elizabeth, October 4.*

#### SENDING QUEEN-BEES TO SOUTH AFRICA.

[5306.] The following letter, addressed to Messrs. Abbott Bros., Southall, will be found interesting to many readers, and we are glad to have the opportunity of publishing it in our columns.—[EDS.] :—

"MESSRS. ABBOTT BROS.

GENTLEMEN,—I am pleased to tell you the result of our venture with the queens. Our outward journey occupied four weeks, and I had great fears as to the store of food holding out. Immediately on leaving Tenerife I arranged with the purser to place the bees in his room on the upper deck, where they would have plenty of fresh air and sufficient darkness to prevent their being disturbed. In the passage from Cape Town I managed to get them put in a reserved corner of the compartment under my own supervision.

On arrival here my brother and I lost no time in examining the packages. The first cage opened revealed a failure—stores exhausted, bees all dead ! No. 2 seemed much in the same condition ; but over the dead workers the queen was seen crawling quite contentedly. Matters improved as we continued our investigations, and the ultimate result was fifteen queens alive and five dead !

My brother only retained one of the queens, which was successfully introduced after twenty-four hours' confinement. The gentleman most interested in the consignment unfortunately entrusted the introduction of his lot of queens to a Transvaal bee-keeper, whose idea was confinement for four or five days ; and I believe he has lost a number through this exaggerated idea. This bee-keeper ranks as a 'professional' here, and his opinion is that the queens were not fertilised, &c. I intend visiting the apiary shortly to form my own opinion. Apart from this, the undertaking from beginning to end was a unique one. From the result I should think less worker-bees to accompany the queens would have been better for such a long distance. Otherwise your packing was splendid. If you think it worth while to mention this matter in the *BRITISH BEE JOURNAL*, I should feel obliged for a copy. Meanwhile, I must thank you for your care and interest on my behalf.—I am faithfully yours, EBENEZER McNALLY, *Randfontein, Transvaal, S.A., September 26."*

## BEES IN ROSS-SHIRE.

[5307.] Another bad season! Lack of sunshine made bee-keeping a non-paying business last year, this time superabundant moisture performed the same kind office. Since the bumper year 1899 we have had three bad seasons, and the local members of the craft are somewhat tired of keeping their bees alive. One man gave his bees 6 stone of sugar last year and got nothing, this year with the same outlay the return was 5 lb. honey and no swarms. Swarms have been less numerous, which is quite fortunate seeing that they did not gather sufficient to build out their brood-combs, and are so scant of stores that not one of them will live over winter.

The real honey flow came on here very early when bees were able to do little more than care for the rapidly extending brood-nest. It seems that bee-men in the South were compelled to keep on feeding until end of June.

That is the usual procedure here during normal seasons, so it was a pleasant surprise to find feeders neglected in May. With brilliant weather there was quite a boom in the apiary, and by the last week of the month honey was coming in fast, drones on the wing and queen-cells under way. We have no fruit bloom, and clover had not shown, so it was rather puzzling to know where the honey came from, but the bees got it all the same, and soon had plenty sealed under top-bars. We usually super at end of June, in this case the first week of the month was not too soon. While clover, forced on by the drought, appeared very early, and swarming began a month ahead of the usual time. The most forward colony supered with drawn combs was busy in three racks at midsummer, so with the principal honey months to come there was some excuse for the belief that the long-looked-for record season was in sight. We have had the record season all right; only it has been for rain not honey. Rain in every degree of intensity has been the all-pervading feature since the end of June. Unlike last year, we were unable to indulge in July, snow-balling but the weather throughout the month was of the character generally ascribed to April, only that the "tears" were many and the "smiles" few. Clover bloomed as usual and bees were ready and willing to gather in the nectar, only not being equipped with the rainproof armour suggested by Mr. Crawshaw, they were compelled to stay at home most of the time.

August was a wretched month and the heather flow a miserable fiasco. With September came a sudden fall in the temperature, the surrounding hills were capped with snow, and all but the most powerful colonies deserted the supers, incidentally taking with them all unsealed stores. Bright sunny weather was experienced during the latter part of the month, only rather unfortunately it was preceded by severe frosts that completely destroyed the heather bloom, so that bees desirous of improving the "shining hour"

were compelled to devote their attention to jam jars and sugar barrels.

Not only is the heather crop about the smallest known, but in most cases bees are short of stores, and if left unfed will never live to gather honey in 1904. The run of bad seasons has had most disastrous effects. At least half the colonies in the district have died, and seeing that half of the remainder will die during the coming winter and spring, those who trouble to keep their bees alive will reap a rich reward.

The days of low prices are over, with a great scarcity of honey. Prices have gone up; unglazed clover sections are in keen demand at 1s. wholesale, and I know of some bee-men selling retail up to 1s. 6d. per lb. The quantity of heather honey on the market is quite insignificant and prices run about the same as clover. Procrastinators would do well to heed the warning given on page 435, and even at this, the eleventh hour, close down their scattered forces. It will pay far better than to "let alone" and then kick yourself when the spring "exam." shows your apiary to be composed of a large percentage of defuncts, a number of worthless "weaklings," and a very few colonies strong enough to make the most of what we hope for in 1904—a booming, three-figure "take" season.—JOHN M. ELLIS, *Ussie Valley, N.B., November 11.*

## THE B.B.K.A. CONFERENCE.

[5308] The remarks made by some of the speakers at the recent Conference are striking in regard to what was said and left unsaid—judging by the concluded report in B.B.J. of last week. No recognised system of logic can be found to support an accusation, as unjustifiable as indiscreet, made by a representative that *all* schoolmasters are so and so, because *one* was found worthy of the impeachment! That is really too ludicrous for any intelligent person to entertain for one moment, and should therefore be ignored.

Again, an attack was based upon the fact that the B.B.K.A. expert at Swanley did not possess a First-Class Expert's Certificate. That is surely quite beside the mark. Does not the B.B.K.A. know its own affairs best? No matter how diligently one searches, no better qualified apiarist than Mr. W. Herrod can be found, and this, of course, the Council, feel as do all those who have had experience of that genial expert.

It does appear striking, not to say regrettable, that no words of appreciation were expressed by these critics to recognise the high-spirited and noble work being so faithfully rendered by the B.B.K.A. Council. Time, thought, and self-sacrifice are given for the sole benefit of apiculture, and bee-keepers should, nay, do, feel that a very great and deep debt of gratitude is the bare due to those gentlemen.—WM. RICHARDS, Hon. Sec., Glam. B.K.A., *Gabalfa, Cardiff, November 15.*

## BEE-KEEPING AND SCHOOL-MASTERS.

## TEACHING THE CHILDREN.

[5309.] At the recent *Conversazione* held by the B.B.K.A. Messrs. Scattergood and Cribb evidently thought it a good opportunity to express their personal feelings, which they did without reflecting for one moment whether or not they were giving an accurate indictment of a good body of public servants. It seems to me that it would be well—I am certain it would be more kindly—to question one's own judgment rather than rush into ill-weighed, and it may be false, accusations. It is to be presumed that the two gentlemen have full knowledge of the persons they condemn; and if they have, has it been sought in a kindly spirit, looking upon good and bad alike? Their remarks seem to indicate that they are speaking in haste from lack of an enlightened acquaintance. It is very easy to make accusations against others, especially if we have no great reason to feel kindly towards them personally. But accusations of the kind can serve no useful purpose, and may even damage the cause one wishes to further.

My object in writing is not to point out the foolishness (to use a mild term) of such talk, but to suggest that it would be a great acquisition to our pet industry if we could get the children of the land on our side, and who could possibly do it so well as the rural schoolmasters? If the County Councils can be prevailed upon to take the matter in hand, district apiaries might easily be established where children could be taught the principles and practice of the business. These apiaries, being in a measure public property, and the public having a personal interest in them, would tend to drive out of existence many of the contrivances now used to keep bees in, and possibly presage an impetus in the work of which few may have any conception.—ALBERT SANDYS, *Drayton, November 10.*

## BEE-KEEPERS IN CONFERENCE

## AND THE VILLAGE SCHOOLMASTER.

[5310.] With regard to the letter from Mr. Flower (5300, page 457) under the above heading in the current issue of the B.B.J., it is only fair to Mr. Cribb for me to state that before any exception was taken to his remarks anent a lack of interest in bee-keeping on the part of the village schoolmaster, he in conversation with me remarked how difficult it was to induce schoolmasters to take up bee-keeping. He informed me that he had on many occasions, in different parts of Lincolnshire, endeavoured to persuade schoolmasters to take up the subject, but without success.

It is surely easy to recognise that in one part of the country it may be the "fashion" for the village schoolmaster to keep a few

stocks of bees, and for his professional brethren in another to take no interest in the subject at all.—A. O. W., *Westfield, Retford, Nov. 16.*

## KENT AND SUSSEX B.K.A.: ITS POSITION.

## LETTER FROM THE CHAIRMAN.

[5311.] I shall be grateful if you will allow me to repeat in the B.B.J. the substance of my letter which has already appeared in the current number of the *Bee-keepers' Record*.

The Kent B.K.A., as most know, is of very old standing, but its inauguration with Sussex is of recent date, and was largely due to the splendid energy and optimism of my good friend Mr. Brice. In 1895, when he succeeded to the Honorary Secretaryship of the Kent, the membership went up by leaps and bounds, and the incubus of debt he had taken over went down in proportion, but when he left Lincoln's Inn and started business on his own account he could no longer devote his leisure to the work of the Association. Then, as misfortune rarely came "unattended" by bad seasons, show expenditure, the cost of circulating the *Record*, and the increasing expense of spring tours in the two counties, all contributed to turn the scale the wrong way. Though members of the Council became life subscribers and otherwise assisted the finances, all was in vain, and, strange as it may seem for me to say it, I and my fellow members of the Council were powerless to arrest the decline. Success cannot be improvised; it must come about by gradual and sustained effort; it is no use putting on "seven-league-boots" in a crisis! I will admit that the marriage of Kent with Sussex was a mésalliance for more reasons than one, but chiefly because the union of two counties deprives an association of County Council assistance. Councils cannot make grants for work *outside* the area of their counties, that is manifest. We have now to reorganise as well as decentralise the work. Even had we found a suitable successor to Mr. Brice it would only have delayed and not have obviated this necessity.

We must not forget that Surrey was in worse plight than we a few years back, but sound methods, moderately assisted by technical education funds, have accomplished wonders for Surrey bee-keeping. Surrey County Councillors are on the B.K.A. Council and control the administration of their grant. Kent as well as Sussex must be worked on similar lines by separate associations.

The Kent County Council has not hitherto assisted us (save with a solitary £15 for special work in 1898). It is true, the grants for lecturing (1892 to 1895) were *nominally* granted to our B.K.A., but the money went direct and intact into the pocket of the lecturer, who was then our Honorary Secretary, and when he resigned our Secretaryship he carried the County Council grants with him. From

1892 to the present time these grants have amounted to about £2,400. When we reflect that work in the apiaries is practically limited to about twenty-four weeks of the year, this is really princely pay and shows how the Kent County Council favours bee-keeping. Omitting Sundays it means 15s. a day all the year round, or 30s. a day on the period when work is possible.

From 1892 to 1897 our Secretary, who was the County Council Lecturer, was also Bee-keeping Instructor at the Swanley Horticultural College. This extra work for at least part of that period naturally involved extra pay. In those six years seven students passed the British Bee-keepers' Association examination at Swanley, and gained two second-class and seven third-class experts' certificates—these seven passed in 1895. In 1898, Swanley College appointed Mr. Wm. Herrod, the B.B.K.A. Expert, as their bee-keeping instructor, and I find the following results:—

	1st class.	2nd class.	3rd class.
In 1898 14 passed the B.B.K.A. Exam.	0	0	14
1899 10     "     "	0	0	10
1900 17     "     "	0	1	16
1901 28     "     "	1	2	25
1902 42     "     "	0	11	31
1903 44     "     "	6	0	38
	7	12	134

Thus 153 students received experts' certificates in those six years against seven students in the whole of six previous years.

I have been furnished with these figures by the courtesy of the principal of Swanley College, and I have also to acknowledge the courtesy of the principal of the South-Eastern College at Wye, to whom I wrote for a return of the examinations there. He informs me that there are no bee-keeping examinations at the County Council apiary at Wye. What we now want are two capable Honorary Secretaries to begin reorganising in each county with liberal allowance for secretarial expenses. "There are as good fish in the sea as ever came out of it," but they need netting! I am confident we shall get them—men who possess heart and brains in those right proportions that make ideal administrators!

I apologise for trespassing so inordinately on your space, but it is in a good cause, and one that is of interest to bee-keepers generally.—E. D. TILL, Chairman, Kent and Sussex B.K.A., *The Priory, Eynsford, Kent, November 16.*

#### BEE NOTES FROM DERBYSHIRE.

[5312.] After the wet, cold spring, and still worse summer, it reads like a romance to some to think it possible that such large "takes" of honey have been secured in various places, as reported in B.B.J. On June 21 I was feeding my bees daily to keep them from starving. Without professing to be weather-wise, I have learned a bit this year in that line, and noted during the first three months

the wind blew from S.W., and this caused our friend Mr. Lamb to predict in B.B.J. one of the earliest springs on record. But the wind then veered round to N. and N.E., and there it stopped till June 21, so it turned out to be one of the latest, so far as yielding honey to the bees. After June 21, the wind changed to S.W., and the difference was at once remarkable, for honey began to roll into strong hives. Unfortunately, my own stocks were not all strong, and I feared they would not be ready for white clover; but it bloomed so late that they were in time for it, and averaged 40 lb. a hive, which is very good, considering the season. Other returns from neighbours have shown about the same average. My best stock yielded about 60 lb., mostly in sections.

About the last week in July, while I was engaged in lending a hand helping an old widow with her bees, I met a Scotchman, who talked about the value of heather honey as being in demand and its good quality so sensibly that I made up my mind to have a try at moor-going, and at the earliest opportunity I was off over the hills towards Chatsworth in search of some heather whereon I could put a few hives. I found heather in plenty on Beeley Moors and lots of nice places for my purpose, but bees could not be left on those wild moors, for there seemed to be neither human beings nor habitations about; so after wandering about some time, a gentleman driving by told me of the nearest house to the heather likely to suit my purpose, so to it I went and secured a location in a field about 100 yards from the edge of the moor, from which there was a down-hill flight off a solid bed of heather stretching away for half a mile on three sides.

I reached home footsore and tired, having tramped near on thirty miles that day, but having attained my object I was content. I then tried to persuade a bee friend to take his three hives along and try our luck at getting heather honey, but I could not get him to budge an inch, so I decided to make the trip alone; and I set off early on August 10. The heather was just opening out, but the fine days were few and far between, and it was with many misgivings and a doubtful heart that I set out some weeks after for a ten-mile tramp to the bees, expecting to find them all starving or dead, although it was one of the few fine days we had in September. But judge my surprise and delight, on nearing the first hive, to see the bees crowding in at entrance in scores and working for all they were worth. The first super of shallow-frames looked at was full to overflowing; the next super of standard-size frames was all but sealed over, but the other hive with sections on was not half full. So here I was ten miles from home and no spare super with me; and next two days turned out to be the best they had, but bees would not go and help their neighbours to fill the sections, and I had not the forethought to put the half-empty sections



on top of shallow-frames or they might have been filled during the next two days, which were good bee-days, but then the wet came and the bees got no further chance, so after six weeks at the moors I got them home again. However, I got over 60 lb. of heather honey with only five real bee days in the six weeks. Well, all bee-work for 1903 has been over with me for a month past, and as far as I know they are packed down with plenty of stores to last them till May comes round again. I have increased to seven stocks by putting ten driven lots into two hives for the winter. Hoping 1904 will have more favourable bee weather all round.—TOM SLEIGHT, *Pilsley, Chesterfield, November 2.*

### PRICE OF HONEY.

[5313.] The discussion of the above ever-recurring question has again arisen; it appears to spring up at irregular intervals. W. J. Farmer says, on page 447 (5284): "If the Bee-keepers' Associations are to be of any real use, they must grapple with the question." May I ask him, "Are not B.K.A.'s of *"any real use"* apart from this subject?"

I admit that members do not associate with each other to the extent they ought to do, and until they unite more, each one must use his own business ability for the disposal of his produce. Taking the alternative of Mr. Farmer's statement, as quoted above, I think it is over-stating the case. The chief aim of a county B.K.A. is to extend the pursuit of apiculture, more particularly to the labouring classes on the land. I do not see any "evil" in that. B.K.A.s are not yet merely commercial organisations. This question was discussed when higher prices were obtained, and, I venture to predict, will be discussed when prices are still lower—I state still lower advisedly. Why should not the price of honey come down? I think we should have the satisfaction of making it a profitable concern at a lower price than is now paid. It is acknowledged that no other minor industry yields so handsome a return in proportion to outlay as bee-keeping. Perhaps some do not know this. An evil is produced by those who obtain much by wanting more; they do not know when they have got enough. I maintain that we now obtain higher prices in proportion to outlay than what we did before B.K.A.s were well established. Compare the profits on the straw skeps of thirty years ago, when the average take was about 20 lb. per hive, and the price 1s. per lb., to that of present-day hives, with surplus of 100 lb. per hive, and price, if you like, at 3d. per lb.; compare the quality, and mode of taking the same.

Have not B.K.A.s, directly or indirectly, educated us here? If we cannot get sufficient for our superior honey in our markets at our doors, how fares the foreigner? How does he compete? It is a natural sequence for honey to come down in price, and then not become a

"serious evil," not when every one takes advantage of the education, and each produce what they require. I see no "mischief," but a *virtue*, in the lower price of pure English honey.

Everybody has not the same amount of business ability; therefore, it is perfectly just if one procures a higher price than another. If a grocer really wants honey, he will pay a fair price for it. If he is educated, and has business ability, he will purchase in the best and cheapest market—which market may be through the BRITISH BEE JOURNAL; if it is the B.J., it will be a small quantity at 45s. per cwt. he will get; he will then, perforce, give a higher price if he wants more.

The policy of keeping back for higher prices is the policy of the dog in the manger; or, in other words, it is hesitancy and selfishness. I send name, &c., and sign myself—DESUNT CÆTERA, *Lincoln, November 16.*

### THE HONEY HARVEST.

#### WEST CORNWALL.

[5314.] Those bee-keepers whose stocks, either by accident or design, happened to be in the pink of condition at the right time have in West Cornwall reaped a bountiful harvest. A neighbouring bee-keeper, Mr. W. Rosmann, of Wall, near Hayle, has taken 861 lb. of extracted honey from five hives, an average of a fraction over 172 lb. per hive. I can vouch for these figures, having personally visited Mr. Rosmann's apiary several times during the past season. My own "take" is somewhat below this, 150 lb. of extracted honey being the greatest amount taken from one hive.—C. H., *Hayle, Cornwall.*

## Queries and Replies.

[3279.] *A Beginner's Queries.*—Some time ago I was advised to commence bee-keeping for profit, and eventually I became a reader of the BEE JOURNAL; I also procured your "Guide Book," from which I gained the information required, and very soon resolved to give the bees a fair trial. I bought four stocks in straw skeps, also one driven lot. Then (thanks to your book) I was soon able to drive bees with success myself, after carefully studying the instructions given. I also intend to transfer the bees from the above skeps to frame-hives in the spring. They have been well fed, and, with plenty of stores, are now in comfortable winter quarters. I hope to increase my apiary to about fifty stocks by purchasing swarms next season, and before doing so I ask:—1. Do you consider it wise for a beginner to get so many hives, or am I too enterprising? 2. Can I insure my bees against accident or foul brood; and, if so, will you kindly say how? 3. Can I become a member

of the B.B.K.A.? I am told that there is no association in Herts. I shall be glad to receive any advice on management of apiary or anything concerning bees. I find it a great pleasure when my day's work is done to help make the bees comfortable, knowing it is not labour in vain.—ENQUIRER, *Herts, November 14.*

REPLY.—1. Too enterprising by far. The proper management of fifty hives is beyond the powers of any beginner we ever knew or heard of. Limit yourself to ten or fifteen colonies at most till you have dealt successfully with that number. To see fifty colonies at swarming time in some seasons is enough to make old hands lose their heads at times. 2. You can insure against damage to others up to a certain amount, but not against disease among your own bees. 3. Yes, by applying to Mr. Edwin H. Young, Secretary, 12, Hanover-square, London.

[3280.] *Candy-Making. — Working the "W.B.C." Hive.* — 1. Will you kindly say if the enclosed sample of candy is suitable for use? I made it from directions in the "Guide Book." 2. If you have no objection, I would very much like to know how you work the "W.B.C." hive. Do you use the 3-in. "ekes" during the winter and remove them, say, in April? 3. Do you then put the box of shallow-frames in its place, and after a while remove and place it over brood-nest, and leave it so during the working season, placing racks of sections over it as needed? I work entirely for sections. I never use excluder-zinc, and scarcely ever have a section spoiled—not 1 per cent.—H. J., *Mountmellick, November 12.*

REPLY.—1. Sample of candy is not at all good. It is insufficiently boiled, hard, and somewhat coarse in grain, instead of being smooth, soft, and buttery when scraped with the finger-nail, as stated in "Guide Book." 2. We remove "eke" in February when adding to covering of brood-nests to promote early breeding. The "eke" is then placed above top-bars, and keeps the extra coverings given close down, thus preventing the escape of warmth from brood-chamber. 3. We do not quite understand this question, so far as "putting the box of shallow-frames in its place" subsequent to removing, and "placing it over brood-nest." This seems to refer to a non-swarming chamber, which the "W.B.C." hive does not possess.

[3281.] *The Insurance Scheme and Divided Apiaries*—There is one question which I should like to ask, and an answer to which would, no doubt, be interesting to all beekeepers similarly situated to myself. I am going into winter quarters with ten stocks, all of which have a good supply of natural stores. Two of these ten are a little distance away from my apiary and far from one another. The cause of their being so is this: Rather than bring a swarm which had clustered some dis-

tance away into the apiary where I already had a few stocks, I hived the swarm in the locality which they had chosen, because forage was plentiful there; and being the only stock in that spot, I considered that the more plentiful surplus from a stock so situated would pay me for the extra trouble with them, on account of their being far afield and not in touch with the other hives. My question is, Could I insure all my hives as one apiary, or would these solitary ones be reckoned as out-apiaries? Thanking you in anticipation for a reply in next week's JOURNAL.—T. ALUN-JONES, *Rhosesmor, Flintshire, November 16.*

REPLY.—You could obtain official particulars on the point of divided apiaries on application to the Secretary of the B.B.K.A. For ourselves, we may say a bee-keeper cannot cover risks from all his bees if they are located in two or more counties without taking out separate policies for each apiary. Again, a single policy only covers a certain distance or area from the place where the bees are located.

## NORTHUMBERLAND AND DURHAM B.K.A.

### HONEY SHOW AT NEWCASTLE.

The above show was held in connection with the Grocers' Exhibition in St. George's Drill Hall, Newcastle-on-Tyne, commencing October 28. The entries were not numerous, but the quality was good. Mr. C. Caldclough, Durham City, judged the honey exhibits, and made the following awards:—

*Observatory Hive with Bees and Queen.*—1st, T. R. Jackson, Corbridge-on-Tyne; 2nd, J. Smith, Forest Hall.

*Twelve 1-lb. Sections.*—1st, Geo. Kirkup, Widdrington.

*Twelve 1-lb. Jars Extracted Honey.*—1st, G. H. Garner, Altrincham, Cheshire; 2nd, R. T. Tennant, Thirsk, Yorks.

*Single Section, 12 $\frac{3}{4}$  in. by 4 $\frac{1}{2}$  in. (approximately 3 lb.).*—1st, J. E. Walton, Blackhill, Durham; 2nd, Geo. Rochester, Blackhill; 3rd, W. Milne, West Hartlepool.

*Six 1-lb. Jars Heather Honey (District members only).*—1st, W. Milne; 2nd, J. Ironside, West Hartlepool.

*Three 1-lb. Sections Heather Honey.*—1st, Geo. Kirkup; 2nd, J. Hope, Corbridge; 3rd, Mrs. G. N. Spain, Netherhouses, Otterburn; 4th, Mrs. Thompson, Cleughbrae, Otterburn.

*Two 1-lb. Sections Heather Honey.*—1st, Geo. Kirkup.

*Non-Sectional Super of Heather Honey.*—1st, Wm. Cowans, Rothbury.

*Beeswax.*—1st, Wm. Cowans; 2nd, Geo. Rochester.—JAS. WADELL, Hon. Sec., *Wooler, Northumberland, November 7.*

\*.\* *A few Queries and Replies are held over till next week for lack of space.*—EDS.

## Editorial, Notices, &c.

### BRITISH BEE-KEEPERS' ASSOCIATION

The monthly meeting of the Council was held at 105, Jermyn-street, S.W., on Wednesday, 18th inst., Mr. T. I. Weston occupying the chair. There were also present Dr. Elliott, Major Fair, Messrs. R. T. Andrews, H. Jonas, J. B. Lamb, H. G. Morris, W. F. Reid, E. Walker and the Secretary. Letters explaining inability to attend were read from Miss Gayton, Rev. W. E. Burkitt, Mr. T. W. Cowan, Mr. D. Bishop-Ackerman, Mr. W. Broughton Carr, and Mr. W. H. Harris.

The minutes of the previous meeting were read and confirmed.

Two new members were elected, viz.:

Mr. A. J. Dover, Platt, Sevenoaks.

Mr. W. J. Potter, 41, Linden-grove, Peckham Rye, S.E.

Dr. Elliott reported that the Finance Committee had examined the accounts to date, and presented the list of cheques required by the Committee. The report was approved.

Reports on recent examinations were received, and as a result it was decided to grant certificates to Messrs. P. L. Aldridge, J. E. Collier, W. Darrington, — Eden, D. Hancox, D. J. Hemming, G. Jordan, D. Marshall, and R. J. Turner.

The Secretary reported that twenty-five candidates had entered for the examination for second-class diplomas. The examination had been conducted at seventeen centres on Nov. 13 and 14. Examiners were appointed to adjudicate upon the papers written.

Mr. Weston brought forward a motion: "That at shows to which the B.B.K.A. make contributions to the Prize Funds the first prize exhibit in the classes for comb honey, light extracted honey, and wax may become the property of the Show Committee of the B.B.K.A. at a price to be fixed and stated in every show schedule."

This was seconded by Mr. Reid, and, after some discussion, was carried by a small majority.

It was resolved that at the R.A.S.E. Show in 1904 the prices at which prize lots may, at the discretion of the Show Committee, be purchased should be as follows:—Sections, 15s. per doz.; extracted honey, 15s. per doz.; wax, 2s. 6d. per lb.

On the motion of Mr. Walker, seconded by Mr. Reid, it was decided to arrange the counties into six groups (instead of nine as in 1903), and to offer, in each group, prizes for sections, light extracted honey, medium or dark coloured extracted honey, and granulated honey. All classes to be open to honey of any year. Classes for appliances, wax, and other exhibits to remain practically as hitherto.

The next meeting of the Council was fixed for Wednesday, December 16.

### BEE-KEEPING.

ITS EDUCATIVE INFLUENCES.

By W. H. Harris, B.A., B.Sc., C.C.

(Continued from page 463.)

#### MENTAL INFLUENCES.

Since the education of the eye, the ear, and the hand is dependent on brain-action, and since the brain is the organ of the mind, the present part of our subject naturally connects itself with the preceding one. Still the mental influences of bee-keeping cover a field far larger than the physical one, and, for the most part, quite outside the latter. This will be manifest from the following considerations, very briefly put:—

First: *The elementary facts of the life history of bees are full of interest to persons of all ages.* This is perfectly well known from the experience of all capable lecturers on the subject. Not only adults, but boys and girls of average intelligence, listen with rapt attention to "the wonders of the hive;" and all good teachers know that when once pleasurable interest is aroused the reception as well as the imparting of knowledge will present little difficulty. Then again, as many simple observations can easily be made, and learners can have the satisfaction of verifying for themselves statements they have heard or read, a new and very real intellectual pleasure arises. This leads to a desire for further knowledge, and such longing, once quickened, will be the path to other fields.

Secondly: *Enlarged reading and observation.* Independent work of this kind is always a great gain; for in this way general intellectual development is best promoted. The benefits consist not only in the habits of mind set up, nor merely in the facts acquired, but rather in the quickening of the imagination, in the storing up of mental pictures, in the strengthening of memory, and in lifting the individual out of the too engrossing domain of the five senses. So—

Thirdly: *It will come to pass frequently that, as knowledge grows from more to more, learners will be led to excursions, more or less prolonged, into other regions of intellectual gratification.* Other fields of natural history—especially those akin in some respects to apiculture, and then others less allied—first, wild bees, wasps, and ants, and, later, butterflies and moths, for example, will successfully display attractions to elementary research. Yet more than this, as flashes of light are seen from the poetry of science—we mean the unwritten ever-living original poetry straight from the mind of God—fresh and previously unthought of joys will allure the learners still further onward. Then, turning to quite another line of thought—

Fourthly: *The meeting with various practical difficulties, requiring more or less prompt solution, will induce habits of quick judgment and ready decision.* It happens

sometimes, for instance, that it is necessary to determine speedily how swarms shall be dealt with; how incipient "robbing" shall be stopped; how accidents from the upsetting of well-stocked hives shall best be remedied, and the breaking-down of full combs be rectified; how the discovery of malignant disease shall be followed up: these complications, and various others encountered in advanced bee-keeping, will call out readiness in resource, and promptitude in action. But these qualities, once acquired, will be available and will be exercised in many another department of everyday life.

Fifthly: *By intercourse with experienced bee-keepers, by attendance at exhibitions of honey, wax, and apicultural apparatus of various kinds, valuable lessons are learnt as to the importance everywhere of details.* People are coming to recognise that in all departments of work, success largely depends on attention to minutiae—looking after what seem little things; not giving in to *laissez faire*; not trusting to what some are pleased to call "chance" or "luck," terms which ought to have no place in the vocabulary of thinking persons, so far as their own affairs are concerned. Again, it has been said by a well-known poet:

In the elder days of art  
Builders wrought with greatest care  
Each minute and unseen part,  
For the Gods are everywhere.

But even more mundane considerations are driving home to us the need of attention to the minor matters of life and work. The bee-keeper who, with this fact in view, gives his mind to looking after what may seem to his careless neighbour trivial points, will be rewarded, not only by greater success in his particular pursuit, but also by establishing a mental habit, which will be of larger service to him in many another line of industry. We may add that to the diligent observer, bees themselves will enforce the lesson of "the power of littles."

Sixthly. What we have said hitherto on this division of our subject applies almost entirely to those whose faculties of mind need drawing forth. There are, however, large numbers of persons of a totally opposite condition—men and women to whom bee-keeping may prove mentally beneficial. We refer to those who need an intellectual sedative, rather than a new stimulus; whose brains are in perpetual activity through professional or business claims. *Many such individuals find an interesting hobby more restful and far more pleasurable than complete idleness.* With minds and hands quite unoccupied, the thoughts are apt to recur to the grooves in which they have been running for hours, to the point of "brain-fag." We affirm then that for tired men and women, and even for hard-working boys and girls, bee-keeping affords during leisure hours, a means of occupation both profitable and diverting.

The old saying still holds true that "a change of work is as good as play." In some instances it is far better, especially when, as in the case of apiculture, no undue physical fatigue is involved, and mental strain is relieved rather than increased.

(To be continued.)

## Correspondence.

*The Editors do not hold themselves responsible for the opinions expressed by correspondents. No notice will be taken of anonymous communications, and correspondents are requested to write on one side of the paper only and give their real names and addresses, not necessarily for publication, but as a guarantee of good faith. Illustrations should be drawn on separate pieces of paper. We do not undertake to return rejected communications.*

### NOTES BY THE WAY.

[5315.] *Honey Jars.*—Honey jars of correct size are still a desideratum with bee-keepers. Mr. Farmer (on page 446) refers to the small profit resulting to bee-keepers who are compelled to buy honey in bulk from brother bee-keepers to enable them to fulfil orders, and have found that the cost of jars has absorbed the small margin by holding more than the 8 oz. or 16 oz. I was told by the Secretary of a B.K.A. that a 28 lb. tin only filled about twenty-six 1 lb. jars; so that only by using a 14 oz. size could there be any profit. To be perfectly fair, then, it seems no more unjust all round to sell jars holding a little under weight than overweight. Messrs. Abbott Bros. catalogue a very nice-looking  $\frac{1}{2}$  lb. jar, and I ordered a crate; but this jar, when filled, holds nearly 9 oz. I recently got an order for half a gross of  $\frac{1}{2}$  lb. jars, and felt I had given in this one order 4 lb. 8 oz. of honey, value about 3s., entirely away in overweight. When at the Dairy Show, I discussed the question with another honey-seller like myself, and got from him a sample  $\frac{1}{2}$ -lb. tie-over jar of foreign make, which I found holds 8 $\frac{1}{2}$  oz. of ordinary honey; so this jar entails a loss on every pound of honey sold in it.

*Shows and Showing.*—If prominent exhibitors in the past had not troubled to stage their exhibits at our honey shows, the British public would never have had an opportunity of seeing what the best products of the hive are like at all. But this fact apparently did appeal to the minds of our friends at the late conference. No doubt other exhibitors along with myself can fully endorse the remark of Mr. Dawson on the unceasing importunities of Secretaries of Bee Associations to get entries. I often receive schedules, marked in "red ink," of extension of time of entry, along with most pressing requests for entries. This is, in my opinion, one reason why Mr. Reid was able to taunt us with "wandering about from show to show to win prizes." I can assure Mr. Reid that for many years I have exhibited more from an educational point of view than the profit there is even in being success-

ful as a prize-winner, and have not seldom done so by special request of some B.K.A. Secretary, so that members should know what really good honey was like. I may say also that sections of honey are sometimes so knocked about by the porters of two or three lines of railway as to be unfit for showing a second time; and it is only the feeling that I have in years gone by had to show against myself that has induced me in recent years to give up my former regular practice of entering my exhibits for sale. To sell exhibits in this way is much more profitable to the exhibitor than to have to pay increased return freightage, sometimes only to find exhibits so damaged as to be unfit for showing again. My own experience of showmen, gained during the past quarter of a century, is that they tire of "showing"—(1) because, in the long run, there is no profit in it; (2) disgust at incompetent judging; (3) the heavy expenses attendant on showing; (4) loss of interest after having gained the highest honours. And now our Bee Parliament, if Mr. Weston carries his motion, as I understand it from his remarks reported in B.B.J. of October 22 last (page 423), will have added another deterrent to the number of entries in some classes by disqualifying prize-winning exhibits which have been staged elsewhere, and of making a primary point that the 1st prize exhibits in certain classes shall be sold. To whom? I ask. It is contended that honey stands in a different category to other exhibits. Yes, it does, from many other things in the show. Honey of prize quality is at best only an annual production while in the section-honey classes it is next to impossible to keep prize sections for a second year's showing.

Bee-keeping in this country is on a very small scale compared to the western hemisphere and, therefore, most bee-keepers here are able to sell a good portion of their products locally. And when we take into consideration the precarious standing of honey production in this country owing to well-known drawbacks, we at once acknowledge that bee-culture is likely to remain as a minor industry in these islands, as an auxiliary to one's income rather than a primary source. The bee-keepers in Great Britain who depend *entirely on bee-keeping* for a living can, I think, be counted on one's fingers.—W. WOODLEY, *Beeton, Newbury.*

#### SELLING HONEY.

[5316.] Referring to the letter of "Desunt Cætera" (5313, page 469), I venture to differ from your correspondent's view when he asks, "Why should not the price of honey come down?" No doubt, as bee-keeping increases, and the supply is more than the demand, prices will come down; but I cannot see why bee-keepers should be asked to sell first-class stuff at a lower price than at present, while

retailers are obtaining a shilling and upwards per 1-lb. jar. I consider that first-class honey at £3 per cwt. in bulk, and 9s. 6d. per dozen screw-cap jars, leaves a very fair profit to the retailer. "Desunt" also asks us to "compare the profits on the straw skeps of thirty years ago, when the average take was about 20 lb. per hive, and the price 1s. per lb., to that of present-day hives, with surplus of 100 lb. per hive, and price, if you like, at 3d. per lb." How many bee-keepers, I would ask, average 100 lb. per hive? I maintain that at the prices he quotes more profit would be got from skeps than from frame-hives, if we take into account the difference in outlay on the old-fashioned system and the modern plan. And it is not too much to say that when good home-grown honey has to be sold at 3d. per lb., no minor industry will yield so small a profit in proportion to outlay as bee-keeping. Moreover, it will only pay to keep bees in the very best honey-producing districts. The last paragraph in "Desunt's" letter compares the policy of contending for fair prices to "the policy of the dog in the manger," or to "hesitancy and selfishness"; but how does he reconcile this with his previous statement that "Everybody has not the same business ability; therefore, it is perfectly just if one procures a higher price than another?" We should not be showing much "business ability" by rushing our honey on the market when prices are low. As I understand it, any man having produce to dispose of should endeavour to sell in the best market, and at a time when it will realise the best price.

Without the smallest idea of who "Desunt Cætera" is, I hope he is not a honey-producer, as I have a better opinion of my brother bee-keepers than to suppose any one of them capable of writing what is, to my mind, only nonsense. I have noticed that the advocates of cheaper honey are in the habit of using a *nom de plume*, which is unsatisfactory in every way. If they gave name and address, we might find they were either not bee-keepers at all, or were very unbusinesslike ones.—W. PATCHETT, *Cabourne, Lincs, November 20.*

#### DUAL B.K. ASSOCIATIONS.

##### ADVANTAGES OF SEPARATION.

[5317.] Mr. Till's letter (5311) in this week's issue of the BEE JOURNAL, in reference to the position of the Kent and Sussex B.K.A., prompts me, not to offer advice as to the course to be pursued, which would be somewhat impertinent on the part of an outsider, but to point out the benefits which have been gained by a "divorce" in another instance. After a number of years of "married life," Lancashire and Cheshire dissolved partnership at the end of 1898. The membership of the Association at that time was about 300, Cheshire members numbering 192. The cash balance was divided, and each of the new Associations started life

with a capital of rather more than £2, together with a share in a bee-tent (which was subsequently disposed of) and in the library (which still remains the joint property of the two Associations). The position of affairs at the end of last year demonstrates the progress which has been made through the formation of separate Associations for each county, and the consequent limitation of area to be covered in each case. The Lancashire B.K.A. report for 1902 shows that there were 346 names on the list, and that the Association had a balance in hand of £14 10s., a number of subscriptions also being overdue; while in the Cheshire Association at the same date the membership was almost similar, 349, and the funds amounted to £43 14s. 11d. Thus, after four years, a membership of, say, 300 had become one of nearly 700; and the cash balance in the hands of the Associations was rather more than £58. In neither case has a large amount of assistance been received from the County Council.

This statement may, perhaps, afford some encouragement to those who have the interests of bee-keeping in Kent and Sussex at heart in the event of an Association being formed for each of those counties. For my own part, I am of opinion that an Association for a single county is advantageous, because the fact that it is their own County Association appeals to the feelings of bee-keepers; and from personal experience I know that one county affords quite sufficient scope for the energies of honorary officials.—EDWARD CHARLEY, Hon. Secretary, Cheshire B.K.A., *Ince Vicarage, Chester, November 20.*

[5318.] Will you please allow me to correct two errors in the letter (5311) you were good enough to publish of mine last week? They are printer's errors, and occur in the sixth line, which should have been "its amalgamation" (not "inauguration") "with Sussex," &c, and the sixteenth line should read: "Then, as misfortune rarely comes" (not "came") "unattended" (not "by"), "bad seasons, show expenditure," &c. The word "by" inserted before "bad seasons" spoils the sense.—E. D. TILL, *The Priory, Eynsford, Kent, November 21.*

#### PREVENTING SWARMING, &c.

[5319] In your issue of August 27 (page 345) Mr. Castle asks for the experience of others on the above. Here is my experience, which may be of interest to him. For many years, owing to my garden being away from my house, I followed the non-swarming system with excellent results, and had no trouble in spring-dwindling, because I re-queened regularly. Clover and limes were close at hand, but I carted the bees to the heather. Since I removed here and have my bees at the back of my house, I have practised artificial swarming,

because it was an easy way of getting queens, and I did not get into such a set of old combs. I find that my average take is much the same, but I have heather close at hand, as well as limes and clover. I have once or twice kept a hive going on the storifying method; but though I get more clover honey from a storified non-swarmed hive, I do not get as much heather honey. The old stock with a young queen gives me the best results for heather honey.

I still believe that the non-swarming system is best for honey when the harvest is a short one; but I am not so sure about it placed as I am. "D. M. M." gives us a very interesting article in the last issue (page 463) on wintering in skeps *versus* frame-hives. I should think the fact of being able to see exactly what a hive had in the way of stores would be a great factor in the case. Things being equal in the way of food, &c., I should think the skep would winter as well as the frame-hive.

I expected to see some discussion on the subject of getting exhibitors for shows after what was said at the B.B.K.A. *Conversazione*. If it were possible to have all sections and comb honey shown undressed, I am sure exhibitors could be got. Few small bee-keepers have either the time or ability to dress sections, and the expense is a consideration.

That is my experience, at least, in county shows. I should also think all prize sections should be marked, not to prevent their being shown again, but to prevent their being shown by other persons—a practice which, I believe, is getting somewhat common.

I saw with extreme regret your announcement of Mr. D. Raitt's death. I knew him personally, and spent some time with him in his works last spring. A worthy son of a great bee-keeper.—H. MARRS, *Newtownards, N.B.*

(Correspondence continued on page 476)

#### HOMES OF THE HONEY BEE.

THE APIARIES OF OUR READERS.

Mr. Best, whose bee-garden is seen on next page, is one more reader whose bee-keeping started with skeps and the sulphur-pit; but, like all true bee-men, he quickly saw the advantages of modern methods of management, and however picturesque and snug the hackle-topped skeps may appear in the photo, they are only tolerated for old times' sake. For the rest, the following "notes" speak for themselves:—

"Trewoon Apiary" is situated about one mile west of 'Clayopolis,' as the busy town of St. Austell is sometimes called, and right in the centre of the historic county of Cornwall. My earliest recollection of *Apis mellifica* dates back about thirty years ago, when I was told to 'watch for the expected swarm,' and this watching left an impression upon my young mind never to be forgotten, and from that time my interest deepened and increased with the

years. I took no practical part, however, in the bee-work at home, except perhaps to cover up with earth the few bees remaining upon the turf when the colony was consigned to the 'sulphur-pit.' But many were the hours spent in watching the busy bee carrying home their loads of many-hued pollen, &c. Eventually I got permission to try the much-talked-of new-fangled notion of wood hives, having derived a little knowledge of modern methods from what I saw at a local show. My little knowledge, as usual, proved a 'dangerous thing.' In those days I had no 'Guide Book' or *B.K. Record* or expert's visit to help me, and what with a rather strong opposition at home, characteristic of a county which is 'on

of my hives, all my own make, except the first one (which always gives me most trouble), and about three years ago turned my attention more fully to the £ s. d. side of bee-keeping. My difficulty was how to find a market for my produce. I sold sections at 6d., 7d. and 8d.—last year at 8d. and 9d., this year at 10d. and 1s.; and could have sold more if I had them, so you see my prices have always improved. But considering I had to 'feed' during the last week in May, I am on the whole very pleased. I do not know that there is anything new in my apiary except, perhaps, that the outer walls of all my hives are raised 2 in. or 3 in. above the top-bars of brood-nest to counteract the bleak driving winds and wet. At the time of



MR. JOHN M. BEST'S APIARY, TREWOON, ST. AUSTELL, CORNWALL.

the road to nowhere,' and the 'opposition' of the bees, when stingfully disposed, along with bad seasons, it was uphill work, but I have always been a keen lover of Nature, and that love attached me to the honey bee, and when my friends sometimes say, 'I like a bit of honey, but I just hate bees,' my reply has often been, 'Yes, but I love the bee.'

My bee-experiences in those days appeared in your monthly, the *Record*, about twelve years ago, under the title 'Bee-keeping Experiences in Cornwall.' From that day I have made headway steadily. For several years I was quite pleased if I could sell a quart or two of honey and be able to give a bit of honey-comb to about a score of friends and neighbours. But I gradually increased the number

writing the skeps shown in photo (kept for the sake of 'Auld Lang Syne') are now reduced to one, and the other hives are increased to thirteen, with a further increase contemplated, as I have just been appointed to the joint offices of rate collector, assistant overseer, and clerk to Parish Council, which (when there are no more passive resisters) will give me more time for my favourite hobby. Having been a cooper by trade, I could not give all necessary attention before.

I am glad to say I have never had foul brood among my bees. I usually winter on natural stores and use preventive measures recommended by 'Guide Book.' I have made my first attempt at 'showing' this year, having secured three 1sts at a local show,

a certificate at the Grocers' Exhibition, five 2nds and a 1st at the Royal Cornwall Show for bees, hives, and honey, and a special for a fourfold nucleus hive not shown in photo. I have also got the B.B.K.A. Expert Certificate, which is prized most of all.

The apiary shown occupies four sides of an oblong piece of ground in my own garden with a walk at the back of each hive. The photo was taken by a friend who has recently developed a keen interest in bee-keeping as a compliment for a few lessons given in the craft. I am a member of the Cornwall B.K.A. and take both the *Record* and *JOURNAL*.

I cannot say anything about my average 'takes' of honey, but have secured more in the present year than in any former one."

### CORRESPONDENCE.

(Continued from page 474.)

#### CLIPPING QUEENS

FOR PREVENTING LOSS OF SWARMS.

[5320.] Referring to 5286, page 447, I should like to give the reason and method with regard to clipping queens wings that I myself practise, as under some circumstances I consider clipping is an advantage. My apiary is situated close to the side of a wood, not large, but thinly populated, perhaps 400 yards long and 10 or 12 yards wide, composed of ash, beech, elm, and other trees. Now when I first dumped my thirty hives down in the month of May it seemed an ideal place for bees. These trees, I thought, would shelter the hives from the rough north and west winds, and they would get the sun all the day, and so they did. Also, as Mr. J. J. Ker (5302, page 458) recommends, all the colonies were strong, headed with young queens, and brood on nearly every frame. Everything seemed in the finest condition but the weather, which was bad, for it rained day after day, and the bees loafed around their own and the other hives, but did no honey-gathering. Then the clover came into bloom, and it still rained; two days wet and half a day fine, then showers, and more rain between, till at last the bees seemed to get quite dissatisfied, and owing, no doubt, to overcrowding, they decided on the first fine day to swarm. And swarm they did, first one hive and then another, sometimes two together; but, anyhow, they swarmed! I then found out how useful the trees were. True, they kept the big winds of winter off the hives, but when two big swarms united and clustered about 4 ft. from the top of one of these trees, it was, to say the least, a bit awkward. Fortunately, in most villages there is one person who "knows all about it," no matter what the subject is, and he reminded me of the long thatching ladders used by farmers. So with some assistance such a ladder was borrowed and brought (it was fully 30 ft. long and weighed something under half a ton); but when leaned up against the tree, the top of the ladder was still 30 ft.

from the swarm, hanging 20 yards above ground, so we were not much nearer than before. I next got a large net, and this was fastened to a light pole. Armed with this and a strong cord, after some climbing I got within reach of the bees, and eventually managed to secure the greater part of them in the net, and commenced to lower to an assistant below. But the "best laid schemes, &c." The bag caught on the end of a broken branch, and was rent from the bottom upwards, so that my assistant got most of the bees on his head and shoulders. In the end they flew back to the old spot, and after shaking them off the branches again and again as they re-clustered, till they settled on a lower level and were hived in safety.

So in view of further similar troubles, all queens now have about two-thirds of the wings on one side cut off. I keep a boy watching during swarming hours, and when a swarm begins to issue he first notes the number of the hive, then gives the alarm. The queen is easily seen on the ground and picked up, and if the swarm is required, the parent hive is moved away and a clean one placed on the stand, and as the bees return (which they usually do in a few minutes) the queen is dropped on the alighting-board and runs in among them, and thus the swarm is hived. If swarms are not desired, the queen is secured in a cage along with a few bees, and kept warm till the evening, when the hive is overhauled, all queen-cells cut out, more room given, and the queen returned.

It is always best to have a few spare queens on hand, because after a swarm has been returned about twice you might find your old queen cast out dead, which means that those bees intend to swarm and will not be frustrated; and they will swarm out (if not prevented) with anything up to a score of virgin queens, and, indeed, I have known them settle in little clusters "all over the shop."—H. F. G., B. D., *Yorks, November 16.*

[5321.] In your issue of November 5 an important question was put to your readers by Mr. L. Illingworth (5286, page 447) on the practice of clipping queens' wings. I awaited the appearance of last week's B.B.J. with interest and curiosity, expecting to find some of our worthy experts who study the anatomy of the bee to give a definite reply whether or not "clipping" the wings is painful to the bee. The question is, no doubt, sensible and useful, especially as so many of your readers are watching the columns of the B.B.J. for the best "swarm-catcher" in the market. But some of us are very careful lest we injure the head of the colony by using such appliances. The points which arise in my mind are—1. Suppose we clip off one half of the queen's wings, does this in any way diminish her prolificness; and would she after the amputation, so to speak, feel sickly for a time? 2. Would it be noticeable



if such were the case; or if the operation proved painless, might not the queen become so accustomed to her mutilated state as not even to know that the greater part of her wings was gone? If that were so, she would prepare for taking wing along with the swarm as at other times, and when, leaving the hive in company with the excited outrush of hundreds of bees, she arrives on the alighting-board, and finds herself carried along with the hurrying multitude, only to drop on the ground through her inability to rise with the bees in their joyous flight. And so the poor wingless queen, being unable to arise and return to the hive, would be lost to the swarm, while the latter is flying about in a demoralised state. Thus the chances are, I think, that a great part of the swarm would be lost or, perhaps, enter other hives. I trust this subject will meet the eyes of some one who, having had experience of queen-clipping, is able and willing to throw a little satisfactory light on the matter.—W. D., *Aldershot, November 16.*

[Our correspondent will find recorded the experience of another bee-keeper on the subject in our issue of Nov. 12 (page 458).—EDS.]

#### BEE-KEEPERS IN CONFERENCE.

[5322] I regret that "A. O. W." (5310, page 467) in last week's issue of B.B.J. failed to comprehend the meaning I wished to convey in my letter of the 12th inst. I merely desired to show that village schoolmasters as a body had given no cause to merit such treatment as was meted out to them by certain delegates at the recent Conference.

Taking the B.B.J. as my authority, the gist of the whole affair in question is this. Mr. Scattergood during his speech gave utterance to some very disparaging remarks with regard to the character of the village schoolmaster. Mr. Cribb, speaking subsequently, said he quite agreed with Mr. Scattergood in his remarks about schoolmasters. He also stated that a schoolmaster was not always a suitable person to teach bee-keeping, proving his case by quoting an isolated instance of neglect on the part of a schoolmaster bee-keeper. "A. O. W." and other friends of Mr. Cribb cannot alter in the least degree the statements made publicly by Mr. Cribb by stating what he said before and after the meeting with regard to village schoolmasters.—K. D. FLOWER, *Ilstington, November 23.*

#### BEE-KEEPING AND SCHOOLMASTERS

[5323.] I have not yet met with a schoolmaster conceited or opinionated, but have found them anxious to learn themselves, and to pass their knowledge on to others, and as these latter are the rising generation surely their help is invaluable? Some are local secretaries, and others help in various ways.—GEO. M. SAUNDERS, *Hon. Sec, Cumberland B.K.A., Keswick, November 23.*

#### WINTER PASSAGES.

##### A SIMPLE HOME-MADE DEVICE.

[5324.] It has been fairly conclusively proved by experiment that winter passages are amongst the good things, and if these can be arranged with ease, simplicity, and economy they are highly desirable. There is no doubt that in frame-hives many an outside seam of bees perishes from cold every winter, often in the midst of plenty, from sheer disability to follow the main cluster in its orbit. The bee-way around the ends of the frames is insufficient from the fact that it is situate in a cold and distant part of the hive, and the sluggish bees chill where they hang before they will make any organised effort to travel. Undoubtedly the best means for such emigration would be a hole through the comb in or above the axis of the spherical cluster of bees, a central way to which the discs of bees between the combs could easily shrink and pass through. This often occurs naturally in skeps where sticks run through the combs, and is, no doubt, possibly, in addition to the shape of the skep hive, one reason for the better wintering of neglected bees thus housed.

No one, however, desires to spoil good frame-combs by the manufacture of such pop-holes as these, and a fairly good substitute is the simple stick laid across the top-bars. The sketch below shows a slight modification of

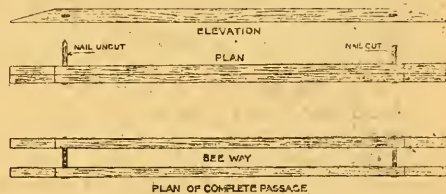

HOME-MADE WINTER PASSAGE.

the arrangement which I have had in use for a couple of years with satisfactory results, and which appears to me to be a slight improvement upon the single stick. It will be seen that two sticks side by side are spaced apart by nails giving bee-way between, thus preventing any stoppage or block of the passage by a close-fitting or crumpled quilt.

The bevelled ends of the passage stick allow the quilt to fit down close to the outside frames.

To make these, take a couple of similar sticks of almost any small rectangular section which will give in one direction sufficient height for bee-way, lay these side by side and drive an oval wire nail through both at each end, the nails being driven home and allowed to project some half-inch or so. Plane up the edges and bevel the ends with the chisel, and after cutting off with the pliers the pointed ends of the nails, "spread" the sticks apart until the nails project no more, the cut ends being just buried. The sketch will, perhaps, make this quite clear. A point as to the

arrangement of these is that the feed-hole in the quilt should be placed between the passages, which should be spaced far enough apart to allow of a cake of candy or a spring feeder to stand between quite flatly and firmly.

Where winter-passages have not already been arranged, such may be placed *in situ* without any disturbance of the bees by slightly rolling back the quilt from the ends of the frames, smoke being in no sense necessary even to the novice who has not yet lost his fear, for whom the suggestion is intended.

Whilst on the subject, I should just like to say that it is common to find beginners attributing virtues to particular appliances, even ignoring somewhat the object of these, and failing to use their common-sense judgment as to why's and wherefores. Thus I have known honey returns attributed to the exact shape or size of porch or alighting-board; and a novice who may make such a simple form of appliance as a winter-passage, if he find this to exceed or fall short by a trifle of the specified dimensions of the text, may perhaps alter or throw it aside for some more elaborate novelty. This is both expensive and unnecessary, the fact being that the simplest arrangements are often the best, and I certainly should consider it to be the height of foolishness for any youngster reading the above to think it necessary to replace his arrangements with the device suggested, so, my dear young enthusiast, do be reasonable, and above all, think for yourself, which is after all the most satisfactory process of reasoning.

I am no advocate of slovenliness, but I should think it a work of supererogation to provide winter passages at all where it is palpably impossible for the quilt to fall upon the top-bars owing to the erections of wax and propolis, as is often the case after the removal of a framed excluder. This is perhaps unworthy doctrine—our Editor must correct me if wrong—but I think that I should leave the scraping and levelling to the proper time for spring-cleaning, the spring.

Hurry up, spring, we are looking forward to your advent with eyes of hope undaunted by the disappointments of either 1902 or 1903, and are prepared for the better things of 1904 by no lack of thoroughness in our preparations for the winter which must precede.—L. S. CRAWSHAW, *Ukley, November 16.*

#### BEEES AND RED CLOVER.

[5325.] The following notes, translated from *L'Apiculture*, page 214, will probably be of interest to your readers. They present an explanation of the conflicting statements made by bee-keepers as to the ability or inability of their bees to gather nectar from the red clover blossom, *Trifolium pratense* :—

“T. I. Weston,

“Balham Park Mansions, S.W.

“On August 16, 1890, passing at a little distance from a field of clover in full bloom,

I was not a little surprised to hear a loud humming of bees. I turned into the field, and could satisfy myself that my ears had not deceived me; a great number of bees were foraging on the red clover. Calling to mind certain articles of Mr. Chas. Dadant, and of other notable apicultural authorities, on the superiority of the Italian bee, due to the greater length of its tongue, I wished to see if the bees sucked the nectar directly through the top of the corolla. From the first, among these foragers—and I observed them very closely—I did not see any Italian bee; besides, there is not to my knowledge any Italian stock within several kilometres of the spot. But this is not all. I wished to observe the bee in the act of plundering; one cannot imagine how difficult this is to do. It is almost always necessary to lie face downward on the ground, or, at least, stoop very low, and be placed as nearly as possible facing the sun, to avoid casting a shadow on the flower, which would scare the bee; draw the blossom, if there is room, close to the eyes, or even detach it by a very gentle movement, and do all this quickly, for the bee is hasty.

After many attempts, which I renewed on that and the following days, during, perhaps, more than two hours, I was able to prove—(1) that the bee always inserted its tongue between the calyx and the corolla; (2) that in all the flowers on which I had seen a bee foraging the corolla was always pierced towards its base, very probably by one of the humble-bees which were foraging in the field in numbers almost equal to the hive-bees.

Afterwards I wished to examine how the humble-bees set to work to draw up the sweet liquid. But to observe closely a humble-bee make his attack on the trifolium, or red clover, is still more difficult than to see a hive-bee do it, since most of them pass from flower to flower with extreme liveliness, and are in general very shy.

On those days I believe I distinguished at least four or five species of humble-bees foraging simultaneously on the red clover—one only of these humble-bees, the smallest, a greyish white, if my memory serves, used a direct exploration and introduced his tongue by the neck of the corolla; most of the others, on the contrary, and notably the great humble-bee with orange-circled abdomen, foraged by forcing their tongues through holes in the sides, whether they had pierced them in the base of the corolla themselves, or were content with a practicable perforation made by a precedent bee.

Nearly all the clover heads that I could examine had perforated flowers, to such an extent that a superficial observer would have believed that a corolla pierced at its base was normal, and the corolla intact the exception.

What conclusion can we draw from the above? This: That bees are unable, even exceptionally, to suck the nectar of *Trifolium pratense* by inserting the tongue down the neck

of the corolla; since, on the one hand, the greater number of humble-bees, even to attain the sweet liquid, do not employ direct investigation; and, on the other hand, the numerous side perforations made by the humble-bees give every facility to hive-bees for reaching the nectar. . . .—CH. PERIN, Membre de la Société d'Apiculture de l'Aisne."

#### PRICE OF HONEY.

[5326.] I notice a letter in this week's JOURNAL (5313, page 469) in reply to previous ones on the above, and although appearing in print is quite outside my line, I feel I must make a few remarks on the points mentioned by your correspondent. I think the question of prices a very pertinent one—at least to the majority of bee-keepers—and very naturally it should come up for discussion rather often, even if no practical good comes as a result.

As regards the work done by the Bee-keepers' Association, I feel sure no one can deny the success of their efforts in extending apiculture, and if bee-keepers should look up to them for advice and assistance in any matters of moment to them, what more natural than in this? I have no doubt the County Associations are in many cases helpful—especially to the labouring classes—in this point, and that without exceeding the duties they have undertaken.

Our Lincoln friend looks at the financial side of our pursuit in rather a "rosy light," I fear. When he speaks of "present-day hives with surplus of 100 lb. per hive," does he mean to take that quantity as representing an average? If that surplus could be produced, then, indeed, many would sell at 3d. per lb. and make the pursuit a profitable as well as an interesting hobby. I fear if the matter were gone into the general all-round average would look very small. Throughout the United Kingdom we know there have been many instances of extraordinary amounts of honey taken from stocks in frame-hives; we need not go beyond the present week's issue of our journal; here is a good Cornish "record," but we cannot take isolated cases—we must strike an average, and in doing so must reckon on total failures some years. Even in Southern California, which I suppose for climate and flora is the finest in the world for the bee-keeper, I learnt from Mr. Cowan's most interesting speech appearing in the JOURNAL, the bee-keeper has seasons of total failure recurring in his crop. I was particularly struck by the illustration Mr. Cowan gave of that leading bee-keeper who instanced his experience of the business by showing three seasons—good, poor, and total failure—and thus showing so small an average, viz., 75 lb. per season only.

In order to show how we stand in Ireland as regards produce—to bring the matter nearer home—I will quote from statistics supplied by the Department of Agriculture. The season I instance is 1901, generally acknowledged as

a splendid season, and for which I can personally vouch. What does the average for bar-frame hives work out? 25 lb. only! I am surprised this is so small, and believe it might have been considerably higher. I cannot but think that in this case there was a sad lack of proper management somewhere in view of such a fine summer. My own average about trebled that; consequently I felt surprised to note how low the general average was.

Your correspondent says he sees a "virtue" in low prices of English honey; he also describes as "selfishness" the policy of holding back for higher prices on the part of the producer, whilst at the same time he apparently commends the buyer for his "business ability" in buying in the best and cheapest market! But I, on the other hand, speaking on behalf of the producer, contend that the latter does not realise enough, generally speaking, for his produce. An extra 1d. per lb. to him might mean something worth considering, whilst the same to the general purchaser of a jar of honey would be but a trifle.

Personally, I may mention, I am not much bettered in a monetary sense by keeping bees, but very much in other ways I consider, in the interest, recreation, &c., they afford. At the same time I am not, I regret, in a position that I could afford to lose sight of any help they can give. My friends in general do not see the wisdom of spending so much of my spare time working amongst my bees, and think all that time might be spent to better advantage, but surely we can never all see "eye to eye" in this world.—C. BEE, *County Louth, November 23.*

## Queries and Replies.

[3282.] *Moving Surplus Chambers in November.*—I shall be obliged by your advice under the following circumstances:—On the 3rd inst. I bought a "Wells" hive stocked on both sides with bees. On getting my purchase home I examined the hive, and found above the brood-chambers, on both sides, crates, or body-boxes, filled with standard-frames of comb, some of them containing honey more or less sealed. Being anxious to get all the bees down into the brood-chamber below, I took the first chance and lifted off the boxes of standard-frames, with many bees thereon, and put them into two spare hives by the side of the "Wells" hive, thinking the bees would leave them and house themselves in their proper home. But during the latter part of the same afternoon a bee-keeping friend called, and he told me the bees would in all probability remain where they were placed, if left to themselves; so he kindly assisted me to hive them by shaking the bees off these frames in front of the "Wells" hive and drove them in, placing the quilts over the brood-chamber, and making all comfortable. Since then I have

been grieved to see the great number of dead bees accumulating on the grass near the alighting-board. I see bees repeatedly hustling out of the hive in a moon-struck sort of manner and settle on the grass; they crawl about a short time, and then die. I cannot make out whatever can be the matter with them. My friend looked down between the frames, and said he was of opinion there was plenty of food, and that I need do nothing more to them but shade out the bright light during snow-fall until February. The hive and its contents are very heavy, so that I am inclined to believe what he said. The roof is thoroughly watertight, and everything, so far as outward appearances are concerned, seems healthy and comfortable. There is no unpleasant smell in the hive, which I understand is the case when the hive is diseased; and there is nothing to be found, on examining the little corpses, to indicate disease. I feel anxious to do something to prevent this distressing process of dying off, and should be grateful for your advice, fearing that if this kind of thing goes on there will be no bees left for the next spring. Would it be advisable to place a cake of candy under the quilts over each colony? Thanking you in anticipation for your advice.—A. S. B., *Anerley, November 21.*

REPLY.—The proper course would have been to remove the quilts from the upper body-boxes and drive the bees down with smoke; then lift out the frames one by one and shake or brush the bees from each comb as removed into the box without removing the latter until all the bees had gone below into the brood-chamber. On such cold days as we have had lately bees are half torpid, and cannot take wing at all; therefore, methods that would be quite proper in warm weather are useless when bees are unable to fly owing to the cold. We cannot understand the bees leaving the hive to "crawl about and die," unless care was not taken to return the bees of each upper chamber to *their own side* of the "Wells" hive. Your bee-friend should endeavour to explain this latter trouble by making an inspection of the respective compartments of the double hive and see if all is right there. Many things may become clear after inspection that are impossible to explain from a distance.

[3283.] *Feeding and Preparing Bees for Winter.*—Herewith I am sending you sample of syrup I gave my bees on October 1. They readily took the first lot from a feeder holding about 1 pint, but after that scarcely touched it. I was very careful to put the right amount of naphthol beta as per printed directions (in fact, had it measured by a chemist so as to be exact); but although I gave it warm and in the evening, the bees hardly touched it. I set the regulating feeder to mark "5," which I take to be rapid-feeding; after that I gave them a cake of candy, and on looking a fortnight later found it quite gone. I have therefore put on another cake. 1. I am not quite sure

if they have enough food, so please say if it will do harm to look at the cake of candy about once a month, or should I leave it now to chance? 2. I should also like to know if it is advisable, after putting on the super filled with chaff, as shown on page 40 of "Guide Book," to cover the loose chaff in super with anything—of course, I mean in addition to the quilts on top-bars below. I have laid a piece of felt above the chaff, but it afterwards struck me that this might do away with the ventilation. 3. I am asking about the syrup for future use; of course, I know it is too late to use now, but I want to know where it is wrong.—G. L., *Weybridge.*

REPLY.—1. It is well known that a "regulating feeder" filled with syrup is not nearly so attractive to bees at this season as a cake of candy. We invariably make this fact plain to readers. If food is short, give another cake as often as consumed. 2. No. 3. Reply to first query applies here.

### Notices to Correspondents & Inquirers.

\* \* *Erratum.*—Referring to letter on "The Honey Harvest in Cornwall" (5314, page 469), owing to printer's error, the name of Mr. W. Rosewarne is printed "Rosmann."

G. CURRIE (Leighton Buzzard).—*Bee-keepers' Association for Bucks.*—We have had no official notification of a County B.K.A. for Buckinghamshire, though we believe a gentleman resident near Slough is making strenuous efforts to establish an Association for the county, and we will draw his attention to your request.

RHYS EVANS (Edenbridge, Kent).—*Bee Parasites*—The parasite referred to is the *Bravula cocoa*, or blind louse, and has been repeatedly described and illustrated in our pages. It is also shown in the "Guide Book" (page 160), illustrated by a photomicrograph taken from life.

#### *Honey Samples.*

F. C. (Kent).—We do not care to even guess the source from which sample of honey (?) was gathered; but it is poor stuff from whatever source, and is also becoming sour from fermentation.

ARDENADH (Islay).—The honey is rather coarse in flavour, but quite wholesome and fit for table use if high quality is not expected. Sample of sugar (very coarse yellow crystals) would do for making syrup for spring use, but is not suitable for winter stores or candy-making.

LLANBERIS (Carnarvon).—All four samples being granulated and having neither pronounced flavour nor aroma, we cannot pretend to fix the source from whence they came. No. 1 is dark in colour, coarse in grain and flavour, and is beginning to ferment. Nos. 2, 3, and 4 are not more than second or third grade in quality.

## Editorial, Notices, &c.

### BEE AND HONEY SHOWS.

#### DEALING WITH PRIZE EXHIBITS.

The statistics regarding bee and honey shows in 1903, which appear in tabulated form on page 483, while arousing general interest among bee-keepers, will have especial significance for those who have already been prominent as exhibitors, and, in a lesser degree, for all whose ambition it is to secure an honourable position on the show-bench. On the other hand, the tabulated returns are satisfactory to the whole industry in respect of the number of exhibitions held, and their value in promoting the use of honey as food, by the opportunity afforded to the public at large for inspecting bee-produce in its best and most attractive form. From the latter point of view it is very encouraging to note how widespread and continually extending is the interest shown in the bee-department by visitors to agricultural and horticultural shows.

Our present purpose, however, is not to deal with the whole subject of Exhibitions, or their possible advantage to bee-keeping as a whole, but to invite attention, first, to the best means of securing more entries in the various classes; and, second, how to secure this desirable end without lowering the standard of quality established by the ablest masters of the craft.

The compiler of the table printed on page 483 holds strong views on this question, and has also the courage of his convictions, as shown by the motion he brought forward at the B.B.K.A. meeting on the 18th ult. For easy reference we reproduce it as under from page 471 of our issue of November 26:—  
 "That at shows to which the B.B.K.A. make contributions to the Prize Funds the first prize exhibit in the classes for comb honey, light extracted honey, and wax may become the property of the show Committee of the B.B.K.A. at a price to be fixed and stated in every show schedule." It was also resolved that at the "R.A.S.E. Show in 1904 the prices at which prize lots may, at the discretion of the Show Committee, be purchased, should be as follows:—Sections, 15s. per doz.; extracted honey, 15s. per doz.; wax, 2s. per lb."

The first motion, which was, we learn, "carried by a small majority," has so important a bearing on future bee-shows that we hope those mainly concerned will lose no time in making their views, *pro* and *con*. known in our pages, in order that there may be no miscalculation in gauging the effect beforehand on the entries at future shows.

That a few men should carry off the bulk of the prizes is not a pleasing reflection; but the question is how to fill the gap if leading exhibitors refuse to enter under the proposed arrangement. Correspondence on the subject will be awaited with much interest by all.

### BEE-KEEPING.

#### ITS EDUCATIVE INFLUENCES.

By *W. H. Harris, B.A., B.Sc., C.C.*

(Continued from page 472.)

#### MORAL GAINS.

For the full and harmonious development of our tripartite—or rather triune—humanity, there are required proper outlets for the energies of "body, mind, and soul." Whenever the forces of any two of these divisions are brought into active exercise, the demands of those of the remaining one will soon make themselves heard. Space will not admit of our illustrating this remark to any adequate extent. We can only say that, since for all, young and old, relief must be found from too trying physical, mental, and moral conditions, it becomes important that, so far as possible, such relief should be unattended by any serious drawbacks. To many people "sport"—whether it be racing, hunting, shooting, or fishing—seems of necessity to involve cruelty; and it is argued that, if this is the case, moral harm must ensue to those who participate in it. It is impossible here to discuss this question. Again, there are many who bewail the evils which have grown up around our fine national games of cricket and football—the inordinate time and excitement devoted to them by men and boys; the betting indulged in with regard to their issues, and the consequent suspicions, in some instances, as to the genuineness of the play. Here, again, we must not attempt any debate. Our object in the foregoing remarks is simply to say this good word for bee-keeping, that, while affording pleasant and healthful recreation, it has no moral drawbacks. More than this, we believe it to exert positive and excellent ethical influences. Among them we venture to indicate the following points:—

First: *Among the working classes experience proves that money spent on bees and bee-keeping is very often so much diverted from the public-house, and from the evils attendant on the excessive use of alcoholic stimulants.* More than this, the production and sale of honey and wax—the result of wise and skilful work—tends to promote care and thrift in other directions. The home becomes more comfortable and tidy; the wife and children are better fed and clothed; and the man himself feels a pride in what his hobby has enabled him to do for his family. By way of fact in this connection, we may mention that a policeman of our acquaintance has, with beaming face, told the writer that during the past season (1903) his three or four stocks of bees have by their produce enabled him twice to give his delicate wife a much-needed change of air, while the strengthened wife maintains their home in exemplary neatness.

Secondly: *Interest in such wonderful and serviceable insects as bees begets sympathy with all living things.* It is true that this point

could not have been urged so long as the old and destructive methods of apiculture prevailed; but modern bee-keeping teaches that a certain value attaches to the life of every worker in a hive; that the crushing of a single one during manipulations is a cardinal error; and that weak stocks, instead of being destroyed, are to be united to others to build up strong communities. Then, also, when the marvels of bee-structure and habits have been learnt, a further ethical benefit is likely to accrue.

Thirdly: *Wonder and reverence for the works of God, coupled with adoration of the Creator, may be aroused and fostered.* The degree to which these happy results may be expected will, no doubt, depend in a measure on the spirit which pervades lessons, lectures, and books, through which information is obtained; and yet, even without help from others, many an intelligent boy and girl—to say nothing of thinking men and women—will be led to “look from Nature up to Nature’s God;” and when this much has been accomplished, some basis of a reliable morality will have been laid. Moreover, if the words of a French writer are true—“On n’aime pas les abeilles: on se passionne d’eux” (People do not simply like bees: they become passionately fond of them)—bee-enthusiasts will be pretty sure to come to appreciate the sentiments of the poet Coleridge, who says:—

“He prayeth well who loveth well  
Both man and bird and beast;  
He prayeth best who loveth best  
All things, both great and small;  
For the dear God who loveth us,  
He made and loveth all.”

Fourthly: It is well known that *bee-keeping very decidedly promotes a spirit of comradeship among those who pursue it.* Knowledge gained from books or from experience; instruction in management and manipulations; help in more or less serious difficulties; readiness to make exchanges or to supply wants; secrets of success and non-success, and other ingredients of good-fellowship, are all freely put at the disposal of co-workers in apiculture. And herein is a very distinct moral gain; for whatever checks envy and jealousy, and leads to unselfishness, sympathy, and open-handed effort to help others, leaves a strong imprint upon general character and modes of feeling. There is one more point which has a special bearing on the ethical teaching of young people. Beyond the well-known lines of Dr. Watts—

“How doth the little busy bee  
Improve each shining hour”—

there are many facts which a duly instructed and interesting teacher can set before the eyes of boys and girls to enforce moral obligations. Let us glance at a few such facts. A visit to an apiary will exemplify the *tireless energy and industry* with which the earnest workers

pursue their daily toil. The importance of the maxim, “*one thing at a time*,” is shown by each nectar-gathering bee confining herself to the same species of flower during the whole of one foraging expedition. “*A place for everything, and everything in its place*” is carried out in the provision of different shapes and sizes of cells for special purposes, and in the arrangement of honey, pollen, and the brood of three kinds in the combs. The Pauline principle, “*He that will not work, neither let him eat*,” is fulfilled in the expulsion of the non-producing drones so soon as stores seem likely to be no longer forthcoming. *Adaptation of means to ends* is seen in the making of “transition cells” near the tops of combs, and when drone-rearing is to take the place of “worker-brood.” *Ingenuity*—almost creative is displayed in the efforts to replace the loss of a queen by building special cells, and placing in them eggs, which, under ordinary circumstances, would become mere “workers;” but which, under the influences of particular food and environment, develop into “mother bees.” *Altruism*—the care for others rather than self—is manifested by the efforts of the workers to supply stores for future generations, not of their own children—for they never have any—but for unborn or growing-up brothers and sisters. *Economy* is taught by the way in which all undue expenditure of wax is avoided, and every drop of honey is utilised, unless taken away from those who have made it. *Patience and perseverance* are writ large on all that the bees do inside and outside their hives; and the *faithful and patriotic doing of one’s best at all costs* is taught by the circumstance that the busy toilers expend their energies in the summer-time to such an extent as leads to a quiet and, we may believe, a painless, and, possibly, happy death after six or seven weeks of labour. So much for some of the good qualities exemplified by bees. But, unfortunately, the possession of some of an opposite nature may serve the teacher for moral lessons. *Unreasoning rage*, leading to the use of the sting with consequences worse to the bee than to the person stung. *Insatiate greed* for sweet things, resulting, when there is an unexpectedly large supply, in gorging to the degree of helplessness, and often, also to furious and fatal fight. *Robbery of the weak and ill*, ending in the contraction of malignant disease, and its conveyance to previously healthy stocks. *Lazy individuals, who try like sneaks to get at stores in hives not their own*, are seen to be driven off by exasperated guards, often with the infliction of a sting, which means a death penalty. These are some of the maxims and facts which, as we have said, an intelligent bee-keeping teacher may forcibly impress, by *object-lessons*, on the minds of children, or those of older years.

In this brief sketch we trust we have made good the statement that apiculture possesses inherently great educative influences—physical, mental, and moral.

BEE AND HONEY SHOWS.

AS ADVERTISED IN "BRITISH BEE JOURNAL" DURING SEASON OF 1903.

To Editors of the BRITISH BEE JOURNAL.

GENTLEMEN,—Can you find room in your valuable paper for the enclosed statistics of the honey shows of the past season? The figures differ slightly from those given at the Conversazione at Jermyn-street, as more details have been placed at my disposal. I shall be pleased to undertake a similar work for next season if the Secretaries of shows will forward to me, through you, the necessary schedules and particulars—I am, &c., T. I. WESTON, Vice-Chairman B.B.K.A.

No.	Date, 1903.	Name of Show.	Where Held.	Value of Prizes.	Number of Prizes Offered.	Number of Entrants.	Number of Competitors.	Remarks.
1	June 9, 10.	Essex Agricultural Society	Bishops Stortford	£13 15 6	51	75	*	
2	" 23-7	Royal Agricultural Society	Park Royal, L'don	70 5 0	106	203	81	44 certificates.
3	July 15, 16	Staffordshire Agricultural Soc.	Lichfield	18 16 0	54	*	*	1 gld medal, 5 sil, 7 br.
4	" 16, 17	Lincolnshire Agricultural Soc.	Lincoln	28 0 0	*	150	*	
4	" "	Lincolnshire B.K.A.	13 Local Shows	7 14 0	*	*	*	Supplemented locally
5	" 22	Broughton, Hampshire	Broughton	6 13 6	27	33	*	
6	" 22, 23	Glamorganshire B.K.A.	Cardiff	15 13 6	*	111	*	
7	" 23	Hants B.K.A. (Wallop Branch)	Wallop	4 12 0	*	71	*	
8	" "	Bristol and District B.K.A.	Henbury	12 6 0	50	117	40	3 & B mdls 450 lb. stgd
9	July 30-Aug. 3	Lancashire Agricultural Soc.	Manchester	32 15 0	39	103	*	3 S. 2 B. cert.
10	July 29	Hants and Isle of Wight B.K.A.	Swanmore Park	9 4 0	37	72	*	1 S. 1 B. cert.
11	Aug. 3	Andover Horticultural Society	Andover, Hants	3 17 6	17	63	*	1 B.
12	" 4	North Norfolk B.K.A.	Melton Constable	6 2 0	28	98	*	S. B. C. 603 lb. staged
13	" 4	Leamington S. Mary's Hort. Soc.	Leamington	3 16 6	*	36	*	
14	" 6	Cheshire Agricultural Society	Nantwich	8 17 6	26	77	29	S. B.
15	" "	Northampton B.K.A.	Kingsthorpe	8 12 0	44	130	*	1 S. 1 B. 8 cert.
16	" "	Worcestershire B.K.A.	Madresfield	4 12 0	*	41	*	S. B. C.
17	" 12	Radstock Horticultural Assoc.	Radstock	*	*	*	*	
18	" "	East Kent Honey Show	Wye	7 14 0	29	110	51	
19	" "	Chippenham District Hort.	Chippenham	6 11 6	23	35	*	
20	" "	Devon B.K.A.	Tavistock	8 10 6	25	77	27	
21	" "	Bristol and District B.K.A.	Chew-Magna	*	*	*	*	
22	" 13	S. Saviour's Hort. & Indust. Soc.	Bath	5 5 0	35	40	*	S. B. cert.
23	" "	Goole & District Agricult. Soc.	Goole	7 2 0	25	*	*	
24	" 15	Chorley Agricultural Society	Chorley, Lancs.	1 15 0	6	16	13	
25	" 19	Wiltshire B.K.A.	New Swindon	8 0 6	44	61	*	
26	" 19, 20	Shrewsbury Horticultural Soc.	Shrewsbury	17 16 6	62	132	*	2 S. 14 B. 1 cert.
27	" 22	Hawkhead Horticultural Soc.	Hawkhead, Lancs.	8 7 0	27	28	*	S. B.
28	" "	Barnton Horticultural Society	Barnton, N'thwich	3 5 9	21	43	*	
29	" 25	Cartmel Agricultural Society	Cartmel, Lancs	6 6 0	18	44	25	S. B.
30	" 26	Berkshire B.K.A.	Reading	9 0 0	21	48	*	
31	" 27	Llangollen Horticultural Soc.	Llangollen	4 15 0	22	61	*	
32	" "	Montgomery Horticult. Show	Montgomery	*	*	*	*	
33	Sept. 5	South Scotland B.K.A.	Dumfries	16 5 6	82	177	*	2 G. 3 S. 2 cups.
34	" 5, 12	Confectioners & Bakers Exhbn.	London	45 5 0	55	108	*	
35	" 8	Oxfordshire B.K.A.	Woodstock	3 0 0	14	77	*	
36	" 9, 10	Derbyshire B.K.A.	Derby	18 6 0	49	97	*	2 S. 2 B. 3 cert. cup.
37	" 17, 19.	Surrey B.K.A.	Crystal Palace	17 10 0	65	283	*	Medals.
38	" 19, 26.	Grocers' Exhibition	London	45 5 0	54	165	*	
39	Oct. 6	British B.K.A. (Dairy Show)	London	23 2 6	34	125	*	Challenge Cup Mdls.
				Total	£518 14 9			

\* Where marked with asterisk no information was obtained.

PRIZE WINNERS AT HONEY SHOWS.—SEASON, 1903.

After tabulating the prize winners at 34 shows whose names have been given in the reports published in the BEE JOURNAL, the results are as follows:—

The number of winning Competitors was	...	...	383
The number of prizes won by them	...	...	1,039
Names occurring 1 to 5 times	...	...	337
Number of prizes won by them	...	...	579

An average of 1.7 each.

Names occurring 5 times and under 10	...	...	26
The number of prizes won by them	...	...	157

An average of 6 prizes each.

Names occurring 10 times and upwards	...	...	20
The number of prizes won by them	...	...	303

An average of 15 prizes each.

From this it appears that 20 persons took nearly one-third of the prizes given during the season. *Balham Park Mansions, November 21, 1903.*

## Correspondence.

The Editors do not hold themselves responsible for the opinions expressed by correspondents. No notice will be taken of anonymous communications, and correspondents are requested to write on one side of the paper only and give their real names and addresses, not necessarily for publication, but as a guarantee of good faith. Illustrations should be drawn on separate pieces of paper. We do not undertake to return rejected communications.

Communications relating to the literary department, reports of Associations, Shows, Meetings, Echoes, Queries, Books for Review, &c., must be addressed only to "The Editors of the 'British Bee Journal,' 10, Buckingham-street, Strand, London, W.C." All business communications relating to advertisements, &c., must be addressed to "THE MANAGER, 'British Bee Journal' Office, 10, Buckingham-street, Strand, London, W.C."

\*.\* In order to facilitate reference, Correspondents, when speaking of any letter or query previously inserted, will oblige by mentioning the number of the letter as well as the page on which it appears.

### AMONG THE BEES.

[5327.] A "Ne Plus Ultra" Hive.—A bee-keeper—and a bee-expert, I think—long ago promised us a description of a wonderfully perfect hive of his invention, which was designed at least to perform a multiplicity of other duties, in addition to being a nursery for rearing young bees, and a receptacle for storing surplus honey, when gathered and manufactured by the workers. At the time several bee-keepers showed a commendable desire to obtain particulars of this paragon amongst hives, which was (designed, at least) to perform so many separate duties. I now wish to ask this gentleman, Mr. Gray, Derbyshire, if he was really "serious" in making the statement that he had such a hive in his possession as the one he described in 4782, page 213, Vol. 1902; because, if he has, it is too selfish of him to keep such a boon from the fraternity. I think Mr. Gray was inclined to severely censure and condemn selfishness in others; yet, for nearly two years, after dangling this *multum in parvo* of a hive before our greedy eyes, he has (selfishly) kept it locked up in his bee-house, while we have been kept on plodding away with the old, commonplace hives. I wonder if Mr. Gray is still a bee-keeper; or did the Philistines demolish him, and kill all his old enthusiasm? Or, has the wonderful hive, designed to do so much, proved but an *ignis fatuus* after all, and, like many another invention "designed" to do everything, end in doing nothing properly? Seriously, I hope Mr. Gray will write his promised description, so that all may judge of the utility and profitableness of his invention.

*Hive Roofs.*—Certain points about the apiary require to be constantly drawn attention to, and the instructions ament the cure or remedy as constantly reiterated, so that they might almost be stereotyped, and periodically reproduced at certain seasons of the year. Amongst them is the important one of hive roofs. When the rain pours in such floods, and so incessantly, as it has done now for nearly two years, even the best and soundest

timber to all appearance may "give" a little. The fault may be small and apparently insignificant, but frequently therein lies the danger. As the sage old proverb hath it—"The drop hollows the stone, not by force, but by constant dropping;" so, a small and tiny crack, admitting very little moisture, it may be, is sufficient to allow that gentle percolation, slow, but sure, through the coverings, which in time finds its way down to the winter cluster. When frost follows, it chills the saturated interior, bringing death and destruction with it, for the moistened mass coagulates; and so ends the career of even the best stock. From what was at first a slight and insignificant soak, there follows this dire result. It is well, then that proper measures should be taken to ascertain that all hive-roofs are rain-proof, because no enemy, without or within, is so inimical to the bees' comfort and wellbeing during the period of repose as internal damp when present even in a modified form. A good and efficient material for covering partially-worn hive-roofs has yet to be discovered, apart from zinc, and most of those now recommended too often prove a delusion and a snare. Surely it should not pass the wit of man to find such a small and simple contrivance, which would be at the same time light, neat, easily put on, and thoroughly water-proof!

*Wax and Wax Cakes.*—I have often wondered at the very large wax cake obtained by Mr. Wells, of double-hive fame, and wished that I could produce anything approaching 25 per cent. of his take. How is it with the average bee-keeper, I wonder? Could we not get some statistics on the subject, which could be compiled on some uniform system, to show all of us who are on a low-down rung of the ladder how we may climb up higher and attain nearer the apex of perfection? In spite of all the directions given in the past, there is room for further improvements and additional instructions, which might be helpful, not only to beginners, but also to old stagers in the craft. I cannot even now obtain more than 10 oz. or 12 oz. from a hive containing ten combs. I have called attention lately to the small returns of beeswax obtained in Ireland, but I strongly suspect that reliable statistics might show us up no better than the sister Isle.

*The Past Season.*—I have had a number of communications condoling with me on the very poor season we have had; but, personally, I have no special reason to complain, as I had taken of from fifty-seven down to eighteen sections off every hive. This contrasts very favourably with others somewhat similarly situated, both north and south. A Dumfries bee-keeper reports very little surplus indeed, and none from the heather; and a Ross-shire enthusiast, with stocks strong to excess almost, sends me the same story—not a heather section for sale. My honey sold out before the end of September, at my own price



to old customers, and I could have disposed of large quantities since at 1s. 6d. per lb. if I only had it. Hives were winter packed with ample stores, and bees so strong that, other things being favourable, they should come out in spring fit for an excellent season's work in that superb season we anticipate, 1904. One good year should surely follow two bad ones. At least, we will live in hopes of this being the case. *Fac et spera!*

*They say—What say they? Let them say!*—I quite sympathise with the smouldering spirit of resentment evoked by the uncalled-for strictures on teachers at the recent Bee Convention. But as only one single individual is now implicated—all others having resiled from their unfriendly attitude or explained away their words—it might be best to leave this solitary mortal in a state of grand isolation, hugging to his heart his pet theory. To seek to convince him that he was wrong might end in leaving him “of his own opinion still;” and the better way would undoubtedly be to adopt the spirit of the words with which I have introduced this paragraph. They are quoted from the inscription over the entrance to Marischal College, Aberdeen, and they are words of infinite wisdom, as many from ripe experience can testify. They say. What say they? Let them say!—D. M. M., *Banff*.

#### MOOT POINTS IN BEE-KEEPING.

[5328.] Your correspondent, “A Worcester-shire Bee-keeper” (5303, page 458), with his experience of thirty years, is much older in the craft than myself, yet in the absence of any more authoritative communication I should like to assist in a settlement of the points he raises, although from his own expressions of opinion I judge that he is not himself in any great doubt. This is as it should be, seeing that his long experience must have enabled him to test, or inform himself upon, each point raised.

As to “moot points,” they are not without their value, speaking generally, in that there is still left to us in these days of well-threshed-out problems subject matter for discussion and friendly disagreement, and it is natural that where there are “many men” their “many minds” evolve many methods, each of which may have something to recommend it. On some subjects, therefore, including bee-keeping, one can do little more at times than lay down general principles on broad lines, recording the details of *personal experience* simply or largely, *as such*.

*First, as to the qualities of the Italian bee.* There is a timely article from the pen of G. M. Doolittle in the current issue of *Gleanings*, which deals fully with the tendency of these bees to prefer brood-nest storage, and as the article may possibly appear in the pages of the B.B.J. I will only say that it accords with my own limited experience with these bees in our own country.

It appears to me that almost any stock of any race which is given the opportunity to accumulate stores below will not “hustle” to the extent that is seen where the storeroom is above a crowded brood-nest. Cause and effect are very close here, but the bees seem to be more “content with such things as they have,” if I may so put it, when there is abundance of store approximate to the position for the future winter cluster.

Some races of bees will no doubt suit some districts better than others, as where, for instance, there is an excess of pollen or propolis. Different racial characteristics are also not surprising, as varying qualities may be easily developed in strains of the same bee.

Some races, too, are far more hardy than others, and I shall be surprised if the Italian bee is satisfactory in this respect, say, so far north as Banff, and although it may be possible that a strain can be improved with a little Southern blood, the reverse is possible also.

With respect to “temper,” it is generally conceded to be the case that the first hybrid to an Italian strain, viz., to a black drone, is of a vicious disposition, but this rule is not without exception, some bees so crossed possessing at times very good working qualities.

But if a hardy hybrid bee is desired, it is far better to go at once to some skilled breeder who has had the opportunity of weeding out undesirable traits for generations past, as a small bee-keeper cannot be very successful in producing hybrids from the drones of only one or two Italian queens.

*With regard to pervious quilts,* difference in practice will no doubt continue, this being a question for the bee-keeper to decide for himself. It is quite conceivable that “district” may affect this matter, according as it is humid or not; then besides the construction of hive, strength of stock, &c., may also be factors for consideration.

Personally, I prefer the impervious quilt, either American cloth, or, still better, a thin quilt covered with propolis. I think that such a quilt may, perhaps, prove warmer, and will afford better foothold than American cloth, but it is absolutely essential that an impervious quilt should be well protected to prevent radiation of heat, and consequent condensation of moisture.

*Size of entrances.* This also must, I think, depend to some considerable extent upon locality, position of hive, prevalence of winds, strength of stock, &c.

I do not care for a wide entrance, which may have to face half a gale, but if it were possible to adequately protect this, I should desire the better ventilation thus afforded. Experiment has, however, so far shown me that there is not much difference apparent between stocks thus differently prepared, and other factors *must* be considered when making such arrangements permanent. Combs which

run towards the entrance may ventilate better than those parallel, and therefore allow of a smaller winter door. I mention such things because your correspondent is, I imagine, asking for a dogmatic pronouncement upon these and kindred matters, which all must obey, whether or no.

My own hives allow of an empty chamber below the brood nest, and I take advantage of this additional air-space thus afforded, and reduce the entrance accordingly. I can, however, provide for slight ventilation both at the top and bottom of this chamber, thus ensuring a gradual change of air with any variation of outside temperature.

*Boiling of Syrup.*—There are, of course, two forms of syrup for spring and autumn use, and there seems to me no more use in boiling the former than there is absolute necessity to provide cane sugar for this purpose, as the syrup is at once converted into bees, whilst some good authorities maintain that under no circumstances is boiling required. I would, however, prefer, when feeding for winter stores, to boil the thick syrup, as this process provides for the inversion of the cane sugar and its truer approximation to the natural food of the bees. Bees will winter upon dissolved sugar, and it is much easier to prepare, but the cooked form is preferable with its consequent inversion, the process of which may be hastened by the addition of vinegar, as in the "Guide Book" recipe.

There are undoubtedly both right and wrong ways of accomplishing most things, but there is sometimes more than one good or permissible way, and where the better costs proportionately more in labour or other form of payment than the slightly inferior way, there is a loss which requires compensation.

The question is often thus resolved into one for each to decide for himself, which of two good methods is the better for *him* to adopt.

In the case of "A. W. B. K.," his results in such a poor season as the present prove that he has either been very fortunate in his locality, or there is not much amiss with his methods, and that it is probably not worth his while to make any very drastic change either of bees or bee management.—L. S. CRAWSHAW, *Ilkley-in-Wharfedale*, Nov. 16.

#### A MOOT POINT IN BEE-KEEPING

##### WINTER QUILTS.

[5329.] Referring to the above subject, as no other correspondent has replied to the letter of "A. Worcestershire Bee-keeper" in the *JOURNAL* of the 12th inst. (5303, page 458), may I be permitted to do so, though no longer a bee-keeper? The subject of quilts in winter is one in which I took considerable interest.

I kept bees for eleven years, and, except at first, I always used American cloth in winter, and never lost a single hive or *nucleus* but one which perished through an accident, though I only kept two hives and regularly wintered

one or two nuclei on four or five standard frames.

The nuclei in winter always had a cork dust dummy on each side, and the hives had double walls with cork dust or crumpled paper between, and all had packed floor boards, to which I attach importance.

The great importance of impervious quilts (in addition to diminution of propolis) is that you can put anything above the quilt—wooden boards, felt, newspapers, bricks, &c., and need not bother about ventilation. The inside keeps quite warm—the bees eat wonderfully little food—and there is no need for winter passages. I found no sign of damp except a little mould on outer frames of the nuclei.

If the American cloth is kept warm above, then the cold does not strike through and condense moisture in the inside, just as, in a warm room in frosty weather, moisture condenses on the window panes and not on the walls.

The entrances of the hives were kept open the full width of the hives and the entrances of the nuclei also were kept pretty wide.—T. F. L., *Brondesbury*, November 28.

#### BEE-KEEPING IN NORFOLK.

##### AN AMATEUR'S EXPERIENCE.

[5330.] I am a constant reader of the *B.B.J.*, and up till the present have not seen in its valuable pages any news from my native county of Norfolk. I am always interested in reading the accounts that appear from other counties, how some bee-farmers have done well, some moderate, and some so badly that it makes one think what a queer country ours is for bees to be sure! The relating of my experiences as an amateur bee-keeper may, therefore, perhaps be an encouragement to some of my amateur bee-friends. It so happened that in the year 1900 I was married to the daughter of a rather notable Norfolk bee-keeper (Mr. W. J. Norman, Harpley Mills) and I presume he thought the new son-in-law had better have some bees, as his daughter would still want some honey. Anyway, he gave me, as a wedding present, a stock of bees in a frame-hive, and this was the start of my bee-keeping. Since that time till now my aim has been to increase the number of hives, and every year I have had the pleasure of increasing my intake of honey from the bees, for which I have a ready sale at a fair price. It is my hobby and affords me much pleasure, while it brings a good profit. There is only one annoying thing in connection with the honey trade that I have to complain of, and that is the way railway companies smash the consignments entrusted to them. No matter how carefully packed, it seems to me there is bound to be a smash.

Respecting the late season, bee-keepers in Norfolk felt the bad weather like others in the country. Bees did nothing till the third week in June, then they began in earnest and made

up for lost time. I began with seven stocks, spring count, and finished with eleven. I got four swarms, which I united in pairs, and put each doubled swarm into a hive holding fifteen frames. The other two extra hives are stocked with driven bees got from neighbors for the trouble of driving.

Respecting my take of surplus honey for 1903, I can congratulate myself, having secured 4 cwt. 4 stone; not only so, but, as far as I have seen in the B.B.J., one of my hives holds the record for 1903. I worked a fifteen-frame hive entirely with boxes of shallow frames (with "W.B.C." wide ends) and, for surplus, I filled 1 gross of bottles, *i.e.*, 10 stone 4 lb., from this one stock. It was a very strong lot.

I am sure very few amateurs would be discouraged at such a result as mine shows, but if they will only follow carefully the advice given in the JOURNAL and "Guide Book" they cannot fail to meet with success.

I am sending a photo of my apiary for inclusion in "Homes of the Honey Bee," if you think it worth a place in your valuable paper. It might be an encouragement to amateurs.—WILLIAM F. FAKE, *Great Massingham, Norfolk.*

#### DR. LIVINGSTONE AND BEES.

[5331.] Perusing that ever-entertaining book, Dr. Livingstone's "Travels in South Africa," I came across several passages which interested me as a bee-keeper, and I thought that perhaps you might think them of sufficient interest to other bee-keepers to reproduce them in the JOURNAL.

First—there is the description of a beehive as made by the natives of a place rejoicing in the musical name of Nyamoana, where, the Doctor remarks, the ladies are the chiefs (perhaps following the example of the bees). The way they make their hives is as follows: They cut two incisions round the trunk of a particular tree, such incisions being about five feet apart; they then make a perpendicular slit from one ring to the other, opening up the bark and removing it from the tree; when this cylinder of bark is removed it springs back into the circular form, and the joint is stitched together. The ends are then closed with coils of grass-rope sewn together as skeps now are, a hole being left in the centre of one of the coils for the ingress and egress of the bees. The hives, we are told, are placed in a horizontal position on high trees in different parts of the forest. Bee-tending under these circumstances and in the costume of a central African must be highly exciting!

The Doctor in several passages mentions a bird called the Honey-guide, which assumes by nature the office of conductor to localities where honey exists. He used to avail himself of the services of this bird until he found that his conductor was an unauthorised one, inasmuch as the bees in that part of the country where he then was were all owned by some one;

and he states: "After having ascertained this, we never attended the call of the honey-guide, for we were sure it would only lead us to a hive which we had no right to touch."

In a place called Londa, however, they were able to avail themselves of their little conductors, which, he states, "were very assiduous in their friendly offices, and enabled my men to get a large quantity of honey." In this place, he writes: "We often met strings of carriers laden with large blocks of this substance (beeswax), each 80 lb. or 100 lb. in weight," and "here we never saw a single artificial hive: the bees were always found in the natural cavities of mopane-trees." In another part he writes: "Bees exist there in vast numbers, tribute being paid in large jars of honey; there, however, the wax, being considered useless, is thrown away."

One is curious to know, cautioned as we are in this temperate country against placing hives where the sun plays too freely on them, what happens to the honey-laden combs in the tropics. Perhaps bees, however—as manufacturers of india-rubber goods do, I believe—modify the consistency to suit the climate. If this be so, beeswax from the tropics should be harder than the home production. Our Editors will doubtless know if that is so.—A. E. B., *Anerley, November 20.*

[We think not.—EDS.]

#### BUYING BEE GOODS.

##### CARELESS PACKING.

[5332.] May I be allowed to give a sample of my experiences in buying bee goods from careless dealers advertising in the BEE JOURNAL, as it may be a caution to others? On October 5 I wrote to an advertiser for three dozen drawn-out combs at 5s. per dozen. I had bought several stocks of driven bees, and therefore wanted them immediately. A reply came stating that he had just three dozen left and could send on receipt of cash. I at once sent P.O. for 15s., but no combs came and no word of reply. Consequently, as bees were coming to hand the following week, I was compelled to buy frames and foundation, and take some combs from other stocks to hive the driven bees on. I then wrote asking for either combs or honey by return, but received no reply. On October 20 the combs came in a bag, thirty-nine in all, comprising nine good ones, eleven damaged ones, and nineteen frames and combs which were broken to pieces. I opened the bag at railway station and let the officials see their condition, but they refused to take any responsibility, as the contents of bag were not properly packed. The combs had been put up wet with honey, which had been left in combs after extracting, and honey was running through the bag when received. I wrote asking the seller what he was going to do by way of amending matters, but got no answer at all. Had he replied, I should have been pleased to meet him in

arranging terms fairly and equitably. By the use of a "Quaker Oats" box he could have easily packed the frames of comb to prevent them tossing about, and fastened the top securely with either the lid or a piece of sacking, with little or no more cost for carriage (the bag cost me 2s. 6d.). And now the combs are as described above. After this experience I shall in future only buy goods on "deposit system," and should advise others to do the same when dealing with those not known as reliable men. By so doing one is better able to get satisfactory results.—WM. D. WRIGHT, *Old Benvell, Newcastle-on-Tyne.*

[We have withheld name of dealer referred to for obvious reasons, but would be glad to have a line giving the "other side of the case"—not necessarily for print—failing which we must take some note of the matter for the credit of fair dealing.—EDS.]

## THE BEE SEASON IN DEVON.

### SOME NOTES ON CANDY-MAKING.

[5333] In the midst of multifarious occupations I never miss reading the many brief reports already published in your paper, and find them very interesting. I beg to send a few words on the doings of my own bees the past season.

Notwithstanding the unfavourable weather, I have taken nearly 1,800 cwt. of honey from twenty-three stocks (spring count). Most of it is good in quality and lighter coloured than in previous years. I enclose a sample of what I use for making bee-candy, and will value your opinion on its quality. I agree with Mr. W. J. Farmer and others that we should consider the interests of the craft in general, and not put our honey on the market at too low a price. It is easy to get prices down, but once down very difficult to get them up again, no matter how poor the honey crop may be, as Mr. Woodley rightly remarks in his recent "Notes by the Way." I suggest that those who are unable to sell all their surplus honey might use a greater part of it for household purposes or for making mead, seeing that cider is this year so high in price. Besides, many good things we can make out of honey. The ancient Romans (who had no sugar at their disposal) knew this very well, as is expressed in the following Latin distich by the poet Martial in honour of the bee and the confectioner:—

"PISTOR DULCIARIUS:

Mille tibi dulces operum manus ista figurat  
Exstruit. Huic uni parca laborat apis,"

which in English reads:—

"THE CONFECTIONER:

This hand makes for you a thousand sweet figures,  
And for him alone the economical bee works."

Any one can make the wholesome and health-giving honey cakes of which children are so fond, and I am sending you a sample of these cakes made by myself after the

fashion of the ancient Roman confectioners. Should you think it useful to bee-keepers I will be glad to send recipes for making. Also one for making honey-mead. I use a good deal of honey myself for honey cakes and in different other ways, so I am in no hurry to put it on the market. I may say, too, that dark and fermented honey unsuitable for table use might be utilised for making honey cakes. I am pleased to see that suitable winter food for bees has been an item of general interest of late in the B.B.J. and *Record*, and that experienced bee-keepers have been urging us to give only good candy to our bees. I hope this advice will be taken. Last year about this time a bee-keeper was relating in the B.B.J. how his bees were busy carrying out from the hive candy they could not use as food he had bought from a well-known firm, and it is not improbable that many scores of stocks may be in the same plight at the present moment. If the poor bees are unable to consume the candy given them it is of little use spending money on such stuff. I wish I could teach all your readers how to make really good bee-candy. But I fear this can only be done by seeing it made, not by reading. I wasted a good deal of time and money on the subject while trying to make a thoroughly good candy, as your readers know from what I wrote last year. I think very few candy sellers would go to the trouble and expense of making honey candy such as I give to my bees, yet to my mind it is well worth the trouble in cases of real need, as when a hive is found to be short of stores in late autumn. At such times if a 6 lb. cake of honey-candy be given it is wonderful how quickly the bees will take it down, whereas if unsuitable candy be offered they will leave it untouched and starve to death. As a palpable illustration of what is said in the "Guide Book," "that good candy must be like fondant sugars made by confectioners," I will send a sample of my candy to any bee-keeper forwarding a stamped addressed envelope, in order that it may be seen how smooth in grain properly made candy is.

In conclusion, may I be allowed to say to those bee-keepers who are conversant with the different uses to which honey may be applied for household purposes that they should let us profit by their experience? I am sure a few lines on this subject from time to time would be welcomed by bee-keepers in general.—B. COLOMBAN, *St. Mary's Abbey, Buckfastleigh, Devon, November 12.*

[Cakes and honey are both very good.—EDS.]

## THE PRICE OF HONEY.

[5334.] Your contributor, "Desunt Cætera," entirely misses the point of my contention. I quite agree with him that the competitive system is a selfish system; but, as I explicitly stated in a former letter, we have no choice at present to ignore it, and if we are to avoid the

bankruptcy court we must work on the recognised competitive business principles. We bee-keepers pay the market prices for our supplies; we pay the usual railway charges; we pay the competitive rents for our houses and fields, which, unless in exceptional cases, are the highest the landlords can obtain; in fact, all people with whom we have dealings exact from us the best price they can get when we are purchasers. Is it fair, therefore, that bee-keepers, in their turn, should sell their goods under the market value? Nothing in this world that is really useful is worth intrinsically an arbitrary sum. You cannot say that honey is worth 1d. per lb. You cannot say its value is 2s. 6d. per lb. Its value in the market depends entirely on supply and demand. My entire ground of complaint is against those bee-keepers who sell under a fair market price; as regards any other considerations, I have nothing to do with them, and I adhere to my statement that it is most desirable that the bee-keepers' associations should not only teach the technical part of the craft, but do something to instil business principles into their members.

When we are compelled to lower our prices to a paltry 3d. per lb. I for one will not blame any one; but I assert that at present there is no such compulsion, and that if my advice is heeded in time the compulsion is not likely to arise for a long period yet. Bee-keepers are subject to very bad seasons often, and have every right to ask such a price as will cover such risks. Besides, the labour and time devoted to the craft is very considerable; but some bee-keepers, apparently, set no value on these items.—W. J. FARMER, *Truro, November 20.*

## Queries and Replies.

[3284.] *Sending Swarms by Rail: Liability of Railway Companies.*—May I trouble you to seek your opinion on the following matter? At the end of last June I sent four swarms by rail to Scotland, of which the bees of three swarms were dead when tendered to consignee. They reached him, as he advised me "a smothered, sticky mass." This state of things, known to bee-keepers, is the result of their being covered up so as to stop ventilation, and thus asphyxiate the bees. They were in well-ventilated boxes and labelled "Live bees, do not cover." I have made a claim on the railway company, and, after much correspondence, they refuse to accept liability. My point is, whether labels are of any use in securing safe transit; and as there is absolute proof that the disaster was caused by disregard of instructions (I have the dead bees now in the boxes), I ask—Do you think I should take proceedings in county court for recovery of value? I have already threatened. Your

kind reply would be esteemed.—A. D. D., *Hants, November 28.*

REPLY.—The matter is entirely a question of where the fault lies, and this could only be decided by the county court judge after hearing the evidence. Our own view is averse to "proceedings" unless clear evidence is available; and we cannot safely decide in regard to this from hearsay, especially when swarms so often travel safely when properly packed.

[3285.] *Bee Experiences: A New Start after a Bad Beginning.*—Deeming it possible that my bee-experience may be of interest to your readers, I send the following details:—Five years ago I purchased my first colony of bees, and the following year two more stocked hives and one spare one. They were looked after by a local tradesman, who professed to know all about bees; personally I took no interest or trouble in their management. During four years I think I got about 40 lb. or 45 lb. of honey, but am unable to say how many of the hives were kept going during the four years; all I know is that this spring there were no bees left alive, and I told the head gardener to get rid of the hives altogether. By chance this autumn I was at the Crystal Palace, and became much interested in the Exhibition held there by the Surrey Bee-keepers' Association. An official introduced me to Mr. Overton, the expert of the S.B.K.A., and after a good chat I decided to have another "shot" at bee-keeping, and to look after the bees myself. I ordered four stocks, bought Cheshire's book—which I have read carefully—and had my hives disinfected and painted inside and out. The bees were hived in my presence; I believe they were most excellent and strong stocks; and now my great anxiety is to winter them well, and see if I cannot succeed in getting 1½ cwt. or 2 cwt. of honey, as I apparently should, instead of an average of 4 lb. or 5 lb. per hive. Now for my questions. I gather that warmth is a great thing for the bees in winter, and mine are now well packed with a quilt and three thicknesses of thick felt. But why are the hives made so flimsy? Some of mine have only single sides, and must be very cold this raw weather. Is there no hive made of oak? and why not line a hive on the inside with cork-carpet? It would be so easy for the bees to get a foothold; besides, we know from our bathrooms how warm cork is for the naked feet. I gave the bees each a 2-lb. cake of candy to-day, but found the inside roof of the hive, which is painted, sweating with moisture like damp walls on a muggy day; surely this is bad, as the moisture, or condensation must run down into the hive? I propose to fill the roof with straw, and nail a piece of porous canvas over to keep the straw in place. Would this be a good plan? I would also like to wind a straw band round and round the body of the hive to keep out the cold, and this would make a

frame-hive look like a square skep, and not be unsightly. All bee appliances, hives, &c., seem to be made so horribly on the cheap. Is there no article suitable for a gentleman's garden? We spend enough on hothouses, stables, kennels, &c., not to begrudge a nice house for the bees. If you can tell me which is the finest, strongest, warmest, and best-made hive in the market I should feel obliged; otherwise I shall have a good model copied in 1-in. oak, lined with cork carpet, and see how I fare next year. I am given to understand that my last bees died of cold and starvation.—R. HOFFMANN, *Streatham, S.W.*, November 30.

REPLY.—Without desiring to minimise the value of the practical part (vol. ii.) of the late Mr. Cheshire's work on bees we must remind our correspondent that it was written about fourteen years ago, and both methods and appliances used at that time are now out of date. It is proved beyond doubt that the best packing in winter for bees is *bees*, and that hives "made of oak," or with cork-lined walls inside, would be only so much money thrown away. The very best results are obtained with hives made as described in the "Guide Book," and the leading makers of to-day can turn out hives neither flimsy nor cheap if quality is desired without limitation as to price. With regard to condensation of moisture inside roofs, if a non-pervious quilt is put close on top-bars, and plenty of warm coverings above, just put a board over all and weight it down; there will then be no "sweating with moisture" inside roof, as stated.

[3286.] *Removing Surplus-Chambers in November.*—I think you have rightly diagnosed my case, when you state on page 480 that care was not taken to return the bees of each upper chamber to their own side of the "Wells" hive. I must plead guilty. Like most criminals, however, I have an excuse to make, having read somewhere that the worker bees in a "Wells" hive all mix together, and, as far as the characteristic odour is concerned by which bees distinguish each other, form one colony. I am happy to state that since I wrote you the evil of which I complained has diminished, either by all the strangers being expelled, or by the bees deciding to forget and forgive and let bygones be bygones. I suppose even the hatred of bees for those of other colonies is not an undying one. You do not appear to advise me as to the introduction of cakes of candy under the quilts. Kindly enlighten me; and also as to the introduction of laths over the frames, or the bee-way described in this week's issue. I have nothing of that sort at present. The afternoon when the bees were shifted was, for the time of year, a particularly fine and mild one.—A. S. B., *Anerley, November 27.*

REPLY.—If there is any uncertainty regarding the supply of food, candy may be given below quilts, and renewed as required; but with ample stores no candy is needed.

## Notices to Correspondents & Inquirers.

*Letters or queries asking for addresses of manufacturers or correspondents, or where appliances can be purchased, or replies giving such information can only be inserted as advertisements. The space devoted to letters, queries, and replies is meant for the general good of bee-keepers, and not for advertisements. We wish our correspondents to bear in mind that, as it is necessary for us to go to press in advance of the date of issue, queries cannot always be replied to in the issue immediately following the receipt of their communications.*

### A COTTAGER BEE-KEEPER (High Wycombe).

—*Disbelief in Big Honey Averages for 1903.*—Really, old friend, you must modify the terms in which your wrath is vented against bee-keepers whose reports seem hard to believe. "C. H.," who writes from Cornwall, on page 469, is to our knowledge as reliable as yourself. Not only so, but the remarkable average he quotes is only another instance of many this year where very heavy takes of surplus have been secured in some parts, as reported in our pages recently. As a reader of the B.B.J. almost from its earliest number, and "a bee-man of fifty-three years' experience," you should bear in mind that the successes with bees of the late John Walton and yourself in the early seventies were hardly thought possible at the time by many bee-keepers. Therefore, you must learn to regard with a more kindly eye the successful doings of those who are not such "old hands" in bee-craft as you and ourselves are.

### Honey Samples.

W. E. E. (Kingston).—Quite unintentionally no doubt, as a novice, you rather puzzle us in sending a bit of old crushed comb (size about 1 in.) with only two or three cells containing honey—sent also in an empty tobacco box—and ask us to judge its colour and quality. Fortunately the strong aroma overcomes that of the tobacco, and enables us to say the honey is gathered partly from heather, which will account for the colour and also the strong flavour.

F. W. M. (Sompting).—Sample of 1902 honey is badly fermented. It may have been all right when sold a year ago, and have gone wrong by being kept in an unsuitable place. No. 2 is a good and well-ripened sample of granulated honey of this year. What you call "sediment" and imagine to be particles of wax at side of jar is neither sediment nor wax, but simply the cloudiness often seen on sides of jars containing granulated honey. It arises mainly from the improper way in which the jars are filled when running honey into them.

### Suspected Comb.

C. W. (Wilts).—Comb contains foul brood of old standing.

# Editorial, Notices, &c.

## HONEY IMPORTS.

The value of honey imported into the United Kingdom during the month of November, 1903, was £1,056.—From a return furnished to the BRITISH BEE JOURNAL by the Statistical Office, H.M. Customs.

## BEE-KEEPING IN CALIFORNIA.

### HONEY AND WAX PRODUCTION.

By George Robertson.

We have been favoured by Mr. Robertson with a copy of his valuable article on "Bee-keeping in California," accompanied by a request for its reproduction in our pages. We have particular pleasure in complying with his request, seeing that the statistics furnished contain information of much interest to bee-keepers the world over.

It is almost impossible to give exact up-to-date statistics regarding the bee industry, as the swarms of bees and the production of honey vary greatly from year to year, according to the conditions of weather, climate, and other circumstances. To all who take an interest and pride in the rapid progress and agricultural development of Fresno county the facts and figures here presented cannot fail to be interesting.

The production of honey has assumed large proportions in the United States—more especially in California, which holds first place in this important industry.

It is only little more than half a century since the honey bee was introduced on the Pacific coast. The earlier bees in this country were the common brown or black German bee, but in 1860 the United States Department of Agriculture introduced the Italian bee, twenty years later the Cyprian, and later the Carniolan. There are others, but these four proved the most popular.

There are numerous points which are valuable as a source of supply for "nectar" for the bees, but they vary according to the conditions of soil and climate. For example, alfalfa, which is so valuable in California, does not produce "nectar" east of the Mississippi, the other leading products for bee forage in this State being fruit trees, manzanita, cleome, monarda, mesquite, black and white and blue sage. The colour, aroma, and flavour of honey depend to a great extent on the forage for the bees.

The leading States in bee-keeping, besides California, are Texas, Kentucky, Missouri, North Carolina, and Tennessee, and the largest producers of honey California and Texas. The production is not only very uncertain, as it depends so much on the season and a plentiful supply of flowers and other plants, but it varies greatly in different parts

of the States. The greatest average production of honey in the Western States is 27.2 lb. to a swarm, while in the South Atlantic States it is low as 11.1 lb., but as high as 28.3 lb. in California.

Wax as a product is expensive to the bee and also to the bee-keeper, as experiments show that it takes 10 to 20 lb. of honey to produce 1 lb. of white comb for surplus storage, and about half that quantity for 1 lb. of brown comb for brood rearing.

### NUMBER AND VALUE OF SWARMS.

The following figures will give some idea of the magnitude of the bee industry:—

	No. Farms with Bees.	No. Swarms.	Value of Bees. Dols.
U.S. ....	767,261 ...	4,109,626 ...	10,136,513
California.....	6,915 ...	129,444 ...	363,885

### POUNDS AND VALUE OF HONEY AND WAX.

	Pounds Honey.	Pounds Wax.	Value of Honey and Wax. Dols.
U.S. ....	61,796,160 ...	1,765,315 ...	6,664,904
California.....	3,667,738 ...	115,330 ...	331,939

Of the counties, San Diego is the largest producer of honey in California, and Fresno the second. Although there have been large increases during the last few years in Tulare, Kings, and Kern, the two former are far ahead of the others

### GROWTH OF THE INDUSTRY.

In 1860 California produced only 12,276 lb. of honey and 584 lb. of wax. In 1890 California was the fifth largest producer, with a total of 3,939,899 lb. In 1899 the average value of bees and production of honey per swarm in California was—

Value of bees .....	Dols. 2.81
Value of honey and wax.....	2.56
Pounds of honey.....	28.3

In 1901 the crop of honey was a bountiful one. Last year showed a considerable decrease, but the coming season is likely to be a record year, the abundant rains and favourable weather having produced a luxurious growth of bee forage in many parts of the State, more especially in northern California.

Apiarists have a promising future before them, as the production of honey and wax is likely to become one of the most important of the minor industries of California.

### CALIFORNIA HONEY CROP.

	Pounds.
1892 .....	1,240,000
1893 .....	2,680,000
1894 .....	4,275,000
1895 .....	4,000,000
1896 .....	5,850,000
1897 .....	7,878,000
1898 .....	1,820,000
1899 .....	2,822,000
1900 .....	2,280,000
1901 .....	4,600,000
1902 (estimated).....	3,600,000

IMPORTED HONEY (DUTY 20 CENTS PER GALLON).

	1898.	1899.	1900.	1901.	1902.
No. gallons ...	96,604	126,217	146,860	182,196	167,301
Value.....	\$38,138	\$51,599	\$70,857	\$83,599	\$56,383

The greater part of the imported honey comes from Mexico and the British West Indies.

EXPORTED HONEY (FOREIGN).

	1898.	1899.	1900.	1901.	1902.
No. gallons ...	79,160	93,297	27,585	63,089	88,363
Value.....	\$32,963	\$36,428	\$13,719	\$29,912	\$31,694

EXPORTED HONEY (DOMESTIC).

	1898.	1899.	1900.	1901.	1902.
Value.....	\$98,604	\$56,900	\$30,191	\$55,574	\$106,112

The custom returns do not give the quantities. The greater part of the domestic honey goes to the United Kingdom, Germany taking the second place.

SOUTHERN CALIFORNIA.

Counties.	Swarms of Bees.	Value of Bees.	Pounds of Honey Pro-duced.	Pounds of Wax Pro-duced.
		Dols.		
Los Angeles.....	8,923	20,067	150,620	7,630
Orange.....	3,312	7,877	45,130	12,990
Riverside.....	8,286	22,633	92,100	13,230
San Bernardino..	5,052	16,959	123,450	7,910
San Diego.....	20,002	50,000	466,290	11,400
San Luis Obispo..	2,106	4,902	76,780	1,710
Santa Barbara...	2,833	5,873	162,390	3,910
Ventura.....	4,926	11,890	152,660	3,430
Totals.....	55,440	140,251	1,260,420	62,210
Indian Reserva-tion.....	25	50	1,290	20
Totals Cali-fornia.....	129,444	363,885	3,677,738	115,330

Counties.	Swarms of Bees.	Value of Bees.	Pounds of Honey Pro-duced.	Pounds of Wax Pro-duced.
		Dols.		
Alameda.....	674	1,995	6,780	470
Alpine.....	92	340	2,300	25
Amador.....	801	2,000	8,100	60
Butte.....	806	1,717	9,010	200
Calaveras.....	488	1,220	11,490	170
Colusa.....	716	1,373	10,610	60
Contra Costa....	991	2,973	29,060	450
Del Norte.....	358	879	2,870	170
El Dorado.....	557	1,120	10,180	240
Fresno.....	10,674	34,162	567,800	13,300
Glenn.....	411	820	5,320	140
Humboldt.....	1,476	3,673	28,980	370
Inyo.....	3,832	15,521	146,320	2,970
Kern.....	5,694	21,218	211,326	3,460
Kings.....	6,057	20,542	221,080	7,580
Lake.....	633	1,377	8,190	1,030
Lasien.....	1,276	4,193	49,930	260
Madera.....	197	591	7,442	60
Marin.....	82	255	740	—
Mariposa.....	54	135	1,080	30
Mendocino.....	456	1,215	4,980	110
Merced.....	3,949	11,133	148,000	3,050
Modoc.....	1,763	7,049	23,560	610
Mono.....	247	996	4,850	430
Monterey.....	3,018	7,390	85,850	2,220
Napa.....	319	851	4,900	120
Nevada.....	335	1,035	3,730	210
Placer.....	526	1,124	6,190	150
Plumas.....	316	858	4,580	60
Sacramento.....	1,524	4,665	48,600	1,040
San Benito.....	449	1,146	10,370	320
San Francisco...	—	—	—	—
San Joaquin.....	1,926	4,815	80,000	1,750
San Mateo.....	247	741	5,150	140
Santa Clara.....	1,972	6,110	41,890	1,340
Santa Cruz.....	271	767	4,370	50
Shasta.....	1,379	3,175	20,780	470
Sierra.....	129	387	1,980	20
Siskiyou.....	2,907	7,165	75,000	700
Solano.....	666	1,955	9,470	530
Sonoma.....	1,034	2,628	21,460	300
Stanislaus.....	1,060	2,818	20,700	660
Sutter.....	5,543	9,150	112,740	1,070
Tehama.....	523	1,320	4,910	190
Trinity.....	55	157	1,340	120
Tulare.....	7,008	22,283	258,000	5,530
Tuolumne.....	426	11,035	11,100	460
Yolo.....	1,767	4,981	48,780	330
Yuba.....	254	542	4,200	75
Totals.....	73,979	223,5	2,307,028	53,100

Correspondence.

The Editors do not hold themselves responsible for the opinions expressed by correspondents. No notice will be taken of anonymous communications, and correspondents are requested to write on one side of the paper only and give their real names and addresses, not necessarily for publication, but as a guarantee of good faith. Illustrations should be drawn on separate pieces of paper. We do not undertake to return rejected communications.

Communications relating to the literary department, reports of Associations, Shows, Meetings, Echoes, Queries, Books for Review, &c., must be addressed only to "The Editors of the 'British Bee Journal,' 10, Buckingham-street, Strand, London, W.C." All business communications relating to advertisements, &c., must be addressed to "THE MANAGER, 'British Bee Journal' Office, 10, Buckingham-street, Strand, London, W.C."

\* \* \* In order to facilitate reference, Correspondents, when speaking of any letter or query previously inserted, will oblige by mentioning the number of the letter as well as the page on which it appears.

NOTES BY THE WAY.

[5335.] Shows and Showing.—My last "Notes" (page 472) were so severely "edited" that the intent was, to some extent, obscured. Referring to shows, I said, "the fact of exhibitors staging their best products and thus making the show did not appeal to the minds of our brethren in conference."

For several years past, the annual meeting at Jermyn-street in October has reeked with vituperation of the principal prize-winners at the honey shows, while the Council of the Parent Association place themselves in the anomalous position of offering a "Challenge Cup" to the exhibitor who secures the greatest number of prizes, and then rack their brains to discover some method of debarring the winner from taking prizes in the future. Another point in these annual "hecklings" is that it keeps the exhibitors away from the meetings. I can name, if required, some prominent bee-men who have not attended for some time, and will



remain away in future. Possibly, some may say, "We don't want them." Be that as it may, the fact is patent to any one who will refer to the B.J. lists of attendance at the meeting in question. As regards the force that impels competition, it is not my intention to discuss it. It may be the hope of gain, or it may be for the mastery; or it may be the aspiration to be dubbed the "Champion of the World." But whatever the object the exhibitors have in view—every one must give them the credit of *making the show*—we all know that bee products are different from live stock, and most of us also know that 1st prize quality honey is not, except under very exceptional conditions, produced annually; the climatic conditions favourable to its production do not often exist in consecutive seasons in the same district.

*Selling Honey.*—But, having produced the fine quality honey (our friend "Desunt Cætera" [5313, page 469] still leaves his real name in abeyance, his letter does not fill the whole bill, especially from the bee-keeper's point of view. The remainder—for that of honey he appraises at 3d.—is still wanting; but as Mr Patchett (5316), and Mr. Farmer (5334) in subsequent issues have fully dealt with that view of the question, I will therefore, briefly, only note that so far as the agricultural labourer is concerned, our Bee-keepers' Associations have not taught him to adapt new methods or induced him to keep bees for his betterment in the old style. The teachings and preachings of our experts of the modern system of bee-keeping have not converted the few remaining bee-keepers of the old school, and the younger generation of labourers have not taken up with bee-keeping, either ancient or modern. I know as a fact that, taking a radius of surrounding villages near me, there is not now one-fourth the number of cottager or labourer bee-keepers that there was twenty-five years ago, notwithstanding the Press articles, the expert's annual visits, the bee-van tours, the lantern lectures, and the instruction and help ungrudgingly given by neighbours who have made the bar-frame system a success. Therefore, I contend that, notwithstanding our continued propaganda for so many years, our mission—so far as the labouring classes on the land are concerned—has failed to teach them to keep bees. Then, when British bee-keepers can, by climatic conditions, get their short six weeks' honey harvest extended to sixteen weeks, or, better still, a six months' honey flow, we shall have such abundance that even Brazil and Cuba honey producers will not be able to compete in our market.

If Mr. Marrs (5319, page 474) had seen the onslaught of bees and wasps from far and near on the exhibits of unglazed sections at one of our Berkshire Shows some years ago, he would not advocate sections to be shown, as he says, *undressed*, and as regards the expense of glazing, if the bee-keeper has the ability to do the work himself, he can glaze each section

for a fraction over one halfpenny each, and if he cannot or will not trouble to do so himself, he can purchase glazed boxes ready to put his prize winning sections into for 1½d. each, and cheaper by a large quantity, from every appliance dealer in Great Britain, so that as regards *dressing*, every bee-keeper stands on the same level.—W. WOODLEY, *Beeton, Newbury.*

[We are sorry to have in any sense altered the meaning in Mr. Woodley's last "Notes." Our view in the obviously necessary work of "editing" is to adhere as *closely* as possible to the ideas of all who favour us with contributions, while, owing to the very limited space at disposal, condensing (or, as the term goes, "boiling down") where it can be done without disadvantage. We so often receive the thanks of contributors for the labour (and it *is* labour) thus bestowed that an occasional slip may, we think, well be pardoned in view of the interest of all readers.—EDS.]

## OUR BEE AND HONEY SHOWS.

### DEALING WITH PRIZE EXHIBITS.

[5336.] I write after over twenty years of bee-keeping, during which I have endeavoured to support exhibitions of bee-produce to the best of my ability, and I have no hesitation in expressing my belief that the proposal that the B.B.K.A. shall buy the principal exhibits of honey and beeswax to which first prizes are awarded at its shows to prevent them being staged in competition again, will, if carried out, have the effect of further reducing the small number of entries obtainable for our exhibitions.

I consider that the exhibiting of honey and of live stock may very properly be compared, though Mr. Weston thinks otherwise; but in the case of live animals the exhibitor is only required to guarantee his ownership for two months previous to the show. In the case of animals, how many are there among owners of valuable animals who could exhibit if they were compelled to hand over their animals to the R.A. Society at a fixed price? It is also well known that cattle may be purchased for exhibition. The bee-keeper is very properly required to guarantee his exhibits to be the produce of his own bees, and if 1st prize exhibits are claimed by the B.B.K.A., the number who can replace such exhibits and show others of the same quality is so small that I believe the later shows would be very adversely affected by the absence of exhibits compulsorily removed from the show-bench earlier in the season.

Referring to the probable effect of the present proposal upon myself and others in similar circumstances, I may say that I usually work ten or twelve hives for honey, and I have never yet been able to produce more than one dozen sections of what I feel are of exhibition quality; though, as in the past season, I can

sometimes show three exhibits of six well-matched sections. The same applies, in a lesser degree, to really good exhibits of light-coloured extracted honey, while of beeswax I can only—in the case of an exceptionally good season excepted—show a single exhibit of really first-class wax. I say this because it is only the cappings from best honey that yield the highest class of wax. Thus the yield of honey appreciably affects the yield of wax of the best quality. I never use acids or any colouring matter in the preparation of wax intended for showing, as, after one trial some years ago, I found that the colour of wax can only be improved at the expense of other equally important points.

Mr. Weston's figures on page 483 afford interesting evidence of the extent to which our honey shows rely upon a small number of bee-keepers for support. It may, of course, be argued that if the men who now give most support to the shows are handicapped, as is proposed, a number of novices will be encouraged to exhibit; but, at present, the amount of evidence in support of this is so small and unreliable that it is only guesswork. For myself, I shall keep an open mind upon that subject, as upon others. The good of the greater number claims our first consideration, and even at the best I only hope that our exhibitions will not be increased in size at the expense of quality.

With regard to the extent to which our honey shows depend upon a few public-spirited bee-keepers, I may refer to our Essex County Show this year. I was in bad health at the time, and felt quite unable to bear the strain of hard work and the long hours necessary to prepare a number of exhibits; but as the date drew near, I saw clearly that it would be the poorer by the absence of such exhibits as I might be able to send, so I decided to make an effort and do what I could.

I may also say here that although the funds of the show were so liberally subscribed for, that the Committee had some hundreds of pounds to hand over afterwards, the honey show was treated with meanness of a decided kind by the Society's local committee. And, as is too often the case at all our important honey shows, whether held in London or in the counties, the exhibits of apianian produce depend upon the efforts of about half-a-dozen bee-keepers; for, in the case of some exhibitions, it may be truly said very few bee-keepers make much of an effort to stage exhibits that will be a credit to themselves, though they grumble because their exhibits are passed over by the judges. They also complain because they are required to compete with bee-keepers who spare no trouble in staging good stuff in proper form.

We not seldom see reference made to the profits obtainable by exhibiting; but my own experience, as a fairly successful exhibitor, shows that on the whole it has been at a loss. Those who usually refer to the profits give no thought to the "expenses" side of the question

as it affects such as myself. In connection with the show I have referred to, I had to hire a horse and cart for nine different journeys to get my things to and from the railway station and show-ground. At another show that I was asked to support in a northern county this year I sent a single exhibit of 12 lb. honey, and the total expenses for this one exhibit totted up to 11s. 6d.

With regard to the exhibits which are to be purchased by the B.B.K.A., I alluded to the owners of valuable animals having to sell at a low price, bearing in mind at the time the proposed prices for honey and wax. But in the case of an important show the first-prize exhibits of honey in open classes would probably be the pick of several gross of sections or jars, so that I think that 15s. per dozen (especially for sections) bears no proportion to the value of the exhibit. I am, of course, referring to the highest-class samples of comb-honey, not merely saleable sections, and I would suggest 25s. as nearer the value—both to the producer and for educational purposes—for such as have taken highest prizes this year. The price to be given for beeswax is also quite as much out of proportion as is that for honey, and it is only those who know how much trouble is expended in producing a first-class sample of beeswax of 3 lb. weight who can appreciate this. Why, I am offered 1s. 9d. per lb. for my poorest beeswax this year.

And if it is decided that the B.B.K.A. shall claim first prize exhibits at a fixed price, into whose hands are these exhibits to pass? I, for one, will require a clear reply to this question, though this may not be the place to state "the reason why." — W. LOVEDAY,  
*Hatfield Heath, Harlow, Essex.*

(Correspondence continued on page 496.)

## HOMES OF THE HONEY-BEE.

### THE APIARIES OF OUR READERS.

We are glad to present a view of the neat and orderly apiary of our friend, Mr. Geo. Dow, along with himself, on next page, as that of a bee-keeper who is resolved not to be beaten, after a rather bad start, and "comes out smiling" in the end. All such bee-men render real help to the craft all round. For the rest, the following "notes" need no addition from us.

"I started bee-keeping twenty years ago with two swarms in straw skeps, in rather a curious way, and not with any friendly feelings towards the bees, for I did not like the idea of having stinging insects in my garden. However, my new venture came about through an old friend living some miles from me being a bee-man, and had a lot of bees in skeps, while I had at the time some young pigs. My friend badly wanted a couple of my pigs in exchange for some bees, and he pressed me so hard that a bargain was struck. He brought me two swarms, and I gave him one pig. My

next move was to extemporise a bee-shed for the skeps out of a big plate-warmer with a door in the back, so that I did not have to pass in front of the bees. I kept them like that for some years, my friend paying me a visit occasionally to see how the bees were getting on, and, at the end of the season, pick out those for the 'sulphur pit.' At last I said if that was the only way to keep bees, I would have no more to do with so cruel a job, and he could take the bees back again as a gift.

But, before this came off I had sent me a copy of 'Modern Bee-keeping,' and, after reading this, I changed my views, seeing that one could keep bees without such cruelty as the brimstone pit enforced. I then bought some frame-hives, and got a copy of the 'Guide

your opinion, and the answer you gave me was 'comb contains foul brood of old standing,' so that was one more lesson. I burnt the lot!

But I resolved not to be beaten. I had got some good stocks in hives with standard frames, and meant to keep them. I think if we get a few knocks like this it sometimes sharpens us up, and makes us more determined in our work in this world. Anyway, I keep my stocks strong and hives clean by scraping all propolis, &c., from top and bottom of every frame in the spring; also give new quilts once a year and put naphthaline in every frame when quilting down for winter. I also renew combs gradually by giving one or two new frames with full sheets of foundation in each hive every year. Not only so, but I get young



MR. GEORGE DOW'S APIARY, ST. MARY CRAY, KENT.

Book,' with the aid of which and a little outside help I soon transferred the bees of all my stocks in skeps into their new homes. This being done very satisfactorily, I got a slight touch of the complaint known as "bee-fever," as many readers have had before me; and went on buying a few more stocks in frame-hives, but was not so sharp as some of those I dealt with, who sold me hives fitted with frames of all sizes but the standard; and I did not find that out before the next spring, when starting to unite some stocks, and so, realising the folly of keeping hives with non-interchangeable frames, these hives had to go.

I then heard of some stocks for sale in standard hives, and I bought two; but on getting them home I thought the combs looked a bit wrong, so I cut out a sample and sent it for

queens by securing all the 'casts' or second swarms I can buy and keep them in nucleus hives on about four frames, with full sheets of foundation, and feeding them well while they are building up, and taking out old queens. Then, in the autumn, I remove all old queens and unite the nucleus colonies to the old stocks. I am local secretary to the Kent and Sussex B.K.A., and had the honour of winning the silver medal at the Crystal Palace Show for granulated honey, besides taking many other prizes at our local shows. I also was glad to be the means, through our district councillor, in obtaining the grant of £15, mentioned by our chairman in the BEE JOURNAL of November 19 last. We are hoping for better times for Kent, if we remind our councillors, when seeking re-election, that they can assist

the County Association if they are so inclined.

Before concluding, let me say that I have a good sale for my honey at a fair price, but this year it has been far from its usual quality in this part of the country—the honey is so dark in colour that my customer does not like the look of it. Nor do I myself, for some of it is nearly black. I believe it comes from the oak trees and the hop gardens during the wet summer. The photo. shows myself in centre and my youngest (of ten) in the background. I end by wishing bee keepers better times with their bees next year."

### CORRESPONDENCE.

(Continued from page 494.)

#### LEATHER-COLOURED ITALIAN BEES.

[5337.] I wonder if any reader of your valuable journal can tell me where the real "honey gatherers" can be obtained from? I mean, the "leather-coloured Italian bee," which the late Mr. George Neighbour used to import. I have not been able to obtain these bees since his death. The bees I refer to were not crossed by the Cyprian in order to "make them beautiful," and so spoilt as honey gatherers. A friend of mine had a stock of these bees, which collected 240 lb. of honey in one season; and I myself saw three supers taken from this hive, the best I have ever set eyes on, and I have seen not a few in my day; every cell was capped, and all beautifully finished. Not only so, but the stock hive was so full, the queen had no room for egg laying, being unable to lay until some of the combs were extracted. So far as my experience goes, the leather-coloured Italians have collected greater weights of honey than the English. They also fly a longer distance. I remember a bee-keeper telling me one autumn that he should have to feed all his stocks. The very next day his Italians made straight for a common two miles distant, and got enough honey from it to enable them to stand the following winter, while all his English stocks required feeding.

I have, myself, kept Cyprians, and they are, certainly, very handsome, the orange colour showing when on the wing; also Palestines, which latter, are even more beautiful than the former, I think. I have also kept Carniolans, but they are, in my hands, everlasting swarmers and almost useless as honey gatherers when in the pure state.

On the other hand, when crossed by the English drone, they make fair honey gatherers. I sometimes wonder, Sir, you do not give us a Christmas number of the B.B.J. The queen and her attendants, coloured as an Italian or Cyprian queen, or a good swarm, would be interesting, with increased price to cover expenses.—ENQUIRER, *Wolverhampton*, December 5.

#### THE SEASON IN NORTHUMBERLAND.

[5338.] The ingathering in the Glendale district of Cornhill-on-Tweed has been a failure, both in clover and heather honey. Stocks were poor in spring, and wet weather continued almost all through the summer. Some few bee-keepers managed to secure a small quantity of clover honey, but it is very scarce everywhere. Wholesale prices ranged from 4d. to 10d. for sections; one bee-keeper I know of in the Milfield district was selling his clover honey at 4d. per lb., while another in the Brantxon district got 10d. each for his sections. The heather season has been generally a failure, as you will judge when I say that at Common Burn there would be about fifty stocks belonging to different bee-men, and the take of honey would not average 1 lb. per hive. Out of thirteen hives one bee-keeper only had eleven saleable sections, which were, however, sold at 2s. 6d. each. Another bee-keeper at the same place sold a few at 1s. each. The Middleton and Goldcluech Moors have both been a failure this year.—A BEE-KEEPER.

#### INTERESTING BEE ITEMS.

[5339.] Some notable incidents have come to my knowledge which, though not of great importance, may possess interest for readers at this quiet season. The first has to do with *Loss of Bees through Beer-drinking*.—A bee-keeping friend (Mr. W. Stone), located near Bristol, nearly lost three colonies of bees last year through a local publican who brews his own beer, and one of the "brewings," after being drawn off from the cooling-vat, left a "scum" around the sides of the "cooler," which latter evidently had some attraction for bees, as those of Mr. Stone went there in thousands, only to be overcome by the beer, as they were found in great numbers at the bottom dead. The loss so depleted my friend's three strong hives that they were almost worthless.

*Swarms Joining Stocked Hives*.—Mr. Geo. Harris, another Bristol bee-keeper, watched a very large truant swarm enter one of his stocked skeps. Fighting at once commenced, and continued all day, many bees being killed; but next morning at ten o'clock the swarm gave up the battle and left the skep in a body, clustering in the usual way, and were captured and hived by Mr. Stone. The interlopers were hybrids, the home bees natives.

*Bees Propolis-ing a Dead Mouse*.—The last "incident" I have to chronicle came under my own notice when a small boy at home. My father made some wooden hives with shutters at back for observation purposes, and one day noticing a crowd of bees at the entrance of a hive not fully combed, I looked through the glass at the back, and it seemed to me the bees were trying to get rid of a dead mouse; but, after watching them for several days, I found

they were covering it up with propolis, which they did, quite sealing it over with that substance.—J. SKINNER, *Easton, Bristol.*

### PRICE OF HONEY.

[5340.] Referring to the letter of Mr. W. Patchett (5316, page 473), he differs from my view of "Why should not the price of honey come down?" I maintain that there would be a greater demand at a lower price, which demand would steadily increase as the properties of honey became known. To my mind a quicker sale even at a smaller profit is more satisfactory than slow sale and inflated profits. A further argument in favour of lower prices is the fact that bee-keeping yields a better return of outlay than any other minor industry. In saying this I make a case out as follows:—Cost of complete hive, 12s. 6d.; swarm of bees, 8s.; subscription to B.K.A., 2s. 6d.; total outlay, 23s. Profit, first year, 30 lb. honey at price W. P. quotes, 16s.; profit, second year, by good management, = 100 lb., £2 13s. 7d. Therefore, total profit for two years = 300 per cent. on outlay.

If I have overstated my case, tone it down, but tell me, Mr. "W. P.," wherein I am wrong. I call it fair profit to get 20 per cent. on things of ready sale, and for slow sales say 30 per cent. I venture to differ from "C. Bee" (5326, page 479), when he contends that honey-producers as a rule do not realise enough for their produce, while agreeing that the producer's share of profit should exceed that of the retailer, but the margin of difference is not great between them. Nor does it necessarily follow that a less capable bee-keeper should compensate for his want of skill by demanding a higher price than his neighbour, who manages better. The British public are not yet educated to judge the qualities of English honey to any appreciable extent, but, in fact, are rather disposed to look upon all as first-class stuff; nor can they easily compare native honey, as the retailer usually stocks one kind only. The best way of cultivating a taste for honey is selling at a fairly low profit.

I did not quote 100 lb. per hive as an average take, but I know several bee-keepers in my own county of Lincs. who have taken that amount in this bad season of 1903, and they certainly would not accept 3d. per lb. for their honey. Still I agree with friend "C. Bee" that bees are a profitable hobby at that price. The fact, however, again proves the adage that "much wants more." I did not intend to convey the impression that we should sell at 3d. per lb., but simply to infer that we should be on the profit side. Now my comparison of skeps with frame-hives is as follows:—Outlay for two straw skeps, 6s.; cost of swarm, 10s.; total, 16s. Income, first year, 0; second year = 20 lb. honey at 1s., 20s. Therefore, profit on outlay = 125 per cent. On the other side, outlay as shown for frame-

hive, £1 3s.; profit for first and second year = 130 lb. at 3d., £1 12s. 6d. Therefore, profit on outlay = 140 per cent.

While still open to correction, I see a virtue in lower prices as enabling those who most need honey—viz., the lower classes—to use it as an article of food.

Again, the grocer depends entirely on "sales" for his living, while the producer regards bee-keeping as an auxiliary to his income (as Mr. Woodley states on page 473), and not as a primary source.

But with regard to business methods in selling to retailers, English honey will fetch its price any time for the trouble of seeking your customers; the "glut" is not everywhere.

With regard to the last paragraph of W. Patchett's letter, I treat it as I do the rest—viz., with respect. It will be a rude awakening for him to know that I am not only a producer, but a brother bee-keeper of Lincs. who realises higher prices than he quotes, but still who does not see eye to eye with him, nor do I treat other people's opinions as nonsense, but as our Editors do. I am aware that if a man takes the unpopular side of a question he is open to ridicule which is no argument, hence my *nom de plume*, but you, Messrs. Editors, have my name, &c., and should any keen, observing correspondent desire it, I have no reason to withhold it, save perhaps a feeling akin to bashfulness. Since I have had showers of blessings bestowed on me for treading on ground that I thought not quite so delicate, I am perhaps better pleased that I am a—  
DESUNT CETERA, *Lincs., November 30.*

### SELLING HONEY.

#### CREATING A MARKET.

[5341.] After reading the views of your correspondents put forward in B.B. JOURNAL on the question of selling honey, I venture to send you my experience, and how I succeeded in creating a market for same. I commenced bee-keeping on the modern plan five years ago, and my surplus for sale the first season amounted to about 20 lb. of extracted honey, which I had some difficulty in selling, as no one in this neighbourhood seemed to use honey as an article of food, but simply bought it in small quantity for the treatment of colds in winter. Living in a rural district, three and a half miles away from town, the only honey available locally was taken from straw skeps, and as it often bore a strong taste of sulphur, no wonder it was not wanted as an article of food. In this state of affairs I resolved to make some improvement, if possible; and, with this end in view, whenever a chance came I talked to friends and neighbours about modern bee-keeping and the wonderful progress made in apiculture in recent years, and inviting them to come to my place and see how honey was extracted without injuring the comb, then strained and put into glass jars, without the

hands touching it. In this way I interested some and raised the curiosity of others, who thought it wonderful to see how cleanly was the process, and the purity of the article when ready for sale. Orders poured in so fast, as my bee-methods got talked about, that I had to refuse a good many orders, some from families who had previously bought a single pound for medicinal purposes, and now ordered by the dozen or half-dozen jars.

In this way, then, by a little honest pushing, a local market is created to the mutual advantage of the seller and buyer. With regard to price, I need hardly say that my working time as a working gardener is fully occupied, and I have to economise my spare hours in every way. I therefore sell all my honey locally, and my humbler class of customers bring their own vessels in which to take away their honey, thus saving the price of screw-cap jars and a little in price per lb., because of no trouble or cost to me in preparing it for market. The price at the door is 6d. per lb., and as each vessel is weighed there is none of the loss in over-weight which some of your correspondents complain of in using glass jars. Those who are located near large towns or seaside resorts will be able to command higher prices than one situated like myself. I am also afraid that I can wield the spade better than the pen; still, I send these few lines hoping they may possess interest or use for some readers of our JOURNAL.

I send my name and address, and sign—  
SPADE, *Wellington, Som., November 30.*

### HONEY JARS AND CLIPPED QUEENS.

[5342.] I am glad to see that Mr. Woodley, has called attention on page 472, to the question of honey jars. I bought a seven gross crate of what should be  $\frac{1}{2}$  lb. jars, from a London firm, who advertised in journals, and instead of holding 8 oz., I find they hold 10 oz. of honey. When I complained, they requested me to return two jars, which I did, and got reply to say they did not think I had many similar jars to those returned. As a matter of fact, the whole crate will average 10 oz., for while some hold a shade under the 10 oz., an equal number hold over that weight. Now, I cannot afford to give 10 oz. of honey in selling a  $\frac{1}{2}$  lb. so I don't quite fill the jars, and am receiving many complaints about jars not being full. I admit they look bad, but what are we to do?

Referring to "Clipped Queens," mentioned on page 476—I am in favour of all queens being clipped where bee-keepers cannot keep their eye on the hives during swarming time. For myself, I cut a half or two-thirds of one wing. The best time to do this is as soon as possible after the young queen has mated. I don't think "clipping" has any ill effect upon the queen. My garden is about 200 yards from the house, and I well remember my first experience of queen clipping, about four years

ago. One day I learned that my bees were swarming, but on reaching the apiary, I could see nothing wrong at any of the hives. However, while I was looking for the swarm, I saw a lot of bees returning to one hive, and knowing this hive contained a "clipped" queen, I began to look on the ground, and before long, found her close to the hive surrounded by a few bees forming a cluster about the size of an egg. Last year again, an old gentleman called me up, for I was in bed—being on night duty at the time—and said my bees had swarmed in his garden. He got back again in time to see the swarm take wing again and fly off. This queen was not clipped, and the bees are to-day located in the roof of Mackworth Church. So you see, the swarm with the clipped queen, returned to the hive, while the other was lost. Better lose a queen than a swarm.—  
J. PEARMAN, *Penny Long Lane, Derby.*

### TEACHING BEE-KEEPING.

#### LECTURE TO CHILDREN ON THE HONEY-BEE.

A lecture was given before the "Children's Guild" at Manston Schoolroom, Cross Gates, near Leeds, on November 26, by Mr. Gilson, of Cross Gates, over seventy children being present besides numerous adults and bee-keepers in the vicinity. The lecture, which was one of a series on natural history subjects, was illustrated by over thirty lantern slides, and Mr. Gilson, describing to the children the wonders of the interior of the bee-hive and the anatomy of the honey-bee, all of which are well known to your readers, told how the queen, living five years, would lay from 200,000 to 400,000 eggs per annum (110 times her own weight), and as she often lays from 2,000 to 3,000 eggs per day, and sometimes twice her own weight, lays during her lifetime upwards of 1,500,000 eggs, which if put end to end would reach a mile and a half.

The lecturer also told the children that a swarm, weighing 5 lb., would consist of about 40,000 bees, each bee weighing threequarters grain, and if they were put in a row would reach one-eighth of a mile, and that when an egg hatches it is fed by the nurse bees for four or five days, during which time the grub increases 1,400 times its original weight, and when it is ready to seal weighs twice as much as its nurse.—DARCY GRIMSHAW, *Leeds.*

### BEE-KEEPING.

"From the blossoms of the furze the bees derive their aromatic honey, which makes that of Dartmoor supreme. Yet bee-keeping is a difficulty there, owing to the gales, that sweep the busy insects away, so that they fail to find their direction home. Only in sheltered hives can they be kept.

The much-relished Swiss honey is a manu-

factured product of glycerine and pear juice; but Dartmoor honey is the sublimated essence of ambrosial sweetness in taste and savour, drawn from no other source than the chalice of the golden furze, and compounded with no adventitious matter."—From "A Book of Dartmoor," by S. BARING-GOULD.

## Queries and Replies.

[3287.] *Artificial Swarming and "Wells" Hives.*—I have Mr. Cowan's "Guide Book," and note the directions for making three colonies from two, and have been wondering how to proceed when the two colonies from which it is desired to make a third, are located in a "Wells" hive. Supposing the five frames of brood and eggs are removed from the stronger colony into a single hive, the "Wells" hive removed to a new situation, while the single hive takes the place of the latter. Will not the flying bees on returning, some belonging to one side of the Wells hive and some to the other side, all strive to enter the single hive? The consequence of this would be, I imagine, what Artemus Ward terms a "fite." What is the proper procedure under these circumstances? I do not mean after the battle has started, but before there is any *casus belli*.—A. E. B., *Anerley, December 5.*

REPLY.—The use of hives holding two stocks of bees, as the "Wells" does, creates a condition of affairs not contemplated in the "Guide Book," nor have we had any practical experience of such conditions. Nor is there any "proper procedure" we know of. On the other hand, we do not think that very serious trouble would arise, in view of the fact that the bees in both compartments of a "Wells" hive so often join forces of their own accord. However, under the circumstances we will invite Mr. Wells to say what he would do in dealing with your query, and publish his reply in due course.

[3288.] *Using Section-Racks in Non-Swarming Hives.*—Can you or any of your readers kindly say if a rack of sections, instead of a box of shallow frames, can be used with success in the chamber beneath brood box in a non-swarming hive? We are told that when the shallow frames are fairly worked out, they should be removed and placed out of brood-chamber, more shallow frames being placed below. This necessitates working for extracted honey only; while I want sections of comb-honey only.—Rev. H. R. N. E., *Marlborough, December 2.*

REPLY.—If an ordinary section-rack will fit below the brood-chamber of your hive, it might answer the intended purpose; but bees would not so readily start working therein as when

a box of shallow frames is used, because of the more ready access to the latter. We do not know when you have been told that "when the first box is removed and placed on top of brood-chamber more shallow frames are placed below," but this teaching is incorrect. The main object of a non-swarming chamber is to start the bees at work storing honey above the brood-nest, and once this is done, the needful room which prevents overcrowding and consequent swarming, is given *overhead* as required; nothing being needed below but a full width entrance. In extreme cases of strong stocks in hot weather, it may be necessary to wedge the hive from its floor-board so as to allow a free current of air all round; but plenty of room above—as a rule—suffices, to prevent swarming. Therefore, when bees are at work in non-swarming chamber, remove it, bees and all, above the brood-nest.

[3289.] *Preventing Fermentation in Keeping Honey.*—Many thanks for your reply on page 490 to my enquiry *re* honey not keeping well. I would be very grateful if you will kindly say in next issue of B.J. 1. What is a "suitable place" in which to keep honey? I keep mine in a cool place. 2. Also, what would be a proper way to fill the jars, in order to prevent the "cloudiness" after granulation mentioned in my last? Am very careful filling mine.—F.W.M., *Sompting, December 4.*

REPLY.—1. The main point in preventing fermentation is to avoid storing away any honey not thoroughly well-ripened. The thin portion, which rises to the top of bulk, after being kept for a few days in a warm place, should be kept apart and used first. The thicker honey which, of course, sinks to the bottom of bulk will keep, not be liable to ferment if kept in a fairly warm and dry place. 2. When jarring off, let the stream of honey flow into centre of jar, and not so quickly as to allow any vacuum for air between honey and the sides of jars.

[3290.] *Foundations and Bee-House Windows.*—1. Will you kindly say in BEE JOURNAL, which foundation is best for use in brood-nest, ordinary make, running seven sheets to the pound or "Weed," at eight sheets? 2. I am having a bee-house made, and would be glad if you will let me know what is the best form of window for letting out bees?—ST. AUSTELL, *Cornwall, December 3.*

REPLY.—1. It is claimed for the "Weed" foundation that the process of manufacture ensures greater toughness, and consequent less liability to break down; judged therefore by this standard, the lighter "weed" should equal if not surpass the "ordinary" of greater thickness. 2. The best form of window for bee-house works on a pivot, with a central pin top and bottom, so that when bees congregate on glass inside, they are turned out by simply pushing the window outward.

[3291.] *Non-Swarming Hives.*—I intend during this winter to make a couple of new hives, and therefore ask if you will advise me in BEE JOURNAL on the following:—The hives I have got are of the "Combination," and the "W.B.C." pattern (eight in all); but my greatest trouble is swarming, and in consequence I want to make two non-swarming hives. I work for section-honey only. My questions are:—1. Is it any use my making the "W.B.C." hive with a chamber below the brood-frames that I may be able to slip a rack of sections in from behind? 2. Will the bees, when cramped for room, work down in the super of sections if given beneath the standard frames?—T. L. COPPEN, jun., *Chadwell Heath, December 1.*

REPLY.—1. So far as the hive you name, Messrs. Jas. Lee & Son make a simple framework device which converts the ordinary "W.B.C." into a non-swarming hive. This device has already been described in our columns. 2. See reply to Rev. H. K. N. E. (page 499), and do not overlook the fact that in using the "W.B.C." hive, reliance is placed on giving room overhead and ventilation below.

[3292.] *Hive-making at Home.*—I should esteem it a favour if you could advise on the following. I may say that I am only a beginner; in fact, I have only one stock of bees, and these are in a skep, but I wish to transfer them into a movable frame-hive early next year. I have read the "Guide Book," and think I shall start with the "W.B.C." hive, as it seems a good practical hive that would answer well. Being a joiner by trade, I should like to make my own hives, but find it rather difficult to get the dimensions from the drawings in the "Guide Book." I shall buy my frames ready-made, as they would be stronger and more accurate if made by machinery. My question, therefore, is, How can I get the exact measurements for a joiner to work from? If I cannot get the particulars I want, should I buy a "W.B.C." hive as a pattern? And if so, where could I obtain one in this district, and the probable cost? Hoping to hear from you through the medium of your grand little paper, the B.B.J. I wish also to thank you for the advice you gave re feeding bees in a skep-hive last August. I may say the bees seem to be wintering well. I am feeding with a cake of candy now, but shall be glad when spring comes, so that I can dispense with the skep-hive, which I think is a great nuisance.—FRANK HUBBARD, *Leicester, December 7.*

REPLY.—A new edition of the "Practical Note Book" is now nearly ready for issue and will contain all the information you ask for.

\* \* \* *A few Queries and Replies are held over till next week for lack of space.*

## WEATHER REPORT.

WESTBOURNE, SUSSEX,

November, 1903.

Rainfall, 1.90 in.	Minimum on grass, 22°, on 20th.
Heaviest fall, 0.98, on 27th.	Frosty nights, 5.
Rain fell on 16 days.	Mean maximum, 50.2°.
Below average, 1.45 in.	Mean minimum, 39.4°.
Sunshine, 66 hours.	Mean temperature, 44.8°.
Brightest day, 6th, 7 hours.	Above average, 1.9°.
Sunless days, 9.	Maximum barometer, 30.58°, on 5th.
Below average, 4.9 hours.	Minimum barometer, 29.20°, on 28th.
Maximum temperature, 56°, on 9th.	
Minimum temperature, 27°, on 20th.	

L. B. BIRKETT.

## Notices to Correspondents & Inquirers.

*Letters or queries asking for addresses of manufacturers or correspondents, or where appliances can be purchased, or replies giving such information, can only be inserted as advertisements. The space devoted to letters, queries, and replies is meant for the general good of bee-keepers, and not for advertisements. We wish our correspondents to bear in mind that, as it is necessary for us to go to press in advance of the date of issue, queries cannot always be replied to in the issue immediately following the receipt of their communications.*

ERNEST WEST (Boston, Lincolns).—*Bee-keepers' Practical Note-Book.*—1. We regret delay on your account and that of many others who have ordered the book. It will, we hope, be ready for issue before the end of present month. 2. The suggestion to "publish details of how to make the 'W.B.C.' hive in pamphlet form at 3d.;" it might, as you say, "pay us to do so," but the details referred to are already included in new edition of note-book, which will be ready much sooner than a separate pamphlet could be got ready, even if the latter course was thought desirable.

E. C. N. WHITE (Newton, Toney).—*Price of Prize Wax.*—The price first mentioned was that proposed, and as we thought agreed to, but it appears that the lower price as quoted on (page 481) was eventually agreed upon. Should other exhibitors along with yourself consider 2s. per lb. too low, we don't think the Council would object to pay the higher sum.

DAVID AIRLIE (Lesmahagow, N.B.).—*Candy-making.*—Your sample is not sufficiently boiled, and would be more "buttery" in grain if stirred longer while cooling off.

*Erratum.*—Br. Colomban, whose letter appears on page 488, calls our attention to what is an obvious misprint in giving the weight of his surplus for 1903. The words "1,800 cwt." should read "18 cwt. from twenty-three stocks."



## Editorial, Notices, &c.

### SUBSCRIPTIONS FOR 1904.

Readers who propose having their B.B.J. for the coming year supplied direct from the office by post will assist our publishing arrangements very much by dating their subscriptions from the beginning of the year. An order form is printed on page iii. of this issue, to which attention is respectfully invited, and as names, &c., are printed, the form should be carefully filled up with correct postal address to ensure prompt delivery on Thursday morning.

### NEW EDITION OF "GUIDE BOOK."

In response to inquiries, we beg to say the seventeenth edition of "The British Bee-keepers' Guide Book" is now entirely sold out, and a new edition is in press, and will be ready for delivery by about the first week in January. The new edition will consist of 5,000 copies, as before, making the fiftieth thousand. We may also say that another translation of the work has now been made, and the seventeenth edition can now be had in the Dutch language, a fact that may be welcomed in South Africa.

The new edition of Mr. Cowan's work on "The Honey Bee," also of "The Bee-keepers' Note Book," will be ready by end of the month.

## Correspondence.

*The Editors do not hold themselves responsible for the opinions expressed by correspondents. No notice will be taken of anonymous communications, and correspondents are requested to write on one side of the paper only and give their real names and addresses, not necessarily for publication, but as a guarantee of good faith. Illustrations should be drawn on separate pieces of paper. We do not undertake to return rejected communications.*

*\*.\* In order to facilitate reference, Correspondents, when speaking of any letter or query previously inserted, will oblige by mentioning the number of the letter as well as the page on which it appears.*

### AMONG THE BEES.

#### PLAGIARISMS IN ANCIENT BEE LITERATURE.

[5343.] Ancient bee literature has a fascination all its own for the true lover of apiculture, and an occasional dip into one of these quaint old volumes is a feast of what some of these "apiarians" might call "right virgin honey." The impression left by their perusal is so pleasant that I hope to share its nectar and ambrosia at some future time with the readers of the JOURNAL. At present I will just lift the curtain so far as to afford a peep behind the scenes by giving examples of rank plagiarisms I have lately discovered; and, as I question if attention has ever been drawn to them before, I will have the pleasure

of supplying something new and novel—a feat by no means easy of attainment in these days when the dissemination of bee literature is so widespread.

In Cotton's "My Bee Book" will be found an article by an "Antient Bee Master of 1707." One sentence reads as follows:—"With the cloom close up the skirts and bracks of your hives that there be no way in to them but by the door." The sentence is not much in itself, and my attention was attracted to it by a footnote added by Cotton, wherein he queries, "Does bracks mean backs?" I at once voted, No! And I got a perfect confirmation of my opinion as a result of a little patient research. I found, too, that this sentence, and many more, were bodily appropriated, without any acknowledgment, from a more ancient bee master, who lived and wrote just a century earlier, viz., in 1609; for in Butler's "Feminine Monarchie," page 41, I discovered the same sentence word for word:—"With dis cloom close up de skirts and braks of your hives, dat dere bee no way into dem but only by de door's." I am astonished that a bee-keeper with the acumen of Mr. Cotton should understand the word bracks (or braks) to mean backs! Let the classic Mr. Butler explain his own word, which he does fully at page 49, where he gives directions how to prepare skeps for winter. "At Scorpio" (our October) "dress your hives for winter. Cloom dem close, mending all braks and faults about dem." To thoroughly exclude mice and other enemies, all broken parts were to be what we would call plastered up. The footnote was the cause of my discovering plagiarism No. 1.

My second example displays a more flagrant and heinous transgression. The beauty of imagery and accuracy of detail in the following extract induces me to give it in full, without any apology for its length:—"Among all the creatures which our bountiful God has made for the use and service of Man, in respect of great profit with small cost, of their ubiquity, or their being in all countries, of their comely order and continual labour, the bees are most worthy of our admiration. For first, with the provision of a hive and some little care and attendance (which need be no hindrance to other business, but rather a delightful recreation in the midst of our labours), they bring sweet product both for food and medicine. There is no fruit or flower, no wood or forest, no hill or dale, no promontory or campaign land, no fruitful or unfruitful soil, but what affordeth matter for the bee to work upon.

In their labour and order at home and abroad, they may be a pattern unto men, both of the one and of the other; for, unless they are hindered by weather, weakness, or want of stuff to work upon, their labour never ceaseth; and for their order, it is such that they may well be said to have a Commonwealth, since all they do is in common without

respect to private interest. They work for all, they watch for all, and they fight for all. In their private quarrels, when they are from their hives, however much you abuse them, they will not resist, if by any means they get away; but when they are at their hives, the common treasury for themselves and for their young, they will fight it out and contend for this property to the last shank. The epithets given to bees by several authors, which have written on this subject are—profitable, laborious, busy, loyal, swift, nimble, quick of scent, bold, valiant, cunning, chaste, neat, &c.” The extract is copied by me verbatim from the introductory chapter of a work “England’s Interest,” by Sir J. More; but it again is copied word for word (with some variations in the spelling necessitated by the lapse of a century) from pages 1, 2, and 25 of Butler’s Edition of 1634. The writer, so far as I know, never acknowledged the source, so it must be set down as an instance of rank plagiarism.

The two examples already given are like the first two degrees of comparison: bad, worse; but the *worst* has yet to come. Eighty-two pages of that interesting little book, the “Compleat Bee Master,” are filled with another man’s words. Every chapter, every paragraph, every sentence, every *word*, is taken from the Rev. S. Purchas’ book! I would fain not blame Gedde. Indeed, I think he was dead in 1721 when the “Compleat Bee Master” was published in his name. I can only conceive that, years before, bee-books being scarce and not easily obtainable, he had borrowed a copy of “The Theatre of Politicall Flying Insects,” and wrote out a good part of it for his own private edification and instruction. Years after, this manuscript fell into the hands of some one who sent it to Mr. Nourse, who certified the booksellers that they “might not only safely commit this manuscript to the Press, but that every purchaser will return his thanks.” Yes! for the cream of Purchas’ large work!! Mr. Nourse declares that he “carefully collated it with most writings upon this delightful subject, both ancient and modern,” naming amongst other authors the Reverend Mr. Purchas. If he ever read that gentleman’s most delightful book, how could he fail to observe that *every word* in Gedde’s book was copied from the other? I have the highest respect for John Gedde, Esq., and look on him in regard to the bee-hive much as I view Watts’ connection with the steam engine. Meanwhile, I am prepared to exonerate him from all blame in perpetrating this barefaced fraud. His title-page describes the work as “A Collection and Improvement of what has been written by *all authors* relating to this subject as well antient and modern.” Did Gedde, however, write this? No! The preface is dated 1675; the title-page was written probably in 1721, when I believe the reputed author could not write. Nothing I have said above refers to Gedde’s

own small book, “A New Discovery: Printed in the Year 1675.” It, the approbation of the Royal Society, and the introduction are Gedde’s own, and are *sans reproche*, although some high authorities hold that Gedde’s hive, like his books, is also a mere plagiarism, and almost bodily borrowed from older hives.—D. M. M., *Banff*.

NOTE.—Since above was in type I learn from an eminent authority on bee-lore that my last instance of plagiarism is no new discovery, but that it was already known to students of ancient bee-literature, and that it was dealt with by Dr. Warder in his fifth and sixth editions. My edition (the ninth) makes no reference to the subject, and in all my reading I have never once seen it mentioned that the entire book was nothing else than a mere copy of another man’s work.—D. M. M.

#### LETTING OFF STEAM.

[5344.] On page 492 of last week’s JOURNAL Mr. W. Woodley makes the following extraordinary statement:—“For several years past the annual meeting at Jermyn-treet in October has reeked with vituperation of the principal prize-winners at the honey shows.”

Mr. Woodley’s reputation as a successful honey-producer, and as the writer of “Notes” in your pages that have hitherto been uniformly genial and interesting, makes it the more necessary that an assertion so deeply affecting the credit of the parent association should be at once emphatically contradicted. What can be his authority? He apparently does not attend the meetings, nor does he believe the reports of them that are published in the B.B.J.; for nothing to be found there will justify his assertion, and yet these reports are, as many will be ready to testify, both fair and ample. In whatever way Mr. Woodley may have been misled, he had no right to believe that *vituperation* of the absent would be indulged in at a meeting of his fellow bee-keepers, or that the chairman of the meeting would have permitted it.

Mr. Woodley suggests that “heckling”—or is it the fear of being heckled?—keeps prominent bee-men away from the meetings. Now, heckling means teasing a man in public, or asking him questions that he will probably find it inconvenient to answer. I can safely say that whenever I have been present, if any one has been heckled it has been the Council of the B.B.K.A., who are there to give an account of their stewardship.

It is true that bee-keepers, whom one would like to meet at the annual meetings, are not to be found there; but, in my experience, this is the case at all public meetings, and in all classes, whether in town or country. The appliance makers are often poorly represented, and I have always supposed that they are too busy to come; that they are either in the parlour, snatching a moment to consume

their "bread and honey," or are occupied in "counting out their money," and settling how best to invest their profits. I prefer still to think that this is the case, and that it is not indifference that keeps away bee-keepers who would be so welcome.

Bee-keeping is a prominent minor industry, and, as such, its commercial side must always be the most important. But it has other sides, and by no means the least important is the right good fellowship that should—and generally does—obtain among all who follow the craft, the warmth of heart that one man feels to another who has the same hobby, the goodwill that exists between bee-keepers of all classes and all nationalities. And the outcome of this should be a looking forward to meeting one's friends each year in Jermyn-street, and to an evening of sociability, such as I myself am glad to have enjoyed at the last three conversaciones at which I have had the honour to preside.

May we, then, hope that Mr. Woodley and his friends will reconsider their position and meet us another year, if all goes well, with smiling faces? Letting off steam under the pressure of a grievance is pardonable, and often eases the engine; but a little discrimination is advisable as to which way you turn the discharge pipe.—H. J. O. WALKER (Lt.-Col.), *Budleigh Salterton, Devon, December 14.*

#### PRICE OF HONEY.

[5345.] Our friend "Desunt Cætera" must not think that criticisms of his ideas necessarily involve any antipathy to himself. I write again because I think there are several fallacies in his intentions which it is well to controvert for his own sake and the sake of others.

In the first place, I should not consider that it would pay to produce honey at 3d. per lb., taking into account bad seasons, depreciation, cost of time, risk of disease, and ill-luck. I consider that at 6d. per lb. net the bee-keeper makes no extravagant profit, and that many of the trades and businesses which he is surrounded with make greater profits on the average. It is quite certain that if the price ever falls to 3d. the army of bee-keepers will be much reduced, if not extinguished, for time would be more valuable than to spend it in that pursuit.

In the second place, his desire to benefit the humbler classes by low prices is very praiseworthy; but we usually find that the wages of the poor are in proportion to the lowest cost of subsistence, and cheaper food means lower wages in the long run. The best and most enduring method, therefore, of benefiting the poor is not by means of charity (that is sometimes necessary, but never desirable), but by teaching them to control events so that the good things of life may be more equitably distributed. The poor themselves are more or

less responsible for their condition of life. All political power is in the hands of King Demos, and he is responsible for the state of society, social and political.

If "Desunt Cætera," or any other man, wishes to benefit the poor, let him not do it by needlessly underselling, and thus injuring, others, but by devoting what he considers excessive trade profits to discreet charity, if he will, or to any of those worthy causes that particularly appeal to him.

Planted down as we are in a competitive system of society, we must act in accordance with the laws of the system, or perish! As I have said, I do not particularly admire the system, but I should not be logical if I knocked my head against its stone walls. I am quite willing, however, to alter or improve it when the majority see fit.

Mr. Woodley, in his "Notes" (5335, page 493), refers to the fact that propaganda work has not greatly increased the number of bee-keepers on the modern system; or, at any rate, not in proportion to the force expended. I should say that the cause lies in the fact that bee-keepers are born—not made. Certain individuals take to bee-keeping like ducks to water, while others find no fascination in the pursuit. It is certain, however, that if the price dropped very much many of those who follow it, partly as a hobby, would reduce their stocks and produce only enough for their own consumption—at least I should for one.

The profits now make it worth while to take a little more trouble; otherwise, fewer bees would give more pleasure as involving less work.—W. J. FARMER, *December 11.*

#### BEE AND HONEY SHOWS.

##### HOW TO ENCOURAGE ENTRIES.

[5346.] To secure plenty of entries, and make a really good display, is the aim of the secretaries of all our bee and other shows. To obtain the best exhibits from other counties, and to beat them if we can, open classes, with good prizes attached, are added to our county prize schedule. Producers of good honey we have in abundance, and in years gone by we had plenty of exhibitors at our annual show. As years roll on, however, we find greater difficulty in filling up entries in the local classes, and the reason is not far to seek. We can, in our county, produce sections fit to compete with those of any county in England; but, unfortunately for us, our run honey is not light enough in colour to meet the approval of judges when competing against the best produce of more favoured counties.

Your keen exhibitor does not like to be beaten, and, having tasted the fruits of victory, he will not readily relinquish his position. Therefore, in order to keep his place on the show bench, he has, in our case, wandered to other counties, and there obtained the right quality of honey

required in order to beat his neighbours. We adopted a plan of stamping sections on the inner sides, and this has answered its purpose, so far as sections are concerned; but with extracted honey we are still at his mercy. We know for certain that several exhibits of extracted honey at our county show were not gathered by the exhibitors' own bees within the county area. At a certain show, held this year, some excellent sections were staged, every one bearing the county stamp, and all containing genuine county honey of a medium amber shade of colour; while side by side with those staged by the same exhibitors were jars of lovely extracted honey of a totally different character to that in the sections, yet staged as having been gathered by the exhibitors' own bees, &c. One of the exhibitors in question had the temerity to say that last year he had planted some raspberry canes in order to get that particular honey—and he had a hundredweight staged!

Will Mr. Weston's propositions, I ask, check this evil, which is demoralising one class of exhibitor and discouraging another? I very much doubt it. It is not by penalising exhibitors from Berks, Hants, Herts, Lincs, &c., that we can hope to secure more entries; rather the reverse, especially at our later shows. Let our secretaries, stewards, and judges have the courage of their convictions, and disqualify every exhibit not in accordance with the *spirit* as well as the letter of the schedule, and I believe we shall have no lack of genuine exhibitors. My first silver medal of the B.B.K.A., dated 1888, and awarded by Mr. T. B. Blow, lies before me, so I am no novice; and I can endorse Mr. Loveday's remarks *re* the monetary profits of showing; but the satisfaction of having won with honey gathered by your own bees repays all the trouble.—A VILLAGE SCHOOLMASTER.

P.S.—As the writer of 5288 (page 448) I am still awaiting a reply from Messrs. Cribb and Scattergood.

## PROFITS OF BEE-KEEPING.

### SHOWS AND SHOWING.

[5347.] May I claim a little of your valuable space to add one more "blessing" to "Desunt Caetera," whose opinions on the profits of bee-keeping, prices of honey, &c., are averse from all opinions previously expressed on the subject. Could we secure anything like the quantity of honey he sets down year after year, then, I say, let prices come down! To further his argument he compares bee-keeping with other rural pursuits, but do other rural pursuits pay as one is sometimes led to think they do? I trow not. I venture to say also that your anonymous correspondent is no large producer of honey, or he would do the "toning down" himself. I quite agree with him that the grocer depends entirely on sales for his living, but by no means on the sales of

honey alone; nor is the bee-man going to look upon his "hobby" only as such merely for the sake of the grocer, or even in order to feed the lower classes. What the humbler class of bee-men require is how to produce their own honey, both for home use and for sale; otherwise, where does the auxiliary business come in? For honey to become a regular article of food, and at the cheap rate "Desunt Caetera" would have it, is out of all reason, and no one, I think, but himself would harbour such a thought. I am afraid that honey, especially heather honey in the comb, the pure golden-coloured article, will remain a luxury until, as Mr. Woodley says, our "six weeks' honey-flow" is prolonged to six months.

With regard to the question of "shows and showing," I might as well offer my opinion among the rest as to the champions in the exhibition world. I would say, let them remain as such and take all the prizes at every possible show. Do not bring forward any plan to prevent them—they deserve all they get, I say, considering the trouble and expense there are with it. Our worthy Editors, show secretaries, and others concerned have enough to do to make the shows even as successful as they are. Nor is there anything to prevent all bee-men that have the will competing against them. I send name and sign—NORTHERNER, *Yorks*, December. 14.

## BEE-KEEPING IN THE NORTH.

### PRICE OF HONEY.

[5348] Being a regular reader of the B.B.J., I often look for some reports of how bees have done in the North, especially from members of the Northumberland and Durham B.K.A. I think our Northern bee-keepers need "waking up" hereabouts. I also note some controversy in your pages regarding the price of honey, which, to my mind, is the main point in bee-keeping. I consider the man who is willing to sell a 1-lb. section or a 1-lb. jar of honey for 3d. is a long way short of *something*. Why, I got last year as much as 1s. 6d. for good 1-lb. glazed sections of clover honey, while others around me never sell at less than 9d., and heather honey brings 2s. to 2s. 6d. per 1-lb. section.

We are a good deal behind up here regarding bee-keeping lectures, nor do we hear or see any demonstrations with bees. I applied last year to the Durham Technical Education Committee for a course of lectures to be given this winter at Whickham, but we have never got them, although the recognised expert of the County Council as much as said that we were to have them. We also had a meeting in the parochial school in January last to form a branch of the N. and D. B.K.A., and selected some gentlemen to visit the bee-keepers of the

district in order to gain members and subscriptions, but nothing has been done yet.

On the other hand, it must be confessed that we have had a very poor season here for honey, the weather being as bad as elsewhere. However, we will look for a better season in 1904. I conclude by wishing you a Merry Christmas and a Happy New Year, and every bee-keeper as well. I send name and sign—LECTURES, *Gateshead, Co. Durham, December 14.*

### BEE AND HONEY SHOWS.

[5349.] Seeing that correspondence is invited on the above subject, I beg to send my views on the matter. The point is how to secure more entries without lowering the present high standard of exhibits, and regarding this I cannot see how the new rule about buying in the first prize exhibits will improve matters, because if all the best honey is bought in early in the season, the standard will certainly be lowered, and what credit will there be in taking a prize towards the end of the year?

On the other hand, suppose those who possess a large number of hives have enough first class honey to be able to save some for the later shows they will "sweep the show-bench" just the same as before, and what encouragement will there be to smaller and less experienced hands? The majority of bee-keepers are, I think, those who keep about a dozen hives, and I would ask—How can they compete with those who keep from fifty to a hundred hives? I beg to suggest the following remedy and shall be glad to hear what other members of the craft think of it. My idea then is that there be separate classes for those who keep upwards of forty stocks of bees; these latter exhibitors might stage thirty sections or thirty 1-lb. jars of honey. Then another class for those with from twelve to forty stocks who would stage 12 lb. of honey in each class, while a third section for those with less than twelve hives could show 6 lb. Some such plan as this would, I think, give the smaller bee-keepers a chance, and produce more entries without injuring the big exhibitors who are so indispensable for maintaining a high standard and for showing the public what honey ought to be like.

I send name and address for reference and sign myself.—BEE-HIVE, *Acton, W., December 10.*

### FERMENTATION OF HONEY.

[5350.] I fear that the prevailing low temperature this year, accompanied as it has been by excessive moisture, will cause many bee-keepers to experience some difficulty in preserving honey still on hand in good condition. The fact that two bee-keepers have been making inquiries recently about their honey fermenting (pages 449 and 499), along

with a complaint I have myself had from a customer that a parcel of honey obtained from me has fermented, induces me to say a few words on the subject. In my own case I find, after some correspondence, that it is about twelve months since the honey in question was supplied. It also appears that what remained of the parcel was stored away, to be kept especially for a particular customer, who expressed a good opinion of its quality, but, when wanted recently, the honey was found to be in a state of fermentation. Having some knowledge of my customer's house and store buildings, I felt assured of the probability that the honey was stored in a damp place, and have pointed this out. Honey produced in my district invariably keeps well, and I have never previously had a complaint. In this case my customer says that he fears to buy English honey in bulk if it will not keep indefinitely as he had supposed it would, and that foreign honey does just as well for his use. However, after going into the question of English compared with foreign honey, I believe I have convinced him. Though not responsible for the fermentation referred to, I have, rather than allow anything to mar the good name of English honey, offered to meet my customer in this matter by sending him half the quantity of good honey to replace that which has gone wrong.

Honey that has fermented can only be used as bee-food with safety in summer, but it is useful as an ingredient in preparing confectionery either at home, or by a professional confectioner.—W. LOVEDAY, *Hatfield Heath, Harlow.*

### CARELESS PACKING.

NOT THE ONLY ONE BITTEN.

[5351.] May I be allowed to say that I think Mr. W. D. Wright (5332, page 487) has just cause to complain, and I regard his letter as most useful in the cause of justice. If all who have been so dealt with were to expose these questionable methods of doing business, we should soon have a better class of advertisers. There are, however, some honourable dealers left yet, as I have proved; but with regard to the case in question I wish to give my own experience. First let me say that Mr. W. D. Wright is in no way related to me, nor do I know anything of him. My case is as follows. I saw an advertisement in the B.B.J. of built-out combs for sale, 4s. 6d. and 5s. per dozen, and at this time I had decided to take my bees to the heather, and, being short of combs, wrote advertiser asking if he had three dozen combs to spare. Prompt reply came: "Just three dozen left at 5s. per dozen." I sent 10s. on August 20 for two dozen, adding, "Wanted at once for the heather."

After waiting a fortnight and no combs coming, I wrote to ask if cash had been re-

ceived, and, if so, to forward the combs at once, or they would be of no use.

Reply came: "Sorry your order has been overlooked; combs shall be sent at once." But no combs came, and I again wrote asking for the return of my money, as I would not accept the combs now under any circumstances. Then came ten days of resultless waiting, when, to my surprise, I learned that the combs had arrived, and my wife had accepted delivery and paid carriage on them. Thus, and having to make the best of a bad job, I examined my purchase, hoping that after all it was money not thrown away.

This package contained what was supposed to be twenty-six frames of comb, and they were actually packed in a sheet of brown paper tied round with string! The "good, tough combs" advertised were eleven or twelve frames, of which two had the top-bars broken; the rest were newly drawn-out combs; most of them were neither built to sides nor bottom-bars.

The inevitable result was—frames mostly smashed to atoms! They were also, as in the case of the other Mr. Wright, "dripping with honey." I would not have cared so much about this had there been any decent effort to protect the combs by even reasonably secure packing.

It would be useful to hear from others who have had similar experiences, as it is only by publicity that a check can be put on this way of doing business. I send name and address of the advertiser in question for your private information.—W. WRIGHT, *Preston, Lancs.*

[We are giving the matter attention.—Eds.]

#### PREVENTING SWARMING, &c.

[5352.] I was much interested in reading the letter of "H. F. G., B.D." (5320, page 476), as to clipping queens for preventing loss of swarms; but I think the great question is "How to prevent swarming?" I know Mr. Rymer has a way of working which overcomes swarming with him; but his district does not produce much clover honey, and I should like to see correspondence from readers who have given his method a trial in working for clover honey during the past season.

For myself, I took Mr. Rymer's advice, and tried a box of shallow-frames above the ordinary brood-combs. I then gently stimulated to get same filled with brood in time for the clover honey. Just as clover was coming into bloom, I supered with shallow-frames, and the bees worked well for about a week, when the weather changed, and we had several days wet and dull; and on return of fine weather the bees swarmed. Next season I hope to try an extra box of standard, instead of shallow, frames, which, I hope, will be as successful with me as with Mr. Rymer.

Will those readers who have found a method of preventing swarming in clover districts

kindly let me have their mode of working? Information on this point will be very acceptable to many bee-keepers who are away from home during the daytime, or who live some distance from their apiaries, and to whom swarming often means the loss of the bees.—W. W., *Sutton-on-Hull, December 10.*

#### A NE PLUS ULTRA HIVE.

[5353.] In answer to the request made by "D. M. M., Banff," for information with regard to my hive (5327, page 484), I must deny the assertion that I am "selfishly" keeping back any hive from the bee fraternity. Anyway, I am willing to send him, carriage forward, one of the hives in question, and give him the use of it for 1904, if he will send address. He can then test the hive in his own locality and discuss its merits and demerits. I claim for it—1. Room to extend the brood-nest to fifteen frames and ease of manipulating same. 2. Feeding accommodation. 3. Self-hiving without hindering ventilation. 4. Accommodation for nucleus. 5. Securing comb and extracted honey from the same super. Yet with all these advantages I do not claim that it is a *perfect* hive. The fire of my enthusiasm may be damped a little by the wet season and practically no harvest, but, after smouldering a while, it breaks forth again into a cheerful blaze. Wishing "D. M. M." and all fellow-bee-keepers a Bright, Happy Christmas.—J. GRAY, *Long Eaton, December 9.*

#### PROFITS OF BEE-KEEPING

##### AND LOW PRICES FOR HONEY.

[5354.] On reading the letter of "Desunt Cætera, Lincs" (page 497), I am impelled to offer a few words on the subject. In calculating the cost of bee-keeping in frame-hives, is not your correspondent greatly understating the expenses? My own "W.B.C." hives supplied by a well-known maker, fitted with supers of shallow-frames, with full sheets of foundation all through, plenty of warm quilts and painted three coats, cost (including a Feeder) not less than 35s. each. A good swarm of bees would certainly cost 10s., but he only allows 8s. Nor can one help asking why he puts down the price of a swarm at 10s. to stock a skep. Why this difference? He also omits mention of all the other necessaries and appliances required, including spring and autumn feeding that swell the total. How many districts can one secure, or where can we average 100 lb. year by year? I am located in a good honey district with plenty of bee forage, including clover, but with all my care and the closest attention to every want, I cannot secure that weight. The time needed in good management, which alone ensures success, is very considerable. All this enormously reduces the percentage of profit

which he erroneously puts down as 300 per cent. for two years.—A BEE-KEEPER, *Cambridgeshire, December 12.*

### COVERING FOR HIVE-ROOFS.

[5355.] With regard to the complaint of "D. M. M., Banff," on page 484, a good and effective covering for hive-roofs, may I suggest thin, or laminated (technical term), rolled sheet lead of the strength necessary to weigh 1 lb. for one square yard? It can be quickly and easily fixed on any shaped hive-roof, and is absolutely weather-proof so long as the surface is not pierced. Sheet lead in this form can be had of any plumber. It only needs to cut the lead of such size as to allow plenty of length to overlap on all sides, and if secured with a copper tack here and there, it will carry off rain effectively. I send a small piece for your opinion.—A. H. WILKES, *Four Oaks, Birmingham, December 9.*

### SHOWS AND SHOWING.

#### BUYING EXHIBITS.

[5356.] Referring to Mr. W. Loveday's argument dealing with the proposal of the B.B.K.A. to buy prize-winning exhibits, in which he evidently thinks the price too low, I would say that, although not an exhibitor of "twenty years' standing," I consider the proposal an excellent one:

Now, suppose we take the exhibits, not from a successful exhibitor's point of view, but from the unsuccessful side of the question. Every bee-keeper knows that the quality of honey and wax may differ in both colour and quality even in adjoining apiaries; and if one bee-keeper has the luck to secure a dozen pounds of honey of the first colour and quality, while his neighbour gets an equal weight of slightly inferior quality, it is hardly fair that one should take all the first prizes and not give the other a chance. As a rule the credit of quality should go to the bees, who get the honey, and not to the exhibitor, who has no control over his produce at all.

I think that if Mr. Weston's proposals were carried out it would induce more beginners to exhibit, and so give a greater impetus to the industry. I myself have been a successful bee-keeper, and with twenty stocks I have averaged about £2 10s. per hive this season; but as an exhibitor I have not been successful. I have also been to various shows and have seen the colour of prize honey, which is in most cases very pronounced; while the colour of the unsuccessful exhibits appears very uniform. And I know from practical experience that two or three times of exhibiting with no mention is generally sufficient to damp the ardour of the average aspirant. Mr. Loveday also likens honey to other kinds of exhibits, viz., valuable animals, birds, &c.; but there he is wrong, as the breeder of the birds,

&c., has some control of his stock, such as suitable mating, feeding, &c., while with honey there is none of this. And I think that the general public would sooner see an exhibition of honey of the average quality than have the same exhibit (prize) hawked from show to show.—W. H. HALES, *Leigh-on-Sea, Essex, December 12.*

### INTERESTING BEE ITEMS.

[5357.] In the B.B.J. of December 10 (5339, page 496) reference is made to the subject of beer-drinking by bees. I wish to say how very glad I am that we bee-keepers do not have to drink such bad beer as is apparently made in the neighbourhood of Bristol, for if the scum kills thousands of Mr. Stone's bees, what must the real article do for the publicans' customers? I must say that our Kent beer is not so bad, for I have seen the bees at the brewery "coolers" having a good, long drink, and then flying away quite happy after their draught; and as my own apiary is situated close to the brewery, I fear that my bees are not teetotalers, for they often visit the "public." Anyway, I shall keep a sharp look-out next season; for if one "brew" kills thousands, I shall lose all my stocks, for our brewers brew every day. Hoping that friend Stone will be able to save the remainder of his bees by removing them farther away from such poison, I send my name and address, and sign—BEER, *St. Mary Cray, Kent.*

### PREVENTION OF INCREASE.

*Non-Swarming.*—It is easy to understand that the methods of management must necessarily be different in two sections of the country. In the North it will do to build up the colonies as rapidly as possible early in the spring, and then let the brood-rearing diminish in order to increase the surplus. But in the South we must not only build up early, but maintain the full strength of the colonies during several months. This requires two conditions:

1. A large brood-nest, so the queen should be able to lay at her full capacity. As to what constitutes a large brood-nest, I found the size advised by the Dadants the best—10 Quinby frames.

2. No swarming, neither natural nor otherwise. The honey-flow, or rather the "jerks" that constitutes our honey season, are (except now and then) not strong enough to furnish anything like a surplus and rebuild a brood-nest. It is one or the other. Please bear in mind that no swarming thus understood, means no increase, that it means keeping the bees, brood and combs together throughout the whole season. The mere issuing of the swarm is only a detail, as the swarm can be returned.

The prevention of swarming thus understood is what gave me the most trouble. I spent some five or six years in experiments. One of those were mentioned in a former contribution, and consisted in my taking out all the brood, putting it in another hive, and returning it after five or six days (cutting out the queen-cells, of course). I also stated that the process was a success as far as swarming was concerned, but was objectionable, chiefly, by requiring an extra set of hives to hold the brood, and from the fact that the bees, during these few days, worked too much in the brood-nest and too little in the sections. One of my critics misunderstood me completely. He thought that by preventing I meant simply preventing the issuing of the swarm, and innocently remarked that the extra hives would be needed for natural swarms, anyway. But that is not what I was after. What I wanted was, as stated in the beginning of this article, prevention of increase; keeping bees and brood together.

As to the building of too much comb in the brood-nest while the brood was out, another critic said I ought to have put on a super from another hive where bees were already at work. That's all right as far as it goes. But as a matter of fact, all the colonies thus treated were already well at work in the sections.

*Moderate Increase.*—Another plan is to take out a comb every week or so and replace it with a comb of foundation. The combs taken out can be used to form new colonies, or reinforce whatever weak ones may be in the apiary. The object is to provide room for the queen to lay. As long as there is plenty of young brood to feed, the nurse-bees will not undertake to rear queens.

The advisability of putting in a comb of foundation rather than comb already built out has been questioned. Let me say here that I am writing exclusively from the comb-honey producer's standpoint. For an extracted-honey producer the problem is an easy one. All he has to do is to give enough empty combs to accommodate the brood and all honey brought in. If he gets in a pinch, he can extract some of the combs already full.

But the comb-honey producer is confronted by entirely different conditions. The empty combs are, by no means, plentiful. I have but six now, and would not have a single one if one of my colonies had not died last winter.

But a built comb will not do, anyway. Let us study the "conditions." When the flow comes the brood-nest is already full, or will be in a few days. The secretion of wax and the building of comb in the sections are not started yet, so there is no room, or but very little, in the sections to put the honey in. Yet it is coming all the day. Having no other place, the bees put it in the brood-nest as fast as the matured brood emerges, and crowd the queen out. Eventually, swarming

follows if the apiarist does not remedy that state of affairs.

Now, suppose we give an empty comb. There is only one queen to lay eggs. There are thousands of bees ready to fill that comb with honey, and they will do it.

But give a frame of foundation and the "conditions" will be different. In the first place, it will take the bees some time to draw the foundation. Then, as soon as the cells are drawn, the queen can lay in them, while they cannot hold honey until they are about an eighth of an inch longer. These two conditions enable the queen to follow the workers and lay as fast as the cells are ready. Result: a solid comb of brood.

Somebody said that a frame of foundation, or a fresh comb, prevents the queen from laying further, acting as a division-board. There is nothing in it. Queens are constantly passing from one comb to another, and when they do stop at a fresh comb it is because they have all the room they need on the side where they are.

One of the critics says that that plan involves too much work, and he prefers "shaking." Perhaps it does; I don't know. But, by the above plan, two or three combs are usually all that it would be necessary to take out. That is less work than shaking eight or ten. It may be objected to, that these two or three combs are to be taken out at different times, and would necessitate opening the hives two or three times instead of once. That is true, but it is to be done at a time of the year when the hives have to be opened to see if the bees are ready for the supers; put on the first super, and later on the second. So, after all, the plan can be carried out with but little extra work.

*Artificial "Shook" Swarms.*—Shall we "shook" or not? No, in my opinion, not in the South, and I believe not in the North, either. But don't misunderstand me again, and think I am advising natural swarming. I want to keep the bees, brood, and combs together. It has been said repeatedly that by placing the old hive near, or above the swarm, or by shaking a second time, nearly all the bees can be secured in the swarm. But that's not all. The brood-nest has to be rebuilt. Did those who argue in favour of shaking ever stop to think that a brood-nest of only eight Langstroth frames contains enough wax to fill sixty-four sections? Would not sixty-four full sections be preferable to a new brood-nest, when the old one will do just as well?

*Caging Queens.*—After trying everything in sight, and almost everything out of sight, so to speak, I came to the conclusion that caging the queens for eight days, or requeening, are the only ways really practical. Both methods have their advantages and disadvantages. Requeening requires more work and more attention. Besides, some queens fail to mate, or are lost some way or other. On the other hand, a young queen will, in some way that I cannot understand, induce the bees to carry



the honey out of the brood-nest into the sections far better than an old one.

In my locality there is (with proper management) but little swarming, owing to cold spells of weather that come now and then, even until the middle of May or later. Only about 10 swarms out of every 100 colonies is the average percentage.

To manipulate 100 colonies in order to prevent ten swarms would be too much work. Furthermore, the 90 colonies, which would not have swarmed, will do better if left undisturbed.

So I let the bees swarm, if they want to, and treat only those that do swarm. Using queen-traps, I have no chasing of swarms to do (except in occasional cases) and no queens to hunt, since I get them in traps. But if I had a large number of swarms to attend to, I would prefer caging, by a long way, and do whatever requeening I might need after the honey season. And if anything like a large portion of my colonies were to swarm, I would certainly forestall them, and cage throughout the whole apiary at the proper time to be effective.—ADRIAN GETAZ in *American Bee Journal*.

## Queries and Replies.

[3293.] *Non-Swarming Hives and Non-Swarming Chambers*.—I should be glad of advice on one or two subjects:—Your reply to "H.R.N.E." (3288, page 499), last week, shows me that I also had misunderstood the principles of the non-swarming hive in the same way as your rev. correspondent had; but would you please explain to me what to do, seeing that last year, before I put the shallow frames in the non-swarming chamber, my bees built large pieces of comb from the bottom-bars of brood combs down into the empty space below, and I had to cut this comb away before I could put in the frames; I therefore ask: 1. When the shallow frames have been removed and put above brood nest, is the drawer which holds the frames to be left empty or reversed to form a solid floor close to the brood frames? 2. I have read in your paper of the seeming difficulty of making hive-roofs rain-proof in winter. We have had sufficient rain here to test any roof, and I have so far succeeded in keeping my hives and quilts quite dry. In the early autumn I bought some ordinary roofing felt and nailed it on so that the edges well overlapped the roofs, and these edges I bent down to keep the rain from driving in at the air-holes; I suppose by tarring the felt it would be even more rain-proof. Do you consider this a satisfactory and reliable protection, or are there any drawbacks to it? I send name for reference and sign—A BEGINNER, *Norfolk*.

REPLY.—1. Without knowing what type of

non-swarming hive is referred to, it is difficult to advise with regard to procedure. If the shallow frames are in movable box made to hold them, we take it that the box is removed along with the frames to serve as a surplus chamber above brood-nest. This being so, it naturally follows that the vacuum below is either done away with by slipping in the floor board, or else by substituting another box of shallow frames to be dealt with as before. In your case, it would seem that the "drawer" below brood-nest is not moved along with the frames, so that a second box must be provided in which to hang them as a surplus-chamber when placed above brood-chamber. 2. Ordinary roofing felt does well enough if tarred once a year, but thin sheet-zinc is far preferable.

[3294.] *Close-Ended Frames in Hives*.—I want a hive easily portable, of small size and warm, and am much interested in the enclosed description of the "Danzenbaker" hive. May I ask—1. Do you think this hive at all suitable for giving one a trial in England, not taking into consideration the frame not being of standard size? 2. Is there too much propolis deposited to permit of the use of close-ended frames? 3. Does the rain beat in at the square joints of the outside cases in the above-named hive? (Root's "A.B.C." book says "No.")—J. H., *Stonehouse, Glos.*

REPLY.—1. Shallower hives than those taking the standard frame have been tried in this country and have not been a success. Mr. D. A. Jones in 1886 introduced the "Heddon" hive, but it turned out a complete failure here. 2. Yes, to work comfortably and in districts where propolis is plentiful close-ended frames are a great nuisance, and we are sure will never find favour in this country. 3. The propolis of the joints inside prevents the rain from driving in.

[3295.] *Bee Districts within Forty Miles of London*.—I should be greatly obliged if, through the medium of the B.B.J., you would kindly give me the following information:—1. Which are considered the *best* bee districts in Essex and Hampshire? I propose starting an apiary on a fairly large scale in one of those two counties, so should be much obliged if you would recommend me a good bee district. 2. Do you think that there are better bee districts in other counties within forty miles of London?—B. W., *Hereford, December 9*.

REPLY.—1. Some of the finest honey is secured within a mile or two of Andover, Hants. But Essex is one of the best counties in England for bee-forage. It therefore becomes a matter of *personal* knowledge of where the best locations are for a reliable crop of fine honey. We will endeavour to get the views of some one who knows the country well, and print report. 2. The only districts in which a distinct advantage is gained is where heather grows plentifully in addition to the clover crop.

[3296.] *Swarms Decamping in S. Africa.*—The bees about here are very commonly housed in plain boxes. Two or three of these I have transferred to a hive fitted with frames, as in the old country. I cut a piece of the brood-comb and fitted it in one of the frames. The bees stayed for a few days, and then cleared out and flew off. The hive was new. Should I have cut the wing of the queen? I shall be very pleased if you can tell me the reason or reasons why they did not take to the new hive.—W. TIRRELL, Tokai, Retreat, Cape Colony, November 24.

REPLY.—We cannot advise without having further information regarding the race or variety of bees in your district. If you will forward a couple of the bees in question, we will give our opinion as regards "clipping" queens, as it is not easy to say why the bees refuse to stay in frame-hives.

[3297.] *Dealing with Odd-Sized Hives.*—I have bought a box of bees; it is not a modern hive, nor is it furnished with standard frames. The dimensions of the hive are—depth, 2 ft. 6 in.; length, 1 ft. 7 $\frac{3}{4}$  in.; width, 1 ft. 1 $\frac{1}{2}$  in. inside measurement; 3 $\frac{1}{2}$  in. thick, with double-case packed with cork dust, all fixed together. I believe the bees are strong and healthy, for they were a very strong lot all the past summer. The bees were also carrying pollen till very late in autumn. I lifted off the quilts to see how their stores were, and could see none. I made a 2-lb. cake of candy from recipe No. 2 in "Guide Book." I have sent a sample of same for your inspection. I raised the quilts and placed candy quickly under centre. The candy was warm when given, and the bees rushed up in large numbers; they started humming away after they were covered down. I left them singing over their candy. The quilts that should have been in one piece over top-bars are in three or four pieces, and badly packed down. I put more coverings on and made them snug. Please tell me if I have done right in giving warm candy to bees, as they became very excited after getting it. And should I make a proper quilt and take old one off altogether and pack them down with plenty of other rugs? If bees come out right in spring, I intend to place a modern frame-hive-fitted with foundation by the side of this one, and put a natural swarm from the box-hive into new one. I shall then move old hive away, as directed in "Guide Book," and make a box to hold the old frames, and place them over a new hive to transfer themselves. Please tell me if I am on the right track, and oblige—A BEGINNER, Earlsdon, Coventry, December 14.

REPLY.—We take no account of the measurements of the "dimensions" of hive (?), which are curious reading, to say the least. For the rest, if you follow the "Guide Book" all will go well. Sample of candy a little under boiled, and will become hard very soon. It is not smooth enough in grain.

### Notices to Correspondents & Inquirers.

Letters or queries asking for addresses of manufacturers or correspondents, or where appliances can be purchased, or replies giving such information, can only be inserted as advertisements. The space devoted to letters, queries, and replies is meant for the general good of bee-keepers, and not for advertisements. We wish our correspondents to bear in mind that, as it is necessary for us to go to press in advance of the date of issue, queries cannot always be replied to in the issue immediately following the receipt of their communications.

Referring to the mention of leather-coloured Italian bees on page 496 last week, Mr. E. H. Taylor, dating from Welwyn, Herts, writes:—"In reply to the question of 'Enquirer' (5337), who mentions the difficulty of obtaining leather-coloured Italian bees, will you allow me to say I will be very pleased to supply your correspondent with these bees, or with ordinary or 'golden' Italians, whichever may be preferred."

S. P. SOAL (Rochford, Essex).—*Shows and Showing.*—While inviting opinions and free discussion on this subject, we must not forget that there is the question of liability to be considered, and when our correspondent refers to what he "has been told" concerning the fraudulent practices of an exhibitor at a certain "dairy show," he must be prepared to give us a solid "covering guarantee" against risk before we could even think of publishing his allegations.

We must also be pardoned for suggesting that our correspondent would do well to refrain from mud-throwing when participating in the discussion we invite, for no matter how undeserved, some of it is "apt to stick," while his reference to "waiting to see which way the wind blows" is open to the inference that he may be "measuring out of his own sack," as the saying goes. We shall be very pleased to print all Mr. Soal desires to say if no personalities are indulged in and his communication is free from what is distinctly libellous, even if true.

PRACTICAL EXPERIENCE (Bucks).—*Fads and Theories.*—Like yourself we are "much amused," but our amusement arises from your terming such items of modern methods as "clipping queens," the use of "swarm-catchers," &c., "out-of-date fads and theories." On the other hand, we cannot say anything about the "absolutely successful" system of bee management "described in BRITISH BEE JOURNAL some years ago," unless we are made acquainted with the details thereof, for we must confess our entire ignorance of what our correspondent vaguely refers to in his letter.

MRS. MARTIN (co. Kilkenny).—*Bee Papers.*—The B.B.J. is, as stated in each issue, published every Thursday, price 1d., or 6s. 6d. per annum, post free. On the other hand, the monthly paper issued from this office about which you enquire is the *Bee-keepers' Record*, price 2d. or 2s. 6d. per annum, post free. Full particulars will be found in the papers ordered.

# Editorial, Notices, &c.

## BRITISH BEEKEEPERS' ASSOCIATION.

The monthly meeting of the Council was held at 105, Jermyn-street, S.W., on Wednesday, 16th inst., Mr. T. I. Weston occupying the Chair. There were also present Miss Gayton, Dr. Elliot, Messrs. D. W. Bishop-Ackerman, R. T. Andrews, W. Broughton Carr, J. B. Lamb, W. F. Reid, E. Walker, and the Secretary. Letters explaining absence were read from Mr. T. W. Cowan and Mr. H. Jonas.

The minutes of the previous meeting were read and confirmed.

The Finance Committee's report, giving particulars of receipts and expenditure to date, was presented by Dr. Elliot, and duly approved.

The examiner's report on recent examinations for first and second class diplomas was received, and, in accordance with their recommendations, it was resolved to grant certificates as follows: First Class—Mr. Wm. Herrod; Second Class—Misses E. Seymour, Helen Smith, and M. W. Unwin, Messrs. J. W. Brewer, S. Clark, T. H. Geary, W. Richards, Dr. Walpole Simmons, F. W. Swabey, R. J. Tabor, and T. E. Whitelaw.

The marks awarded to each candidate are given below, viz. :—

Candidate's No.	Section "A."	Section "B."
1	62	50
2	79	61
3	67	71
4	49	48
5	48	57
6	53	65
7	68	70
8	56	50
9	42	57
10	20	33
11	46	38
12	44	51
13	43	59
14	78	75
15	80	65
16	45	39
17	65	66
18	78	53
19	65	64
20	82	100
21	77	61
22	51	64
23	65	56
25	48	52

NOTE.—Maximum number of marks in each section, 100. Marks required in each section for a "pass," 60.

24 (First Class) 87 ..... 90

NOTE.—Maximum number of marks in each section, 100, with 80 marks for a "pass."

The Council resolved to reprint for circulation, in pamphlet form, the articles by Mr. W. H. Harris on "The Educative Influences

of Bee-keeping," recently published in the columns of the B.B.J.

Amongst the correspondence brought forward for consideration was a batch of letters relating to difficulties in the working of the insurance scheme in one or two counties, and to meet such contingencies it was resolved "that in cases of Secretaries of County Associations refusing to receive the insurance premiums, members of those Associations shall be permitted to insure on the same terms as bee-keepers unconnected with any Associations, viz., on payment of 6d. extra."

The prize schedule, grouping of counties, and rules and regulations for exhibiting in the Hive and Honey Department of the "Royal" Show in June, 1904, were revised and completed for approval by the R.A.S.E.

The next meeting of the Council was fixed for Wednesday, January 20.

## Correspondence.

*The Editors do not hold themselves responsible for the opinions expressed by correspondents. No notice will be taken of anonymous communications, and correspondents are requested to write on one side of the paper only and give their real names and addresses, not necessarily for publication, but as a guarantee of good faith. Illustrations should be drawn on separate pieces of paper. We do not undertake to return rejected communications.*

*Communications relating to the literary department, reports of Associations, Shows, Meetings, Echoes, Queries, Books for Review, &c., must be addressed only to "The Editors of the 'British Bee Journal,' 10, Buckingham-street, Strand, London, W.C." All business communications relating to advertisements, &c., must be addressed to "THE MANAGER, 'British Bee Journal' Office, 10, Buckingham-street, Strand, London, W.C."*

*\*.\* In order to facilitate reference, Correspondents, when speaking of any letter or query previously inserted, will oblige by mentioning the number of the letter as well as the page on which it appears.*

### NOTES BY THE WAY.

[5358.] *Honey Jars.*—The so-called 1-lb. jars for honey are still troubling me. They are screw-capped, of good quality glass, have the well-known triangle brand with the figure "6" in the triangle, and which one of our largest dealers and advertisers says holds exactly 1 lb. of honey. My recent experience, however (less than a week ago), was that it took 28 lb. net of honey to fill twenty-six of these jars just up to the neck, so that as the order I had in hand was for a gross 1-lb. jars I again gave away between 5 lb. and 6 lb. of honey. After filling the first two dozen jars I weighed several, and hardly one in a dozen was of the correct size, the other eleven holding from ½ oz. to 2 oz. over weight. I opine this is the position in which many of our brethren in the craft are placed when selling their produce in jars, and I ask, in common fairness to all, cannot something be done by our appliance dealers to induce manufacturers to make a 1-lb. jar holding 16 oz. of honey; and a ½-lb. one to hold 8 oz.? May be, those of our friends who are able to obtain jars of the

correct size holding capacity will give their experience and names of makers for the benefit of their less fortunate brethren.

*Shows and Showing.*—Thanks, Mr. Loveday, for your very temperate and well reasoned letter, dealing with prize exhibits, on page 493. So far as I am concerned the Council of the B. B. K. A. are welcome to purchase my winning exhibits at 15s. per dozen. I suppose the B. B. K. A. would not expect to carry off the prize card along with the honey? on the other hand, how the buying in of the prize exhibit is going to help in clearing the show-bench of difficulties, or help to swell the entries, passes my comprehension. Let us take the four big metropolitan shows:—The honey staged at the "Royal," in June, will be mostly of the previous year; then comes the "Confectioners," at which the winners with the current year's honey are debarred from showing at the "Grocers," so that the only attainable object that I can see will be to either extinguish the Dairy Show altogether, so far as the honey classes are concerned, or otherwise to enable exhibitors of an inferior quality of honey to take the prizes and win the challenge cup. This result may possibly gratify those of our craft whose bees are located in less favourable honey districts for a year or two, but it won't go beyond that. Or to take another point of view, looking on the allied shows of "Confectioners" and "Grocers" exhibitions, as distinct from those of the B. B. K. A., and, therefore, so far as the exhibits are concerned, beyond their control. If my premise is correct, I fail to see how the purchase of prize-winning exhibits at the "Royal" can prevent the same exhibitor from competing at the "Dairy Show," and in this way it is more than probable that the purchase of winning exhibits at the "Dairy" may further restrict or decrease the entries at the following year's "Royal Show," owing to the early date at which it is held. How far this will meet the views of the B. B. K. A., I know not.

Referring to Mr. Hales (5356, page 507). When he has had more experience in bee-keeping and honey-producing he will realise that the credit of securing bee-products of the finest quality is not altogether with the bees, but that the *genus homo* also has some hand in directing the work. Granting that the bees as "gatherers" of that food *par excellence* ("fit for the Gods?") clept honey, are the main agents in its production, but man's guiding hand is needed to accomplish the best results. There are bees and bees, some being far better "workmen," so to speak, than others. Some of the so-called "long-tongued" foreign races will secure just enough of some dark coloured honey similar to that in the oval store cells of the *Bombus Terestis* to spoil the beautiful white clover honey or that from the raspberry flowers as mentioned by "A Village Schoolmaster," on page 504.

Someone was inquiring recently in the

B.B.J. about a good location for an apiary or bee farm. The grand result of £2 10s. per hive—£50 profit from twenty hives in one season, and that season the worst since 1888—secured by our friend should act as a "pointer" to anyone in search of a good honey district. I think that few of our craft who could realize even one half that amount of clear profit per hive yearly would require any greater impetus to the industry.

I cannot agree with Mr. Hales' closing paragraph that the general public who take long journeys to shows, would prefer to see on the show-bench exhibits of average quality, be it honey, agricultural produce, or farmyard cattle.

"*Letting off Steam.*"—I am sorry to have raised the ire or hurt the feelings of Col. Walker (5344, page 502), but I'll "climb down" and, if I have given offence, apologise. Perhaps my terms were too forcible, so may I strike out the word "vituperation" and tone down the sentence by using "gibe" or "reproach," as conveying the sense of the remarks which were used towards us some three or four years ago, since when neither myself nor others attended the annual meetings.

These will be my last "notes" for the year 1903, and in this volume to me there is always a sadness in the word *finis*. We began the new volume with so much hope and expectation as the bells rang in the new year,—now with its passing we take a retrospective glance of the many failures and of the many vacant places made during its brief space; some of our loved ones are "beyond the bar," but duty will rouse us up to appreciate the more those we have left, and endeavour to make their lives more glad this joyous Christmastide.—W. WOODLEY, *Beeton, Newbury.*

## SHOWS AND SHOWING.

### DEALING WITH PRIZE EXHIBITS.

[5359.] To my previous letter (page 493 upon the above-named subject I would, with the Editors' permission, add a line to say I have only seen three exhibits of 1-lb. sections this year that I would recommend as much as 25s. each being paid for as their fair value to the owner and for educational purposes. Should the Council of the B.B.K.A. decide to adopt the proposals recently brought forward by Mr. Weston, I would suggest a sliding scale of prices to be paid for exhibits purchased, viz., between 15s. and 25s., but that at all shows where it is intended to claim prize exhibits two judges shall be appointed; one representing the Council of the B.B.K.A., and the other the bee-keeper proper.

"Your keen exhibitor does not like to be beaten." These are the words of "A Village Schoolmaster" (5346, page 503), and unfortunately many exhibitors harbour in their breasts this feeling and others akin to it. For myself, I may say that I have in the

past tried to cultivate the spirit that hopes and says out plainly, "May the best win!" while I still go on learning by endeavouring to find out the cause of non-winning exhibits failing to get a place among the winners. Even in the poor season of 1903 I learned something well worth knowing by attending some of the shows.

"A Village Schoolmaster" refers to fraudulent exhibiting, *i.e.*, buying, borrowing, or lending honey for show purposes. This sort of thing is, I am sorry to say, carried on at some of what should be our best exhibitions of apianian produce, in a way calculated to bring ruin either to the shows or to those who are determined to win prizes at the cost of truth or anything else. That it may be the latter all bee-men worthy the name will fervently wish.

Your correspondent, "W. H. Hales" (5356, page 507), refers to the comparison drawn in my previous letter between exhibits of honey and exhibits of livestock, and says I am "wrong" on the point; but I must point out that if a valuable animal or bird after winning a prize is claimed by the show committee and killed—or otherwise dealt with to prevent its being placed in competition again—this animal, being one of a limited number of such as itself, is done away with for food, and its destruction would be a loss to later shows. In the same way the removal of the best exhibits of honey at early shows must affect shows of later date. Mr. Hales says "the breeder of birds and animals has some control of his stock," and it would appear that he has yet to learn that the bee-keeper, too, can, to a large extent, control the mating of his bees, and thus the breeding of his stock, and so has command of the class of work that his bees will do.—W. LOVEDAY, *Hatfield Heath, Harlow.*

## OUR BEE SHOWS.

### BUYING IN PRIZE EXHIBITS.

[5360.] Replying to Mr. Hales, whose interesting letter appears on page 507, I should like to say that until he has control over his bees and their produce he will remain an unsuccessful exhibitor; and immediately he becomes one, his average profit per hive will go below £2 10s. per annum. I say this because it is impossible to produce "prize" specimens without lowering the net yield. I also maintain that the whole credit must go to the bee-keeper, without whom the bees will, as a rule, yield little or no surplus honey. The idea of the *same* exhibit being "hawked from show to show" is often altogether erroneous. Take my case of showing sections this season—which has, I believe, had something to do with the present controversy. I wish to say that at no two shows did I stage precisely the same dozen sections; the pilfering, railway journeys, &c., prevented this. As a matter of fact, from one to six of the sections staged had to be replaced each time, in order to keep up the standard of quality.

But, apart from the personal matter I have mentioned, will Mr. Hales kindly tell us his average weight of surplus per hive and the price he gets for his honey? The cash average per hive he tots up knocks mine into the proverbial "cocked hat"!

But with regard to the main point at issue—*viz.*, the motion carried at the recent meeting of the B.B.K.A.—Mr. Weston's proposition must, to my mind, either reduce entries or lower the standard of excellence; and I must echo the question which has already been asked, "To whom will the first-prize lots go?" If they by any means can be made to find their way to the show-bench under another name, one of the greatest evils of showing will be intensified. Then with regard to the price fixed by the B.B.K.A., it is exactly one half what I could have sold every section for that I put on a show bench this season, and one quarter of the reserve price I put on them. As already pointed out, the proposal hits the small producer much harder than the bigger ones, which, I venture to think, is the opposite effect to what Mr. Weston intended. It has been said that honey is on a different footing to cattle, &c., at shows. I maintain, as an article of consumption, it is exactly on a par with the splendid specimens of cattle lately seen at our "fat stock" shows, specimens upon which any amount of trouble and money are ungrudgingly expended in order to secure the finest result. On this point have not we exhibitors a notable example in his Majesty the King, who—if you choose to put it that way—"hawks" his specimens from show to show.—ALFRED W. WEATHERHOGG, *Willoughton, Lincs, December 17.*

## BEE AND HONEY SHOWS.

### A SUGGESTION.

[5361.] In connection with the discussion on this subject now being carried on in these pages, I beg to offer the following suggestion. From some of the letters which have appeared it seems certain that many of the smaller bee-keepers and younger members of Associations are deterred from entering for the shows by the knowledge that they may have to compete against exhibits which have already taken prizes at previous shows. On the other hand, it would appear equally certain that if the prize-winners at one show are debarred from entering their prize exhibits at other shows, the standard of excellence will fall off. I would suggest, therefore, that the B.B.K.A. should, at its own discretion, exhibit any of the prize honey it has purchased *not for competition*, indicating the name of the winner and the particular show at which it won its honours. The fact of any particular bee-keeper's prize honey being thus exhibited by the B.B.K.A. would, of course, not prevent him from entering again at the other shows. It would only ensure that he was not taking prizes again with the same stuff; and I venture

to think that the mere display of such prize honey would do much to prevent that falling off of the standard which is to be carefully guarded against.—G. S. N., *Godstone, Surrey*, December 21.

## SWARMS DECAMPING IN SOUTH AFRICA.

### SOME PRACTICAL EXPERIENCE.

[5362.] Having had a somewhat similar experience to that of Mr. Tirrell, Cape Colony, whose query appears on page 510, I may be allowed to state that never once in my four years bee-keeping in South Africa had I the slightest trouble in getting bees to remain in frame-hives after being taken from rough boxes or from between the wooden sides or from under floors of houses. In fact, my apiary in South Africa was entirely built up with bees taken in this manner. With regard to my methods I may say when transferring I did not trouble about old brood-combs, but simply took a frame of eggs and brood from one of my other frame-hives and filled up space required for the bees with frames fitted with half sheets of foundation. There is also one thing to bear in mind when using old comb, viz., to make sure that it does contain unsealed larvæ, because in the higher land or interior of South Africa there is scarcely any brood to be found in hives during the winter or dry season, although the thermometer may register 70 deg. Fahr. in the daytime.

On the other hand there are some exceptions, and in South Africa these are—1. Bees driven from their homes by grass fires in the winter, and—2. Those that are taken from holes in the earth—either from banks or the open veldt—of which latter I have dug out several lots; but although sometimes hived on as many as three frames, each containing plenty of eggs and unsealed larvæ, I was never able to keep a stock of these bees in frame-hives. I have tried confining queens by using excluder zinc; clipped queen's wings, giving food above brood-nest in the best part of the honey-flow, and some without feeding at all, but nothing seemed to stop the bees from decamping; they always cleared off leaving everything behind. Those stocks where excluder zinc was used continually would swarm out, issuing several times in one day, now and then until the queen having stopped laying her abdomen became so contracted that she had little trouble in getting through the zinc in not many days' time. Those with clipped queens going off and leaving the queen behind.

The queens and bees are slightly smaller than our native English bee, although exactly similar in colour. The bees of South Africa I know have a great dislike to yellow deal if it contains much resin, and this may possibly cause the bees to object to your correspondent's hive! Why does he not try one made

of clear pine, such as are sent out by most good makers.

*Temper of Bees in South Africa.*—Referring to the "Bee Notes from South Africa" (5305, page 464), in the B.B.J. from an expert of the B.B.K.A. now living at Port Elizabeth, who writes on the vicious temper of bees in South Africa, I should like to state that during the whole of my experience there I never saw anything similar to what he describes. I was certainly told that the native bees sometimes turned very fierce; but is Mr. Martin sure that his "boys" (Kaffirs) had not been interfering with the bees? It is well known that the Kaffir "boys" are very fond of the contents of the hives, eating the comb and all it contains—honey, brood, and pollen, just as it comes to hand. Nor are they very particular about leaving pieces of comb dripping with honey about on the ground, and thus in the winter "robbing" is started. I think your correspondent will find this, or something of the kind, has been the cause of his bees getting so cross and doing so much damage.

I never wore a veil when manipulating my own bees in South Africa, either in removing surplus, or when examining brood-nests; in fact, mine were the most quiet bees that I have ever handled anywhere, much more so than the Italians.

I was much pleased to see the contributions of my old rival on the show-bench at Pietermaritzburg and Durban when I was resident in South Africa. Mr. Sewell is an enthusiastic bee-man, and does a great deal of good in promoting modern methods of bee-keeping in Natal.—J. E. COLLIER, *Observatory-street, Oxford, December 18.*

(Correspondence continued on page 516)

## HOMES OF THE HONEY BEE.

### THE APIARIES OF OUR READERS.

Our friend Mr. Richards, seen in his apiary on next page, affords a good example of the bee-man who wisely adapts himself to his surroundings. Finding that his district does not produce prize-winning, light-coloured honey, he goes in for heather honey, and succeeds. For the rest, his interesting "notes" speak for themselves. He says:—

"I began bee-keeping in 1894, and having, therefore, served more than a seven-years' apprenticeship to the craft, I may now call myself an 'improver,' but as season succeeds season, I find myself still a learner, and realise very fully how much I 'don't know' about bees. I was induced to start through the interesting facts a friend told me he had read of in the B.B.J., which led to my resolve to own a hive of bees and try to do likewise. I at once ordered the B.B.J., and then obtained the 'Guide Book,' and after carefully reading it, I got my first stock of bees, hives, and the usual appliances from a well-known manufacturer in the south, from whom I also, at a subsequent interview, received much

information valuable to a beginner. On the arrival of my purchases, I successfully transferred the bees from the travelling-box to the hive. I fear that stock suffered much from what is termed excessive manipulation, but in spite of this the bees came through the winter well, thanks mainly to our county expert, who kindly took much interest in helping me to feed up and pack the bees for winter. Early the following spring I purchased two more stocks in frame-hives, notwithstanding the axiom about 'making haste slowly,' and curbing my enthusiasm as I ought to have done. I bought several new hives and purchased a special strain of bees, for which I paid a rather long price, and they nearly brought about my

we it long distances to various shows, taking three firsts at 'Royal' shows among many other prizes. When my apiary had increased to about a dozen stocks I began 'heather going,' though our moors are twenty miles away. I went 'prospecting' on Cannock Chase, secured a stand, took five hives, got some good heather honey, and, greatly daring, despatched twelve jars to the Dairy Show, and, much to my surprise, secured first prize for them. I have since secured premier honours several times for run heather honey, among successes I was placed first at the 'Confectioners' for three years in succession; these successes have brought me more orders for heather honey than I could supply



MR. THOS. RICHARDS' APIARY, CHURCH GRESLEY, BURTON-ON-TRENT, STAFFS.

undoing as a bee-keeper; for after having had my suspicions aroused by certain signs, I called in the expert, and he declared it a case of foul brood in an advanced stage. The bees were removed from the hive and kept confined for three days on the starvation plan, and then put back into the disinfected hive, and from that time I am happy to say I have never been troubled with foul brood. That incident, of course, quite upset my calculations of the success I had expected, but despite the bad luck I secured two second prizes for honey, and a first for observatory hive at our local flower show. The following summer I had rather a sharp attack of 'show fever,' and my observatory hive (shown in the photo)

although I have steadily increased my stocks at the heather.

I have also done fairly well with clover honey at the county and other shows. I possess one gold, four silver, and two bronze medals. But I never got any prizes for clover honey at the London shows, nor do I expect to do so. My locality will not produce honey to rival that of our Hampshire friends. But I shall not consider myself a thorough bee-keeper until I get some high-class sections, as I consider the true test of bee-keeping is the production of good sections. I prefer for regular use the two-bee-way sections and the native bee to fill them. For extracting I like the wide shallow-frame.

The picture seen shows my home apiary; it is located on the borders of a large colliery and pottery village—not an ideal place for bee-keeping—and I find about a dozen stocks as many as I can manage without inconvenience to my neighbours. The hives face south, and are rather a mixed lot—some purchased, some home-made, but all take standard frames. I have two 'Wells' hives, but I have never got on satisfactorily with them. The figure shown in the photo is myself. To cope with the increasing sale of honey I have established an out-apiary on a farm about ten miles from here, where I get some good results, but not record takes by a long, long way. My weight of surplus honey might be larger, but I never rob the brood nest. I go into winter quarters this year with twenty-three stocks.

In concluding, I might briefly say I have been a member of the Derbyshire B.K.A. since 1894, and for several years have been on the Committee, and have twice attended the annual meeting at Jernyn-street, London, but have not yet had the temerity to take part in any discussion there. I am also a member of the British Bee-keepers' Association, and shall always do what I can to forward the cause, which I am afraid will not be very much, as I am only a working man; still, I can hope that all readers of the B.B.J. will have a better season in 1904 than the majority had this year."

### CORRESPONDENCE.

(Continued from page 514.)

#### PRICE OF HONEY.

[5363.] Your correspondent, "Desunt Cætera," in his second letter (5340, page 497), asks me to tell him wherein he is wrong. I may say that, in my opinion, he is wrong all through, for a more misleading and unfair estimate I have seldom read. If the B.B.J. was read by bee-keepers only, he would do no great amount of harm, because all practical men would assess his statements at their proper value, but I know that our journal is read by many dealers in, and consumers of, honey who do not understand bees at all, and in view of this, I ask, what must they think with regard to present prices? Why, simply that we are charging, and getting, unfair prices for our produce, and that we are coming money! I have never heard of a bee-keeper getting rich out of his bees in this country.

"D. C.," after estimating a complete frame-hive at about one-half its actual cost, and swarm at about two-thirds the usual price, goes on to say: profit first year, value of 30 lb. of honey; and profit second year, by good management, value of 100 lb. Now, I assert (and think I can prove) that his estimate is more than double the average amount of surplus honey secured, taking the country through.

After devoting nearly a column of your space to bad estimates, and trying to prove that it would be advantageous to bee-keeping for prices to come down, he says "English honey will fetch its price any time for the trouble of seeking your customers!" And yet he objects to me treating his opinions as "nonsense." I would like to know how else can I treat them?

One more question I would like to ask him is, if the feeling akin to bashfulness has kept him from divulging his name, whence come his showers of "blessings"? He certainly has not received them through the only source I can see possible, that is in the pages of the B.B.J. I may express myself rather strongly, but the "rude awakening" he mentions induces me to do so. I should be sorry to write discourteously of any man for expressing his opinions, but "D. C." should treat the subject fairly, and show that he has the courage of his opinions by selling his produce at the price he quotes, viz., 3d. per lb., and not at higher prices than I quoted myself. When he does this, I shall be pleased to treat his views with respect.—W. PATCHETT, *Cabourne, Lincs, December 18.*

### CLIPPING QUEENS.

#### PREVENTING LOSS OF SWARMS.

[5364.] I should like to thank those who have kindly given their experiences of the matter in your pages in answer to my letter in the B.B.J. of November 5 (5286, page 447).

Of those who have written on the subject only Mr. Ker (5302) seems to have been unsuccessful; but I think the case he gives of the new queen heading the swarm, and the old one being lost, though it might occasionally happen, is an exceptional one, as young queens do not generally hatch till some days after the swarm has left.

I also thank "H. F., G. B. D." (5320), and Mr. Pearman (5342) for their interesting letters, and quite agree with the latter that it is better to lose a queen than a swarm.

I have a full-grown oak quite close to my hives, and am afraid that one day I shall have a swarm cluster on one of its topmost branches, unless I adopt some means such as queen-clipping to prevent it. There seems to be only one drawback to clipping as pointed out by "W. D." (5321), viz., the possibility of injuring the queen; and though Mr. Pearman thinks it has no ill-effect, and Mr. Root in his "A. B. C. of Bee Culture" says that clipped queens are just as fertile and live as long as unclipped ones, yet there is still a doubt in my mind as to the painlessness of the operation, as it seems the cutting of the delicate wing of a queen must be more painful than cutting, say, the wing of a hen. This is the difficulty, for I do not want to lose my swarms, neither do I wish to cause any unnecessary pain to anything. "W. W." (5352) says the great question is how to



prevent swarming, but I fear this is a problem which is not yet solved for all localities, even if it has been in some; so until this is done attention must be given to the question of preventing the loss of bees when they do swarm.—L. ILLINGWORTH, *Acton, W., December 21.*

## MEAD AND HONEY CAKES.

### RECIPES FOR MAKING.

[5365.] Having been asked by many beekeepers, who are readers of the B.E.J., to give a recipe for making honey-cakes and honey-mead, I send on the following if you care to publish these:—

*Recipe for Honey-Cakes.*—3 lb. honey, 3 lb. flour, 1 oz. powdered ammonia, a small teaspoonful of ground cinnamon, half teaspoonful of ground cloves, 6 oz. orange peel cut very small, 4 oz. sweet almonds cut small.

*Directions.*—Pour the honey in a copper or enamelled pan, and set on a stove, or quick fire. When it boils, draw it aside and remove the scum (as honey boils up very quickly, great care must be taken not to let it boil over). Then pour the honey into the vessel in which the paste is to be made; leave it to cool; then add flour and other ingredients, except the ammonia, which latter must not be added till the flour and honey has been mixed up, and the paste has become quite cold. In preparing for use, place the ammonia in a cup, pour on a few drops of cold water and stir it well, so as to form a thick paste, then mix it up with the rest. Then take a piece of the paste, roll it out into a cake not over a  $\frac{1}{4}$ -inch thick, and cut up into convenient sizes as desired. This done, put cakes on a flat tin (which must be greased beforehand), and bake from twelve to fifteen minutes in a hot oven.

*Recipe for Honey-Mead.*—Procure a 25-gallon cask, of which the top has been taken out, place it standing upright in some corner of the kitchen (as heat is a necessary condition for success), and put in 18 lb. of ordinary raisins. Pour in 2 or 3 gallons of warm water (preferably rain-water), and cover the cask with a cloth. Two days afterwards dissolve 80 lb. of good honey by adding rain-water made very hot, add 3 oz. of tartaric acid, then pour into the cask, which is then nearly filled with water, leaving sufficient space for the raisins to swell and rise to the surface as they will very soon do. Twice a day the raisins must be forced down below the surface of the liquid, otherwise the mixture will show a tendency to ferment and turn into vinegar. A week or so later take out the raisins, and press them well in a vessel so as to separate the skins; put the juice back into the cask. The empty space in cask is then filled up with warm water. To ensure a good fermentation, the liquid should be kept at a temperature of about 87 deg. Fahr. The room should also be warm and airy. A fortnight afterwards decant the mead into an

ordinary cask of the same dimensions as the first one used. If not quite full, add some water rather than to leave an empty space. The bung must not be inserted as long as the fermentation goes on. My practice is to leave the mead eight days more in the kitchen, then remove to the cellar, where, after three or four months, it will become clear and transparent and ready for bottling.

It is a great mistake—and often a cause of failure—to use honey which contains pollen for making mead, or to brew the liquor in a vessel which might give it a disagreeable smell. In this way also I would not advise the use of honey which has a strong pronounced flavour, as heather, for example. The best is good white honey. My experience, however, teaches me that the rank flavour and disagreeable taste imparted to mead by some honeys, will almost disappear if the honey used is boiled.

For the benefit of those who have not high-class honey at command for mead-making, I recommend the following recipe as reliable:—

In a clean boiler (copper or enamelled) put 15 gallons of rain-water. When this begins to get warm, pour in 25 lb. of honey, leave it to boil slowly for  $1\frac{1}{2}$  hours, keeping it well skimmed during this time. Then pour the liquid in a vessel to cool. When nearly cooled down (say, to 82 deg. fahrenheit) transfer the liquid into a clean cask, leaving the bung loose. If the place where you make the mead is not too cold, fermentation will begin after eight or ten days. Two weeks after this occurs, decant the mead into another clean cask, leaving, of course, the "lee," or sediment, behind. In this second cask the fermentation will still continue for ten or fourteen days, after which the bung must be put in and fastened down. Three or four weeks later the mead will be clear and ready for use. Wishing you and all readers a very Happy Christmas.—BR. COLOMBAN, *St. Mary's Abbey, Buckfastleigh, December 18.*

## BEEES AND THEIR FOES.

[5366.] *Ants Attacking Hives.*—In the spring of 1903 I observed that one of my hives had been attacked by ants, and that the bees had unconditionally surrendered, for the ants were going in like Pharaoh's "lean kine" and coming out like his fat ones. Being, therefore, anxious to put a stop to this state of things, I mixed some bee-candy with arsenic, and put it under the hive, placing a piece of perforated zinc over candy, and a small box over all, to make sure that the bees could not get at it. The effect was surprising! On first day the candy was black with ants; second day, only two or three to be seen; third day, ants all gone! I have had no more trouble with them this season. Ants eat their dead, and therefore a wholesale poisoning had been set up by them devouring their dead comrades. Arsenic is, however, a deadly poison, and should be used with the greatest care

Dry soot is also a good thing to place around legs of hives, as it keeps off all wingless insects.

*Wasp-Trap*.—Get a small lamp-glass (price 1d.) and put it top-side down into a 3-lb. jam-bottle, baiting the latter with old beer sweetened; this makes the most effective trap I have ever tried.

*Paint for Hives*.—Some time ago mention was made in B.B.J. about "Hall's water-paint" for insides of hives. I believe it would be a splendid thing for hives when affected with foul-brood. They could be soaked in water, and the paint would peel off, taking all disease along with it. Can any reader tell us of a good bee-flower which is a climber?—H. POTTER, *Brompton, Kent, December 15.*

### DO BEES STORE PROPOLIS?

[5367.] Do bees store propolis for future use or do they collect it as they require it? Shuckard, in "British Bees," states (page 327) that they store it. But Shuckard wrote in 1866, and seems to have devoted more attention to wild species than to *apis mellifica*. For instance, he thought that the departing queen with a swarm did not leave the hive till a day or two after the marriage flight of her successor. And in his discussion of the distribution of work inside and outside the hive he seems to have been unaware that nursing is undertaken by the younger bees exclusively. I have kept bees for many years and have not observed this habit (of storing propolis) but know it takes more than one witness to prove a negative. I do not think the question has been raised in your columns so may be of interest. I enclose card for reference.—ROYAL OAK, *Puncknoll, December 16.*

### BEE AND HONEY SHOWS.

[5368].—Having read the opinions and suggestions of Brother bee-keepers regarding exhibiting and proposed rules for purchasing exhibits, &c., I have been wondering why it has been made a rule to show so many jars of extracted honey in each exhibit, considering the cost of carriage and further loss if damaged in transit.

I would suggest that the following plan should be adopted:—

(1) No entry fee. (2) The exhibit to become the property of the Society. (3) That six sections of comb-honey and four 1-lb. jars of extracted honey be the quantity for each entry staged. (4) Members of county associations to be awarded medals or diplomas in addition to cash prize. (5) Non-members of associations to only have award of cash prizes.

I believe if these suggestions were adopted many more entries would be made, and in having a less number items in each exhibit the whole display would not take up so much valuable room, nor would it be so severe a loss to an exhibitor if he got no award. It would also

be equally fair to the small apiarian as to the owner of a hundred hives; not only so, but in a season of scarcity like the present one, the absence of good exhibits would not seriously handicap anyone from entering at several shows from which they have been hitherto excluded, through all their best being at one show.

Trusting these ideas will commend themselves to the various committees and associations, I send name, &c., and sign myself.—A PRIZE-WINNER, *Luton, Beds, December 21.*

### CONVERSATIONS WITH DOOLITTLE.

#### UNIFORMITY IN HIVES, ETC.

"I am about to make some new hives. Is there any advantage in both upper and lower stories being just alike, so they can be used together or separately?"

"There are many advantages in having all hives in use of the same size, and several in having both stories just alike. Some of them are as follows: In making you can do the same much faster, and with less bother; you can use the upper story for the same purpose you do the lower, at any time you desire, which will be very often, I assure you; and then, one, two, three, or more will fit together like clockwork in tiering up, without any outside shell to cover them."

"Yes, I see. But what about the entrance? How can that be arranged?"

"By making the entrance in the bottom-board, where it should always be. Thus, this part need not affect the hive at all. If made there, you will never have any bother from this entrance when changing hives, reversing them, changing the front for the rear, or any such thing; and I am sure, after once having hives without any entrance cut in them, you will never go back to the old plan of entrances in the hive again."

"That seems quite simple now you mention it; but I had not thought but that I was obliged to have the entrance cut in the hives as did our fathers. But we must not tarry too long on any one thing lest I weary you with the many questions I wish to ask on different subjects. I must have frames for my hives. Would you advise me to buy wired frames by the hundred, filled with foundation?"

"That depends upon conditions, because if you expect to work your apiary for extracted honey it might be the better plan; and even if you work it for comb honey, and have not the time to look after the combs properly, while they are being built, or if your time is very valuable, it may be the better way to buy as you suggest."

"What are the conditions under which you would not think it advisable to buy?"

"With the average bee-keeper, who has some time at his or her command, I think it will pay fully as well, especially where the sections are filled with thin foundation, to use only starters of comb or comb foundation

in the brood-frames, say from  $\frac{3}{4}$  in. to 1 in. wide, as it will to fill the frames full of the same, to say nothing about the saving of money and time. It is the opinion of several of the best bee-keepers of to-day that as much or more comb honey can be secured by allowing the bees to build their comb in the brood-frames, using starters as I have spoken of, than by any other mode of procedure."

"I suppose this would give me nice comb honey too?"

"Certainly. Comb honey of the most fancy make can be produced in this way, and the difference in selling price between this and that built by a colony having old black comb below, where much of the old wax is worked into the capping of the section honey, is an item worth looking after. But, so far as I can see, just as nice honey comes from a colony having frames filled with foundation as does from frames having only starters, so this fancy section honey has no claims against frames filled with foundation."

"I thank you for this explanation. Now I should like your experience regarding the wintering qualities of the Italian bee as compared with the German. Can the former stand the cold winters we have in 43 degrees north latitude as well as the latter?"

"It is said by some that they do not; and I used to believe that the black or German bee was the hardier; but that was before I made any careful test in the matter. Some twenty-five years ago I began to look carefully into the matter of wintering; and during the experience of all these years since, I have become convinced that there is little, if any, difference in favour of either along this line. Some winters the blacks seem to do the better; in others the Italians come out ahead."

"Now I wish to thank you again, and will come to the main item which brought me over to see you. A neighbour has given me some bees in box hives, because he thinks they have not stores enough to winter on. How can I feed these bees?"

"This could have been very easily done a month ago, and perhaps now, should there come a warm spell, or our usual 'Indian summer,' by boring a hole in the top of the hive, if there is none already there, and placing a feeder on top, covering all with a hood, box, half-bushel, or something of that kind."

"What shall I use for this feeder? I have none."

"If you do not have a feeder, a suitable sized tin basin or pan will answer every purpose for such feeding. After having the feed in the pan, pull up some rather short grass and scatter it over the top of the feed for a float, to keep the bees from drowning, and set up a piece of section material in such a way that the bees can climb on it over to the feed. Above all, be sure that all cracks under and about your over are bee-tight, otherwise you may have a

bad time with robber bees, especially should it come off quite warm."

"Can I not put off feeding till winter?"

"No!—a thousand times no! It has been put off already too long. Allow me to impress on your mind, so it will always stay there, that from September 20 to October 5 is quite late enough to feed bees."

"But suppose there come no warm days—what then?"

"If it should happen, and you find the bees are nearly or quite destitute of food when winter sets in, take the box hives to the cellar, turn them bottom side up, and every three or four days sprinkle a few tablespoonfuls of honey over the bees and combs, having the honey a little more than blood warm."

"Will the size of the colony make any difference?"

"Yes. If any are large colonies, or any seem to require more, use as much as half a teacupful each time, but do not use so much that they will not take it all, as that which runs down in the hive and stays there will sour, and cause the bees not to winter so well."

"What will be the chances if I cannot feed them this fall?"

"Bees have been successfully wintered by feeding them while in the cellar in the way I have told you; but the chances are that a loss of feed and bees will be the result. Still, if I were in your place, I would try it if no warm spell occurs, as you will gain in experience, even if you lose the bees."

"Would it do to leave them till winter, and then set them in a warm room under netting, to feed?"

"I should prefer not to try it, though you might one or two, if you wished to. From my experience in the past, such a procedure would cause them to become uneasy and to go to breeding, thus consuming large quantities of food, which would in all probability cause diarrhoea, resulting in death. There is a chance for such occurring where fed in the cellar, but not as much as in a warm room."

## Queries and Replies.

[3298.] *Feeding Bees in Skeps.*—1. Will you kindly tell me through B.B.J., what is the best method of feeding a stock of bees in a skep, in order to keep them alive through the winter? The skep in question is now placed on a flat stone. There is no floorboard, and the lower edge of skep is plastered with mortar all round, except at entrance where the bees pass in and out. 2. What is the best month to transfer them to a frame-hive? Your reply will oblige—A BEGINNER, *Tetbury, Glos., December 21.*

REPLY.—1. It is now too late in the season to give syrup-food, consequently you will have to

rely on a regular supply of soft bee-candy. Regarding the "method of feeding," if there is not already a feed-hole in skep, you will need to cut out a circular piece in top about large enough to admit the mouth of a screw-cap honey-jar. This done, and with, say 2 lb. of candy ready, press the latter into the feed-hole, and round off the upper side of the cake so that it may be covered over neatly with a piece of leather-cloth put on glazed side down. Cover all down with warm wraps, and secure the latter all round with wire nails pushed into the straw. Renew the candy as often as consumed. 2. April is the month usually chosen for transferring operations, but you must let us know what plan of transferring it is proposed to adopt. We advise allowing the bees to transfer themselves, but will defer saying how this is to be done until we hear again from you.

## Echoes from the Hives.

*Hatfield Heath, Harlow, December 21st, 1903.*—The bees rest, conserving their strength for future efforts. The small "Echo" from the hives is all of peace and unity for the common good. May we all be willing to learn from the bees! If you please, Messrs. Editors, I would add a line to wish the "Compliments of the Season" to yourselves and all bee-keepers.—WM. LOVEDAY.

## Notices to Correspondents & Inquirers.

*Letters or queries asking for addresses of manufacturers or correspondents, or where appliances can be purchased, or replies giving such information, can only be inserted as advertisements. The space devoted to letters, queries, and replies is meant for the general good of bee-keepers, and not for advertisements. We wish our correspondents to bear in mind that, as it is necessary for us to go to press in advance of the date of issue, queries cannot always be replied to in the issue immediately following the receipt of their communications.*

\* \* Without being able to reply personally to the expressions of goodwill which have accompanied nearly every letter received for some days past, the Editors desire to say how much they have been gratified by the kindly feeling displayed in this way, and that the good wishes of our readers are most cordially reciprocated.

J. D. (Oxon).—*Disputes between Buyers and Sellers.*—Though quite unable to undertake the task of arbitrating on disputes between buyers and sellers, we have gone through the letters sent, and, without troubling to wade through those on the other side (which have been promised if we desire to see them), we are glad to hear the matter is settled, as stated. With regard

to our "opinion," it seems to be a case of fixing responsibility for damage to bees and hives in transit; and this could only be done after much trouble and inquiry. You will, we think, be well advised in allowing the matter to drop, as the buyer has certainly had both trouble and expense over the affair through no fault of his own. We can only again express our conviction that he is wisest who avoids "law" wherever possible.

BUCK UP (Snodland, Kent).—*Bees Dying in December.*—The bees sent are Carniolan hybrids. There is nothing to indicate cause of death; in fact, we expect it is nothing more than the usual dying off—through old age—that is constantly going on in the winter months. We have no doubt that your further experience, after perusing "Guide Book" recently ordered, will enable you to avoid the mistakes to which all beginners are liable. And since you are determined to "buck up"—whatever that may mean—we may feel sure all will go on right next year.

J. MARTIN (Bog Farm, Port Elizabeth, S.A.).—*An Examination.*—Very pleased to get your interesting Christmas photo, and hope to reproduce it in next issue, as possessing interest for the many readers who will be glad to see a portrait of their old friend in his new sphere as an ostrich breeder and bee farmer in S. Africa.

F. R. C. (Sittingbourne).—*Seasonable Bee-photos.*—"W. B. C." is much obliged for Christmas card photo of apiary, showing your "boys" and self; and, in returning your good wishes, hopes to some day see you in the flesh.

### Suspected Comb.

*Special Notice to correspondents sending queries on "Foul brood."*

*We urgently request that all letters sent with samples of suspected comb be put outside the box or tin containing the sample. Also that no more than a couple of square inches of comb be sent, taking care to neither crush the comb nor probe the cells before despatching.*

*In urgent cases (and where possible) we undertake to "wire" replies as to F.B. if six stamps are sent to cover cost of telegram. All letters should be addressed "Editors," not "Manager."*

T. W. (Herts).—It is altogether too late now to do anything by way of dealing with the hive from which sample of comb was taken. Nor do we think it worth while to tinker with it at all, as the comb is affected with foul brood of old standing, and even if bees are "fairly strong," as stated, we should burn the lot rather than risk the present healthiness of your other stocks.

### Honey Samples.

D. F. S. (Co. Durham).—If your honey is all like sample, it should sell at this season if a moderate price is asked for it. Why not advertise it, either locally or in our pages?

## Editorial, Notices, &c.

### THE OLD YEAR AND THE NEW.

The fact that the final number of Volume XXXI. will be in our readers' hands on the closing day of 1903 affords us the opportunity of heartily wishing that to-morrow may see the opening day of a more prosperous year for all connected with bees and bee-keeping. Things have not gone too well for bee-craft as a whole in the past twelve months, though a small minority have come out fairly well for what has been an admittedly disheartening season. But what strikes us most just now is the cheery way in which the disappointment has been endured. Our opportunities for judging are known to be exceptional, and we hear of very few who are "giving up bees in disgust," as the saying goes, while the number of recruits joining our ranks shows no falling off, but points very encouragingly the other way. This being so, our anxiety just now is to impress upon all—who are fortunate enough to have kept their bees alive—the need for making the utmost of the valuable material they have on hand in the shape of strong, healthy colonies, well provisioned and able to give a good account of themselves in the new year.

It is no uncommon thing in bee-keeping to find a succession of several bad seasons followed by an abnormally good one. And some of us are old enough to remember that when the "honey glut" came there remained comparatively few bees alive to gather it in. Hence our word of warning to the careless bee-keeper if such be found among readers of the BRITISH BEE JOURNAL.

In bidding good-bye to the old year, we again wish happiness and prosperity to all in the new one.

THE EDITORS.

### BEE-FARMING IN PARAGUAY.

Bee-keeping in South America has not yet attained that measure of development which the eminently favourable nature of the climate seems to warrant. In the drier parts of the Argentine Republic, such as the provinces of Mendoza and Cordoba, there are a number of apiaries, and probably in this part bee-keeping is more general than elsewhere in the South American continent. That portion of Argentina has a climate somewhat resembling that of Southern California, which has been called the paradise of bee-keepers. The almost continual sunshine and the absence of any real winter are great advantages, while the local market for the produce is fairly good. In the following lines, however, I will confine myself principally to Paraguay, as a part of the continent with which I am better acquainted, while the climate is, if anything, in my opinion, still more favourable to bee-farming than that of Argentina. Paraguay also has the advantage

that land, living, and labour are all cheaper than in the neighbouring Argentine Republic.

It certainly cannot be said that bee-farming has been overdone in Paraguay, as there are very few apiaries of any size in the country. This is, perhaps, more owing to the absence of technically trained apiarists than any other cause, as there are a number of agricultural or pastoral farms in which apiaries of from fifty to a hundred hives exist. Most of these are owned by Germans, who seem to have been the pioneers of the industry in the country, for the aborigines designate honey by a name which signifies "German syrup," a fact which would seem to indicate that the honey-bee was introduced into the country by our Teutonic cousins. The honey-bee was certainly not indigenous to any part of America, for I remember that old settlers in the Western States will still tell you the year in which the insect crossed the Mississippi, while about sixty years ago, when California was still almost a *terra incognita*, it was gravely asserted by General Fremont (one of the first to explore that region) that the bee could not exist in California—the very region which is now designated "the bee-keeper's paradise!"

In Paraguay there is, properly speaking, no winter, for the season so termed is scarcely colder than an English autumn, and the thermometer never sinks to freezing point except sometimes in the early morning, the frost being invariably dissipated by the rising sun, and frosty mornings may be followed by quite warm days. The months of May, June, July, and August (it must be remembered that the seasons are reversed on the south of the line) are the only ones in which the collection of honey by the bees is interrupted. It must not be imagined that the bees are idle during all this time, as there are many warm days in winter in which they are actively at work, for although flowers are not so plentiful during the winter months, they are far from being absent.

The honey season may be said to commence about the end of August or beginning of September, when the orange trees are in bloom. The orange blossom is a most valuable factor in the production of honey, as the tree commences to bloom about the end of winter (there is no season which can be called spring in Paraguay), at a time when the swarms are weak and other flowers scarce. The orange blossom produces an excellent honey, of fine colour, pleasant flavour, and admirable keeping qualities. Orange trees are present everywhere in Paraguay; they grow wild in the woods in great abundance, and are, in fact, in many parts the commonest wild tree. Although the fruit of the wild tree is not edible, the flowers are equally valuable as bee-pasture. The orange trees continue in flower for about two months, when their place is taken by numerous other flowers. Some plants, such as the banana, are in flower more or less all the year round; but, although they contain a large

quantity of honey, from the shape of the flower they are difficult of access to the bees, who are, however, very fond of them, and may be seen busily collecting honey from such flowers as have fallen to the ground.

To make a comparison between Paraguay and Australia, another part of the world where many large apiaries exist, Paraguay is exempt both from the extreme droughts and the extreme heats of Australia. In the latter colony the thermometer frequently rises to 120 deg in the interior; in Paraguay a reading of 100 deg. is rare. Australia is just recovering from a drought of seven years' duration; in Paraguay, if a whole month passes without rain, it is called a drought. Owing to the cheapness of living and of labour, working expenses are much less in Paraguay than in Australia, while the prices obtainable for honey are also in favour of the South American country. In Paraguay the average price obtainable for honey (wholesale) is about 5d. per lb., while in Australia, so far as I can learn, the average price is only about 3½d. per lb. It is true in Paraguay the market is limited, but there is nothing to prevent the honey and wax from being exported to any part of the world. In Buenos Ayres there are dealers who advertise that they will buy honey by the ton in any quantity, but I cannot say whether it is more advantageous to sell in the Buenos Ayres market or to export to Europe. The latter market is certainly practically unlimited.

It is said that in tropical or semi-tropical countries bees tend to lose their honey-collecting instinct. In a country where there is no winter and flowers abound all the year round, there is, of course, no object why the insects should lay up any store of honey, and, so it is claimed, they are apt to become lazy and live only for the passing hour. So far as I can learn from my own experience and that of other bee-keepers in Paraguay, there is no perceptible diminution in the laborious habits of the bees domiciled in the country. Although there is no valid reason why they should lay up stores of honey, in view of the never-failing bee-pasture which is to be found there, yet the insects still conserve the instincts of their primeval climate, and continue to work as assiduously as ever in the manufacture of honey and wax. At the same time, I think it not improbable that in the course of generations the honey-saving instinct will become lost or impaired; but, if so, the process is so slow as to be imperceptible. I think, therefore, that it would be advisable on the part of all bee-keepers who think of emigrating to South America to bring with them a good supply of fresh queens of the most approved breeds, so that, by the introduction of fresh blood (if such a term can be used when speaking of bees) from time to time, the original instincts of the bees may be preserved and any deterioration prevented.

Except in some of the larger apiaries, it is

not the custom to feed bees in Paraguay during the short and mild winter, when, as already said, pasture is always to be had. Most bee-keepers do not leave any honey in the hives, but it will be found advisable to leave a small quantity in all the hives, for during winter there are many spells of cold and wet weather, lasting sometimes for ten days or more at a stretch, when the insects do not venture forth, and would be apt to suffer if left without a drop of honey. Insect pests are plentiful, and when the hives are weak may give a good deal of trouble; but, with proper care and attention, seldom do much damage. Toads of gigantic size are also numerous, but cause little destruction if the hives are raised a sufficient distance from the ground. Ants are abundant, but give little trouble except in very weak hives. The bees are not subject to disease. I have heard of very few cases of foul-brood, and those have generally been due to carelessness. Larger enemies are not much in evidence. In Southern California I remember to have seen a bee-farm at the foot of the mountains, which was surrounded by a barbed-wire fence to protect it from the attacks of grizzly bears. No such precautions are necessary here.

In the winter-time sudden squalls of wind from the south, which are cold and attended with storms of rain, are frequent, being in their character somewhat like the "southerly bursters" of Austral. Cyclones and tornadoes, however, are unknown. Paraguay is not an agricultural country, and is not likely ever to be. The climate is genial, the soil fertile, and land and labour are both cheap. Notwithstanding all these advantages, agriculture is not lucrative, chiefly owing to the extreme cheapness of all kinds of produce and the uncertainty of the markets. Nevertheless, newcomers, though frequently warned, often embark in agriculture on a large scale, with disastrous results. For pastoral farming of all kinds, on the other hand, it is admirably adapted, and, when intelligently conducted, cattle-raising is generally very profitable. Some of the most prosperous bee-farms I have seen in Paraguay were those which were run in connection with a cattle-farm. As cattle-farming as conducted in Paraguay does not take up too much of a man's time, it leaves him ample leisure at all seasons of the year to attend to his bees if he has a fancy for this kind of stock. Quite recently I paid a visit to a farm of this kind, kept by a German. It was romantically situated at the foot of a mountain, for the most part open prairie land, on which hundreds of cattle were grazing, with just sufficient forest to give shelter to the cattle and provide wood for fuel and fencing. He had about a hundred hives, and was an intelligent bee-farmer. He made his own hives, scientifically constructed, with three tiers of frames, queen excluders, and glass panels at the back for purpose of observation. He had all the most improved appliances in

the way of wax and honey extractors, and made his own foundation. In the way of agriculture, like a wise man, he had no more ground under cultivation than was necessary for the supply of fruit, vegetables, and grain for his family. His only hobby, except bees, was the cultivation of bananas, of which he had a grove, by no means large, but sufficient to give a large surplus, which he converted into excellent vinegar. He had also dried the fruit, and in this condition, resembling figs, had tried to find a market for it in Europe; but, although admirably prepared, his efforts were not successful.

It is this kind of mixed farming which is most profitable in Paraguay, and it can be undertaken here on a comparatively small capital.—JOHN D. LECKIE, *Villa Rica, Paraguay. The Field*, December 12, 1903.

[The above excellent article has aroused unwonted interest among B.B.J. readers, as conveying valuable information to bee-keepers who may possibly contemplate seeking "fresh fields and pastures new" in which to follow their favourite occupation with benefit to themselves and advantage to the land of their adoption. Several copies of *The Field* have been sent to this office with requests for insertion of the article in our JOURNAL, which is the most likely medium for bringing it to the notice of bee-keepers. We have much pleasure in complying with the wishes so expressed.—Eds.]

## Correspondence.

*The Editors do not hold themselves responsible for the opinions expressed by correspondents. No notice will be taken of anonymous communications, and correspondents are requested to write on one side of the paper only and give their real names and addresses, not necessarily for publication, but as a guarantee of good faith. Illustrations should be drawn on separate pieces of paper. We do not undertake to return rejected communications.*

*Communications relating to the literary department, reports of Associations, Shows, Meetings, Echoes, Queries, Books for Review, &c., must be addressed only to "The Editors of the 'British Bee Journal,' 10, Buckingham-street, Strand, London, W.C."* All business communications relating to advertisements, &c., must be addressed to "THE MANAGER, 'British Bee Journal' Office, 10, Buckingham-street, Strand, London, W.C."

*\*. In order to facilitate reference, Correspondents, when speaking of any letter or query previously inserted, will oblige by mentioning the number of the letter as well as the page on which it appears.*

### SHOWS AND SHOWING.

MR. WESTON'S VIEWS.

[5369.] Will you allow me some space in which to put forward my views on the subject of "shows and showing," as my name has been freely used in connection with it by several of your correspondents? To begin with, I think it advisable to clear away a misconception. The motion (of which I gave a month's notice) which was carried at our November meeting was not intended to bar in any way the honest exhibitor from showing and taking prizes as often as he has opportunity. No. *The motion*

*was aimed at the dishonest or fraudulent exhibitor only.* Here I know I am treading on thin ice, and, having the fear of the law of libel in mind, must leave names alone. However, I will draw your readers' attention to the expressions in your pages. Mr. Woodley (page 472): "The feeling that I have had to show against myself has induced me to give up my former practice of entering my exhibits for sale." Mr. C. N. White (page 422): "It appeared that these sections had been bought and re-exhibited under another name." "A Village Schoolmaster" (page 504): "Will (they), I ask, check this evil (viz., fraudulent showing), which is demoralising one class of exhibitor and discouraging another?"

In a private letter from a well-known Northern B.K.A. Secretary is the expression, "I take your motion as an honest attempt to remedy an existing evil"; also one B.K. Association has had to adopt the plan of stamping sections in order to check the evil. With letters of complaint sent to the Council it is impossible to deal here, as they are private, but I can assure you it is only because there seemed a necessity for something to be done which caused us to take the step, for, as Mr. W. Loveday says (page 513): "This sort of thing is, I am sorry to say, carried on at some of what should be our best exhibitions of apiarian produce in a way calculated to bring ruin either to the shows or to those who are determined to win prizes at the cost of truth or anything else." The italics are mine.

The evil to be stopped is the buying of prize exhibits to be re-shown elsewhere in another name. My remedy is: Let the Committee buy up the prize exhibits and have them consumed. Has any one a better plan to offer? Mine is simple and effectual. Of course, the B.B.K.A. can only deal with the shows under its management; but it can, and should, set the example to all other show committees, and I would gladly see them all follow it by buying up the first prize exhibits in the comb and light extracted-honey open classes, making sure, however, that the honey was consumed. I say open classes only, because in local classes there is far keener watchfulness by an exhibitor's neighbours, and therefore less crooked dealing.

My letter, I fear, is growing too long, so, with your kind permission, I will return to the subject in your next issue. Wishing you and all friends of the busy bee a happy and prosperous New Year.—THOS. I. WESTON, *Balham Park Mansions, S.W., December 28.*

### ON VARIOUS TOPICS.

[5370.] *The B.B.K.A. Annual Meetings.*—Mr. W. Woodley (5358, page 512), having honourably withdrawn his imputation as regards recent years, and modified it as regards the past, I will now ask him to believe that I had, and could have, no personal feeling in

the matter. My protest was entirely for the credit of our parent Association and of British bee-keeping in general. The B.B.J. conveys our joys, grievances, and thoughts in general to many countries.

*Purchase of Prize Honey.*—The suggestion made by "G. S. N." (5361, page 513) seems to me a very good one. The addition of 15s. to the prize-money, and the glory and advantage of having his best produce displayed, ticketed with name and address, at subsequent London shows of the season should console any prize-winner for the loss of his dozen sections, while he still has the chance of winning again with his next best dozen. On the other hand, less fortunate competitors would be encouraged to come forward again, or for the first time, and the public would obtain the educational advantage of a display of the best British honey procurable. The care of its purchase while in the hands of the B.B.K.A., and its final disposal would doubtless receive due attention.

*Nectar-Producing Wall Shrubs.*—An inquiry was recently made for the name of the best wall shrub or climber, from the point of view of the honey bee. The only hardy shrub known to me that satisfies the condition is *Cotoneaster microphylla*, sometimes called rose box on account of the shape of its leaves and flowers, a well-known evergreen that came to us from Nepal. In April and May its small white flowers are very popular. The pink flowers of *Cotoneaster horizontalis*, another variety, are also much visited. This does best on a sunny bank, where it likes to sprawl and is an unfailing attraction to queen wasps. Both varieties are ornamented with bright red berries, and the leaves of the last named take on a fine colour in autumn.

The handsome flowers of *Pyrus japonica*, another popular wall shrub, afford pollen in spring and October; I am not sure about honey. Ivy supplies both, but often too late in the year to be of much service.

*The Storage of Propolis.*—On page 518 a correspondent (5367) asks whether bees store propolis in cells? Good observers in England and on the Continent agree that they do not. On page 77, vol. xxviii., B.B.J., there is a full description of how bees deal with this substance, as seen in an observatory hive.—H. J. O. WALKER, Lieut.-Colonel, *Budleigh Salterton, Devon, December 27.*

### BEEES IN WILTSHIRE.

[5371.] I write from the highest and coldest point in the county of Wilts, and send on a few notes of our bee-doings in the season 1903. First, then, let me say it has been a very poor one for all skeppists, but as one who works with frame-hives I have no reason to complain, seeing my five stocks stored over 300 lb. in the supers. My first take of honey weighed 200 lb., and left on five partly filled but not

sealed supers. The weather then became bad again, and when next examined I found all unsealed honey was carried down below. I can fully endorse all Mr. Woodley has said re the "combination hive," nearly all mine being of that type. I also agree with what Colonel Walker stated some time ago on the working of swarms. Wishing to start a new apiary on the last day of May this year, I hived a large swarm on eight frames 16 in. by 10 in. Bad weather kept the bees indoors during the first three weeks, and I had to feed, but on June 22 lovely bee-weather set in, and as the bees started to work with a will I at once put on a box of shallow-frames, which in a week was filled, sealed, and taken off, and a rack of sections took its place. On the last day of June they sent off a large swarm. Finding plenty of bees still in the hive, I left the super on, and they finished and sealed all the sections except three, which latter were filled, but not sealed, when removed. I replaced this with a box of shallow-frames, and these were filled, but only partly sealed over.

The hives in which my honey-crop was stored are home-made, cheap, non-swarmer hives made from "Quaker Oats" boxes, lined inside with good dry pine boards. I work the brood-nest at the back to prevent swarming, and fill up front with shallow-frames fitted with starters only of foundation. Then, if supers are not removed in time, the bees, instead of swarming, get to work in front of the dummy, which latter is made the exact size of a standard frame, giving not only the  $\frac{1}{2}$  in. below it, but the  $\frac{1}{4}$  in. space at each end of the same.

My bees remain all winter open to the front of hive, and the roof. I make a simple winter-passage across all frames by placing two strips of wood ( $\frac{1}{4}$  in. thick and  $\frac{1}{2}$  in. wide), 4 in. apart, and across these strips I nail picture-backing  $\frac{1}{2}$  in. thick. On this I put glazed cloth, and above that about 6 in. of quilts. The bees are wintered on the whole ten or twelve frames used during the working season, and with this treatment they come out healthy and strong in spring.

Wishing our Editors and all bee-keepers the compliments of the season, and a better one in 1904.—W. WEBBER, *Burbage, Wilts, December 23.*

### LEATHER-COLOURED ITALIAN BEES.

[5372.] With reference to the recent inquiry in the BRITISH BEE JOURNAL as to where leather-coloured Italian bees, similar to those imported many years ago, can be obtained, will you allow me to say that there is no difficulty whatever in obtaining these bees? I imported parcels of these queens from Italy and Switzerland every week—sometimes twice a week—throughout last season, and supplied them promptly to all applicants, as advertised in the BRITISH BEE JOURNAL. I hope to do



the same thing next season. I also keep colonies and nuclei of these bees.—F. W. L. SLADEN, *Ripple Court Apia.*, near Dover.

individual bees in the original photograph are very distinct.—C. V. S., *Walton Park, Clevedon.*

#### A CORNISH BEES' HOME.

[5373] In my wanderings during my summer holidays in North Cornwall, I happened to come across a beautiful specimen of a natural observatory bee-hive, which may be of interest to your readers. I therefore send you a photograph. This self-selected bees' home is an old unused rabbit-hutch, built into a cob (mud and straw) wall about 5 ft. from the ground. The swarm took possession of this early in July by entering through the

### Queries and Replies.

[3299.] *Re-queening Stocks in December.*—I have to-day found a dead queen on the ground outside one of my Italian stocks, and, as a reader of your journal, would be obliged if you will give me some advice on the following:—1. Is it too late now to introduce another queen, or should I allow the stock to remain queenless until spring, and then unite the bees to another colony? 2. If this course

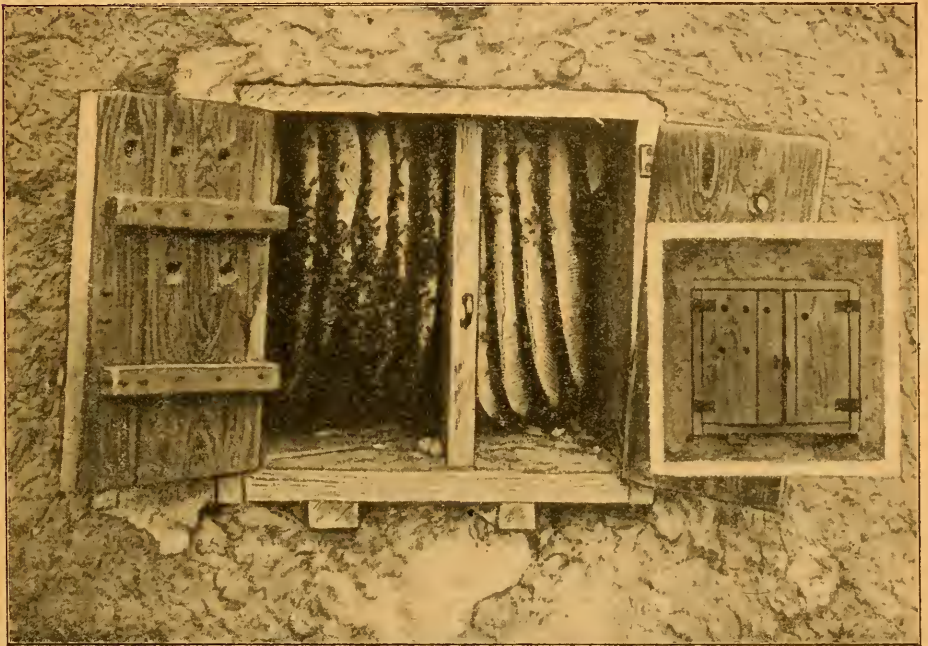

BEES IN A CORNISH RABBIT HUTCH.

holes when the doors were closed, as shown on the right-hand side of the photograph. This picture represents the wonderful result of their labours from that time up to September 3 (just two months), when the photograph was taken. The partition which is seen goes through to the back, the left-hand portion is evidently the brood-chamber, and the right-hand a surplus-chamber. All the combs are remarkably regular, since they are entirely the bees' own handiwork. I estimate that there are 30 sq. ft. of comb, and about 30 lb. of honey. If they survive the winter, which is doubtful, a very large quantity of honey should be obtained another season. The

is not advisable, what do you recommend me to do? It should be explained that I moved the hive a foot or two away from its original stand on Saturday, the 19th, but no commotion seemed to be caused in hive through removal, or I should have opened and examined it. 3. Do you think the queen was "balled" as a consequence of removing, as I cannot otherwise understand how she was killed?—A. H. BARTLETT, *Crowthorne, Berks, December 23.*

REPLY.—1. Bees that have been queenless all winter are of little use for uniting purposes in the following spring. We should take the first chance of examining the combs

to see if queen-cells are started, and if this be so, and a fertile queen is available, we advise introducing her to the stock without delay, while the bees are in condition to take kindly to an alien queen. 2. The best alternative plan would be to unite the bees to another stock as soon as convenient by adopting the plan of setting the queenless stock above frames of the colony to which they are joined, separating the two lots by a sheet of brown paper in which a few small holes are pierced. On this plan the bees will themselves enlarge the holes in paper, and so join forces without quarrelling. 3. It is most probably a case of "balling" through the removal of hive as stated.

best thing to do, seeing that I do not wish to increase the number of my stocks beyond two hives. Thanking you for past favours, also for reply to this, I send name for reference, and sign—SEASIDE, *Harwich*, December 26.

REPLY.—The proposed plan will be quite the best thing to follow, unless it should happen that the older queen you wish to destroy is the better of the two. It is not always safe to assume that a queen is old and failing because the stock she heads has not swarmed. Bees frequently re-queen themselves. We should winter both lots, and see which hive is making most headway in April next, then unite, reserving the more promising queen of the two.



*A Christmas Card from South Africa: "An Examination."*

"Best wishes to all old friends, and for the success of the BRITISH BEE JOURNAL, from J. Martin, late Expert B.B.K.A., Bog Farm, S. Africa."

[3300.] *Uniting Bees for Renewing Queens.*—I am again seeking your advice under the following circumstances. Last spring I bought a stock of bees in a frame-hive from which I got 40 lb. of honey, but the bees did not swarm; consequently, I do not know the age of queen. I also transferred a stock from skep to a frame-hive; this lot, however, gave no surplus, but sent out a swarm, and, after the usual interval, a second swarm, or cast. The former I lost, but caught the "cast." I should like to know through the B.B.J. if you recommend my taking away the queen from the stock that gave 40 lb., and uniting the "cast" referred to above with same, thus heading the colony with a young queen. I am under the impression this would be the

#### *Notices to Correspondents & Inquirers.*

JAS. SKINNER (Easton, Bristol).—*Beer-Drinking by Bees.*—The remarks of our St. Mary Cray correspondent (whom we happen to know very well) on page 507, being evidently penned in a jocular vein, were not intended to be taken seriously, and much less as a reflection on the quality of the beer brewed "in the neighbourhood of Bristol." It is therefore hardly worth while to print your rejoinder, for we are quite sure that no offence was intended.

T. G. B. (Milverton).—*Bee-Candy.*—Your sample should be readily taken by bees. It is soft, of smooth grain, and, on the whole, well made.











