

NATURE









8

# NATURE

A WEEKLY

ILLUSTRATED JOURNAL OF SCIENCE

VOLUME XIII.

NOVEMBER 1875 to APRIL 1876

---

*"To the solid ground  
Of Nature trusts the mind which builds for aye."*—WORDSWORTH

---

Printed and Published by  
MACMILLAN AND CO.,  
11, BUNYARD LANE, LONDON, E.C.

London and New York:  
MACMILLAN AND CO.

1876



LONDON  
R. CLAY, SONS, AND TAYLOR, PRINTERS,  
BREAD STREET HILL, QUEEN VICTORIA STREET

YASUJI  
ROYAL CANAL COMPANY  
VT23TV100

# INDEX.

- ABBOTT (Dr. C. C.), Flint Skin-scrapers from New Jersey, 270  
 Abney (Capt.), on Photographing Solar Spectra, 419; Photography of the Red End of the Spectrum, 432  
 Abode, the, of Snow, by A. Wilson, 4  
 Abyssinia, Sport in, Earl of Mayo, 384  
 Ackroyd (W.), Metachromism, 385  
 Acoustic Cloudiness, Prof. Tyndall, F.R.S., 72  
 Adams (Prof. W. G., F.R.S.), Action of Light on Tellurium and Selenium, 238, 419  
 Aeronautics: Balloon Accident at Vincennes, 135; French Society of, 113; in Germany, 397  
 Africa, Andersson's Notes of Travel in South, 144; Birds of North-Eastern, 289; Dr. Schweinfurth's "Artes Africanae," 142; Italian Expedition to, 77, 155; Lieut. Cameron's Expedition, 154, 174, 202, 256, 273, 315, 414; Mr. A. S. Southworth's Journey in, 43; Stanley's Exploration of, 35, 93  
 Agassiz (L.), Geological Sketches, 383  
 Agassiz (A.), Misti and its Cloud, 107  
 Agricultural Diagrams, 36  
 Agricultural Society of England, Journal, 176  
 Agricultural Society of Scotland, 101  
 Agricultural Students' Gazette, 113  
 Agriculture, Scientific, Prof. T. Baldwin, 101  
 "Air and its Relation to Life," W. N. Hartley, 243  
 Airy (Sir G. B.), Freedom of the City of London conferred on, 35; The National Standards and, 46  
 Alaska, the Peaks of, 53  
 Algae, Marine, of the United States, 38  
 "Algebra for Beginners," Loudon's, 404  
 Algeria, Meteorology in 217; Threatened Famine in, 414  
 Alix (Dr.), Locomotion of Birds, 3  
 Allsopp's Ales, 345, 396  
 "Alps, the Indian, and how we crossed them," by a Lady Pioneer, 246  
 Alps, Temperature of the, 532; Unequal Distribution of Rare Plants in the, 516  
 America: Dixon's "White Conquest," 23; Geological Surveys, Prof. A. Geikie, F.R.S., 1; Institute of Mining Engineers, 156 (See also United States, Philadelphia, &c.)  
 American Journal of Microscopy, 297  
 American Journal of Science and Art, 137, 277, 317, 417, 497  
 American Naturalist, 154, 358  
 Amery (C. F.), "Notes on Forestry," 6  
 Amphibians, Wiedersheim on, 30  
 Amú Darya District, 114  
 Analysts, Public, 242, 266, 287  
 "Analytical Geometry," T. G. Vyvyan, 24  
 Anatomy and Physiology, Journal of, 237, 532  
 Anderson (J.), "Mandalay to Momien," 422  
 Anderson School of Natural History, Penikese Island, U.S., 89  
 Andersson (C. J.), Notes of Travel in South Africa, 148  
 André (M. E.), Expedition to Brazil, 76  
 "Anemology," M. Ansart on, 375  
 Angelsey, how it became an Island, Prof. A. C. Ramsay, 279  
 "Angola and the River Congo," Monteiro's, 161  
 "Animal Parasites," Van Beneden's, Dr. Spencer Cobbold, F.R.S., 303  
 Antarctic Exploration, 475  
 Anthropological Institute, 59, 99, 200, 239, 279, 318, 440, 499, 535  
 Anthropological Society, 158  
 Anthropology, Bulletin de la Société d'Anthropologie, 198  
 Ants, Bees, and Wasps, Sir J. Lubbock on, 37, 359  
 Ants, Habits of, Fritz Müller, 304  
 Aphasia, Case of, 400  
 Aquarium, A. W. Wills on the Marine, 189; Manchester, 77, 85; Southport, 197; Westminster, 255; Yarmouth, 77  
 Archæology, Researches in Kentucky and Indiana, 109  
 Archiv für Anthropologie, 130  
 Archives des Sciences Physiques et Naturelles, 237  
*Arctia caja*, Caterpillar of, 54  
 Arctic Seas, J. Lamont's Yachting in the, 264  
 Arctic Expedition, 335; Capt. Adams on, 36  
 Arctic Exploration, German Commission on, 34, 73, 75; Lieut. Weyprecht on, 33; the Swedish Expedition, 116  
 "Arctic World," The, 146  
 Argentine Republic, 53, 189  
 Arrows, poisoned, of the Papuans, 235  
 Arsenic Eating in Germany, 57  
 Ash Seed Screw, 428; Francis Darwin, 465; Dr. W. McLaurin, 512  
 Asia (Eastern), Zoology of, 53  
 Asiatic Society of Bengal, 259  
 Astrocrinites, Mr. R. M. Etheridge on, 339  
 Astronomical Column, 8, 27, 47, 87, 108, 129, 150, 168, 188, 208, 226, 238, 248, 268, 287, 306, 326, 348, 367, 386, 406, 428, 449, 467, 486, 513  
 Astronomical Objects, Birds as, Prof. A. Newton, F.R.S., 447  
 Astronomical Society, 58, 158, 318, 419, 534; M. Leverrier at, 314; present of books to, 397  
 Astronomische Nachrichten, 8, 27  
 Astronomy: Bessel's works, 27; Bulletin International, 255; new works in, 88  
 Atlas Météorologique, 256  
 Atlas Pleiadum  $\Sigma$  453, 129  
 Atmometer, Self-registering, 79  
 Auricula, Prof. Kerner on the, 94  
 Aurora Borealis and Geissler Tubes, 237  
 Australia, Exploration of, 154; First Geological Map of, 352; Forrest's Explorations in, 83; Meteorological Reports, 196; Meteorology of, 396; Australian Implement, J. P. Glover, 27  
 "Australian Heroes," Charles H. Eden, 323  
 Baboon, Dr. H. B. Major on the Brain of, 196  
 Bacteria, Prof. Tyndall, F.R.S., on, 252, 268  
 Baden, Meteorology in, 25  
 Baker (Valentine), "Clouds in the East," 484  
 Balard (M.), Death of, 457; Obituary Notice of, 475  
 Baldwin (Prof. T.), Scientific Agriculture, 101  
 Ball (Dr., F.R.S.), "Theory of Screws," 463  
 Balloon Accident in Paris, 155; at Vincennes, 135  
 Baltic and North Sea, Report on, 53  
 Bar-magnets and Conducting-wires, G. Gore, F.R.S., 176  
 Barbary Races, Papers on the, 436  
 Barometer, T. Stevenson on a proposed Optical, 150  
 Bartlett (R. E.), the River-beds of the Riviera, 406, 448  
 Basalt, the Cup-shaped Joints in Prismatic, G. Poulett Scrope, F.R.S., 47; Prismatic, 7, 47  
*Basidiomycetes*, Fertilisation of, 157, 186  
 Bastian (Dr. H. C., F.R.S.), Prof. Tyndall on Germs, 284, 324  
 Bath Field Club, Proceedings of, 20  
 Bathometer, Dr. Siemens', 431  
*Batrachia* and *Reptilia* of Costa Rica, 257  
 Bax (Capt. B. W.), "The Eastern Seas," 185  
 Baxter River, New Guinea, 76  
 Beats in Music, Dr. Wm. Pole, F.R.S., 212, 232  
 Beccari's Exploration of New Guinea, 336  
 Bees and Flowers, Dr. Müller, 10; Thomas Belt, 26  
 Bees, Communication of Information among, Prof. H. Blackburn, 68  
 Bees, Wasps, and Ants, Sir J. Lubbock on, 37  
 Behring's Straits, Expedition to, 217

- Belfast Natural History Society, 95; Naturalists' Field Club, Report of, 38  
 Belgian Academy, Prizes of the, 413  
 Belgium, Horticulture in, 95  
 Belt (Thomas). Bees and Clover, 26; the Drift of Devon and Cornwall, 58  
 Benedict (Dr.), on Crime, 34  
 Bengal, W. G. Willson on the Meteorology of, 66  
 Bennett (A. W.), the Absorptive Glands of Carnivorous Plants, 403; Sir Thomas Millington and the Sexuality of Plants, 85, 166, 185  
 Bennett (J. J., F.R.S.), Obituary Notice of, 418  
 Bentley and Trimen's "Medicinal Plants," 36  
 Berlin, Geographical Society, 377; German Chemical Society, 80, 119, 178, 259, 319, 360  
 Berwickshire Naturalists' Field Club, Proceedings, 19  
 Besant (W. H., F.R.S.), "Conic Sections," 24  
 Bessel's Astronomical Works, 27, 248  
 Bhutas Worship in Western India, 158  
 Binary Stars, 69, 287, 349  
 "Biology," Article on, in "Encyclopædia Britannica, 221"  
 Biology, Letourneau's, 404  
 Bird (C.), "Twelve Maps for Map-drawing," 7  
 "Birds," Article on, in "Encyclopædia Britannica," 221, 266, 247; Dr. Alix on the Locomotion of, 3; As Astronomical Objects, Prof. A. Newton, F.R.S., 447; of Madagascar, Dr. Hartlaub's Work on the, 272; of North-Eastern Africa, 289; of the Pelew Islands, 152; the Sailing Flight of, 324; Skulls of, Prof. Parker, F.R.S., on, 178  
 Birmingham, Philosophical Society, 396; Science Classes and Penny Lectures in, 149; Sir Josiah Mason's College at, 174  
 Blackburn (Prof. H.), Communication of Information among Bees, 68  
 Blasius on Storms, 421  
 Blowpipe, Works on the, 164  
 Blowpipe Analysis, 186, 208, 224  
 Boisbaudran (M. L. de) on some Properties of Gallium, 136  
 Bonavia (Dr. E.), a Relapsed Donkey, 486  
 Bone-caves of the Creswell Crags, 534  
 Bonnat (M.), Exploration of the Gold Coast, 94  
 Boomerang, the, Rev. H. H. Higgins, 168  
 Boston Natural History Society, 60  
 Botanic Garden, Oxford, 61, 94, 315  
 Botanical Locality Record Club, Report of, 36  
 Botany: Botanical Notes, 38, 117; Calcutta Botanical Gardens, 117; Lectures on, at South Kensington, 436; W. J. Brown's Manual of, 85  
 Bothkamp Sun Observations, Dr. A. Schuster, 402  
 Bottomley (J. T.), the Use of the Words "Weight" and "Mass," 325, 446  
 Boulger (G. S.), Glands of the Cherry Laurel, 107  
 Boyle (Hon. Robert), his Portrait, 76  
 Brazil: Kitchen Middens, Fritz Müller, 304; Maps at Railway Stations, 77; M. E. André's Expedition to, 76  
 Bremen, the Museum of, 273  
 Bristol, University College at, 113, 134, 488  
 Bristol and Gloucestershire Archaeological Society, proposed, 316  
 Bristow (H. W., F.R.S.), Tables of British Strata, 464  
 British Association, Deputations from, on Scientific Instruction, 371; Meeting at Glasgow, 335; President for 1876, 530  
 British Insects, Houghton's Sketches of, 365  
 British Museum, 414  
 Brittany, Hutchinson's Summer Holidays in, 465  
 Broun (J. A., F.R.S.), Effects of the Sun's Rotation and the Moon's Revolution on the Earth's Magnetism, 328; Lisbon Magnetic Observations, 301, 448; Origin of the Numerals, 47  
 Browne (W. J., M.A.), Botany for Schools, 85  
 Brussels, Climate of, 296; Cold in, 235; Observatory, 254  
 Bryant and May's Matches, W. H. Preece, 208  
 Buchan (Alex.), The Flowering of Spring Plants, 249; Swedish forms for observing Cirrus Clouds, 7  
 Buckland (Miss), Rhabdomancy, 200  
 Buckley (A. B.), "History of Natural Science," 343  
 Buckton (C. M.), Health in the House, 384  
 Bulletin de l'Académie Royale des Sciences, 78  
 Bulletin International, 255, 256  
 Bulletin de la Société d'Anthropologie de Paris, 198  
 Bullfinches and Primroses, 427  
 Burchett's "Practical Plane Geometry," 223  
 Burton's Gorilla Land and the Congo, 123  
 Butter Case, the recent, 271, 287  
 Butterflies, Fossil, S. H. Scudder, 222  
 Calcutta, Botanical Garden, 117; Rainfall of, 436  
 Calico Printing, Crace-Calvert's, R. Meldola, 283  
 California, Academy of Sciences, 180  
 Caligraphy as a test of Character, 77  
 Cambridge University Board of Mathematical Studies, 434;  
 Clothworkers' Exhibitions, 316; Exhibitions at Christ's College, 113; Human Anatomy at, 151; Local Examinations, 95; Memorial from Members of, 474; Natural Science Club, 155; Natural Science Lectures at, 316; Natural Science Scholarships, &c., for 1876, 292; Philosophical Society, 40, 60, 160; Report of the Studies Syndicate, 414; Scholarships at Caius College, 256; Scholarships at Clare College, 155; Students at Dr. Dobrn's Zoological Station, 113; University Commission, 414; "Wort's Scholarships," 315  
 Camerarius and the Sexuality of Plants, 85  
 Cameron (Lieut.), Expedition in Africa, 154, 174, 202, 256, 273, 296, 315, 414, 530; his return from Africa, 436; Arrival at Liverpool, 456; at the Geographical Society, 473; and the French Geographical Society, 473  
 Campbell (J. F.), "My Circular Notes," 481  
 Canary Islands, Gaunch Population of, 335; the Volcanic Rocks of the, 403  
 Cardiff Naturalists' Society, 16  
 Cardiograph, a Modified, 471  
 Carnivorous Plants, the Absorptive Glands of, 36, 403  
 Carrington (R. C., F.R.S.), Death of, 134  
 Casella (L.), a New Compass, 135  
 Caspian Sea, the Fauna of the, 74  
 Castleton, Museum at, 335  
 "Catechism of Chemistry," 464  
 Caterpillars and Linen, 54  
 Cats, White, and Deafness, 495  
 Cave, Prehistoric, Discovery of, in France, 456  
*Ceratodus*, Prof. Huxley, F.R.S., on, 196  
*Chatopoda*, Ehlers on the, 75  
*Challenger* Expedition, 70, 76, 216, 272, 413, 435, 457, 478;  
 Photography in the, Col. Stuart Wortley, 25; Reports, 250  
 "Chambers' Encyclopædia," 42  
 Channel Tunnel, W. Topley, 133  
 Chaumont (Dr. F. de), Dr. Richardson's Hygeia, 25  
 "Chemical Analysis," Prof. Dittmar's, 507  
 Chemical Society, 39, 79, 118, 158, 258, 298, 339, 399, 418, 499, 534; Journal of, 78, 176, 277, 378; Research Fund for the, Dr. W. J. Russell, F.R.S., 461; Visit to the Royal Arsenal, 395  
 Chemistry, Catechism of, 464; Dammer's Dictionary of, 483;  
 Dr. Youmans' Class-book of, 424  
 Chemistry of the Non-metallic Elements, Procter, 446  
 Cherry Blossoms destroyed by Squirrels, F. H. Storer, 26  
 Cherry Laurel, Glands of the, 107, 150  
 Chicago Botanical Garden, 357  
 Children, Science teaching to, 48  
 China, Tufted Deer of, 334  
 Chinese Miners in Victoria, 256  
 Chisholm (H. W.), International Metric Commission at Paris, 452  
 Chloride of Silver Batteries, W. De la Rue, F.R.S., 277  
 Chlorides, Prof. T. E. Thorpe on the Specific Volumes of Inorganic, 397  
 Cholera and Meteorology, 340  
 Christy and Lartet, "Reliquiæ Aquitanicæ," 401  
 Chronoscope, a new form of, 139  
 Cinchona in India, 196  
 Circle, the Secret of the, Alick Carrick, 323  
 "Circular Notes," J. F. Campbell, 481  
 Cirrus Cloud, Forms for Observing, 7  
 Citric and Tartaric Acids, 78  
 City Companies, Mr. Gladstone on the, 42  
 Clifton College Scientific Society, 236  
 Climatic Characteristics of Winds as dependent on their Origin, 520  
 Climbing Plants, Darwin on, 65  
 "Close Time" for Indigenous Animals, 315  
 "Clouds in the East," Valentine Baker, 484  
 Clouds, Genesis of, 107  
 Clover and Bees, Thomas Belt, 26



- Cobbold (Dr. T. S., F.R.S.), Sutton's Report on Trichinosis, 105; Van Beneden's "Animal Parasites," 303  
 Coffee, Cultivation of, in India, 175; in Dominica, 38, 187  
 Coggia's Comet, 151  
 Collomia, Dr. Asa Gray, 85  
 Colorado, Map of, 414  
 Colour in Flowers, 150, 129, 348, 366, 427, 465  
 Coloured Solar Halos, 466  
 Comets, 486; of 1729, 129; Coggia's, 151; of 1702, 168; Encke's, 188; of 1874 and 1680, 208; Olbers' of 1815, 348; Biela's, 368; of 1840, 386; D'Arrest's, 428; A Southern (?), 449  
 Compass, Mr. Casella's New, 135  
 Compressed Air Locomotives, 489  
 Compulsory Education, Dr. Lyon Playfair on, 35  
 Condensed Air Tramways, 228  
 "Congo and Gorilla Land," R. F. Burton's, 123  
 Congo, the River, Monteiro's Angola and, 161  
 Conia, Properties of, 300  
 Conic Sections, W. H. Besant's, 24  
 Continued Fractions, Early History of, Thomas Muir, 448  
 Cook (A. J.), "Injurious Insects of Michigan," 424  
 Cooke (Josiah P.), "Scientific Culture," 284  
 Copenhagen, Meteorology of, 197  
 Coral Sand, the Formation of, 510  
 Corn, Sunspots and the Price of, 15  
 Cornu (M.), Experiments on Light, 112  
 "Cosmos," 114, 155, 530  
 Costerus (J. C.), Seasonal Order of Colour in Flowers, 427  
 Crab, H. Woodward, F.R.S., on a New Fossil, 58  
 Creation, Prof. Haeckel's History of, 121  
 Creswell Crags, Bone-Caves of the, 534  
 Croll (James), Oceanic Circulation, 66  
 Crookes (W., F.R.S.), Award of Royal Society Medal to, 34; Radiometers, 458, 489; Repulsion and Radiation, 391, 450  
 Crova (M.), Apparatus for Demonstrating the Transformation of Force, 434  
 Crystal Palace School of Engineering, 36  
 Cuckoo, First Heard, 475  
 Cumming (Linnæus), Physical Science in Schools, 330  
 Curley (E. A.), Nebraska, 7  
 Curve-Tracing, Works on, 483  
 Cyclometers and other Paradoxes, Part II., 28  
 Cyclones, 386; in Mauritius, 456  
 D'Alberty (Sig.), Discoveries in New Guinea, 154, 435  
 Dall (W. H.), Mountains of Alaska, 53  
 Damman's Race-Photographs, E. B. Tylor, F.R.S., 184  
 Dammer (Dr.), "Kurzes Chemisches Handwörterbuch," 483  
 D'Arrest's Comet, 428  
 Darwin (C., F.R.S.), on Climbing Plants, 65; Theory of Pangenesis, 333  
 Darwin (Francis), Vivisection, 385  
 Dasent (Rev. M.), Migration of Species, 367  
 Davenport (S. T.), Death of, 216  
 Davis Straits, New Harbour near, 54  
 Dawkins (Prof. Boyd, F.R.S.), Plagiarism of Map, 7, 26  
 Day (Francis), Collection of Indian Fishes, 334  
 Deep-sea Telegraphs: How they are Tested, 517  
 Deer, the Tufted, of China, 334  
 De la Rue (W., F.R.S.), Chloride of Silver Batteries, 277  
 Denning (W. F.), Large Meteors, 287; Meteor in the Daytime, 207  
 Derby (Lord) on the Endowment of Scientific Research, 141  
 Der Naturforscher, 533  
 Deutsche Seewarte, 375  
 Devon and Cornwall, the Drift of, 58  
 Diagrams, Agricultural, 36  
 Diarrhœa, Registrar-General on Infantile, 35; Report on the Epidemic of, in Leicester, 273  
 Didot (M.), Death of, 358  
 "Difference Engine, the," 215  
*Dimocrata*, Prof. Marsh on the, 374  
 Dinosaurian Vertebra, Prof. R. Owen, F.R.S., 99  
 "Discoveries and Inventions of the Nineteenth Century," by R. Routledge, F.C.S., 45  
 "Diseases of Modern Life," Dr. Richardson's, 508  
 Dittmar (Prof. W.), "Qualitative Chemical Analysis," 507  
 Dixon (W. Hepworth), "White Conquest," 23  
 D-line Spectra, Major W. A. Ross, 366; Prof. G. G. Stokes, F.R.S., 247  
 Dominica, Coffee in, 38, 187  
 Dodel (Arnold), "Die Neuere Schöpfungsgeschichte," 265  
 Dog, a Criminal, R. S. Culley, 66; Retriever, and Cat, 36  
 Dohrn (Dr.), Cambridge Students at his Zoological Station, 113  
 Donati, Proposed Monument to, 455  
 Donkey, a Relapsed, Prof. E. Bonavia, 486  
 Double Stars, 449; Rugby Catalogue of, 287  
 Drasche (Dr.), on the Philippine Islands, 435  
 Dresden, the, "Gorilla," Dr. A. B. Meyer, 106  
 Dresden Zoological Museum, 464  
 Drinking Water, Organic Impurities of, Prof. Frankland, F.R.S., 330  
 Dublin, Professorships at Trinity College, 15; Royal Irish Academy, 100; Scientific Societies, 470; Duncan (Prof. P. Martin, F.R.S.), the Animal of Millepora, 465  
 Dundee Free Library, Report of, 175  
 Dunraven (Earl of), "The Great Divide," 264  
 "Dyeing and Calico Printing," Dr. F. Crace-Calvert; R. Meldola, 283  
 Dyer (Prof. W. T.), Seasonal Order of Colour in Flowers, 348  
 Earth, J. Willis on the Internal Heat of the, 8  
 Earthquakes, in Algiers, 135, 457; in Algeria, 274, 375; at Berne, 475; in Bombay, 135; at Gisborne, New Zealand, 95; at Lyons, 114; in North Carolina, 94; Porto Rico, 155; in Peru, 274; in United States, 236  
 Earth's Age, Prof. Tait on the, 486  
 Earth's Magnetism and the Sun's rotation, 466  
 Earth's Magnetism, Effects of the Sun's Rotation and the Moon's Revolution on the, J. Allan Broun, F.R.S., 328  
 East Anglia, Physical Geography of, during the Glacial Period, 198  
 Eastbourne, Natural History Society, 155  
 Easter, to find, 487  
 Easter Sunday, date of, 315, 326  
 Ecker (Dr. A.), on the Character of the Hand, 8  
 Eclipse, the Late, Dr. A. Schuster, 86, 207  
 Eclipses, Solar, of 1605, 108; Solar, of 1999, 169; Solar, of March 25, 1876, 248; Total Solar, of 1876, 268; Solar, of 1706, 307; Solar, of 1883, 406  
 Eden (Chas. H.), Australian Heroes, 323  
 Edinburgh, Royal Observatory at, 45; Royal Society, 77, 340; Scottish Meteorological Society, 100  
 Education, Dr. Lyon Playfair on Compulsory, 35; in Holland, 528; Science in, 48  
 Eels, Tenacity of Life in, 531  
 Egypt and the Nile, 43  
 Ehlers on the *Chaetopoda*, 75  
 Electric Lamps, 414  
 Electrical Appliances, Exhibition of, in Paris, 54  
 Electrical Induction, Experimental Researches in, Prof. Volpi-celli, 437, 475  
 Electricity, the flow of, in a plate, 459; Lighting by, 256  
 Electro-Magnetic Rotation, Experiment on, W. Spottiswoode, F.R.S., 498  
 Electrodes, Polarisation of, 298  
 Ellery (Prof.), Meteorology of Australia, 196  
 Encke's Comet, 188  
 "Encyclopædia Britannica," vol. iii., Prof. A. H. Garrod, 221; the Article "Birds" in, Prof. A. H. Garrod, 266; Prof. Huxley, F.R.S., 247; Prof. Newton, F.R.S., 186  
 Endowment of Scientific Research, Lord Derby, 141  
 Engel's "Musical Instruments at South Kensington," 443  
 Entomological Society, 79, 140, 219, 340, 419, 536  
 Eosin, Action of, on the Photographic Spectrum, 255  
 Ericsson (Capt. J.), Thermal Energy and Radiation, 114; Thermal Energy from the Solar Surface, 224  
 Ericsson's Researches on the Sun, P. A. Secchi, 46  
 Eskimo, Dr. Rink's Tales and Traditions of, 103  
*Eucalyptus Globulus*, 117  
 "Euclid Simplified," J. R. Morell's, 202, 405, 427  
 Evans (J., F.R.S.), Anniversary Address at the Geological Society, 354, 376; Water Supply of the Metropolis, 425  
 Everett (Prof. J. D.), Prof. Tait on the Earth's Age, 486  
 Evers (Dr. H.), "Mathematical Tables," 494  
 Examinations, School, and the University of London, 286  
 Exhibition of Scientific Apparatus at South Kensington, 36, 196, 231, 274, 295, 315, 349, 375, 413, 503

- Fatigue, the Law of, Dr. S. Haughton, F.R.S., 98  
 Faye on the Laws of Storms, 11, 87, 187  
 Fertilisation of Flowers by Insects, Hermann Müller, XII., 210; XIII., 289  
 Fertilisation, Plant, 427  
 "Fifteen Young Ladies Problem," 57  
 Finsch (Dr. Otto), Birds of the Pelew Islands, 152  
 Fire-Damp, Explosions from, E. W. Binney, F.R.S., 219  
 Firework Paper, Japanese, 236  
 Fish, Exhibition of, in United States, 217  
 Fish, Rapid Growth of, Robert U. S. Mitchell, 107  
 Fish-pigment, Spectrum of, 167  
 Fisheries of Norfolk, Report on, 114  
 Fishes of India, Mr. F. Day's Collection, 334  
 Fishes, Prof. Van Siebold's work on Freshwater, 366  
 Flame of Common Salt, T. N. Müller, 448  
 Flight of Birds, 324  
 Flint Skin-scrapers from New Jersey, Dr. Charles C. Abbott, 270  
 Floods in France, 197; in Somersetshire, 155  
 Flower (Prof., F.R.S.), a New Cetacean from New Zealand, 149; the Relation of Extinct to Existing Mammalia, 296, 307, 327, 350, 387, 409, 449, 487, 513; the Uintatherium, 404  
 Flowering of Spring Plants, Alex. Buchan, 249  
 Flowers and Bees, Dr. Müller, 10  
 Flowers, Colour of, Grown in the Dark, H. C. Sorby, F.R.S., 465  
 Flowers, Fertilisation of, by Insects, H. Müller, XII., 210, XIII., 289  
 Flowers, Seasonal Order of Colour in, 129, 150, 326, 348, 366, 427  
*Foehn* Storms in Switzerland, 218, 440  
 Food, Dr. Hassall's work on, 345, 396  
 Forbes (Prof. George), Notes from Siberia, 469  
 Force, M. Crova's Apparatus for Demonstrating the Transformation of, 434  
 Forestry, C. F. Amery's Notes on, 6  
 Forrest (J.), Explorations in Australia, 83  
 Forster (W. E., M. P.), on Science, 456  
 "Fossil Butterflies," S. H. Scudder, 222  
 Fossil Flora of North America, 95  
 Fossil Horse of Buenos Ayres, Dr. Burmeister on, 53  
 Fossil Skeletons of Le Puy en Velay, 207  
 Foster (Prof. G. C.), a New Form of Chronoscope, 139  
 Fractions, Estimation of, 127  
 France: Ancient Glacial Action in, 67, 404, 425; Floods in, 197; Geographical Society, 77, 174, 357, 473; Geographical Society's Bulletin, 16, 207; Glaciers in Central, 149, 166; Dr. J. D. Hooker on Glaciers in; Maps at Railways, 77; Meteorology in, 356; Meteorology Stations in, 336; New Maps of, 335; National Library, 77; G. Poulett Scrope, F.R.S., on Glaciers in, 149, 166; Physical Society, 280; Society of Aerial Navigation, 113; *see also* Paris  
 Francis (George), Spectrum of Fish-pigment, 167  
 Frankland (Dr. E., F.R.S.), Coloured Solar Halos, 404; how Typhoid Fever is Spread, 447; Organic Impurities of Drinking Water, 330; Water Supply of the Metropolis, 392  
 French Experimental Physiology, 44, 182  
 Freshwater Fishes of England, Prof. Van Siebold's Work on, 366  
 Friction between Water and Air, Dr. Ritter von Lang on, 533  
 "From Vineyard to Decanter," 217  
 Frost (Percival) "Treatise on Curve Tracing," 483  
 Froude (Wm., F.R.S.), "Stream Lines" in Relation to the Resistance of Ships, 50, 89, 111, 130, 169  
 Fungus and House-fly, 168  
 Fusinieri, the Discoveries of, G. Nardi, 111  
 Gabb (Dr. W. M.), Exploration of Costa Rica, 257  
 Galabin (Dr. A. L.), Modified Cardiograph, 471  
 Gallium, on some Properties of, 136  
 Galton (F., F.R.S.), Heredity, 59  
 Galton (J. C.), a New Palmistry, 8, 47, 68, 87; Protective Resemblance in the Sloths, 187  
 Galvanic Currents, the, 452  
 Galvanometer, a New, 379  
 Gamond (M. Thomé de), death of, 335  
 Garrod (Prof. A. H.), "Encyclopædia Britannica," vol. iii., 221; the Article "Birds" in "Encyclopædia Britannica," 226  
 Gautier (Col.), Meteorology in Labrador, 60  
 "Gegenschein" of the Zodiacal Light, 129  
 Geikie (Prof. A., F.R.S.), American Surveys, 1; Old Red Sandstone, 389  
 Geissler Tubes and Aurora Borealis, 237; the Spectrum of Nitrogen and that of Alkaline Metals in, 314  
 Geneva: International Medical Congress at, 77; Physical and Natural History Society, 60, 120, 280, 400  
 Geographical Magazine, 114, 297, 376  
 Geographical Society, 52, 93, 134, 256, 315, 357, 397, 473  
 Geographical Society of France, 155, 174, 357; Bulletin, 297  
 Geographical Society of Italy, 136  
 Geographical Zoology, P. L. Sclater, F.R.S., 482  
 Geological Map of Australia, 352  
 Geological Record for 1874; W. Whitaker, 322  
 Geological Sketches; L. Agassiz, 383  
 Geological Society, 57, 99, 139, 198, 238, 278, 339, 358, 379, 439, 479, 534; Anniversary Address, 354, 376; Medal of, 295; New Museum of, 227  
 Geological Society, Vienna, 220, 319  
 Geological Survey of the United States, 156, 314  
 Geological Time, Prof. McKenny Hughes on, 435  
 "Geologie der Kohlenlager," Dr. H. Mietzsch, 166  
 Geologists' Association, 159, 258, 318, 459  
 Geology, Abyssinian, 137; American Geological Surveys by Prof. A. Geikie, 1; Survey of United States, 356; U. S. Survey Publications, 385  
 "Geology for Students," Prof. A. H. Green's, 505  
 Geometry, Burchett's Practical Plane, 223; French Works on, 509; the New, 102  
 Germany: Association of Natural Philosophers, &c., 32; German Chemical Society, 80, 119, 178, 289, 319, 360; Commission on Arctic Exploration, 34, 73; Germany and the Loan Exhibition of Scientific Apparatus, 470; German North Sea Commission, 125; Science in, 10, 30, 75, 112, 250, 452, 521; Scientific and Medical Association, 56  
 Germs, Prof. Tyndall on, 252, 268, 324, 347; Dr. H. Charlton Bastian, F.R.S., 284, 285  
 Gerst (R.), Physical Science in Schools, 430  
 Glacial Action in Central France, W. S. Symonds, 67  
 Glacial Coal-beds of Switzerland, Traces of Man in, 130  
 Glacial Period, Physical Geography of East Anglia during the, 198  
 Glaciers, in California, 180; Evidence of, in Central France, 31, 149, 166, 404, 425  
 Gladstone (Mr.), at Greenwich, 41  
 Gladstone (Dr. J. H., F.R.S.), on the Replacement of Electro-positive by Electro-negative Metals in a Voltaic Cell, 118  
 Glands of the Cherry Laurel, G. S. Boulger, 107  
 Glover (J. P.), Australian Implement, 27  
 Glow-worm in Scotland, 188, 208  
 Godwin-Austen (H. H.), Dr. Stoliczka's Collection of Mammals, 106, 109  
 Gold Coast, M. Bonnat's Exploration of, 94  
 Goodenough (Commodore), Memoir of, C. R. Markham, 185  
 Gore (G., F.R.S.), Bar Magnets and Conducting Wires, 176  
 "Gorilla Land and the Congo," R. F. Burton, 123  
 Gorilla, the Dresden, Dr. A. B. Meyer, 106  
 Gould's "Birds of New Guinea," 15  
 Gould (John, F.R.S.), "A Monograph of the Trogonidæ," 166  
 Granitic Rocks of the Lake District, 139  
 Gratz, German Association at, 32  
 Gray (Dr. Asa), Collomia, 85  
 "Great Divide, the," Earl of Dunraven, 264  
 Green (Prof. A. H.), "Geology for Students and General Readers," 505  
 Greenland, Dr. Rink on, 103  
 "Greenstones" of Cornwall, 379  
 Gresham College, 273  
 Grieve (G. J. P.), Further Linkage Work, 69  
 Grimm (Oscar), Fauna of the Caspian Sea, 74  
 Grohman (W. A. B.), Tyrol and the Tyrolese, 206  
 Guillemin's "Le Ciel," 494  
 Gum Arabic, 117  
 Guthrie (Prof.), Stationary Liquid Waves, 99; "Magnetism and Electricity," 261  
 Hadden (A.), a New Galvanometer, 379  
 Haeckel (Prof.), "History of Creation," 121; on Universities, 135

- Hæmoglobin, H. C. Sorby, F.R.S., on the Evolution of, 306  
Halos, Coloured Solar, 404, 426, 466, 512  
Hamburg Naval Observatory, 217  
Hanbury (Daniel), Proposed Memorial to, 455  
*Harpypopsis Nova Guinea*, 134  
Harris (G. L.L.D.), Caligraphy as a Test of Character, 77  
Hartley (W. N.), Physical Science in Schools, 413; "Air and its Relation to Life," 243  
"Haskell Portfolio," 175  
Hassall (Dr.), "On Food," 345, 396  
Hastings, Science in, 217, 267, 306  
Haughton (Dr. S., F.R.S.), the Law of Fatigue, 98  
Havana, Meteorological Observations at, 224  
Hayden (Prof.), Bulletin of the Survey of the United States, 414; Geological Survey of the United States, 1, 156, 314  
"Health in the House," C. M. Buckton, 384  
Heat of the Earth, J. Willis on the Internal, 8  
Hector (Dr., F.R.S.), Geology of New Zealand, 258  
Hemiptera, List of American, 376  
Henry (Prof.), Smithsonian Report for 1874, 94  
Hensley's Scholar's Algebra, 304  
Henslow (Rev. George), Physical Science in Schools, 493  
Hentz (N. M., M.D.), Archæological Writings of, 281  
Hepaticæ, Irish, 38  
Hermann (Prof. D. L.), "Human Physiology," 22  
Herring, the Migration of the, 100; Report of the Scotch Fishery Board on, 35  
Herschel (Caroline), Memoir of, 361  
Herwart's Multiplication Table, 40  
Heuglin (Baron Th. von), Birds of North-Eastern Africa, 289  
Hicks (George), Mechanical Action of Light, 347  
Higgins (Rev. H. H.), the Boomerang, 168; Voyage to West Indies, 174  
Himalayas, the Eastern, 246  
Himalayas, Scientific Notes taken in the, Dr. A. Schuster, 393  
Himalayas, A. Wilson's Journey in the Western, 4  
Hinrichliff (T. W.), "Over the Sea and Far Away," 509  
Hinrichs (Dr. Gustavus), Meteor in Iowa, 113  
"History of Creation," Prof. Hæckel's, 121  
Hoffmeyer's Synoptic Weather Charts, 85  
Hofmann (Prof., F.R.S.), Award of Royal Society Medal to, 34; Elected Associate of the Italian Society of Science, 235  
Holland, Middle-Class Education in, 528  
Holten (Prof. C.), Meteorological Tables, 197  
Honolulu, Microscopic Club at, 256  
Hooker (Dr. J. D., P.R.S.), Ancient Glaciers in France, 31  
Hopkins University, U.S., 412  
Horrocks (Jeremiah), Memorial of, 112  
Horses, Case of Intelligence in, 36  
Horticultural Exhibition at Amsterdam, 135  
Horticulture in Belgium, 95  
Houghton (Rev. W.), "Sketches of British Insects," 365  
House-fly and Fungus, 168  
Hubrecht (Dr. A. A. W.), Exploration of Sumatra, 209  
Huddersfield Naturalists' Society, 136  
Hughes (Prof. McKenny), Geological Time, 435  
"Human Physiology," Dr. Hermann's, 22  
Hunterian Lectures, Prof. Flower's, 307, 327, 350, 387, 409, 449, 487, 513  
Hurricane in Manila, 175  
Hutchinson (T. N.), Physical Science in Schools, 353; radiometers, 324  
Hutchinson (T. J.), Summer Holidays in Brittany, 465  
Huxley (Prof., F.R.S.), the Article "Birds" in the "Encyclopædia Britannica," 247; on *Ceratodus*, 196; Geological Society's Wollaston Medal, 295; Origin of Vertebrate Animals, 388, 410, 429, 467, 514  
Hygeia, Dr. Richardson's, 25  
Hymenopterous Insects, Ocelli of, Dr. Hermann Müller, 167  
Hyperion, the Saturnian Satellite, 326  
Ice Machine, Raoul Pictet's Sulphurous Acid, 432  
Iceland, Volcanic Eruptions in, 135; Meteorology in, 493  
India, Cultivation of Coffee and Tea in, 175  
India, Maps of, 54, 95, 413  
"Indian Alps and how we crossed them," by a Lady Pioneer, 246  
Indian Fishes, Mr. F. Day's Collection, 334  
Indiana and Kentucky, Archæological Researches in, 109  
Industrial Applications of Oxygen, 293, 336  
Ingleby (Dr. C. M.), Floating Radiometers, 511  
Insects, Houghton's Sketches of British, 365; the Ocelli in, 406  
Insects of Michigan, A. J. Cook's Injurious, 424  
Institute of Civil Engineers, 279, 319, 340, 358, 399, 440  
International Bulletin, 273  
International Medical Congress, 77  
International Metric Commission in Paris, H. W. Chisholm, 452  
Inundations in France, 197  
"Inventions and Discoveries of the Nineteenth Century," by R. Routledge, 45  
Iowa, Meteor in, 113; Physical Observatory at, 316; Iowa Weather Report, 197, 316  
Ireland, Science and Art in, 309, 349, 370  
Ireland, Science Commission Report on the Queen's Colleges, 22  
Irish Academy, 100, 255, 297, 414  
Irish Hepaticæ, 38  
Iron and Steel Institute, 77  
Italian Expedition to Africa, 77, 155  
Italy, Geographical Society, 136, 375; Meteorological Congress, 356; Meteorology of, 436; Science in, 110  
Jackson (J. R.), Laslett's "Timber and Timber Trees," 181  
Jahrbuch der k. k. Geologischen Reichsanstalt, 176  
Jahrbucher für Wissenschaftliche Botanik, 156, 533  
Japanese "Firework Paper," 236  
Jenesei, Prof. Nordenskjöld on the, 95, 275, 312  
Jenkins (B. G.), Extraordinary Tides, 69  
Jersey, Subsidence of Parts of, 238  
Jevons (Prof. S., F.R.S.), Sunspots and the Price of Corn, 15  
Johnston's (W. and A. K.) Map of India, 54  
Jones (Prof. Rupert, F.R.S.) on Quartz and other Forms of Silica, 159  
Journal of Anatomy and Physiology, 237, 532  
Journal of Botany, 155  
Journal of the Chemical Society, 78, 176, 277, 378, 477  
Journal Géographique Internationale, 376  
Journal d'Hygiene, 255  
Journal of Mental Science, 196  
Journal de Physique, 157, 237, 418  
Jungken (Prof.), Scientific Collections of, 155  
Jupiter's Satellites, 288  
Kansas City, U.S., Academy of Science at, 493  
Kent (Saville) appointed to Yarmouth Aquarium, 77; Guide-book to the Manchester Aquarium, 85  
Kent's Cave, Eleventh Report of Committee for Exploring, 17  
Kentucky and Indiana, Archæological Researches in, 109  
Kerner (Prof.), on the Auricula, 94; Hybrid Primulacæ of the Alps, 113  
Kesslerloch, Merk's Excavations at the, 401  
Kiddle (Capt. W. W.), the Effect of Waves, 108  
Kingdoms of Nature, the Three, 367, 386  
Kjellman (Dr. F. R.), Swedish Arctic Expedition, 116  
Klein (E., F.R.S.), Small-pox of Sheep, 467  
*Labyrinthodontia*, 479  
Lake District, the Granitic Rocks of, 139  
Lamont (James, F.G.S.), Yachting in the Arctic Seas, 264  
Lang (Dr. Rutter von) on the Friction between Water and Air, 533  
Lange (Prof. F. A.), Death of, 94  
Lankester (E. Ray, F.R.S.), Dr. Bastian and Prof. Tyndall on Germs, 324; Prof. von Siebold's Fresh-water Fishes of England, 366; Translation of Hæckel's "History of Creation," 121  
Lartet and Christy, "Reliquiæ Aquitanicæ," 401  
Lasaulx (Prof. A. von), Ancient Glaciers in France, 404  
Laslett's "Timber and Timber Trees," J. R. Jackson, 181  
Lateau (Louise), the Case of, 95  
Law of Storms, Faye on the, 11, 87, 187; J. J. Murphy, 187  
Lawes (J. B., F.R.S.), his Experiments in Farming, 101  
Leared (Dr. A.), "Morocco and the Moors," 206  
Leeds, Science in, 527  
Leicester, Report on the Epidemic of Diarrhoea, 237  
Lesquereux (Leo.), Fossil Flora of North America, 95  
Letourneau's "Biologie," 404  
Leverrier (M.) at Astronomical Society, 314; on Weather Forecasts, 296  
Lichens, the True Nature of, Dr. Lauder Lindsay, 168, 247



- Light, Lommel's Nature of, 62  
 Light, Mechanical Action of, 347  
 "Light Mills," Dr. Geisler's, 479  
 Lightning-conductors, 357, 494  
 Lightning on Trees, Effects of, 120  
 Lindsay (Dr. W. Lauder), the True Nature of Lichens, 247  
 Linen and Caterpillars, 54  
 Linkages, 69  
 Linnæan Society, 39, 98, 112, 118, 134, 178, 298, 317, 359, 418, 458, 499; Transactions, 216  
 Lion, Remains of a British Species of, 396  
 Lippich (M.), the Luminiferous Ether, 494  
 Lisbon Academy of Science, 296  
 Lisbon Magnetic Observations, 301, 448  
 Liverpool Naturalists' Field Club, 16  
 Livingstone's African Expeditions, 197  
 Loan Exhibition of Scientific Apparatus, 36, 196, 231, 274, 295, 315, 349, 375, 413, 455, 470, 474, 503  
 Lockyer (J. Norman, F.R.S.), Recent Methods of Spectroscopy, 239  
 Locomotives, Compressed Air, 489  
 Lodge (O. J.), the Flow of Electricity in a Plate, 459  
 Lohse (Dr. O.), Bothkamp Sun Observations, 402  
 Lommel's "Nature of Light," 62; Optics, 87  
 Lorrain (Dr.), Death of, 16  
 Loudon's "Algebra for Beginners," 404  
 Lubbock (Sir J., F.R.S.), Bees, Wasps, and Ants, 37; on Ants, 359  
 Luminiferous Ether, the, 494
- Macleay's Expedition to New Guinea, 94, 153  
 M'Nab (Prof.) on *Penicillium glaucum*, 36; Pfeffer's "Periodic Movements of Leaf-organs," 24  
 Macrurus Crustacea, some new, 57  
 Madagascar, Dr. Harlaub's work on the Birds of, 272; Natural History, 308  
 Magnetic Observations at Lisbon, 301, 448  
 "Magnetism and Electricity," Dr. Guthrie's, 261  
 Magnetism, the Early History of, 523  
 Magnus (P.), School Examinations and the University of London, 286  
 "Maladies which are special to Mystics," 95  
 Mallett (R.), Prismatic Basalt, 7  
 Mammalia, Prof. Flower's Hunterian Lectures on the 307, 327, 350, 387, 409, 449, 487, 513  
 Mammals of Yarkand, 109  
 Man, Traces of, in the Glacial Coal-beds of Switzerland, 130  
 Manchester Aquarium, additions to, 77; Saville Kent's Guide-book to, 85; Literary and Philosophical Society, 118, 178, 219, 259, 399; Science Lectures, 82; Scientific Students' Association, 40  
 "Mandalay to Momiën," Dr. J. Anderson, 422  
 Manila, Hurricane in, 175  
 Maoris of New Zealand, 239  
 Map-drawing, C. Bird's Twelve Maps for, 7  
 Maps, at French Railway Stations, 77; of India, Catalogue of, 413; Stanford's Orographical, 396  
 Marey's "Physiologie Experimentale," 144, 182  
 Marine Algae of the United States, 38  
 Marine Aquariums, 208  
 Markham (C. R.), Memoir of Commodore Goodenough, 185  
 Marine Deposits, A. Tylor, 199  
 Mars, the Equator of, 449  
 Marsden's "Numismata Orientalia," Part II., 302  
 Marsh (Prof. O. C.) on the Dinoceratæ, 374  
 Mason (Sir Josiah), College at Birmingham, 174  
 "Mass" and "Weight," the Use of the Words, 325, 385, 405, 446, 466, 484  
 Matches, Safety, 208, 469, 512  
 Mathematical Science, C. Pine's Further Researches in, 6  
 Mathematical Society, 57, 138, 238, 317, 399, 534  
 Mathematical Tables, Dr. H. Evers, 494  
 Maxwell (Prof. Clerk, F.R.S.), Tait's "Recent Advances in Physical Science," 461  
 Mayo (Earl of), Sport in Abyssinia, 384  
 Mechanical Action of Light, 347  
 Medical, International, Congress, 77  
 Medusæ, Abnormal Multiplication and Abortion of Parts in, G. J. Romanes, 496
- Melbourne, The Observatory, 173; Rocks and Minerals in the Museum at, 165  
 Melde (Dr. Franz), Theorie und Praxis der Astronomischen Zeitbestimmung, 88  
 Meldola (R.), Crace-Calver's Dyeing and Calico-printing, 283; Tissandier's Photography, 204  
 Memorie della Società degli Spettroscopisti Italiani, 137, 497  
 Mercury, the Visibility of, 427  
 Merk (Conrad), Excavations at the Kesslerloch, 401  
 Metachromism, 298, 347, 385, 426, 467  
 Meteors, 113, 187, 207, 287, 467  
 Meteorolite at Wolverhampton, 531  
 Meteorological Congress at Poitiers, 94  
 Meteorological Society, 79, 158, 279, 340, 440, 536; Journal of the, 436, 531  
 Meteorological Society of Paris, 196  
 Meteorological Society of Scotland, 100, 135  
 Meteorological Stations in France, 336  
 Meteorology, Algerian, 217; Atlas Météorologique de l'Observatoire de Paris, 375; in Baden, 25; of Bengal, W. G. Willson, 66; Bulletin of the Pyrénées-Orientales, 113; Charts of the United States, 53; Congress in Italy, 356; Congress at Poitiers, 35; of Copenhagen, 197; in France, 356; at Havana, 224; Dr. Hellmann on Atmospheric Strata, 137; Hoffmeyer's Synoptic Weather Charts, 85; in Iceland, 493; in India, 340; Italian, 436; Italian Commission, 234; M. Leverrier on Weather Forecasts, 296; New Office of, in Paris, 54; of Norway, 154; "Notizblatt der Vereins," 136; Observatories, 413; Poitiers Congress, 77; in the Pyrenees, 135; the Rainfall of India, 86; Weather Maps of the U.S., 95; Weather Reports of the U.S., 397  
 Metric Commission at Paris, H. W. Chisholm, 452  
 Mexico, New, Lieut. Wheeler's Expedition to, 76  
 Meyer (Dr. A. B.), the Dresden "Gorilla," 106; Saw-fish inhabiting Fresh Water, 167  
 Michelet (Jules), "The Sea," 106  
 Michigan, A. J. Cook's Injurious Insects of, 424  
 Michigan State Medical Society, Transactions of, 35  
 Microscope and Molecules of Matter, Relation between, H. C. Sorby, F.R.S., 332  
 Microscopical Science, Quarterly Journal of, 257  
 Microscopical Society, 39, 118, 159, 219, 299, 384, 399, 499  
 Microscopy, American Journal of, 297  
 Middle-class Education in Holland, 528  
 Mietzsch (Dr. H.), "Geologie der Kohlenlager," 166  
 Migration of Species, Rev. M. Dasent, 367  
 Millepora, the Animal of, Prof. Martin Duncan, F.R.S., 465  
 Miller (Mrs. Hugh), Death of, 414  
 Millington (Sir Thomas) and the Sexuality of Plants, 85, 127, 166, 185  
 Miniature Physical Geography, 310  
 "Mind," 477  
 Mineralogical Society, 274, 357  
 Minerals, Collection of, in United States, 77  
 Minerals of New South Wales, 382  
 Minor Planets, 27, 47, 69, 87, 109, 150, 208, 227, 268, 307, 326, 349, 407, 513  
 Mirage in Upper Thibet, 67  
 Misti and its Cloud, A. Agassiz, 107  
 Mitchell (R. U. S.), Observations on Fish, 107  
 Moa Bones, Discovery of, in New Zealand, 273  
 Mohn (Prof.), Meteorology of Norway, 154  
 Mohr (E.), "Victoria Falls of Zambesi," 384  
 Molecules of Matter and Microscope, Relation between, H. C. Sorby, F.R.S., 332  
 Molluscs, Freshwater and Land, Prof. Nordenskjöld, 284  
 Momiën and Mandalay, Dr. Anderson's Work on, 422  
 Mont Blanc, Ascent of, by a Lady, 315, 336; Temperature on, 296  
 Monteiro (J. J.), "Angola and the River Congo," 161  
 Montsouris Physical Observatory, 217, 255  
 Morell's "Euclid Simplified," 202, 405, 427  
 Moresby (Capt. J.), "New Guinea and Polynesia," 235, 363  
 Morocco and the Moors, Dr. A. Leared, 206  
 Morphologisches Jahrbuch, 20, 176  
 Mosso (Dr.), *Flethysmograph*, 336  
 Mott (F. T.), a New Palmistry, 68  
 Muir (Thomas), Early History of Continued Fractions, 448  
 Muir (M. M. Pattison), Routledge's "Discoveries and Inventions," 45; Dr. Youman's "Class-book of Chemistry," 424

- Müller (Dr. Hermann), Bees and Flowers, 10; Fertilisation of Flowers by Insects, XII., 210; XIII., 289; Ocelli of Hymenopterous Insects, 167
- Müller (Fritz), Brazil Kitchen Middens, Habits of Ants, 304
- Müller (J. J.), the Luminiferous Ether, 494
- Müller (Prof. Max) at Oxford, 112, 335
- Müller (T. N.), Flame of Common Salt, 448
- Munro (J.), the Formation of Coral Sand, 510
- Murphy (J. J.), Law of Storms, 187; Physical Constitution of Steam, 466
- Musical Instruments at South Kensington, 443
- Musical Intervals, Dr. Wm. Pole's Method of representing, 116
- Musical Pipes, Hermann Smith on, 511
- Music, Beats in, Dr. Wm. Pole, F.R.S., 212, 232
- Nachtigal (Dr.), Medal awarded to, 456
- Naples, Cambridge Students at the Zoological Station, 113
- Nardi (Sig. G.), the Discoveries of Fusinieri, 111
- Natural Science, Miss Buckley's History of, 343
- Naturforscher, Der, 97, 198, 317
- Nebraska, E. A. Curley on, 7
- Neesen (Herr) on Mr. Crookes' Radiometer, 10
- Nesbit (H. A.), University of London and School Examinations, 286
- New Guinea, Baxter River, 76, 134; Beccari's Exploration of, 356; Botany of, 316; Capt. Moresby work on, 235, 363; D'Albertis' Discoveries in, 154, 435; Discovery of a New Rapacious Bird in, 134; Interior of, 397; Rev. S. Macfarlane's Travels in, 415; Macleay's Expedition to, 94; Voyage of the *Chavert* to, 153
- "New Guinea and Polynesia," Capt. J. Moresby, 363
- New Mexico, Lieut. Wheeler's Expedition to, 76
- New South Wales, Minerals of, 382; Royal Society of, 78
- New York Lyceum, change of name of, 531
- New Zealand, Discovery of Moa Bones, 273; Dr. Hector, F.R.S., on the Geology of, 258; Inquest on a Skeleton, 196; Prof. Flower, F.R.S., on a New Cetacean from, 149; Salmon in, 256, 257; Volcanoes in, 135; Wellington Philosophical Society, 179
- Newton (Prof. A., F.R.S.), Article "Birds" in "Encyclopædia Britannica," 186; Birds as Astronomical Objects, 447
- Nile, the, Mr. A. Southworth's Journey up the, 43
- Nitrogen, Spectrum of, and that of Alkaline Metals in Geissler Tubes, 314
- Non-Metallic Elements, Chemistry of the, Dr. Procter, 446
- Nordenskjöld (Prof.), on the Jenisei, 95, 275, 312
- Norfolk, the Fisheries of, 114
- Norfolk Naturalists' Society, 156
- North America, Fossil Flora of, 95
- North and Baltic Sea, Report on, 53
- North Carolina Earthquakes, 94
- North Sea Commission, the German, 125
- Norway, Meteorology of, 154
- Numerals, J. Allan Broun, F.R.S., on the Origin of, 47
- "Numismata Orientalia," Marsden's, 302
- Obi Expedition, 315, 368
- Observatories: Brussels, 254; Cincinnati, 357; Melbourne, 173; Paris, 229, 493; Pawlowsk, 97; Vienna, 192; at Iowa, 316; Montsouris, 255; Puy de Dôme, 273; on Pic du Midi, 251
- "Observer of Nature," 531
- Oceanic Circulation, James Coll, 66
- Ocelli of Hymenopterous Insects, Dr. Hermann Müller, 167, 406
- Oldham (Dr. Thomas, F.R.S.), award of Royal Society Medal to, 34
- Old Red Sandstone, Prof. Geikie, F.R.S., 389
- Oppenheim (Dr. A.), Association of German Natural Philosophers &c., 32; German Scientific and Medical Association, 56; Industrial Applications of Oxygen, 293, 336
- Optical Barometer, Proposed, J. Stevenson, 150
- Ordnance Survey, 197
- Orientalists, Meeting of, in St. Petersburg, 76
- Ornithological Collection, H. Seebohm's, 14
- Ornithosauria, Prof. H. G. Seeley on, 98
- "Over the Sea and Far Away," Hinchliff's, 509
- Owen (Prof. R., F.R.S.), Dinosaurian Vertebræ, 99; Evidences of a Carnivorous Reptile, 339; on *Prorastomus Sorenooides*, 114
- Oxford Botanic Garden, 61, 94, 315; Johnson Memorial Prize, 256; Observatory, Visitors of, 54; Scholarships at Balliol College, 37; Science Lectures, 376; University Commission, 112, 434
- Oxygen, the Industrial Applications of, 293, 336
- Palmistry, a New, 47, 68, 87
- "Pandora" Expedition, 457
- Pangenesis, Darwin's Theory of, 333
- Papuans, Poisoned Arrows of, 235
- Paris Academy, 20, 40, 60, 80, 100, 120, 140, 160, 175, 200, 220, 240, 260, 280, 300, 320, 360, 379, 400, 420, 440, 460, 480, 500, 530; Award of Prizes, 195; Physical Observatory, 235
- Paris, Electric Lighting in, 256; Exhibition of Electrical Appliances, 54; Geographical Society, 155; National Library, 77; Observatory, 229, 493; Public Instruction in, 375; Railway Exhibition, 135; Steam-engines on Tramways, 77
- Parker (Prof., F.R.S.) on Birds' Skulls, 178; Lectures at Royal College of Surgeons, 356; on the Woodpeckers and Wry-necks, 173
- Parkes (Dr.), Obituary Notice of, 435
- Paradoxes, among the Cyclometers and other, 28
- Pasteur (L.), Prof. Tyndall on Germs, 305
- Pawlowsk, Observatory at, 97
- Pelew Islands, Birds of the, 152
- Penicillium glaucum*, Prof. M'Nab on, 36
- Penikese School, U.S., 89
- Penning (W. H.), Physical Geography of East Anglia during the Glacial Period, 198
- Périgord, Archæology of, 401
- Periodic Movements of Leaf-organs, Dr. Pfeffer, 24
- Pesth, Water Supply of, 336
- Petermann's Mittheilungen, 16, 76, 236, 297, 396, 401, 530
- Petrie (W. M. Flinders), Estimation of Fractions, 127; Metachromism, 347, 426
- Pfeffer (Prof. W.), "Die Periodischen Bewegungen der Blattorgane," 24
- Pharmaceutical Conference, 136
- Philadelphia, Museum at, 77; Academy of Natural Sciences, 299
- Philippine Islands, 435
- Photographic Society, 255
- Photography in the *Challenger*, Col. Stuart Wortley, 25
- Photography of the Red End of the Spectrum, Capt. W. de W. Abney, 432
- Photography, Year Book of, 256; Photographic Almanac, 256
- Photometer, a New, by Prof. J. Reynolds, 478
- Physical Constitution of Steam, J. J. Murphy, 466
- Physical Geography, Miniature, 310
- Physical Observatories in France, 235; at Iowa, 316; Montsouris, 217; on the Pic du Midi, 251
- Physical Science in Schools, 329, 353, 371, 386, 412, 430, 454, 472, 491
- Physical Society, 59, 99, 139, 239, 298, 318, 379, 419, 459, 535
- Physical Society of France, 280
- Physiological Research, Proposed Society for, 455
- Physiology, Dr. Hermann's Human, 22
- Physiology, Recent French Experimental, 144, 182
- Pic du Midi, Physical Observatory on the, 251
- Pictet (M. Adolphe), Death of, 235
- Pictet (Raoul), Sulphurous Acid Ice Machine, 432
- Pine (C.), Researches in Mathematical Science, 6
- Pirrie's "Rigid Dynamics," 323
- Planets, the Minor, 27, 47, 69, 87, 109, 151, 208, 227, 268, 307, 326, 349, 407, 513
- Plant Fertilisation, 427
- Plants, Darwin on Climbing, 65; the Flowering of Spring, Alex. Buchan, 249; Sir Thos. Millington and the Sexuality of, 166, 185; Sexuality of, 85, 127
- Playfair (Dr. Lyon), on Compulsory Education, 35
- Plethysmograph*, Dr. Mosso's, 336
- Poggendorff's *Annalen der Physik und Chemie*, 38, 78, 317, 358, 497
- Poisoned Arrows of the Papuans, 235
- Poitiers Meteorological Congress, 77, 94
- Pole (Dr. Wm., F.R.S.), Beats in Music, 212, 232; Method of Representing Musical Intervals, 116
- Pollution of Rivers, Wm. Hope, 81
- Polynesia and New Guinea, Capt. Moresby on, 363

- Poncelet (General) *Eloge* on, 196  
 Porto Rico, Earthquake in, 155  
 Potato Disease, 459; Worthington G. Smith on, 524  
 Pouchet's "Universe," 77  
 Preece (W. H.), Bryant and May's Matches, 208  
 "Preece and Sivewright's Telegraphy," 441, 511  
 Prehistoric Cave, Discovery of, in France, 456  
 Primroses and Bullfinches, 427  
 Primulaceæ, Hybrid, of the Alps, 113  
 Pringsheim (Dr.), "Jahrbuch für Botanik," 156  
 Prismatic Basalt, 7, 47  
 Procter (W., M.D.), Chemistry of the Non-metallic Elements, 446  
 Proctor (R. A.), the Late Eclipse, 186  
 Procyon, Struve's Companion of, 406  
*Prorastomus sirenoides*, Prof. Owen, F.R.S., on, 114  
 Pryor (R. A.), a New Palmistry, 47; Seasonal Colour in Flowers, 150  
 Psychological Society, 77  
 Public Analysts., 242, 287  
 Puckle (Col. J.), the Rainfall,  
 Putnam's Archæological Researches in Kentucky and Indiana, 109
- Quarterly Journal of the Meteorological Society, 531  
 Quarterly Journal of Microscopical Science, 257  
 Queen's Colleges in Ireland, 22; Commission on, 530  
 Quetelet (Prof. E.), Statistics, Brussels, 296
- Radiation and Repulsion, W. Crookes, F.R.S., 391, 450  
 Radiation and Thermal Energy, Capt. J. Ericsson, 114  
 Radiometers, 10, 324, 366, 420, 458, 473, 489, 511  
 Railway Exhibition in Paris, 135  
 Railway Stations in France, Maps at, 77  
 Rainbow Projected on Blue Sky, 348  
 Rainfall in 1875, 70, 86  
 Rainfall on the Continent, Decrease of, 15  
 Rainfall of Sweden, 436  
 Ramsay (Prof., F.R.S.), Anglesey, how it became an Island, 279  
 Rankine (Prof.), Memorial to, 374  
 Rare Plants in the Alps, Unequal Distribution of, 516  
 "Recent Origin of Man," J. S. Southall, 245, 484, 510  
 Red Snow, 414  
 Refraction, Apparatus for illustrating the Law of, 535  
 Refraction of Light and Sound through the Atmosphere, Dr. A. Schuster, 67  
 Refraction of Sound, Prof. Osborne Reynolds, 218  
*Reichert and Du Bois Reymond's Archiv*, 258  
 "Reliquiæ Aquitanicæ," Lartet and Christy, 401  
 Renshaw (A. G.), Screw-Propeller in Nature, 367  
 Reptilia and Batrachia of Costa Rica, 257  
 Repulsion and Radiation, W. Crookes, F.R.S., 391, 450  
 Research Fund for the Chemical Society, Dr. W. J. Russell, F.R.S., 461  
 Retriever Dog, and Cat, 36; a Criminal, 69  
 Revue Philosophique, 477  
 Reynolds (Prof. Osborne), Hartley's "Air and its Relation to Life," 243; Refraction of Sound, 218  
 Rhabdomancy, Miss Buckland on, 200  
 Richardson (Dr., F.R.S.), Dr. F. de Chaumont on his Hygeia, 25; "Diseases of Modern Life," 508  
 Rink (Dr. Henry), "Tales and Traditions of the Eskimo," 103  
 River-beds of the Riviera, 406, 448  
 Rivers, Wm. Hope on the Pollution of, 81  
 Riviera, the Dry River-beds of the, 406, 448  
 Romanes (G. J.) on Medusæ, 496  
 Rome, Accademia dei Lincei, 536; Excavations at, 155; the University of, 114, 296  
 Roscoe (Prof., F.R.S.), on Popular Science Lectures, 82; Physical Science in Schools, 353, 386  
 Ross (Major W. A.), "Pyrology, or Fire Chemistry," 164; Blow-pipe Analysis, 186; D-line Spectra, 366  
 Rosse (Lord), Bronze Statue of, 435  
 Rotherham, Science Classes at, 135  
 Routledge (R., F.C.S.), "Discoveries and Inventions of the Nineteenth Century," 44  
 Royal Arsenal, Chemical Society at, 395  
 Royal Institution, Lectures at, 75  
 Royal School of Mines, Annual Dinner, 155  
 Royal Society, 78, 98, 118, 134, 138, 158, 176, 198, 218, 237, 277, 298, 397, 418, 458, 478, 498, 533; Anniversary Meeting, 93; Committees, 193; Conversazione, 473; Election of Officers and Council, 35; Medals of the, 34, 93; New Fellows, 474  
 Rogers (C. E. H.), Seasonal Order of Colour in Flowers, 129  
 Rugby Catalogue of Double Stars, 287  
 Russell (Dr. W. J., F.R.S.), a Research Fund for the Chemical Society, 461  
 Russia, Expedition to Behring's Straits, 217  
 Rüttimeyer on Traces of Man in the Glacial Coal-beds of Switzerland, 130
- Safety Matches, 469, 512  
 St. Gothard's Tunnel Works, Compressed Air Locomotives used in, 489  
 St. Helena, the Natural History of, 272  
 St. Petersburg, Meeting of Orientalists, 76  
 Salet (M.), the Spectrum of Nitrogen and that of Alkaline Metals in Geissler Tubes, 314  
 Salmon, Investigation into the Habits of, 53; in New Zealand, 256, 257  
 Salt, the Flame of Common, 287, 306, 448  
 Satellites of Uranus, 208  
 Saturn, Occultations of, 188; Rings of, 307; Satellite Hyperion, 326  
 Saw-fish inhabiting Fresh Water, 107, 167  
 Scheerer and Blanford's "Introduction to the Use of the Mouth-Blowpipe," 164  
 School Examinations and the University of London, 261, 286  
 Schools, Physical Science in, 311, 329, 353, 371, 386, 412, 430, 454, 472, 491  
 Schott (Chas. A.), Meteorological Charts of the United States, 53  
 Schuster (Dr. A.), the Bothkamp Sun Observations, 402; the Flame of Common Salt, 306; the Late Eclipse, 86, 207; on the Radiometer, 458; Refraction of Light and Sound through the Atmosphere, 67; Scientific Notes taken in the Himalayas, 393  
 Schweinfurth (Dr. G.), "Artes Africanæ," 142  
 Science and Art in Ireland, 309, 349, 370  
 Science Classes and Penny Lectures in Birmingham, 149  
 Science Commission, Seventh Report of, 21  
 Science: in Germany, 10, 30, 75, 112, 250, 452, 521; in Italy, 110; in Leeds, 527  
 Science in Schools (*See* Schools)  
 Science Lectures at Manchester, 82  
 Science Teaching to Young Children, G. H. West, 48  
 Scientific Agriculture, Prof. T. Baldwin, 101  
 Scientific Apparatus, Loan Exhibition of, 36, 196, 231, 274, 295, 315, 349, 375, 413, 455, 470, 474, 503  
 "Scientific Culture," Josiah P. Cooke, 284  
 Scientific Instruction and the Advancement of Science, 371  
 Scientific Notes taken in the Himalayas, Dr. A. Schuster, 393  
 Scientific Research, Lord Derby on the Endowment of, 141  
 Scientific Research for the Promotion of Science, Prof. Piazzi Smith, 45  
 Scientific Societies of Dublin, 470  
 SCIENTIFIC WORTHIES, VII.—Sir Charles Wheatstone, 501  
 Sclater (P. L., F.R.S.), Geographical Zoology, 482; the Island of Socotra, 414, 426  
 Scorpion, H. Woodward, F.R.S., on a Fossil, 58  
 Scotland: Scotch Herring Fishery Board, Report of, 35; Scotch Universities, Science Commission, Report on, 21; Royal Agricultural Society, 101; Meteorological Society of, 53, 76, 100, 135  
 Scott (R. H., F.R.S.), Hoffmeyer's Synoptic Weather Charts, 85  
 Screw Propeller, Origin of, 367, 386, 428, 465, 512  
 Screws, Dr. Ball, F.R.S., on, 463  
 Scrope (G. Poulet, F.R.S.), Cup-shaped Joints in Prismatic Basalt, 47; Glaciers in France, 149, 166; Obituary Notice of, 241  
 Scudder (S. H.), Fossil Butterflies, 222  
 Sea, the, Jules Michelet, 106  
 Seasonal Order of Colour in Flowers, 150, 326, 348, 366, 427  
 Sea Trout on the Norfolk Coast, 114  
 Sea-water, the Expansion of, by Heat, 237  
 Secchi (Padre), Ericson's Researches on the Sun, 46; Spectra of Stars, 480  
 Sedgwick Memorial, 375



- Secbohm (H.), Ornithological Collection, 14  
 Seeley (Prof. H. G.), the Ornithosauria, 98  
 Selenium, Action of Light on, 238, 407, 419; Herr W. Siemen's Researches on, 112  
 Settle Cave Committee, Report of, 55  
 Sexuality of Plants and Sir Thomas Millington, 85, 127, 166, 185  
 Sheep, Small-pox of, E. Klein, F.R.S., 467  
 Siberia, Notes from, Prof. George Forbes, 469  
 Siberia, Northern, German Expedition to, 368  
 Siebold (Prof. von), Fresh-water Fishes of England, 366  
 Siemens (Dr. C. W., F.R.S.), the Action of Light on Selenium, 407; Bathometer, 431  
 Siemens (Herr W.), Researches on Selenium, 112  
 Silica, Prof. Rupert Jones, F.R.S., on various Forms of Silica, 159  
 Sirius, the Companion of, 428  
 Sivewright (J.), Preece and Sivewright's "Telegraphy," 511  
 Skeleton, Inquest on a, in New Zealand, 196  
 Skin-scrapers, Flint, from New Jersey, 270  
 Sloths, Protective Resemblance in the, J. C. Galton, 187  
 Small-pox of Sheep, E. Klein, F.R.S., 467  
 Smith (Hermann) on the Nature of Musical Pipes having a Propulsive Mode of Action, 511  
 Smith (Worthington G.), Fertilisation of Basidiomycetes, 186; Potato Disease, 524  
 Smithsonian Institution, Report of, 94  
 Smyth (R. B.), Geological Map of Australia, 352  
 Smyth (Prof. Piazzi), Scientific Research the [Promotion of Science, 45  
 Snow, Red, 414  
 Socotra, the Island of, 414, 426  
 Solar Eclipses of 1605, 108; of 1999, 169; of 1876, March 25, 248; Total, of 1876, 268; of 1706, 307; of 1883, 406  
 Solar Halos, 495, 512; Coloured, 404, 426, 466  
 Solar Spectra, Capt. Abney on Photographing, 419  
 Solar Spots, Veiled, Mr. Trouvelot on, 497  
 Somerset House and the Public Analysts, 242  
 Somersetshire, Floods in, 155  
 Sorby (H. C., F.R.S.), Address at Microscopical Society, 384; Apparatus for Measuring Spectra, 159; Colour of Flowers Grown in the Dark, 465; the Evolution of Hæmoglobin, 306; Measuring Bands in Spectra, 39; Relation between Microscope and Molecules of Matter, 332  
 Sound, Prof. Osborne Reynolds on the Refraction of, 218; Prof. Stein on the Formation of, 78  
 South Kensington, Lectures on Botany at, 436; Loan Exhibition of Scientific Apparatus at, 36, 196, 231, 274, 295, 315, 349, 375, 413, 503; Musical Instruments at, 443  
 Southall (J. C.), "The Recent Origin of Man," 245, 484, 510  
 Southport, Aquarium, 197; Botanic Garden and Museum at, 495  
 Southworth (A. S.), "Four Thousand Miles of African Travel," 43  
 Spectra, D-line, Major W. A. Ross, 366; Prof. G. G. Stokes, F.R.S., 247  
 Spectra, H. C. Sorby, F.R.S., Apparatus for Measuring, 159; Measuring Bands in, 39; of Solutions, New Form of Tube for Observing, 74; of Stars, Padre Secchi, 480  
 Spectroscopy, J. Norman Lockyer, F.R.S., on some Recent Methods of, 239  
 Spectrum Analysis, Prof. Stokes, F.R.S., on the Early History of, 188  
 Spectrum of Fish-pigment, George Francis, 167  
 Spectrum, Photography of Red End of the, Capt. W. de W. Abney, 432  
 Sphygmograph, M. Bouilland on the, 114  
 Spiders, Old and New World, 281  
 Spinoza, Proposed Statue of, 315  
 Spottiswoode (W., F.R.S.), Experiment on Electro-magnetic Rotation, 498  
 Spring Plants, the Flowering of, Alex. Buchan, 249  
 Squirrels, Cherry Blossoms destroyed by, 26  
 Stanford's Map of India, 95; Geographical Maps, 396  
 Stanley's Exploration of Africa, 35, 53, 76, 93  
 Stars, 226; Atlas Pleiadum,  $\times$  453, 129; B.A.C. 793, 419; Binary, 69, 287, 249; the Binary  $\gamma$  Coronæ Australis, 248; Double, 449; Double, Rugby Catalogue of, 287; 40 Eridani, 8; Proper Motion of  $\alpha^2$  Centauri, 8; Variable, 27, 150, 227, 306, 326, 367, 467, 486  
 Stationary Liquid Waves, Dr. Guthrie, 99  
 Steam, Physical Constitution of, J. J. Murphy, 466  
 Stein (Prof.) on the Formation of Sound, 78  
 Stenographic Exhibition at Rome, 114  
 Sterlets at the Manchester Aquarium, 77  
 Stevenson (Thos.), Proposed Optical Barometer, 150  
 Stewart (Prof. Balfour, F.R.S.) on Measuring the Heat of the Sun, 118  
 Stieler's Hand Atlas, 236  
 Stockholm Academy of Sciences, 320  
 Stockwell (J. N.), Theory of the Moon's Motions, 88  
 Stokes (Prof. G. G., F.R.S.), D-line Spectra, 247; the Early History of Spectrum Analysis, 188  
 Stoliczka's (Dr.) Collection of Mammals, 106, 109  
 Stone (Dr.), on Thermopiles, 59  
 Stoney (Prof. Johnstone, F.R.S.), on Radiometers, 420  
 Storer (F. H.), Cherry Blossoms destroyed by Squirrels, 26  
 Storms: Blasius on, 421; T. S. Osborne, 406; Faye on the Laws of, 11, 87, 187  
 Strange (Col., F.R.S.), Obituary Notice of, 396, 408  
 Strata, Bristow's Tables of British, 464  
 Stream Lines, Wm. Froude, F.R.S. on, 50, 89, 130, 169  
 Struve's Companion of Procyon, 406  
 Submarine Explorations, W. Topley, 133  
 Sub-Wæalden Exploration, 175, 334, 396  
 Sulphurous Acid Ice-Machine, Raoul Pictet's, 432  
 Sumatra, Exploration of, Dr. A. A. W. Hubrecht, 209  
 Sun: Prof. Balfour Stewart on Measuring the Heat of the, 118; P. A. Secchi on Ericsson's Researches on the, 46; Origin of the Heat of the, W. Coutie, 126; the Bothkamp Observations, 402; Rotation of, and Moon's Revolution and the Earth's Magnetism, 466  
 Sun-spots, 497; and the price of corn, 15; Father Secchi on, 137  
 Surrey Commercial Docks, Excavations at, 77  
 Sussex, Flora of, 155  
 Sutton (Dr. G.), Report on Trichinosis, 105  
 Sweden: Rainfall of, 436; Tornado in, 216  
 Swedish Arctic Expedition, 16, 116  
 Switzerland, Traces of Man in the Glacial Coal-beds of, 130  
 "Syllabus of Plane Geometry," 102  
 Symonds (Rev. W. S.), Ancient Glacier Action in Central France, 67; the Fossil Skeletons of Le Puy en Velay, 207; Ancient Glaciers in France, 425  
 Tacchini (Prof.), Sun-spots, 497  
 Tait (Prof.), on the Earth's Age, 486; "Recent Advances in Physical Science," Prof. Clerk Maxwell, F.R.S., 461  
 Tartaric and Citric Acids, 78  
 Tea, Cultivation of, in India, 175  
 Telegraph Cables, Testing of Deep Sea, 517  
 "Telegraphy," Preece and Sivewright's, 441  
 Telescope, the Great, of the Paris Observatory, 229  
 Thames, High Tides in the, 54  
 Thermal Energy and Radiation; Capt. J. Ericsson, 114, 224  
 Thermometer, Self-registering, 79  
 Thermopiles, Dr. Stone on, 59  
 Theophrastus versus Millington, 127  
 Thibet, Upper, Mirage in, 67  
 Thomson (Prof. Wyville), Obituary Notice of Dr. von Willemoes Suhm, 88; the Work of the *Challenger*, 70  
 Thorell (T.), European and North African Spiders, 281  
 Thorpe (Prof. T. E.), Specific Volumes of Liquids, 397  
 Three Kingdoms of Nature, 367, 386  
 Thurston (Prof. R. H.), "The Mechanical Engineer," 16  
 Tides, Extraordinary, B. G. Jenkins, 69  
 Tilden (W. A.), Physical Science in Schools, 373  
 "Timber and Timber Trees," Laslett's, 181  
 Time, Correct, in Country Towns, 95  
 Tissandier's Photography; R. Meldola, 204  
 Tomlinson (C., F.R.S.), on Safety Matches, 469  
 Tomsk University, 357  
 Topley (W.), Channel Tunnel—Submarine Explorations, 133  
 Tornado in Sweden, 216  
 Toulouse, New Telescope at the Observatory, 16  
 "Tour de France," 135  
 Trade Winds, Course of the, 12  
 Tramways, Condensed Air, 228; Steam Engines on, 77  
 Transit of Venus, 238  
 Trees, Effects of Lightning on, 120  
 Trichinosis, Dr. G. Sutton's Report on, 105  
 Troglodytes, French and Swiss, 401  
 Trogonidae, J. Gould's Monograph of the, 166

- Tube for observing Spectra of Solutions, New Form of, 74  
 Tucker (R.), Morell's Euclid Simplified, 427  
 Tuckwell (Rev. W.), Physical Science in Schools, 412  
 Tufted Deer of China, 334  
 Tuning Forks, Prof. Stern on, 38  
 Tylor (E. B., F.R.S.), "Dammann's Race Photographs," 184  
 Tylor (A.), Marine Deposits, 199  
 Tyndall (Prof., F.R.S.), Acoustic Cloudiness, 72; on Germs, 252, 268, 324, 347; Dr. H. Charlton Bastian, F.R.S., 284, 305; L. Pasteur, 305  
 Typhoid Fever, How it is Spread, 428, 447  
 Tyrol and the Tyrolese; W. A. B. Grohman, 206
- Uintatherium, Prof. W. H. Flower, F.R.S., 404  
 Ulrich (G. H. F.), Rocks and Minerals in the Melbourne Museum, 165  
 United States: Archaeological Researches in Kentucky and Indiana, 109; Collection of Mineral Products of, 77; Geological Survey of, 156, 314, 356; Hopkins University, 412; Map of Colorado, 414; Meteorological Charts of, 53; National Academy of Sciences, 214; National Museum, 236; New York Lyceum, 531; Survey Publications, 385; Weather Maps of, 95; Weather Reports, 397; see also America, Philadelphia, &c.
- Universities Bill, 314, 341  
 University College, Ladies' Classes at, 235  
 University College, Bristol, 488  
 University of London and School Examinations, 261, 286  
 University Reform, 368, 381  
 "Unseen Universe," the, J. Emery, 485  
 Uranus, Satellites of, 87, 208  
 Usborne (T.S.), Storms, 406
- Valhalla des Sciences Purés et Appliquées, 266  
 Valorous, the Work of the, 250  
 Vanadium, the Physiological action of, 78  
 Van Beneden's "Animal Parasites," Dr. Spencer Cobbold, F.R.S., 303  
 Variable Stars, 27, 150, 227, 306, 326, 367, 467, 486  
 Venus, the Rotation of, 513  
 Verhandlungen der k. k. geologischen Reichsanstalt, 137  
 Vertebrate Animals, Origin of, Prof. Huxley, F.R.S., 388, 410, 429, 467, 514  
 Vesuvius, Mount, 94, 135, 155, 414, 436  
 Victoria and Albert Palace Association, 436  
 Victoria Cave, Report on the, 55  
 Victoria, Chinese Miners in, 256  
 Victoria Institute, 200, 240, 299, 440  
 Vienna Academy of Sciences, 179, 200, 260, 280; Geological Society, 179, 220, 319; New Observatory at, 192  
 Vignoles (C. B., F.R.S.), Obituary Notice of, 73  
 Vincent (C. W.), Year-Book of Facts, 1875, 365  
 Vivisection, 113, 321, 342, 385, 396  
 Volcanic Eruptions in Iceland, 135  
 Volcanic Rocks of the Canaries, 403  
 Volcanoes: Eruption of Vesuvius, 94, 135, 155, 414, 436; Mount Tongariro, 135  
 Volpicelli (Prof. P.), Notice (*with Portrait*) of Sir Charles Wheatstone, 501; Researches in Electrical Induction, 437, 475  
 Vvyyan (Rev. T. G.), "Analytical Geometry," 24
- Walker (H.), Plagiarism and Prof. Boyd Dawkins, 7, 26  
 Warrington (R.), Tartaric and Citric Acids, 78  
 Wasps, Ants, and Bees, Sir J. Lubbock on, 37  
 Water a Mineral, 367, 386  
 Water, Organic Impurities of Drinking, Prof. Frankland, F.R.S., 330  
 Waterspouts and Eddies, 11  
 Water Supply of the Metropolis, 201, 392, 425  
 Watford Natural History Society, 319, 376
- Watts (Dr. W. Marshall), Physical Science in Schools, 311, 455, 491  
 Waves, Capt. W. W. Kiddle on the Effect of, 108  
 Weather Charts, Hoffmeyer's Synoptic, 85  
 Weather Maps of the United States, 95  
 Webb (Rev. T. W.), Caroline Herschel, 361; Meteor in the Daytime, 187, 207  
 "Weight" and "Mass," the Use of the Words, 325, 385, 405, 446, 466, 484  
 Wellington (N. Z.), Philosophical Society, 179  
 Welwitsch (Dr.), his Botanical Collections, 76  
 West (G. Herbert), Science Teaching to Young Children, 48  
 Westminster Aquarium, 255, 274  
 Weyprecht (Lieut.), Arctic Exploration, 33  
 Whale, Prof. Flower, F.R.S., on a new, from New Zealand, 149  
 Wheatstone (Sir Charles), Notice (*with Portrait*), by Prof. F. Volpicelli, 501; Legacies of, 76  
 Wheeler (Lieut.), Expedition to New Mexico, 76  
 Whitaker (W.), Geological Record for 1874, 322  
 White (Gilbert), Unpublished Letters of, 496  
 "White Conquest," Hepworth Dixon's, 23  
 Wiedersheim on Amphibians, 30  
 Wigan, Mining and Mechanical School, 174  
 Wild Birds' Protection Act, 315  
 Wilde (Sir W., M.D.), Obituary Notice, 527  
 Wilkinson (Sir J. G., F.R.S.), Death of, 16  
 Willemoes-Suhm (Dr. von), 52, 129; Obituary Notice of, Prof. Wyville Thomson, 88  
 Williams (W. Mattieu), the Difficulties of Public Analysts, 266  
 Science Classes and Penny Lectures in Birmingham, 149  
 Willis (J.), Internal Heat of the Earth, 8  
 Wills (A. W.), Some Unsolved Problems in the Management of the Marine Aquarium, 189  
 Willson (W. G.), Meteorology of Bengal, 66  
 Wilson (A.), "The Abode of Snow," 4  
 Wilson (Dr. Andrew), Physical Science in Schools, 412  
 Wilson (J. M.), Physical Science in Schools, 329, 354, 371, 477  
 Winchester College Natural History Society, Report of, 19  
 Winds, Climatic Characteristics of, 520  
 Wine, Pseudo, from Tsen-ia, 175  
 Wöhler (F.), Autobiographical Sketch of, 80  
 Wood (W. W.), Saw-fish Inhabiting Fresh Water, 107  
 Woodpeckers and Wrynecks, Prof. Parker, F.R.S., on the, 173  
 Wortley (Col. Stuart), Photography in the *Challenger*, 25  
 Wright (T.), "The Celt, the Roman, the Saxon," 16  
 Wrynecks and Woodpeckers, Prof. Parker, F.R.S., on the, 173  
 Wyles (T.), Physical Science in Schools, 454
- Yarkand, the Mammals of, 109  
 Yarmouth Aquarium, 77  
 Year-book of Facts, 1875, 365  
 Year-book of Photography, 256  
 Yellow Glass for Use in Zoological Collections, 488  
 Yorkshire College of Science, Scholarship at, 35  
 Youmans (Dr. E. L.), "Class-book of Chemistry," 424
- Zambesi, E. Mohr's Work on, 384  
 Zeitschrift der Oesterreichischen Gesellschaft für Meteorologie, 97, 137, 157, 218, 497, 532  
 Zeitschrift für Wissenschaftliche Zoologie, 157, 257  
 Zodiacal Light, 169; the "Gegenschein" of the, 129  
 Zoological Collections, Yellow Glass for, 488  
 Zoological Gardens, Additions to, 17, 37, 54, 77, 114, 136, 156, 175, 198, 218, 237, 257, 274, 297, 316, 336, 358, 376, 397, 414, 458, 475, 496, 532  
 Zoological Gardens in America, 76  
 Zoological Society, 39, 79, 139, 219, 258, 298, 339, 399, 439, 499; Lectures, 374  
 Zoology, Dr. Sclater's Geographical, 482  
 Zuyder Zee, the Drainage of the, 288



## A WEEKLY ILLUSTRATED JOURNAL OF SCIENCE

*"To the solid ground  
Of Nature trusts the mind which builds for aye."*—WORDSWORTH

THURSDAY, NOVEMBER 4, 1875

### AMERICAN GEOLOGICAL SURVEYS \*

THE volumes which record the progress of the United States Geological Survey of the Territories since its commencement in 1867 contain much information of great value to geologists, as well as to those who watch with intelligent interest the advance of the wave of human civilisation into the far West. Each of them is full of fresh illustrations of the principles of geology, such as the dependence of scenery upon rocky structure, the order of succession of formations, the plication of mountain-chains, the phenomena of volcanic action, the functions of rivers and glaciers as geological agents—illustrations which have already to some extent found their way into general text-books and are no doubt destined ere long to be made in that way familiar even to tyros in the science all over the world. In each of them too we have such information as could be gathered as to the agricultural value of the countries, the practicable routes for roads and railways, the mineral resources to be looked for, the facilities for general commerce—information which will probably serve as the basis for the future development of the regions into settled States.

During the years 1871 and 1872 Dr. Hayden's parties were at work about the sources of the Missouri and Yellowstone Rivers. They had gradually pushed on into that wild region, stimulated by the variety and interest of its scenery and geology, but they had got far from any civilised base-line, including railroads and other conveniences of transport and subsistence. Beyond them lay the lands of the Indians, who manifested no disposition to treat the peaceful work of the Survey in another light than as some insidious part of the designs of the grasping central power at Washington. It seemed desirable therefore in the meantime to discontinue the further prosecution of the Survey in the north-west until by the establishment of railroad communication it could be resumed with much less labour and cost. This delay, however, will probably not be of long continuance, when

\* See vol. xii. p. 267.

we consider with what marvellous rapidity the tide of American energy is travelling towards the Pacific.

The region recommended by Dr. Hayden and approved of by the Government as the scene to which the operations of the Survey should be transferred was that portion of the Rocky Mountain range which runs through Colorado and New Mexico—a region as yet unsurveyed and likely in a few years to be rapidly developed by some of the most important railroads of the West. The survey of the fortieth parallel by Mr. Clarence King, to which allusion has been already made, and of which some account will be given in a subsequent paper, had done good service in making known the physical features and geology of a belt of country stretching across the northern limits of the tract which Dr. Hayden now proposed to examine. That survey would form the starting-point of the new explorations which it was arranged should sweep westward across the watershed of the continent to the left bank of the Green and Colorado Rivers, eastward across the sources and higher course of the Platte, Arkansas, and other tributaries of the Mississippi, and southwards to the boundary-line between the United States and Mexico.

The first instalment of results from this transference of area has appeared in the Annual Report of the Geological Survey of the Territories for 1873—a thick volume of 718 pages, with numerous and excellent sections, maps, and views. This Report is divided into four parts, devoted respectively to—I. Geology, Mineralogy, and Mining Industry; II. Palæontology; III. Zoology; IV. Geography and Topography. An appendix contains papers on some mineral fields, while detailed descriptions of a large number of new species of fossil plants and animals are given in Part II. Taking the general supervision of the whole operations of the Survey, Dr. Hayden furnishes some chapters in reference to the geological features of part of the eastern slope of the Rocky Mountains, and introductory to those of the officers placed by him in charge of the three subdivisions into which, as already remarked, the work of the year was arranged. It appears that the first division, under the charge of Mr. A. R. Marvine, surveyed, topo-

graphically and geologically, an area of 5,600 square miles during the period between the end of May and the latter part of October; the third division, under Dr. F. M. Endlich, accomplished the survey of nearly 7,600 square miles, "particular attention being paid to the agricultural and mineralogical resources of the country traversed." Allowing 130 full working days for the period during which these two parties were at work, we find that on an average 100 square miles were surveyed topographically and geologically each day, and that this was performed by some seven or eight observers! And if it be further noted that only half of that number were geologists, and that in the case of the San Luis, or third division, the geological work appears to have been done by one man, we shall form some notion of the rate at which scientific surveys advance in the far West. We have not the same precise statements of the area actually surveyed by the second or South Park division, under Dr. A. C. Peale; but it seems to have been on the same extensive scale.

Now by those who take interest in the progress of topographical and geological surveying some explanation will naturally be required as to the almost incredibly large area examined in one season by Dr. Hayden's corps. Compared with his rate of progress, our Ordnance and Geological Surveys creep on at a snail's pace. His geologists, for instance, get over in a single day an amount of ground which the most hard-working and experienced members of the Geological Survey of Great Britain could hardly accomplish in a year's campaign. Evidently the two kinds of work cannot properly be compared with each other. That of the British Surveys is minutely detailed, and meant to be, for the time, exhaustive. The American Survey of the Territories, on the other hand, cannot be regarded as, and does not pretend to be, more than a rapid but intelligent reconnaissance, wherein the positions of the leading landmarks are correctly determined, and those of the intermediate features are fixed as nearly as may be; while, acting in concert with the topographer, and availing himself of the same points of observation, the geologist ascertains the nature and order of the rocks in a few traverses from which he infers what must be the structure of the surrounding districts. It is no disparagement to this work to say that it must in the end be superseded by more accurate and detailed surveys. It is in the meanwhile doing a notable service by pioneering in vast and unknown or little known regions, and giving the world a first outline of the main features of their geography and geology. In the territory of Central Colorado investigated in 1873, the geologists had the advantage of comparatively simple structure to deal with. So clearly does the skeleton of the continent protrude in that region through the surface, that from each main hill-top it was not difficult to follow for many miles on successive ridges and spurs the crags and hollows marking the lines of outcrop of particular strata. The extent to which this peculiarity and simplicity of geological physiography has been useful, may be inferred from the numerous diagram-sections of the belt of country surveyed, showing the relation of the surface-contour to the arrangement of the underlying rocks.

Space cannot be given here for a detailed account of this Report, but reference may be made to some of its

features which have a general interest. Mountain-structure, especially in relation to the plications of the crust of the earth, receives much notice from the various members of the Survey. They have followed the gradual swelling of the flat formations of the plains, first into gentle ridges or "hog backs," then into more marked and crested ranges, until they have traced them in vertical or even inverted masses reposing against the central core of granite. Crossing this latter they have caught up again the same formations on the other side, and followed them in like order and position from the disrupted and highly-inclined central mass down to their gradual subsidence into the flat plains. The rocks next to the granite are metamorphosed, and, what must strike European geologists as curious, have huge intercalated sheets and dykes or veins of trachyte associated with them. The elevation of the mountain ranges has upraised cretaceous rocks, and even some parts of later geological formations.

The length of time, however, which has passed since the upheaval of the Rocky Mountains and their subsidiary spurs has allowed a vast amount of work to be done upon their slopes and crests by the weather, rain, torrents, frost, snow, and glaciers. It would seem hardly possible indeed to find a region where it would be more easy to appraise exactly the amount of waste from a given area due to this cause. The geological structure of the anticlinal and synclinal folds is so simple, the rocks are so well exposed, and the limits of sub-aerial erosion seem so sharply marked off from those of subterranean movement, that the flanks of the Rocky Mountains might be selected as a typical region for the study of this branch of physiographical geology. Sometimes the corries or cirques ("gulches" is their American name) have been cut back so as to leave a steep hardly-traversable crest between them, while now and then a valley has been cut completely across the watershed, so as to draw its first waters from the other side. In some places the rocks have been so weathered as to stand up in extraordinary pillars and capped statuesque masses like those for which Saxon Switzerland has been so long famous.

The former presence of extensive glaciers descending from the mountains of Colorado has been proved by the evidence of huge moraine mounds, admirable ice-worn domes of granite, and scattered glacier-lakes. It would seem, indeed, that no very great diminution of temperature might suffice to restore glaciers to these valleys. Dr. Hayden describes vast masses of snow and ice, which, melting in summer on the steep slopes and saturating the rocks and soil, slide down like glaciers and cumber the declivities and valleys with piles of rubbish.

The now well-known geysers of the Yellowstone region have made known the extent and comparative recentness of volcanic action in that region. We learn some further facts of interest on this subject from the present report. Dykes and streams of basalt have been found in proximity to their parent cones. In some cases the lava beds form the cappings of isolated hills, or project as terraced bars from the sides of the slopes. In other instances they occur in the bottoms of the valleys, and even appear to have sometimes crossed the present river-courses and formed lakes. Recent, therefore, though these lava-eruptions must be, they were evidently continued during a period of time long enough for deep and wide valleys to be cut

out of the older flows, while *coulées* were poured down the excavated hollows. In these respects the history of this late North American volcanic action recalls the succession of events so long ago and so admirably described by Mr. Poulett Scrope as traceable among the volcanic masses of Central France.

The mines now in operation, as well as indications of probable positions for new ones, are carefully noted in the Report. The geologists, indeed, have constantly had before them the consciousness that the future development of these territories would not be helped so much by their making out all geological details at present as by their ascertaining what practicable places could be found for the establishment of mining industry. At the same time, they deserve great credit for keeping the thoroughly scientific character of their duty so conspicuous in their reports; for undoubtedly the only way to make an exploration which shall be of real value as a guide in mining operations is to do it in the strictest sense geologically. With the area and relations of the different rock-formations mapped out for him, the mining prospector may save much time and money by learning what tracts to avoid as well as which to explore.

Each of the geologists in command of a division under Dr. Hayden furnishes a report, which appears in the present volume. These are remarkably well done, that of Mr. Marvin being specially interesting from the variety of phenomena with which he had to deal and the clearness with which he tells his story. Besides the geological reports, Prof. Lesquereux supplies one of great value on the Lignitic formation and its fossil flora, in which he enters anew into the vexed question of the true age of that formation. As the result of his long study of its large and well-marked flora, he concludes that the formation is of Tertiary date, a conclusion which agrees also with that to which Dr. Hayden has been led. A large list of new species of fossil plants from the Lignitic strata is described by him in his report. Under the head of Zoology are gathered a number of communications on insects, crustacea, mollusca, and other invertebrata, collected or observed during the progress of the Survey. The part devoted to Geography and Topography contains the reports of the geographer and his colleagues on the system of triangulation employed, the heights of various places, the practicable routes, and other matters. The book is well printed and well illustrated. It deserves the heartiest commendations both for the Government which supports such good work and for the men by whom it is practically done.

ARCH. GEIKIE

#### ALIX ON THE LOCOMOTION OF BIRDS

*Essai sur l'Appareil Locomoteur des Oiseaux.* By Edmond Alix, M.D. (Paris: G. Masson.)

THIS considerable volume, the first independent work of any pretensions on the osteology and myology of birds, is a valuable addition both to zoological and to ornithological literature. As far as the latter is concerned it would have been more distinctly useful if the author had been better acquainted practically with birds' skins, as well as with the binomial nomenclature and the importance of specific distinctions. If he had, such a sentence as the following

would have been modified in a manner which would have made it of greater value to future investigators, at the same time that the precision would have added weight to the points brought forward. We are told with reference to the accessory femoro-caudal muscle that "this fasciculus, represented in the Cormorant by an aponeurotic band, is found uncomplicated in the Grebe, Flamingo, Heron, Bustard, and Secretary Bird," in which remark the fact that what are there termed Grebe, Bustard, &c., are general terms, seems to be entirely ignored; as is therefore the possibility of there being structural differences among the members of the included groups. It may even be mentioned that respecting the very point referred to in the above quotation, the statement therein made does not generally apply, being correct as far as the Little Grebe (*Podiceps minor*) and the Common Heron (*Ardea cinerea*) are concerned, but being inaccurate when said of the Eared Grebe (*Podiceps cristatus*) and the Giant Heron (*Ardea goliath*). Most works on the anatomy of birds suffer from the same imperfection; the importance of specific and even generic distinctions being generally disregarded, by all but pure ornithologists.

The work is divided into three sections—the three in which the consideration of the locomotive apparatus of birds most naturally falls; namely, the consideration of birds firstly as vertebrated animals (zoologically); secondly, as a special organised type (anatomically); and thirdly, as flying animals (physiologically). An excellent *résumé* of previous investigations on the several subjects prefaces each section, in which due credit is on nearly all occasions given to foreign workers.

Under the first heading, following the teaching of De Blainville and Gratiolet, Dr. Alix describes the typical skull on the hypothesis of its vertebral origin; of the fourth or nasal vertebra, considering the perpendicular plate of the ethmoidal as the centrum, the lateral masses of that bone as the laminae, and the nasals as the spinous element.

In the treatment of the osteology of birds, most of the important subjects which have of late attracted most considerable attention are fully discussed. We are rather surprised to find no reference to the point so forcibly put forward by Prof. Parker, and laid stress on by Prof. Huxley, with regard to the ankylosis of the palatine bones with the vomer in the Tinamous. The vomer as a separate bone is also rather neglected. As to the light thrown by a study of the skull on the classification of birds, we read that "the examination of the head of birds confirms the major divisions established originally from a consideration of the beak and the feet. It proves that Raptores, Passeres, Gallinæ, &c., exist in reality: but it also renders it evident that there are divisions beyond these not capable of being included among these primary forms. For instance, the Parrots form a well-marked group of themselves . . . the Raptores Nocturnæ are clearly distinct from the Raptores Diurnæ, the Pigeons can in no way be confounded either with the Passeres or with the Fowls." As to the sternum, "the results arrived at by De Blainville and confirmed by subsequent authors (are said to) prove that Cuvier has narrowed the question too much in affirming that the indications afforded by the sternum cannot serve for more than generic distinctions. But it must be admitted that, with the exception of the cha-

racters indicated by the presence or absence of the carina, it is almost impossible to recognise in the sternum any of those distinguishing features which may be stated in a single word, or may be incorporated as a definition in any tabular arrangement. The sternums of most birds, even those which are most peculiar, must be considered in their entirety, and a complete description is necessary for their differentiation." We would feel disposed to go even further than this, and to say that in the sternum there are characters from which, with a little extraneous assistance, more considerable generalisations may be arrived at. It is true that in the passerine *Pteroptochus* the posterior margin is doubly notched on either side, but in how different a manner from that in the piciform birds and owls! What more than the sternum proves the closeness of the relationship between the Toucans, Woodpeckers, and Capitoes, also between the Swifts and the Humming Birds, as well as the small kinship between the gallinaceous birds and the Sand Grouse? On the other hand, the sternum does not aid us much in the determination of more distant relationships, such as those of families one to the other. From it alone we should not feel justified in placing the Tinamou near the Apteryx, nor the Stormy Petrels near the Fulmars.

In the *Bulletin de la Société Philomathique* and in the *Journal de Zoologie* Dr. Alix has published his dissections of the Rhea and of a Tinamou (*Nothura major*). His myological investigations are based on the descriptions given by Vic d'Azyr and Meckel. Following the latter of these, he mentions that in the Cormorant the ambiens muscle (*accessoire iliaque du fléchisseur perforé*) is absent, which is decidedly not the case in the common species (*Phalacrocorax carbo*). With reference to this bird, the accessory femoro-caudal is said to be represented by an aponeurotic band, which we have failed to detect; and the same remark applies to the muscle itself in the Heron (*Ardea cinerea*), in which it is also said to be developed; from which we may infer that the author has evidently not clearly recognised the characters which distinguish this fleshy fasciculus from the obturator externus (*carré*); and that such is the case is further proved by his statement that the latter named muscle is enormous in the ostrich, in which it is in reality very small, being almost hidden by the former.

The flexor tendons of the toes are specially dwelt on. The flexor perforatus digitorum is shown to present peculiarities sufficiently important to deserve special names. This muscle in birds is not a single one, but is formed of a superficial and a deep group; the latter having two separate origins, an internal and an external, of which the relative proportionate bulks vary. Those birds in which the outer head is the larger are termed *ectomyens*; those with a larger internal head, *entomyens*; and those with equal heads, *homœomyens*. "The palimpeds, the longirostral and pressirostral Waders, the Flamingoes, the Storks, the Tinamou, the struthious birds and the Parrots, are entomyen; the Herons, the Rails, the gallinæ, Pigeons and passerines, are homœomyen; whilst the diurnal and nocturnal birds of prey are ectomyen." The deep flexors are said not to offer such remarkable differences as those just referred to, but as none of their most striking peculiarities are mentioned, we presume that the author is unacquainted with them. The long flexor tendon to the

hind toe, we are told, is absent in the swan; it may be so in *Cygnus olor*, such is certainly not the case in *C. nigricollis*.

The last section of the work is almost entirely devoted to the flight of birds, this subject being viewed from a theoretical standpoint only. It is demonstrated in a fairly conclusive manner that the assumption of Borelli, in which the wing is considered to strike directly downwards and to turn backwards simply on account of the yieldingness of its posterior margin, is insufficient to explain the different movements observed; at the same time that it is opposed to the results arrived at from a study of the shape of the articular surfaces of the shoulder, and the arrangement of the fibres of the muscles acting on that joint. This, we think, is the tendency of modern investigation, notwithstanding the support, by M. Marey, of the opposite view. The results of the elaborate investigations of this latter able physiologist are as easily explained upon the one assumption as the other, perhaps better on the anti-Borellian theory, which no doubt is not required to account for the movements of the wings in the much less intricate problem of insect flight.

The following are Dr. Alix's propositions on this subject:—"First. The wing in the down-stroke begins by moving forward to attain its basis of support; after which it strikes briskly from above downwards, and at the same time from before backwards, as a result of which the bird is projected forwards. Second. At the moment at which the wing commences to descend, its lower surface looks forwards; but as it descends, this surface gradually turns to look directly downwards, and ultimately more and more backwards. Third. During the ascent of the wing, it moves upward and forward, its inferior surface at the same time looking forward." The nearly complete agreement of these observations with the results of M. Marey's previously published experiments is worthy of note, considering the differences in the starting-points of the two authors. The question of avian locomotion, as it now stands, is therefore not so much as to what are the positions of the wing during the different parts of the stroke, but as to whether the variations in the direction of its plane depend for their origin on the movements imparted to the humerus by the muscles acting on the shoulder, or on the influence of the resisting air upon a vertically moving plane which is more yielding behind than in front. This question requires further elucidation, though, as we have just remarked, we think, with Dr. Alix, that the balance of evidence is considerably in favour of the former view.

In conclusion, we strongly recommend this complete and able exposition of the locomotor apparatus of birds to all students both of physiology as well as of zoology.

#### "THE ABODE OF SNOW"

*The Abode of Snow.* Observations on a Journey from Chinese Tibet to the Indian Caucasus, through the upper valleys of the Himalayas. By Andrew Wilson. (Edinburgh and London: W. Blackwood and Co., 1875.)

LAST week we noticed Mr. Drew's almost exhaustive work on Jummoo and Kashmir; Mr. Wilson's work is to a large extent concerned with the same region, as



the greater part of the journey recorded was through Kashmirian territory. But the two works differ in many respects in design and plan. Mr. Drew has brought together so full and trustworthy a mass of information of all kinds about Kashmir as must render his work the great authority on the subject for a long time to come; his style is perfectly plain and unadorned; nearly every sentence is a positive statement of fact; he does not spend many words in admiration of the unparalleled scenery in the midst of which he lived for ten years, and he is never tempted into rapture. The attraction of Mr. Drew's work, and it is distinctly attractive, lies in the high interest and value and frequent novelty of the information contained in it. Mr. Wilson's aim, on the other hand, is to enable the reader to share, as far as words can go, the sensations which he himself felt in journeying for weeks in the midst of scenery whose grandeur cannot be adequately expressed, to present an impressive panoramic view of the "peaks, passes, and glaciers," and the fearful ravines of the highest mountains in the world, and to picture the scanty life which lurks in their lofty valleys or clings to their steep and rugged sides. His work is written, he tells us, "for those who have never seen and may never see the Himalaya. I have sought," he says, "to enable such readers in some degree to realise what these great mountains are, what scenes of beauty and grandeur they present, what is the character of the simple people who dwell among them, and what are the incidents the traveller meets with, his means of conveyance, and his mode of life?" Mr. Wilson has accomplished this task as successfully as it is possible to do it by means of language. Without apparent effort or artifice the current of his narrative flows on with delightful sweep; his style is vigorous, clear, and really eloquent, never bombastic or stilted, and with an under-current of genuine humour. He follows the only scientific method of reproducing in his readers the impressions made upon himself by the Himalayan scenery—by representing in simple but striking language the features which stirred his admiration and awe, never indulging in those futile and vague expressions of ecstasy which are a mark of the feeble observer, unscientific thinker, and unskilled writer. At the same time Mr. Wilson manages to convey a very considerable amount of information, and whoever reads his work with care will have realised to some extent the character of the region which it attempts to describe.

Mr. Wilson's main object in undertaking his toilsome tour among the Western Himalayas was to invigorate a constitution prostrated by the trying climate of India. His original intention was simply to visit Masuri and Simla, "but the first glimpse of the Jumnotri and Gangotri peaks excited longings which there was no need to restrain," and he plunged into the heart of the Himalayas. His journey lasted from June to November 1873. His real starting-point was Simla, though he gives valuable information as to other routes, and makes many shrewd comments on the men and manners of the various places through which he passed before reaching this point, on society and politics, and on certain burning questions connected with our Indian Empire. From Simla he proceeded up the stifling valley of the Sutlej to Shipki, where he made a vain attempt to get into Chinese Tibet; he was worsted by the women of the place. Hence he

proceeded in a generally north-west direction by the Lee River, through the Schinkal pass, past Padam in Zanskar, to Dras, visiting Sirinagar and the Vale of Kashmir, and on westwards by the Jhelam River to the Khyber Pass. This is easily told, but the difficulties Mr. Wilson had to encounter are almost incredible, especially when it is considered that he was an invalid in search of health; for a month he was laid up at Pu, not far north from Simla, by an attack which nearly proved fatal. He camped out nearly all the time, had frequent difficulty in procuring provisions for himself and his small retinue, had often to scramble along paths not much broader than a mantelshelf, overhanging ravines many thousands of feet deep, had to risk being lost in glaciers and frozen to death on passes upwards of 16,000 feet high. He bore it all with infinite good humour, and reached the Khyber Pass, we have no doubt, a stronger and a wiser, and quite as cheerful a man as when he started from Simla.

Mr. Wilson's work, as we have hinted, is something more than a fascinating tale of travel. While he gave himself up unrestrainedly to the scenic influences in the midst of which he sojourned for five months, he was quite alive to all the principal features of interest which presented themselves. There are frequent references to the animal and vegetable life of the region, to its grand physical and geological phenomena, and especially to the characteristics of the interesting people who inhabit the not infrequent villages on the route. He has added something to our knowledge of the glaciers of this part of the Himalayas. Mr. Wilson had several opportunities of observing closely the life of the people, and the information he gives will be found of value even by those who are familiar with the literature of the subject. He speaks, as might be expected, at considerable length on the polyandry and Lamaism which prevail over a considerable part of his route, and his remarks are characterised by great moderation and good sense. We wish we had space to quote the exquisite picture of domestic life which Mr. Wilson witnessed while snowed up at the village of Phe, in Zanskar. He seriously suggests the possibility of the Turanian Zanskaris being "congeners of the Celtic race."

He tells us a good deal, of course, about the Vale of Kashmir, and, like Mr. Drew and other geologists, concludes that it was at one time, and that not very remote, a great lake; he enters into some interesting speculations on the prehistoric inhabitants and condition of Kashmir. When near the end of his journey he made a bold raid across the Afghan frontier, and has a chapter on Afghan ethnology and the Afghan character.

In a chapter written under the influences of a moonlight midnight among the Himalayas—and how awe-inspiring and "other-worldly" such influences must be, one can easily imagine—Mr. Wilson indulges in some curious speculations on the struggle for life in the organic, and especially in the animal world, as contrasted with the inorganic. We think he has struck quite a wrong key here, and has not an adequate grasp of the facts of the case; but even if we had space we could not enter into his argument, as it is mixed up with certain subjects that are beyond the sphere of NATURE.

"The Abode of Snow" will, we believe, take its place as one among the few of our really classic works of travel.

## OUR BOOK SHELF

*Further Researches in Mathematical Science, embracing the Appendix of "The Two Discoveries."* By the author of "The Two Discoveries." (Clement Pine, Taunton Road, Bridgwater, 1875.)

OUR readers may ask, who is the author of "The Two Discoveries," and what are the Discoveries? An advertisement informs us that Mr. Clement Pine himself is the former, and that the subjects of "The Two Discoveries" are "The Mathematical Discovery, the Spiritual Telegraph, Astronomy, Cause of the Changes of the Seasons, Botany, Capillary Attraction, or the Principle of Growth; Religion, Progression, Scenery in the Spirit Realm, &c., and a variety of other topics." A suggestive list! We shall extract a *morceau* here and there which will indicate the nature of the present pamphlet. There are "important discoveries in a science in which very slight advances have been made since its foundation was laid by Euclid." We commend this to the "Improvement of Geometrical Teaching Association." To his scholastic ignorance and to his loss of sight, Mr. Pine attributes the fact of his attention having been turned to these subjects and of his having hit upon shorter, simpler, and more effectual modes of obtaining certain results.

After a personal narrative, he tells us he bought a guitar. "The guitar having only six strings to perform a melody which may require sixteen whole tones, besides semi-tones, to be effected by shortening the strings by fingering, I had now a fair field open for my calculations. So I conceived a musical instrument of sixteen strings similar to the guitar, which would require no shortening of the strings by fingering, but which could be played straight ahead, each string representing a different note, like the harp. Now, all my stock-in-trade in mathematical science was a knowledge of the properties of the right-angled triangle, which, connected with the rule of proportion known as the Rule of Three in arithmetic, seemed like a magic key to unlock the mysteries connected with geometry and trigonometry." He then dwells on the properties of the right-angled triangle. The especial property is the discovery imputed to Pythagoras. This he expects is of "greater value than any other axiom in mathematics." He simplifies "this simple axiom, and if you want it any plainer, the only way is to set your own brains to work." With his Minstrel (the musical instrument) he has plenty of amusement. "I would be so absorbed in calculating and committing the numbers arrived at to memory as to be quite unconscious I had lost my sight. The outer world was invisible, but the inner world of the spirit was transparent." He then comes to his main point, viz., the true mode of obtaining the distances of remote objects by observation. "My mind must have been occupied on this theorem for five or six years, and it was not until a year after the recovery of the sight of one eye that I discovered the principle. At length it came to my mind like a flash of lightning, first to find the correspondence of the circle to the square; and then to obtain the distance by the proportion of the paralax (*sic*) to the length of the square for a divisor, and the length of the base line measured or obtained as the multiplier. . . . The principle itself is perfect, and the approximation to perfection in its application depends altogether on the comparative perfection of the instrument used and of the observations made."

There are two diagrams and long descriptions. We have preferred to let our author speak for himself, and so to show that if he is not affected with the *morbus cyclometricus*, the diagnosis points to a disease nearly allied to it. Further, we have hardly dared to discuss the pamphlet in other fashion on account of the paragraphs on p. 12, prefaced with the remark, "But what is to come will startle you." "I have been receiving from

my honoured father in the Spirit Realm, John Pine, senior, some two dozen essays on philosophical subjects. He was giving his views on religion in very forcible language, and thinking I was becoming too excited, he made a sudden change to trigonometry, and then referred to his diagrams, and the importance of my discovery in mathematics; and that it was my duty to lay it before the world. I said it seemed to me very complete for terrestrial observations, but I was not aware that it would apply to astronomy. He remarked that it was equally applicable to astronomical as terrestrial observations; and he insisted that I should continue my researches on the subject. I have taken his advice, and have continued my mental researches; and shall now present them for public scrutiny." His father further states: "Two years ago, or more, when you used to be showing them to —, I was with you all the time when you were studying on the subject, and am better acquainted with the diagrams than you are yourself." With the announcement of this "Imp-primatur" we close our notice of this singular farrago.

*Notes on Forestry.* By C. F. Amery, Deputy Conservator, N.W. Provinces, India. Pp. 119. (London: Trübner and Co.)

THIS is a little book written by a forest officer for the benefit of those Englishmen who, having been trained in the schools of forestry in France and Germany, require a convenient handbook written in their mother tongue to guide them in their future operations in forest work. Bulky books in the languages of the two countries just alluded to already exist, but these, as the author says, deal so largely in details that the student has frequently to wade through a great mass of matter before he can get a clear view of the individual facts he is specially in search of, or of the broad general principles which govern forest administration. Considering the number of educated and intelligent men now employed in the Forest Department of India, we might suppose that some would be tempted to record their experience for the benefit of those who may be working in the same cause. Dr. Brandis's "Forest Flora" is the first trustworthy work devoted to the scientific and economic aspects of the Indian forests, but besides a knowledge of the trees themselves the practical forester requires to know more than a little about the planting and thinning of trees, the transport and measurement of timber, &c., and it is upon these matters that Mr. Amery's "Notes" deal. He points out that Nature's method to foster the growth of the young seedlings is to allow the admission of sufficient light and air. The practice prevailing in Germany is to thin out the young plants at first only lightly to assist germination, then to admit more light to encourage healthy development. "The period between the first thinning and final clearing varies from ten to thirty years. On the plains of India, such is the rapid growth of some of the trees in their earlier stages as compared with the rate of growth in Europe, that it will probably not be desirable to extend the period beyond two or three years; but this difference of conditions does not affect the principle, which is the admission of as much light and no more than is necessary to the well-being of the young crop at every stage." The seedlings of some of the finest timber trees are of so delicate a nature that they have not power to struggle through any kind of undergrowth, even through rank grass: to overcome these difficulties it is recommended that in ordinary grass land the sods should be removed and inverted grass to grass, and the seeds sown on the inverted sod, which should be from five to six inches thick. The advantages of this system are, that the seedling plants are elevated a few inches above the surrounding soil, so that they have no foes to contend with in the early stages of their growth. From these remarks it will be seen that the book is entirely practical, and will, we have no doubt, be consulted by young foresters.

J. R. J.

*Nebraska; its Advantages, Resources, and Drawbacks.* Illustrated. By Edwin A. Curley. (London: Sampson Low and Co., 1875.)

MR. CURLEY acted as the Special Commissioner of the *Field* to the emigrant fields of N. America, and the present work appeared originally, we believe, as a series of papers in that journal. Mr. Curley has evidently done his work as Commissioner thoroughly, and the present volume is an almost exhaustive account of Nebraska from an emigrant point of view, and we would strongly recommend all intending emigrants to study it carefully. The author sets forth with perfect impartiality all the advantages and disadvantages of Nebraska as a field for emigration, with the result that for those who can command a small capital, and are able and willing to do the necessary work, there is every chance of success. Mr. Curley describes the Geography of Nebraska, and has two chapters of statistics. There is a chapter on the Climate, two chapters on the Surface Geology, and one on the Wild Fruits of Nebraska, by Prof. Aughey. In a series of chapters the author describes in considerable detail the principal districts of the State, and has chapters on Timber and Fuel, the Pastoral Capacities of the State, Co-operative Colonisation, and Land. Indeed, the work seems to contain answers to every inquiry that an emigrant is likely to make, down even to routes, steamship lines, and fares. It is illustrated with many well-executed woodcuts, lithographs, maps, and plans; and even those who have no intention of emigrating will find it pleasant and instructive reading.

*A Series of Twelve Maps for Map-Drawing and Examination.* By Charles Bird, B.A., F.R.A.S., Science Master in Bradford Grammar School. (London: Stanford, 1875.)

THE twelve maps are Europe, Asia, Africa, North and South America, England, Scotland, Ireland, France, Germany, India, and Australia. They are simple outlines, showing the courses of the chief rivers, the run of the mountains indicated by black lines, and the situation of the principal lakes. The maps, instead of names, are covered with a large number of figures which refer to a copious index at the end. The intention is, that after the student has become thoroughly familiar with the situations of the principal mountains, rivers, towns, and other features of a country, his knowledge should be tested by his being required to fill in, in these or similar skeleton maps, the names corresponding to the figures furnished or pointed out by the teacher. It is also intended to provide a handy method for drawing maps. We believe that if judiciously used, the method here indicated will be of good service for both purposes. The maps are well drawn, and, so far as we have tested them, accurately constructed.

#### LETTERS TO THE EDITOR

[The Editor does not hold himself responsible for opinions expressed by his correspondents. Neither can he undertake to return, or to correspond with the writers of, rejected manuscripts. No notice is taken of anonymous communications.]

##### Observation of Cirrus Cloud

I HAVE just received from the Meteorological Observatory at Upsal, Sweden, a number of blank forms (with instructions in English) for observations of the directions of the cirrus cloud. Copies of these forms I shall have much pleasure in supplying to anyone who may be willing to make observations of these clouds, the systematic and extensive observation of which is, as you pointed out in a recent number of NATURE, of such importance in numerous meteorological inquiries.

ALEXANDER BUCHAN, Secretary

Scottish Meteorological Society, Edinburgh, Nov. 2

##### Mr. Mallet's Paper on Prismatic Basalt

In a paper published in the *Geological Magazine* for September last, and entitled "Note on Mr. R. Mallet on the Prismatic

Structure of Basalt," by Mr. Scrope, that author conceives he has found a refutation of the explanation which I have given of the production of the transverse joints in prismatic basalt in my paper on the subject published in the *Philosophical Magazine* for August and September 1875, and Proc. R. S. 158, 1875. For this he appeals to the features presented by the transverse joints in a group of three prisms stated to be from the Giant's Causeway, existing in the hall of the Geological Society of London. In one of these three prisms it is stated that the convex surfaces of the two top joints point in opposite directions, so that the upper articulation "is found to be biconcave in the fashion of a double concave lens. In another of the prisms the convex surfaces of the joints point downwards, while in the third the convex surfaces point upwards."

I will assume that these three prisms occupy the same relative position with respect to each other vertically that they did when *in situ*, and that Mr. Scrope's description of the jointing is exact, which, however, is not the case; e.g., the top surfaces of the three prisms are not alternately concave and convex, but all are concave, though in different degrees. The entire length of the prisms referred to is about 4½ feet, and the group must have been taken from a mass cooled both from above and below. The phenomena presented by the joints of these prisms do not conflict with the views which I have enunciated. The prisms referred to have come from some portion of the original mass in which occurred the dividing plane between that part cooled from the top and that cooled from the bottom, as is proved by the existence in one of the columns of a joint having surfaces curved in opposite directions; such plane, in fact, passing transversely through the articulation said to be in the form of a double concave lens. Other adjacent prisms may have their joints, within a limited vertical height above or below this plane, either convex upwards or downwards, for the slightest differences in the conductivity or in the conditions and rates of cooling, will suffice either to depress or to elevate in them, by a greater or less degree, the plane already spoken of. It is also not difficult to see that several alternations in the directions of the concave and convex surfaces may occur in the neighbourhood of the meeting plane of cooling in opposite directions, where, as in the case of other divergent or opposite heat waves, more or less confusion in normal structure must occur.

I have not examined the group myself, nor should I care to appeal to such fragments either in refutation or support of any theory. Mr. Scrope's imaginary refutation appears to resolve itself into a confirmation of the exactness of my views, and is the product of his imperfect grasp of the physical conditions involved in the question which he undertakes to discuss. That Mr. Scrope has got but a very incomplete grasp of my views as to the production of the cross-joints in prismatic basalt, is evident from the inaccurate language in which he professes to describe that portion to which he refers, as may be seen by those who take interest enough in the subject to compare his note with my paper (*Philosophical Magazine* for August and September 1875), and more especially from p. 134 to p. 205.

Oct. 18

ROBT. MALLET

#### Plagiarism

MAY I ask you to allow me a very small portion of your space to anticipate a charge of plagiarism which might otherwise be made against my work on Cave-hunting, by the readers of the article in the *Leisure Hour*, entitled "The Early Geography of the British Islands, by Henry Walker, F.G.S., July 1874," which I now see for the first time.

In this article there is a map (p. 423) so exactly like my own that it is obvious that one is copied from the other, and it might be believed (it has been suggested) that mine was taken without acknowledgment from Mr. Walker, since his was published in July, and mine in October, 1874.

The facts are as follows:—In October 1871 I published a map in the *Popular Science Review*, and this is reproduced, with certain details left out, by Mr. Walker, without allusion to my previous publication. I reprinted my map of 1871 in "Cave-hunting."

Now, I would willingly and heartily allow any map of mine, in which the labours of others are combined with my own, to be used by others without acknowledgment; but that in consequence of this I should be open to the charge of plagiarism, as in this case, I do not feel justified in letting pass without a word as to the facts.

W. BOYD DAWKINS

City of Melbourne s.s., off San Francisco, Sept. 16

The Internal Heat of the Earth

ON looking over the account, contained in vol. xii. p. 545, of Prof. Mohr's interesting observations on the internal heat of the earth, I found that, according to the law which seems to prevail between the depths of 700 and 3,390 feet, there will cease to be any increase at all in the temperature exactly at the depth of one English mile, or 5,280 feet.

The reason of the discrepancy between this result and that previously given, is to be found in the last entry in your table, where only the upper part of the stratum between the depths of 3,300 and 3,500 feet, is taken, instead of the whole 200 feet, as in the other strata.

The following continuation of the table will make this evident :—

Depth.	Increase per 100 feet.
3300 to 3500 feet ... ..	0'445" R.
3500 " 3700 " ... ..	0'395 " "
3700 " 3900 " ... ..	0'345 " "
3900 " 4100 " ... ..	0'295 " "
4100 " 4300 " ... ..	0'245 " "
4300 " 4500 " ... ..	0'195 " "
4500 " 4700 " ... ..	0'145 " "
4700 " 4900 " ... ..	0'095 " "
4900 " 5100 " ... ..	0'045 " "
5100 " 5280 " ... ..	0' " "

By adding the various increments of temperature below the depth of 3,390 feet to the temperature there observed of 36'756° R., we obtain 40'81° R., or 123'82° F. as the maximum temperature.

To temperature at	=	36'756° R.
Add at 3390 feet		
" 3400 " ... ..	0'044 " "	
" 3500 " ... ..	0'445 " "	
" 3700 " ... ..	0'790 " "	
" 3900 " ... ..	0'690 " "	
" 4100 " ... ..	0'590 " "	
" 4300 " ... ..	0'490 " "	
" 4500 " ... ..	0'390 " "	
" 4700 " ... ..	0'290 " "	
" 4900 " ... ..	0'190 " "	
" 5100 " ... ..	0'090 " "	
Between 5100 and 5280	0'045 " "	

40'810

There is a further remark called for by the manner of filling up the gap above 700 feet. If we compare the increment given for the stratum between 600 and 700 feet, namely 1'10, with that of the next stratum, namely, 1'097, we get a difference of only 0'003 instead of 0'05, as in all other parts of the table. It would be more in accordance with the lower part of the table if we could proceed thus :—

Depth.	Increase per 100 feet.
Above 100 feet ... ..	1'30"
100 to 300 " ... ..	1'25 "
300 " 500 " ... ..	1'20 "
500 " 700 " ... ..	1'15 "
700 " 900 " ... ..	1'097 = 1'10 nearly.

Whether the facts observed will warrant such an extension of the table is a question into which I forbear to enter.

Bradford, Oct. 27

JOHN WILLIS

OUR ASTRONOMICAL COLUMN

40 ERIDANI.—Prof. Winnecke measured, in addition to the well-known distant companion of this star, which is affected with nearly the same large proper motion, two small stars which he calls D and E. It would be interesting to ascertain if these stars are fixed, or if they also follow the principal one in its rapid motion through space, and measures taken during the present season may be expected to decide the point.

The results obtained in 1864 are :—

A D 1864.842	Position 185°04	Distance 75'85
A E " " "	312'48	" 89'45

If we adopt Mädler's proper motions for 40 Eridani, from the Dorpat Observations vol. xiv., or - 2''188 in R.A. and

- 3''470 in declination, we find for 1875, Nov. 15, if D and E are fixed—

A D ..	Position 155'2	Distance 4'1
A E ...	" 336'9	" 107'3

Sir John Herschel had probably in view the physical connection of D and E with their bright neighbour when he suggested that at least a diagram of the relative situation of the small stars near it should be made.

The *comes* B which partakes of the large proper motion of A is itself a close double-star,  $\Pi$ . 80 of Sir W. Herschel and  $\Sigma$  518, and Struve first notified its probable binary nature. Dawes refers to the difficulty attending measures in 1851, but the list of epochs is decisive as to rapid orbital motion. We have for comparison—

Herschel 1783'08	Position 326'7	Distance 4-8
Struve 1825'12	" 287'7	" "
O. Struve 1850'94	" 160'2	" 3'93
Dawes 1851'06	" 160'0	" 13 ±
O. Struve 1851'50	" 160'2	" 3'85
Winnecke 1864'85	" 147'6	" 4'46

Dawes estimated the magnitudes of the components 10½ and 11, but there is a suspicion of variability of the smaller one.

PROPER MOTION OF  $\alpha^3$  CENTAURI.—The values given in our catalogues for the proper motion of this star in declination are not so accordant as might be expected if only the more reliable or modern observations are used. Thus the Cape General Catalogue has + 0''83, the Melbourne General Catalogue + 0''49.

Perhaps as reliable a figure as any that can be derived from data so far published will be obtained by comparing the declination of the Melbourne Catalogue with that given by the Astronomer Royal's reduction of the observations of the Rev. Fearon Fallows at the Royal Observatory, Cape of Good Hope, 1829-31. With Prof. Peters' elements for precession, this comparison gives + 0''4399. If we similarly compare with Johnson's observations at St. Helena, we find + 0''4867. Probably La Caille's declination has been used in working up the adopted Cape value, as on comparing it with the Melbourne declination for 1870, we should have for the proper motion, + 0''723.

For proper motion in right ascension, the comparison of Fallows and Melbourne General Catalogue gives - 0'5235s., and the substitution of Johnson for Fallows alters this to - 0'5462s.

THE "ASTRONOMISCHE NACHRICHTEN."—A General Register of the contents of this publication, so indispensable to every practical astronomer, from vols. lxi. to lxxx., by Dr. C. F. W. Peters, is announced (Mauke, Leipzig).

The last number contains the Washington observations of the satellites of Uranus and Neptune during the first five months of the present year, with numerous measures of the position of the companion of Sirius in the years 1873-75; also, remarks by Prof. Asaph Hall on the determination of the mass of Mars from perturbations of the minor planets, in which Massalia, Echo, Beatrix, and Peitho are mentioned as the planets best adapted for this purpose. Magnifying powers of 610 and 890 were generally used for the satellite-observations, but on a few occasions one of 1,290 was employed; the companion of Sirius was generally measured with 400, all the observations being taken with illuminated wires in a dark field.—The death of Dr. August Reslhuber, so long director of the Observatory at Kremsmünster, is announced.

A NEW PALMISTRY

DR. ALEXANDER ECKER, the well-known authority on matters prehistorical, as well as Professor of Comparative Anatomy in Freiburg, Baden, contributes to

a recent number of the periodical, of which he is a joint editor, a most suggestive paper, entitled "Some Remarks upon a Fluctuating Character in the Human Hand."\* As the line of research is somewhat uncommon, and may, for aught we know, be productive of important results, the substance of Prof. Ecker's paper is here presented to English readers in an abridged form.

Henle, in his work on Anatomy, has made the observation that people have very vague ideas about objects even which are assumed to be well known; e.g. the query is often put, How many feet has a crab? or, How many toes has a cat?—questions which receive most varying answers even in well-informed and educated circles.

If, then, the question be put in the company of half a dozen people, which finger is the longest—the index (forefinger) or the "ring" (fourth) finger?—the query can but seldom be answered before the members in question have been looked at. It seems, further, very probable that the authors of well-known anatomical works have laid down as being the rule that which they have observed on their own hands, so that we are enabled to tell in what respect, as to digital arrangement, such and such *savant* is endowed. For instance—Weber says that the "ring" finger is only slightly shorter than the index; Carus holds that the latter digit is shorter than the ring finger; Henle is of the same opinion; while, according to Hyrtl, it is the index which comes next to the middle finger (the longest) in length; and Langer, lastly, says that the index is generally shorter than the "ring" finger, but that there are individuals in whom they are nearly of the same length.

Have these variations a morphological significance or not? For the solution of this, answers to the following questions are necessary:—

(a) How are the animals which come next after man, in other words, the apes, and especially the anthropomorphic apes,† off in this particular?

(β) What is the case with the lower races of mankind in the same particular?

(γ) What is the most usual digital arrangement in this respect among the European races of man? and lastly,

(δ) Which proportion of the two digits in question has been accepted as the most beautiful and symmetrical, and either knowingly or unknowingly adopted in art?

1. With regard to the Ape, the index is—and often considerably—shorter than the "ring" finger. The difference in length is much more considerable in the Chimpanzee than in the Gorilla; the greatest difference, that of 20 mm., having been found in the cast of a hand of a male Chimpanzee.

2. Drawings—made by placing the hand upon paper, the axis of the middle digit coinciding with a straight line at right angles to the front or hind margin of the paper, supposing the latter to be a parallelogram, and then following the outline of the fingers with a pencil—were made of twenty-five male and twenty-four female negroes, with the following result:—

(a) Among the males twenty-four had the "ring" finger longest, the average difference being 8 mm., while in the remaining instance both fingers were of the same length.

(b) Out of the females the "ring" finger was longest in fifteen, the difference varying from 2 to 14 mm.; in three the fingers were of the same length; while in six the index was the longer, the difference being from 2 to 6 mm.

Prof. Ecker has further found the "ring" finger longest in casts and in several photographs of the hands of negroes; but in the hand of a "Turco" negro the index was the longer of the two digits. In photographs of a Hottentot and of an Australian female, the "ring" finger was the longer, while in a photograph of a female Sandwich Islander the reverse was the case.

\* "Einige Bemerkungen über einen schwankenden Character in der Hand des Menschen." *Archiv für Anthropologie*, viii<sup>te</sup> Bd. s. 67.

† Such as the Orang, Gorilla, Chimpanzee, and Gibbons.

3. As for Europeans, no conclusions have as yet been arrived at; but it appears probable that there is a relatively greater length of the index finger in the female than in the male sex; and further, among the latter, in the slight and highly developed, than in the short and underset.

4. Lastly, as regards Art. In that which is left to us of the productions of the ancients, there are variations in the relative length of the two digits, though it appears that the index finger, and especially so in the female, ought to be the longest. In the Dying Gladiator the index (of the left hand supported upon the knee) is the longer; while in the Apollo "Belvedere" (right hand) there is no appreciable difference. In the Venus "Medici,"\* in the Venus "pudica" of the Gallérie Chiaramonti, in Rome, as well as in the Venus by Praxiteles, in the Vatican, the index is obviously the longest. In modern art there seems to be no evidence of rule or canon; among painters, for instance, there being, it appears, no fixed tradition on this point. In Schadow's "Polyklet, oder von den Maassen des Menschen nach dem Geschlecht und Alter" (2<sup>te</sup> Aufl. Fol., Berlin, 1867) no rule is laid down. In the extended hand of a powerful man, by Albrecht Dürer, the "ring" finger is the longest.

It is not probable that a difference in the length of the fingers in question is a merely individual, so-called chance (zufällige) variation, for the reason that the whole form of the hand is in relation with this. In the variety of hand termed *elementary*, by Carus ("Ueber Grund und Bedeutung der verschiedenen Formen der Hände in verschiedenen Personen;" 4to., Stuttgart, 1846), the index is shortest; in the *motor* variety the difference is not considerable, the index being slightly the longer; in the *sensible* form the index is longer, but not much so; while in the *intellectual* (seelische) this finger is considerably the longer. The opinion just given is further supported by the fact that in the Mammalia the length of the various digits is very constant.

It may be concluded, then, that—

a. In the Apes as yet examined, the difference being least marked in the Gorilla, the index finger is the shorter.

β. In Negroes, also, the index appears to be the shorter. No sexual difference can as yet be established.

γ. In Europeans the variation is so great that at present no rule can be laid down.

δ. When a great artist has attempted to represent a beautiful and ideally perfect hand, he has never made the index strikingly shorter than the "ring" finger.

May it then not be possible,—

1. That an index relatively longer than the "ring" finger is the attribute of a higher form of beauty? †

2. That here, as in many other particulars, the female form appears to be morphologically the purest?

The longest and least mobile finger is the middle one; the shortest, and most capable of motion, is the thumb, or "pollex;" next in order in the scale of mobility come the little, "ring," and lastly the index, or forefinger.

The question which Prof. Ecker has here raised, and into which he intends to inquire further, may appear to some trivial and unworthy of serious study; but, far from this, the satisfactory solution of it will, there is but little doubt, be of the greatest interest not only to the philosophical anatomist, but also to the sculptor and painter who would fain go a little below the mere surface of his art. It is certainly a subject in which, were they yet alive, such men as Goethe and Winkelmann would take the deepest interest.

JOHN C. GALTON

\* The famous Medician Venus has been said to be a copy by Cleomenes, a son of Apollodorus, of the Venus of Cnidus, by Praxiteles. *Vide* Winckelmann's "Geschichte der Kunst des Alterthums."—J. C. G.

† The hands of the writer are, unfortunately, specimens of the lower type, each index being considerably shorter than the "ring" finger in its same series. It is a curious fact that in each hand the radial artery at its termination, instead of plunging beneath the volar muscles, takes a superficial and somewhat dangerous course as far as the skin web which passes from the pollex to the index. It would be interesting to know whether these phenomena are correlative or not.

## SCIENCE IN GERMANY

(From a German Correspondent.)

HERR NEESEN, assistant to Prof. Helmholtz, has recently published a memoir on the phenomena of attraction and repulsion by light and heat-rays, observed by Mr. Crookes. He states in it that he had already for two years observed such phenomena, which at first seemed to be a case of mechanical action of light-rays, *i.e.* of the effect of their impinging and rebounding on the surface of a mirror suspended by a cocoon-fibre. He now thinks, however, from the experiments he has made, that the effects of light and heat-rays in question are to be regarded as merely produced through air-currents arising from heating of the air in certain parts of the apparatus in which the movements of the mirror take place. Neesen first shows that in the phenomena observed such air-currents have, in fact, influence. He used for his experiments a rectangular case of sheet iron, in the upper cover of which was a peculiar arrangement for hanging a cocoon fibre. In the lower part of one of the sides of the case was a rectangular aperture closed by a plane parallel glass plate, and behind this plate was the suspended mirror. The air-currents above referred to arise not only from the fact that the air in contact with the glass plate through which the light must pass to reach the mirror, or the air in contact with the mirror, is heated. The air-particles also between glass plate and mirror are heated by conduction of the heat; and so, by their heating also, air-currents are produced which tend to turn the mirror.

In favour of Neesen's explanation are the facts (1) that the movements of the mirror always decrease when the air in which it is enclosed is rarefied; and (2) that these movements also become less if adiathermanous substances (*e.g.* a column of water) absorb the light-rays before these can reach the mirror.

The considerations which seem to be against his explanation are the following:—(1) The reversal of the movement, observed by Mr. Crookes, on a certain small air pressure being reached; (2) a fact appearing from Neesen's own experiments, *viz.*, that according as the direction in which the light-rays fell on the mirror was varied, was the direction of rotation of the mirror changed, though the light fell on the same part of the mirror. Both these peculiarities, however, may also be explained by air-currents. First, as regards the fact observed by Neesen, it is clear that, according as the lamp is placed to one side or the other of the mirror, different parts of the glass plate in front are heated, and different parts of the air-layer between glass plate and mirror; and accordingly the currents and the rotation of the mirror must have an opposite direction. To explain the reversal of the motion on a certain low pressure being reached, Neesen calls to mind that the conductivity of air for heat, as Kundt and Warburg have shown, decreases with extraordinary rapidity on decrease of pressure (well observed with low pressures); so that with as perfect a vacuum as possible, it entirely disappears, and only radiation of heat remains. Now, as long as the heat is conducted, the air-particles conducting the heat are themselves heated. On the other hand, no such heating takes place when the heat passes only by radiation. That with such very different conditions the currents may be different is probable in a high degree. W.

## MÜLLER ON BEES AND FLOWERS\*

IN this communication Dr. Müller calls attention to the interesting facts presented by various groups of Hymenoptera, in which we find a series of forms presenting more and more complex life relations, accom-

\* "Die Bedeutung der Honigbiene für unsere Blumen," in the *Bienen Zeitung* for July 15.

panied by a higher and higher mental organisation. The consideration of these gradations is calculated to throw much light on the question, "How has the Honey Bee acquired its remarkable instincts?" a question which the study of that species alone would, in his opinion, do little to solve, but on which the habits and organisation of other groups throw much light. The Sawflies (*Tenthredo*) are amongst the lowest of Hymenoptera. They merely choose a plant of the species on which they have themselves lived, cut a hole in the leaf with their curious saw, and deposit therein an egg. The young larvæ ~~then~~ find themselves on their food and live like ordinary caterpillars, which in general appearance they much resemble, and like which they are exposed to destruction by various enemies.

Passing on to the Gall Insects (*Cynips*), we meet with a new mode of life which is very instructive. The incision made in the plant by the Sawfly causes little abnormal growth, while in the case of the *Cynipidæ*, on the contrary, it gives rise to the well-known galls.

Some species, however, pierce not plants, but animals, and have thus opened out for themselves many more possibilities of existence, since there is scarcely any group of insects which is free from these attacks; neither the thick-skinned beetle, nor the active and powerful wasp, nor the wood-boring larvæ of *Cerambyx*, nor even the aquatic larvæ of the *Phryganeæ*.

This passage from phytophagous to carnivorous habits has not only led to the formation of many new species, but also to a greater complexity in the relations of the parents to their young, and to a higher intellectual development, which is shown especially in the arrangements made for the nourishment of the larvæ, since it certainly requires both greater energy and more intelligence to discover and attack a particular species of insect than merely to lay an egg on the plant which has served the mother herself for nourishment. The passage from the gall insects to these insect-piercing species must, in M. Müller's opinion, have been slow and gradual. The genus *Synergus*, which deposits its eggs in the galls of the true gall insects, constitutes, perhaps, a link between the two groups.

On the basis of this increased energy, intelligence, and adaptability, certain groups then made a still further advance by which some of the drawbacks incident to such a mode of life were avoided. For it of course frequently occurs that caterpillars and other insects in which these insect-piercing Hymenoptera have deposited their eggs, are devoured by birds or other enemies. Certain species, however, meet this danger by transporting their victims to a place of security. To effect this, however, certain conditions are necessary. The aggressor must be sufficiently large to overpower his victim, but the latter must not be killed, or it would decay and thus become unsuitable for food. Dr. Müller considers that many insect-boring species have probably endeavoured to secure their prey, but have under these circumstances found it impossible to do so. Thus, the ovipositor of the *Tenthredo* became the sting of the wasp, and thus those species which carried off their victim to a place of concealment would abandon the habit of laying their eggs inside the victim. Dr. Müller expresses the opinion that the various proceedings by which the solitary wasps thus protect their young against contingencies to which the insect-piercing species are liable, must have at first been arrived at with a consciousness of the object to be effected, but that they have gradually become instinctive, and are now unconsciously inherited from generation to generation. Still it is, he observes, impossible to watch a wasp at work without feeling that, with these inherited customs, or so-called instinct, much individual effort also comes into play. Dr. Müller proposes to discuss this interesting part of the subject in detail in a future communication. J. L.



## FAYE ON THE LAWS OF STORMS\*

*Mechanical Identity of Waterspouts and Eddies.*—The question then is reduced to this, viz., whether, when in the middle of the most profound calm these destructive waterspouts are [seen to appear, the form of which corresponds so well to the eddies formed in streams of water, we can point to any current by] which the phenomenon has been originated. Now this is precisely what we intended to set in strong relief in describing the general currents of the atmosphere. The counter-trades clearly show that there exist above our heads unmistakable currents of air in motion. Without even recurring to considerations of this nature, it is enough to cast our eyes over the heavens on the appearance of a waterspout, in order to see by the march of the clouds that in spite of the calm below, powerful horizontal currents prevail aloft, which, as their different parts cannot advance at the same rate, must consequently give rise to whirling movements of a more or less decided character. If one of these whirls meet with the favourable circumstances so often seen in water-streams, it will be regularly developed by taking the form which analysis assigns to it; by its downward movement it will even penetrate through into the calm strata, the resistance of which will gradually alter its form and its course, and end by reaching the ground. This simple notion of the mechanical identity of gyrations, whether of liquids or gases, furnishes at once the explanation of phenomena which meteorologists have laboured to find in an entirely different range of ideas. Waterspouts contain powerful forces in action, because they draw the force from a medium above, where it is in abundance; they march onwards because they follow the current which originates them; at their base they are slightly curved, not forwards but backwards, because the comparatively still medium they traverse offers a certain amount of resistance; they act nevertheless in the same manner both on the ground and over water, whatever be the curvature of the conical tube which descends from the clouds, because this curvature never interferes with the direction of the axis of rotation of each spiral, but only with the succession of these spirals in space, &c.

This identity of waterspouts in air and of eddies in water, which is so complete in a mechanical and geometrical point of view, is no longer to be looked at altogether from the physical standpoint, on account of the differences which in this respect exist between water and gas. Indeed, the temperature of a stream of water is almost the same at all depths; in the air, on the contrary, heat decreases markedly as we rise to the higher strata. Further, the moisture of the air is liable to be condensed for a fall of temperature often very slight. Thence the cold air of the high regions, drawn gradually downward by the whirling movement into the low and moist strata, generates a thin mist all round the waterspout. This mist serves as an outer envelope or sheath, the form of which is more or less sharply marked, being rendered visible by its opacity. There is no doubt that the air in its descent is subjected to an increasing pressure and gradually rises in temperature; but it is lower than the temperature of the surrounding air, and it is enough if it falls to the dew-point of the general mass of air surrounding it in order that the nebulous sheath may be immediately produced. If the difference of the two temperatures is insufficient, or if the humidity is too low in any particular stratum, the misty sheath will not be formed, and the waterspout will in part be invisible. None the less, however, will it be there, though it seem cut in two, or appear only in its upper part in a truncated form. This is the appearance so often presented by waterspouts at their commencement, when the upper and lower portions are seen, but not the intermediate portion. Soon these detached portions meet, the outside sheath

completing itself as the stratum traversed by it becomes slightly more humid, or as the air whirled more rapidly downwards by the waterspout becomes slightly colder than the air it meets.

Just as happens in the case of the water which gradually descends down an eddy in its whirling course, the air, which gradually descends with a violent whirling motion down the waterspout, escapes from it on coming into contact with the ground, and thereafter rises again in an irregular manner outside the waterspout. But the volume of air which enters into ordinary waterspouts is far from being sufficient to give rise, at a distance, to a wind of any appreciable force; it is only in proximity to and immediately around the base of the waterspout, where this irregular upward movement of the air manifests itself by the ascent of the dust or spray already raised by the lower spires of the meteor. The base of the waterspout is then enveloped in a sort of confused cloud ceaselessly renewed, unless the end of the waterspout ceases to reach down to the ground. This is especially the case when a waterspout suddenly meets a valley in its course; its lower end goes on lengthening, and with little delay is again joined with the ground; but if the movement of translation is too rapid, it will not resume its destructive work till it has cleared the valley and gained the opposite higher ground. Thus in gases as in liquids, whirling movements observe exactly the same laws. The idea is simple and clear: let us, then, without hesitation, put it in place of that of an aerial column with boundaries formed doubtless of misty vapour, but really treated as solid and impenetrable like the crystal spheres of antiquity, through which the cloud draws up the water of the sea, trees, and other objects; or, to put it differently, through which a centripetal updraught violently draws skywards sea-water, trees, &c. In accordance to our idea, all becomes clear and simple in the history of waterspouts; with prejudice, on the other hand, all remains astounding, incomprehensible, and contrary to the simplest notions of mechanics. There, are, however, two points of detail yet to be discussed: we have to return to the appearances from which eye-witnesses have drawn such remarkable conclusions, and to the part played by electricity, a force which meteorologists, till quite recently, were always so ready to resort to in the explanation of phenomena.

As the purely physical appearances of waterspouts differ widely from each other, some have failed to observe the slightest trace of an internal movement; others have attributed to them a descending movement without rotation; and lastly, others, and these the most numerous attribute to them a whirling ascending movement. A little reflection easily explains these contradictions. What is seen and what is related by eye-witnesses whose impressions are vitiated by old-standing prejudice, has no reference to the waterspout itself, which, like air, is transparent and invisible, but to its external envelope of mist, which is more or less opaque. The envelope is exterior, we repeat; it does not therefore partake in the internal gyrations, which, moreover, are too rapid to be visible. Only the surrounding air which is brought into contact with the waterspout is rapidly drawn from some distance by lateral communication with the whirling movement, the result of which is a sort of whirling or spiroidal agitation in the outside sheath of the waterspout. The degree in which movements of this sort favour illusion is well known. It is thus that the slight movements of the cilia of rotifers have the appearance of a rapidly revolving wheel, and the simple rotation of a spirally-cut cylinder of glass produces the impression of a flowing stream of water. Further, the air which is thrown out at the base rises again outside the waterspout. The aqueous vapour imperfectly condensed in the outside of the sheath has itself an ascending tendency sufficient to raise some of the small cloudlets of mist found there. Here are the real movements, complex and changing, but slow enough

\* Concluded from vol. xii. p. 538.



to be visible. The illusion of the observer lies in attributing to the interior of the waterspout the movements which really take place round and outside its exterior margin.

The part played by electricity has been thus stated by Peltier, who supposed he had detected traces of this force in the well-known waterspout of Monville. The sheath of vapour is in some sort a continuation of the electrically-charged clouds; it forms a long conductor of about eight hundred feet between the clouds and the ground, a conductor doubtless very imperfect, but on a great scale, and capable of affording to some extent a passage to the electricity. It is, however, far from being comparable with the destructive characteristics of the thunderbolt. The way in which trees overturned by whirlwinds are sometimes broken up has been recognised as resembling more or less that of trees struck by lightning and shattered into splinters; but this effect is only the result of the violent torsion exerted by the gyratory movement of the whirlwind, and not of the sudden passage of an electrical current. Men and animals have often been caught by whirlwinds and injured, without ever experiencing the least electrical shock.

Thus the essential characteristic of these remarkable movements which produce waterspouts or great tornadoes is a circular gyration, the spirals being slightly inclined to the horizon. Wherever you make a section of it, you only find there concentric circles with the radii always converging towards a centre. In representing them geometrically you need not hesitate between the circular diagrams of Reid, Redfield, and Piddington, and the diagrams with converging rays of some learned meteorologists, the victims of a hypothesis and old prejudice. The former diagrams reproduce the mechanical phenomenon in its essentials; the latter answer to a mere illusion which a little reflection should ages since have exploded.

*Extension of this Identity to Cyclones.*—The last step only remains to extend these conclusions to great tornadoes, that is, typhoons, and lastly to cyclones, which often overspread a vast extent of territory. It is one of the characteristic properties of the eddies generated in currents of water, that they are formed on every scale, even the largest, without undergoing any essential change. Eddies may be a few inches in diameter, a few yards, a few furlongs, or even of still larger dimensions; it is the breadth of the currents where they are generated which alone limits their size. In the ocean there are gyrations on a still vaster scale, or even on a scale altogether colossal, such as the vast currents of the Atlantic which circle round the calm region of the Sargasso Sea. The sun presents the phenomena of whirling movements still better defined and of all dimensions, from large openings equalling our cyclones, even to those large spots which are five or six times greater than the earth itself. In like manner, in the whirling movements of our atmosphere are found small, short-lived eddies of a few feet in diameter, whirlwinds and waterspouts, which last longer, from 10 to 200 yards across, and tornadoes from about  $\frac{1}{3}$  to  $1\frac{1}{2}$  mile in diameter. Beyond this the eye cannot take in the forms of the whirling columns; these receive another name, but in all essential points they remain the same. When the dimensions are still greater, the diameters measuring 300 miles and upwards, they bear the name of hurricanes or cyclones; but notwithstanding this, their mechanism remains unchanged. They are always gyratory, circular movements increasing in velocity as they near the centre; are generated in the upper currents of the atmosphere, through the inequalities of their velocities; are propagated downwards through the lower strata in spite of the calm or independently of the winds which there prevail; ply their destructive energy when they reach the obstacle offered by the ground; and follow in their march the upper currents, so

that the track of their devastations marks out on the surface of the globe the route of the viewless currents of the upper regions of the atmosphere.

There is, however, a difference between whirlwinds and tornadoes on the one hand, and typhoons and hurricanes on the other. As regards the former, note in the first place, the upper portion (*embouchure*), which is a sort of truncated cone inverted and very much widened out above, and in the second place the descending column which prolongs the meteor even to the ground. If the atmosphere was a gaseous mass of air of indefinite height like that of the sun, cyclones would always present these two features. As regards cyclones, however, the ground is very near in proportion to the extent of area they cover, and is reached before they can be subjected to the prolonged contracting process seen in waterspouts and whirlwinds. A cyclone is then a vast whirlwind, but reduced by the obstacle offered by the ground, to the upper part, or to what may be called the funnel-shaped portion of the phenomenon strictly so called. Thence, doubtless, the constant presence in the former of a calm space about the centre, of which the analogue is to be found only in the circling movements of the ocean on their grandest scale; and thence also certain important peculiarities of cyclones to be more particularly insisted on, after having examined the movements of translation of these phenomena.

*Course of the Upper Trade Winds.*—When the attention is directed to whirlwinds which appear most frequently to be accidental phenomena of short duration and merely superadded to other phenomena of a more general character and much more lasting, it must be allowed that the short lines marking out their course have scarcely been studied from a geographical point of view. These lines probably follow no simple law. In this respect it is otherwise with cyclones; their course recurves, as we saw at the beginning of these articles, on the globe in accordance with a particular law the constancy of which Fig. 2 (vol. xii. p. 402) reveals at a glance. From this chart, the upper currents, whence cyclones derive their origin and mechanical power, do not proceed directly from the equator to the poles. They are deflected at the outset toward the west, then toward the east, thus describing over the surface of the globe parabolic curves whose apices lie somewhere within a few degrees of the polar limits of the surface trade-winds. Clearly these upper currents, which are true aerial rivers, ought to form a part of the upper trades whose existence is assumed, but their actual course is not directly known. If this assumption be correct, then Fig. 2 presents at once the projections of the double system of trades and counter-trades over both hemispheres; and it only remains to explain the singular recurring course taken by the upper trades. This explanation we shall attempt, though the question lies a little out of our way.

If the atmosphere were withdrawn from the influence of the solar heat, it would remain in equilibrium; its successive strata would arrange themselves according to surfaces of level, and would become part and parcel, so to speak, of the solid globe itself; at least it would, even as regards the highest strata, exactly follow the earth's rotation. The effect of the solar heat is constantly to disturb this equilibrium, by the introduction of movements which are the more curious inasmuch as they do not essentially destroy the normal stratification of the strata of the atmosphere. The air incumbent over the hemisphere actually facing the sun is expanded in its lower strata, where the opacity arising from dust floating in the air, and above all the aqueous vapour, absorbs a large part of the heat-rays of the sun. The intervention of this aqueous vapour which ascends vertically from stratum to stratum, has in a special manner the effect even of rendering the diurnal variation of temperature perceptible at heights at which it would not be felt if the air was dry. The maximum of

this general dilatation in the torrid zone takes place under the vertical rays of the sun. In this manner the centre of gravity of the lower strata rises vertically; these raise the strata above them, which being specifically lighter, dry and transparent, are consequently less sensitive to the sun's rays. All the strata in succession, thus thrust upward above their surface of normal height, tend to flow with accelerated motion along these surfaces in the direction of the two poles, where the temperature is relatively low. This effect is still further increased by the peculiar march of the aqueous vapour which is principally condensed about the poles, whence it returns to the equator by another way than that of the atmosphere, viz., along the surface of the earth in the liquid state.

The atmosphere cannot exactly follow the diurnal rotation. A half of its mass, or from about 30° lat. S. to 35° lat. N., lags somewhat behind, since all the molecules in this region being thrust upward describe circles continually increasing in size with the linear velocity from the lower level from which they started in their ascent. To this retardation must be superadded that of the surface trades resulting from their general flow towards the equatorial region. Beyond the tropics, on the contrary, in the temperate zones where the air advances into parallels of latitude continually diminishing in size, the other half of the atmosphere flows in advance of the earth's rotation. Towards the polar circles this advance is converted into a circling movement round the two poles from west to east.

The unequal distribution of land and water over the globe modifies this general aerial current, so that it does not flow on in one current, but is broken up into many currents—the equalities of the surface throwing the current of the counter-trades into several currents more or less distinct from each other. We can easily imagine the behaviour of the counter-trades by combining their march toward the poles with the two opposite transverse tendencies of which we are about to speak. Between the tropics, the resulting currents do not blow straight to the equator, but wear round more toward a westerly direction. Beyond the tropics, they do not blow directly toward the poles, but take a course inclined more to eastward. The two following figures will explain our meaning:—

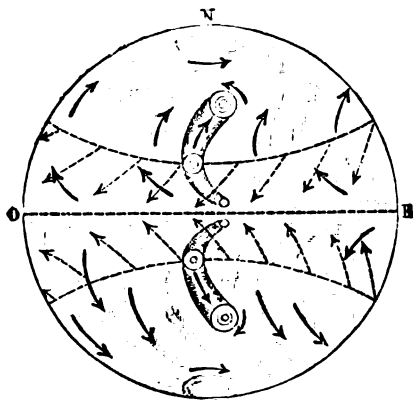

FIG. 13.

Fig. 13 represents the whole upper currents for both hemispheres on a projection of the meridian; and Fig. 14 for the northern hemisphere on a projection of the equator. The dotted arrows mark the surface counter-currents; in other words, the trade-winds blowing obliquely towards the equator, making nearly a right angle with the upper trades of the torrid zone. A slow whirling movement may also be seen around both poles resulting from the counter-trades. These really exist, for the meteorologists of the United States have recently

described them under the name, a little fanciful, perhaps, of polar cyclones.

The aerial rivers which are marked out in the midst of these great movements, by which the equilibrium, incessantly disturbed, tends constantly to re-establish itself, exhibit then precisely the course which we have recognised as a peculiarity of the trajectories of cyclones, whilst the surface-trades have no relation to these same curves showing the courses of cyclones. This agreement is a further proof that cyclones must have their origin in the upper

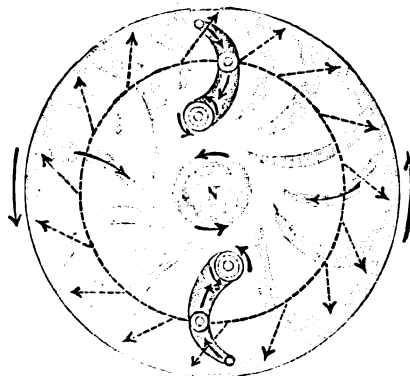

FIG. 14.

regions of the atmosphere, and thence descend even to the ground, and in doing so traverse strata of air either calm or in motion, in such a way as to be totally independent of the cyclone—a state of things incomprehensible on any other hypothesis that has yet been advanced. As to the direction of rotation of cyclones, it results from it that, in these currents strongly recurved, the velocity goes on diminishing transversely from the concave side to the convex side. The zone of calms would then no longer accord with the phenomena of an ascending up-draught, but with a maximum of dilatation to the right and to the left of the place where the movement toward the poles commences. Lastly, the mean velocity of these currents, feeble at first in the neighbourhood of the equator, would go on accelerating just as the velocity of translation of our cyclones.

*Segmentation of Cyclones.*—Whatever may be thought of these opinions regarding the march of the upper trades, of which the surface-trades are the counterpart, it is impossible to doubt that cyclones take their origin from these currents. Let us then look more closely at these gyratory movements. If the maximum height of these trades be from 33,000 to 40,000 feet, and the lower diameter of the gyratory movements, or cyclones, where they meet the ground, from 120 to 180 nautical miles, it will be seen that cyclones must have a figure very different from waterspouts and tornadoes, whose proportions are altogether different, since the height of these last is enormously disproportioned to their lower diameter. Piddington was therefore right in comparing cyclones to mere whirling discs. It would however be more correct to regard them as waterspouts reduced to their upper funnel-shaped portion, or deprived of their slightly conical column, which descends even to the ground. As it advances, the generating current is lowered a little; the vertical height of the cyclone is thereby as much diminished, its section enlarges by contact with the ground, and the disc becomes even more flattened out.

This being granted, if any whirling movement encounters resistances, or if the general current exhibits differences of velocity in different places, it is in the upper regions of the atmosphere especially that these disturbing causes will act most powerfully on the phenomenon, because the velocities are there less, and the distances traversed by the currents enormous. Below, on the other

hand, where the column is narrowed to a very great extent, and where the velocity of the gyrations is excessive, the obstacles met with exercising little influence, are instantly reversed or overcome. Waterspouts acting by the lower extremity, at a distance from their funnel-shaped top (*embouchure*), undergo no change; but cyclones will not withstand the forces brought into play so easily.

Let the modifications thus induced by external causes be what they may, the preceding theory shows that they are possible, and that the rigorously circular movement enunciated by the authors of the "Laws of Storms" allows of perturbations more or less local, and more or less marked, for the simple reason that the whirling movements, which in the case of cyclones are reduced to their upper portions and are therefore little more than mere discs, are very easily modified. It is this, moreover, which explains the deviations from the rule that are found in even the earliest writings of the authors of the "Laws of Storms," as, for example, in Fig. 1 (vol. xii. p. 401), representing the Cuba hurricane, where, notwithstanding the general agreement of the arrows showing the wind with the purely circular theory of storms, there also occur several local deviations.

What can these perturbations be? How can a gyratory movement be changed under the influence of a given external cause? What happens if the velocities of the generating current undergo local changes? It would be as difficult to answer these inquiries *a priori* as it would have been to foresee, before the development of the mechanical theory of solid bodies, the astonishing results of an external force brought to bear on them; but the study of other whirling movements more within the reach of observation, and directed to the sun, has shown that a cyclone is not arbitrarily deformed in any manner whatever. Segmentation, or breaking up of the cyclone, is the last term of the alterations which it can undergo. Then the fragments into which it is broken up tend to assume the form of cyclones, each as perfect as the one from which they were formed, and they follow routes differing but little from each other and describing nearly the same trajectory, but at a distance from each other. This segmentation of cyclones occasionally occurs in the case of the thunderstorms which advance on France from the Bay of Biscay, of which the thunderstorm of the 9th of March, 1865, so well described by M. Marié-Davy, may be cited as an example. A like process of segmentation cannot take effect unless the primitive cyclone in some part and for some time deviate from its rigorously circular form. The tendency to keep this form maintains the ascendancy sometimes, but if it begins to give way in a large cyclone, the result is a breaking up of the cyclone itself into segments.

It would be easy to adduce numerous cases in which whirlwinds, tornadoes, and cyclones appear in groups about a given point, or at least follow each other with rapidity. The evidence all goes to show that they are most frequently the result of the phenomenon of *segmentation*, so called from the term used in natural history to designate the process by which some of the lower animals are divided into segments each of which soon becomes a complete animal of itself. But it is in solar cyclones where this mysterious operation can be best followed step by step. Thus a circular sunspot may be seen gradually undergoing the process of deformation, then breaking up into parts, and ending by giving birth to other spots, which precede the original one in a row and at some distance, proceeding at the same pace and reproducing on a small scale the features and behaviour of the primitive type.

#### CONCLUSION.

The laws of storms, the statement of which in absolute terms ignores the modifications we have indicated, are therefore in reality only an approximate enunciation, just as are Kepler's laws, to which we have more than once

compared them. Kepler's laws would be rigorously exact if we could leave out of account the action of the planets on each other and on the sun; but this being impossible, these laws are not an adequate expression of the truth. The same holds good with respect to the laws of storms. They would also be exact if the currents of the atmosphere never exerted any disturbing action, and as the laws take no account of these disturbing actions, and do not give the means of foreseeing them, or at least of measuring their effects, it would be a mistake to apply them blindly in practical affairs.

It was not by substituting the *cassinoide* for Kepler's ellipse that science made progress; in like manner it will not be by the substitution of centripetal diagrams of storms for circular diagrams that navigation will be rendered safer. If we have succeeded in giving the true theoretical interpretation of these laws, it must be granted that the time has not come to abandon them, but rather to make them more complete.

To sum up, there are no centripetal waterspouts, whirlwinds, typhoons, or cyclones. The *moveable* forces of aspiration formed, as is said, over the heated ground of the tropics, do not transport themselves with their accompanying updraught to a distance of 700 or 800 leagues over the cold soil of high latitudes, and they have never determined the whirling movements of our atmosphere. The Laws of Storms are in general accord with the mechanical theory of these movements. The rules of navigation which are deduced from them, merit in ordinary cases the confidence sailors have had in them for the past thirty years. The exceptions should be only regarded as mechanical disturbances of the gyratory movement, the further study of which seems destined to complete a first and happy approximation to the truth. The discovery of the approximate laws of storms is one of the finest scientific conquests of this century, and if a closer approximation is to be made, it will be by a more careful study of solar cyclones.

Formerly whirling movements played an important part in our general conceptions of the universe. Fallen into disrepute by a very natural reaction from a false idea, they have been too much forgotten; therefore when at a later period a gyratory character was recognised in the great movements of the atmosphere, an effort was made with one consent to connect them with totally different causes. Geometricians seemed to class them among those irregular movements of which nothing could be made. We see, however, that movements of the cyclonic order constitute in truth a vast series of regular and stable phenomena, of which their perturbations even exhibit a behaviour in accordance with geometric principles. This series which begins with simple eddies in our streams of water, embrace the most singular as well as the most dreaded phenomena of the atmosphere, together with the vast movements which observation reveals in the sun, and extends even to the nebulae, the structure of which Rosse's telescope has proved to be characterised by whirling movements. It is therefore most desirable that the theory of these movements should be again included in the domain of applied mechanics. The first step to this end is an empirical investigation of their laws, and this work the eminent authors of the "Laws of Storms" accomplished thirty years ago.

#### NOTES

Two members of the British Ornithologists' Union, Messrs. Harvie-Brown and Henry Seebohm, have recently returned from a most successful expedition into Northern Siberia. Leaving this country early in the spring of this year, they arrived at Ust Zylma, on the Petschora River, in the middle of April, after travelling overland from Archangel. They remained there

until the breaking up of the ice in the beginning of June, when they took boat to Alexievka, and made this their head-quarters for some time. Of the most important ornithological acquisitions amongst more than 1,000 skins, are the young in down together with the eggs of the Little Stint and Grey Plover, the eggs (for the first time) of Bewick's Swan, the eggs of *Sylvia middendorffii* and *S. borealis*, the eggs of *Motacilla citreola*, the eggs of the Smew, and a new species of Pipit. These specimens will be exhibited by Mr. Scebohm at the next meeting of the Zoological Society on the 16th instant.

THERE are three professorships in Trinity College, Dublin, which, by the School of Physic Act (40 Geo. III., chap. 84), become vacant at the end of every seventh year from the date of election; but it is also provided that every professor should be capable of re-election. The three professorships are those of Anatomy, of Chemistry, and of Botany. Pursuant to notice in the London and Dublin *Gazettes*, we learn that the latter of these will be vacant on the 23rd of January, 1876, and that on Saturday, the 29th of January, 1876, the Provost and Senior Fellows will proceed to the election. All candidates are required to send their names, with the places of their education, the universities where they have taken their degrees, to the Registrar of Trinity College, Dublin, before the 22nd January, 1876, and for further information are to apply to the Rev. Dr. Haughton, F.R.S., Medical Registrar of the School of Physic. The emoluments of the professor consist of 300*l.* a year, for which he is required to deliver, first, a course of lectures on Botany in the Arts School during each of the three college terms. Michaelmas Term commences early in October, and Trinity Term sometimes lingers on until the month of July. Secondly, a course of not less than forty lectures on Botany in the Medical School, commencing on the 1st of April and ending on the 1st of July in each year. As Curator of the College Herbarium, there is an additional salary of 50*l.* per annum. The professor being his own assistant, the whole work of arranging and sorting this well-known collection, as well as the correspondence incidental to such a charge, falls on the Curator. The fees average, we are informed, a sum of about nine guineas a year, as the lectures are free to all students of the University. The present Professor, Dr. E. Perceval Wright, being eligible, is a candidate for reappointment.

HIS Excellency the Lord Lieutenant of Ireland has been pleased to appoint Dr. John James Charles to the chair of Anatomy in the Queen's College, Cork, vacant by the resignation of Dr. Corbett. Dr. Charles was a pupil in the Queen's College, Belfast, and is a graduate with high honours of the Queen's University in Ireland. For some time he was assistant lecturer to Prof. Wyville Thomson, and for many years he was Prof. Redfern's assistant and demonstrator. Well taught himself, and already a contributor of numerous essays to the medical journals, we anticipate for Dr. Charles every success as a teacher. With Redfern and Cleland as his colleagues, anatomy appears to be well represented in the Queen's Colleges in Ireland.

THE Vienna Academy of Sciences, says *La Nature*, is occupied with a question which concerns all Europe—the decrease of the quantity of water in springs, rivers, and watercourses. A circular, accompanied by a very instructive report, has been addressed to the scientific societies of other countries, inviting them to undertake observations which, in time, may yield useful results. The Academy calls attention to the fact that during a certain number of years there has been observed a diminution in the waters of the Danube and other large rivers, especially since the practice of felling forests has become common. The Austrian Engineers' and Architects' Union are also occupied with this question, and have appointed a Hydrostatic Commission

to collect facts and prepare a report. The Danube, the Elbe, and the Rhine have each been assigned to two members, while two others will be occupied with the meteorology relating to the same subject and with the influence that glaciers and Alpine torrents may exercise on the general result. The Commission considers the question urgent, and recommends the immediate adoption of measures to remedy the evil. According to the *Revue des Eaux et Forêts*, it is unanimous in declaring that the prime cause of the disastrous decrease of the water is the devastation of the forests.

WE are informed that Mr. Gould will shortly issue the first and second part of an important work on the "Birds of New Guinea," which will at the same time form a second supplement to the "Birds of Australia," and will contain illustrations and descriptions of several new species not included in the latter work.

AT a congregation held at Cambridge on Oct. 28, it was resolved to establish a Professorship of Mechanism and Applied Mechanics, with a stipend of 300*l.* a year. There are already three candidates, viz.—Mr. James Stuart, M.A., Fellow of Trinity College; Mr. E. J. Routh, M.A., F.R.S., of St. Peter's College; and the Rev. J. C. Williams-Ellis, of Sidney.

THE Board for superintending non-collegiate students at Cambridge give notice that there will be an examination in certain selected branches of physical science for the award of an exhibition granted by the Worshipful Company of Clothworkers, commencing on Thursday, Jan. 13, 1876, 9 A.M. The exhibition will be one of 50*l.* per annum, tenable for three years by a non-collegiate student of the University of Cambridge. Full information may be obtained from the Censor, Rev. R. B. Somerset.

AN interesting paper on "The Influence of the Sunspot Period upon the Price of Corn" formed the subject of a paper by Prof. W. Stanley Jevons, F.R.S., at the recent meeting of the British Association. After alluding to the attempts made by Mr. Carrington to trace a connection between the price of corn and the variations in the sunspots during portions of the last and present centuries, the Professor said that Mr. Schuster has pointed out that the years of good vintage in Western Europe have occurred at intervals approximating to eleven years, the average length of the principal sunspot period. The elaborate collection of the prices of commodities in all parts of England between the years 1259 and 1400, published in Prof. J. E. T. Rogers' "History of Agriculture and Prices in England," appears to afford the best data for deciding whether the sunspot period influences the price of corn. For this purpose, tables of the average prices per quarter of wheat and other grain, expressed in grains of pure silver, were used. Each series of prices was divided into intervals of eleven years, which were ranged under each other and averaged, so as to give the average of the first, of the second, of the third, &c., years, the commencement of the period being arbitrarily assumed. It is found that the price of each kind of produce examined rises in the first four years, but afterwards falls. It is further shown that the *maxima* prices are found to fall into the tenth, eleventh, first, second, and third years of the assumed eleven-year period. These results are to be looked upon as only preliminary, and need further investigation. It is also pointed out that commercial panics have tended to recur during the last fifty-four years in a distinctly periodic manner. The average length of interval between the principal panics is about 10·8 years, nearly coinciding with 11·11, the length of the solar-spot period. If Prof. Balfour Stewart be right in holding that the sunspot variation depends on the configurations of the planets, it would appear that these configurations are the remote cause of the greatest commercial disasters.

THE death is announced, at the age of seventy-eight years, of Sir John Gardner Wilkinson, F.R.S. He was well known for his successful explorations in Egypt, and his archaeological and geographical publications. In 1852 he was created hon. D.C.L. of Oxford, was corresponding member of the R.I.A. of Vienna and of the Royal Academy of Turin.

DR. LORRAIN, one of the most popular professors of the Paris Medical Faculty, died from apoplexy a few days ago. The Minister of Public Instruction and all the professors of the faculty were present at his funeral. Dr. Lorrain wrote many excellent works on professional subjects, amongst which we may notice "Diagnostic by Pulsation."

THE resignation of M. Wurtz has been tendered once more and accepted by the French Minister of Public Instruction, and M. Vulpian has been appointed to succeed him as Dean of the School of Medicine of Paris.

THE Observatory of Toulouse has purchased a telescope of eighty-five centimetres diameter, and five metres focal distance, at a cost of 1,200*l.* M. Tisserand is head of the Toulouse Observatory.

PETERMANN'S *Mittheilungen* for November contains the following papers:—On Soleillet's and Largeau's travels in the Sahara and to Soudan, by Dr. Gerhard Rohlf's. The continuation of Weyprecht's "Pictures from the High North," in which he describes the formation of the pack-ice, and gives some forcible illustrations of ice-pressure. Under the head of "Most Recent Travels in Australia," accounts are given of Forrest's journey through W. Australia (1874), Lewis's explorations in the north and east of Lake Eyre, with a map (1874-5), Ross's journey in the S.W. of South Australia (1874), and Giles's journey from Fowler Bay to Torrens Lake. A paper, with map, by E. Behm, on the extension of the Egyptian power on the Upper Nile, treats of the results obtained by Baker, Long, Kemp, and Marno.

In the *Bulletin* of the French Geographical Society for October is an itinerary of a journey by the energetic Abbé Desgodins in 1873, from Yerkalo to Tse-Kou, both on the river Lan-Tsang-Kang, in Eastern Tibet. It is accompanied by a map of part of Eastern Tibet to the north of Burmah and Yunnan, containing the courses of many rivers, and the positions of a large number of towns. There is also a paper, with map, by Colonel Long, describing his journey in 1874-5 to the Victoria Nyanza, and the Niam-Niam country. M. E. Boisse describes a visit which he paid in 1874 to Samoa and a few other Pacific islands.

PROFESSORS Nordenakjöld, Lundström, and Stuxberg, who took leave of the Swedish Arctic Expedition at the mouth of the Yenesei River on the 19th of August last, with the intention of returning to Sweden *via* Siberia, arrived at Ekaterinburg on October 29, and were to remain for four days.

THE report of the meeting of the Eastbourne Natural History Society for October 15 contains a paper by Mr. F. C. S. Roper, F.L.S., on the additions to the Fauna and Flora of Eastbourne during 1875.

THE Eighth Annual Exhibition of the Haggerston Entomological Society will take place at the Society's Rooms, 10, Brownlow Street, Dalston, on Thursday and Friday, Nov. 11 and 12, 1875, between the hours of 6 and 11 P.M.

FROM the "Proceedings of the Liverpool Naturalists' Field Club" for 1874-5, we find that the Society continues to do a creditable amount of useful work. Ten field meetings were held last summer, and from the way in which these are conducted, the members are likely to derive much benefit from them. The "Proceedings" contain an admirable address by the President, the Rev. H. H. Higgins, well calculated to stimulate

those who heard it to an earnest study of science. Mr. Higgins has been presented by the Society with a handsome testimonial in acknowledgment of his long and valuable services as president.

FROM the Tenth Report of the Quekett Microscopical Club we learn that the number of members is 530, and that the Club is, in all respects in a prosperous condition.

ANOTHER part of "Figures of Characteristic British Fossils with Descriptive Remarks" has been issued. It will be recollected that Part I. appeared in 1867, II. in 1869, and III. in 1871. These three parts included from the Cambrian to the Devonian forming thirty plates. This new part (IV.) contains plates 31 to 42, and includes "Devonian, Old Red Sandstone, Carboniferous and Permian," completing the Palaeozoic division. In addition to the plates giving figures of fossils and the letter-press description, there are descriptive remarks on groups of fossils with woodcuts of recent and fossil forms for comparison.

WE have just received a copy of the report on deep-sea dredging operations in the Gulf of St. Lawrence, by J. F. Whiteaves, dated Montreal, 1874. The ship used was the Government schooner *J. H. Nickerson*, of seventy tons. Four cruises were made. In the first 14 casts of the dredge were made in 110 to 220 fathoms, in the second 16 hauls in 20 to 70 fathoms, in the third 18 hauls, and the fourth 16, in neither of which is the depth stated. A summary of the zoological results is given, the determinations being mostly by Professors A. E. Verrill and S. J. Smith.

WE would recommend to the notice of those of our readers who are interested in the antiquities of our country, a third revised edition of Mr. Thomas Wright's well-known work, "The Celt, the Roman, and the Saxon" (Triebner). It contains a vast amount of information on the pre-Christian condition of England.

AMONG the subjects on which the Council of the Institute of Civil Engineers invite communications and offer premiums is "The Flow of Fluids, liquid and gaseous."

FROM the "Report" for 1874 of the Cardiff Naturalists' Society, established in 1867, we learn that it is increasing rapidly in numbers and prosperity. During 1874 the Committee tried the experiment of introducing scientific and other lectures, and although monetarily they were a failure, in other respects they were so satisfactory that the Committee recommended their continuance for another year. A large proportion of lectures on important scientific subjects were given, and two field meetings were held. The "Report" contains a Meteorological Report for each month of the year, by Mr. F. G. Evans, F.M.S., and also a table of rainfall observations in the Society's field.

THE following papers by Mr. T. Mellard Reade, C.E., F.G.S., have been reprinted from the Proceedings of the Liverpool Geological Society:—"The Glacial and Post-glacial Deposits of Garston and the surrounding District, with Remarks on the Structure of the Boulder Clay;" and "Speculations on the probable Distribution of Land and Sea during the Deposition of the Marine Boulder Clays and Sands."

WE have received an address by Prof. R. H. Thurston, C.E., delivered to the graduating class of the Stevens Institute of Technology (U.S.) It is entitled "The Mechanical Engineer, his Preparation and his Work," and contains some excellent advice, useful not only to young engineers, but to all who have been trained to other mechanical professions. The Stevens Institute, though what we would call a technical college, affords a good general scientific training, with a fair admixture of literary culture, and the object of Prof. Thurston's address is to show that the more complete is the culture of an engineer, the greater is likely to be his professional success.

THE additions to the Zoological Society's Gardens during the past week include a Rhesus Monkey (*Macacus crythreus*) from India, presented by Mr. R. Roberts; a Macaque Monkey (*Macacus cynomolgus*) from India, presented by Mrs. Gibbs; two Lesser White-throats (*Sylvia sylvicola*), two Yellow Wagtails (*Motacilla flava*), European, presented by Mr. Augustus E. Field; two Central American Agoutis (*Dasyprocta punctata*) from Central America, presented by Mr. W. G. Davis; a Polar Bear (*Ursus maritimus*), Arctic Regions; a Smooth-headed Capuchin (*Cebus monachus*) from S.E. Brazil; a White-throated Capuchin (*Cebus hypoleucus*) from Central America; a Golden Eagle (*Aquila chrysaetus*) from Hudson's Bay; two Maximilian's Aracaris (*Pteroglossus wiedi*) from Brazil, deposited; two Golden Agoutis (*Dasyprocta aguti*), born in the Gardens.

#### ELEVENTH REPORT OF THE COMMITTEE FOR EXPLORING KENT'S CAVERN, DEVONSHIRE\*

THE Committee have again the melancholy duty of reporting that death has deprived them of one of their members. As long ago as 1859, as soon as he became aware of the importance of the discoveries made in the Windmill Hill Cavern at Brixham, Sir Charles Lyell expressed a strong desire that Kent's Cavern should also be systematically and thoroughly explored; and it was with his full concurrence that the proposal to do so was laid before the Committee of the Geological Section of the British Association at Bath in 1864, the day after he delivered his Presidential Address, whilst his ardent advocacy, together with that of the late Prof. Phillips, secured its ready acceptance by the Committee of Recommendations and the General Committee. At the first meeting of the Cavern Committee, appointed in the year just mentioned, he was unanimously elected chairman, and he continued to occupy that post until his lamented decease on Feb. 27, 1875. Though the state of his health prevented him from taking any active part in the exploration, his interest in the work never abated; he always carefully studied the Monthly Reports of Progress sent him by the superintendents, and he made careful arrangements for their preservation.

The Tenth Report, read to the Geological Section of the Association at the Belfast meeting, and printed in the annual volume for last year, brought up the work to the end of July 1874. The exploration has been carried on without interruption from that date to the present time; the mode of excavation adopted at the beginning has been uniformly followed; the superintendents have visited the cavern daily; the progress of the work has been carefully recorded in the cavern diary; and the workmen have, as heretofore, given complete satisfaction; and Monthly Reports have been regularly sent to Sir Charles Lyell until his decease, and subsequently to Mr. John Evans.

The cavern continues to be much visited by persons desirous of studying on the spot its characters and phenomena; and during the last twelve months the superintendents have had the pleasure of taking a large number of visitors through those branches which have been explored, and of explaining to them the mode of operation. Probably a still larger number have been conducted by the "guide," who, though under the control of the committee, is not permitted to take parties to those branches of the cavern in which the exploration is in progress, or has not been begun.

As in former years, rats have frequently been seen running about in various parts of the cavern, including those in which the men have been at work, though hundreds of feet from any glimmering of daylight; and they have displayed their usual boldness as well as their skill in carrying off candles. In other branches, almost as far from the entrances, where all researches have ceased for some years, their footprints are to be seen in great numbers, especially on the silt left, here and there, where the drip is copious in wet weather.

On Jan. 29, 1875, a "buzzing fly" was seen and heard about 300 feet from daylight.

*Clinnick's Gallery*.—The Tenth Report (1874) stated that the exploration of Clinnick's Gallery was in progress, and had been completed for about 34 feet; that below the least ancient, or the Granular, Stalagmitic Floor, for a distance of 18 feet from its entrance, a small quantity of "cave earth" uniformly presented

itself, beneath which lay the Breccia, occasionally separated from it by remnants of the more ancient, or Crystalline, Stalagmitic Floor *in situ*; but that from the point just named, up to that reached when the Tenth Report was drawn, there was no cave earth, so that the two Stalagmites lay the one immediately on the other, with the Breccia, that is, so far as is known, the oldest of the cavern deposits, beneath the whole.

At the commencement of the exploration of this gallery, the deposits so very nearly reached the roof as to induce the belief that a very few feet at most was all that the workmen had before them. As the work advanced, however, the unoccupied interspace between the roof and floor became gradually larger, until on Aug. 6, 1875, John Clinnick, one of the workmen, forced himself through, and, after proceeding about 50 feet by estimation, entered a large chamber, into which he was followed by one of the superintendents. The chamber, probably one of the largest in the cavern, is beautifully hung with Stalactites, and has numerous Stalagmitic "paps," some of them four feet high, and of almost cylindrical form, rising from a floor of the same material.

Clinnick's Gallery, on being excavated, was found to be a somewhat tortuous passage, varying from four to eight feet in width, and from seven to ten feet in height. That it was once a water-course there can be little doubt, as the roof bears the marks of the long-continued action of a running stream. The walls vary considerably, being in some places smooth, in others much fretted or corroded, and in others more or less angular.

The objects of interest found in this branch of the cavern during the last twelve months have been by no means numerous; nevertheless, they are not without considerable interest.

Attached to the upper surface of the Granular Stalagmitic Floor portions of three land-shells were found, and about twenty bones of mammals were met with lying together loose on the floor. Their characters imply a recent introduction into the cavern.

Incorporated in the Granular Stalagmitic Floor itself were a few bones, including a humerus, a tibia, and an ulna, each nearly entire, and a portion of a large humerus, all of which had been gnawed.

Though no cave earth was met with beyond the point already specified, there seems no doubt that to the era of that deposit may be referred a considerable portion of a radius and of an ulna, both gnawed and found under loose pieces of stalagmite.

The remains found in the Breccia were four teeth of bear, a few bones and fragments of bone, and three teeth of lion in three portions of, no doubt, one and the same lower jaw. The latter "find" (No. 6,482) is of considerable interest, as being the first known instance of remains of any animal besides bear met with in the Breccia. Though the superintendents had no doubt of the feline character of the teeth, they forwarded one of them to Mr. G. Busk, F.R.S., a member of the committee, remarking that they believed it to be the last lower left molar of *Felis splava*, and requesting his opinion on it. In his reply, he remarks: "There is no doubt that the tooth is the left lower carnassial of *Felis leo*, but it is of very unusual size, being, I should estimate, one-twelfth bigger than the average dimensions of that tooth in the lion. It is usually longer, but not so thick, in the tiger than in the lion, but the thickness of the present one is proportionate to its length. Another peculiarity, as it seems to me, is the great wear that the tooth has undergone. I fancy existing lions are not allowed to live long enough to wear their teeth so much. At any rate the Kent's Hole tooth appears to be more worn than any other I have as yet met with. Can it belong to *Machairodus*?" Having succeeded in removing some part of the matrix encrusting the other portions of the jaw, they were also forwarded to Mr. Busk, with the observation that the superintendents had carefully considered the question before submitting the first tooth, and had come to the conclusion that the jaw was not that of *Machairodus*, for, waiving the fact that none of the teeth were serrated, the fang of the canine still remaining in the jaw was much too large for a lower canine of any known species of *Machairodus*; and it was suggested that it might be worth considering whether the specimen belonged to any of the species of *Felis* found in the forest-bed of Cromer. To this Mr. Busk replied: "The jaw does not appear to present anything unusual. It is, however, a good example to show that the cave lion lived to a good old age."

The Breccia in Clinnick's Gallery also yielded seven specimens of flint and chert, none of which need detailed description.

The comparative paucity of specimens induced the superintendents to suspend operations in that direction for at least a time. The labour of seven months had been expended on it,

\* Abstract read at the Bristol meeting of the British Association.



during which the exploration of the gallery had reached seventy-five feet from the entrance, where the great chamber discovered by Clinnick may be said to begin.

The following is a complete list of the objects of interest found in this gallery from first to last:—Three shells of *Helix* and about twenty bones of mammals lying on the upper surface of the Granular Stalagmite; a few gnawed bones incorporated within this stalagmite itself; eight teeth of hyæna and two of fox, a tolerable number of bones and fragments of bone, one large chert implement, and one small flint flake, in the cave earth; and ninety teeth of bear and three of lion in portions of a left lower jaw, a large part of a skull, numerous bones and portions of bone, a flint pebble, and eleven specimens of flint and chert implements, flakes, and chips, including the very fine tool, No.  $\frac{1}{6411}$ , in the Breccia.

*The Cave of Inscriptions.*—The chamber in which the Long Arcade terminates has been called "The Cave of Inscriptions," from the number of names, initials, and dates graven on the stalagmite in various parts of it. Besides those on the "Inscribed Boss of Stalagmite" at the entrance of the cave, described in the Tenth Report, inscriptions occur on what is known as the "Hedges Boss" and on the walls of the chamber. There are also a large number of names, &c., smoothened on various parts of the roof, as there are, indeed, in almost every branch of the cavern, some of which appear to be of very considerable antiquity. The oldest of the inscribed dates is 1609, and the most modern 1792, but the most conspicuous and most famous of the inscriptions is "Robert Hedges, of Ireland, Feb. 20, 1688."

It was stated in the Tenth Report that the exploration of this cave had been completed up to sixteen feet from its entrance, when it was suspended in order to proceed with Clinnick's Gallery; that the Granular, or less ancient, Stalagmitic Floor was found to be everywhere intact and continuous, and that the Crystalline, or more ancient, Stalagmite lay beneath it; that the latter had been broken by some natural agency, and though in some cases the severed portions remained *in situ*, in others they had been removed and were not always traceable; that adjacent to the left wall of the cave a wedge-like layer of cave earth lay in its proper place between the stalagmites, and was six inches thick at the wall, but thinned out about a yard from it, beyond which the one floor lay immediately on the other. On resuming the exploration of the cave it was found that the state of the deposits continued to be the same up to thirty-four feet from the entrance, with the single exception that the broken blocks of crystalline stalagmite were never dislodged beyond being faulted to the extent of two or three inches. At and beyond the point just specified, traces of the earlier explorers were again met with in almost every part of the cave, but were found to be limited to the breaking up of the stalagmites and the subjacent deposit to the depth of twelve inches at most. A thin layer of typical cave earth extended throughout the entire chamber, and it was obvious that at the time when the deposition of the cave earth commenced the crystalline stalagmite did not exist as a continuous sheet, for in considerable spaces the cave-earth lay immediately on the breccia without any stalagmite between them, and it was not always easy to determine the exact junction of the two deposits. On the discovery of objects of interest at or near this doubtful junction, care was taken to record them as belonging to the "cave earth and breccia," even though, from their own characters, it was usually easy to refer them to their proper deposits and eras respectively.

The Cave of Inscriptions was found to extend upwards of sixty feet from north-east to south-west, forty-five feet from south-east to north-west, and to be upwards of twenty feet high.

Two "finds" only were met with in the Granular Stalagmitic Floor; one consisting of a few bones, including a portion of a large humerus, whilst the other was a very small bone, probably of bat, with bits of charcoal and of coprolite, all lodged in the same hand specimen.

The cave earth yielded four teeth of hyæna, a few gnawed bones, coprolites on several occasions, and one flint flake.

At and near the junction of the cave earth and breccia, where they were not separated by stalagmite, two right lower jaws and four loose teeth of hyæna, thirty-eight teeth of bear, part of a jaw of fox, one incisor tooth of a small rodent, numerous bones and fragments of bone, a somewhat large number of coprolites, and one flint flake were met with. At least most of the ursine remains may be safely referred to the breccia, whilst all those of

hyæna undoubtedly belong to the cave earth. One of the hyæna jaws just mentioned contains all its teeth except the inner incisor, but, as is commonly the case with lower jaws of the cave earth, it has lost its lower border and condyles, and is much gnawed. The other jaw of hyæna has lost the two inner incisor teeth and the condyles, and is slightly gnawed, but is otherwise entire.

There were found in the Breccia eighty-two teeth of bear—some of them in jaws or parts of jaws—two of lion, in a portion of right upper jaw, numerous bones and pieces of bone, including part of a skull and several other good specimens, and thirteen implements, flakes, and chips of flint and chert. The lion's teeth (No. 6,518) are the last two molars. The sockets of the canine tooth and of the small tooth immediately behind it still exist, and everything betokens an animal of great size. The specimen, to which a considerable quantity of the breccia still adheres, is peculiarly interesting as being found in a deposit in which careful methodical research, continued for years, had failed to detect any other osseous remains than those of bear, with but one exception, and that, as already stated, being also the lower jaw of a lion, found less than two months before. This interesting relic was met with on 31st December, with two teeth of bear, bones and fragments of bone, in the second foot-level of Breccia. No feline remains have been detected since that date.

A few only of the flint and chert specimens require description:—

No. 6,550 is an implement made out of a well-rolled chert nodule. It is somewhat semilunar in form, but broader at one end than the other, and measures about 4.4 inches in length, 2.3 inches in greatest breadth, and 2.5 inches in greatest thickness, which it attains near the broader or butt-end. It has undergone a considerable amount of chipping, has been reduced to an irregular edge along the greater part of its perimeter, and is comparatively thin near the pointed end. It is very, but unequally, convex on both faces, each of which has a central ridge, and retains the original surface of the nodule over the whole of the butt-end, whence a trace of it extends along the central ridge of the less convex face to about an inch from the point. The portion of the surface which has been chipped is of a yellowish hue, derived, no doubt, from the matrix in which the specimen lay. This, however, is but a superficial stain, as there are indications of an almost white colour within. This fine implement was found 15th February, 1875, between the Hedges Boss and the left wall of the cave, thirty-six feet from its entrance, in the second foot-level below the surface, that is, in the uppermost foot-level of the Breccia, and having no other object of interest near it.

No. 6,565 is a chert implement 3.7 inches long, 2.7 inches in greatest breadth, and 1.7 inches in greatest thickness, which it attains not far from its centre. It has unfortunately lost one of its extremities—apparently broken off whilst the tool was being made. It is very, perhaps equally, convex on each face, but the centres of convexity are not situated opposite one another; and, though made from a nodule, not a flake, no part of the original surface remains. A considerable amount of work has been expended on it, and it has been reduced to an edge all round the perimeter except at the broken end. The marginal edge is neither keen nor regular, nor in the same continuous plane. There can be little doubt that it was intended to be a somewhat pointed ovoid tool, and that had it been perfected its form would have been more symmetrical than the breccia tools are usually, and its colour is whiter than that of most of the implements found in the same deposit. It was met with on 13th April, 1875, in the second foot-level of the Breccia, without any other object of interest near it, forty-seven feet from the entrance of the Cave of Inscriptions.

The earlier explorers had but imperfectly examined the material they dug up in this branch of the cavern. On taking it to the daylight, the committee found in it nineteen teeth of bear, twelve of fox, nine of hyæna, two of horse, and one of rhinoceros; a large number of bones, numerous coprolites, a fragment of a marine shell, and six flakes and chips of flint.

The exploration of this cave was completed on 14th June, 1875, having occupied the labour of between eight and nine months.

The following is a list of the specimens found in it in undisturbed ground, inclusive of those mentioned in the Tenth Report:—One bone of bat, a few other bones, a few patches of coprolite, and a bit of charcoal, in the Granular Stalagmite; twenty-seven teeth of hyæna, several of them in jaws or parts of jaws,



eleven of bear, one of a small rodent, one jaw of fox, numerous bones and fragments of bone, of which six had been charred and a greater number gnawed, a large number of coprolites, and seven tools, flakes, and chips of flint, in the Cave Earth; 213 teeth of bear, some of them in jaws or pieces of jaws, two of lion, in parts of upper jaw, and twenty implements and flakes of flint and chert.

*The Recess.*—On completing the exploration of the Cave of Inscriptions, operations were at once commenced in a "Recess" occupying its north-western corner, and which was expected to lead to a new external entrance to the cavern. It extends in a north-westerly direction for fully sixty feet, and is of sufficient width for a man to pass easily; beyond this its extent is considerable, but at present it is too narrow for examination. Its floor is a thick sheet of the crystalline or more ancient stalagmite, and is abruptly truncated at the junction of the Recess with the Cave of Inscriptions. It rested on a thick mechanical accumulation, which is unmistakable breccia, and reaches a higher level than elsewhere in the cavern, so far as is at present known. It was decided to leave intact the Stalagmitic Floor, and in fact to burrow under it; but when the excavation had reached a distance of ten feet, the two walls were found to be so very nearly together as to render it necessary to abandon the work, or to break up the floor and proceed at a higher level. The former course was, though reluctantly, decided on. The only specimens found here were two teeth of bear, a few bones, and an unimportant piece of flint.

*The Alcove.*—A recess in the eastern wall of the Cave of Inscriptions, near the Hedges Boss, and which received the name of the "Alcove," was next explored. When emptied it proved to be scarcely lofty enough for a man to stand erect, and ten feet in length and breadth, but divided into two compartments by a limestone partition extending nearly across it. Its exploration, which occupied three weeks, was rewarded with thirty-nine "finds" of remains of mammals, including fifty-nine teeth of bear, several of them in portions of jaws; sixteen of fox, all of them in portions of three lower jaws; four of hyæna; numerous bones, including several good specimens, though all of them more or less fragmentary; and one coprolite. The teeth of hyæna, two of the jaws of fox, and the coprolite were met with in cave earth; but the remaining jaw of fox (No. 6,619) was found in the breccia. It was broken into two pieces, which were lying together and contained five teeth, and is the only known relic of the genus in this old deposit. The Alcove contained no trace of flint or chert.

*The Great Oven.*—A very long, narrow, and low tunnel opening out of the south-western corner of the Cave of Inscriptions has been termed the "Great Oven." Its exploration was begun July 27, 1875, or but four days before the period at which this report closes. It contains a thin layer of cave earth, and a deposit of breccia of unknown depth. The former has already yielded a few traces of hyæna, and the latter a greater number of ursine remains.

On studying the osseous remains found in the Breccia in the branches of the cavern explored during the last twelve months, the following prominent facts arrest attention:—Some of the teeth of bear are those of very old animals and worn almost to the fang. The jaws, though frequently broken, have never lost their lower borders, as is almost uniformly the case with the cave-earth specimens; and none of the bones appear to have been gnawed. In no instance were the bones found lying in their anatomical relations, but different parts of the skeleton were often huddled confusedly together; thus, in No. 6,613, found in the Alcove, a canine tooth adheres to one side of the proximal end of a tibia, and a piece of jaw to another side. Some of the specimens have fretted surfaces, and appear to have been rolled by running water. Many of the bones were broken where they were finally lodged, and the parts, with little or no displacement, reunited with stalagmitic infiltration. Others appear to have been flattened, or more or less crushed, where they lay. Occasionally, in the same rock-like mass of breccia were found bones of very different colours, showing that mere colour is no test of age.

Nor are the remains from the cave earth void of instruction. Up to the present time, wherever the cave earth has been met with, there also have traces of the hyæna been found, either in the form of parts of his skeleton, or his coprolites, or bones scored with his teeth-marks, or jaws divested of their lower borders, or long bones broken after his well-known fashion. But though everywhere present in greater or lesser numbers, these traces became less and less plentiful with increased distance from

the external entrances of the cavern, and were very "few and far between" in the chamber most remote from the entrances. Whilst remains of the hyæna were thus met with wherever the cave earth occurred, they were accompanied in the interior by very few of his contemporaries. Thus, whilst the chambers adjacent to the entrances contained teeth and bones of horse, rhinoceros, deer (several species), bear, fox, elephant, ox, lion, wolf, and hare, as well as hyæna—the last being by far the most prevalent—remains of the hyæna alone have been found during the last twelve months. Nor is it without interest to note the branches of the cavern in which remains of the different forms just enumerated were last detected on the way to the Cave of Inscriptions. The hare was not found anywhere in the western division of the cavern—that of which the Cave of Inscriptions is the innermost chamber; the badger, wolf, and ox were represented in the "Charcoal Cave," but not beyond it; and relics of horse, rhinoceros, deer, bear, fox, elephant, and lion did not appear beyond the Long Arcade. Finally, no traces of *Machairodus* have been met with since the incisor tooth, found July 29, 1872, and described in the Eighth Report, presented at Brighton.

### SCIENTIFIC SERIALS

*Proceedings of the Berwickshire Naturalists' Field Club*, vol. vii. No. ii.—This earliest of Field Clubs continues to sustain the high reputation it has had from the beginning; and the present part of the Proceedings shows that the members continue to investigate diligently and to good purpose the natural history and antiquities of the interesting district which forms their field. Most of the papers are of real value, and the best service we can render the club and our readers is to give a list of them:—"On supposed lake or river-terraces near Kelso," by Mr. T. Craig; "On Jedburgh Pears," by Mr. James Tate; "On the antiquity and history of some Border Pears," by Mr. Jas. Hardy; "On evidences of ice-action in Berwickshire," by Mr. W. Stevenson; "Ornithological notes," by Mr. H. Gibb; "On the value of the horse-chestnut (*Æsculus hippocastanum*) as a timber-tree in plantations," by Mr. R. Carr-Ellison; "On Lepidoptera, taken mostly in 1874," a list of captures by various members; "On the signification of some names of places in South Northumberland," by Mr. R. Carr-Ellison; "On the occurrence of the Wild Cat in the border district," by Mr. James Hardy; "A list of local plants and their localities," by Mr. A. Brotherston; "Ornithological notes," by Mr. R. Gray; "On iron and iron slag found at Worm Law and Yeavinger," by Mr. Jas. Hardy; "On some flint implements of prehistoric people in Berwickshire," by Mr. James Hardy, with some beautifully executed illustrations; "A note on a specimen of *Arabis turrita*, discovered at Haining," by Mr. A. H. Borthwick; "On ancient stone cysts and human remains discovered at Aycliffe House, near Ayton," by Mr. J. Hardy, with an illustration; "On a bronze celt found at Linden," by Mr. R. G. Balam, with an illustration; "Some notes on the movements of migratory birds," by Dr. Scott and Mr. Hardy; "Zoological notes," by Messrs. Ferguson and Brotherston; various information on local natural history, by Mr. Hardy; "On some of the birds of Lauderdale," by Mr. A. Kelly; "List of *Araneidae* and *Phalangidea*, collected from Oct. 1871 to Dec. 1874, in Berwickshire and Northumberland, by Mr. James Hardy," by the Rev. O. P. Cambridge; "On Berwickshire insects," by Mr. Hardy, who also has "Contributions to the entomology of the Cheviot Hills."

*Third Report of the Winchester College Natural History Society.*—This report is altogether very encouraging; it has, as the preface justly states, "a real amount of active and intelligent life" to record during the year. The members as a body seem to be really interested in the work of the Society, and the tendency of that work is evidently to train the members to be accurate observers and independent thinkers. In the preface considerable importance is rightly attached to the collection and exhibition of specimens at the meetings for examination and comment, especially with the view of encouraging the younger members to become intelligent collectors. The report contains a considerable number of papers, nearly all by present or past members, and these papers give evidence of real intelligence, honest study, and in some cases of original observation. The first paper especially, that by W. A. Forbes, is highly creditable to its author; G. L. Hawker's, on Bio-geology, shows considerable knowledge and not a little originality of conception; the paper by N. M. Richardson also deserves mention. But indeed

the papers as a whole are above the average of those emanating from similar societies. The lists of specimens in the various sections appended show that the members continue to do much practical work; a botanical garden has also been opened in connection with the Society.

*Proceedings of the Bath Natural History and Antiquarian Field Club*, vol. iii. No. 2, 1875.—This part contains the following papers on scientific subjects:—Notes on some railway sections near Bath, by the Rev. H. H. Winwood, F.G.S., with an illustration.—Studies and problems for Somersetshire geologists, by M. H. B. Woodward, F.G.S.—There is an interesting address by the Rev. Preb. Scarth, on the results of modern archæological achievement, and a summary of Proceedings for the year 1874-75, by the Secretary.

*Morphologisches Jahrbuch*.—The first part of this new Journal of Anatomy and Embryology, issued by Prof. Gegenbaur (see vol. xii. p. 15) consists of about 200 pages, and has five double plates. Prof. Gegenbaur supplies an excellent introductory article on the position and signification of morphology. The succeeding sixty pages are occupied by an elaborate account, by Dr. Richard Hertwig, of *Podophrya gemmipara*, a new species of Acinetæ, followed by an essay on the structure and systematic position of the Acinetæ. The author identifies his species with one figured, but not determined, by the late Mr. Alder in the "Annals of Natural History" for 1851, p. 426. Its nucleus is remarkable for having a number of irregular stellate branches, and its tentacles are differentiated into captorial and suctorial. After a review of the structure of Acinetæ generally, Dr. Hertwig comes to the conclusion that a unicellular organism, covered with cilia, is the original form from which Acinetæ and Infusorians have sprung, but that it cannot yet be determined whether it possessed a cytostome, and thus was a true ciliated Infusorian, or whether it was provided with tentacles, and was intermediate between Ciliata and Acinetæ.—The whole of the remainder (114 pages) of this part is occupied by a very notable paper by Dr. Emil Rosenberg, on the development of the vertebral column and of the os centrale carpi of man. He sets before himself the problem, little touched hitherto, of the discovery of the steps by which man may have developed from the nearest mammalian stock. Taking first the vertebral column, he sets forth the differences existing therein in the various Anthropomorphæ, and seeks to reconcile them with that of man. For instance, in two genera, Troglodytes and Hylobates, there are thirteen dorsal vertebrae, while in the Orang and in man there are only twelve. But Dr. Rosenberg has discovered in more than one human embryo an actual rudiment on the 13th dorsal vertebra; so that the homology of the 13th dorsal in man and Troglodytes is established. Another result that Dr. Rosenberg claims to have demonstrated from examination of human embryos is that a process of transformation goes on in the growth of the sacrum, by which vertebrae at the proximal end, with their costal elements, are assumed into the sacrum, while a corresponding number at the distal end undergo reduction and are dismissed into the caudal region. And this process, generalised, may be applied to each of the hinder regions of the vertebral columns. Thus in the history of development each lumbar vertebra in man is the result of a single transformation from the condition of a dorsal vertebra; each sacral vertebra has previously passed through the lumbar stage; while the caudal vertebrae have been successively dorsal, lumbar, and sacral, before becoming caudal. This is necessarily but a very imperfect sketch of the major subject of this paper, which is of very high interest.

SOCIETIES AND ACADEMIES

PARIS

Academy of Sciences, Oct. 26.—M. Frémy in the chair.—In opening, he referred in feeling terms to the death of Sir Chas. Wheatstone.—M. Milne-Edwards presented the second part of the eleventh vol. of his work on "The Comparative Physiology and Anatomy of Men and Animals." The following other communications were made:—On employment of means in experimental physiology, *à propos* of the influence of stripping the leaves off the beet, upon the production of saccharine matter, by M. Cl. Bernard. M. Frémy made some remarks also on this subject.—On the carpellary theory, according to the Iridæ (third par.), by M. Trécul.—On the dates of fall of meteorites, by M. Sainte-Claire Deville. He finds an excessive fall of bodies on the 12th, 13th, and 14th May; also

something like a ten-days' period, corresponding to periodical inequalities of temperature.—On the practical value of steam-injectors, by M. Ledieu.—Progress realised, in the question of making land, by employment of the rational method, and in determination of the daily working of chronometers, by M. de Magnac. The new method (he shows) renders navigation much more exact.—Magnetic observations on the island of St. Paul, in November and December 1874, by M. Cazin.—On the mosses of St. Paul and Amsterdam Islands, by M. Bescherelle.—List of Lichens collected by M. de l'Isle, on St. Paul and Amsterdam, and description of new species, by M. Nylander.—New spectro-electric tube (modified fulgurator), by MM. Delachanal and Mermet. A small conical capillary tube is placed over the platinum electrode passing through the bottom of the larger tube; through this the liquid rises and is illuminated by the spark.—On the laws which govern reaction with direct addition (continued), by M. Markovnikoff.—The industry of nitrate of soda in South America, by M. L'Olivier.—Experimental researches on the mechanism of coagulation of blood in treatment of varices by simple isolation of veins, by M. Bergeron.—On the alterations produced in the vine by *Phylloxera vastatrix*, by M. Max. Cornu.—Conservation of food stuffs, by M. Reynoss.—M. de Carvalho presented a note on the properties of air subjected to passage of an induction current.—M. Delaunoy on a "solar concentrator," *à propos* of M. Mouchot's paper.—M. Pertinset on a project of exploration of Terra del Fuego.—The Minister for the Navy and Colonies communicated part of a report from the Governor of Martinique on the earthquake there from 17th to 25th September, and magnetic phenomena accompanying it. M. Sainte-Claire Deville said M. Duvignan had written him from Guadeloupe that none of the Martinique shocks had been felt there.—Observations of the planet (149) discovered by M. Perrotin at Toulouse (sent by M. Leverrier).—Experiments made on Geissler tubes with the chloride of silver pile formerly described, by MM. Warren De la Rue and Müller.—On spiral nebulae, by M. Planté. He shows how a cloud of metallic matter detached from the electrode by an electric current of high tension, in a liquid, assumes a gyratory movement when acted on by a magnet; and supposes the form of spiral nebulae may thus be due to strongly magnetic celestial bodies in their neighbourhood.—On the hydrological map of the department of Seine-et-Marne, by M. Delesse.—M. Degantière presented a note on the noise which accompanies or precedes the fall of hail.

BOOKS AND PAMPHLETS RECEIVED

COLONIAL.—Report of the Agricultural Conditions, Capabilities, and Prospects of the Neilgherry District: W. R. Robertson, M.R.A.C. (Madras).  
 AMERICAN.—The Mechanical Engineer; his Preparation and his Work.—An Address by R. H. Thurston, A.M., C.E. (New York, Van Nostrand).  
 —Monthly Report of the U.S. Department of Agriculture, Aug. and Sept.—Memoirs of the Boston Society of Natural History. Vol. ii. Part 4, No. 2.  
 —Report of Mount St. Elias: W. H. Dall, U.S.C.S.—Bulletin of the Buffalo Society of Natural Sciences.  
 FOREIGN.—Bulletin de la Fédération des Sociétés d'Horticulture de Belgique (Liège).—Liste des Jardines, des Chaires, et des Musées Botaniques du Monde (Liège).

CONTENTS

	PAGE
AMERICAN GEOLOGICAL SURVEYS. By Prof. ARCH. GEIKIE, F.R.S.	1
ALIX ON THE LOCOMOTION OF BIRDS . . . . .	3
"THE ABODE OF SNOW" . . . . .	4
OUR BOOK SHELF:—	
Further "Researches in Mathematical Science" . . . . .	6
Amery's "Notes on Forestry" . . . . .	6
Curly's "Nebraska" . . . . .	7
Bird's "Twelve Maps for Map-Drawing" . . . . .	7
LETTERS TO THE EDITOR:—	
Observation of Cirrus Cloud.—ALEXANDER BUCHAN . . . . .	7
Mr. Mallet's Paper on Prismatic Basalt.—ROBT. MALLET, F.R.S.	7
Plagiarism.—Prof. W. BOYD DAWKINS, F.R.S. . . . .	7
The Internal Heat of the Earth.—JOHN WILLIS . . . . .	8
OUR ASTRONOMICAL COLUMN:—	
40 Eridani . . . . .	8
Proper Motion of $\alpha^2$ Centauri . . . . .	8
The "Astronomische Nachrichten" . . . . .	8
A NEW PALMISTRY. By JOHN C. GALTON . . . . .	8
SCIENCE IN GERMANY . . . . .	10
MULLER ON BEES AND FLOWERS. By J. L. . . . .	10
FAYE ON THE LAWS OF STORMS ( <i>With Illustrations</i> ) . . . . .	11
NOTES . . . . .	14
ELEVENTH REPORT OF THE COMMITTEE FOR EXPLORING KENT'S CAVERN, DEVONSHIRE . . . . .	17
SCIENTIFIC SERIALS . . . . .	19
SOCIETIES AND ACADEMIES . . . . .	20
BOOKS AND PAMPHLETS RECEIVED . . . . .	20

ERRATUM.—Vol. xii. p. 559, col. 2, line 17 from bottom: for "sixty years" read "ten years."

THURSDAY, NOVEMBER 11, 1875

SEVENTH REPORT OF THE SCIENCE  
COMMISSION

THE present Report deals with the University of London, the Universities of Scotland, the University of Dublin and Trinity College, and the Queen's University in Ireland. With regard to the University of London the Commission has few suggestions to make, though it is of opinion that the Matriculation Examination would have a still higher value than it has if a Practical Examination could be instituted in connection therewith. "The enforcement of a practical test would accelerate the introduction of practical work into school teaching, and would thus exert a very favourable influence on the Progress of Scientific Education."

The Commission is also of opinion that the University of London should follow the example of the University of Edinburgh, and award the degree of D.Sc. only to those who have given proofs of the desire and capacity to make some addition to scientific knowledge.

The greater portion of this Report refers to the Universities of Scotland. The Report begins by referring to the inquiry conducted by the Commissioners appointed under the Universities (Scotland) Act of 1858, and to the reforms instituted by them. The recommendations made by this Commission were, however, controlled by the fact that the sum to be provided by Parliament to carry them out would not exceed 10,000*l.* a year. The Universities Commission kept very much, therefore, to the old lines, making classical learning the foundation of a University course, and prescribing for graduation in arts, a course extending over four winter sessions, and including "attendance on the Classes of Humanity, Greek, Mathematics, Logic, Moral Philosophy, and Natural Philosophy:" and, in addition to these, "attendance on a course of English Literature," which previously had not been required in any Scottish University except that of Edinburgh.

The Commission observes with satisfaction that in the Scotch Graduation Examination it is clearly recognised that a fair training both in literature and in science is the best basis for further advances in either the one direction or the other. They suggest, however, that the student should be allowed to show the required proficiency, whether in science or literature, by passing an examination at such a period in his University career as will enable him, in the latter part of his academic course, to devote his attention systematically to a particular group of subjects.

In referring to the examinations for the degrees of Bachelor and Doctor of Science, the Report states that recently a regulation has been made at Edinburgh that each candidate for the degree of D.Sc. must submit a thesis containing "some original researches on the subject of his intended examination, and such thesis must be approved before the candidate is allowed to proceed in his examination." It seems quite astonishing that this, which has for generations been the rule on the Continent, has not been done in all our Universities long ago. Degrees of an essentially similar kind have been instituted in Glasgow.

The most important part of the Report on the Scottish Universities is concerned with the deficiencies in respect to assistants and apparatus. In some cases the rooms are not at all adapted to the kind of teaching that must be carried on in them. The laboratory accommodation is throughout glaringly deficient, and ill-adapted for practical work. Indeed, if we except Glasgow, where new buildings have recently been erected, practical teaching can scarcely be said to exist, and now that it has come to occupy so large a space in the higher education, it is not to be wondered at that the scientific professors feel completely hampered in carrying on their work. Happily, in the case of Edinburgh this state of matters is likely soon to be remedied; 80,000*l.* have been already subscribed to build a new medical school, so as to leave the present buildings for the other departments of the University.

With regard to assistants, all the Universities are also miserably deficient, the deficiencies being attributable to the inadequacy of their resources. There are certain funds available for assistants to the scientific as well as to the other professors, but these are so scanty that in some cases the science professors have to provide additional assistants out of their by no means munificent incomes. The apparatus also, in connection with the scientific chairs, is discreditable to the Universities and quite inadequate to the modern requirements of scientific teaching.

In the case of the Universities of Edinburgh, Glasgow, and St. Andrews, the Commissioners recommend that Government augment their grant sufficiently to enable the Universities to increase the number, and, in some cases, the emoluments of assistants; to make more ample provision of apparatus for teaching; and to revise the salaries of the scientific professors.

In the case of Edinburgh it is recommended that such assistance be given, both in the form of a capital sum in aid of a scheme of extension, and of an annual grant.

The Report also deals shortly with the Andersonian Institute, or "Anderson University" of Glasgow, founded under the will of John Anderson, Professor of Natural Philosophy in Glasgow University towards the close of last century. There is no doubt it does good work among those who cannot afford a regular University education; many students in Arts and Medicine get their education here. It has been suggested that this Institute receive a charter, but the Commissioners wisely decline to support such a suggestion.

A movement was set on foot some time ago to establish a Science School at Dundee, about twelve miles from St. Andrews, across the Firth of Tay, which is being bridged for a railway. The Commissioners, however, cannot recommend any scheme which would involve the St. Andrews professors travelling to and from Dundee to teach, or which would remove the scientific chair to that town.

For some reason the University of Aberdeen has declined to avail itself of the opportunities afforded it of tendering evidence before the Commission.

With regard to the two Irish Universities, that of Dublin and the Queen's University, the Commissioners report very favourably on the portion allotted to science in these two institutions.

In the Dublin University there are thirty-three fellowships, which are tenable for life, irrespective of the restriction of celibacy, and are now open to all without distinction of creed. The Commissioners think that it would be very desirable that in the election to Fellowships important original research should be regarded as a substantial element of merit.

The nature of the constitution of the Queen's University, Ireland, and its three colleges at Belfast, Cork, and Galway, is well known. The education to be obtained at these colleges is fairly complete, both on the scientific and literary side, and the examinations imposed by the University are such as to make its degrees of real value.

The evidence shows that the appliances for teaching are in some respects insufficient, and that there is a serious deficiency of funds for maintaining the efficiency of the Queen's Colleges in this respect. The Report concludes and recommends as follows with regard to the Queen's University in Ireland:—

"In founding the Queen's Colleges, the State did not adopt the principle of assisting and stimulating local efforts, and if we except the exhibitions and prizes, to which reference has been already made, as having been provided by public subscription, and a few other exhibitions which have been founded at Belfast, no voluntary contributions have been received by them. They are institutions for which the State has made itself responsible, and in which, as part of a University system, a complete scientific training is implied.

"As we think it of great importance that the sanction of the State should not be given to the teaching of science on a scale inadequate to ensure its efficiency, we recommend (1) That an increased annual grant be made to the Queen's Colleges for the purpose of providing assistants, apparatus, and the other necessary appliances of practical scientific teaching. We further recommend (2) that the Professorship of Natural History in the Queen's College, Belfast, be separated from that of Geology and Mineralogy."

The general conclusion reached, then, in this Seventh Report is that it would take very little to make London University nearly perfect as an examining and degree-granting body; that Dublin University is in a healthy condition, and by a little amendment in the subjects of examination for her Scholarships and Fellowships, she might be an example to her sister Universities in England; that the Queen's University, Ireland, and the four Scottish Universities are all working in the right lines, and that what they mainly require in order that they may develop into perfectly efficient teaching bodies, so far as science is concerned, are funds to provide the necessary men, buildings, and apparatus. No doubt the recommendations of the Commissioners in reference to these and other matters will receive serious attention in the proper quarter.

#### HERMANN'S "ELEMENTS OF HUMAN PHYSIOLOGY"

*Elements of Human Physiology.* By D. L. Hermann, Professor of Physiology at the University of Zurich. Translated by Arthur Gamgee, M.D., F.R.S. (London: Smith, Elder, and Co., 1875.)

FOR a considerable time a first-class work on the Elements of Physiology in our own language has been a desideratum. The bulky Handbook by Carpenter

was framed in a nearly bygone era of the science; Kirkes' smaller volume is under a similar disadvantage; Huxley's excellent little book does not appeal to others than beginners, and the "Handbook to the Physiological Laboratory," by Drs. Sanderson, Foster, Brunton, and Klein, was never intended to fill the place of a manual. Dr. Gamgee steps forward to fill the gap with a carefully conducted and excellent translation of the fifth edition of Prof. Hermann's deservedly esteemed "Elements of Physiology," a work unequalled in the care which has been bestowed on the collecting and balancing of the investigations of authors from all quarters, as well as in its general construction and inherent unity of design.

Dr. Gamgee tells us, "After much hesitation and many doubts I decided not to annotate the text, for had explanatory notes, of the nature of commentaries with illustrations, been added to it, as I once intended, its appearance would have been still further delayed, and the work would have been materially altered in character—it would have ceased to have been Hermann's Physiology." We have a sufficiently high estimation of Dr. Gamgee's ability to think that the English reading public are the sufferers from his change of determination. The work being Hermann's therefore, and not in any way Gamgee's, except as far as the translation is concerned, our remarks apply only to the former.

The subject is treated in four sections, or parts. The first is entitled "The Exchanges of the Matter of the Organism"; the second, "The Activities or Energies of the Body"; the third, "The Liberating Apparatus; the Nervous System"; and the last, "Origin, Development, and Death of the Organism." As in most works on general subjects written by authors with any special predilections, the space devoted to the different functions is not quite that which would suggest itself to the unbiassed reader. As an instance of this in the present case we may refer to the fact that the account of the organ of sight alone occupies more than one-eighth of the volume, and nearly three times as much space as that devoted to the circulation of the blood.

The first part treats of the chemical constituents of the human body, the blood, and the circulation. The most advanced method of notation is adopted, and Baeyer's observations on the relations of uric acid are incorporated.

In the chapter on the blood we find one section devoted to the death of that fluid, the expression being employed to indicate those effects which follow its withdrawal from the influence of the walls of the living vessels. With reference to the movement of the blood in the circulatory system, we cannot help feeling that there is considerably more that might have been said about it with advantage, and that it might have been treated in a more connected and precise manner. Too much stress is laid on the aspiratory power of the thorax, which is assumed to be so continuous that "an ordinary expiration merely removes the inspiratory increase of the negative pressure." The duration of the systole of the ventricles of the heart is said not to vary with differences in the pulse-rate, according to the observations of Donders, which have been since shown to be incorrect. We are also led, incorrectly, to infer that the blood-pressure in the ventricles at the end of the diastole is a negative one; that the

force of gravity] is one of those which aids the circulation ; that "all those vessels which carry blood to a capillary system are called arteries ;" that in "scaly amphibia"—by which we assume reptiles are meant—the two ventricles always communicate, which is not true as far as the crocodiles and alligators are concerned ; and that the heart of a warm-blooded animal, removed from the body, will continue to beat "so long as a supply of oxygenated blood is provided."

The term "secretion" in its widest sense is said to denote "all those processes in which substances quit the blood in an altered or unaltered condition." This involves the inclusion of that simple nutritive diffusion into tissues which results in the origin and growth of bone, cartilage, &c. ; an unnecessary complication, we cannot help thinking, and one apt to mislead. When it is stated that "nothing is known about the formation and regeneration of bone-tissue, except the morphological appearances presented in the various stages," justice is not done to Dr. Beale's most ingenious and highly probable explanation of the process by which it comes into existence.

The second portion of the work discusses the energetic relations of the body. Parts give indications of having been evolved from the author's inner consciousness, when he might have appealed to sound fact. On the whole we prefer the way in which the subject is treated in Dr. Pavy's excellent work on "Food." Prof. Hermann's theory of muscular contractility, based entirely on slender analogies, does not impress itself on our attention more than does the not less satisfactory one of Dr. Radcliffe.

The "liberating" or "discharging" apparatus, in other words the nervous system, occupies the third section of the work. As our knowledge of the nerves is very superficial, remarks the author, it must suffice to establish empirically the conditions which increase, diminish, or destroy irritability. This is done in a most exhaustive and excellent manner. Prof. Hermann regards the phenomenon of electrotonus as an effect of contact, the contents of nerve-tubes which are dying or in activity being negative to the contents of nerve-tubes which are living and at rest. The chapters on special sense will be read with particular interest, from the masterly manner in which they are written. Why so much space is devoted to the horopter, a surface the physical relations of which are as much connected with stereoscopic photograph cameras and double magic lanterns as with eyes, we do not know. With regard to the author's ideas on the recent views promulgated by Hitzig, Fritsch, Nothnagel, and Ferrier, we will quote his own words. "The movements which have recently been induced by electrical stimulation, since they do not occur after mechanical or chemical stimulation, may very well be set down to the irritation of more deeply seated regions, for the latter are unavoidably exposed to the diffusion of currents. . . . No results as to the nature and distribution of the functions of the cortex, even of the value of approximations, can be deduced from these experiments."

In the fourth section of the work a short account is given of the development of the embryo, not detailed enough to be of much service, except to the initiated.

This rapid glance at the contents of Prof. Hermann's

work indicates that it adopts a method of treatment that is more modern than most. In perusing it in detail the incorporation of the results arrived at in all directions by physiologists during the last twenty years, makes its value still further apparent. The many conflicting statements which have sometimes to be made, without any explanation being given, leave several questions without any definite answer. Such must for some time be the case in a science so young as physiology. The authorities for the different statements introduced are given in every case where there might be any doubt, and the book would have been still further serviceable if references had been introduced to the publications in which the results are described, as well as to the author's name. Many, in looking through the work, will feel that much of the method and many of the phenomena there explained, which, although they have not made their way into our text-books, have been current in the oral tradition of physiological circles ; they must remember that a considerable amount of capital has been made out of foreign investigations by those who have done little more than dote them out in a different language from that in which they originally appeared.]

The arduous task of translation has been most conscientiously performed by Dr. Gamgee, who has evidently weighed, carefully and acutely, the unavoidably difficult forms of expression employed, many necessarily quite new on account of the novelty of the conceptions developed. Taking for example the word "Schwellenwerth," as employed with reference to Fechner's psycho-physical law which is shortly explained ; at the suggestion of Dr. Sanderson it has been translated "liminal intensity," an expression which does not at first sight explain itself, as does "initial intensity," the rendering which first occurred to Dr. Gamgee. In physics "initial" is employed of velocities, and we are not sure that any other term was necessary.

In conclusion, there is no doubt that the appearance of this work has greatly reduced the need, at the present time, for any other treatise on the Elements of Physiology.

### WHITE CONQUEST

*White Conquest.* By William Hepworth Dixon. Two vols. (London : Chatto and Windus, 1876.)

MR. DIXON has been again in America, this time to collect evidences of the struggle between the races that is being waged on that wide battle-field. Although his method of treating the subject is not such as quite to bring his work within the critical sphere of NATURE, and although the author makes no attempt to treat his subject scientifically, still even the scientific reader, the student of ethnology or of the characteristics of the various races of men, and he who takes an interest in the struggle for existence wherever it is being carried on, will find much in Mr. Dixon's striking pictures well fitted both to interest and instruct. It is not in our province to criticise the quality of the artistic element in the work, but about its fascination there can be no doubt. Of course the work is one-sided. We do not use the term by way of depreciation, but in its literal sense. Mr. Dixon's aim is to represent, by means of a

series of sharply outlined and brilliant pictures, the most prominent and often the most unpleasant features of the great struggle out of which it is evident the white race must come victorious.

The regions with which the work is mainly concerned are the Pacific States, especially California, and also the States on the Gulf. In the West, especially, the fight is a regular *mêlée* between white men, red men, black men, and yellow men. Very striking indeed is Mr. Dixon's account of the means by which the Chinese are rapidly asserting for themselves a place of the first importance in and around San Francisco, notwithstanding the disgusting and degrading habits of the majority of them.

When the heat of the struggle is over, when the country is again sufficiently populated, and the people have settled down to a life of steady progress, what will be their characteristics, physical, intellectual, and moral? It is an interesting question, an intricate problem, which we fear it would be difficult to work out beforehand. In a recent number we referred to the valuable paper by Prof. Wilson, of Toronto, detailing his observations on the relations between the whites and the Indians, especially in Canada. His conclusion is, that in accounting for the disappearance of the American Indian, too much prominence has been given to extermination and too little to absorption. He produces data to show that a very considerable amount of red blood has been absorbed by the white intruders, and that aboriginal traces are to be found widespread among all classes of society. Moreover, that it is difficult to find a pure Indian, and that the half-breeds who now mainly represent the old proprietors of the soil have excellent stuff in them, and are being constrained gradually to settle down to a civilised life. The conclusion is, that in the end a homogeneous race will result, having no doubt large white characteristics, but at the same time showing unmistakable marks of a red ancestry.

Where one race intrudes itself forcibly into a country already populated, and has to fight its way to find a place for itself, this mixture is inevitable; the men who do this rough work cannot as a rule take their own women with them. Some of the most impressive pictures in Mr. Dixon's work are connected with this subject, and show how inevitable it is that under the circumstances alluded to, a large half-breed population must arise. We are sorry to see, however, that Mr. Dixon does not speak so well of the half-breeds as Prof. Wilson does, though this may arise from the fact that those of Canada have as a rule more white blood than red in their veins. In the end, which approaches with accelerating speed, when homogeneity is attained, the United States will be populated by a race of very mixed blood indeed, though it is evident to everyone but a pessimist, that the brain and sinew and muscle which dominate in the Old World will, both in quality and quantity, in intension and extension, to use logical terms, bear the sway on the other side of the water. The great stumbling-block in this, as in other respects, in America, is the Negro, the "cullid gemm'n," as he now calls himself. Extermination does not appear likely to be his fate, and "absorption" in his case seems a mighty long way off.

Two of the most interesting chapters in Mr. Dixon's works refer to education in America, and will somewhat

surprise those who fancy that America has a system of education as thorough and uncompromising as that of Germany. While Mr. Dixon has evidently presented here almost exclusively the dark side of the education question in America, there is no withstanding his statistics. Still, all things considered, especially looking at the heterogeneous population, ever largely increasing from the outside, with which American educationists have to deal, both the extent and the quality of education in the United States do the citizens infinite credit.

While, we repeat, Mr. Dixon's work makes no pretensions to be scientific, still we are grateful to him for bringing before us so brilliant and attractive a series of pictures of a struggle which is indeed only the continuation, further westwards, of that which was begun far back in prehistoric times by the ancestors of those whites who at present seem likely to be victors and lords all the world over. We fear that after all, however much we may plume ourselves on our superior culture and advanced civilisation, might is still with us, as with our predecessors, right; and perhaps after all, both on scientific and humanitarian grounds, it is only right that it should be so.

#### OUR BOOK SHELF

*Elementary Analytical Geometry.* By the Rev. T. G. Vyvyan. (London: George Bell and Sons, 1875.)

*Conic Sections treated Geometrically.* By W. H. Besant, F.R.S. (Same publishers.)

THERE is little calling for special notice in Mr. Vyvyan's work. The fact of its having reached a third edition is a clear indication that it has met with acceptance. New chapters have been added on focal properties of conics and on abridged notation and trilinear co-ordinates; the central conics are discussed together; and the chapter on the general equation has been enlarged. There is a good selection of exercises. The work is reduced in price, and now forms one of the publishers' series of Cambridge School and College Text Books.

The new matter in this second edition of Mr. Besant's "Conics" is confined to little more than two articles. The errata of the first edition have been carefully removed, and we have detected only some half-dozen simple typographical mistakes. Between thirty and forty new examples have been added. We notice that in consequence of a few slight alterations, in some four or five cases, the same figures come on to opposite pages, a fact easily accounted for when we know that the work is now in its second edition.

We presume that though Mr. Besant in his Introduction still states that "a knowledge of Euclid's Geometry is all that is necessary," he does not thereby mean us to infer that a like knowledge of geometry obtained from other and more modern text-books would not answer as well. It is not necessary to say anything in praise of a work so well known and prized as this as a text-book of Geometrical Conics.

*Die Periodischen Bewegungen der Blattorgane.* Von Dr. W. Pfeffer, A.O. Professor in Bonn. Mit 4 lithographirten Tafeln und 9 Holzschnitten. (Leipzig: Verlag von Wilhelm Engelmann, 1875. 8vo., 176 pp.) (The Periodic Movements of Leaf-organs. By Dr. W. Pfeffer, Extraordinary Professor in Bonn. With 4 lithographed plates and 9 woodcuts. Leipzig: W. Engelmann.)

THE essential character of periodic movements as defined by Pfeffer is their being recurrent. All "repeated" movements, whatever their cause and mechanism may be, are periodic. Recurrent or periodic movements are of diffe-



rent kinds, and it is necessary carefully to distinguish between them. Thus certain periodic movements occur only during the growth of the part, and cease entirely when the structure has become full-grown; and the term "nutations" is restricted by Pfeffer to these recurrent movements during growth. In other cases periodic movements occur which are not determined by the growth of the part, but are due exclusively to the elongation and contraction of certain portions of tissue; and these latter are called by Pfeffer "movements of variation." These movements of variation which occur so commonly in the Leguminosæ are due to the action of more or less joint or hinge-like portions of the leaf. Nutations on the other hand which occur in very many leaves or petioles are due to unequal growth of the tissues, and not to the presence of a joint. As the movements of nutation are dependent on the growth of the part, they cease when growth ceases; and as the zone of maximum growth of the part changes its position, so also the seat of the nutation will vary. The movements of variation have a very different character, as they continue when the leaf is full-grown, and naturally, as they depend on a definite structure having a fixed position, they do not change their place during growth. The two forms of movement are very closely related, and jointed parts during growth often exhibit movements of nutation, thus showing the close relationship that exists between the two.

Periodic movements, whether movements of nutation or of variation, are either entirely independent of external stimuli, or are conditioned by them. The former class are the "autonomous" or "spontaneous" movements, the latter are the "paratonic" or "induced" movements—"Receptionsbewegungen," and depend on the paratonic action of external agents, as, for example, light and heat. As a consequence of the paratonic action, the leaf makes, in addition to the simple to-and-fro pendulum-like movement, certain further oscillations with decreasing amplitude, which Pfeffer calls "Nachwirkungsbewegungen" but which for want of any better word we may call simply secondary movements. It is by the help of these "secondary" movements that Pfeffer explains the peculiarities of the daily periodic movements of plants. The first chapter of the work now before us is devoted to these general remarks on the movements.

The second chapter treats of the mechanism of the induced movements evoked by alternation in illumination, the so-called sleeping and waking of plants. These movements are either movements of variation, as in the *Phaseolus vulgaris*, or they are movements of nutation, as seen in the leaves of *Impatiens noli-me-tangere* and the flowers of *Leontodon hostilis*. The measurements of the movements are made by an instrument described and figured by Pfeffer as the Lever Dynamometer.

The third chapter treats of the daily periodic movements. The subsequent chapters treat of such subjects as the mechanism of the daily movements, the intensity and internal causes of the movements, the influence of temperature and gravity, autonomous movements, and the like. A short chapter is devoted to the distribution of periodic movements. From it we learn that movements of variation are common in plants belonging to the Leguminosæ and Oxalidaceæ. All the plants of an order do not necessarily show movements of variation. Thus in the Euphorbiaceæ they occur in Phyllanthus; while in Euphorbia we have movements of nutation. A short historical review and *résumé* of results concludes this most interesting volume. W. R. M'NAB.

*Jahresbericht der Meteorologischen Centralstation Karlsruhe über die Ergebnisse der an den Meteorologischen Stationen des Grossherzogthums Baden im Jahre, 1874, angestellten Beobachtungen.* (Bearbeitet von Oscar Ruppell.)

THIS report gives a very satisfactory discussion, by copious tables and accompanying remarks, of the meteoro-

logical observations made at sixteen stations in the Grand Duchy of Baden during 1874. In addition to the tables usually printed in such reports, the temperature is given for the five-day means at all the stations. The monthly means of temperature, humidity, pressure, &c., include also the means of the separate hours of observation,—a feature of the report which deserves, from the important practical questions it throws light upon, to be more generally followed. The tabulation of thunderstorms shows each day on which these phenomena occurred at each of the stations. This method is greatly to be preferred to giving only the gross number for the separate months, since the data so published will be available in determining the periodicity of thunderstorms through the year,—an inquiry with which many interesting inquiries are intimately bound up. It is unnecessary to remark that 16 stations are miserably inadequate as a representation of the rainfall over the diversified surface of the Grand Duchy. Future reports will doubtless show a large increase to the staff of rain-observers. The daily pressure is given for two stations, Karlsruhe (404 ft.), and Höchenschwand (3,322 ft.), but unfortunately only the mean of the three daily observations is given, instead of one, or, better still, the whole three observations, it being only observations at particular hours which can be turned to account in charting the weather.

#### LETTERS TO THE EDITOR

[The Editor does not hold himself responsible for opinions expressed by his correspondents. Neither can he undertake to return, or to correspond with the writers of, rejected manuscripts. No notice is taken of anonymous communications.]

##### Dr. Richardson's Hygeia

THE eloquent address in which Dr. Richardson has sketched the possible Health City of the future might furnish matter for much discussion—among other points, the probable statistics of the community. The author contemplates the possible reduction of the death-rate to 8 per 1,000 in the first generation, and to 5 or less in the next, as suggested by Mr. Chadwick. It sounds simple enough to talk of knocking 1 or 2 per 1,000 from a death-rate, and, so long as the rate is tolerably high, such as 20 or more, the effect is not so startling, but when we come to such low figures as 8 and 5 the difference becomes enormous. Thus, whereas a diminution from 21 to 20 raises the expectation of life by only 1½ years, a fall from 9 to 8 raises it by 9, from 6 to 5 by 21 years, and from 5 to 4 by 40 years. We should thus have at 8 per 1,000 death-rate an expectation of life of 86 years, and probable mean duration of 120, whilst there would be cases of old people living to 160. Again, at 5 per 1,000 the ages would be respectively 137 years for expectation at birth, and old people living on to 250; at 4 per 1,000 the expectation would be 177, and old people would live to beyond 330. Compare these figures with Dr. Richardson's closing address, where he claims a modest 90 years as the proper length of human life.

Another aspect of the case is the probable increase of population, which we may thus calculate:—The mean birth-rate of England for the last 35 years is 33·8; if the death-rate be 5 the net increase would be 28·8 per 1,000. At this rate the population of Great Britain and Ireland would reach 66,000,000 by the year 1900, and, by the year 2000, no less than 1,120,000,000, or about the present population of the inhabited globe. At the same time the model City of Hygeia would more than double itself by the end of the present century, whilst, by the end of the next, its population would be 3,450,000, or as nearly as possible that of our overgrown metropolis. What check does Dr. Richardson contemplate to this inordinate hypertrophy? F. DE CHAUMONT

##### Photography in the "Challenger"

WHEN the *Challenger* was fitted out, I was asked to prepare certain special dry photographic plates to go with her. I wished to give them the sensitiveness of wet collodion and unlimited keeping qualities, and the following letter from the chief photographer on board is very satisfactory. The stains alluded to on

some occur from the shifting of the packing papers, and the faces of two plates then coming in contact :—

“H.M.S. *Challenger*, Yokohama, 15th June, 1875.

“Sir,—It gives me great pleasure to acquaint you that the dry plates supplied to this ship three years ago are working well, being *fully* sensitive, notwithstanding the great trial that they have been subjected to—extreme cold and heat. On some plates I found damp spots on the film, which stain the picture, and hence I discard them; but, on selecting plates, I travelled up 2,500 feet (where the wet process seemed impossible) and obtained *perfect* negatives. I would suggest that more substance be placed between the plates, as I have found them sticking together, and hence the same spots on each plate. I am using your new developer, which works well.

“I remain, yours obediently,

(Signed)

“JESSE LAY, Photographer.

“To Col. Stuart Wortley.”

If at any time any scientific worker may be contemplating an expedition where highly sensitive dry photographic films might be of use, I shall be glad to place my experience at his disposal, and give him formulæ on which he can thoroughly and implicitly rely.

H. STUART WORTLEY

Patent Office Museum, South Kensington, Nov. 8

### Bees and Clover

IN NATURE, vol. xii. p. 527, it is stated that two nests of English humble-bees have been sent out to New Zealand, and that they are specially desired there for the purpose of fertilising the common clover. I suppose the red clover is meant, as the white is fertilised by the hive-bee, and the wonderful rapidity with which it has spread over the Australian colonies proves that it does not require any further assistance.

The species of *Bombus* sent out is not mentioned in the paragraph, and it is not likely that Mr. Frank Buckland would send the wrong one; but it is worth pointing out, as not being generally known, that the commonest of the humble-bees (*Bombus terrestris*) does much more harm than good to many of our flowers. I have for several years watched the humble-bees, and I never saw this species go to the mouth of the corolla of the red clover. As far as my experience goes, it invariably bites a hole at the base of the flower and extracts the nectar from that opening, so that it is of no use in carrying the pollen from one flower to another. All the other species of humble-bees that I have noticed go to the mouth of the flowers, and they alone are useful in their fertilisation.

The common scarlet-runner or pole-bean is entirely dependent on the visits of bees for the fertilisation of its flowers, and I have lately seen an instance where the attentions of *Bombus terrestris* were mischievous and hurtful. A friend of mine, living near Finchley, had a late sowing of scarlet-runners rendered barren by their operations. The smaller humble-bees did not visit his garden, and *Bombus terrestris* cut holes at the base of both the expanded flowers and the unopened buds. The hive-bee with some trouble, by pushing between the petals, can get at the nectar and sometimes fertilises the flowers, but as soon as the humble-bee commences to cut holes at the base it seeks for these perforations as a readier means of access.

At the beginning of the season some of the *Bombus terrestris* will be seen visiting the flowers of the scarlet-runner in a legitimate manner, but they soon learn that it is easier for them to get at the nectary by cutting holes at the base, and later on their acquired experience teaches them to attack the buds in the same manner. Large gaping flowers such as the Nasturtium and the Fox-glove are fertilised by this species, but to most of the narrow tubular ones its visits are injurious.

I hope therefore that it is not *Bombus terrestris* (the common large yellow-banded kind) but some other species of the genus that has been sent to New Zealand, and if so it will be a most valuable addition to the fauna of the country should it be successfully acclimatised.

In sending humble-bees to a distant country I believe the best plan would be to dig up the fertilised queens, in winter, out of the ground where they hibernate, and forward them in their dormant state packed in earth kept cool by ice.

Cornwall House, Ealing

THOMAS DELT

### Cherry Blossoms destroyed by Squirrels

THE very general interest exhibited in your columns some time since in regard to the destruction of flowers by birds, leads me to report the following observation.

I have noticed repeatedly here in New England that the common red squirrel (*Sciurus Hudsonius*, Pall.) is extremely fond of flowers, and I am inclined to believe that in this immediate vicinity he destroys far more flowers than any bird. The squirrel in question, though smaller than the common squirrel of Europe (*S. vulgaris*, Linn.), bears a close resemblance to the latter. We have field-mice also whose habits so closely resemble those of the squirrel that it seems highly probable that mice as well as squirrels often aid in the destruction of flowers. For cherry blossoms in particular our squirrel has a well-nigh insatiable appetite.

Having lived for several years upon the edge of a considerable belt of woodland, I have been surprised to witness the extent of the devastations of the squirrel in this particular, and have watched their operations with no little interest. The flower is bitten from its stalk precisely as a nut would be, and held between the paws of the animal while the little ovary at the base of the blossom is eaten. All this is the work of but a moment, since the edible morsel is exceedingly minute. The flower is then dropped to the ground, seemingly in a perfect state, since the petals are untouched, and remain adhering to the calyx. I have noticed that one squirrel working by himself will destroy in this way two hundred blossoms or more in the early morning of a single day. On examining the discarded flowers it appeared that they were in no wise mutilated excepting that the ovary had been bitten from the pedicel in every instance. Freshly opened flowers seem to be preferred. At all events the very first blossoms of the spring are eaten, and the destruction of flowers is largest in the early days of the blooming. As soon as the flowers have become somewhat mature, the squirrels leave them, and they neglect the immature cherries also until near the time of ripening, when they again attack them, both for the sake of the fleshy part of the fruit and of the kernel. With respect to the fruit, however, the squirrels are far less harmful than birds, since the latter descend upon it in overwhelming force. The red squirrel has long been detested by American gardeners because of his destruction of pears, the choicest of which he gnaws in two, for the sake of their seeds merely, but I am ignorant whether anyone has hitherto called attention to his fondness for the blossoms of fruit-trees.

I have occasionally noticed the rose-breasted grosbeak (*Guiraca Ludoviciana*, Linn.) plucking cherry blossoms, or perhaps the unopened flower-buds, at the same time with the squirrels, but the birds ate leaf-buds from an adjacent ash tree as often as they ate the cherry flowers, and the number of blossoms destroyed by the birds was insignificant in comparison with the work of the squirrels.

F. H. STORER

Bussey Institution of Harvard University, Oct. 20

### Plagiarism

A FRIEND has just called my attention to the letter of Mr. Boyd Dawkins in last week's NATURE under the head of "Plagiarism." Mr. Dawkins may have found out by this time that he has made a mistake to my detriment, but I am bound to reply to his letter.

The map accompanying the article "The Early Geography of the British Isles" (*Leisure Hour*, July 1874), which Mr. Boyd Dawkins says is a reproduction of one he published in 1871, is in reality the well-known map first issued by Sir Henry de la Beche more than forty years ago, with the addition of hypothetical river-courses (indicated in the first instance by Mr. Godwin-Austen) and submerged forests, the said river-courses having since been more completely and strikingly portrayed by Mr. Dawkins, whilst I have added to the submerged forests.

The *Leisure Hour* map is thus a composite production. Beneath it, so far from there being no reference to its various authors, are the words: "After Sir Henry de la Beche and Mr. Godwin-Austen, F.R.S." (I regret to find Mr. Dawkins's name is not placed on the map as well); whilst in the text of the article are the words: "See a paper by Mr. Boyd Dawkins, F.R.S., in 'Hardwicke's Popular Science Review' for October 1871."

I can only suppose Mr. Dawkins had not given due attention to the *Leisure Hour* map and its accompanying article when he wrote his letter off San Francisco. If he had, I disallow his exclusive claim to the one hundred fathom line of the British seas, the submerged forests, and (with the modification above mentioned) the hypothetical river-courses.

8, Watterton Road, W., Nov. 8

HENRY WALKER

Curious Australian Implement

IN NATURE, vol. xii. p. 544, a correspondent points out the resemblance existing between an implement used by the Ute Indians and one belonging to the Australian natives, which he calls a vermin hook. May I venture to suggest that he may possibly have mistaken the use of the latter? It appears to me to be identical with the instrument used by all the Australian "river" blacks to throw their light reed spears with, which consist of a heavy miall wood point and a shaft of reed. The bone hook is inserted in the head of the reed, the spear resting between the forefinger and thumb of the hand that holds the thrower and lying parallel to it, thus :—



the spear being propelled from the hooked end of the thrower, which is rapidly brought forward into a vertical position, thus propelling the spear before it. During several years on the different Australian rivers, I saw the weapon universally used as above, but neither there nor elsewhere in the colonies for any other purpose.

J. P. GLOVER

Derby, Oct. 29

OUR ASTRONOMICAL COLUMN

VARIABLE STARS.—The following are the Greenwich mean times of geocentric minima of Algol, occurring before 14h., to the end of the present year, according to the elements employed by Schönfeld for his later ephemerides :—

	h. m.		h. m.		h. m.
Nov. 14	11 42	Dec. 4	13 24	Dec. 27	11 57
„ 17	8 30	„ 7	10 13	„ 30	8 46
„ 20	5 19	„ 10	7 2		

The first heliocentric minimum in 1876, with the epoch and period of Schönfeld's second catalogue of variable stars (1875), occurs on January 2, at 5h. 34.5m. G.M.T., or January 2.23226; the minima throughout the year will be obtained by the successive addition of 2<sup>d</sup> 86729. For times of geocentric minima, corrections must be applied to the times so calculated, which may be found from

Corr. to heliocentric minimum = 7.67m. R. sin. (S + 35°.69),

where R is the earth's radius-vector at the date, and S the sun's longitude.

The period of Algol, which had diminished since 1782, at first slowly, but afterwards more rapidly, after remaining constant or nearly so for a time, appears to be again slowly diminishing.

According to Schmidt, of Athens, the brightness of Algol is equal to that of δ Persei about 47 minutes before and after minimum, to that of ε Persei about 62 minutes before and after the same, and to that of β Trianguli 95 minutes before and after. The fluctuations extend over about 9½ hours.

There is a suspicion of variability about the light of the small companion of this star, first remarked by Schroeter. Smyth measured it in 1835. During the last two years it has sometimes been readily visible and at others discernible with difficulty with the same instrument; but a systematic course of observations is required to decide if there be a real variation.

According to Schönfeld, S Cancri will be at a minimum on Nov. 14 at 16h. 50m., Dec. 3 at 16h. 3m., and Dec. 22 at 15h. 17m. G.M.T.

For U Geminorum it appears very difficult to make a prediction likely to be of any service, so that very frequent examination is necessary for the determination of the times of maximum. Mr. Otto Struve states that this object does not usually disappear in the Pulkova refractor. Schönfeld thinks the period varies between 70 and 150

days. A secondary minimum has been remarked on several occasions about the time of greatest light. In most periods the star has not continued visible in ordinary telescopes more than a fortnight, and occasionally less. Winnecke has given a list of the small stars in the vicinity of U Geminorum, which will be useful in its identification (See *Astron. Nach.*, No. 1,120). At maximum this star is a little brighter than an average ninth magnitude in Bessel's scale.

THE MINOR PLANETS.—There are this week three additional discoveries to record. No. 151, by Palisa, at the Observatory of Pola on the Adriatic on Nov. 1, place at 13h. 24m. local mean time in R.A. 3h. 2m. 17s., and N.P.D. 71° 40'; No. 152, by Paul Henry, at Paris on Nov. 2, place at 11h. in R.A. 2h. 38m. 17s., N.P.D. 74° 35'; and No. 153 by Palisa, on Nov. 2, place at 12h. 40m. in R.A. 3h. 1m. 28s., N.P.D. 72° 25'; all three are of the twelfth magnitude, or somewhat fainter. In Prof. Tietjen's Berlin Circular he transposes the above numbers for the planets discovered on Nov. 2, but upon what ground does not appear; according to the times of observation given in the first announcement of discovery, the Paris planet should precede that detected at Pola. No. 150, which was found by Watson at Ann Arbor on Oct. 19, soon after his return from Europe, has been observed at Berlin, Düsseldorf, Leipsic, and Pola, and No. 151 on the night after discovery, at Berlin.

Though in certain cases it may be necessary to use caution in announcing the discovery of a new small planet, the actual positions of several of those already observed being very imperfectly known, there appears every probability that the three just brought to light are really new. No. 138 (Tolosa) is probably near the ecliptic in 3h. R.A., but some thirteen or fourteen degrees to the east of Palisa's objects, as will be found from the elements of Gruber, calculated upon the six weeks' observations in June and July 1874. The rough approximations to the orbits of Dike and Camilla at present obtained, place the former in the 5th hour of R.A., and upwards of 34° N. of the equator, and the latter at the beginning of the 4th hour, but at a considerable distance from the ecliptic, or with a N. declination of 8° or 9°. The position of No. 137 (Melibœa) is open to great uncertainty, the observations so far published extending over sixteen days only, and an orbit founded upon them would be of little service so long after the date of observation. A circular orbit appears to have been computed by Dr. Becker at the time, as he published a short ephemeris in the *Astronomische Nachrichten*—but the elements were not appended. Even with the shortest period yet assigned to any member of this group of planets, Melibœa would hardly be so far advanced in R.A. at the present time.

No. 97 (Clotho), in opposition on Nov. 9, is now very little below an eighth magnitude in Argelander's scale. The calculated places for Berlin midnight are—

	h. m. s.		h. m. s.
Nov. 12	R.A. 3 22 2	N.P.D.	93 30
„ 16	„ 3 19 1	„	93 52
„ 20	„ 3 16 2	„	94 9
„ 24	„ 3 13 12	„	94 20
„ 28	„ 3 10 35	„	94 24

BESSEL'S WORKS.—With No. 2,061 of the *Astronomische Nachrichten*, Dr. Engelmann, formerly attached to the Observatory of Leipsic, issues a prospectus of an important astronomical publication, entitled "Abhandlungen von Friedrich Wilhelm Bessel," in which it is intended to reprint a selection of upwards of 130 of the more important papers, &c., of the great Königsberg astronomer. Many of these are now scattered in works which are often costly and difficult to procure, and the proposed collective edition of the principal memoirs cannot fail to be of vast service to the astronomical student. The selection which has been made will be contained in three

volumes, the first of which is to appear in the present month, the second in the spring, and the third during the summer of 1876, and will be arranged under the following divisions:—(1) Motions of the Bodies of the Solar System; (2) Spherical Astronomy; (3) Theory of Instruments; (4) Stellar Astronomy; (5) Mathematics; (6) Geodesy; (7) Physics, and (8) Various. A portrait and short life of Bessel is to be attached to the first volume. Dr. Busch's complete list of Bessel's works, inclusive of astronomical notes in various scientific periodicals, as the *Monatliche Correspondenz* of Zach, the *Berliner Jahrbuch*, &c., which is appended to vol. xxiv. of the Königsberg Observations, contains 385 titles; but many of the shorter contributions being of minor or ephemeral interest, it is probable that the selection proposed will include all the writings of the illustrious astronomer which can now possess value.

AMONG THE CYCLOMETERS AND SOME OTHER PARADOXERS\*

II.

MR. H. HARBORD, who hails from Hull, has put forth three letters, with which we have been favoured. "The Circle Squared" (in November 1867) has, we guess, been noticed by Prof. De Morgan. There is a nicely drawn diagram, two concentric circles, two squares, said to be their respective equivalents, all in black; an equilateral triangle and its circumscribing circle in red ink; the former is described on a side of the smaller square, and the red circle passes through the extremities of the same side. A statement is made, which appears to be a statement and nothing more, for it proves nothing. From "Squaring the Circle" (April 15, 1874) we learn that the writer has leisure (*fous et origo mali!*), and so has ventured to amuse himself by considering the relation of the equilateral triangle, the square, and the circle. He obtains the positive altitude of an equilateral triangle on a side of the square to be 775448559771125, and requires the exact side of the square and the proportion of the triangle to the square and the equivalent circle. He winds up, like many of his race, with the following reflections:—"I think if the learned in geometry, mathematics, and trigonometry, abandoned approximating theories, and would take the trouble to elucidate the above-stated propositions, they would undoubtedly be able to subvert all anomalous and vague theorems, free the study of geometry, &c., from ambiguity, enable tutors to explain correctly, remove burthens imposed on the mind of the pupil, and establish a system of teaching which shall be correct and intelligible, for it is evident the result of minute calculations proves there is no mystery in geometry, mathematics, or trigonometry; they are uniform, and may be more easily taught and comprehended with perfect truthfulness without approximation." To prevent trouble, this man of leisure appends the rule; it is: Add one-seventh to the altitude, and we get the base; and so on. Not satisfied with the above remarks, we have a note to the "learned" (see above); and it is the following curious sentence:—"It is worthy of remark, and more especially to those who are interested in the forthcoming 'Transit of Venus,' when the true distance of the earth from the sun is to be determined, and a difference of about three millions of miles accounted for, to be in a position to prove the fact. Now all this can be accomplished by anxious, minute observation and correct calculation!" He then appends (we don't see the connection): "Length of an arc of one degree, '017 . . . to twenty-seven places final." We got the last communication a few days ago; it is, "Construction of the Perfect Ellipse" (Dec. 22, 1874). This is a fine large figure on a sheet of paper some eighteen inches by fourteen. He finds that the true

ellipse is only to be described on the perpendicular of the equilateral triangle. Mr. Harbord has evidently an idea, and that is, that the equilateral triangle is the key to unlock many geometrical mysteries.

Mr. Michael Callanan, of Cork (September 1874), "is in a position to demonstrate before any appointed number of scientific gentlemen, the perfect quadrature of the circle, rendering it as clear as the most simple, plain (*sic*) rectilinear figure. The Circle, that colossal mystery, to prove the area of which has been looked upon as the climax of geometrical science; and, although the object of search by the mathematicians of all nations, their greatest efforts have failed; every attempt, as yet, to square the circle being undemonstrable, and offering no reward to the anxious investigator beyond mechanical or approximate measurement—a manipulation of the great problem. My solution will be found original and thoroughly demonstrative in all its details, without having anything whatever to do with the given or polygonal rules for approximation. Entirely new ground is opened up in the path of science which I have chosen, guided only by positive mathematical laws, combined in the most strict logical arrangement, and thus *proved to demonstration*. I now proclaim the absolute fact of being able to set aside for ever any further doubt as to the complete quadrature of the circle, and thereby confound those scientific prophets who pronounced it an impossibility." Local circumstances offer many impediments in bringing the matter before the scientific world, and "being a geometrical secret, the law of Patent cannot be applied." He then puts himself in the same position with other inventors and discoverers, but he asks for an accredited tribunal "from which I would ask an impartial hearing, so as to verify these statements, and also to be identified and protected as the discoverer." For this end he is willing to attend at any selected place in England, Ireland, or Scotland. He then glances at some of the immediate results in the realisation of this problem. "At the proper time will be published a comprehensive work, including all the new diagrams necessary to carry out and complete the demonstration." And this is all we know of Mr. Callanan's "Secret of 'the Circle' solved."

Our next claimant for notice is not a Circle-squarer, but he would certainly have got a warm corner in the "Budget." Middleton's "new process of measuring the height of the sun," an observation for latitude demonstrated by geometry, proving the sun's height less than the latitude of observer. On this leaflet our paradoxer says, "the sun's height is under 3,000 miles." The principles of this discovery are published in the *West Londoner*. Mr. Empson E. Middleton, *Poet* (Naval and Military Club), sends us a further document (May 5th, 1873): "£100 Reward to the first who disproves the following Diagram—Middleton's Geometrical Proof that the Earth is Flat." Proof is said to turn upon the SPHINX SOLUTION,—"a globe demands six cardinal points." Having disposed of this point to his satisfaction, he "challenges all the mathematicians to support their statement that a perpendicular line and a line at right angles are the same; one is *flat*, the other *upright*. I undertake to prove that the perpendicular line is *not* the same as a line at right angles, though the two are utterly confused in every school-book of the day. I undertake to meet in public and to confute any of our mathematical professors who may have the manliness to come forward and discuss this question of the perpendicular, a question which forms the fundamental basis of the whole science of geometry, and is of the very first importance. I remain faithfully, to the Majesty of Truth." Mr. Middleton has published a translation of "the first two books of the *Æneid* of Virgil" to supersede Mr. Conington's (*sic*); he has a work "On Space" unpublished, and one "On Man" awaiting demand.

Naturally, after this we should turn to Parallax, or to

\* Concluded from vol. xii. p. 560.

Mr. John Hampden, but we have preserved nothing from either of these paradoxers. The former has gained notice in the *Budget* (we are sorry to record the recent death of another able opponent of these views, Mr. T. T. Wilkinson, F.R.A.S.); the latter has figured before the public in the daily papers. A consequence of Mr. Wallace's acceptance of Mr. Hampden's wager is that the former gentleman has for nearly five years been the subject of continuous libels (see letters in *Daily News*, March 11, also March 9). It is to be hoped that an enforced retirement of a twelvemonth will result in Mr. Hampden's learning wisdom and the keeping of the peace towards Mr. Wallace and all others.

In De Morgan's account of Taylor the Platonist (*B of P.* pp. 182, &c.) there is nothing said of an early work of his, "The Elements of a new method of Reasoning in Geometry applied to the rectification of the Circle" (1780), "a juvenile performance lost or suppressed" (biographer in *Penny Cyclopaedia*). We have examined this work, but it is impossible to give an account of it here; the solution is approximative.

The malady (*Malus cyclometricus*) is not confined to the Old World; our concluding instances will be drawn from a Geometry published at New York, and from a treatise specially devoted to the subject and printed at Montreal. We have not a copy of Mr. Lawrence S. Benson's "The Elements of Euclid and Legendre, with Elements of Plane and Spherical Trigonometry," but he has sent us "A Reply to Criticisms on Benson's Geometry." This will answer our purpose better, for the defence shows that the malady is confirmed. The symptoms are even more exaggerated than in Mr. J. Smith's case, for whereas his circumference ("Budget," p. 318) shrank into exactly  $3\frac{1}{2}$  times his diameter, Mr. Benson's has shrunk to only 3 times! Where all this will end if the malady increases it is hard to say; perhaps the unfortunate circle will shrink up into its own centre! Opponents had pointed out "that when the areas of polygons inscribed in the circle are computed by means of plane triangles, a result is obtained for the inscribed polygons greater than  $3R^2$ ," and they reasoned (it seems to us irresistibly) "that it is impossible for a circle to be less than a figure inscribed in the circle." Mr. Benson trusts, however, that after fourteen years' application to mathematics he will not be thought to have committed so egregious a blunder as to bring himself into direct contradiction of the self-evident proposition, "A part is less than the whole." He commences his defence with the statement that Torelli contends that the circle will be proved to be the square on its diameter exactly as 3 to 4. He then goes on to instance that Playfair ("Euclid," p. 307) demonstrates that Torelli's proposition is true on two conditions. Is it credible that Mr. Benson should proceed to say: "The fact that the proposition is true 'on two conditions' prevents the proposition from being false, for a false proposition can be true on no condition." The conclusion of the whole matter is that he replies to the inquiry, "How is it that reasoning from plane triangles for the computation of the areas of polygons, and reasoning from the ratios of rectangles, when they are all rectilinear magnitudes, that different and conflicting results are obtained?" that "the reasoning on the ratios and rotation of surfaces involves their relation to each other; whereas the computation of the plane triangles involves their boundaries: and since for the QUADRATURE OF THE CIRCLE the relation between the circle and a certain rectangular space is required, it is evident that the proper mode of reasoning is by means of the relation of the ratios of the small rectangles inscribed in the circular spaces to the ratios of the sums of those rectangles, or of the whole rectilinear figures; or by means of the rotation of rectilinear and curvilinear surfaces around a common axis—and not by the process of continually doubling the number of sides of the polygons described about the circle; since the sides do not

reach the circumference, this process gives an approximate result only, which is inconsistent with the strictness of geometrical reasoning." We do not profess to follow the writer's reasoning, but hold fast by the *terra firma* which he appears to discard.

"The Circle and Straight Line" is a work got up in an elaborate and elegant dress: it consists of Parts I., II., III., and a supplement in brown binding, and a duplicate of the supplement in green (there is a portion of a flyleaf additional in the former supplement, or else the two copies appear to be identical). Further, there is with each a book of plates, all most clearly drawn, and the diagrams protected by slips of tissue paper. Evidently the author, John Harris, or Kuklos, is not a needy man. Let us gather from Mr. Harris's preface the object he has in view. Deeming the solution of the geometrical problem which demonstrates the relation of the circle to the straight line to be peculiarly of public importance, he gives a statement of what he has done in the matter. "The discovery of the solution was communicated by letter, dated 29th of December, 1870, accompanied with demonstration, &c., to the Astronomer Royal." There was, the author admits, imperfection and error in the case as then presented. The Astronomer Royal declined to examine the case. In January 1873 the papers were presented to the President of the Royal Society (still Sir G. B. Airy), "with a request (claim) in writing to have the case judicially examined by that Society." The documents were returned; they met with a similar fate at the hands of the Professors of M'Gill College. The subject is to describe a circle (or circumference) equal in length to a given straight line, and to draw a straight line equal in length to the arc of a circle, "accompanied with demonstration that the conditions of the requisition have been mathematically fulfilled. We publish our solution with the distinct statement that it is essentially in strict accordance with that scientific system known as Euclid's. We claim to have our demonstration admitted or disproved, and we challenge objection or adverse argument on that system." We shall first convince our mathematical readers, on Kuklos's own summing up ("Corollary," p. 34), that he is wrong, and then, on the charitable supposition that he is willing to be convinced, point out where we consider he has failed. We shall take the last sentence of the Corollary cited above: "Wherefore, if a square be inscribed in a circle, the ratio of the inscribed square to the circle is the ratio of nine to ten." It will be seen that this gives for the value of  $\pi$ ,  $\frac{20\sqrt{2}}{9}$ , that is

$3\cdot142696$ ; not a very close approximation to the accepted value. But, of course, in arguing with Mr. Harris we must go over his work and point out, if possible, where he has tripped. We commence with enunciating his Theorem A: "If an arc containing one-eighth of a circle be applied upon a straight line, and from the terminal extremity of the arc a perpendicular be drawn intercepting the straight line, and if from the arc one-tenth thereof be cut off, then, if the remaining arc (to wit, the arc containing nine-tenths of the whole arc) be rolled upon the straight line, the point of contact shall be the same point on the straight line intercepted by the perpendicular drawn from the terminal extremity of the whole arc."  $BM$ ,  $Bn$  are taken to be the two arcs, and  $O, d$  are taken to be the corresponding points to  $M, n$ , on the tangent at  $B$ , also  $D$  is the foot of the perpendicular from  $M$  on the same tangent. Mr. Harris's object is to show that  $Dd$  coincide: if they did, then we would admit that he has proved his point; but on p. 22, line 13 (all his previous working having been sound, though somewhat tediously put), he has " $cd$ " instead of  $CD$  (his  $cd$  is a misprint, we presume, for  $Cd$ ), and then easily gets to his desired conclusion. We would ask him *how* he gets " $Cd$ ." Again, on p. 24, third line from bottom of page, we tell him that " $DO$  is one-tenth of  $BO$ " is a coo

assumption, and we also ask him how he gets the last line on p. 27. These crucial points occur in "independent proofs" of the same theorem; they are pure "beggings of the question," we believe. This is all we have to say on Part I. Part II. opens with an admirable motto (reminding us herein of Mr. James Smith), "Prove all things; hold fast that which is good." Having proved then the previous theorem, he holds fast to that, and proceeds to the "construction of the circle;" his object being "to make manifest the great importance of the circle as one of the fundamental facts belonging to the Plan of Creation." As we consider the foundation wrong, until Prop. A is proved, we shall not follow the writer through the twenty-four pages of rather obscure mathematics devoted to this subject. We come next to "Mathematics and the Art of Computation." Starting from what he has (as he thinks, we will say) just proved, viz., that "the difference of the quadrant and the chord of the quadrant is an aliquot part of the quadrant and of the chord, and that the number of those equal parts contained in the chord being nine--the quadrant contains ten": because he finds in this "conclusive evidence that the (so-called) Arabic system of notation is is not an artificial human contrivance, but a great natural fact of a primary character, a fundamental part of the Science of Creation." Further down he speaks of many persons preferring "with a strange, and, as it would seem, with an increasing perversity, to cultivate the thorns and thistles, leaving the good seed as not worth utilising." He is then careful to state that by "thorns and thistles" he does not mean the modern methods of mathematical analysis. Still, "is it, or is it not, true that the language of mathematics is fast becoming an unknown tongue to ordinarily educated men, and that those to whom it is known can scarcely hold converse with their fellows (on any scientific subject) in ordinary language without a feeling of condescension, and scarcely without a feeling of impropriety? . . . Is it true that the mathematician does now, in some degree, regard his fellow-worker who is unpractised in the calculus and non-conversant with differential methods as but little better than a publican and heathen?" We will not undertake to answer this question, but perhaps our author's ground for this opinion is the reputed division of the human species by the "Cambridge Wrangler" into those who understand the differential calculus and those who do not. He himself goes on to say, "If it be true that such a result does manifest itself in any considerable degree, it may be pronounced decidedly unwholesome and bad--bad for science and bad for civilisation--because mathematical knowledge is a necessity to science and a necessity to civilisation." This we admit. He then reiterates the statement that he knows that examination will show his demonstration of the quantitative (*sic*) ratio of the perimeters of the circle to the diameters is "mathematically incontestable." He then goes into an examination of Prop. XIII., Book V., of Brewster's Legendre: "The surface of a regular inscribed polygon and that of a similar polygon circumscribed, being given, to find the surface of the regular inscribed and circumscribed polygons having double the number of sides." Among other objections, he objects to the italicised statement (Prop. XIV., "Legendre"), "We shall infer that the last result expresses the area of the circle, which, since it must always lie between the inscribed and circumscribed polygon, and since these polygons agree as far as a certain place of decimals, must also agree with both as far as the same place." His objection to the whole method is "in the omission to observe that comparison has to be made between a continuous curved line (the circle) and a continuous straight line (the diameter)." And then, as elsewhere, he indulges in metaphysics. Part III. begins with Curvature and ends with Theology. "A human science which does not distinctly recognise the primary truths of theology as its ultimate

basis, is not based on reality; it has not and cannot have any actual and secure foundation. If the science of England is not so based, no matter what seeming progress may for a time be made, whenever the trial comes it will be as the house built on the shifting sand, and, if not destroyed by sudden catastrophe, will eventually become a ruin, together with the civilisation which rests upon it." Our safety then, we presume, Kuklos would have us believe, is to believe in  $\pi = \frac{20\sqrt{2}}{9}$ . The supplement has "Supplementary Illustrations" and Tables. The work is printed at Montreal.

The conclusion of the matter is, that there are Cyclo-meters and Cyclometers. We have endeavoured to give a fair presentment of the several kinds by giving as far as possible their views in their own words. The majority of their writings evidence great waste of ingenuity, which, had it been otherwise directed, might have resulted in works of utility instead of in such utterly trivial work as it has done.

To any who may be thinking of taking up this "curiosity of literature," not having done so hitherto, we say emphatically, "Don't."

### SCIENCE IN GERMANY

(From our own Correspondent.)

IN Wiedersheim's recently published book, "*Salamandrina perspicillata* und *Geotriton fuscus*," two very little-known tailed amphibians (Urodela) are described and compared anatomically, which, by their entire organisation, stand at the two opposite limits of the Salamandrinæ that are known to us, representing the highest and the lowest form of these. *Salamandrina perspicillata*, which is rather a land than a water animal, seems to be found only in the western half of Italy; it is a prettily coloured, small, and slender animal, which lives on insects, and during the dry summer months continues in a kind of summer sleep, but in winter it is found in full vital activity. In its skull are almost entirely wanting the cartilaginous parts denoted as the "primordial cranium," so that in this it rises above all other Salamandrinæ, and comes near the Reptiles. In accordance with this, also, is the existence of a cavity in the base of the skull (*sella turcica*), the prolongation of the frontal bone (*frontale*) into the eye cavity, and a roofing-over of the latter; lastly, the absence of a special nose-partition (which, again, quite characterises the Reptiles). On account also of the course of development of its vertebrae, and the numerous bones of its carpus and tarsus, *Salamandrina perspicillata* must stand at the top of the Salamandrinæ; its divided kidneys, again, suggest the reptile, so that we must look on this animal as a form rendering



Tongue of *Geotriton fuscus*.

possible the transition from the Amphibia to the Reptilia, and which, on account of its peculiarities, might represent a separate family. *Geotriton fuscus*, on the other hand, holds quite a different position. If, in view of the numerous anatomical relations added, we are able, commencing with *Salamandrina perspicillata*, and passing through the various water salamanders (Tritons), to the land salamander (*Salamandra maculata*), to form a descending series of ever less-developed forms, *Geotriton fuscus* comes at the lower end of the series, for in many respects it ranks with the lowest Amphibia generally, the Perennibranchiata. Indications of this appear in the fensness of bones in the skull and the tarsus, the extended double cone form of the soft-cartilaged vertebrae;



then, too, the joint processes are wanting, &c. On the other hand, *Geotriton* is distinguished in the most peculiar way, by one organ, from all other Amphibia, viz., by the tongue. This is a pedicelled disc, like a mushroom, on the bottom of the mouth cavity, where it is connected with the tongue-bone apparatus; the latter, however, does not merely consist of the same parts as in other Amphibia, but at its two hinder ends there is attached on either side a long thin cartilage, which reaches, free between the neck muscles and the skin, as

far as the back, and is enclosed in an envelope of special muscles, which are only attached at its hinder end and in front to the rest of the tongue-bone. If, now, this muscle be contracted, it thrusts out the cartilage rod, and with it the tongue, in a way similar to that observed in Chameleons, Woodpeckers, and Ant-eaters. Compare the annexed drawing. Thus Nature connects in the most remarkable manner a complicated organ of the higher Vertebrates with the organisation of amphibians that evidently stand very low.

EVIDENCES OF ANCIENT GLACIERS IN CENTRAL FRANCE

WHEN visiting the Mont' Dore district, in Central France, with Prof. Huxley in the summer of 1873, my attention was accidentally directed to some magnificent transported boulders occupying the floor of an ele-

ivated valley due south of the highest ridge of the Pic de Sancy.

These, though gigantic, and occupying a very conspicuous position, in every respect similar to positions occupied by deposits from ancient glaciers in Switzerland and in all other Alpine regions, are not alluded to in Le Coq's exhaustive work on Central France, or his geolo-



FIG. 1.—Transported blocks in the Tranteine Valley, Mont Dore. Mountains of Cantal in the distance.

gical map appended thereto; nor are they in either of Mr. Scrope's works on the Volcanoes of Central France; nor can I obtain any information regarding them from those of my geological friends who are most versed in glacial phenomena.

Under these circumstances, though still of opinion that they cannot have escaped the notice of French observers, if not writers, on the geology of France, I may assume that they are of sufficient novelty and interest to render the accompanying notes and sketches acceptable to the readers of NATURE.

Under these circumstances, though still of opinion that

The well-known lofty range of Mont Dore is described



FIG. 2.—Transported block in the Tranteine Valley, Mont Dore (estimated length 36 feet). Pic de Sancy (N.) in the distance.

by Scrope ("Volcanoes," ed. ii., p. 362) as a mountain mass rising in its highest peaks more than 6,200 feet above the sea-level, composed of beds of trachytic and basaltic lavas, alternating with their respective conglomerates. And again, in his "Volcanoes of Central

France" (ed. ii., p. 124), the same author says of the figure of the mass, that it is best understood by supposing seven or eight rocky summits grouped together within a circuit of about a mile in diameter, from which, as from the apex of a flattened and somewhat irregular cone, all

the sides slope more or less rapidly, the mass being deeply and widely eaten into on opposite sides by two principal valleys, those of the Dordogne and the Chambon.

It is with the southern valley, or that of the source of the Dordogne river, that we are concerned, the head of which occupies a noble amphitheatre facing the south, immediately under the highest summit of Mont Dore. My companion and myself were on our way to the summit of the Pic de Sancy, from the village of Latour about seven miles to the westward; we were skirting the rocky and very steep sides of the amphitheatre at an elevation of some 5,000 feet, and were enjoying the view of the snow-streaked mountains of the Cantal which bounded the horizon to the southwards at nearly forty miles' distance, when my attention was arrested by some large objects on the broad and level (as seen from a height) floor of the valley at our feet. They were presumed huts, haystacks, or glacially transported blocks, and their position in reference to the head of the valley and amphitheatre,

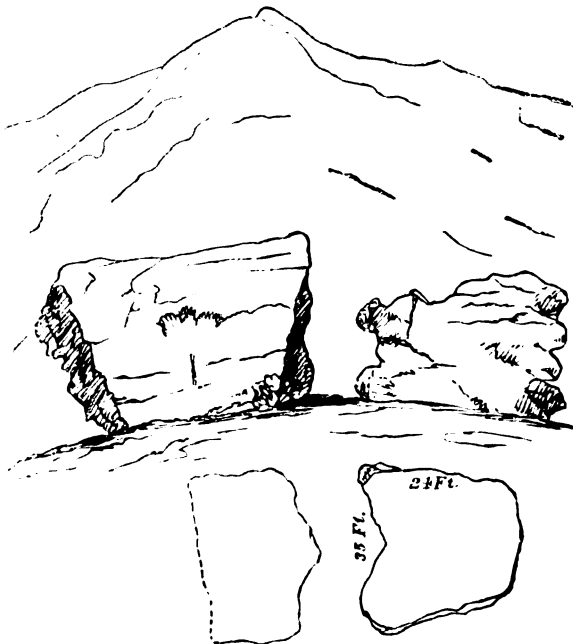

FIG. 3.—Transported block split into two pieces in the Tranteine Valley, Mont Dore.

theatre so strongly inclined me to the latter view, that I determined on visiting them before leaving the neighbourhood. Accordingly, on the following day, I took the high road to Latour, south-eastward to the village of Chastail. Then leaving the road, I descended and crossed a small stream to the eastward. The ascent of its steep opposite bank led through beechwoods to a broad flat ridge with some cheese-makers' huts upon it, from which, still proceeding eastward, I descended by a gentle slope immediately upon the floor of the valley, and found myself amongst a group of magnificent boulders that had evidently been deposited by an ancient glacier which had flowed from the rocky amphitheatre at the head of the valley.

The blocks were of trachyte, and what I took to be domite, of the same nature as the rocks towards the top of the pic; they were scattered over an undulating surface, which I guessed to be about half a mile long by a quarter of a mile broad, and occupied both the floor and the very gentle slopes of this part of the valley, up to perhaps 200 feet above the stream. Others were seen further down the valley, which however soon contracted; its

stream, which meandered in the position of the greatest number of blocks, becoming, beyond it, a torrent. For about a mile above this there were no blocks; that is, between my position and the base of the steep cliffs forming the amphitheatre where the glaciers had descended. The largest blocks were those furthest down the valley; at least twenty of them appeared to me to be upwards of as many feet in length, and one of greater length was also of greater height. Several were split in two, like blocks that had been fractured by falling through the crevasse of a glacier. All were weather-worn and covered with lichens, ling, and grass.

Returning I took a north-westerly direction, ascending the spur I had crossed in coming, passing close under a magnificently mountainous mass of basalt to the east of the Puy de Pougé. Still further eastward and south of this Puy are meadows where brood mares and foals are grazed, upon which were a few large blocks of trachyte or basalt artificially shaped into very odd forms, some like skittles, others like a truncated cone with the earth heaped up round its base; they may be worthy of further investigation, but I had no time to examine them and no opportunity of making inquiry. Thence my direction lay under the Puy de Compaine, and so by a steep descent to the Ruisseau de la Chambasse, which I followed to the village of Sarsenac, and thence ascended to Latour.

J. D. HOOKER

#### ASSOCIATION OF GERMAN NATURAL PHILOSOPHERS AND PHYSICIANS

THE forty-eighth meeting of this Association was held from the 18th to the 25th of September at Gratz, the chief town of Styria, in one of the most beautiful valleys of the Austrian Alps.

The Association is the oldest of its kind; founded in 1822, and preceding, therefore, by several years, the birth of its British sister. In times of political disturbances and wars, such as the years 1848, 1866, and 1870, it held no meetings; in several previous years the German Governments, who in days gone by regarded every public meeting with suspicious eyes, prohibited them, and thus forty-eight meetings only were held during the fifty-four years of its existence. The German "Naturforscher-Versammlung" owes its formation to one of the founders of comparative anatomy, the celebrated Oken, late Professor of Zoology at Jena, and it cannot be denied that politics entered into the intentions of its founder as well as of many of its original members. When German unity was nothing but a treasonable aim of persecuted patriots, every meeting of Germans from different States served to spread and to give fresh vigour to this aim, and was in itself a protest against the division into small States of the common country, and against persecutions such as Oken himself has had to suffer. Aye, even now, when the old wishes have been fulfilled and no division separates Government and nation, remains of the old political undercurrent can still be traced in some of these meetings.

Gratz has an entirely German population, whose sympathies with the new German realm are increased by their proximity to Slavian provinces. It has taken a prominent part in the Reformation, and although brought back to the old religion by threats of fire and sword, by the establishment of Jesuit colleges and the suppression of the Protestant University once graced by Kepler, it still glories in its old recollections and carries high the banners of freedom and of its German nationality. In 1842, the "Naturforscher-Versammlung" was invited to Gratz and gave to that town a foretaste of the right of association then proscribed in Austria, and in 1875 the town opened her gates once more to her non-Austrian brethren, principally to assert her intellectual unity with Germany. This idea, and their enthusiasm for the freedom of thought, formed the

chief contents of the opening address delivered by Prof. Rollett, and of the welcome tendered by Dr. Kienzel, the chief magistrate of the town. The Government was represented by the lord-lieutenant of the province and by an under-secretary of the Board of Agriculture, while the Minister of Public Instruction welcomed the meeting in a letter excusing his absence. The Emperor Francis Joseph had contributed largely to the costs of the meeting. But this did not prevent his Government from interfering with the hoisting of the flags of Germany, which were destined to greet the visitors on their entrance into the town. It would naturally be supposed that the sympathy evinced by the town of Gratz would have been responded to by large numbers of German visitors. In this respect, however, the meeting was destined to be a disappointment, without any very prominent reason to account for it. Most likely a good many reasons contributed to this result: such as the distance of the place of meeting from the centre of Germany, the bad aspect of monetary matters, the day chosen for the assembly, which, lying in the middle of the summer vacation, prevents visitors from taking journeys into distant countries. Again, some of the branches represented in the Association have commenced to hold separate meetings: the geologists, the astronomers, the societies for the improvement of public health, for ophthalmology, psychiatrics, and surgery, hold separate annual meetings independent of the Association of Natural Philosophers and Physicians. Lastly, certain events that have lately taken place in Austria seem to have deterred German members of the Association from visiting the Austrian Empire. It will be remembered that some of the most prominent German professors of the University of Prag have been all but forced to leave their posts, and that the vacillating policy of the Austrian Government wishes at present to reconcile the Slavian population by excluding as much as possible German influence from Austrian Universities.

The number of visitors at the meeting of Gratz was 715 members, 1,567 associates, and 1,700 lady associates. Of the 2,282 male visitors, 1,705 belonged to Austria (1,141 being residents of Gratz), and 546 to the German Empire; 114 of the latter being residents of Silesia, the nearest German province. Seventeen Russians, four Swiss, three Turks, two Swedes, two Roumanians, and one visitor from England, one from Italy, and one from America make up the total. It will be seen that this number corresponds very nearly with the average number of attendants at the British Association.

This, of course, is a merely fortuitous resemblance. But many other points indicate that the British Association has been modelled from the German pattern. Both Associations are convened for the same number of days; both hold the same number of general and sectional meetings; they resemble each other in the nature of the recreations offered to visitors: excursions, dinners, concerts, to which in Germany (and Austria) are added balls and theatrical performances, while England has the private hospitality of its nobles and rich manufacturers and merchants to offer, which do not enter into the German programme or certainly do not appear in it to the same extent. A festivity of a peculiar character in addition to those named was offered by the municipality of Gratz: an illumination by bonfires of the mountains surrounding the town, a sight of most impressive beauty.

Generally speaking there are no evening meetings in Germany, and the festivals being of a public nature (not depending upon private hospitality), the connection between the visitors is greater than it is at the British meetings. A peculiarity of the German meetings is the absence of a president; two *chargés d'affaires* (*Geschäftsführer*) being nominated to conduct the business of the Association, one a natural philosopher, one a physician. Professors Rollett and L. von Pebal occupied these positions in Gratz. The sections nominate new presidents

for each of their daily meetings. A consequence of this arrangement is a certain want of formality. No retrospective introductions are offered at the opening of the sectional meetings, no criticisms of the work of fellow-workers by more or less competent critics, no sweeping remarks on the state of science in general, which happen to be the more disparaging the less the critic himself is actually engaged in contributing to the advancement of the branch of science he is discussing.

In two respects the British Association has an indubitable advantage over the German meetings. Those splendidly illustrated evening lectures addressed to the general public, which form one of the attractions of the meetings in the United Kingdom, are not offered in Germany.

Again, the funds of the German Association are small; they are spent for the purposes of each meeting, and no money can be given in grants for scientific purposes as is done in Great Britain. There are therefore no general and no sectional committees in Germany. On the other hand, the German Association offers the advantage of a speedy publication of its transactions. Instead of publishing an annual volume long after the close of the meetings, the German Association offers a daily paper (*Tageblatt*) giving the proceedings in a more or less condensed form according to the notes given by members to the general or the sectional secretaries. Generally some supplementary numbers are issued, completing the report within one month after the conclusion of the meeting.

The papers read at the general meetings are mostly given in full. At the first general meeting at Gratz, after the opening ceremony already alluded to, the Arctic explorer, Lieut. Weyprecht, gave a most interesting review of Arctic explorations, and at the same time a curious and stirring piece of self-criticism.\* Amongst the most characteristic passages are the following:—

“Originally it was the wish for material gain, in the shape of fur and fish-oil, that prompted Arctic exploration. Later on this cause was replaced by the ambition of geographical discoveries such as are easily understood by the general public. The running after this sort of fame gradually assumed such proportions that Arctic exploration became a sort of international steeplechase towards the North Pole, a system opposed to true scientific discoveries. Topographical geography must be subordinated in Arctic regions to physical geography. Geographical discovery derives its value only from scientific discoveries connected with it. The exploration of the great and unknown latitudes near the poles of our globe must be continued without regard to the expenditure of money and of life which it demands. But its ulterior aim must lie higher than the mere sketching and christening in different languages of islands, bays, and promontories buried in ice, and the mere reaching of higher latitudes than those reached by our predecessors. One reason of the indifferent results of previous expeditions is that they have been unconnected with each other. The progress of meteorology consists in comparison, and every success it has obtained, such as the laws of storms, the theory of winds, &c., is the result of simultaneous observations. The aim of future Arctic explorers must be to make simultaneous observations, extending over the period of a whole year, with identical instruments and according to identical rules. In the first place, they will have to consider natural philosophy and meteorology, botany, zoology, and geology, and only in the second place the discovery of geographical details. I do not intend in what I said to depreciate the merits of my Arctic predecessors, whose sacrifices few can appreciate better than I do. In giving utterance for the first time to these opinions, which I have taken time in forming, I complain against myself, and I condemn the greater part of the results of my own arduous

\* Some of the chief points in this address we gave in NATURE, vol. xii. p. 539.

labours. I will conclude by announcing that the future participation of Austria in such an enterprise has been secured by the generosity of a man who has already made several sacrifices in the interest of Arctic voyages."

The Mæcenas of the new expedition alluded to but not named in this announcement is understood to be Count Hans Wilczek.

Weyprecht's manly speech was followed by great applause, and has already produced the effect of inducing the Commission appointed by the German Government to examine the question of expediency of a new expedition to the North Pole, *not* to recommend the despatch of a new expedition, but the establishment of stations of observation in northern latitudes.

The second general meeting selected Hamburg for its place of assembly in 1876, and appointed the chief magistrate of the town, Burgomaster Kirchenpauer, and Dr. Dantzel, to manage affairs. Prof. Behn brought before the meeting the plan of a society for the assistance of scientific men in reduced circumstances.

Dr. Günther then gave a very interesting lecture, to which, unfortunately, no abridgment could do justice, on the aims and results of the history of mathematics; followed by Prof. Benedict on the history of crime with regard to ethnology and anthropology. He touched upon delicate ground, asserting that every action is based less on liberty than on compulsion; that our acts are governed by natural laws and not by theological opinions, and that punishment may act as a corrective of perverted human nature, but is chiefly the outflow of the desire of society to avenge wrongs inflicted upon it. The best prevention of crime depends upon the increase of our knowledge of those circumstances that necessarily engender it. In England a speech like this would no doubt have raised a storm of theological indignation. In Germany the clergy is distinguished by its absence from scientific meetings. The separation of natural science and orthodoxy is complete, and no opposition was therefore offered to these remarks.

In the third and last general meeting two popular medical lectures were given, one by Dr. Ravoth, on nursing the sick; the other by Dr. Lender, on ozone (the latter gentleman having made some doubtful efforts of introducing infinitesimally small doses of ozone into medicine). Then Prof. von Pebal rose, and declaring the order of the day exhausted, thanked the members for their attendance at Gratz, and proposed a vote of thanks to the sovereign in whose realm they had assembled. This proposal having been cheerfully responded to, Dr. Stilling proposed and carried a cordial vote of thanks to the town of Gratz, and Dr. Rollet, who presided at the meeting, declared the assembly closed.

Of minor incidents may be mentioned the invitation of a society in Offenburg (Black Forest) to contribute for a monument to be erected to Oken in this his native town; and the distribution of several works written for the occasion, amongst others a guide to Gratz, and a commemorative volume published by the Medical Society of that town.

Reverting at last to a short review of the proper business of the Association, its sectional meetings, the reader will remark the absence at the German assembly of one of the most popular sections of the British Association, viz., that of engineering, while several other sections appear in the German programme that are omitted in the British society, notably those devoted to medicine. This review will form the subject of a second article. A. OPPENHEIM

#### THE GERMAN COMMISSION ON ARCTIC EXPLORATION

THE German Commission on Arctic Exploration, appointed by the Reichskanzler, and to which we have before referred, consists of Professors Dove and

Neumayer, Doctors v. Richthofen and Siemens from Berlin, Prof. Karsten from Kiel, Prof. Grisebach from Göttingen, Prof. Zittel from Munich, Prof. Bruhns from Leipzig, Prof. Quenstedt from Tubingen, Director Rümker from Hamburg, Professors Schimper and Winnecke from Strassburg. The Commissioners have held meetings at Berlin from October 4 to 13; and the result of their deliberations—a long memoir on the value of the different branches of science—has been delivered to the Bundesrath for further consideration. The *résumé* of that report is contained in the following unanimously adopted conclusions:—

"1. The exploration of the Arctic regions is of great importance for all branches of science. The Commission recommends for such exploration the establishment of fixed observing stations. From the principal station, and supported by it, are to be made exploring expeditions by sea and by land.

"2. The Commission is of opinion that the region which should be explored by organised German Arctic explorers, is the great inlet to the higher Arctic regions situated between the eastern shore of Greenland and the western shore of Spitzbergen.

"Considering the results of the second German Arctic expedition, a principal station should be established on the eastern shore of Greenland, and, at least, two secondary stations, fitted out for *permanent* investigation of different scientific questions, at Jan Mayen and on the western shore of Spitzbergen. For certain scientific researches the principal station should establish temporary stations.

"3. It appears very desirable, and, so far as scientific preparations are concerned, possible, to commence these Arctic explorations in the year 1877.

"4. The Commission is convinced that an exploration of the Arctic regions, based on such principles, will furnish valuable results, even if limited to the region between Greenland and Spitzbergen; but it is also of opinion that an exhaustive solution of the problems to be solved can only be expected when the exploration is extended over the whole Arctic zone, and when other countries take their share in the undertaking.

"The Commission recommends, therefore, that the principles adopted for the German undertaking should be communicated to the Governments of the States which take interest in Arctic inquiry, in order to establish, if possible, a complete circle of observing stations in the Arctic zones."

#### NOTES

WE take the following from the *Times*:—

The award of the medals in the gift of the Royal Society for the present year, by the Council, is as follows:—The Copley Medal to Prof. A. W. Hofmann, F.R.S., for his numerous contributions to the science of chemistry, and especially for his researches on the derivatives of ammonia; a Royal medal to Mr. William Crookes, F.R.S., for his various chemical and physical researches, more especially for his discovery of thallium, his investigation of its compounds, and determination of its atomic weight, and for his discovery of the repulsion referable to radiation; a Royal medal to Dr. Thomas Oldham, F.R.S., for his long and important services in the science of geology, first as Professor of Geology, Trinity College, Dublin, and Director of the Geological Survey of Ireland, and chiefly for the great work which he has long conducted as Superintendent of the Geological Survey of India, in which so much progress has been made that in a few years it will be possible to produce a geological map of India comparable to the geological map of England executed by the late Mr. Greenough—also for the series of volumes of Geological Reports and Memoirs, including the "Palæontologia

Indica," published under his direction. It is hoped that Dr. Hofmann may be spared from Berlin for a few days so as to receive the medal in person. The medals will be presented at the anniversary meeting of the Society on the 30th inst.

The following are the names to be proposed for election as Council and officers of the Royal Society for the ensuing year at the anniversary meeting of the Society, to be held on the 30th inst., St. Andrew's Day:—President, Joseph Dalton Hooker, C.B. Treasurer, William Spottiswoode, M.A., LL.D. Secretaries, Prof. George Gabriel Stokes, M.A., D.C.L., LL.D., and Prof. Thomas Henry Huxley, LL.D. Foreign Secretary, Prof. Alexander William Williamson, Ph.D. Other members of the Council:—Prof. J. C. Adams, LL.D., Major-General John T. Boileau, Edward Viscount Cardwell, F.G.S., Warren De la Rue, D.C.L., Capt. Frederick J. O. Evans, R.N., C.B., Edward Frankland, D.C.L., Albert C. L. G. Günther, M.D., Prof. T. Wharton Jones, F.R.C.S., Joseph Norman Lockyer, F.R.A.S., the Rev. Robert Main, M.A., Prof. Daniel Oliver, F.L.S., Prof. Edmund A. Parkes, M.D., Right Hon. Lyon Playfair, C.B., LL.D., William Pole, C.E., the Rev. Bartholomew Price, M.A., Warrington W. Smyth, M.A.

AT last Friday's lecture by Dr. Carpenter, in connection with the St. Thomas Charterhouse School Teachers' Science Association, Dr. Lyon Playfair presided. In proposing a vote of thanks to Dr. Carpenter, Dr. Playfair referred to the subject of compulsory education, which is gradually becoming universal in this country, but which, he said, would be pure tyranny unless the education in our schools was increased and its quality raised. Quantity is all very good, but unless there is quality along with it, there is not much gained. "If it was to be said that children of thirteen or fourteen years of age were merely to receive the same education as children of eight years of age, compulsory education would be but tyranny. Therefore compulsory education involved higher education." Dr. Playfair expressed his gratification that the teachers composing the Association had banded themselves together in order to qualify themselves by attending such lectures as those of the Gilchrist fund and by other means, to undertake this higher education, which, we believe with Dr. Playfair, will be forced upon us even in elementary schools by the spread of compulsory education.

THE conferring of the Freedom of the City of London on Sir George B. Airy, the Astronomer Royal, and late President of the Royal Society, which took place on Thursday last, is, we believe, the first instance in which that honour has been bestowed for scientific services unconnected with military or engineering science. In the civic speeches which accompanied the ceremony, great stress was laid on Sir G. B. Airy's services in connection with the Metric Standard.

IN the Quarterly Return of Marriages, Births, and Deaths, just issued by the Registrar-General, we are glad to see that attention is pointedly drawn in the remarks to the annual epidemic of infantile diarrhœa, and the opinion expressed that it rests with the health officers of the diarrhœa-stricken towns to discover the nature of the sanitary shortcomings which lead to this waste of infant life. Perhaps equal stress might have been laid on a correct knowledge of the modes of nursing infants prevailing in the separate towns as on their merely sanitary conditions, as likely to lead to the true causes of the observed variations in the diarrhœa death-rate.

AT the Meteorological Congress to be held under M. Le Verrier's presidency at Poitiers on the 19th, 20th, and 21st inst., as already stated in NATURE, steps will be taken to inaugurate, for the west of France overlooking the Bay of Biscay, a system of daily weather telegrams by the Observatory of Paris. Since this system of warnings is more specially designed to further the interests of agriculture, subscriptions are solicited from pro-

prietors and others more specially interested in the success of the proposed scheme, particularly in view of the considerable expense which will be incurred in founding a sufficient number of stations with the necessary equipment of instruments. Weather warnings for agriculturists, if they are to be of practical utility, must do more than forecast high winds, they must also, and more particularly, aim at giving warning of the approach of frost, rain, snow, and thunder-storms; and this requires for its successful accomplishment more numerous stations and more frequent observations than are necessary in issuing warnings for the benefit of the shipping interest.

WE have received the Transactions of the Michigan State Medical Society for 1875, containing among other matters a discussion by Professor Kedzie, the president, of the observations on ozone made by him during 1872-75; and a form for meteorological observations made thrice a day, adopted by the State Board of Health, Michigan, which appears to be well adapted for medico-meteorological purposes, except that the directions given for the position of the thermometer are vague as well as faulty to secure comparability among the observations.

AT the last meeting of the General Council of the Yorkshire College of Science, under the presidency of Dr. Heaton, it was unanimously resolved to found a scholarship of the annual value of 25*l.*, to be called the Cavendish Scholarship, in recognition of the obligations conferred upon the college by the Duke of Devonshire and Lord F. C. Cavendish, M.P. From a statistical return presented by Mr. Henry H. Sales, secretary, it appears that 200 students are in attendance at the college, of whom more than forty are availing themselves of the day classes.

THE Report of the Scotch Herring Fishery Board states that already certain facts have been discovered in the course of the experiments which have been instituted for the purpose of discovering how far the temperature of the sea and other meteorological conditions might be concerned in determining the migration of the herring. Arrangements were made during the season of 1874 for regular observations, and twenty of the fisheries were supplied, through the liberality of the Marquis of Tweeddale, with deep-sea thermometers for ascertaining the temperature of the sea at the times and places when fishing was going on. The records of these observations, taken in conjunction with the returns of the daily catch, and with particulars collected from other sources, were referred to Mr. Buchan, Secretary to the Meteorological Society, who analysed them. Although the returns are not sufficiently full to afford any accurate rule, owing to the lateness of the period before the sea-thermometers were ready to be sent to the fishermen, they prove that "during the periods when good or heavy catches were taken the barometer was, in the great majority of cases, high and steady, the winds light or moderate, and electrical phenomena wanting; and on the other hand, when catches were low, the observations often indicated a low barometer, strong winds, unsettled weather, and thunder and lightning." From the complete returns of the daily catch of the fish, and of the meteorological conditions, inclusive of the temperature of the sea, now obtained, it is anticipated that materials will be collected in three or four years from which most valuable conclusions will be arrived at.

A NEW edition of Dr. Lardner's "Handbook of Astronomy," revised and completed to 1875 by Mr. Edwin Dunkin, F.R.A.S., is nearly ready for publication by Messrs. Lockwood and Co. It will contain a large number of plates and woodcuts.

THE *Daily Telegraph* announces that the letters from Mr. Stanley, committed to the charge of M. Linants de Bellefonds, have safely arrived, notwithstanding the assassination of Colonel Gordon's representative. They contain a full description of the south-eastern, eastern, and northern shores of Lake Nyanza.

The letters are said to contain valuable geographical data in illustration of the map already forwarded, including soundings of the Victoria Nyanza and an exploration of the White Nile above Ripon Falls.

IN reference to the Reuter's telegram (vol. xii., p. 562) relative to the mission to Italy of Major Festing and Mr. Lockyer, we should state that the instruments which it was sought to collect for the forthcoming Government Exhibition of Scientific Instruments at South Kensington Museum are not instruments used in recent astronomical observations, but rather such as will be historically interesting as illustrating those sciences in the early development of which Italian philosophers such as Galileo, Toricelli, Volta, and Galvani took such a large share.

ON Saturday evening, [Captain Adams, of the whaler *Arctic*, arrived in Dundee from the Davies Straits fishing. From the condition of the wind and sea at Carey Island, Captain Adams believes that there must have been a vast extent of open water towards the north, and he is convinced that the Government ships must have reached a higher latitude than they possibly could have attained for many years past. Captain Adams has an intimate knowledge of the Polar regions, and has already made several valuable contributions to Arctic discoveries.

A SERIES of Popular Scientific Lectures was commenced at the Town Hall, West Bromwich, on Tuesday week, when Prof. Williamson, F.R.S., lectured on "Coal and Coal Plants." The following remain to be given:—On Nov. 16, "The Age of Ice in Britain," by Rev. H. W. Crosskey, F.G.S. On Nov. 30, "Coal Gas," by F. Jones, F.R.S.E., F.C.S. On Dec. 14, "Nerve Cells and Nerve Fibres," by Prof. A. Gamgee, M.D., F.R.S. On Jan. 10, "The Mariner's Compass," by J. Hopkinson, D.Sc., M.A.

WE have received the Report of the "Botanical Locality Record Club" for 1874. It forms a valuable addition to our topographical knowledge of British plants; and in the list of "New County Records," care seems to have been taken not to give those of the rarer plants so precisely that the publication will be likely to result in their extinction. A suggestion has been made to extend the area of the records to Cellular Cryptogams (Vascular Cryptogams being already included). This might probably be done with advantage as far as Mosses, Lichens, and Hepaticæ, and possibly also Fungi, are concerned; but with regard to Algae, it is more doubtful whether much would be gained by a record of their geographical distribution.

MM. REESS and WILL, of Erlangen, record in the *Botanische Zeitung* No. 44 for the current year, a series of observations on the carnivorous habits of *Dionaea* and *Drosera*. Made quite independently of Mr. Darwin's researches, and partly before their publication, they abundantly confirm his conclusions as to the power possessed by the sundew of absorbing and digesting nitrogenous substances. Similar experiments on other plants with glandular hairs produced, like Mr. Darwin's, negative results.

THE *Argonaut* is to be doubled in size at the commencement of a new volume in January. A new feature will be a monthly report, suited for general readers, on the progress of science, specially prepared for the magazine "by professional gentlemen of acknowledged standing in their respective spheres of study."

It is gratifying to see that the value of experimental observation is coming to be more and more recognised in Medicine. We would draw attention, in reference to this, to a summary of an excellent address on the subject, by Dr. McKendrick, of Edinburgh, which appears in last Saturday's *British Medical Journal*.

PROF. W. R. M'NAB reprints from the *Quarterly Journal of Microscopical Science* his translation of Brefeld's most important researches on the life-history of one of the common blue moulds, *Penicillium glaucum*. A very close research succeeded in detecting the hitherto unknown sexual mode of reproduction of this fungus. Brefeld terms the second generation a sclerotium or sporocarp, from which are developed—as the result of the union of the true sexual organs, the carogonium and antheridium—asci and ascospores, the formation of which shows that *Penicillium* must be placed in the group of Ascomycetes; and he considers that, from the striking resemblance of the minute structure of the sclerotia to those of the truffle, a position must be assigned it close to the Tuberales.

THE second part of Bentley and Trimen's "Medicinal Plants" fully maintains the character of the first. It contains seven plates: *Theobroma Cacao* (the cocoa-plant), *Rhamnus catharticus*, *Prunus Amygdalus* (the almond), *Pyrus Cydonia* (the quince), *Lobelia inflata*, *Gaultheria procumbens*, and *Cinnamomum zeylanicum* (the cinnamon). The letter-press is amply descriptive of the various species and their official preparations. The work will be completed in about forty parts.

MM. Wiegandt, Hempel, and Parey, of Berlin, are publishing a large number of wall-maps or diagrams for instruction in natural history, with especial reference to agriculture. Five series have been issued up to the present time; the first relating to the breeding of stock; the second to the production of wool; the third to the minute structure of plants; the fourth to the cultivation of root and other crops; and the fifth to physical geography.

MR. J. J. HARRIS TEALL, B.A., First Class in the Natural Sciences Tripos 1872 and Sedgwick Prizeman 1873, has been elected a Fellow of St. John's College, Cambridge. Mr. Teall is at present one of the lecturers engaged on behalf of the University in the larger towns.

THE unfortunate explosion of the *Magenta* at Toulouse has involved a loss of some consequence to science. Eighteen Phœnician inscriptions, recently discovered and on their way to the Louvre Museum, were on board the ill-fated steamer. Great efforts will be made to raise the hull, and the inscriptions may possibly be recovered by divers.

THE Crystal Palace Company's School of Practical Engineering is to be further developed this season by the addition of a Colonial Section. This section is designed particularly for gentlemen who intend to proceed to the colonies or abroad, as explorers or settlers. The object proposed is to afford them so much practical knowledge of scientific and mechanical work and expedients as shall enable them best to utilise the means with which they may have to deal, especially when entirely dependent on their own resources. The Colonial Section will be opened on January 5, 1876.

A RETRIEVER DOG, whose owner was working in the garden of the Bath Institution, lately killed a favourite cat, a frequenter of the same grounds. Having committed this unprovoked murder, the dog deliberately took the cat in his mouth, carried it some distance, dug a deep hole behind some bushes, and after depositing the cat therein, carefully replaced the earth, and had he not been observed there would have been no evidence of the crime. Shortly after, the dog lost his life by poison, probably a penalty for the offence.

IN the neighbourhood of Bath a gentleman possesses a pair of carriage horses, one of which evinces more than ordinary intelligence when his own ends have to be served. If the horse hears, even in the distance, the very first movement of a mowing-machine, he connects the sound with fresh grass, and at once taps with his hoof at the boarding of the stall to summon the



coachman for a supply. At first this is done gently, but if time passes he imperatively demands attention, or it is doubtful if the stable would contain him. The coachman lives adjoining the stable, and, much to his discomfort, the horse sometimes has imaginary wants during the night, and repeats the same process; and at whatever hour this occurs, the coachman is under the necessity of getting up to attend to him.

ON the 23rd inst. there will be an election at Balliol College, Oxford, to a scholarship on the foundation of Miss Hannah Brakenbury, "for the encouragement of the study of Natural Science," worth 80*l.* a year, tenable during residence of four years; open to all such candidates as shall not exceed eight terms from matriculation. Candidates are requested to communicate their intention to the Master of Balliol by letter, on or before Tuesday, the 16th inst., enclosing testimonials.

THE formal opening of the Zoological Garden of Cincinnati took place on the 18th of September. It contains sixty-six acres, and is very well arranged for its purposes.

THE additions to the Zoological Society's Gardens during the past week include two Macaque Monkeys (*Macacus cynomolgus*) from India, presented by Mrs. Tipping; an Egyptian Goose (*Chenalex agyptiaca*) from Africa, presented by Dr. E. Swain; a Ring-necked Parakeet (*Falcornis torquata*) from India, presented by Miss Thirlwall; a White-fronted Guan (*Penelope jacucaca*), a White Eye-browed Guan (*Penelope superciliaris*) from S.E. Brazil, a Vulpine Phalanger (*Phalangista vulpina*) from Australia, a Blue and Yellow Maccaw (*Ara ararauna*) from S. America, two Jambu Fruit Pigeons (*Ptilonopus jambu*) from the Indian Archipelago, deposited; two Upland Geese (*Chlapaga magellanica*) from the Falkland Islands, received in exchange.

#### OBSERVATIONS ON BEES, WASPS, AND ANTS\*

THIS is a continuation of my previous papers on the same subject. In them I recorded various experiments tending to show that in many cases Ants and Bees which have found a store of food or of larvæ certainly do not communicate the information to their friends. This unexpected observation was received with so much surprise, and indeed was so unexpected to myself, that I determined to repeat the experiments: which I have now done, with, however, the same result. To take one as an illustration: I placed an *F. Flava* (the small red ant) to a heap of larvæ, which, as is well known, are fleshy legless grubs incapable of motion. I placed them about two feet from the entrance to her nest. I then watched her from eleven in the morning till after seven in the evening, during which time she made eighty-six journeys from the nest to the heap of larvæ, carrying one off each time; but although she had so much work to do, and though the precious larvæ were lying for so long exposed to so many dangers and to the weather, she brought no other ant to assist her in carrying them off. One of the ants I observed in this way carried off one by one no less than 187 larvæ in a day. In other instances, on the contrary, the opposite result occurred. I was for some time uncertain, in the latter cases, whether the ants purposely brought friends to their assistance, or whether, as the ants are sociable insects, it merely happened that the one accompanied the other, as it were, by accident. To test this question, I took two ants, and placed them under similar circumstances, the one to a heap of larvæ, the other to a group of two or three, always, however, putting one in place of any that was carried off; and it was quite clear that the ants which were placed to the large group of larvæ brought far more friends to their assistance than those which had apparently only two or three larvæ to move. Of thirty ants which were observed, those placed to a large number of larvæ brought 250 friends, while those placed to two or three larvæ under similar circumstances only brought eighty.

One account, much relied on as showing the intelligence of ants, has been the following observation made by M. Lund in Brazil.

Passing one day under a tree which stood almost by itself, he was surprised to hear the leaves falling like rain. On examining the cause of this, he found that a number of ants had climbed the tree, and were cutting off the leaves, which were then carried away by companions waiting for them below. Of course it might be said that the leaves which dropped fell by accident; in which case they would naturally be carried off by the ants below. It occurred to me, however, that this was an observation which might easily be repeated. I placed therefore a number of larvæ on a slip of glass, which I suspended by a tape, so that it hung one-third of an inch from the surface of one of my artificial nests; isolating it, however, in such a manner that for an ant to walk to the nest she would be obliged to go thirteen feet round. I then placed some black ants (*F. nigra*) on the glass with the larvæ. Each of them took a larva in the usual way, and then endeavoured to go by the quickest road home. They leaned over the glass and made every effort to reach down, but of course in vain, though the distance was so small that they could all but touch the nest with their antennæ, and even, in one or two cases, succeeded in getting down by stepping on to the back of an ant below. Those, however, which did not meet with any such assistance, gradually, though at first requiring some help from me, found their way round to the nest, and after a short time there was quite a string of ants passing to and fro from the nest to the larvæ, although it would have been so easy for them to throw the larvæ over the edge of the glass, or to go straight home, if they would have faced a drop of, say, one-tenth of an inch.

Moreover, I placed some fine mould within half an inch of the glass, so that it would have been easy for the ants, by literally one minute's labour, to have constructed for themselves a stepping stone up to the glass; yet they did not adopt any of these expedients, but for hours together, and by hundreds, continued to make the long journey round. I confess this experiment, which I repeated on several occasions, surprised me very much.

As my previous experiments, which showed that bees did not by any means in all cases bring their friends to share stores of food which they had discovered, have been much questioned by bee-keepers, I have repeated them again.

No doubt, if honey is put in an exposed place, so that it is found by one bee, it is most natural that others should also find their way to it; but this does not, according to my experience, happen if the honey is concealed. For instance, I put a bee to some honey in a flowerpot placed on its side, and so arranged that the bee had only a small orifice through which to enter. Under these circumstances, from a quarter to seven in the morning till a quarter past seven in the evening, she made fifty-nine journeys, and during the whole of this time only one other bee found her way to the honey.

I found that bees soon accustomed themselves to look for honey on papers of particular colours. For instance, on Sept. 13 I placed a bee to some honey on a slip of glass on green paper, and after she had made twelve journeys to and from the hive I put red paper where the green had been, and placed another drop of honey on a green paper, at a distance of about a foot. The bee returned, however, to the honey on the green paper. I then gently moved the green paper, with the bee on it, back to the old place. When the bee had gone, I replaced the green paper by a yellow one, and put the green again a foot off. After the usual interval she returned again to the green. I repeated the same proceeding, but with orange paper instead of green. She returned again to the green. I now did the same with white paper: she returned again to the green. Again I tried her with blue: she again came to the green. I then reversed the position of the blue and green papers, but still she returned to the green. I repeated this experiment with other bees, and with the same result, though it seemed to me that in some cases they did not distinguish so clearly between green and blue as between green and other colours. In other respects they seemed to adhere equally closely to any colour to which they were made accustomed.

As regards wasps, my experiments fully confirm those previously made, and justify everything I have said with reference to their great industry. Indeed, they begin to work earlier in the morning and cease later in the evening than bees, continuing all day with the utmost assiduity. Thus, a wasp which I watched on the 10th of September, worked from seven in the morning until seven in the evening without a moment's intermission, during which time she made no less than ninety-four visits to the honey. As is the case with bees, if a wasp is put to exposed honey, others soon come. To determine this, if pes-

\* A paper read by Sir John Lubbock, Bart., M.P., D.C.L., F.R.S., at the Linnean Society, Nov. 4. Communicated by the author.

sible, I trained a wasp to come to some honey which I placed in a box communicating with the outside by an india-rubber tube six inches in length and one-third of an inch in diameter. She came to this honey continuously for three days, during which time no other wasp found the honey. As regards colour, I satisfied myself, by experiments like those made with bees, that they are capable of seeing colour, though they appear to be less influenced by it than are bees.

#### OUR BOTANICAL COLUMN

IRISH HEPATICÆ.—S. O. Lindberg has just published a quarto memoir on the "Hepaticæ in Hibernia mense Julii 1873 lectæ." This memoir is a reprint from the tenth volume of the "Acta Societatis Scientiarum Fennicæ," and contains a list of eighty-nine species of Hepaticæ collected during a month's visit to Ireland. The author had the benefit of the great geographical knowledge of Dr. Moore—the author with A. G. More of the "Cybele Hibernica"—to enable him to visit, without delay, the most productive portions of Ireland; otherwise it may be doubted if his collections would have been so rich. Many of the species described are very rare; some of them are new. The synonymy of the species is worked out in a manner worthy of the greatest praise. Many of the smaller forms among *Lejeunea* and other genera are described from fresh specimens or from those preserved in alcohol. The collections were chiefly made in Killarney. Of the new species we may mention *Lejeunea patens*, *L. Moorei*, *Zygodon aristatus*. In an appendix we find a list of the genera of European Hepaticæ classified as follows:—

1. Marchantiaceæ.
2. Jungermaniaceæ.
3. Anthocerotæ.

The group of Marchantiaceæ is divided into *A. Schizocarpa* and *B. Cleistocarpa* (this latter includes such genera as *Tessellina* and *Riccia*); that of Jungermaniaceæ into the same two subdivisions; and these are again much sub-divided.

The existence in Ireland of so large a number of interesting forms, of which so very much yet remains to be known as to their life-history, ought surely to act as a stimulant to the rising school of Irish botanists.

MARINE ALGÆ OF THE UNITED STATES.—Although nearly twenty years have elapsed since the third part of Harvey's "Nereis Boreali-Americana" was sent to the press, yet the contributions to a knowledge of the North American Algæ have been but few. W. G. Farlow, one of Prof. Asa Gray's assistants, ascribes this to the fact that but few American botanists reside on the western coast of America, where novelties might be expected; and he publishes a most welcome list of the marine species of the United States *proper*, not including Alaska, but in part enumerating those of Vancouver's Island. Those added since the publication of Harvey's "Nereis" are denoted by a star. The number of species enumerated is 430, a number that doubtless will be increased when the Algæ are investigated as recent forms either living or preserved in fluid, and not, as is now frequently the case, only examined when in a state of what is but little better than that of stains on white paper. Mr. Farlow's list will be found in vol. x. 2nd ser. of the Proceedings of the American Academy of Arts and Sciences.

COFFEE IN DOMINICA.—A good deal of attention has been directed of late to the island of Dominica as a coffee-producing country, a fact briefly referred to in NATURE, vol. xii. p. 173. At one time coffee was one of the staple products of the island, and was grown not only in large quantities, but also of excellent quality. At the present time little or none is exported to Europe, but the island still grows sufficient to supply its own demands, and we believe sends a little to the neighbouring islands. This falling off in the cultivation of the coffee-plant, in a soil and climate which experience showed was eminently suited to it in every respect, was due to the extensive destruction of the plants by what was then known as the coffee blight. This was soon found to be of insect origin, but no active or energetic measures were taken to rid the island of the pest, which continued its ravages, destroying many plantations, and even driving planters away in great numbers. Nothing seems to have been known regarding the insect itself until within the past few weeks, when specimens in their various stages, together with the injured leaves, have been received at the Kew Museum. Upon submitting these specimens to an entomologist, they were at once identified as the White Coffee-

leaf Miner (*Cemistoma coffellum*, Mann.), an insect exceedingly destructive to the coffee-plants in Brazil, Rio Janeiro, Martinique, &c. The crops of coffee in Brazil are said to be lessened one-fifth in consequence of the ravages of this insect.

It is remarkable that little seems to have been known in Dominica about the classification or habits of the insect, though it made its first appearance there in 1833, some forty-two years back, and it seems to have been known in Brazil only within the last twenty or twenty-three years. An elaborate description of the insect and its ravages will be found in the *American Naturalist*, vol. vi. pp. 332, 596; 187a.

#### SCIENTIFIC SERIALS

*Annual Report and Proceedings of the Belfast Naturalists' Field Club, 1873, 74.*—This Report was written before the meeting of the British Association in Belfast last year, so that its issue must have been very much delayed. The Society, according to the Report, as to financial condition and number of members, is in a thoroughly satisfactory condition. The Society, as a Field Club, makes excursions during summer; and an account of those for 1873 is contained in this part of the Proceedings. The papers read during the winter session are all interesting; we have space only for the titles:—"On the British Association, its aims and objects," by Mr. W. Gray; "On Progressive Development," by Mr. G. Langtry; "On the Surnames of the Inhabitants of the County Antrim, and their indications," by the Rev. E. M'Clure; "On Flints, and the Foraminifera, Entomostraca, &c., contained in them," by Mr. Joseph Wright, F.G.S.; "Irish Cranogones and their contents," by Mr. F. Wakeman; "Notes on the Aurora Borealis, taken in Belfast in the years 1870, 71, with suggestions as to its source and that of the earth's magnetism and magnetic currents," by Dr. T. H. Keown, R.N. The Appendix contains two valuable lists; first, of the Mooses of the North-east of Ireland, by Mr. S. A. Stewart; and second, of the Cretaceous Microzoa of the North of Ireland, by Mr. Joseph Wright, F.G.S., the latter illustrated by a large number of figures.

*Poggendorff's Annalen der Physik und Chemie, No. 9, 1875.*—This number commences with a long paper, in which M. Wilhelm Weber investigates mathematically the motion of electricity in bodies of molecular constitution. Among the points treated are, objections against the fundamental law of electric action; identity of the moveable parts (in all bodies) whose movement is heat, magnetism, or galvanism; identity of *vis viva* of the electromotive force in the current with the heat produced by the current in the conductor; movement and distribution of electricity in conductors; and Kohlrausch's theory of thermo-electricity.—In an article on formation of sound, Prof. Stern inquires why tuning forks without resonant supports give such a very weak sound. It cannot be due, as many physicists suppose, to their less surface of contact with the air, else high-pitched small forks could not sound louder than low and large ones, nor could overtones sound louder than ground tones when e.g. a large fork is struck with a hard body. Having shown reason for thinking that the amplitude of vibration and number of vibrations in unit of time have no direct influence on the strength of the sound, Prof. Stern groups together a number of interesting phenomena bearing on the subject: the difference in rate of decrease of sound, in high and low forks, on withdrawal from the ear; a like difference with regard to transverse vibrations and those produced longitudinally; the interference-effects where resonance-cases act on each other; the effects of bringing a resonator near an organ-pipe, &c. The paper is not yet concluded.—The action of the Holtz machine still requires some elucidation, and in a paper to the Berlin Academy (here reproduced) M. Poggendorff furnishes "further facts towards an adequate theory of electric machines of the second kind" (with two moveable discs). One of these facts is as follows:—The two discs turning in opposite directions, stop (say) the front one by holding it (the screw having previously been loosened); then, when the back disc is rotated, a current is obtained as before. Now turn the front disc round through 360°, and rotate the back disc as before. If this turning be done in the direction of the front disc's former rotation, the current in the back disc is unaltered; but if in the opposite direction, it is reversed. A turning of 180° or even of 90° has the same effect. These and similar facts, indicating an influence of *direction* (rather than extent) of dis-

placement, on the direction of the current, the author is unable to account for satisfactorily; they cannot, he thinks, be due to inductive action.—Some researches by Dr. Neesen on attraction and repulsion by rays of light and heat are noticed in our "Science in Germany."—M. Soret describes the diffraction phenomena obtained with circular gratings, consisting of opaque discs with a series of openings in the form of concentric rings; and a paper of "Optical Notes," by Dr. Wolcott Gibbs, of the American Academy, treats of a new optical constant, and a method of measuring indices of refraction without employment of graduated instruments.—M. Fuchs shows how the electrometer may be used for determining intensity of current, polarisation, and resistance; and M. Mach describes a polarisation apparatus with rotating analyser.

*Bulletin de l'Académie Impériale des Sciences de St. Petersburg.* (t. xix. Nos. 4 and 5; t. xx. Nos. 1 and 2).—From these publications we notice the following more important papers:—On the double star  $\epsilon$  634 = Camelopardali 19, Hev., by Dr. O. Struve.—On the salts of parabanic acid, by N. Mentchutkine; the author considers the potash, soda, ammonia, and silver salts of this acid.—On oxalurate of potash and on the determination of potassium in the salts of the acids of the uric group, by the same.—On the velocity of irritation in the spinal marrow, by E. Cyon.—Researches on blood, by Heinr. Struve.—On carbon tetraiodide, by M. G. Gustavson.—On a simple evaporimeter, alike useful in winter or summer, by H. Wild.—Continued observations of the companion of Procyon, by O. Struve.—On dimethylisobutylcarbinol and the new heptylene obtained by means of this alcohol, by M. D. Pawlow.—On iodide of ethylidene, by M. G. Gustavson.—On the chemical structure of pinacolone, by M. A. Boutlerow.—Preliminary note on the elasticity of rarefied air, by M. D. Mendeleeff and M. Kirpitschoff.—Diagnoses plantarum novarum Japoniæ et Mandshuriæ, by C. J. Maximowicz.—Report on a new iron meteorite from the shores of the Angara river, in the government of Jenisseisk, by M. A. Goebel.—Observations of the planets at the Academical Observatory of St. Petersburg; determination of the longitude of the ascending node in the orbit of Mars, by A. Savitsch.—Results of measurements made on crystals of arragonite, copper, pyrites, and skorodite, by N. von Kokscharow.—On the doubts recently raised on the cosmical origin of the Pallas iron, and a refutation of the same, by M. A. Goebel.—Hydrological researches, by Prof. C. Schmidt, of Dorpat. The author treats of the Caspian Sea, the Sea of Aral, the Dwina, and the White Sea.—On a method to obtain a uniform exposure in photographing the sun, by Dr. B. Hasselberg.—On the existence of a resisting medium in celestial space, by Dr. E. von Asten.—Researches on the theory of the determination of orbits, by Fr. W. Berg.—Barycentric theorem, which gives a means to express the duration of any movement of a point, by relation of two straight lines; by J. Somoff.—A note on perowskite crystals, by N. von Kokscharow; the author describes the determination of perowskite forms by approximate measurements made with the ordinary reflexion goniometer of Wollaston, the nature of the perowskite crystals from the Ural Mountains, and the angles measured.—Results of exact measurements of sulphur crystals, by the same. Analysis of the observations made in the Caucasus on terrestrial refraction, by M. Sawitch.—A note on mechanisms which retard reflex actions, by J. Setschenow.

## SOCIETIES AND ACADEMIES

### LONDON

Linnean Society, Nov. 4.—Dr. G. J. Allman, F.R.S., president, in the chair.—The following papers were read:—Observations on Bees, Wasps, and Ants, Part III., by Sir John Lubbock, Bart., F.R.S. An abstract of this paper appears in another column.—On the rate of growth of the female flower-stalk of *Vallisneria spiralis*, by A. W. Bennett, F.L.S. The peduncle of the female flower of this plant is remarkable for the rapidity of its growth, attaining a length of from three to four feet, and increasing, at its period of greatest energy, at the rate of half an inch per hour. The observations were chiefly directed to determine which portion of the peduncle displayed the greatest part of this energy; and this was found to lie in a portion at but a short distance below the flower-bud; a marked zone of two inches increasing ultimately relatively to the remainder of the flower-stalk about in the proportion of three to two. This displays a greater analogy to what has been hitherto observed in

the case of roots than in that of aerial stems. The coiling up of the peduncle so as to bring the flower beneath the surface does not take place when the flower has not been impregnated.—On plants collected by Lieut. Cameron about Lake Tanganyika, by Prof. Oliver, F.R.S.—On a collection of North Celebes plants made by M. Riedel, by Prof. Oliver, F.R.S.

Chemical Society, Nov. 4.—Prof. Abel, F.R.S., president, in the chair.—First paper, On the decomposition of stearic acid by distillation under pressure, by Mr. G. Johnston.—Dr. C. R. A. Wright read a paper, by himself and Mr. G. A. Beckett, On Isomeric Terpenes and their Derivatives, being Part V. of their researches on this subject; also one On the Alkaloids contained in the Aconites, Part I.; after which Mr. F. J. M. Page gave an account of a simple form of gas regulator for maintaining a constant temperature in air-baths, water-baths, incubators, &c.—Communications were also read from Mr. R. W. E. M'Yvor, on the fluorides of arsenic, phosphorus, and iodine; and on the iodide of antimony.—The last paper, On Tolyphenyl, a new hydrocarbon, was by Mr. T. Carnelly.

Zoological Society, Nov. 2.—Dr. E. Hamilton, V.P., in the chair.—The Secretary read a report on the additions that had been made to the Society's Menagerie during the months of June, July, August, and September, 1875.—A letter was read from Signor L. M. D'Alberia, giving some account of several excursions he had made into Southern New Guinea from his present quarters in Yule Island.—A note was read from Mr. Walter J. Hoffman, describing a horn of an American Pronghorn (*Antilocapra americana*), with a double prong.—A letter was read from Capt. J. Moresby, R.N., giving the exact locality of the young *Casuarium uni-appendiculatus*, presented by him to the Society in August 1874.—A communication was read from Dr. P. von Bleeker, containing a description of a rare Central-Asiatic fish (*Elopichthys dahuricus*).—A communication was read from Mr. Edgar A. Smith, containing the description of a new species of *Carinifex* from California, which he proposed to name *Carinifex ponsombii*.—A second communication from Mr. Smith contained remarks on the genus *Alaba*, with the description of a new species.—A communication was read from Mr. W. T. Blanford correcting certain errors in the figures of *Herpestes ferruginus* and *Orvis polii*, in the Society's Proceedings.—Mr. P. I. Sclater, F.R.S., and Mr. O. Salvin, F.R.S., read a paper giving the descriptions of two birds from Medellin, State of Antioquia, U.S.C., which appeared to be new to science, and were named *Catharus phaoplurus* and *Automolus holostictus*.—Mr. A. H. Garrod read a report on the causes of death of the Indian elephant which died in the Gardens on July 7, 1875.—A communication was read from the Rev. S. J. Whitmee, of Samoa, on the habits of the fishes of the genus *Antennarius*.—A communication was read from Mr. G. E. Dobson, containing a monograph of the bats of the genus *Taphosous*, Geoffr.—A communication was read from Dr. Otto Finsch, containing notes on the pigeons of the genus *Chrysaena*.—A communication was read from Dr. J. S. Bowerbank, F.R.S., being the fifth part of his monograph of the siliceo-fibrous sponges.

Royal Microscopical Society, Nov. 3.—Mr. H. C. Sorby, F.R.S., president, in the chair.—A very interesting paper was read by the President, On a new method of measuring bands in spectra. It was first explained that by means of the ordinary quartz absorption band plate, the exact position of a spectrum line not coinciding with either of the absorption bands, could not be accurately determined; and the necessity for so doing having been shown, the author described and figured his new contrivance designed for the purpose. It consisted of a piece of quartz about  $\frac{1}{4}$  inches thick, and cut with parallel surfaces exactly at right-angles to the principal axis of the crystal, along the line of which there was no polarisation. This gave a series of seven dark bands when placed between two Nicol prisms and viewed through the spectroscope. By rotating the upper prism the position of the first band could readily be made to coincide with any given fixed line as D, and by the rotation of the lower prism the series of bands could be caused to traverse the entire spectrum, each half rotation moving them forward the precise amount of the distance existing between them. A graduated scale marked upon a circle attached to the lower prism enabled the position of the bands to be compared with great accuracy with that which they originally occupied, and of course also with that of any fixed lines shown in the comparison spectrum. A paper by Dr. J. J. Woodward (U.S.A.), on *Frustulia Saxonica*, was read by the Secretary.

## CAMBRIDGE

Philosophical Society, Oct. 25.—Mr. J. W. L. Glaisher read a paper on Herwart ab Hohenburg's *Tabulæ arithmetice prosthaphæreseos universales*, Munich, 1610. The book is a very large and thick folio, and contains a multiplication table up to  $1000 \times 1000$ , the thousand multiples of any one number being given on the same page. There is an introduction of seven pages, in which the use of the tables in multiplying numbers containing more than three figures, and in the solution of spherical triangles, is explained. Very little information with regard to the work is to be obtained from the mathematical bibliographers and historians, Heilbronner, Kästner, Scheibel, Marhard, Kogg, Montucla, Lalande, &c. De Morgan writes: "Herwart passes for the author, but nothing indicates more than that the manuscript was found in his collection. The book is excessively rare; a copy sold by auction a few years ago was the only one we ever saw." While preparing the report of the British Association Committee on Mathematical Tables, Mr. Glaisher had endeavoured without success to obtain some further information about this great multiplication table, which has never been exceeded, and which is only equalled by Crelle's *Rechentafeln*, which first appeared in 1820, and is now in general use. But recently he had found a correspondence of six letters between Herwart and Kepler, which are printed in vol. iv. (1863) of Frisch's complete edition of Kepler's works, and which throw light upon the table in question. In the first, dated September 13, 1608, Herwart mentions that he has been in the habit of using a special praxis for avoiding the labour of multiplication, and which his friends have recommended him to print. He adds that without it he should long ago have had to give up all mathematics which involved calculation, on account of his many occupations and because he was not a good computer. He encloses a page as a specimen. Kepler replies that he thinks the table will be useful, and he urges that its uses in the solution of spherical triangles should be noticed, pointing out its superiority in point of clearness to the "*προσθαφαιρεσις* Vietchiana," which is too complicated to be retained in the memory. Herwart replies that he had already thought of its application in prosthaphæresis; he suggests a title for the book, and asks for Kepler's opinion; and in the last letter of the correspondence Kepler proposes the title "*Χειραχθεια* sive *Novæ Tabulæ, quibus Arithmetici debitis inextricabilibus multiplicandi et dividendi liberantur, ingenio, temporis, viribusque ratiocinantur consulitur.*" It is thus proved that the table was printed from a manuscript which Herwart used himself, and which very likely he had made. As for the word prosthaphæresis, it is well known that the prosthaphæresis of the orbit is the angle subtended at the planet by the eccentricity, and De Morgan explained the use of the word on the title-page thus: "Prosthaphæresis is a word compounded of prosthesis and aphæresis, and means addition and subtraction. Astronomical corrections sometimes additive and sometimes subtractive were called prosthaphæreses. The constant necessity for multiplication in forming proportional parts for the corrections gave rise to this table, which had the name of its application on its title-page." But the prosthaphæresis referred to seems most likely a method of solving spherical triangles in which the product of two sines or of a sine and cosine is avoided by the use of formulæ such as  $\sin a \sin b = \frac{1}{2} \{ \cos(a-b) - \cos(a+b) \}$ , and such a method is associated with the name of Wittich. This explains all Kepler's allusions, and why Herwart employed the word on his title-page, as he proposed to avoid the necessity of the transformation by rendering easy the operation of the simple multiplication. A copy of Herwart's work borrowed, through the kindness of Prof. Henrici, from the Graves Library at University College, London, was exhibited to the meeting.

## MANCHESTER

Scientific Students' Association, Oct. 20.—Mr. Mark Stirrup gave a short account of a visit to the celebrated Chesil Bank, on the coast of Dorset, and exhibited some specimens of the pebbles therefrom. The source whence these pebbles were derived and their mode of accumulation, as explained by many writers on the subject, were referred to. All these explanations have failed to account satisfactorily for a deposit of such vast magnitude, and there is no doubt that the views recently enunciated by Prof. Prestwich, F.R.S. (see *NATURE*, vol. xi, p. 299), go far to clear up the difficulty.

## PARIS

Academy of Sciences, Nov. 2.—M. Frémy in the chair. The following papers were read:—Determination of the class

of envelope-curves which present themselves in questions of equality of size of two segments made on tangents of geometric curves, by M. Chasles.—On the steam carriage of M. Bollée, of Mans, by M. Tresca.—Fourteenth note on the electric conductivity of mediocre conductors, by M. Du Moncel. These experiments were with various metallic filings and the powder of metallic minerals, graphite, and retort charcoal, which were compressed into prisms between mica-plates. When heated, their conductivity at first diminishes somewhat, but it then increases very rapidly. When the heating ceases, it diminishes again, and after some time the intensity of the current becomes much less than it was at first. Thermo-electrical and chemical effects are also described.—On the useful effect of steam injectors (concluded), by M. Leduc.—On the laws which govern reactions with direct addition (continued), by M. Markovnikoff.—On the unipolar electric excitation of nerves: comparison of the activity of the two poles during the passage of battery currents, by M. Chauveau. The subject was placed half in salt water, and a fine electrode applied to a point selected on the skin of the emergent portion; the other electrode was held in the liquid. Or the two electrodes were placed on two nerves sufficiently apart. M. Chauveau finds that for every healthy subject there is a certain moderate intensity of current, with which the contractions produced by the positive and negative excitation are equal in extent and duration; below this intensity the negative pole has the greater action; above it, the positive.—On the general arrangement of the nervous system in stylomatophorous pulmonate gasteropod molluscs, by M. Fischer.—Results obtained by means of sulphocarbonate of potassium on vines attacked by Phylloxera at Mezel. M. Dumas, summing up the testimony on this point, said the sulphocarbonates had everywhere proved effective (where used) in destroying the insect, and they rather improved than injured the quality of the vines.—On the method of Cauchy for the integration of an equation with partial derivatives of the first order, by M. Mansion.—M. Sainte-Claire Deville gave an extract from a letter by M. Fouqué, describing observations of volcanic phenomena in the island of Santorin.—The Perpetual Secretary called attention to a work of "Researches on the Combustion of Coal," by MM. Scheurer, Kestner, and Mennier-Dollfus; also to a memoir by MM. Marion and Borretzky, on the Annelids of the Bay of Marseilles. He further announced the publication, by M. Dummer, of a *résumé* of works of the Berlin Academy of Sciences from 1822 to 1872.

## BOOKS AND PAMPHLETS RECEIVED

BRITISH.—Air and its Relations to Life: W. Noel Hartley, F.C.S. (Longmans).—The Princes of India: Sir E. Sullivan, Bart. (Staddon).—Inaugural Address of the West London Scientific Association and Field Club. Session 1875-6: Rev. G. Henslow, M.A., F.L.S.—Notes of Travel in South Africa: Chas. J. Anderson. Edited by J. Lloyd (Hurst and Blackett).—The Revised Theory of Light: W. Cave Thomas (Smith, Elder, and Co.)

## CONTENTS

	PAGE
SEVENTH REPORT OF THE SCIENCE COMMISSION . . . . .	81
HERMANN'S "ELEMENTS OF HUMAN PHYSIOLOGY . . . . .	82
WHITE CONQUEST . . . . .	23
OUR BOOK SHELF:—	
VVyvyan's "Analytical Geometry" . . . . .	24
Besant's "Conic Sections" . . . . .	24
Pfeffer's "Periodic Movements of Leaf-organs" . . . . .	24
"Meteorology in Baden" . . . . .	25
LETTERS TO THE EDITOR:—	
Dr. Richardson's Hygeia.—Dr. F. DE CHAUMONT . . . . .	25
Photography in the "Challenger."—Col. H. STUART WORTLEY . . . . .	25
Bees and Clover.—THOMAS BELT . . . . .	26
Cherry Blossoms destroyed by Squirrels.—F. H. STORER . . . . .	26
Plagiarism.—HENRY WALKER . . . . .	26
Curious Australian implement.—J. P. GLOVER ( <i>With Illustration</i> ) . . . . .	27
OUR ASTRONOMICAL COLUMN:—	
Variable Stars . . . . .	27
The Minor Planets . . . . .	27
Bessel's Works . . . . .	27
AMONG THE CYCLOMETERS AND SOME OTHER PARADOXERS, II. . . . .	28
SCIENCE IN GERMANY ( <i>With Illustration</i> ) . . . . .	29
EVIDENCES OF ANCIENT GLACIERS IN CENTRAL FRANCE. By Dr. J. D. HOOKER, C.B., Pres. R.S. ( <i>With Illustrations</i> ) . . . . .	31
ASSOCIATION OF GERMAN NATURAL PHILOSOPHERS AND PHYSICIANS. By Dr. A. OPPENHEIM . . . . .	32
THE GERMAN COMMISSION ON ARCTIC EXPLORATION. . . . .	34
NOTES . . . . .	34
OBSERVATIONS ON BEES, WASPS, AND ANTS. By Sir JOHN LUBBOCK, F.R.S. . . . .	37
OUR BOTANICAL COLUMN:—	
Irish Hepaticæ . . . . .	38
Marine Algae of the United States . . . . .	38
Coffee in Dominica . . . . .	38
SCIENTIFIC SERIALS . . . . .	38
SOCIETIES AND ACADEMIES . . . . .	39
BOOKS AND PAMPHLETS RECEIVED . . . . .	40

THURSDAY, NOVEMBER 18, 1875

## MR. GLADSTONE AT GREENWICH

WE may surely regard it as a hopeful sign of progress that a whole page of the *Times*, as well as of other daily papers, of last Friday was practically devoted to the discussion of matters connected with Science and Art. When we find the daily papers giving so great prominence to these subjects, and when men of such position and mark as Prince Leopold, Mr. Gladstone, and the Lord Chief Justice, take what is evidently a genuine interest in the progress of science and art education among the lower classes, it seems quite safe to infer that this movement has at last taken a prominent and important place in the everyday life of the country.

Prince Leopold, in his address at Oxford, showed that he had taken some pains to become acquainted with the latest statistics of the Science and Art classes. The discrepancy between Prince Leopold's statistics and those of Mr. Gladstone has been commented upon in the *Times*. It would appear from an examination of the last Report of the Science and Art Department, however, that the figures which Prince Leopold gives for the number of students under instruction in science are probably the *number of papers worked* at the last May examinations. This, possibly, is an error in reporting. Mr. Gladstone, on the other hand, gives the right number—"about 48,000"—of the students under instruction *last January*; a different number, of course, to that in May 1874, when it was 53,050, or in May 1875, which has not yet been published, as far as we are aware. But in some way he has arrived at, or been furnished with, a wrong total for the number of Art students. This should be 54,800 odd, irrespective of the scholars in Elementary Day Schools. At the same time it is gratifying that a man like Mr. Gladstone should think it worth his while to take an interest in the matter at all, but when he does determine to think about it, the least he can do is to inform himself correctly as to statistics.

Mr. Gladstone set [himself almost entirely to impress upon his audience] the value of an education in the principles and practice of art; he attempted to show that really artistic handiwork had not only a refining, elevating influence even on the workman himself, but that it answered the requirement of utility in the best sense of the term. To his advocacy of the introduction of artistic taste into the commonest manufactures we can have no possible objection, but we distinctly demur to the ground on which he seems to have based the prominence that he gave it in his address. He found—wrongly, it appears—from the statistics that the proportion of students attending the Science classes was considerably larger than that of those who are attending the Art classes. According to the latest statistics this excess of Science over Art students is shown not to exist, and the inference that Science is getting more than its due share of attention, and that the claims of Art require special advocacy as being neglected, seems to us unwarranted on several grounds. The truth is the Art classes were established for many years before the Science classes, and the fact that there has been such a rush upon the latter simply proves that they meet a wider and deeper want than do the

former; that, in short, the nation feels that it stands more urgently in need of science at present than of art.

We infer, moreover, from what Mr. Gladstone said, that he thinks the practical application of science ought to be endowed in preference to abstract scientific investigation and education in scientific principles. But is it not much more rational and really practical that the men who are getting their education at these Science and Art classes should be educated in the main principles and leading facts of science before they are taught how to apply them? How is the best work likely to be got out of a man? Is it by teaching him the practice of a few traditional rules, incapable of expansion, and which have no meaning for him; or by educating him thoroughly in the scientific principles and data on which his handicraft is founded, and then leaving him to learn in the workshop how these are applied in practice? One might as well expect a carpenter to make a workman-like chair or table before he has learned to use the plane or saw, as expect the best work to be produced by the former course. The principles or laws of science are comparatively few; their applications are endless.

The student who has an accurate knowledge of principles will readily understand the applications. One school will, as it were, fit him out with all that is necessary for all industrial progress. To teach the applied sciences on the other hand requires a special school for all the various possible permutations and combinations that may be rung on the general principles.

By looking to general science, again, the Government avoids the difficulties which must necessarily accompany, with all the fluctuations of trade, any attempt to teach applied science except in some very general forms. The fact is that the practical applications of science bring their own reward, and need no extraneous encouragement; instruction and invention in them may very well and without the least hardship be left to those whose pockets they fill. Art receives ample encouragement, and is well rewarded by the nation; let but an artist in any department show himself capable of producing good work, and he will soon find that both the Government and private individuals have plenty of rewards to bestow upon him. Science, on the other hand, receives not a penny in the way of assistance or reward, and yet the scientific investigator is the nation's servant and greatest benefactor. Pure scientific research is at present, like virtue, its own reward; the man who devotes himself to such research, unless he has some other means of gaining a livelihood, is likely enough to starve for all the help he will get from his country; and yet, as it has been shown over and over again, our country's prosperity, the progress of nearly all our industries, and even the very existence of many of them, are dependent on the discoveries of the scientific investigator who pursues his research on purely scientific principles, and with no practical end whatever in view. Our country has got at least as much glory, and we venture to think more practical benefit, from achievements in the region of pure science, as from all that has been accomplished in the domain of art, and yet no helping hand is held out to those who are able and willing to do their country the highest service, but cannot, because they must drudge for a living. The domain of science is every day becoming

more and more extended, her methods are becoming more and more complicated, and her instruments more and more expensive; in almost every department paths are being opened up which, if pursued to their end, would certainly lead to discoveries of vital importance to the best welfare and prosperity of the nation. Our public men are continually telling us that we are being outstripped by continental nations in fields which used to be peculiarly our own, and that simply because abroad every encouragement is given to scientific research, while here its existence is either ignored or it is regarded as a mere pastime. We can only think that Mr. Gladstone must have been imperfectly informed, or that he felt himself bound for the occasion to assume the position of special pleader on behalf of Art, which really can take very good care of herself.

We are grateful, however, for the unmistakable manner in which he referred to the City Companies. He put the case exactly as it ought to be put, and did not in the least exaggerate the crying scandal. Their pharisaical trumpeting of the piteous dole out in the way of charity blinds very few, we should think, to the disgraceful way in which they discharge the stewardship of the enormous funds committed to their trust. What are these eleemosynary piteous doles compared to the sums they lavish yearly on their ponderous entertainments, relics of long past generations, when men were some stages nearer the lower animals than they are now, but which are now meaningless and out of date? These Corporations, though there are some wide-awake, practical, and, we must believe, advanced and cultivated men among them, seem to be quite unconscious of their lethargic, antiquated, and even dangerous position. We say "dangerous," for it is high time they should know that if they do not wake up out of their lethargy, and set their own house in order, they must very soon be wakened by a shock from without. The country cannot much longer forbear calling them to give an account of their valuable stewardship, and a sorry account, we fear they must render. It cannot be tolerated that while the advancement of the highest interests of the country is most seriously crippled for want of necessary means, those funds which were left by our benevolent predecessors in trust for the country's good, should rust in a useless napkin or be drawn upon only for the sensual gratification of those who foolishly fancy themselves their irresponsible trustees.

#### CHAMBERS'S ENCYCLOPÆDIA

*Chambers's Encyclopædia, a Dictionary of Useful Knowledge for the People.* Illustrated with Maps and numerous Wood Engravings. Revised Edition. Ten vols. (Edinburgh and London: W. and R. Chambers, 1874.)

WHEN the history of the English people during the present century comes to be written by some future Green—or it may be by the present one—the name of the publishing firm of W. and R. Chambers must be referred to with honour as having had a considerable share in fostering the great intellectual awakening among the people which was initiated in the earlier part of the century. By means of their *Journal*, which still maintains an honourable place among popular serials,

their *Information*, their *Miscellany*, and other similar publications, they supplied the growing appetite of the people for useful knowledge with healthy and invigorating food, which at the same time stimulated a craving for more. We believe that in this way the Messrs. Chambers have done much to create the general want among the middle and lower classes which is now being gradually supplied by more organised and systematic means of instruction and culture. They were also among the first, if not the first, to publish for the use of schools a carefully compiled and almost complete series of text-books of science, a series which held its place for a long time, though no doubt now somewhat out of date, if not largely out of print. The crowning effort of this firm to provide "the people" with the means of obtaining useful and accurate information is no doubt to be seen in the "Encyclopædia" which they have brought out under the editorial care of Dr. Andrew Findlater.

Previous to the publication of this "Encyclopædia," which began to be issued in 1860, and to go no farther back than the present century, a large number of books of reference of this class had been published both in England and Scotland, but they were all works of a ponderous size and constructed pretty much after the plan of the "Britannica," consisting mainly of long treatises on the various departments of knowledge. The Messrs. Chambers, however, took as their model Brockhaus's well-known "Conversations-Lexicon," and have broken down, as they express it, the various masses of systematic knowledge, to as great a degree as is consistent with the separate explanation of the several fragments. No doubt this is the only satisfactory plan for a dictionary of universal information, which, first of all, ought to be a handy reference book. It is for this very reason that the alphabetical arrangement is used, and we do not see that much is gained by such an arrangement, if an encyclopædia is to consist of a collection of exhaustive treatises, requiring an enormous index to make them consultable. As a handy book of reference, then, the plan of "Chambers's Encyclopædia" is all that could be desired. Of course there is a limit to the cutting down of subjects for purposes of reference, and Dr. Findlater has shown great shrewdness and common sense in fixing this limit. Perhaps some might desire an encyclopædia with a more copious vocabulary, with a fuller list of subjects, more condensed information, and in every case where practicable a copious bibliography; but for the great bulk of the people, the encyclopædia before us will be found to answer with singular completeness all the purposes of a book of reference. Between the body of the work and the copious index there is little that any ordinary man will want to inquire about which he will not find information upon here, and that speedily. In many cases references to special authorities furnish the means of pursuing a subject further.

As to the quality of the work we can speak with almost unqualified approval. We have said that the "Encyclopædia" is modelled after the German "Conversations-Lexicon." Indeed, the Preface states that it was at first intended to translate almost literally the German work, but that after the work of translating had been gone on with for some time, it was seen that an encyclopædia adapted to the English public would have to be constructed on an independent basis. This has



evidently been done. We have examined carefully a large number of the articles, and of course the scientific ones especially, and considering the purpose and plan of the work, there is really very little room for criticism. All the scientific articles have evidently been written by men who have special knowledge of their subjects, and as a rule are masterly specimens of condensation, clear statement, and wonderful fulness of information. Such names of contributors as Tait, Deutsch, Alex. Bain, Alex. Buchan, Goldstücker, Dr. G. E. Day, Keith Johnston, Dr. Birch, Pengelly, Francis Francis, and many others, are guarantees that in all the principal departments thoroughly competent men have been secured to write. But while with such contributors the quality of the information was bound to be up to the mark, the Encyclopædia would have suffered much in other respects without a thoroughly competent organising head. It is, no doubt, mainly due to Dr. Findlater that uniformity and due proportion have been secured, and that throughout perfect clearness has been maintained. His singular adaptation to fill the post of editor of such a work has largely contributed to its success.

But it is not only in the larger and more important articles that accuracy and care are apparent; even in the case of unimportant towns which may occupy only three or four lines, the information may be depended on, and in the case of British towns at least, was obtained, we believe, in almost every instance at first hand from some one on the spot. But down to the minutest details throughout the work constant and thoroughly intelligent and competent editorial care is evident, and if the Messrs. Chambers are careful to keep their work up to date, and bring out new editions at the proper times, they need hardly fear a rival.

The edition which lies before us is not strictly a new, but a revised edition; the work has not been reset, and but little increase has been made in the number of articles. We have, however, taken pains to compare some of the principal scientific articles in the new edition with the corresponding ones in the old, and in every case, where it has been really necessary for such a work, a competent revising hand is evident. "Chemistry," for example, which was first written twelve years ago, has been brought fairly up to date, and, as chemists know, this implies a great deal. By a few additional sentences in "Astronomy," the direction of the most striking recent researches is indicated; so in "Meteorology" and other articles. Indeed, it is quite evident that the work has been subjected to a thorough revision, and that considerable alterations have been effected, quite sufficient to keep the work fresh until a completely new edition is called for: not a few of the articles have been entirely re-written. The illustrations are copious and, in the main, accurate and well-drawn, and there is an excellent selection of maps.

Of course there are points in the work that are open to criticism; some subjects may seem inadequately treated, and others at too great length, and evidences of local bias are occasionally apparent, while there is a tendency in many of the biographical articles, to ambitious writing and the "higher criticism," which are a little out of place in a staid book of reference. But these are matters of comparatively small importance, in which Dr. Findlater is probably a much better judge than we. Of the sterling merits of the work throughout there can

be no mistake, and it will long remain a monument of Messrs. Chambers's enterprise and public spirit, and of Dr. Findlater's practical skill, judiciousness, and power of organisation, not to say wide and accurate knowledge. Not its least merit is that, like all Messrs. Chambers's serial works, it was issued in weekly numbers at three-halfpence, and we would advise all who can spare the pittance to become possessed of this "golden treasury" of knowledge.

#### EGYPT AND THE NILE

*Four Thousand Miles of African Travel: a Personal Record of a Journey up the Nile and through the Soudan to the Confines of Central Africa.* By Alvan S. Southworth, Secretary of the American Geographical Society. (New York: Baker, Pratt, and Co. London: Sampson Low and Co., 1875.)

MR. SOUTHWORTH, we may at once state, has broken no new ground; he has simply followed what are now considered beaten paths, although fifteen years ago there would have been few European footprints on the route; nevertheless, Mr. Southworth has gathered much useful information. This is given to the public in an agreeable form, with a tinge of American humour in some descriptions that breaks the usual monotony of a book of travels.

It appears that the author's love of adventure prompted him to visit the Soudan in the hope of following and eventually joining the expedition under the command of Sir Samuel Baker, in Central Africa. In Chapter III., "The Start for the Soudan," he writes:—"Alarming rumours of the death of Sir Samuel Baker and his whole party had been freely circulated in Cairo." . . . "Such a great undertaking as the Baker expedition was regarded by many of the finest minds in Egypt as too gigantic to move successfully among the unknown wastes of Ethiopia. In the first place, it is taking an army into a country foul with the unhealthiest malarias, and charred to desert sands by the fiercest of African suns." . . . "Therefore, when news came from Khartoum that Sir Samuel Baker was in distress at some point of the Nile Basin, I prepared to go to the Soudan in order to investigate his position and condition." With this object Mr. Southworth started from Cairo in company with two American officers, Generals Starring and Butler, and after a winter journey through the Korosko Desert, the party arrived in Khartoum on the 6th of February.

Chapter XI. will well repay perusal by those who take a desponding view of Egypt's future. The description given of the extreme fertility and boundless resources of the Soudan may be to a certain extent overdrawn; but even with the deduction of fifty per cent., the value of the country remains enormous. At the period of Mr. Southworth's visit to Khartoum, Moomtaz Pacha was the new Governor-General of the Soudan, a Circassian of great energy, who was determined to develop the cotton-producing powers of his almost boundless territory. Unfortunately he had forgotten that a necessary step preliminary to cultivation was a railway from Cairo, as no means of transport existed beyond the limited conveyance by camels. "Tell the American people," said the Governor-General of the Soudan to Mr. Southworth, "that I have found a new America in the heart of Africa."

"Moomtaz Pacha, who had been there but four months and a half, had done more work than all his predecessors combined. He was the first man who appreciated the resources of this country; who formulated plans to utilise them; and who with a resolute hand began what I am firmly convinced will eventually come to be a prosperous empire, reaching from the equator to the tropic of Capricorn, and from the Indian Ocean to the Desert of Sahara."

Mr. Southworth's evidence is extremely valuable at this moment of general depression, when doubts have been expressed concerning the future prosperity of Egypt. There is the unanimous testimony from numerous travellers that a mine of agricultural wealth lies upon the southern limit of the great Nubian deserts, simply requiring a line of railway for its immediate development. There are lands in many portions of the globe that are adapted by soil and climate for the cultivation of cotton, but in most cases where such facilities exist there is a scarcity of labour. In the Soudan we find not only an apparently boundless extent of fertile soil where the cotton shrub is indigenous, but a large population is at hand who are only too ready to work for a fair remuneration. It may perhaps be forgotten by many that the ancient historian Pliny calls attention to the "wool-bearing trees of Ethiopia." In the days of Herodotus, whose descriptions of Egypt are so graphic, cotton was unknown, and the Egyptians were renowned for the manufacture of the finest linen from the native flax; it was only in the reign of Mehemet Ali Pacha, the grandfather of the present Khedive, that cotton was introduced into Egypt. Curiously enough, this was seed from the "wool-bearing trees of Ethiopia," which was brought into Egypt by an enterprising French traveller upon his return from the Soudan. When we consider the important assistance that was rendered to England by Egypt during the American civil war by an extraordinary effort in the production of cotton, we must feel a more than usual interest in the development of the vast cotton-producing resources of the Soudan. It is the natural hot-bed of the cotton plant, where it has existed from time immemorial; we have only to construct a railway either to the Port of Souakim on the Red Sea, or direct to Cairo according to the plan of Mr. Fowler, and the Soudan will at once deliver its vast burden of riches.

Mr. Southworth upon his arrival at Khartoum discovered that owing to the impediments to navigation caused by the vegetable obstructions on the White Nile, it was quite impossible to carry out his original idea of joining the expedition of Sir Samuel Baker. The enterprising Governor of the Soudan, Moomtaz Pacha, showed him every attention, and invited him to an excursion by steamer up the White Nile. During this voyage Mr. Southworth was struck by the extraordinary fertility of the soil in the vicinity of the river, together with the great advantages of water communication as a means of transport from the interior.

In spite of the vast natural resources of the country, Mr. Southworth, who was now fairly behind the scenes, quickly perceived the moral cancer that preyed upon the Soudan and completely paralysed all progress; this was the slave trade, which engrossed the attention and energies of the population. He writes (page 355): "A slave expe-

dition starting under the title of an ivory enterprise means war. As high as 5,000 soldiers are employed by a single trader. Agâte had over this number on the White Nile; Cushick Ali, 4,000; Gatise, 4,000; Bizelli, 800. Thus the slave trade in the valley of the Upper Nile is sustained by an active force quite as large as the standing army of the United States." . . . "By examining the most exhaustive consular statistics on the ivory trade, I find that no expedition could pay the first cost. The traders do not expect it; so that when you read of a great ivory trader you may substitute, with little fear of doing an injustice, 'an infamous slave-trader.'" At the time that Mr. Southworth's sympathies were enlisted against this abominable traffic, he thus speaks (page 216) of the Khedive's expedition under Sir Samuel Baker to suppress the slave-hunters: "As long as Baker remained a Pacha at Gondokoro (now Ismailia) there was no danger of a direct White Nile slave trade. Indeed, the traffic may be said to have been closed." . . . "When I say 'direct slave trade,' I mean no slaves could be made to descend within the reach or knowledge of Baker Pacha. But unhappily he could not cover a whole continent." In page 213 he writes: "Sir Samuel Baker has been in that region its only vigorous European combatant, and more to him than any other man will be due the praise of its utter eradication, if the day ever arrives."

Mr. Southworth, as Secretary of the American Geographical Society, has a perfect right to express his opinions upon the "sources of the Nile," although he did not personally travel far upon the White River. He is somewhat perplexed by the pretensions of Col. Long, who, as a member of Col. Gordon's staff, travelled up to the capital of the King M'Tésé, with whom Sir Samuel Baker had established a permanent alliance. Col. Long, on his return from the Victoria N'yanza Bay, which forms the embouchure of the Victoria Nile exit (discovered by the late Capt. Speke), continued his course down stream by canoe to Foweera, the headquarters of Rionga. He reported that the mighty Victoria N'yanza was only fifteen miles broad, and that Speke had greatly exaggerated the size. He further reported that he had himself discovered an immense lake a few miles south of M'rooli (N. lat. 1° 36'), which he suggested was the "source of the Nile." These pretensions were never accepted by geographers, it being well known that at certain seasons the Victoria Nile floods many leagues of country above M'rooli; this would give a stranger an erroneous impression of a permanent lake. The recent explorations of Mr. Stanley, who claims to have coasted in his boat 1,000 miles of the Victoria N'yanza along the southern, eastern, and northern shores, is a sufficient refutation of Colonel Long's disparaging assertion that Capt. Speke's Victoria N'yanza was only fifteen miles across. Mr. Southworth with true discrimination suggests on page 302: "It is possible that Col. Long's lake was only the Nile in a very swollen condition; for I have seen the Nile at latitude 13° N. at very high water resemble a vast lake." On page 316 Mr. Southworth writes: "Dr. Livingstone's claims may be considered as out of the question. Lieut. Cameron has almost completely proven that Livingstone never saw the Nile, but that his operations were confined to the Congo Basin." On p. 317 the author thus summarises: "It practically reduces the Nile problem to this. The

sources must be in the Albert and Victoria N'yanzas or their extensions; in the new lake of Col. Long; at the head waters of the Bahr-el-Ghazal, and in the sources of the feeders of the Blue Nile and the Atbara." We will dismiss the "new lake of Col. Long," but remind Mr. Southworth that he has omitted the most powerful of the White Nile affluents—the Sobat—N. lat.  $9^{\circ} 21'$ !

There can be no doubt the Victoria N'yanza is a mighty reservoir or principal source of the Nile, and the friends of the lamented Capt. Speke will rejoice in the triumph of his discovery now rendered certain by the survey of Mr. Stanley. The Albert N'yanza has never been visited by any Europeans except Sir Samuel and Lady Baker in February 1864; thus nearly twelve years have elapsed since its discovery, and yet no European has been able to reach its shores, although its waters were again sighted by Sir S. Baker during the expedition of the Khedive of Egypt.

There can be little doubt that Col. Gordon will succeed in exploring the Great Basin of the Nile, which will prove to be not only a source, but the general reservoir or basin that receives all equatorial affluents.

Although Mr. Southworth's travels do not include any new ground, his book affords much useful information, which will be received with more than ordinary interest at the present moment, when Egyptian affairs are prominently before the public.

---

#### OUR BOOK SHELF

*Discoveries and Inventions of the Nineteenth Century.*  
By Robert Routledge, B.Sc., F.C.S. With numerous Illustrations; pp. 594. (London: George Routledge and Sons, 1876.)

IN this book "an attempt has been made to present a popular account of remarkable discoveries and inventions which characterise the present century." "The instances selected have been those which appeared to some extent typical, or those which seemed to have the most direct bearing upon the general progress of the age." "The author has endeavoured to indicate, if not to explain, the principles involved in each discovery and invention."

These extracts from the preface sufficiently explain the object of the work before us. Anyone who attentively reads this book must admit that the author has succeeded in fulfilling the promise of his preface. He has produced a work teeming with useful and exact information presented in a singularly lucid and taking style. Of course this book cannot in any way take the place of the acknowledged manuals on the several subjects of which it treats, but it is admirably adapted to awaken an interest, especially among the young, in those wonderful advances which natural science has made in the present century; and to supply such a general knowledge as shall convey a correct idea of the principles on which the application of science to arts and manufactures are based, along with a sufficiently detailed account of these manufactures themselves.

Books, the general plan of which resembles that of this work, have been too often produced by men who had no scientific knowledge of the processes they attempted to describe, and have therefore shown a lamentable deficiency in exactness of detail and accuracy of theory. That the book before us should have escaped these faults, faults for which no brilliancy of diction or popularity of style can atone, is to be traced to the fact that its author has evidently determined, and has been able to carry out his determination, to make the book a scientific one; to show, as far as could be consistently with the general tone

of the work, that theory is necessary for correct practice, and that correct practice reacts upon theory. The contents of the book include an account of steam engines, iron, tools, railways, steam navigation, fire-arms, printing machines, light, the spectroscope, electricity, photography, aquaria, india-rubber, explosives, mineral combustibles, coal gas, &c. A very interesting chapter is devoted to New Metals, in which a clear and succinct account of the discovery and present method of producing sodium, potassium, aluminium, and magnesium is given. The gradual diminution in the cost of these metals, and therefore their increasing application in manufactures as chemical science has discovered easier methods for their preparation, is an argument in favour of the study of pure science which must appeal, one would think, even to the Philistines.

The title which the author has chosen for the closing chapter of his book, viz. "The greatest discovery of the age," might lead one to look for a glowing account of some new invention to economise labour or to annihilate pain, but when we find that the chapter is devoted to a sober account of Dr. Joule's experimental determination of the mechanical equivalent of heat, and to some of the consequences deduced therefrom, we are but the more convinced that this book must rank among the few popular works which are sure to be of service in spreading a knowledge of the incalculable benefits which science has bestowed upon the human race.

M. M. PATTISON MUIR

---

#### LETTERS TO THE EDITOR

[The Editor does not hold himself responsible for opinions expressed by his correspondents. Neither can he undertake to return, or to correspond with the writers of, rejected manuscripts. No notice is taken of anonymous communications.]

##### Scientific Research for the Promotion of Science

IN NATURE, vol. xii. p. 470, there are some valuable summaries of evidence taken before the Government Science Commission; but among them I was surprised to meet with the statement (by Captain Galton, R.E.) that, as one of the varieties of administration of several existing scientific institutions, "you have the Observatory at Edinburgh as part of the University of Edinburgh."

Now, inasmuch as I have for the last thirty years held the Directorship of the Edinburgh Observatory, by virtue of my appointment thereto signed by her Majesty, I should know something of the real facts of the case; and they oblige me to state that the Royal Observatory (the only Observatory) in Edinburgh is supported, in so far as it exists at all, by Government. It is responsible, moreover, solely to Government, in the person of the Principal Secretary of State for Home Affairs; it has never at any time received a farthing from the University of Edinburgh, whether for instruments, salaries, general maintenance, or particular services; and does not form any part of, nor belong to, nor did ever belong to, the said University in any manner whatever.

But the efficiency of the Observatory has been crippled from the beginning by the connection of its Director with the University; and as that offers a practical answer to the question much discussed in your pp. 429 and 470, touching whether there is, or is not, any difference in kind, nature, interests and feelings between institutions for the promotion of science by original observation on one side, and on the other the usually much larger and more numerous institutions for education,—I trust you will allow me a little space wherein to describe our actual and long-continued experiences here.

Built by the members of the late Astronomical Institution of Edinburgh between 1811 and 1830, this Observatory was, after many public petitions to that end, graciously taken up by Government in 1834, and its future utilisation secured by arrangements for the appointment thereto of a Royal Astronomer with an assistant, and a small allowance for ordinary working expenses. The first Astronomer so appointed was the late Thomas Henderson, the best man by far for such a post whom Scotland has ever possessed; and as he had at that time just returned from being Astronomer Royal at the Cape of Good

Hope, and had there secured and brought home the most astounding amount of both useful and even super-excellent astronomical observations that ever one man made in twelve months,—there was no apparent reason why he should not at once have been allowed to step straight into this new Observatory appointment, and commence its laborious duties forthwith.

But that was not to be; for he was privately informed that he must first and preliminarily be appointed a Professor in the University of Edinburgh. He started at and resisted the idea; he said he did not want to be a Professor, and would not be one; it was an occupation wholly foreign to his tastes, and entirely incompatible with the full and conscientious devotion of himself to being a working astronomer within the Observatory. Pressure, however, of powerful friends was brought to bear upon him; and he was made to understand that Government could not, or would not, whatever the secret reason, create and set agoing the new appointment for the Observatory on the Calton Hill, of "Astronomer Royal for Scotland," without first connecting it with a certain old and shameful sinecure in the University of Edinburgh, called the Professorship of Practical Astronomy.

He was indeed assured that he would, and should, never be called on to lecture in the Professorship; that it was a mere name and nothing more; and his form of appointment to the strangely and unnaturally duplex post of the old Professorship and the new Astronomer Royalship, was made out in words assigning clearly enough the work in the Observatory, of "with zeal and diligence making observations for the extension and improvement of astronomy, geography, and navigation, and other branches of science connected therewith," to be his only circle of duties and his only claim to salary, viz. 300*l.* per annum. But then how were those promises fulfilled; or rather, how were they neglected and overborne when the multitudinous heads of the great educational University of Edinburgh had once got poor Thomas Henderson, the first Astronomer Royal for Scotland, safe within their thrall as being also a Professor before them?

Why thus: they immediately began treading on his toes from every side; and with the most magnificent disregard that he had anything worthy of notice to do in the Observatory, they forced on his attention, both in season and out of it, "that while they were working so hard in the great educational hive, he was a mere drone, and yet was in receipt of a salary of 300*l.* per annum, an absolutely larger salary than any of themselves who bore the brunt and burden of the tuition of all the students." For the complainers, be it remarked, left out of view, that if their incomes did not mount up to 300*l.* in the shape of salaries, it was because they came to them chiefly in the form of students' fees; and in that phase sometimes reached 1,000*l.*, 1,300*l.*, and even 1,600*l.* per annum.

But this difference the teaching Professors could not see; and so, if, as they knew perfectly well, there were no students applying for Practical Astronomy Lectures, they determined that the Practical Astronomy Professor should still be educationally utilised, and as an assistant to other Professors, if not as a Professor on his own account. Wherefore Thomas Henderson was talked at, and talked at, until for one winter he was prevailed on to give lectures in the University to the Mathematical Class during the illness of its Professor. Then he was induced to take up the onerous position of Secretary to certain University trusts. And then, while that was still going on, he was over-persuaded into giving lectures for the then Professor of Natural Philosophy during one of his retirements; and then,—why, then, Thomas Henderson, who was all this time struggling almost superhumanly by night and by day to keep up his observations as Astronomer Royal for Scotland in the Royal Observatory, Edinburgh,—why, then—he died! Died too at the early age of forty-six years, and Scotland has not seen his like either before or since; for he was in fact the one and only high-class and complete practical astronomer whom his country and his nation have ever produced; and yet he was hurried to a premature grave, trampled on by an unsympathising educational University.

Of my own troubles in trying to fill this truly great man's place, I could tell a vast deal, but would rather merely refer to my last official Report to the Government-appointed Board of Visitors of the Royal Observatory, Edinburgh; wherein, after showing forth the recent attempts of the University authorities actually to "transfer" from the Astronomer Royalship of Scotland the whole of the salary originally appointed to that office by the Crown, and take it over to their own studentless Professorship, I have finally besought the Board to apply to

Government to separate the two offices absolutely and for ever.

Most heartily convinced therefore must I be of the positive wisdom of those weighty words of Colonel Strange, alluded to in your p. 429; wherein, after stating his belief that there should be a Minister of Science, to look after the interests of institutions for the promotion of science, as entirely apart from any or all the institutions for education, whether in science or anything else, that most sage and experienced officer goes on to say:—

"That he considers education to be quite a different thing from national research, and that they should be kept as distinct as possible; and that one great evil now existing is the mixing up of those two things."

PIAZZI SMYTH,

Professor, and Astronomer Royal for Scotland  
Royal Observatory, Edinburgh

#### Ericsson's Researches on the Sun

In your interesting journal (vol. xii. p. 519) I see a description of an experiment by Capt. Ericsson, intended to measure the difference of temperature between the centre and the edge of the sun. I do not intend to make here any criticism on this experiment, but only to make some remarks on the final conclusions.

We must first distinguish two kinds of results—one directly given by the observation, the other by calculation.

In the first, we agree as far as is possible in considering the different methods of solving this question. He finds, indeed, that the intensity near the edge is 0.638 of that of the centre, the outer zone being in the mean line 49' distant from the edge, and consequently large,  $98'' = 1' 38''$ . On my experimenting on a small area not exceeding one minute square, and distant from the centre  $14' 920 = 14' 55'' 2$  (and consequently distant in September from the edge 62''), I found 0.5586. The difference is indeed not very considerable, being 0.0794. Now Plana has shown, in the *Astron. Nachrichten*, No. 813, that such a small difference may lead to a very considerable difference in the value of the absorption.

The value of the solar atmospherical absorption, according to Mr. Ericsson, cannot be greater than 0.144 of the radiant heat emanating from the photosphere (page 520), and he then quotes my results, in which it is stated that 0.38 is absorbed by the whole atmosphere. He proceeds to remark: "It is unnecessary to criticise these figures presented by the Roman astronomer, as a cursory inspection of our table and diagrams is sufficient to show the fallacy of his computations."

I beg leave to observe that the fallacies are not only my own, but those of Laplace and Plana as well, who from the numbers of Bouguer's have arrived at a conclusion very similar to my own. The fallacy, I think, is rather in Mr. Ericsson's method of calculating. In a problem of so great difficulty, and where the great analysts have established very complicated formulae, he makes use only of some very simple proportions, which are by no means justified, and with these he thinks his conclusion is very plain! I regret to say that such a method of computing in this case cannot be admitted, and consequently we are justified in attributing the difference of the results, not to the fallacy of our computation, but to the fallacy of those proportions assumed by Mr. Ericsson, unless he, or any competent mathematician, be able to show some great error in the formulæ of Laplace and of Plana.

Several objections besides may be made to his manner of experimenting, but of that on another occasion. In applying the numbers of Mr. Ericsson to the formulæ of Laplace and Plana, the result will be found to be not very different from mine. But at present I have no time to discuss these and other calculations, and also I wait for the new experiments which he has promised. I will only add that I do not share his opinion that the lenses and telescopes introduced in these researches by me do not give reliable results.

Rome, Oct. 28

P. A. SECCHI,  
Director of the Roman Observatory

#### Sir G. B. Airy and the National Standards

IN NATURE vol. xiii. p. 35, the following statement occurs:—

"In the civic speeches which accompanied the ceremony [of conferring the Freedom of the City of London], great stress was laid on Sir G. B. Airy's services in connection with the Metric Standards."

This statement is not perfectly correct.

The expression of the Chamberlain of the Corporation, as recorded in the official register, and as correctly reported in the principal newspapers, was :—



"When the national standards of measure and ponderosity were by accident lost to the nation, you were applied to for the accomplishment of their restoration with that mathematical exactitude which was indispensable."

The statement in NATURE will be made correct by erasing the word "Metric" and substituting "National."



G. B. AIRY

The Origin of our Numerals







MR. DONISTHORPE's ingenious construction of our numerals by corresponding numbers of lines (NATURE, vol. xii. p. 476) induces me to offer a few remarks on this subject, which has a literature of its own. There can be no doubt, I believe, that our forms were derived directly from the Arab series called Gobar; that the Arabs had them from the Indians, and the Indians from the Chinese. My esteemed friend Dr. Wilson, of Bombay, published a "Note on the Origin of the Units of the Indian and European numerals," in 1858,\* in which he showed the derivation of some of our numerals from ancient Indian forms found on cave inscriptions of Western India, on the Bhilsa Topes, and on coins. My remarks are founded wholly on the forms given in this note, which is little known, I believe, in England.







Dr. Wilson obtains our first four numeral forms from the Chinese, traced through different Indian script characters nearly as supposed by Mr. Donisthorpe. One, two, three horizontal bars and a square for 4. He also finds the eight in the forms , , and  on the cave inscriptions.



Before proceeding to the other numerals I wish to notice a rule which may be deduced from the consideration of the changes in the forms of numerals in passing from one people to another, that the same form may be turned through angles of 90° or 180°, and may be inverted or reversed without altering its value. Even the same people have used a form turned in different ways for the same numeral. The Arabs used their 2, 3, and 4 in two ways, making angles of 90° with each other; the 2, 4, and 5 of Sacro Bosco and Roger Bacon were the Indian script Modi (and ours) turned through 180°, or upside down; other examples will be noticed.

The most important derivation by Dr. Wilson is that from the Chinese  ten; this is found on the Bhilsa Topes with a circle round it (Dr. Wilson thinks to distinguish it from the oldest form of K found on the cave inscriptions). The nine is found on the Bhilsa Topes as , or one under ten, and on



old coins thus: . The Indian caves give half of ten ,



, for five (as V is the half of the Roman ten, X). It is from this form that Dr. Wilson derives the Indian Modi and Nagari fives , , . It is here that I venture to differ slightly from Dr. Wilson. One of the cave forms of four is , which Dr. Wilson interprets (as in the case of nine) one under five, or five less one; now this form without the under bar, as well as the other forms of five, are, it seems to me, the halves not of the cross () merely, but of the cross and circle thus:

, , , which are as nearly as possible two half diameters and half circumference. The form  is, I believe, the origin of our four, and not the Chinese or Indian square, as supposed. This I think will be evident when we compare the Arab four () with the Indian four above. The Arab four is also employed thus: , which inverted gives , a sufficiently near approximation to our four.

Dr. Wilson has not been able to find the origin of our seven, but this is obtained from his Arab seven , by turning it round () and making one leg shorter than the other, nearly

\* See "India Three Thousand Years Ago." By John Wilson, D.D., F.R.S. (Bombay: Smith, Elder, and Co., 1858.)

resembling the Gobar seven . We may also find an earlier source in the Chinese seven turned round 180°, , which is almost exactly the German written seven. Neither six nor seven is to be found on the cave inscriptions. In Dr. Wilson's Arab series the Indian five  is used for six, and the Gobar six, as

well as ours, may be taken from the Nagari seven . We may also find an origin in the Chinese six , by omitting the horizontal bar, as in the case of the seven. That such liberties were taken is evident on a consideration of the five of Sacro Bosco and Roger Bacon (), the Indian five *without the bar*, and turned round 180°. If there is any merit in these suggestions it belongs to Dr. Wilson.

JOHN ALLAN BROWN

On the Cup-shaped Joints in Prismatic Basalt

THE difference between Mr. Mallet (NATURE, vol. xiii. p. 7) and myself is simply this. He asserts, as necessary to his theory, that the "convexities" should always project in the direction in which the cooling and consequent "splitting is proceeding" ("Proceedings of the Royal Society," No. 158, p. 182). I referred him to the beautiful specimen, in the hall of the Geological Society's Museum, of three columns, one of which exhibits an articulation in the shape of a double-concave lens; the adjacent convexities consequently pointing, in this case, in *opposite directions*.

Mr. Mallet's reply to this is, that the cooling must have proceeded, in this instance, in different directions, and met in the biconcave-lens-shaped articulation. Now, inasmuch as this articulation is only a few inches (three or four) thick, and shows no sign of seam or separation across it, and Mr. Mallet himself declares (in the article mentioned above) that the plane which separates the part cooled from above, from that which cooled from below, "consists of irregular fragments," I maintain that his explanation is inadmissible and self-contradictory. Any geologist who takes sufficient interest in the question to examine the columns for himself will be easily satisfied on this point.

Nov. 8

G. P. SCROPE

A New Palmistry

THE proportions of the fingers in the two hands are not, I think, always the same. With me the index finger of the left hand is considerably longer than the ring; in the right they are very nearly equal.

R. A. PRYOR

Hatfield, Nov. 12

OUR ASTRONOMICAL COLUMN

THE MINOR PLANETS.—The discovery of No. 154 by Mr. Prosper Henry at the Observatory of Paris, on November 6th, is announced in M. Leverrier's Bulletin and by circular with the "Astronomische Nachrichten," and that of No. 155 by Herr Palisa at Pola on the 8th inst., in the Paris Bulletin of the 13th. They are of the same magnitude (twelfth) as the three previously detected during the present month.

The rapid increase in the number of small planets must soon occasion serious difficulty, not only in predicting their positions with sufficient approximation to allow of their being recognised without considerable expenditure of time and trouble, but likewise in securing observations, especially on the meridian, according to the system pursued for some years past at Greenwich and Paris, by agreement between the Astronomer Royal and M. Leverrier.

As regards the preparation of ephemerides, it is well known that the conductor of the "Berliner Astronomisches Jahrbuch," Prof. Tietjen, makes it a speciality of his work, with the aid of a numerous body of astronomers in various parts of Europe and in the United States, and hitherto he has succeeded in providing observers with an ephemeris of nearly every small planet detected to within a short time of publication. Thus, in the Jahrbuch for

1877, we find approximate places for 1875, of 134 out of 138 planets—materials for calculation not being available in four cases—and accurate opposition-ephemerides are given where the elements have been perturbed to the year, and for those planets for which Tables have been prepared. The initiated in these matters will be aware that a work of this extent involves a vast amount of labour, which will be greatly increased with the present rate of discoveries of new members of the group of small planets.

In some few instances the perturbations have been determined with every possible precision, with a particular object in view, as in the case of Themis, the motion of which was rigorously investigated by Dr. Krüger, for a determination of the mass of Jupiter; and for those planets whose perturbations have been thrown into the form of Tables, it was also necessary to settle the elements with great accuracy, though the results have not been in every case so satisfactory as might have been expected. We have now Tables of Amphitrite, by Becker; of Iris, Flora, and Victoria, by Brünnow; Egeria, by Hansen; Metis, Lutetia, and Pomona, by Lesser; and of Parthenope, Eunomia, Melpomene, and Harmonia, by Schubert.

Even with approximate places of these bodies, so long as they are situated within about 3° from the ecliptic, the charts of small stars now in the hands of astronomers allow of their being identified without much difficulty with the equatorial, and the errors of the predicted places being determined by this instrument, their meridional observation is greatly facilitated. Still, rough ephemerides must be prepared, and a considerable amount of time will be involved in ascertaining their errors, and as observations made with this purpose in view may be so conducted as to give positions pretty nearly as reliable as those generally resulting from meridional observations, we shall not be surprised to learn that the latter are soon relinquished, except perhaps for the older minor planets and for such as attain the brightness of stars of the eighth or ninth magnitude, and are accurately predicted. The subdivision of labour as regards observations does not appear to have so far worked very efficiently, though proposed many years since—another effort, however, may be necessary in this direction, and it may at least be expected that those who by their discoveries are so rapidly increasing the list of planets, will keep them in view for a sufficient length of time to allow of their elements being well determined.

Egeria, which has now about the brightness of an average star of the ninth magnitude, is favourably situated for observation; it has lately passed amongst the outliers of the Pleiades. The following places are for Berlin midnight:—

	R. A.	N. P. D.	Distance from earth.
	h. m. s.		
Nov. 18	3 18 59	65 53.3	1.478
" 20	3 16 32	65 47.8	1.479
" 22	3 14 6	65 42.6	1.481
" 24	3 11 42	65 37.7	1.484
" 26	3 9 21	65 33.1	1.488
" 28	3 7 3	65 28.8	1.493

Lutetia, a bright eleventh magnitude, is approaching opposition. Places, also for Berlin midnight, are:—

	R. A.	N. P. D.	Distance from earth.
	h. m. s.		
Nov. 18	4 54 11	68 34.1	1.480
" 20	4 52 8	68 35.0	1.477
" 22	4 50 1	68 36.1	1.474
" 24	4 47 52	68 37.3	1.472
" 26	4 45 40	68 38.6	1.472
" 28	4 43 26	68 40.0	1.472

#### SCIENCE TEACHING TO YOUNG CHILDREN

THE leading article in NATURE of Oct. 28, on the Sixth Report of the Science Commission has made me think that possibly a short account of an attempt to teach

science to boys younger than those to whom that report refers, may be not without interest for some of your readers.

There are at present about fifty boys in this school, varying in age from seven to fourteen, the majority of whom are going to one or other of the great public schools. In order to attain the high standard of classical work necessary, half the school-hours have to be given up to Latin and Greek. Enough time still remains, however, even after providing for the requirements of mathematics, French, and the usual English subjects, to enable every boy to learn either botany or chemistry. For this purpose the school is divided into three classes, the lowest of which contains about twenty boys, whose average age is nine. Class II. is composed of ten boys of an average age of twelve, while the first class contains twelve boys of an average age of twelve and a half. Class III. has two lessons in botany of three-quarters of an hour each, and one hour's lesson on physical geography in the course of the week. The boys in it are taught to distinguish the parts of a flower, and by the help of a chart similar to that given by Mrs. Kitchener in her "Year's Botany" to discover the order to which any plant belongs. The winter is employed in learning the chart, and in studying the characters of the different orders as shown on Henslow's Botanical Diagrams. Illustrations taken from Sir John Lubbock's and Mr. Darwin's books, of the relations between plants and insects, and facts bearing on the geographical distribution and economical uses of plants, add interest to these lessons. The second class also does botany, but is able to give two-and-a-half hours per week to it. The standard of knowledge aimed at is such as is contained in Prof. Oliver's or Mrs. Kitchener's books and the boys are expected to be able to find out any given plant in Bentham's British Flora. The boys in Class I. learn chemistry, and spend one afternoon of one-and-a-half hours at practical work in a small laboratory. Another afternoon is employed in listening to a lecture founded upon Miller's Chemistry (Text-books of Science series). Two additional half-hours are given to getting up the portion of Miller lectured on, so as to be able to answer questions on it at the beginning of the next lesson. The boys have also to keep notes of the lectures and of the laboratory work. The standard aimed at is the power to discover a simple acid and base, and an acquaintance with the text-book. During the summer the chemistry boys have a botany lesson once a fortnight, in order that they may keep up what they had previously learned. In addition to this regular work, Classes I. and II. have occasional lectures either on chemical physics, "Erdkunde," or some such subject. As regards marks, all the various school subjects stand on an equal footing.

The science lessons are very popular with the boys, as is shown by their frequently referring to them out of school, and by their occasionally bringing home plants in order to make them out. But we hope that the boys will retain some considerable amount of knowledge beyond the mere power of making out the flowers given to them, or that of doing simple analysis, and though perhaps few of the younger boys would be able to pass a thoroughly satisfactory written examination, in either chemistry or botany, yet a good deal more knowledge might be questioned out of even them by an experienced examiner than they would be able to put upon paper. Mere knowledge of the facts of either science is not the object at which we have been chiefly aiming. These sciences were chosen less as subjects of study than as instruments of training in order to cultivate the powers of observation, and to encourage a habit of inductive reasoning. If the teaching of science in its early stages is thus regarded more as a means than as an end, there is no child, who has begun to learn anything at all, who may not be taught some branch of it with advantage.

At the same time there is a danger to be avoided.



When we first began teaching botany and chemistry here, I was so strongly impressed by the truth of this view of the proper place of science in education, that I started by making the boys examine flowers and do simple reactions without making them learn anything by heart, hoping to induce them to collect their facts and build up their science for themselves. The result was that they did not know what to do with the facts which they collected, and kept losing them as fast as they picked them up. But since the botany boys have been set to learn the chart by heart, and since the chemistry boys have been using a text-book, the progress made has been far more satisfactory. A young child's reasoning powers are so feeble that he needs to be constantly guided in the use of them, and before being set to observe he requires to be furnished with a "cadre" in which to arrange his battalions of facts.

It may be asked why botany and chemistry should be chosen in preference to other sciences, such as geology or physics, which might seem likely to prove more attractive to boys. Botany was chosen because it is purely a science of perception, of observation and co-ordination of existing facts, and because it calls into play and directs into a useful channel that natural propensity of boys to collect and classify which is seen in butterfly catching and stamp albums. A good deal more might be made of entomology than has hitherto been attempted, but it is rather a holiday than a school subject, the bases of its classification are too minute and even arbitrary, and it has the disadvantage of leading almost of necessity up to subjects too wide for boys to grasp. Chemistry was chosen because it is a science of reflection, and forms the best introduction to the experimental method. In chemical analysis a boy has first to produce the results on which he must afterwards exercise his reason; he has to reflect on and draw his conclusions from not only what he sees, but what he does. He thus learns never to do anything without knowing why he does it and what result he expects to obtain. Chemistry also has the advantage of giving a first insight into the practical applications of mathematics. That indeed is the part of the subject which the majority of boys find most difficult. It is rare to find a boy who will readily work out arithmetically even a simple reaction. In the only possible rival to chemistry—physics—the simpler phenomena are much less varied and interesting, the bond of union between them is less apparent, the reasoning from effect to cause less patent, and there are comparatively few experiments which a child could perform for itself. Physics form an admirable lecture subject, but even then the necessary mathematical reasoning is far beyond the capacity of an average boy of twelve. Such subjects as geology and astronomy may be made most interesting, and a great deal may be done by directing children's attention to the physical actions going on in the world around them, but they are what, from a schoolmaster's point of view, I should call informational rather than educational sciences, their phenomena are generally too vast for a child's mind really to exercise itself upon them.

It will have been noticed that in no case are we able to give to science the full six hours per week recommended by the Commissioners. I would gladly do so, but do not think that it would be possible unless the standard for the classical entrance scholarships at the public schools, which of necessity fixes that of the first class at private schools, were lower than it is now, and although the entrance scholarships have raised this standard considerably above what it was only a few years ago, yet I do not think that it would be desirable to lower it, at least in translation and grammar. In composition, and especially in verse composition, I think it is a matter for consideration whether classical scholarship really benefits by expecting so much from very young boys; whether they would not learn to appreciate the delicacies of style more

quickly and thoroughly if they did not spend so much time over artificial composition before they have gained that natural facility of expressing their thoughts in their own tongue which only practice and varied reading can give; and whether therefore some part of the time now given to that subject might not, in many cases at least, be more usefully employed on other subjects, such as science and English composition, or perhaps drawing, in which boys naturally take a keen interest, and which certainly tend to give breadth of view and largeness of mind, and what is equally important, "a ready wit." Even in translation boys fail much oftener from want of knowledge of English than from want of power to construe. At present the number of entrance scholarships in which science counts for anything is so small that they may be disregarded, and certainly nothing could be less desirable for the interests of science itself, or more productive of "cram," than for scholarships to be given to boys in science alone. Would it not, however, be possible for the classical composition standard to be lowered in a considerable number of scholarships, and for one-third or one-half of the marks in them to be given to science, including practical work? The remaining scholarships might keep to their present standard in every respect, a standard which is certainly not at all too high for boys who possess real literary power, and possibly not for average boys who do not seem to possess any special bias either towards the literary or the scientific side. A plan of this sort would avoid giving that encouragement to "modern sides" which would be given by special science scholarships, and that would be an advantage, for any bifurcating arrangement is always practically very difficult to work, and has never yet produced a satisfactory result either in science or in classics.

The Commissioners are, I believe, in the right in thinking that education should be brought under the great law of progress from the more general to the special, and that it will be quite soon enough for any ordinary student to begin to concentrate all his energies on that particular line of study which is likely to prove the most valuable to him in his future career, when he has entered the university, and ought therefore to be of such an age and discretion as to be able to decide for himself what will be the probable course of his future life. From this opinion it is true that Prof. Stokes dissents, on the ground that "a wider discretion should be left to the governing bodies or head masters as to the degree to which what has been called 'stratification' of studies should be carried out." Now I am convinced, not only from theory, but from practical experience, that though stratification is undoubtedly the right course for an adult to pursue, yet that the advocates of that system do not make sufficient allowance for the intense love of novelty innate in a child, nor for the incapacity of a brain not fully developed of sustained application to any one subject. We have been led here, little by little, to diminish the length of the lessons in every subject until now scarcely any lesson exceeds half, or at the most three-quarters, of an hour in length; and the masters all agree in saying that with fairly intelligent boys they can get quite as much work done in the shorter time as in the longer. No boy can fix his attention on one subject for long together, and the moment it flags he might just as well be out in the playground as in the school-room. But if, before he has got weary of one subject, another which interests him is brought before him, he will turn to it with as much zest as if he were just beginning work. It has more than once happened that a boy in this school has needed to give special attention to certain subjects. Formerly I used to take such a boy out of his less important classes, in order that he might give extra time to his special subject. But in no case have we found that such a boy at the end of the term has made any

sensible progress beyond his fellows who had continued doing their ordinary more varied work. Though some part of this might be owing to his being outside the regular classes, yet by far the greater part was due to the monotonous work palling upon him and dulling his brain.

The education of young children should be made like their picture-books. The pictures should be such as will induce the little learner to read and study the letterpress in order to find out more about them, and for that purpose they can scarcely be too numerous. A boy when his mind first opens to the world around him is like a man in a large strange house. He must needs go about and learn the arrangement of the building, peer into every room, examine the varied prospect from every window, before he can decide which rooms he will make his own; but when once he has made his choice, he will probably keep to one or two rooms and seldom enter the others.\*

G. HERBERT WEST

Ascham House School, Bournemouth

### THE THEORY OF "STREAM LINES" IN RELATION TO THE RESISTANCE OF SHIPS†

THE address of the President of a Section would year by year possess an appropriate interest, if it could always consist of an exposition of the progress made during the past year in the department of science which the Section embraces. And many of the addresses to this and other sections have conformed to this pattern with marked success.

But the adequate preparation of an address shaped in this approved mould would require a range of experience and a grasp of thought such as few possess; and custom has wisely sanctioned a type of address which, though less appropriate to the occasion, need not be either uninteresting or inapposite. And we, in this Section, have not to search far for instances in which its President has charmed and instructed us by a masterful exposition of some single subject in practical science, or by a timely reminder of the improvident manner in which we deal with some precious store of natural wealth.

I must express a hope that it will not be regarded as a conversion of liberty into license, if the subject I have chosen obliges me to introduce a further innovation, and to use diagrams and experiments in order to make my meaning clear.

I propose to treat of certain of the fundamental principles which govern the behaviour of fluid, and this with special reference to the resistance of ships. By the term "resistance" I mean the opposing force which a ship experiences in its progress through the water.

Considering the immense aggregate amount of power expended in the propulsion of ships, or, in other words, in overcoming the resistance of ships, I trust you will look favourably on an attempt to elucidate the causes of this resistance. It is true that improved results in ship-building have been obtained through accumulated experience; but it unfortunately happens that many of the theories by which this experience is commonly interpreted, are interwoven with fundamental fallacies, which, passing for principles, lead to mischievous results when again applied beyond the limits of actual experience.

The resistance experienced by ships is but a branch of the general question of the forces which act on a body moving through a fluid, and has within a comparatively recent period been placed in an entirely new light by what is commonly called the theory of stream-lines.

The theory as a whole involves mathematics of the highest order, reaching alike beyond my ken and my purpose; but I believe that, so far as it concerns the resistance of ships, it can be sufficiently understood without the help of technical mathematics; and I will endeavour to explain the course which I have myself found most conducive to its easy apprehension.

It is convenient to consider first the case of a completely submerged body moving in a straight line with uniform speed through an unlimited ocean of fluid. A fish in deep water, a submarine motive torpedo, a sounding lead while descending

through the water, if moving at uniform speed, are all examples of the case I am dealing with.

It is a common but erroneous belief that a body thus moving experiences resistance to its onward motion by an increase of pressure on its head end, and a diminution of pressure on its tail end. It is thus supposed that the entire head end of the body has to keep on exerting pressure to drive the fluid out of the way, to force a passage for the body, and that the entire tail end has to keep on exerting a kind of suction on the fluid to induce it to close in again—that there is, in fact, what is termed a pressure throughout the head end of the body, and *minus* pressure or partial vacuum throughout the tail end.

This is not so; the resistance to the progress of the body is not due to these causes. The theory of stream-lines discloses to us the startling but true proposition, that a submerged body, moving at a uniform speed through a perfect fluid, would encounter no resistance whatever. By a perfect fluid, I mean a fluid which is free from viscosity, or quasi-solidity, and in which no friction is caused by the sliding of the particles of the fluid past one another, or past the surface of the body.

The property which I describe as "quasi-solidity" must not be confused with that which persons have in their minds when they use the term "solid water." When people in this sense speak of water as being "solid," they refer to the sensation of solidity experienced on striking the water-surface with the hand, or to the reaction encountered by an oar-blade or propeller. What I mean by "quasi-solidity" is the sort of stiffness which is conspicuous in tar or liquid mud; and this property undoubtedly exists in water, though in a very small degree. But the sensation of solid reaction which is encountered by the hand or the oar-blade, is not in any way due to this property, but to the inertia of the water: it is in effect this inertia which is erroneously termed solidity; and this inertia is possessed by the perfect fluid, with which we are going to deal, as fully as by water. Nevertheless it is true, as I am presently going to show you, that the perfect fluid would offer no resistance to a submerged body moving through it at a steady speed. It will be seen that the apparent contradiction in terms which I have just advanced is cleared up by the circumstance, that in the one case we are dealing with steady motion, and in the other case with the initiation or growth of motion.

In the case of a completely submerged body in the midst of an ocean of perfect fluid, unlimited in every direction, I need hardly argue that it is immaterial whether we consider the body as moving uniformly through the ocean of fluid, or the ocean of fluid as moving uniformly past the body.

The proposition that the motion of a body through a perfect fluid is unresisted, or, what is the same thing, that the motion of a perfect fluid past a body has no tendency to push it in the direction in which the fluid is flowing, is a novel one to many persons; and to such it must seem extremely startling. It arises from a general principle of fluid motion, which I shall presently put before you in detail—namely, that to cause a perfect fluid to change its condition of flow in any manner whatever, and ultimately to return to its original condition of flow, does not require, nay, does not admit of, the expenditure of any power, whether the fluid be caused to flow in a curved path, as it must do in order to get round a stationary body which stands in its way, or to flow with altered speed, as it must do in order to get through the local contraction of channel which the presence of the stationary body practically creates. Power, it may indeed be said, is first expended, and force exerted to communicate certain motions to the fluid; but that same power will ultimately be given back, and the force counterbalanced, when the fluid yields up the motion which has been communicated to it, and returns to its original condition.

I shall commence by illustrating the action on a small scale by fluid flowing through variously shaped pipes; and I must premise that in the greater part of what I shall have to say, I shall not require to take account of absolute hydrostatic pressures. The flow of water through pipes is uninfluenced by the absolute pressure of the water.

I will begin with a very simple case, which I will treat in some detail, and which will serve to show the nature of the argument I am about to submit to you.

Suppose a rigid pipe of uniform sectional area, of the form shown in Fig. 1, something like the form of the water-line of a vessel.

The portions AB, BC, CD, DE are supposed to be equal in length, and of the same curvature, the pipe terminating at E in exactly the same straight line in which it commenced at A, so

\* My experience has been entirely with boys, but I feel sure that elementary science might be taught with at least equal advantage to little girls.  
† Address to the Mechanical Section of the British Association, Bristol, August 25, 1875; by William Froude, C.E., M.A., F.R.S., President of the Section. Revised and extended by the author.

that its figure is perfectly symmetric on either side of C, the middle point of its length.

Let us now assume that the pipe has a stream of perfect fluid

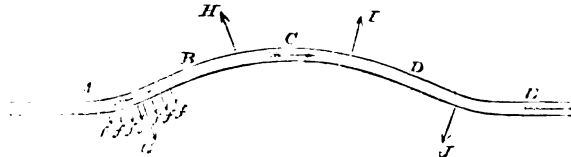

FIG. 1.

running through it from A towards E, and that the pipe is free to move bodily endways.

It is not unnatural to assume at first sight that the tendency of the fluid would be to push the pipe forward, in virtue of the opposing surfaces offered by the bends in it—that both the divergence between A and C from the original line at A, and the return between C and E to that line at E, would place parts of the interior surface of the pipe in some manner in opposition to the stream or flow, and that the flow thus obstructed would drive the pipe forward; but if we endeavour to build up these supposed causes in detail, we find the reasoning to be illusory.

I will now trace the results which can be established by correct reasoning.

The surface being assumed to be smooth, the fluid, being a perfect fluid, can exercise no drag by friction or otherwise on the side of the pipe in the direction of its length, and in fact can exercise no force on the side of the pipe, except at right angles to it. Now the fluid flowing round the curve from A to B will, no doubt, have to be deflected from its course, and, by what is commonly known as centrifugal action, will press against the outer side of the curve, and this with a determinable force. The magnitude and direction of this force at each portion of the curve of the pipe between A and B are represented by the small arrows marked *f*; and the aggregate of these forces between A and B is represented by the larger arrow marked G. In the same way the forces acting on the parts BC, CD, and DE are indicated by the arrows H, I, and J; and as the conditions under which the fluid passes along each of the successive parts of the pipe are precisely alike, it follows that the four forces are exactly equal, and, as shown by the arrows in the diagram, they exactly neutralise one another in virtue of their respective directions; and therefore the whole pipe from A to E, considered as a rigid single structure, is subject to no disturbing force by reason of the fluid running through it.

Though this conclusion that the pipe is not pushed endways may appear on reflection so obvious as to have scarcely needed elaborate proof, I hope that it has not seemed needless, even though tedious, to follow somewhat in detail the forces that act, and which are, under the assumed conditions, the *only* forces that act, on a symmetrical pipe such as I have supposed.

Having shown that in the case of this special symmetrical curved pipe the flow of a perfect fluid through it does not tend to push it endways, I will now proceed to show that this is also the case whatever may be the outline of the pipe, provided that its beginning and end are in the same straight line.

Assume a pipe bent, and its ends joined so as to form a complete circular ring, and the fluid within it running with velocity round the circle. This fluid, by centrifugal force, exercises a uniform outward pressure on every part of the uniform curve; and this is the only force the fluid can exert. This pressure tends to tear the ring asunder, and causes a uniform longitudinal tension on each part of the ring, in the same manner as the pressure within a cylindrical boiler makes a uniform tension on the shell of the boiler.

Now, in the case of fluid running round within rings of various diameter, just as in the case of railway trains running round curves of various diameter, if the velocity along the curve remain the same, the outward pressure on each part of the circumference is less, in proportion as the diameter becomes greater; but the circumferential tension of the pipe is in direct proportion to the pressure and to the diameter; and since the pressure has been shown to be inversely as the diameter, the tension for a given velocity will be the same, whatever be the diameter.

Thus, if we take a ring of doubled diameter, if the velocity is unchanged, the outward pressure per lineal inch will be halved; but this halved pressure, acting with the doubled diameter, will give the same circumferential tension.

Now this longitudinal tension is the same at every part of the

ring; and if we cut out a piece of the ring, and supply the longitudinal tension at the ends of the piece, by attaching two straight pipes to it tangentially (see Fig. 2), and if we maintain the flow of the fluid through it, the curved portion of the pipe will be under just the same strains as when it formed part of the com-

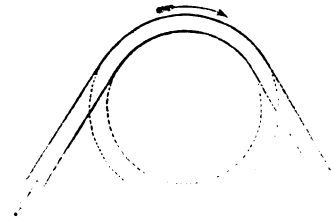

FIG. 2.

plete ring. It will be subject merely to a longitudinal tension; and if the pipe thus formed be flexible, and fastened at the ends, the flow of fluid through it will not tend to disturb it in any way. Whatever be the diameter of the ring out of which the piece is assumed to be cut, and whatever be the length of the segment cut out of it, we have seen that the longitudinal tension will be the same if the fluid be moving at the same velocity; so that, if we piece together any number of such bends of any lengths and any curvatures to form a pipe of any shape, such pipe, if flexible and fastened at the ends (see Fig. 3), will not be disturbed by the

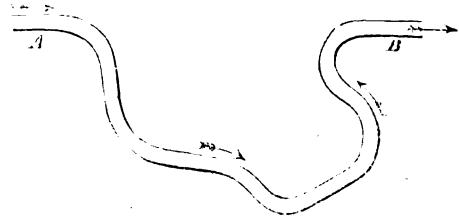

FIG. 3.

flow of fluid through it; and the equilibrium of each portion and of the whole of the combined pipe will be satisfied by a uniform tension along it.

Further, if the two ends of the pipe are in the same straight line, pointing away from one another (see Fig. 4), since the

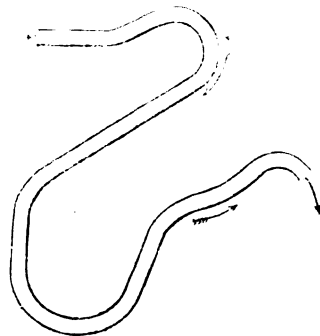

FIG. 4.

tensions on the ends of the pipe are equal and opposite, the flow of the fluid through it does not tend to push it bodily endways.\*

This is the point which it was my object to prove; but in the course of this proof there has incidentally appeared the further proposition, that a flexible tortuous pipe, if fastened at the ends, will not tend to be disturbed in any way by the flow of fluid through it. This proposition may to some persons seem at first sight to be so paradoxical as to cast some doubt on the validity of the reasoning which has been used; but the proposition is nevertheless true, as can be proved by a closely analogous experiment, as follows:—

Imagine the ends of the flexible tortuous pipe to be joined so as to form a closed figure (see Fig. 5), there will then be no need for the imaginary fastenings at the ends, since each end will

\* See Supplementary Note A.

supply the fastening to the other. Then substitute for the fluid flowing round the circuit of the pipe, a flexible chain, running in the same path. In this case the centrifugal forces of the chain running in its curved path are similar to those of the fluid flow-

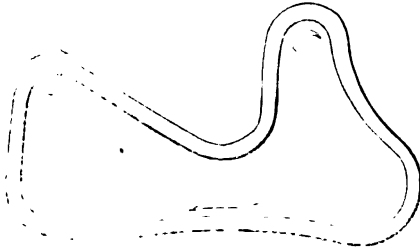

FIG. 5.

ing in the pipe; and the longitudinal tension of the chain represents in every particular the longitudinal tension on the pipe.

As a simple form of this experiment, if a chain be set rotating at a very high velocity over a pulley in the manner shown in Fig. 6, it will be seen that the centrifugal forces do not tend to disturb the path of the running chain; and, indeed, the velocity being extremely great, the forces, in fact, tend to preserve the path of the chain in opposition to any disturbing cause. On the



FIG. 6.

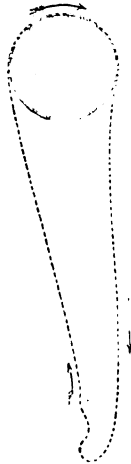

FIG. 7.

other hand, if by sufficient force we disturb it from its path, it tends to retain the new figure which has been thus imposed upon it (see Fig. 7).

The apparatus with which I am about to verify this proposition has been lent to me by Sir W. Thomson. It is one which he has used on many occasions for the same purpose; and I must add that the proposition in his hands has formed the basis of conclusions incomparably deeper and more important than those to which I am now directing your attention.

You observe the chain when at rest hangs in the ordinary catenary form, from a large pulley with a very wide-mouthed groove and mounted in a frame which is secured to the ceiling. By a simple arrangement of multiplying bands the pulley is driven at a high speed, carrying the chain round by the frictional adhesion of its upper semi-circumference. When at its highest speed the chain travels about 40 per second.

The idea that the chain when thus put in motion will be disturbed by its centrifugal force from the shape it holds while at rest must point to one of two conclusions; either (1) the chain will tend to open out into a complete circle, or (2) it will on the contrary tend to stretch itself at its lower bend to a curvature of infinite sharpness.

But you observe that no tendency to either change of form appears. On the contrary, the chain, instead of taking spontaneously any new form in virtue of its centrifugal force, has plainly assumed a condition under which it is with difficulty disturbed, alike from its existing form, or from any other which I communicate to it by violently striking it. Such blows locally indent it almost as they would bend a bar of lead.

In spite, however, of this quasi-rigidity which its velocity has imparted to it, it does, if left to itself, slowly assume, as you perceive, a curious little contortion, both as it approaches and as it recedes from the lower bend of the catenary; and it is both interesting and instructive to trace the cause of the deformation.

I have already explained that the speed of the chain subjects it throughout to longitudinal tension. Speaking quantitatively, the tension is equal to the weight of a length of the chain twice the height due to the velocity. This is  $\frac{v^2}{g}$ , and thus, as the

speed is 40 feet per second,  $\frac{1600}{32} = 50$  feet, or with this chain about 14 lbs.

Now in travelling through the lower bend of the catenary, the chain passes from being nearly straight, to being sharply curved and immediately straightened again, and this change of form involves a continued pivoting of link within link, the friction being called into action by the tension which presses the surfaces together. Each link thus in succession resists this pivoting with a definite force, and the resistance, in effect, converts what appears to be a perfectly flexible combination into one possessing a tangible degree of stiffness, and the oblique attitude assumed by the chain as it approaches the bend, and the slight back turn which it assumes as it emerges from the bend, are alike consequences of this factitious stiffness.

For in virtue of gravity, the running chain, like the chain at rest, tends always to maintain the original catenary; and in virtue of its speed of rotation, it seeks to maintain (not preferentially the catenary, but) whatever form it for the moment possesses. Hence its departure from the true catenary was, as you saw, gradual. But when the figure of equilibrium is once attained, the persistency of form imparted by velocity serves to maintain this figure as indifferently as any other. Hence the figure is that in which equilibrium subsists between the force of gravity seeking to restore the catenary, and the factitious stiffness resisting the necessity of bending and unbending.

The slowness with which the form is assumed, and its steady persistency when once assumed, alike bear witness to the truth of the proposition which it is the object of the experiment to verify.

The stream of fluid in the tortuous flexible pipe would behave in a strictly analogous manner.

(To be continued.)

#### NOTES

It is with great regret that we hear of the death of Dr. von Willemoes-Suhm, the distinguished naturalist assisting Prof. Wyville Thomson in the *Challenger*. Information of the sad occurrence has just been received at the Admiralty.

At the opening meeting of the Royal Geographical Society on Monday, the president, Sir H. Rawlinson, reviewed the progress of the Society and of geographical discovery during the past year. He announced that the Prince of Wales, the Vice-patron of the Society, had just sent the Society, as the first geographical result of his tour in the East, a very interesting collection of route-maps of Upper Egypt and its recently acquired dependencies, which had been executed in the Topographical Department of the Egyptian War Office by General Stone, Chief of the Etat Major, from materials furnished in one direction by Col. Gordon and the officers serving under his orders, and in another by Col. Purdy and the officers of the Darfur Expedition. These maps contain much new geographical matter. The President referred with great satisfaction to Stanley's exploration of the Nyanza, and exhibited a complete chart of the lake drawn by Stanley. As to Col. Gordon, who by last accounts had reached Appudo, 140 miles from the Albert Nyanza, if he could overcome the eight miles of rapids which lay before him, he would probably reach the Albert Nyanza with his steamer the *Khedive*, before Stanley. Both Gordon and his assistant Chipendall report, from native information, that the Nile leaves the Albert Nyanza by two channels. Dr. Pogge and Dr. Lasaulx, the only remaining members of the German African

expedition, have shifted their ground to the south, with the intention of starting from the Loanda base, and making their way *vid Cassange* to the mysterious capital of Matiamno. The President then referred to Capt. Trotter's work on the Panjah River, and to the Russian scientific expedition to Hissar, by which we are now able to construct a reliable map of the country between the Upper Oxus and Jaxartes. Sir Henry then spoke of New Guinea, and of the failure of Macleay's expedition. D'Alberty has during the late spring and summer been occupied in natural history researches on Yule Island, while the Rev. S. Macfarlane and Mr. Stone have discovered and ascended for a distance of sixty miles a large river on the south coast of New Guinea. The river is from one to a quarter mile broad, and from three to twelve fathoms deep, and might easily be made navigable for more than 100 miles. It is proposed to call it the Baxter River. At the close of his address, the President observed that at the next meeting the subject of the Victoria Nyanza will be fully gone into, and that the discussion on that subject had better therefore be reserved until that occasion. Mr. W. L. Watts afterwards read a paper on his journey last summer across the Vatna Jökull, Iceland.

THE *Daily Telegraph* of Monday contains Mr. Stanley's letter which was sent home by the unfortunate Col. Linant de Bellefonds. It is dated "Mtesa's Capital, Uganda, April 12," and is principally occupied with an account of Mr. Stanley's voyage round the southern, eastern, and north-eastern shores of the Victoria Nyanza. His exploration has evidently been made with great care, and he has ascertained with considerable certainty that Speke was right in regarding the Nyanza as only one lake. It is, however, evidently thickly studded with islands, and its coast much broken up into bays and creeks by long promontories from the land. Stanley was most hospitably received and magnificently entertained by Mtesa, who, since Speke saw him, has, with his people, turned Mahommedan. Stanley speaks of him with the greatest respect, and believes that he might be made a most effective instrument for the civilisation of [the region surrounding his capital. The *Telegraph* of Tuesday contains Mr. Stanley's map of the Nyanza, neatly reproduced.

MR. JAMES STUART, Fellow of Trinity College, has been elected Professor of Mechanism and Applied Mechanics at Cambridge University.

WE understand that the Council of the Scottish Meteorological Society have resolved to commence an investigation into the habits of the salmon. The point which is first to be investigated is the question of the earliness or lateness of the different rivers, and for this purpose they have entered into communication with Mr. Archibald Young, Fishery Commissioner, at whose suggestion various early and late rivers have been selected, and arrangements have already now been made for carrying on the necessary observations on the river Ugie, Aberdeenshire.

WE have received six large temperature and rain charts of the United States, constructed by Mr. Charles A. Schott from observations collected by the Smithsonian Institution, which show by lines the distribution of temperature for every 4° from 36° to 76°, and of rainfall for every two or four inches during summer, winter, and the year. The principle on which the temperature charts have been constructed, and which was fully described in NATURE in reviewing the annual chart in the small form in which it was first published, consists in representing actual mean temperatures, uncorrected for elevation. The whole form a set of six charts illustrative of the most prominent features of the climatology of the United States, and are calculated to prove of great utility in many practical matters.

THE Report of the Commission appointed by the Prussian Government for the scientific investigation of the Baltic and North Sea, for 1872 and 1873, has just been published. The

Report (pp. 380), which is a very valuable one and well illustrated, contains discussions on the fisheries of the German coasts, by Dr. V. Hensen; and on the physical observations made at the various stations of the Commission, by Dr. G. Karsten; together with interesting papers by Dr. H. A. Meyer, Dr. P. Magnus, Dr. K. Möbius, and others, on the currents, temperature, and specific gravity of the sea, and on the botanical and geological results of the expedition which was undertaken during the summer of 1872 with the view of collecting data bearing on the physics, chemistry, and biology of the North Sea. We hope to examine this at length in an early number.

DR. BURMEISTER, Director of the National Museum of Buenos Ayres, has in course of preparation a complete scientific description of the Argentine Republic. The first volume, containing the history and geography, is already in the press. The second, containing the meteorology, physical geography, and biology, is in preparation. The work is in German, but the Argentine Government has undertaken a French translation of it.

DR. BURMEISTER has also nearly ready a description of a complete skeleton of the Fossil Horse of Buenos Ayres (*Hippidium neogaeum*, Owen), of which but fragmentary portions have been previously known.

AN important work on the Zoology of Eastern Asia will appear in Russia before the close of the current year. It will comprise the results of the journey undertaken by Colonel Przevalski in Western China, and it will include descriptions of many new and interesting species. It is not improbable that a translation will be published in English.

WE would draw the attention of our biological readers to Mr. G. E. Dobson's valuable *Conspectus* of the sub-order, families, and genera of Cheiroptera, arranged according to their natural affinities, in the "Annals and Magazine of Natural History" for this month.

WE have received Prof. Cope's systematic catalogue of Vertebrata of the Eocene of New Mexico collected in 1874, containing the account of forty-seven species, of which twenty-four are described for the first time. The genera *Bathmodon* and *Uintatherium* are placed in a new order—Amblipoda—by themselves, and the foot of the former is figured, with three phalanges to the hallux, which is evidently inaccurate.

WE have also received a paper by Prof. O. C. Marsh, on the *Odontornithes*, or birds with teeth, containing illustrations of parts of *Ichthyornis dispar* and *Hesperornis regalis*.

MR. W. H. DALL, of the U. S. Coast Survey, has published the results of his examination of Mount Saint Elias, Mount Fairweather, and other peaks of the range which skirts the coast of the narrow strip in the south of Alaska; Mount St. Elias, however, really seems to be in British territory. Very various heights have been given to the latter from La Pérouse downwards, varying from 12,600 to 17,800 feet, the British Admiralty Chart making it 14,970 feet. Mr. Dall, from many careful observations, gives the height as 19,500 feet, with a possible error either way of 400 feet. Mount Fairweather he gives as 15,500 feet; Mount Crillon, 15,900 feet, with possible error of 500 feet; Mount Cook, 16,000 feet; Mount Vancouver, 13,100 feet; and Mount La Pérouse, 11,300 feet, the last three being approximate. The names of Cook and Vancouver have been given by Mr. Dall to two high peaks of the St. Elias range to the southward and eastward of St. Elias; to a high peak near the sea, at Icy Cape, he has given the name of La Pérouse; Mount Crillon is to the south of Mount Fairweather. The following are the geological conclusions at which Mr. Dall arrives with regard to this range:—That these Alps are, like the high Sierra of California, mainly composed of crystalline rocks, and in their

topography, their small, pustular, basaltic vents, their associated marbles, quartzites, and later conglomerates, exhibit a close parallel to the Sierras; that parallelism in structure and composition implies parallelism in age and method of formation; and, finally, that the volcanic origin of the high peaks is opposed not only by analogy, but by the known facts." An examination of the clear sketches certainly seems to bear out Mr. Dall's conclusion that these peaks are not of the volcanic type.

LONDON has at last come in for her share of the disasters by flooding which have devastated so many river valleys in England and on the Continent. An unprecedentedly high tide caused the Thames to overflow its banks on the south side very early on Monday morning, flooding the streets and houses of Lambeth and other low-lying districts all along that side of the river, from Woolwich even to Kingston, we believe. The damage caused has been very serious and extensive, several feet of water rushing at one time through many streets on the south side, even at a considerable distance from the river. No one seems to have expected an unusual tide, though in March last year a similar phenomenon was looked for; the tide then, however, was seven inches lower than that of Monday. It is supposed that a very high spring tide with a strong gale blowing is the cause of the disaster.

THE force of the last hurricane in Paris was so great that its maximum could not be measured at the Montsouris Observatory, the magnetic anemometer having been broken by the rush of wind. The rate measured by Robinson's cups exceeded 70 kilometres per hour, when the apparatus was put out of order by the excess of central force.

MR. WILLIAM SANDERS, a well-known geologist in the West of England, died on Friday at his residence at Clifton, aged 76.

A COURSE of twelve lectures, by Mr. E. Bellamy, on the Anatomy of the Human Form, commenced last Monday, in connection with the National Art Training School, South Kensington. There are to be twelve lectures in all, to be delivered on Monday evenings.

WITH reference to the subject of the use of the movements of the sea as motive powers, referred to in NATURE, vol. xii. p. 212, Señor Don Eduardo Benot writes that the subject has been a study with him for many years, and he will be pleased to correspond with anyone who may wish to obtain information on the subject. Señor Benot's address is Barquillo 5, Madrid, Spain.

ACCORDING to a report presented by Count Hallel d'Arros to the Managing Committee, the Exhibition of Electrical Appliances, to be held at Paris in 1877, will be divided into the following groups:—1. History of Electricity; 2. Apparatus for Demonstration; 3. Piles and Batteries; 4. Electro-magnetism; 5. The Electric Telegraph; 6. The Electric Light; 7. Electric Motors; 8. Electrotyping; 9. Therapeutic Electricity.

A CORRESPONDENT at Belfast has sent us specimens of the caterpillar of *Arctia caja*, telling us at the same time that during this season, in which they have been particularly numerous, he has noticed that they have done much injury to textile fabrics laid on grass to bleach, by perforating them in circular holes, specially during sunshine after rain. The holes they make vary in size, some being very small, others large enough to admit the body of the animal. They are usually in clusters, and each is generally surrounded by a greenish coloured matter, apparently ejected by the caterpillar. This habit of *Arctia caja* is quite new to entomologists.

WE have received in a separate form, reprinted from the report of Major J. W. Powell's Exploration of the Colorado River of the West and its tributaries, a lengthy paper by Dr. Elliott Coues on the North American cheek-pouched rodent genera *Geomys* and *Thomomys*. The number of species of the former is given as five; of the latter two, of which one, *T. clausius*, is new, and is figured life size.

THE French Minister of Marine is establishing at the Depot of Maps, a new office for meteorology, which will be in some respects in connection with the Meteorological Office of the National Observatory. It will be placed under the control of Capt. Mouchez.

THE numerous reports as to the occurrence of a remarkable marine animal on the coast of New England during the past summer have induced the Boston Society of Natural History to prepare and distribute a circular calling for information on the subject.

IN a Congregation held at Oxford on Nov. 10, Prof. Bartholomew Price, Warren De la Rue, D.C.L., John Dale, M.A., and William Esson, M.A., were duly appointed visitors of the University Observatory. This is the first appointment of such visitors. The Observatory, which has been lately completed, took its rise, as our readers know, in the munificence of Dr. De la Rue.

MR. GEORGE SMITH, of the British Museum, left London last week for the East, to resume his researches in Assyria. He will be absent six months.

MESSRS. W. and A. K. Johnston have published a very clear map of India, to illustrate the travels of the Prince of Wales. It is on the satisfactory scale of seventeen miles to an inch, is fairly full but not too crowded with names, and has the proposed route of his Royal Highness clearly shown. Of course the route is liable to be altered, but anyone will be able to follow the Prince in the map without effort. Side by side with the principal map is a neat map of England on the same scale, showing at once the comparative sizes, and the fact that our country is only about twice the size of Ceylon. There is also a map of part of Europe, Asia, and Africa, showing the route from England to India. The blue surface of the wide Bay of Bengal has been utilised for a number of useful statistics concerning India. Anyone interested in following the Prince's route will find this map of great service.

THE success of the geographical play "Round the World in Eighty Days" has encouraged another Paris theatre to try an astronomical drama under the title of "Travels in the Moon." But the only astronomical part of the performance is a large moon which is exhibited in front of the theatre, showing to an admiring crowd the principal features of Beer and Madler's well-known lunar map.

CAPTAIN SOUTER, of the *Intrepid*, from the Davis Straits whale fishing, reports that while anchored in Isabella Bay on the 13th August he found, it necessary, in consequence of the great body of ice coming down, to proceed on shore. After sailing some distance he came into a fine commodious natural harbour, not marked in the charts. There was nothing to show that it had ever been entered before. Captain Souter and other officers left in a cairn a writing, indicating the discovery. Splendid water was found.

THE additions to the Zoological Society's Gardens during the past week include a Beisa Antelope (*Oryx beisa*) from Central Africa, presented by the Seyyid Burgash of Zanzibar; two Central American Agoutis (*Dasyprocta punctata*) from Central America, presented by Capt. E. Hairby and Mr. W. J. Henderson respectively; a Grey Ichneumon (*Herpestes griseus*), from India, presented by Mr. John Jennings; a Spotted Ichneumon (*Herpestes auroguttatus*) from Nepal, presented by Mr. L. B. Lewis; a Plantain Squirrel (*Sciurus plantani*) from Java, presented by Master E. H. Cole; a Malbrouck Monkey (*Cercopithecus cynosurus*) from E. Africa, presented by Mr. C. L. Norris Newman; a Dufresne's Amazon (*Chrysotis dufresniana*) from S. E. Brazil, presented by the Rev. A. Hibbet; a Mona Monkey (*Cercopithecus mona*), a Campbell's Monkey (*Cercopithecus campbelli*) from W. Africa, deposited.



THIRD REPORT OF THE SETTLE CAVE COMMITTEE (VICTORIA CAVE)\*

WORK has been carried on almost uninterruptedly throughout the year (except from March 20th to May 20th when it was stopped for want of funds), at a cost of 175*l.* 12*s.* 7*d.* Of this, 80*l.* 11*s.* 9*d.* was a balance in hand, 50*l.* the British Association grant, and 45*l.* or 100*l.* raised by private subscription.

Great progress has been made in the past year in uncovering the glacial deposits at the entrance of the cave, and showing their relation to the older bone-beds containing the remains of man with the extinct animals. The boulders are seen to cover an area of at least 1,200 square feet.† They are of all sizes, and consist of dark and white Carboniferous Limestone, and the basement bed of that formation, Carboniferous Gritstone, and Silurian Grit. Some have travelled at least two miles, and others greater distances. They are various in size, from mere sand-grains to blocks several tons in weight. An interesting section was displayed, showing the passage of the boulder-beds in one part from a regular till with large scratched stones, through scratched gravel, sand, to laminated clay, and these were so interbedded as to demonstrate that some at least of the laminated clay is of glacial age and origin.

At length, after six years' work, we are able to say that we have reached the floor of the cave at the entrance. Several pinnacles of rock have been found by the removal of the boulders; they run in lines parallel with the joints of the rock above, and give testimony to the cave having been at some time occupied by a stream, similar rock-weathering occurring in other water-caves in Craven. The arched niches on the right of the cave at the entrance lead to the same conclusion.

And now, with the additional evidence of another year's diggings, we may again consider the question, the most interesting perhaps of all the problems before us: Are the glacial deposits which rest upon the older bone-beds, containing the extinct mammals and man, in the position which they occupied at the close of the glacial conditions, or have they subsequently fallen into their present site? We may again urge the reasons given last year (see Second Report), strengthened by enlarged sections and a wider experience, which go to prove the first alternative. To these arguments we may now add the following:—That the extent of the glacial deposits now exposed is so great that it is impossible that they can be a mere chance accumulation of boulders which have been re-deposited in their present position since glacial times. This being the case, it is clear from the position of the boulders beneath all the scree, that they are a portion of the general glacial covering of the valleys and hillsides which was left by the ice-sheet at the time of its disappearance.

These are the main arguments to be derived from the cave itself, but further strong presumptive evidence, that the Pleistocene fauna lived in the North of England before the ice-sheet, exists as follows:—The older fauna once lived in this district, a point which admits of no dispute from its existence in the Victoria Cave, in Kirkdale Cave, Raygill Cave in Lothersdale, and perhaps in other caves. But their bones are now found nowhere in the open country. None of the river-gravels contain them; and just that district which is conspicuous by their absence, is also remarkable for the strongest evidences of great glaciation. Putting these facts together, the probability is very strong that it was glaciation that destroyed their remains in the open country. To suppose that these have been destroyed by other sub-aerial agencies, would be to ignore the fact that in the South of England and other non-glaciated areas, such remains exist both in the caves and river-gravels.

A few bones were found lying upon the boulders beneath the talus. They have been determined where possible by Prof. Busk, but they are only fragmentary and not of much interest; they were probably washed out of the Lower Cave-earth when it was exposed above the edge of the boulders. No fragments of bone were found throughout the 19 feet of talus which lies between the base of the Neolithic layer and the top of the boulders.

Work in Chamber D.—A considerable amount of work has been done in excavating this chamber which leads off from the principal entrance towards the right. It was choked to the roof

over the greater part of its extent, with clay and limestone blocks. It is now 110 feet long, 20 feet wide, and 20 feet high at the entrance. Two galleries lead off from it on the right. One, the Birkbeck Gallery, is made easily accessible for a distance of 44 feet, in a N E. direction. Here it becomes very narrow and leads to a narrow chasm 20 feet deep. The other gallery is blocked at the entrance with stalagmite.

A magnificent series of bones was found in Chamber D. They were all carefully registered as to their position by Mr. Jackson. The Committee are much indebted to Prof. Busk for his kindness in determining them. He says: "They are a remarkably interesting collection, especially in the Bears, and I think the larger of the two skulls is by far the finest specimen of the kind yet found in this country."

"Out of about 269 specimens, including\* detached teeth,

127	belonged to Bear
37	" " Hyæna
36	" " Bos
24	" " Fox
22	" " Deer } 15 Red Deer
	" " " } 7 Reindeer
10	" " Rhinoceros
2	" " Horse
1	" " Badger."

To these we may add 1 of Fig. 2 of Elephant, and 1 of Hippopotamus. The Rhinoceros is *hemitechus*, the Elephant *antiquus*, and the Hippopotamus, a portion of a tusk, is the only specimen of that animal found in the course of six years' digging. The careful registration of the remains has enabled your reporter to construct a section showing the distribution of the different animals throughout the different portions of the deposit. It is too bulky for publication, but the result may be given in words. The bones group themselves along two horizons separated by a greater or less thickness of laminated clay, cave-earth, and stalagmite. The lower extends from the back of the boulder-beds at the cave mouth, is continuous with that which contained the human fibula, and runs continuously as far as Parallel 42. The upper bed commences only at Parallel 15, close against the roof, and continues to Parallel 43. Where the upper bed commences, the two horizons are about twelve feet apart, but they gradually approach other, and at Parallel 35 not only touch, but seem to be somewhat commingled.

From this section we find that the following species are—

Peculiar to the Upper Bed.	Peculiar to the Lower Bed.	Common to both.
Badger.	Hyæna.	Man.
Horse.	Brown Bear?	Fox.
Fig.	<i>Elephas antiquus</i>	Grisly Bear.
Reindeer.	<i>Rhinoceros hemitechus</i> .	Red Deer.
Goat or Sheep.	Hippopotamus.	
	<i>Bos primigenius</i> .	

Brown Bear has previously been found in the upper beds in other parts of the cave. The upper bed probably contains remains from the Reindeer period to the present, those of later date being mixed up with older in the mud at the surface. But as distinguished from the lower bed, the chief characteristics of the upper appear to be the presence of the Reindeer, and the absence of Elephant, Rhinoceros, Hippopotamus, and Hyæna.

In the upper bed the only sign of man's presence consists of the spinous process of a vertebra of a bear which has been hacked apparently by some cutting instrument with a tolerably regular edge. It might have been done with a bronze celt or polished flint axe. It is probable that Chamber D was never the resort of man within the historic period. The soft wet mud of the floor, and the lowness of the roof, render it most unlikely that anyone would take to it, except under the direst necessity, or in the pursuit of science.

In the lower bed again evidence of man's presence is but scanty. At the mouth, and close to where the human fibula was found, we have this year met with a piece of rib apparently nicked by human agency. The nicks appear to have been made by some clumsy instrument drawn backwards and forwards. They are in character totally unlike the square-troughed gnawings of rodents, and the furrows heavily ploughed by the teeth of carnivores.

And now, having restricted ourselves to the hard road of

\* Abstract. Read at the Bristol meeting of the British Association, August 1875, by R. H. Tiddeman, M.A., F.G.S.

† The full report will contain two photographic plates giving a general view of the cave and a nearer view of the boulders.

fact, we may, perhaps, in conclusion, be permitted to indulge in a short flight of fancy. Let us endeavour to realise how great is the distance in time which separates the savage of Craven from our own day. We have the history of much of it in the Victoria Cave itself, and we may restore some of the missing pages from the surrounding district.

At the cave, Roman times are separated from our own by sometimes less than one, but not more than two, feet of talus, the chips which time detaches from the cliffs above. The Neolithic age, which antiquaries know was a considerable time before the Roman occupation, is represented by a layer in some places four or five feet beneath the Roman, in others even running into it. Then comes a thickness of 19 feet of talus without a record of any living thing. Judging by the shallowness of the Roman layer, this must represent an enormous interval of time. And this takes us down to the boulders, the inscribed records of the Glacial Period. They must represent a long series of climatal changes, during which the ice was waxing and waning, advancing and melting back over the mouth of the Victoria Cave. This period saw the Reindeer and the Grisly Bear occasionally in possession. Then we have an unconformity, a break in the continuity of the deposits, the boulders lying on the edges of the older beds. Time again! and that time long enough for changes to take place which allowed the district to cool down from a warmth suitable to the Hippopotamus, and become a fitting pasture-ground for the Reindeer. It was in that warm period that the early Craven savage lived and died.

But these are not all the changes which occurred in the North of England since that time. The age of the great submergence represented by the sea beaches of Moel Tryfaen and Macclesfield, and by the Middle-Sands-and-Gravels of Lancashire, has left no record up at the cave. Your reporter is of opinion that the submergence did not attain in that district a greater depth than six or seven hundred feet, and this would still leave the cave 750 feet above the sea, though it would cut up the land into a group of islands. The fact is sufficient for us, the depth is immaterial.

Upon no fact are geologists better agreed than upon the existence of a wide-spread submergence and emergence of land towards the close of the Glacial Period. No tradition is common to more races and religions than that of a great deluge. Where back in the past is the common point whence these two far-travelled, almost parallel rays of truth had their origin? In the opinion of your reporter the Craven savage who lived before the Great Ice-sheet, and before the Great Submergence, may form another of the many strong ties which bind together the sciences of Geology and Anthropology.

#### GERMAN SCIENTIFIC AND MEDICAL ASSOCIATION\*

THE following communications were made to the various sections. Of many of these papers our space permits us to give little more than the titles and names of authors:—

Section 1. *Astronomy and Mathematics.*—The laws of comets, by M. von Haucenfels.—On the idea of space, by Prof. Hoppe.—On properties of tetragons between hyperbolas, by Prof. Reitlinger.—On the criteria of maxima and minima in definite integrals, by Prof. Zmurko.—On Voigtländer's newest telescopes, by A. Martin.—On the mathematical series called chains, by Dr. Günther.

Section 2. *Physics and Meteorology.*—The new polariscope of Mach, by Dr. Subic.—The glimmer combination of Reusch and their significance for theoretical optics, by Dr. Sohnke.—The relation between the temperature and the inner friction of gases, by Capt. Obermeyer.—Dr. Prestel showed his climatographical atlas of Germany.—On changes of induction-currents through iron nuclei, by A. Ettingshausen.—On the isogonic lines in Transylvania, by G. Schenzl.—On microscopical photography, by A. Martin.—On the increase of the velocity of evaporation through electricity, by Dr. Reitlinger.—On the temperature of steam given off by solutions of salts, by L. Pfandler.—Method of representing the various constituents of weather in a short and exact manner, by Dr. Prestel.—The conducting powers of several acids for electricity, by Prof. Kohlrusch.—On mirror observations with minute mirrors, by Prof. Boltzmann.

Section 3. *Chemistry.*—On a new colouring matter, phlorin, by R. Benedict (already published in the *Annalen der Chemie*).—R. Böttger proved that Gore's inflammable antimony

contains not only chloride of antimony, but also occluded hydrogen, transforming, as it does, ferricyanide into ferrocyanide of potassium. The same chemist has found glycerine to preserve palladium-hydrogen for three months or longer. The same chemist also showed a new solvent for tri-nitro-cellulose, viz., sodic sulphhydrate.—Dr. Schwartz showed the oxidation of ammonia to nitric acid by means of hypermanganate of potassium.—Dr. Meusel proved the transformation of ammonia in water into nitrites to be due to the presence of bacteria, and to be prevented by benzoic, carbolic, or salicylic acids, that kill the bacteria.—A. Mitscherlich showed a new air-thermometer.—A. Butlerow presented observations on the transformation of hydrocarbons  $C_nH_{2n}$  into alcohols.—The same chemist has found a phenol  $C_{15}H_{24}O$  in the juice of *Cynanchum acutum*.—L. v. Pelzel showed new apparatus for disengaging gases, and new thermometers for lecture purposes.—A. Michaelis reported on the continuation of his experiments on aromatic compounds of phosphorus.—H. v. Richter on the action of cyanide of potassium on nitro-compounds, and on the transformation of aromatic amides into bromides.—M. Conrad on dichloro-aceto-acetic ether.—H. Schacherl demonstrated that hydrochloric acid and chlorate of potassium yield hypochlorous acid:—

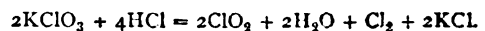

—E. Urban communicated that phosphoric anhydride transforms allylic alcohol, not into allylene, but marsh-gas.—Prof. Butlerow insisted upon the necessity of introducing dynamical views into the constitution-theory of chemical molecules, and explained his intentions by drawing attention to the various decompositions which both cyanic and hydrocyanic acids offer under different circumstances.—I. Iobst sent a communication on a Bolivian bark *Quina cola*, which is free from quinine, but contains 1½ per cent. of a new crystalline body not yet analysed.

Section 4. *Mineralogy and Geology.*—On a Labyrinthinifer found near Brünn, by A. Markowsky.—Geology of the Vienna Waterworks, by F. Karrer.—On minerals enclosed in the volcanic conglomerates of the Swabian Alps, by Prof. Nies.—On the Brown-coal Flora of Styria, by C. von Ettingshausen.—On Baer's law respecting the flowing of rivers of a southern direction, by A. Dunker.—On the influence of plants for diminishing the surface of lakes, by Dr. Senft.—On a fossil resin, Hartit, by Dr. Hofman.—On the magnesites of Styria, by Prof. Rumpf.—On the results of deep borings in the North German Plain, by Dr. Huysser.—On the granites of the mountain-range, Böhmerwald, by Dr. Woldrich.—On earthquakes (trying to demonstrate the action of the moon on subterranean volcanic eruptions), by K. Falb.—On the falling in of abandoned coal-mines in Königshütte (Silesia), by Dr. Serlo.—On eruptive formations in the Fassa-valley and Fleimservalley, by C. Dölter.—On a discovery lately made near Suttgart, of eighteen Saurians, partly measuring as much as 0.9 metres in length, by Dr. Karpff.—On corals in Tertiary sediments of Krain, by W. Linhart.

Section 5. *Botany.*—C. von Ettingshausen communicated phyto-palæontological studies in their bearing on the transformation of species; also a paper on the transformation of *Castanea atavica* into *Castanea vesca*.—Dr. Eidam described the development of the sexual organs of Hymenomyces.—On high pressure in the cells of plants, by Dr. Pfeffer.—On morphology of cryptogamea, by Dr. Prantl.—On the flora of Australia and of the Cape, by C. v. Ettingshausen.—On the sexual life of plants, by E. Strasburger.—On the vegetation of Mount Etna, by G. Strobl.—On Theophrastus as a botanist, by O. Kirchner.—On a monstrous organ in *Marchantia polymorpha*, by Prof. Leitgeb.—On acclimatising *Rheum Ribes* in Vienna, by Prof. Fenzl.—Morphology of mosses (Lebermoose) and application of phenol and essential oil of cloves for botanical preparations, by H. Leitgeb.

Section 6. *Zoology and Comparative Anatomy.*—On the zoological station at Trieste, and on a sponge, *Sycandra raphanus Faackel*, by F. E. Schulze.—On the genus *Myzostomum*, by L. Graff.—On the penis of Scolytides and the chewing apparatus of the same genus, by Prof. Lindemann.—On *Ptychoptera contaminata*, by C. Grobben.—On the circulation of molluscs, by Prof. Kollmann.—On the curves described by the legs of insects, by V. Graber.—On noctilucous Diptera at the Aral lake-district, by W. Aleuiztin.—On the ear of Heteropodes, by Prof. Claus.—On *Podocoryne carnea*, by C. Grobben.—The typical forms of the skulls of cattle, by Dr. Wilkens.—On the differentiation in certain species of beetles (*Carabus monitis*, *arrogans*, and

\* Continued from p. 34.

*Ullrichii*) produced by climate, by Dr. Kraatz.—On the anatomy of Turbellariae, by L. Graff.

Section 7. *Anatomy and Physiology*.—On the texture of the cerebellum of man, by B. Stilling.—On the time necessary for developing muscular currents, by H. Hermann.—On the nervus vagus, by Dr. Steiner.—Application of anilin-red for microscopical objects, by E. Hermann.—Contribution to the physiology of muscles, by Prof. Auerbach.—On Newton's law of temperatures with regard to animal heat, by A. Adamkiewicz.—Prof. Gscheidlen proved that the activity of nerves is connected with oxidising processes.—On the retina of snakes, by Dr. Flesch.

The Sections 8 (*Pathology*), 9 (*Medicine*), 10 (*Surgery*), 11 (*Ophthalmology and Otiatrics*), 12 (*Midwifery*), 13 (*Psychiatrics*), 14 (*Hygiene*), 15 (*Military Surgery*), and 20 (*Diseases of Children*), being devoted to medicine, must be omitted in this report; excepting, however, a paper read in Section 9, by Dr. Knapp, on the Styrian habit of arsenic-eating. The speaker introduced two men, fifty-five and twenty-five years old, who had been in the habit of eating arsenic for years, the former having contracted this habit in 1849, to save himself (in his opinion) from an epidemic of typhus then raging. The other, a farm-servant, applied arsenic to improve the health of cattle, and accustomed himself to its use. They have gradually increased the dose to about 0.5 gram.  $As_2O_3$  or  $As_2S_3$ , taken once a week. They swallowed before the eyes of the Section 0.3 gr. of orpiment and 0.5 gr. of arsenious acid respectively. Only strong people seem to adopt this habit, and they do not appear to suffer in health through it. With women it has been known to produce abortion (see also Section 17).

Section 16 "Naturwissenschaftliche Paedagogic" (*on the Teaching of Science in Schools*) was composed of teachers, who discussed the means for teaching and the extent to which science should be taught in schools.

Section 17. *Agricultural Chemistry*.—On estimating atmospheric carbonic acid, by Dr. Fittbogen.—On experiments made in the agricultural station of Proskau on the influence of shearing in increasing the weight of sheep (it being found that shearing increases their appetite), and on the influence of arsenic in fattening animals, by O. Kellner. It appears that arsenic increases the power of digesting fat, and decreases the amount of nitrogen given off in urine, thus assisting materially in the formation of flesh.—On potato-feeding, by Dr. Wolf.—On the specific weight of seeds and on the bearing of analytical results on the physiological value of seeds, by G. Marck.—On fibrous plants and their cultivation in moors for the purpose of paper-making, by H. Stierner.—On the value of animal protein, by Dr. Wild.—On the proportion of solid and liquid matter in plants in different periods of their vegetation, and on the decrease of salts in water used for watering fields in Westphalia, by Dr. König.—On the solubility of phosphates of lime, and on the treatment of bones with superheated steam, by Dr. Krockner.

Section 18. *Geography and Ethnology*.—Prof. Friesach explained a table destined for mariners to facilitate the finding of the shortest route between two points of the globe.—Dr. V. Zwiedinesk reported on a journey to the Wan Lake (Curdistan).—Von. Hochstaetter showed Mr. Mundy's photographs of New Zealand.—On the course of the Arctic vessel *Tegethof*, by Vice-Admiral Baron Willnerstorf.—On Arctic ice, by Lieut. Weyprecht.—On the project of connecting the Algerian-Tunisian plain (Chotto or Sebckhas) with the Mediterranean, by G. Stache. The author is of opinion that the advantages of this (Capt. Rondaire's) project are not in proportion to its difficulties and costs.—On Dante's views on the advancing and receding of the sea, by W. Schmidt.

Section 19. *Anthropology*.—On prehistorical remains (urns) at Maria-Rast, near Marburg (Styria), by Prof. Müller. This burial-ground was visited by the Section, as also the field near Leibnitz, where various bronzes have been found, and the tumuli near Purgstall; Count Wurmbbrand acting as guide.—The latter reported on burial-grounds in Upper Hungary.—On a burial-ground near Innsbruck, by Dr. Wieser.—On Slavian legends, by Prof. Müller.—On Celtic remains in Styria, by F. Ferk.—On the cavern of Byci-Scala in Moravia, by H. Wankel.—On diluvial man, by Count Wurmbbrand.—On lake-cities (Pfahlbauten) in the moors of Laibach, by Dr. Deschmann.—On prehistorical walls and ditches in Hungary, by Dr. Romer.—On the natural law of the formation of states, by L. Gumplowicz.—On prehistorical measures, by R. v. Luschin.—On Keltic warfare, by Dr. Weiss.

A. OPPENHEIM

## SOCIETIES AND ACADEMIES

LONDON

Mathematical Society, Nov. 11.—Prof. Cayley, F.R.S., in the chair.—Prof. Sylvester, F.R.S., gave an account of results arrived at in his communication "on the fifteen young ladies problem and a general mathematical theory of pure syntax." The problem, which was first considered by Mr. Sylvester more than twenty-five years ago, was not at that time published by him: it was then discussed by Prof. Cayley, next proposed by Rev. T. P. Kirkman in the "Lady's and Gentleman's Diary" for 1850: solutions were given in the "Diary" for 1851; but it was not until the year 1862 that an elaborate solution was given by Mr. W. S. B. Woolhouse in the volume for that year. The problem may be enunciated as follows:—"In a school of fifteen girls, a rule has been laid down that they shall walk out every day in rows of threes, but that the same two girls shall never come together twice in the same row. The rule is supposed to have been carried out correctly during the six working days of the week, but when the time comes for their going to church together on Sunday it is found to be absolutely impossible to continue it any further. Can the rule have been carried out correctly during the six previous days?"—Other papers brought before the Society were: "On the relation between Bernoulli's numbers and the binomial coefficients," by Mr. J. Hammond. The paper, which was accompanied by a coloured diagram, showing how certain four determinants for the numbers are formed of selected coefficients, contained some interesting numerical results which follow directly from certain division formulæ given in a former paper by the same writer.—"On three-bar motion in plane space," by Mr. S. Roberts. In this communication the author determines three foci, any two of which may be taken as centres of the link movement and the nature of the linkwork in each case.—"Values of certain infinite products, with an application to the summation of the geometrical series of the  $n$ th order as a definite integral," by Mr. J. W. L. Glaisher, F.R.S.—"On the form of cam which, acting on a lever, shall communicate a motion such that the angular velocity ratio of the lever and cam is a given function of the angle described by the latter," by Major J. R. Campbell.

Geological Society, Nov. 3.—Mr. John Evans, V.P.R.S., president, in the chair.—Mr. Thomas Andrew, 18, Southemhay, Exeter; Mr. Harry M. Becher, White Lodge, Barnes, S.W.; Mr. Arthur Back Kitchener, F.C.S., 19, Buckingham Street, Strand, W.C.; Mr. Daniel Morris, Grammar School, Burnley; Mr. Christopher Thomas Richardson, M.D., 13, Nelson Crescent, Ramsgate; and Mr. Gustavus A. H. Thureau, Lecturer on Geology and Practical Mining, School of Mines, Sandhurst, Victoria, were elected Fellows of the Society.—On some new Macrurous Crustacea from the Kimmeridge Clay of the Sub-Wealden Boring, Sussex, and from Boulogne-sur-Mer, by Mr. Henry Woodward, F.R.S. The first species described by the author belonged to the fossiliferous family Thalassinidae, six species of which belonging to four genera are now found on the British coasts. The known fossil species are from the Chalk of Maestrich, the Greensand of Bohemia and Silesia, the Chalk of Bohemia, the Greensand of Colin Glen, near Belfast, and the Upper Marine Series of Hempstead, Isle of Wight. All these are referred to the genus *Callianassa*, which also includes the species from the Kimmeridge Clay described in this paper. The fossil is seen in profile on several sections of the core, and has the enlarged hands of the fore limbs more nearly equal in size than in the living species of *Callianassa*; the carapace and segments of the abdomen are smooth, and the latter are somewhat quadrate in profile, contracted at each extremity, and not pointed, and the caudal plates are oval. For this Crustacean the author proposes the name of *Callianassa isochela*. The second species described belongs to the genus *Mecochirus*, distinguished by the great length of the fore-limbs, which is equal to that of the whole body, the oldest known species of which (*M. olifex*, Quenst.) is from the Lower Lias of Würtemberg. It was obtained, together with *Lingula ovalis*, from the Kimmeridge Clay of Boulogne, by Mr. J. E. H. Peyton, after whom the author proposes to name it *M. Peytoni*. In this species the fore-legs are very finely punctate, and measure seventy-five millims. in length. The rostrum is somewhat produced, and the carapace, which is finely granulated, measures thirty millims. in length. The antennæ are long and slender. The abdomen measures forty-five millims., and the epimeral borders of the segments are falcate. The species is intermediate in size between *M. socialis*,

Mey., and *M. Pearci*, M'Coy, which the author regards as distinct. He also refers to *M. Peytoni* a pair of fore-limbs obtained from the Sub-Wealden boring.—On a new Fossil Crab from the Tertiary of New Zealand, by Henry Woodward, F.R.S. In this paper the author described a crab obtained by Dr. Hector, F.R.S., Director of the Geological Survey of New Zealand, from the "Passage-beds" of the Otago series in Woodpecker Bay, Brighton, on the west coast of the south island of New Zealand. The new species belongs to the genus *Harpaocarrinus*, A. Milne-Edw., which includes six species from the Eocene of southern Europe. Its nearest ally is *H. quadrilobatus*, Desmar., but its carapace is much more tumid, especially in the brachial and gastric regions; the surface of the anterior half of the carapace is nearly smooth, and that of the posterior half finely granulated. The rostrum is short and very obtusely tricuspidate, the orbits shallow and rounded, the hepatic margin bluntly toothed, with a stronger tooth at the epi-brachial angles; the divisions of the regions of the carapace faintly indicated, and there is a slightly roughened line on the sides of the gastric intumescence. The characters of the jawfeet and of the chelæ are described by the author; of the latter the right is considerably larger than the left hand. The specimen was a female. For this species the author proposed the name of *Harpaocarrinus tumidus*. Dr. Hector explained the sequence of formations in the locality from which the above crab was derived, and stated that the Otago series is to be regarded as Cretaceous-Tertiary, containing some fossils of decidedly Cretaceous type, such as Saurian bones and fragmentary *Inocerami*, and other forms that are associated with decidedly Mesozoic fossils in the underlying strata. On the other hand, the occurrence of Tertiary forms such as *Nautilus sicca* (or a nearly allied form), the gigantic Penguin (*Palæudyptes antarcticus*, Huxl.), and a Turtle, indicate a fauna not unlike that at present existing in the vicinity.—On a remarkable fossil Orthopterous Insect from the Coal-measures of Britain, by Mr. Henry Woodward, F.R.S. The author commenced by indicating the importance of the examination of the Clay-ironstone nodules of the Coal-measures, in which so many valuable fossils have been discovered, including the remarkable insect described in the present paper. The specimen displays the characters of the four wings, only two of which, however, are nearly perfect, and these measure  $2\frac{1}{2}$  inches in length and 1 inch and  $1\frac{1}{4}$  inch in breadth, the hind wing being the broadest. The author described in detail the characters presented by the venation of the wings, which includes three straight veins running parallel to the fore margin, the third bifurcating near the apex, a fourth much curved vein giving origin to six branches, and having at its base a triangular space, from which arise the other veins of the wing. The body appears to have been about five lines broad between the bases of the wings. In front of the wings is the prothorax in the form of two large, rounded, dilated, and veined lobes; it measures fourteen lines across and six lines in length. In front of these lobes is the head, with its eyes produced in front into a slender process three lines long. This insect is considered by the author to be most nearly related to the Mantideæ, the characters of the head and thorax especially being to some extent paralleled in the existing genus *Blepharis*. The author proposed to name the species *Lithomantis carbonarius*, and suggested that *Gryllacris (Corydalis) brongniarti* probably belongs to the same genus.—On the discovery of a Fossil Scorpion in the English Coal-measures, by Mr. H. Woodward, F.R.S. The author commenced by noticing the various European and American localities in which fossil Arachnida have been found in the Coal-measures. Hitherto no true Scorpions have been recorded from the English Coal-measures; but in 1874 the author received from Dr. D. R. Rankin a specimen from the Coal-measures near Carlisle, which he regarded as the fossil abdominal segment of a Scorpion; in April last he obtained a fossil Scorpion from the Sandwell Park Colliery, and in August Mr. E. Wilson forwarded to him several specimens of similar nature in Clay-ironstone nodules from Skegby New Colliery, near Mansfield. The specimens are all very imperfect, but the author states that they most closely resemble an Indian form, which is probably *Scorpio aser*. He refers the English species provisionally to the genus *Euscorpius*, Meek and Worthen, and proposes to name it *E. anglicus*.—The Drift of Devon and Cornwall, its origin, Correlation with that of the South-east of England, and place in the Glacial Series, by Mr. Thomas Belt, F.G.S. The author described the general characters of the drift in the district under consideration, and stated that on the uplands the drift consists of undisturbed gravels and travelled boulders, which occur only in isolated remnants on the lower ranges, and

that in the lowlands and valleys within 100 feet of the present level of the sea the gravels are widely spread, and show signs of sudden and tumultuous action. Between the upland and lowland gravels he considered that great denudation had taken place. He maintained that the boulders and the materials of the gravels had been distributed by floating ice, and that their presence on the summit of Dartmoor indicated that the water on which the ice floated must have extended up to 1,200 feet above the present sea-level; but he argued that this water was not that of the sea, because no old sea-beaches or remains of marine organisms are to be found in the region, although freshwater shells are preserved. He described these phenomena to the presence of a great freshwater lake, produced by the drainage of Europe being dammed back by a great glacier flowing from the north-west (Greenland) down the present bed of the Atlantic, and over the northern parts of the continent. The author discussed the characters of the superficial deposits in the southern and south-eastern counties, and indicated the points in which these seemed to bear out his hypothesis. The sequence of phenomena assumed by the author is as follows:—Accepting Mr. Tylor's notion that the actual sea-level must have been lowered during the Glacial period in consequence of the great accumulation of water in the form of ice at the poles, he seeks a point of departure at the Glacial period in the first evidence of such a lowering of the sea-level. The Weybourne sands and the marine beds of Portland Bill were deposited when the sea was at about its present level, and the Bridlington Crag probably belongs to the same period. The fossils found in these deposits show that the waters were cold. The first stage of the Glacial period is that of the older Forest-beds, and the immigration of a number of great Mammalia and of Palæolithic man indicates that the sea had retired from the British Channel and the German Ocean, leaving these islands connected with the Continent. A great river probably ran southwards through the region now submerged. The second stage is marked by the continued advance of the ice from the north, the retreat of the southern fauna and Palæolithic man, and the arrival of Arctic Mammals. The third stage saw the culmination of the Glacial period and the greatest extent of the Atlantic glacier, which reached to the coast of Europe, blocked up the English Channel, and caused the formation of an immense lake of freshwater by damming back the drainage of the whole of north-western Europe, as already indicated. In the fourth stage the Atlantic glacier began to retreat, and the sudden breaking away of the barrier of ice that blocked up the mouth of the Channel caused the tumultuous discharge of the waters of the great lake, by which the spreading of the lowland gravels was effected. To this cause the author attributes the formation of the Middle Glacial sands and gravels of Norfolk and Suffolk. During the fifth stage the ice of the German Ocean continued to retreat; but there was a temporary advance of the Atlantic glacier, which again blocked up the Channel, and produced a second great lake, which, however, did not attain so great a height as the first, and its waters were not discharged in the same tumultuous fashion. At this period the Upper Boulder-clay of Norfolk and Suffolk was formed; but the author is not convinced that this formation is represented south of the Thames except by the "Trail" of the Rev. O. Fisher. In the sixth and last stage the Atlantic ice retreated as far as the north of Scotland, but the sea had not returned to its former level. The British Isles were connected with the Continent and with each other. To this the author assigns the last great Forest period, and the arrival of Neolithic man and the associated fauna from the Continent.

Astronomical Society, Nov. 12.—Prof. Adams, president, in the chair.—A valuable series of solar photographs were presented to the Society by the executors of the late Prof. Selwyn. They represent a period of rather more than eleven years, and so cover a complete cycle of sunspot frequency. The negatives are upon glass and have been taken upon a scale of four inches to the sun's diameter. The casket in which the Freedom of the City of London had been presented to the Astronomer Royal was shown to the meeting, and Sir G. B. Airy gave an account of the work that had been going on at the Observatory during the recess. Attention has been paid to the positions of the satellites of Saturn in connection with the ephemerides, which have been published by Mr. Marth in the *Monthly Notices* and *Astronomische Nachrichten*. A new eight-year Greenwich catalogue of stars is being published. Stella-spectroscopy has also been energetically followed up, and though the observations were at first somewhat discordant, latterly they have grown more consistent,

and the results which have been obtained in the main verify those of Mr. Huggins as to the approach and recession of stars from and towards us in the line of sight. The Astronomer Royal remarked that Mr. Huggins had in this direction had the privilege of starting a new science, and it would be their duty at the Observatory to revise it; they intended to follow up the matter still further, but there were great difficulties still to be overcome, difficulties which no one could appreciate who had not attempted delicate work of the kind. They had also at the Observatory been applying themselves to photography, and had taken negatives of the sun with considerable regularity, though there were fewer spots to be observed now than at any former period which he could remember. Sir G. B. Airy also laid before the Society a map of the stars in the neighbourhood of Mars during its next opposition in 1877, and drew attention to the great advantages which this opposition would offer for the determination of the solar parallax.—Mr. De la Rue gave an account of the preparations that are being made both in France and Austria for the cultivation of physical astronomy. At Vienna an observatory is in the course of erection outside the city, on an area of some fifteen or seventeen acres. A central dome is being erected of 42 feet in diameter, which is to hold a 27-inch refractor, by Grubb, of Dublin.—Prof. Pritchard gave an account of the new Physical Observatory at Oxford, and of the mounting of the 12½ inch refractor by Grubb, which has recently been bought by the University.—Lord Lindsay read a note on the progress of the reduction of his observations of the transit of Venus; and Mr. Bidder exhibited at the meeting and described an observing chair of simple and inexpensive construction.

**Physical Society, Nov. 13.**—Prof. Gladstone, F.R.S., president, in the chair.—The President stated that since the last meeting of the Society, Prof. Everett's important work on the Centimetre-Gramme-Second System of Units had been published by the Society. The book is based on the recommendations of a committee of the British Association, and consists of a collection of physical data concisely presented on the above system, a complete account being added of the theory of units.—Dr. Stone then read a paper on Thermopiles. He has recently been engaged in some experiments with a view to ascertain the best alloy for use in thermopiles. The thermo-electric power of a metal or alloy appears to be quite unconnected with its power for conducting heat or electricity, or with its voltaic relation to other metals, neither does it appear to have any relation to specific gravities or atomic weights. The thermopiles employed were of a form slightly modified from that employed by Pouillet in his demonstration of Ohm's law. Alloys are frequently more powerful than elementary metals, thus: 2 parts antimony and 1 part zinc have a negative power represented by 22·70, while that of antimony is 6·96 or 9·43, and of zinc is 0·2. A strange exception, however, is that of bismuth and tin, for while the power of bismuth is + 35·8, when the two metals are alloyed in the proportion of 12 to 1, the power becomes — 13·67. Dr. Stone first used a couple consisting of iron and rich German silver (that is, rich in nickel). This was characterised by great steadiness, but the electromotive force produced by moderate differences of temperature was not great. He then used Marcus's negative alloy, consisting of 12 parts antimony, 5 of zinc, and 1 of bismuth, but the crystalline nature and consequent brittleness of this mixture were found to be great objections to its practical use. It occurred to Dr. Stone that the addition of arsenic might diminish the brittleness without injuring the thermo-electric power, and on trial it was found that an alloy of zinc, antimony, and arsenic, with a little tin, formed a much less brittle mass than Marcus metal, with quite as great or greater thermo-electric power. A set of twelve couples of this alloy and German silver was exhibited. The electromotive forces of this set and of a similar one of twelve iron and German silver couples were determined by Mr. W. J. Wilson, and found to be, for one alloy and German silver couple with difference of temperature of 80° C.,  $1\frac{1}{3}$  of a Daniell's cell. The electromotive force of one couple of the iron and German silver set was  $\frac{1}{4}$  of a Daniell's cell. The ordinary method of applying heat by a trough of hot water is objectionable, for the water short-circuits some of the current. This is evident from the fact that if oil heated to the same temperature be substituted, a considerably greater deflection is obtained. Another method suggested by the author, which would tend to economy, is to allow petroleum to volatilise in the neighbourhood of one face of the pile, thus chilling it, and to ignite the mixture of air and gas so produced at the other face. Clamond's pile, consisting of iron and an

alloy of zinc and antimony, was employed for some time, but although good results were obtained, the iron is liable to rust at the connections.—Dr. Guthrie remarked that in researches of this nature the main object in view was to ascertain what relation, if any, existed between the direction of the current and the amount of heat-flow. He referred to the experiment with a tangle of fine platinum wire, by which it is found that if either end of the wire be heated, a current flows towards the tangle, and this takes place however well the tangle may be annealed. Dr. Guthrie suggested that the great effect which alloying one metal slightly with another has on its position in the thermo-electric series may perhaps be connected with its change in conducting power for heat.—Mr. Walenn referred to experiments which he made some years since on thermopiles when used at high temperatures. The most powerful currents were obtained with a couple in which amalgamated copper was employed, but the power was soon lost in consequence of the volatilisation of the mercury. Subsequently he employed wires of wrought iron and German silver, and although the results were not specially remarkable at moderately high temperatures, the power became great when the connections were raised to a red heat.—Prof. Foster called attention to Matthiessen's table of the electric conductivities of metals and alloys in relation to the use of the latter in thermopiles. The fact shown by Matthiessen that the conductivities of alloys are greatly influenced by changes of temperature, will probably, he considers, be found to have some connection with their thermo-electric action. He also mentioned, as a fact which should be remembered when considering the construction of thermopiles, that the presence of minute traces of impurity completely changes the electric conductivity of a metal.

**Anthropological Institute, Nov. 9.**—Col. A. Lane-Fox, president, in the chair.—Major T. F. Wisden was elected a member.—Mr. Francis Galton, F.R.S., read the following papers:—"Heredity in Twins." On comparing the number of twins found among the uncles and aunts of twins with those found in similar classes of society generally, it appears that twin-bearing is hereditary, in so far that there is an excess per cent. of three individuals of twin birth in the former group. It further appears that the male and female lines contribute the twin-bearing tendency in identical proportions. The families are very large in which twins are born; even those of their parents average nearly seven persons, but the twins themselves appear neither to marry so frequently nor to be so prolific as other persons. However, the common belief that both twins are in no case fertile is quite untrue.—"A Theory of Heredity." Starting with the generally admitted view that the body consists of a multitude of organic units, each of which is to a certain degree independent of the rest, and with certain postulates which that view implicitly recognises, there exists a firm basis on which to establish a theory of heredity. By these and their necessary consequences, the object of double parentage, and therefore of sex, was first explained by the likeness and dissimilarities observed between brothers and sisters, and the still more remarkable similarities and contrasts between twins of the same sex, were then accounted for. It was argued that the germs which were selected for development into the bodily structure had very small influence in an hereditary point of view, but it was those germs that were never developed but remained latent, that were the real origin of the sexual element; by this hypothesis the almost complete non-transmission of acquired modification was explained; also the occasional fact that strongly marked characteristics in the parents were sometimes barely transmissible, and again that of certain diseases skipping alternate generations. It was further supposed, in the successive segregations and segmentations of the earliest germinal matter, that the divisions were never precise, and therefore that alien germs were ultimately included in each structure; thus latent germs of all kinds became distributed over all parts of the body. This accounted for much that Mr. Darwin's theory of Pangenesis over-accounted for, and was free from objections raised against the latter. The assumed evidence that structural changes under modified conditions of life reacted on the sexual elements was then discussed, and it was pointed out that much that had the appearance of heredity was not so in fact, but was due to changes of the sexual elements collaterally with the structural ones. A modification of Pangenesis was adopted, as a subsidiary part of the main theory, to account for the occasional and limited transmission of acquired modification. The precise character of the relationship that connects the offspring with the parents was then defined.—Mr. F. W. Rudler, F.G.S., read a report on the Department of Anthropology at the Bristol meeting of the British Association.

Institution of Civil Engineers, Nov. 9.—Mr. Thos. E. Harrison, president, in the chair.—The paper read was on the Manora Breakwater, Kurrachee, by Mr. William Henry Price.

## CAMBRIDGE

Philosophical Society, Nov. 1.—Mr. Pearson read a paper on Aristotle's notion of "Right-Handedness;" and added some remarks on a theory of his own on the subject.

## BOSTON

Natural History Society, May 5.—This was the Annual Meeting, when Prof. Hyatt, the Custodian, presented his report, in which he described the condition of the numerous collections belonging to the Society. The following papers were read:—On some of the habits of the Blind Crawfish (*Cambarus pellucidus*), and the reproduction of lost parts, by F. W. Putnam.—Synopsis of the Odonata of America, by Dr. H. A. Hagen.

## PARIS

Academy of Sciences, Nov. 8.—M. Frémy in the chair. The following papers were read:—Discovery of two small new planets, at the Observatory of Paris, by MM. Paul and Prosper Henry, by M. Leverrier.—Memoir on measurement of the affinities in the reaction of two solutions on one another, taking as bases the electromotive forces, by M. Becquerel.—On the alcohols which accompany vinic alcohol, by M. Is. Pierre.—On the exhaustion of the soil by apple-trees, by M. Is. Pierre. He estimates that an annual supply of about 80 kilogrammes of manure would be required for a single tree, to maintain the original fertility of the ground.—Observations by M. P. Thenard on M. Pierre's communication.—M. de Lesseps presented the second volume of his work on the History of the Suez Canal.—On the separation of mixed liquids and on new maximum and minimum thermometers, by M. Duclaux. It is always possible to begin with a mixture (at a given temperature) such that on lowering the temperature very little (much less than the tenth of a degree), it divides into two layers of equal volume; e.g. a mixture of 15 c.c. amylic alcohol, 20 c.c. ordinary alcohol, and 32.9 c.c. water, at 20°. The thermometers on this principle are easily made, cheap, solid, and resistant to shocks and pressure, though, of course, a special mixture is required for each.—Note on the determination of caffeine, and the solubility of this substance, by M. Commaille.—On a process for separating cholesterol from fatty matters, by M. Commaille.—On the various modes of structure of eruptive rocks, studied with the microscope, by M. Michel Levy.—Researches on the inversion of cane-sugar by acids and salts, by M. Henry.—Comparison of anipolar excitations of the same sign, positive or negative: influence of increase of the current on the value of these excitations, by M. Chauveau. In medical use of electricity, he finds that to manage the current with regularity, unipolar excitation should be used with the positive pole for motor, and with the negative for sensitive, nerves.—On the anatomy and histology of *Lucernaria*, by M. de Korstneff.—Treatment, with sulpho-carbonates, of the spot which indicated the appearance of *Phylloxera* at Villié-Morgon, by M. Duclaux.—On electro-capillary currents produced by mineral caustics, by M. Onimus.—On the influence of acids on coagulation of blood, by M. Oré. Neither acids nor alcohol coagulate albumen when injected directly into the circulation; and most substances insoluble in water, but which cease to be so in presence of acids and of alcohol, may be injected without causing coagulation, after being submitted to the action of these.

## GENEVA

Society of Physics and Natural History, Oct. 7.—Prof. Alfred Gautier gave an account of the meteorological observations made in Labrador by the Moravian missionaries at various stations in that northern region. The first notice, published by him in June 1870 (*Archives des Sciences*, tome xxxviii. p. 132), referred to the first documents of that kind sent by the missionaries from 1778 to 1780, and published in the *Phil. Trans.*, vols. 69 and 71; then a second series, made from 1841 to 1843, contained in the *Annales* of M. Lamont, of Munich. A new series of observations has been undertaken since 1867, by means of thermometers sent from Geneva by M. Gautier, and it has been continued more or less regularly by the missionaries. Results have been received from four stations; that of Hopedale, from 1868 to 1874; Zoar, for one year, from Sept. 1870 to Sept. 1871; that of Hebron, from Sept. 1869 to August 1870; Rama, the most northerly, from July 1872 to June 1874. Hopedale is situated in 55° 39' N. lat. The annual means of temperature in

Centigrade degrees, drawn from three observations daily, made at 7 A.M., 12 noon, and 7 P.M., are as follows:—

December, 1868	to November 1869	— 3° 04
" 1869	" "	1870 — 3° 42
" 1870	" "	1871 — 2° 83
" 1871	" "	1872 — 2° 32
" 1872	" "	1873 — 3° 63

The mean of five years is thus — 3° 09. Compared with the mean of Edinburgh (in an even more northerly lat., 55° 57', which is about 8° 4', it indicates the enormous difference existing between the temperatures of corresponding latitudes on the western coast and in the eastern regions of the North Atlantic. The mean of the seasons at Hopedale deduced from the collective observations is as follows: Winter, — 18° 0; spring, — 5° 5; summer, 9° 0; autumn, 1° 3. The minimum temperature in winter is from — 26° to — 36° below zero. The absolute minimum observed have been — 38° on Feb. 3, 1870, and — 39° on Feb. 2, 1873; on March 1, 1874, — 35° was observed. In July and August there was not much frost, and vegetation prospered. The thermometer rose to 29° and even 30°, which was reached on July 26, 1871. The daily variations resulting from five years' observations rose in the mean to 4° 49. Its monthly maximum was 6° 6 in June 1873, and its minimum 1° 2 in November 1869. It is accidentally sometimes much more considerable. The most notable instance was on Oct. 11, 1871, when the thermometer, which indicated — 4° 2 at 7 A.M., sank at 7 P.M. to — 27°. The barometric observations made at Hopedale present inconsiderable variations. In the neighbouring districts these variations being often very sudden and very extended, it may be asked if the instruments used are in a satisfactory condition. Since the heights reached vary between 29 and 304 English inches, it may be presumed that the tube is quite free from air? This is a point deserving a special inquiry. From the three daily observations made at the station of Zoar from September 1870 to August 1871, may be deduced a mean annual temperature of — 2° 26. Zoar is situated in about 56° of N. lat. At Hebron two daily observations at 7 A.M. and 2 P.M. during one year, from September 1869 to August 1870, give a mean of — 3° 6. The latitude is about 58° 20'. The two previous years gave an annual mean of — 4° 5, and besides former observations in 1841–2, a mean of — 5° 3. Finally, at Rama, situated in about 60° N. lat., the annual mean in 1872–3 was about — 5° 6.

## BOOKS AND PAMPHLETS RECEIVED

BRITISH.—Bamboo considered as a Paper-making Material: T. Roudledge (Spou).—Four Thousand Miles of African Travel: Alvan S. Southworth (Low and Marston).—Artes Africanæ: Dr. G. Schweinfurth (Low and Marston).—Journal of the Royal Agricultural Society of England. Vol. ii. Part 2 (Murray).—Notes on Forestry: C. F. Amery (Trübner).—Tenth Annual Report of the Quekett Microscopic Club.—The White Conquest: William Hepworth Dixon (Chatto and Windus).—The Potton and Wicken Phosphatic Deposits: J. J. Harris Teall, B.A., F.G.S. (Deighton, Bell, and Co.).—The Nature of Light, with a general account of Physical Optics: Dr. Eugene Lommel (H. S. King).—Science Lectures for the People, delivered in Manchester. 1st and 2nd, 3rd and 4th, 5th and 6th series (Manchester, John Heywood).—Theory of Heat: J. Clerk-Maxwell, M.A., LL.D. (Longmans).—Papers on Glacial Geology: T. Mellard Reade, C.E., F.C.S. (Liverpool Geological Society).

## CONTENTS

	PAGE
MR. GLADSTONE AT GREENWICH . . . . .	41
CHAMBERS'S ENCYCLOPEDIA . . . . .	42
EGYPT AND THE NILE . . . . .	43
OUR BOOK SHELF:—	
Routledge's "Discoveries and Inventions of the Nineteenth Century"	45
LETTERS TO THE EDITOR:—	
Scientific Research for the Promotion of Science.—Prof. PIAZZI	
SMITH . . . . .	45
Ericsson's Researches on the Sun.—P. A. SECCHI . . . . .	46
Sir G. B. Airy and the National Standards.—Sir G. B. AIRY, F.R.S.	47
The Origin of Our Numerals.—JOHN ALLAN BROWN . . . . .	47
On the Cup-shaped Joints in Prismatic Basalt.—G. P. SCROPE, F.R.S. . . . .	47
A New Palmistry.—R. A. FAYOR . . . . .	47
OUR ASTRONOMICAL COLUMN:—	
The Minor Planets . . . . .	48
SCIENCE TEACHING TO YOUNG CHILDREN. By Rev. G. HERBERT WEST . . . . .	47
THE THEORY OF "STREAM LINES" IN RELATION TO THE RESISTANCE OF SHIPS. By WM. FROUDE, F.R.S. (With Illustrations) . . . . .	50
NOTES . . . . .	52
THIRD REPORT OF THE SETTLE CAVE COMMITTEE (VICTORIA CAVE). By R. H. TIDDEMAN, F.G.S. . . . .	55
GERMAN SCIENTIFIC AND MEDICAL ASSOCIATION. By Dr. A. OFFENHEIM . . . . .	56
SOCIETIES AND ACADEMIES . . . . .	57
BOOKS AND PAMPHLETS RECEIVED . . . . .	60



THURSDAY, NOVEMBER 25, 1875

## THE OXFORD BOTANIC GARDEN

EVERYONE who knows Oxford remembers the quaint old Botanic Garden by Magdalen Bridge at the foot of the High Street. Nearly two centuries and a half have passed since St. James's Day, 1632, when the Vice-Chancellor and the authorities of the University walked in procession from St. Mary's Church to lay the foundation of the main gateway afterwards completed by Inigo Jones. The expense of this and of the high stone walls which surround the garden and protect it from the wind exceeded 5,000*l.*, a large sum even in those days, but which was provided by the munificence of Lord Danby, who afterwards bequeathed some property as an endowment.

The Oxford Botanic Garden is the oldest in Britain, and there are but two or three of earlier date in other countries. The space of this article would be insufficient to do justice to the place which belongs to it and to its successive professors in English scientific history. A few only of its traditions will be enough to show that it has always been a place for study as well as for instruction. Evelyn visited it in 1654, when "the sensitive plant was shown as a great wonder." Twenty years after (1676) Sir Thomas Millington, the Savilian Professor, first divined the fundamental fact of sexual reproduction in flowering plants. Five years later (1681) Bobart, "overseer of the physick gardens," experimentally demonstrated the function of pollen. At the beginning of the eighteenth century the Oxford Botanic Garden solved another great problem. Although Ferns bear no flowers, the world shared the opinion of Columna that they must have flower-produced seeds, because, amongst other reasons, "the book of Genesis said nothing about plants being destitute of them." Fern seed then came to be regarded as existent although invisible, and then by a not unusual transition as the cause of invisibility in its possessors. Morison (1715) disposed of these fancies by demonstrating that the asexual spores of Ferns were actually their means of reproduction. In 1736 the garden—then under the charge of Dillenius, the editor of the third edition of Ray's "Synopsis," and the author of the "Historia Muscorum"—was visited by Linnæus. Here he resided for some weeks, and many particulars have come down to us of discussions amongst the living plants, in which he endeavoured to convert Dillenius to his newly published Sexual System. Passing over Sibthorp and his splendid work on the Botany of Greece, it must not be forgotten that in the Oxford Botanic Garden Daubeny anticipated Draper in demonstrating (1836) that the light belonging to the red end of the spectrum is most effectual in promoting the evolution of oxygen by plants. There is something perhaps characteristic of the habits of forty years ago in his using port wine as one of his absorptive media.

It might be supposed that a place so venerable in its aspect, so interesting in its traditions, would be a source of some pride to the members of an ancient University, and that they would be anxious to give it the needful support to enable it to be as useful now as it has been in the past. Unhappily, the facts show the reverse of this.

Notwithstanding the efforts of the present professor, the garden and its buildings have been for some time allowed by the University to sink into neglect, and it is now proposed—mainly at the instance of the Regius Professor of Medicine—to abandon the site altogether and create a new garden in the modern suburb of Oxford and in the vicinity of the New Museum.

It will, of course, be assumed by all who are unacquainted with the real state of the case that the present site is quite unfitted for its purpose; yet there is the very highest authority in such matters for saying that the facts are all the other way, and the Professor of Botany strongly opposes the removal. Soil and situation are all that can be desired, and far better than can be obtained in the "Parks," where the soil is poor and the ground is wind-swept. A moderate outlay compared with that which removal would entail would make the present garden an all but ideal establishment for the prosecution of every branch of modern botanical research, while, if half a mile distant from the professorial suburb, it is on the other hand ready of access to most of the colleges, where undergraduates reside.

The argument used in favour of the removal is the advisability of bringing together all the scientific institutions of the University. In pursuance of this policy an astronomical observatory has also been built in the Parks at considerable cost, although Oxford already possessed in the Radcliffe Observatory an institution of this kind. If it were profitable for students to rush in hot haste from astronomical instruction to the lectures of the Botany Professor, such a juxtaposition might be desirable. But this sort of omnivorous study is a thing to be discouraged. In the present state of science an hour now and again spent in a professor's lecture-room is of the slenderest value. Oral teaching must be supplemented by workroom study, and if Botany in its modern aspects is to be effectively studied in Oxford at all, students must be encouraged to give to it considerable portions of whole days rather than a mere sporadic attendance. This demand for centralisation does not make itself felt in the other studies of the University, and as regards proximity to the Radcliffe Library, the Botanic Garden already has a fair library of its own.

If the truth must be spoken, this unhappy scheme is one more phase of the feverish æsthetic activity which in modern Oxford seems to have taken the place of enthusiasm for learning. This is not the place to criticise the New Museum erected at vast cost for the scientific studies of the University, but we may challenge any impartial man of science to stand before that fanciful building, half municipal, half monastic in its aspect, and fail to see that it bears the impress of the fleeting artistic aspirations of a period rather than of the sober needs of scientific study. The same impulse which in building a laboratory must needs reproduce the abbot's kitchen at Glastonbury will now, if it have its swing, transform a botanic garden into a pleasure ground, in which the needs of study must once more be subordinated to artistic effect, and conservatories will be built not so much to grow plants as to show how such things can be constructed in the neo-Gothic manner. Forming part of the "Parks," and contiguous to a suburb of villa residences, it will immediately become a pleasant lounge, and the mem-

bers of the University will of course not be satisfied unless the time of the gardeners is pretty fully occupied with decorative floriculture. Comparing such a prospect with the old Garden, one turns to a place whose trim extent is ample for purposes of study, whose old-fashioned aspect is pleasing to the eye without much need of "bedding out," and which is supplied with substantial buildings well adapted for library, herbarium, laboratory, and museum, or which might be made so at comparatively little expense. It is true that the greenhouses are dilapidated and antiquated, but they could be reconstructed against one of the old walls, and this at a much less cost than they could be erected in the "Parks."

The hammer and the chisel resound throughout Oxford. The great court of Christ Church is to be surrounded with useless cloisters. The University Church, having been restored thirty years ago, is to be re-restored in a more critical manner. The beautiful old library of the Bodleian is in no small peril. The secret of all this is easy to read. A new distribution of the funds of the University and colleges is believed to be imminent. From one point of view it is desirable that these should be husbanded to the last penny, in order that new endowments for study and research may be adequate and comprehensive. From the other point of view it is only desired at Oxford *stare supra antiquas vias*, and the money must be got rid of before the time of redistribution arrives. Oxford, alas!—and those who regard her most lament it most—has grown careless that her life should pulsate with the life outside her. What new word in science ever now resounds from Oxford laboratories? Her energies seem lulled in the lethargy of a fastidious, almost feminine, culture. Her professors cannot be denied the possession of capacity and laboriousness, yet if perchance any new teacher is summoned from without to join their number, his friends lament him as one who has fallen away into an intellectual Capua.

To examine is the crown as to be examined is the commencement of an Oxford career. And those who are content that this should be the University's "measure of sufficiency" are only careful that buildings and appliances ancillary to examinations and studies preparatory for them should be after the newest fashion in taste and fitted to excite the admiration of relatives who visit Oxford at Commemoration-time. No one doubts that examinations are useful, and in Oxford, at least, no one will deny that Mr. Ruskin has not written on architecture in vain. But Oxford will not satisfy the hopes of those who look to its treasures for things new as well as things old, till she has learnt to look upon examinations as by no means a sufficient *raison d'être*, and the wisdom of spending as little as possible upon the decoration, and as much as possible upon the efficient equipment of her workrooms and laboratories.

#### LOMMEL ON LIGHT

*The Nature of Light, with a General Account of Physical Optics.* By Dr. Eugene Lommel, Professor of Physics in the University of Erlangen. (London: H. S. King and Co., 1875.)

THIS book forms the nineteenth volume of the International Scientific Series. Nearly all the volumes have passed through more than one edition, and with few

exceptions the works are of singular merit. They are, moreover, issued at so low a price that they cannot fail to have largely extended an interest in science and given the public a sound acquaintance with the special subjects upon which they treat. In the long list of the forthcoming volumes of the series, we are glad to find that some of the most eminent English and European men of science have consented to take a part.

In the present treatise, Prof. Lommel has given an admirable outline of the nature of Light and the laws of Optics. Unlike most other writers on this subject, the author has, we think wisely, postponed all reference to theories of the nature of the light until the laws of reflection, refraction, and absorption have been clearly set before the reader. Then in the fifteenth chapter Prof. Lommel discusses Fresnel's famous interference experiment, and leads the reader to see that the undulatory theory is the only conclusion that can be satisfactorily arrived at. A clear exposition is now given of Huyghens' theory, after which follow several chapters on the diffraction and polarisation of light-bearing waves. The reader is thus led onwards much in the same way as the science itself has unfolded, and this we think is the surest and best way of teaching natural knowledge.

Let us now look a little more closely at the book before us. It is evidently a translation, and as such the author's meaning must to some extent suffer, but on the whole the translator has done his work fairly well. We regret, however, to meet with some inaccuracies in the use of terms that ought not to have escaped revision. For example, on p. 228 we read: "The intensity (or energy) of light depends on the *liveliness* of the vibrations." The word *liveliness*, though used less objectionably in other parts of the book to express brilliancy, is here most likely to mislead the reader. For *liveliness* one may take to mean either extent and vigour or quickness of vibration; if the reader has the former meaning uppermost, he has of course gained a right conception, but if the latter, an erroneous idea is conveyed. The ambiguity of the word is fatal to its use in the passage we have quoted. Again, on p. 250 the word *fluids* is used when *liquids* should have been employed; the passage as it stands runs: "Glowing *fluids*, between the molecules of which the force of cohesion still acts, exhibit a continuous spectrum." This, of course, is not true of elastic fluids, as gases and vapours. The same error we notice also elsewhere, e.g. on p. 242. Again, on p. 261, the translator makes Prof. Lommel say: "When a telescope is used for the purpose of observing a diffraction image, *it* is formed in the focal plane of the objective." What is formed? Surely not the telescope. Throughout the chapters on diffraction the term "elementary rays and elementary waves" is incessantly used; the more familiar term, "secondary waves," is not employed; we think it would have been well to have helped the general reader by a reference to the latter expression in a footnote or otherwise.

So likewise we find the term "fasciculus of rays" everywhere employed, where it is common for us to use the term pencil or group; it would have been pleasanter to have varied the expression occasionally by the use of one or other of its synonyms. On p. 249, "consistence of the chord" hardly expresses with sufficient exactness the word "density" for which it is used. Freshness

of expression is welcome, but not at the expense of accuracy.

Then, again, we wonder what was the object of the translator in tacking on to many words their German equivalent; if the meaning were doubtful to him, or could not be rendered, that would be all very well; but when a plain man finds in the text the statement that

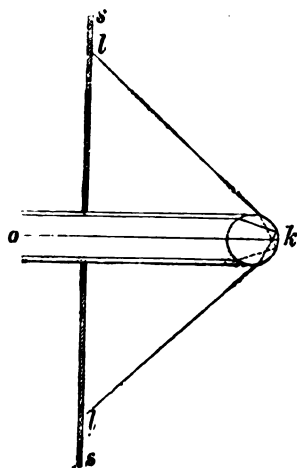

FIG. 1.—Refraction and internal reflection in a raindrop.

solid bodies are held together “by a powerful force which is termed the force of cohesion (Zusammenhangkraft),” he is apt to be a little frightened. The translator possibly felt that after the insignificance of our English term, it was necessary to give a powerful German word to express the powerful force. This, however, does not explain the occurrence of German expressions elsewhere in brackets.

These little defects are perhaps incidental to the first edition of a translation; of Prof. Lommel’s work we have already expressed our high opinion. The explanations of phenomena are extremely clear and precise, and here and there appendices furnish elementary mathematical reasonings which, though wholly omitted from the text, are desirable in some places to give the reader a more complete knowledge. The chapters in which the undu-

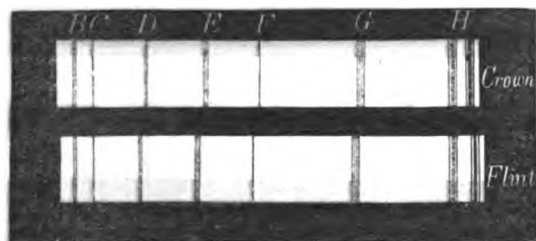

FIG. 2.—Spectra of crown and flint glass.

latory theory is employed to explain the phenomena of reflection, refraction, &c., seem to us extremely useful and clearly written. Nowhere, in an elementary book, have we met with so simple and elegant an explanation of the reason why the energy of a vibration is proportional to the square of its amplitude as that given by the author on pp. 227 and 228.

Here is a simple experiment to illustrate the formation of the rainbow, that we have not before seen in a text-book:—

“Upon a glass sphere *k*, filled with water and having a diameter of four centim. ( $1\frac{1}{2}$  in.), a beam of solar light of equal or greater diameter than the sphere is allowed to strike horizontally, and there is then seen, upon a large screen *ss*, placed in front of the sphere, and perforated in its centre to allow the passage of the incident rays, arranged concentrically to the aperture and at a distance from it which is nearly equal to that of the sphere from the screen, a beautifully coloured circle, in fact a circular spectrum, the colours of which are arranged concentrically, and in such a manner that the red is outside and the violet on the inside. At a still greater distance from the centre of the screen a second similar but much fainter circle is observed, the colours of which however succeeded one another in the inverse order, the red appearing on the inside, and the violet at the outer periphery.” (p. 122.)

The different dispersive power of bodies is instructively shown by comparing the spectra given by crown and flint glass (Fig. 2), wherein it is seen that although the total dispersion, that is the length of the spectrum, is exactly the same, the mode of dispersion is different. By the position of the Fraunhofer lines in the two spectra, “it is rendered evident that the less refrangible rays are more closely approximated in passing through the flint glass, whilst the more refrangible are separated further from one another than by the crown glass.” (p. 139.)

The difference in the nature of the dispersion is subsequently shown (chapter xviii.) to be caused by a difference in the rate of propagation of the various undulations when passing through many solids and liquids. Hence “the proposition that all kinds of

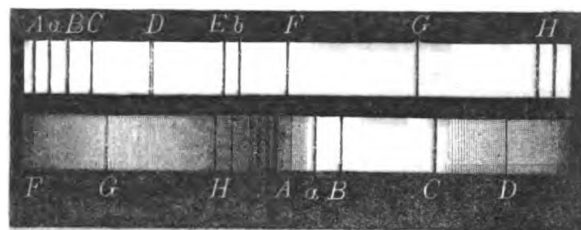

FIG. 3.—Unusual dispersive power of Fuchsin.

light are propagated with equal rapidity, which was shown to be true of the free ether of the universe, is found to be no longer admissible for the ether contained in the interior and occupying the interstices of the particles of natural substances.” Very strikingly is the influence of the nature of the material particles on the velocity of propagation exhibited in those substances in whose absorption spectra one or more very dark lines appear. “If we introduce, for example, an alcoholic solution of the aniline colour ‘fuchsin,’ into a hollow prism, and look through it at a brightly illuminated slit, we obtain a spectrum in which blue and violet are less deflected than yellow and red. What is elsewhere the end of the spectrum here appears at the commencement; towards the middle it fades, and in the centre the green, being absorbed, is absent (Fig. 3). From this behaviour the conclusion may be drawn that in ‘fuchsin’ the blue and violet rays are propagated with greater velocity than the red and yellow. This phenomenon, which was discovered by Christiansen, and was shown by Kundt to be presented by a great number of absorbing substances, has been called the *anomalous dispersion of light.*” (p. 244.)

The phenomena of absorption are treated very fully in this volume.

A pretty mode is given by the author on p. 177 of showing how the absorption bands yielded by a coloured body, gradually thicken, but are not displaced, when greater depths of colouring matter are used. "To demonstrate this a number of gelatine discs coloured with

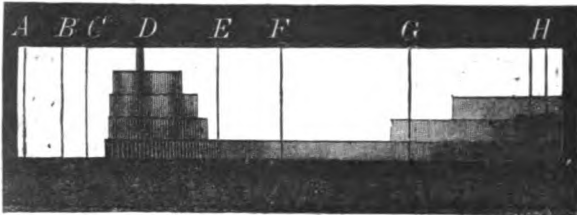

FIG. 4.—Absorption of colouring matter of litmus.

litmus may be used, which are placed between two colourless glass plates in a graduated manner. If these be placed before the slit, there will be seen in the aperture (Fig. 4) the graduated amount of absorption corresponding to the different thicknesses of the gelatine. In the case of the thinnest layer only a thick dark band is seen in front of D, whilst the thickest layer only permits the red end of the spectrum to be seen. The appearance of this spectrum explains why a layer of litmus gradually increasing in thickness first appears whitish, then blue, then violet, and finally purple red."

The next diagram (Fig. 5) represents the absorption

the violet end of the spectrum being cut out and two broad bands between D and E making their appearance; an alkaline solution of chlorophyll gives the absorption shown in 3; glass coloured blue by cobalt is shown in 4, and coloured red by oxide of copper in 5; solution of bichromate of potash is given in 6, and of ammoniacal oxide of copper in 7—these two are seen to transmit complementary colours, and hence their conjunction cuts off the entire spectrum. When the upper half of the screen is white and the lower half covered with red paper, the

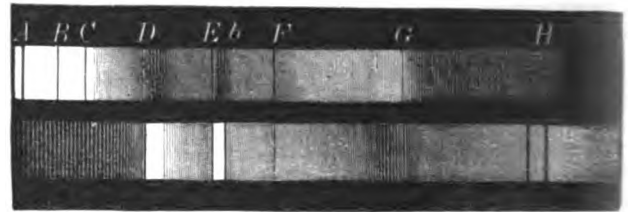

FIG. 6.—Absorption and fluorescing spectrum of naphthalin red.

effect shown in 9 is obtained. No. 8 shows the absorption lines produced by glass containing didymium in combination; to the eye such glass appears colourless, but the characteristic bands in the spectrum enable the faintest trace of that metal to be detected. Conversely by heating the oxide of didymium to incandescence, bright lines appear in the spectrum of the emitted light in the place of the dark lines. As is well known, the oxides of didymium and erbium are rare examples of glowing solids giving a linear and not a continuous spectrum.

Concerning the production of these bright lines, Prof. Lommel remarks further on (p. 250): "The vibrations which the molecules of solid and fluid [liquid] bodies exhibit under the influence of the force of cohesion, do not prevent the simultaneous occurrence of those vibrations within each molecule to which the molecule is attuned owing to its chemical composition. As a general rule the latter are not visible, because the bright lines which correspond to them disappear upon the bright background of the continuous spectrum. The characteristic linear spectrum which discloses to us the chemical quality of a body is much better and more clearly

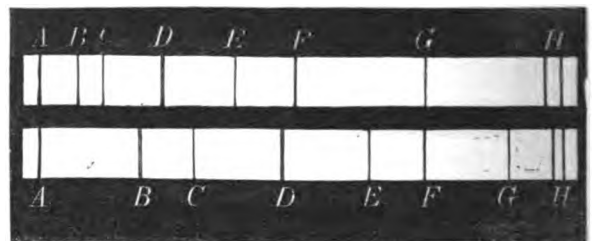

FIG. 7.—Comparison of prismatic with grating spectrum.

seen when its molecules, freed from the chains of cohesion, enter into the gaseous condition." We ought in fact to find the traces of its linear spectrum in a glowing liquid; if, for example, the metal sodium be heated to incandescence in nitrogen, the yellow portion of the spectrum should be more pronounced than the remaining regions; and if the glowing liquid metal could slowly pass into glowing gas, the extinction of the whole spectrum, except the characteristic D lines, should proceed imper-

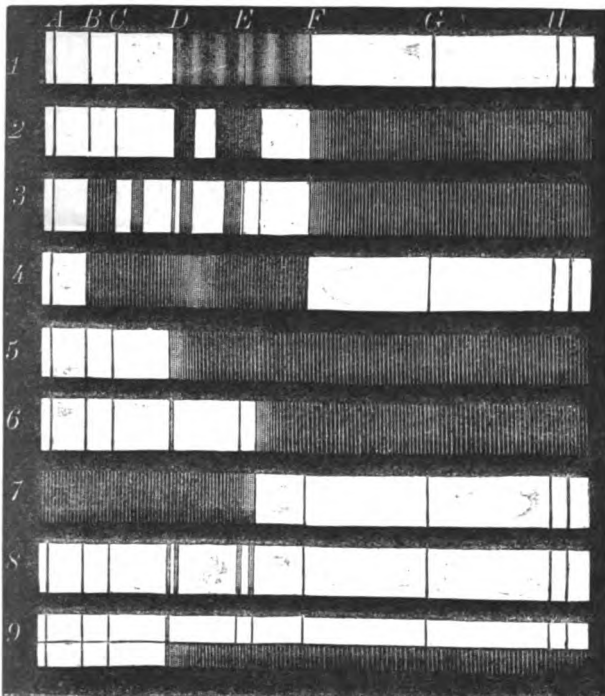

FIG. 5.—Absorption spectra.

spectra given by different bodies, the Fraunhofer lines being used as convenient standards of reference. The uppermost band, 1, is the spectrum as modified by transmission through a solution of permanganate of potash; the absorption by blood diluted with water is shown in 2,

ceptibly. From the law of continuity this must necessarily be the case in the transition of every solid into a gas, yet we are not aware of any definite experiments on this point.

The reciprocity of radiation and absorption is well illustrated by a comparison of the fluorescent and absorption spectrum of what the translator terms naphthalin red ; we presume rosaniline is meant. If the solar spectrum be projected upon a glass cell containing this liquid, the fluorescence exhibited in Fig. 6 (2) is seen. In the upper diagram is shown the absorption spectrum obtained by transmitting the solar spectrum through the same solution, and it will be clearer to the eye than it is in the diagram, that the three regions of strong fluorescence are in the same position as the three principal absorption bands. By employing a solution of proper strength, it will be found indeed that "every dark band in the absorption spectrum corresponds to a bright band in the fluorescing spectrum." (p. 190.)

The last diagram we give shows in an instructive manner the irrationality of the dispersion spectrum, by a comparison of the normal spectrum yielded by a diffraction grating with the ordinary prismatic spectrum (Fig. 7, 1). The last sentence in chap. 19, referring to this diagram, is badly translated, and certainly ought to be amended, for as it stands at present it is unintelligible.

We have said enough to show that Prof. Lommel's treatise is a useful contribution to the International Series, and is a book that can thoroughly be understood and enjoyed by any intelligent reader who may not have had any special scientific training. The familiar chromolithograph of different spectra which adorns the title-page of the volume has by this time lost its novelty and become wearisome. No book on chemistry, astronomy, or physics seems to be issued without it. Though the spectroscope is a wonderful and powerful instrument, yet the prominence of this subject is a little apt to throw equally valuable instruments into the background.

W. F. B.

#### DARWIN ON CLIMBING PLANTS

*The Movements and Habits of Climbing Plants.* By Chas. Darwin, M.A., F.R.S., &c. Second Edition, revised. With Illustrations. (London : J. Murray, 1875.)

THIS volume is a reprint of Mr. Darwin's well-known treatise on the habits of climbing plants, published in 1865 in the ninth volume of the "Journal of the Linnean Society," with such additions and corrections as the progress of knowledge since that time has rendered necessary. Although the subject had been investigated previously to that time by the German physiologists Palm and Von Mohl, it was Mr. Darwin's publication, describing many facts not previously recorded, that first introduced the remarkable phenomena connected with it to the notice of the general public. The phrase Climbing Plant is used by Mr. Darwin as a generic term for all those which, provided themselves with but weak stems that have no power of standing erect, avail themselves of the assistance of neighbouring plants for the purpose of raising their foliage and flowers to a considerable height from the ground. The plants included under

this head are arranged in four divisions, according to the part that is modified in order to subserve this purpose : (1) Twining Plants (called in the first edition Spiral Twiners), in which the stem is the climbing organ ; (2) Leaf-climbers, which climb by the aid of the petiole or some other portion of the leaf ; (3) Tendril-bearers, by far the most numerous class, which are provided with tendrils specially contrived for this purpose ; and (4) Hook and root-climbers, which climb by the aid of hooks on aerial roots, or merely scramble over other plants. In all these classes except the last, the mechanical means by which the climbing is effected is a sensitiveness and power of revolution possessed by the extremity of the stem or tendril, or by the petiole.

The origin of this peculiar power is one of the most interesting points of the inquiry. In some cases, as Passifloraceæ and Cucurbitaceæ, it is possessed by nearly or quite every species of the order ; other orders, as Leguminosæ, include species belonging to two or three divisions of climbers, along with a large number which do not possess the power ; while in others, as Compositæ, Rubiaceæ, Scrophulariaceæ, and Liliaceæ, it belongs to only a very few out of a large number of genera. From these facts, and the wide separation, on any system of natural classification, of the orders which contain climbing plants, Mr. Darwin draws the conclusion that "the capacity of revolving, on which most climbers depend, is inherent, though undeveloped, in almost every plant in the vegetable kingdom"—a conclusion which seems to us strongly confirmed by the fact that sensitiveness and a slight power of spontaneous motion are possessed by some parts of flowers where it is of no use for climbing purposes, as the flower-stalks of *Maurandia* and *Brassica Napus* ; and by the remarkable observation of Fritz Müller—one of the most interesting additional notes in the present volume—that "the stems, whilst young, of an *Alisma* and of a *Linum*," which do not climb, "are continually performing slight movements to all points of the compass, like those of climbing plants."

These observations lead Mr. Darwin to a discussion of the nature of the difference between the so-called "spontaneous" power of motion of some plants and that possessed by animals, which he sums up as follows :—

"It has often been vaguely asserted that plants are distinguished from animals by not having the power of movement. It should rather be said that plants acquire and display this power only when it is of some advantage to them ; this being of comparatively rare occurrence, as they are affixed to the ground, and food is brought to them by the air and rain."

In the present work Mr. Darwin makes ample reference to the light that has been thrown on the habits and movements of climbing plants by researches of a later date than the publication of the first edition, especially those carried out in the Würzburg Laboratory by De Vries and Sachs ; and one of the most important of the additions is a paragraph wherein he expresses his partial dissent on one point from the conclusions of the last-named high authority. In his "Text-book of Botany," Sachs attributes all the movements of tendrils to rapid growth on the side opposite to that which becomes concave ; these movements consisting of revolving nutation, the bending to and from the light and in opposition to gravity, those caused by touch, and spiral contraction. While

conceding this view with regard to all the other causes of movement, Mr. Darwin finds a difficulty in accepting it as regards movement caused by curvature from a touch, or what is ordinarily called sensitiveness. On this point he remarks that the movement of Revolving Nutation (Sachs's term for "the continuous self-bowing of a whole shoot successively to all points of the compass") differs from that due to touch, in so far that in some cases the two powers are acquired by the same tendril at different periods of growth; and the sensitive part of the tendril does not seem capable of nutation. A more important cause of hesitation is the extraordinary rapidity of the movement. Mr. Darwin has seen the extremity of a tendril of *Passiflora gracilis*, after being touched, distinctly bend in twenty-five seconds, and often in thirty seconds; and he doubts whether it is possible to believe in such rapidity of growth as would account for such movement. In reference to this we may simply remark that instances are on record of extraordinarily rapid growth—as in the case of the flower-stalk of *Vallisneria* to the extent of half an inch in an hour or more—even without any abnormal irritation.

The student will find in Mr. Darwin's work a *résumé* of everything known to the present date on this interesting and curious department of Vegetable Physiology.

#### OUR BOOK SHELF

*Report of the Meteorological Reporter of the Government of Bengal for 1874; and Administration Report of the Meteorological Reporter to the Government of Bengal for 1874-75.* By W. G. Willson, Officiating Meteorological Reporter. (Calcutta: Bengal Secretarial Press, 1875.)

THIS Report, drawn up by Mr. W. G. Willson, who has acted as officiating reporter during the absence of Mr. Blanford, keeps up the high character of the previous reports of this Office. It contains not merely the dry details which form an integrant part of such reports, but also an able discussion of them both in their practical and theoretical bearings. As regards new observations, the most important are those from Sibsagar, situated in the north-east of the Assam Valley. The large barometric oscillation from 10 A.M. to 4 P.M., which on the average of the twelve months of 1874 amounted to 0.133 inch, will indicate their high strictly meteorological value. The hourly observations of the different instruments made on four days of each month at a number of the stations are a valuable piece of work, and the discussion of the results three or four years hence will be looked forward to with much interest by meteorologists. An admirable feature of these reports are the averages, corrected up to date in all instances, which are given with the discussion of each meteorological element, thus affording the means of an immediate comparison of the monthly results with the best averages that can possibly be had. Of these averages and comparisons we would direct special attention to those of the rainfall, which is of so great importance in Indian meteorology. Rainfall averages for different periods were prepared during the past year for the information of the Government of India. These have since been further amplified and corrected, and the present report gives the average monthly and annual rainfall for 146 stations, and incomplete averages for some months for other twenty-three stations. An example of the practical application of the rainfall discussions of the Office is given in the report. A forecast of the rainfall was called for by the Government from the Office in the latter part of July 1874, when considerable

apprehensions were entertained regarding the prospects of the principal rice-crop of the year. A comparison of the peculiarities of the rainfall up to the end of July with those of past years, and the general similarity of the meteorological circumstances with those of 1872, induced Mr. Willson to submit the opinion that the rainfall in the latter months of the monsoon would turn out as favourable as in 1872, a forecast which fortunately was fully realised.

The inter-relations of the pressure, temperature, winds, and rainfall are particularly inquired into, and some of the results are of very high importance, of which those referring to the weather of January, April, May, and June may be specially referred to. From a careful examination of the observations, Mr. Willson infers that during the hot weather months there is an upper westerly current from the heated plains of Northern India blowing towards the cooler regions of Assam above the southerly winds of the delta; and that, if this be so, the vapour carried from the Bay of Bengal by the southerly winds in the hot weather months is mostly diffused upwards and thence transferred by the upper westerly current to Assam, where it descends, and, meeting the cold north-easterly surface winds, its vapour is precipitated in the copious rains which fall in Assam in this season. According to this view, the excessive rainfall of Assam in May 1874 is completely accounted for by the very unusual strength of the southerly sea winds over the delta in that month; by the abnormally low surface-pressure and high temperature over the plains of Northern India, and by the relatively high surface-pressure and low temperature over Assam. It will be seen that there is here indicated a further development of the important practical question of the prediction of the character of the coming season. As regards these and many other questions of meteorology, still more important observations and discussions may be looked for from the reports of the new Meteorological Department now being organised by Mr. Blanford for the whole of India, including British Burmah and the islands of the Bay.

#### LETTERS TO THE EDITOR

[The Editor does not hold himself responsible for opinions expressed by his correspondents. Neither can he undertake to return, or to correspond with the writers of, rejected manuscripts. No notice is taken of anonymous communications.]

##### Oceanic Circulation

I HAVE, at Prof. Thorpe's suggestion (vol. xii. p. 514), compared the results obtained by the use of Prof. Hubbard's Table of the expansion of sea-water with that obtained from Muncke's, and find them almost identical. Both give 2 feet 6 inches as the amount by which the expansion of Column B\* (lat. 23° N.) exceeds that of the Equatorial Column. Muncke's Table gives 3 feet 6 inches as the amount by which Column A (lat. 38° N.) exceeds that of the equatorial, while, according to Prof. Hubbard's Table, it is 3 feet 4 inches, being a difference of only 2 inches.

Dr. Carpenter objects† to my result on the ground that I have omitted the consideration of the inferior salinity of the equatorial column. Had I taken this into account, he thinks I would have found that it makes a difference in the opposite direction of about 1 foot in 1,026, which would more than neutralise the whole 3½ feet of slope derived from temperature. I do not know upon what grounds he believes that the difference in salinity is so great between the equatorial and Atlantic columns. Certainly the researches of the *Challenger* Expedition do not warrant any such conclusion. It is true that there is an excess of salinity in the surface-water of the North Atlantic, but it does not extend to any great depth. This superior salinity of the warm upper stratum of the North Atlantic, it may be observed, is an additional evidence that the water is of Gulf-stream origin.

\* Columns A, B, and C refer to Dr. Carpenter's section as given in my paper on the "Crucial Test" argument, read before the British Association at Bristol, and published in full in the *Philosophical Magazine* for September. A refers to North Atlantic column in lat. 38°, B to column in lat. 23°, and C to equatorial column.

† See NATURE, vol. xii. p. 533.



Through the kindness of the Hydrographer of the Admiralty, I have been favoured with all the observations made in the *Challenger* of the specific gravities of the Atlantic at intermediate depths between surface and bottom. From these observations it will be seen that there is scarcely any sensible difference between the mean specific gravity of the equatorial and the two Atlantic columns.

The following Table shows the mean specific gravities of the three columns :—

ATLANTIC.		EQUATORIAL.			
Depth in Fathoms.	I.	II.	Depth in Fathoms.	III.	IV.
	Lat. 38° 1' N. Long. 50° 10' W. Specific gravity at 60.	Lat. 20° 38' N. Long. 22° 57' W. Specific gravity at 60.		Lat. 1° 22' N. Long. 26° 36' W. Specific gravity at 60.	Lat. 3° 8' N. Long. 14° 49' W. Specific gravity at 60.
Surface	1.02684	1.02695	Surface	1.02616	1.02591
100	—	1.02738	50	1.02630	1.02658
150	1.02677	1.02658	90	1.02627	—
250	1.02641	1.02642	100	—	1.02643
400	—	1.02659	200	1.02607	1.02620
500	1.02608	1.02600	300	1.02618	1.02610
1500	1.02607	1.02620	400	—	1.02629
			1500	1.02618	1.02613
	1.026211 = mean of Column A.	1.02623 = mean of Column B.	Mean specific gravity of columns.	1.026181	1.026223
			Mean of the two.	1.026202 = Mean of Equatorial Column C.	

The mean specific gravity of the equatorial column as proved by the two soundings III. and IV. in the Table is 1.026202; and 1.026211 of sounding I. of the Table may be regarded as the mean specific gravity of the North Atlantic Column A, for the observations were made at a place on the same latitude, and only about two degrees to the east of that column. Consequently the specific gravity of Column A exceeds that of the equatorial by only .00009, a quantity which does not amount to one inch in 1,500 fathoms! Sounding No. II. of the Table, made at a place a few degrees to the east of Column B of the section, gives 1.02623, which may be regarded as the mean specific gravity of that column, and the more so as another sounding made in this region gives identically the same mean value. The difference between the Equatorial Column and Atlantic Column B in lat. 23° N. therefore amounts to only .000028, or 3 inches in 1,500 fathoms. It must of course be observed that as the specific gravities in the table are not taken at equal intervals the mean of the figures does not represent the mean specific gravity of a column. The number of fathoms represented by each separate value must be taken into account in determining the mean value of a column.

My result is, therefore, not materially affected, even after I have thus taken into account difference of salinity, and computed the amount of expansion according to Prof. Hubbard's Table. The surface of the North Atlantic in lat. 38° to be in static equilibrium must be 3 feet 3 inches above that of the equator, and in lat. 23°, 2 feet 3 inches above it.

It is perfectly true that according to the gravitation theory the ocean is never in a state of static equilibrium, but it must be observed that as the surface-flow according to this theory is from the equator polewards, it is the equatorial column that is kept constantly below the level necessary to static equilibrium; hence, were I to make allowance for want of static equilibrium, I should make the slope greater than 3 feet 6 inches. Dr. Carpenter's objection that the force of my argument rests on the assumption that the sea is in equilibrium is based on a misapprehension of the problem, for in reality, by not making allowance for want of equilibrium, I give his theory an advantage which it does not deserve. Were the surface-flow from the North Atlantic to the equator, there would then be some force in his objection, for by leaving out of account want of equilibrium I would be making the slope greater than it should be. Dr. Carpenter states that his objection met the approval of General Strachey

and Sir William Thomson at the British Association meeting. If it did, it shows that they must either have misapprehended my argument or his objection to it.

I have again to remind Dr. Carpenter that "viscosity" can have nothing to do with the question at issue. The water has to flow up the "gradient," and that by means of gravity. This is mechanically impossible, whether water be viscous or not.

It is needless to quote the opinions of Lenz, Arago, and Pouillet. They were not in possession of sufficient data to enable them to determine the question with certainty. The question, be it observed, is not "Can difference of temperature produce circulation?" Everyone will admit that there were no other agencies at work but equatorial heat and polar cold, a difference of temperature would soon arise which would induce and sustain a system of circulation; but this condition of things is prevented by the equatorial waters being swept away by the winds as rapidly as they are heated. I submit that I have proved that this is the case in reference to the Atlantic. If I am wrong, let it be shown where my error lies.

Edinburgh, Nov. 10

JAMES CROLL

Refraction of Light and Sound through the Atmosphere

THERE is in Upper Thibet a plateau called the "Kyan Chu Plain," on which phenomena of mirage are frequently seen. The plain is at a height varying from 15,000 to 16,000 feet. A cold wind comes down from the surrounding mountains, while an exceedingly hot sun heats the ground. While marching through this plain on Aug. 19 I saw the mirage in perfection. A mountain in front of us, at a distance of about five miles, appeared to be situated on the border of a lake of a deep and rich blue. A shepherd with a flock of sheep seemed to wade through the water, and the reflection of each sheep was most distinct and sharp. The effect was so complete that one of my companions proposed to leave the pool of water at the side of which we had encamped for breakfast, in order to go to the borders of the lake.

I measured the temperature of the air at various heights from the ground. The following readings were obtained :—

Height above ground.	Dry Bulb.	Wet Bulb.
5 feet ... ..	49° ... ..	32°
4 inches ... ..	55° ... ..	38°
1 inch ... ..	56° ... ..	39°

The ground at that place was stony, and no accurate measurement of its temperature could be taken. A few miles further on, however, a sandy ground was found to have a temperature of 90°.

The difference between the temperature of the ground and that of the air was painfully striking to me, as, owing to blisters, I had to walk with bare feet. My feet felt burning hot, while the remainder of the body was unpleasantly cold. The mirage was seen in its greatest perfection at about 9 o'clock A.M.

Such a condition of the atmosphere must, according to Prof. Reynolds, prevent any sound from being heard at a great distance, owing to its refraction upwards. Such was really the case. A rifle fired by the above-mentioned companion at a short distance remained almost unheard.

With regard to the question whether our better hearing at night is due to the absence of disturbing noises, or to the cause suggested by Prof. Reynolds, I wish to remark that the Upper Himalayas are particularly free from any disturbing noises, yet the increase in our power of hearing at night is most marked.

Sunnyside, Upper Avenue  
Road, N.W., Nov. 20

ARTHUR SCHUSTER

Evidences of Ancient Glacier Action in Central France

HAVING read with much interest Dr. Hooker's contribution to NATURE on "Evidences of Ancient Glaciers in Central France," I am tempted to send you a few remarks which may interest those who look out for glacial phenomena wherever they travel.

When travelling in Auvergne with Sir William Guise in 1866, we unfortunately missed the transported erratics in the Tranteine Valley, described by Dr. Hooker. We saw, however, examples of what we believed to be ice-borne erratics, on more than one occasion, and consulted M. Lecoq on the subject at his residence at Clermont Ferrand. He had observed travelled boulders in certain localities, but, as mentioned in the note-book of Sir William Guise, "attributed to transport by snow many of the effects generally assigned to glacial action."

I would also ask attention to a subject which appears to me of considerable interest with regard to the age of the most modern

of the lava currents of Auvergne. M. Lecoq had in his museum some fossil remains of the Marmot, the Mammoth, and the tichorhine Rhinoceros, and he distinctly told us that these relics of northern mammalia, which geologists are accustomed to associate with glacial times, were mostly found in cracks and fissures in the lava-streams near Clermont Ferrand. From this it would appear that the latest lava streams of Auvergne had become cold, consolidated, and fissured before the introduction of the bones and teeth of the northern quadrupeds into the fissures.

But if this prove to be true, on further investigation, I do not wish to imply that there have been no volcanic eruptions in Central France since the last outpour of lava currents, or the days of the Mammoth. On the contrary, I think the evidence is the other way. I have just returned from a visit to the extinct volcanos of the Haute Loire and the Ardèche, where I was accompanied by my friends Sir William Guise, Capt. Price, and Mr. Lucy; and I believe there is evidence of a certain amount of volcanic action in the Ardèche since the outpouring of the later lava-streams. There are outbursts of volcanic ash and scoriae which form what are termed "chimneys," and which are blown right through the most recent lava-currents. Both near Montpezat, so admirably depicted by Mr. Scrope, and near the bridge at La Beaume, there are outbursts and eruptions through the basalts, which dislocate and throw off the basaltic columns. It is not improbable that some of these attempts at forming a volcano happened in the Ardèche during the fifth century, when the Archbishop of Vienne, Alcimus Avitus, in his homily on the "Rogation Days," speaks of "frequent shocks of earthquakes," and "fires often blazing," and "piled up mounds of ashes." Gregory of Tours also speaks of stags and wolves wandering about Vienne. These wild animals may have been driven from the forests of the Ardèche, by these last volcanic eruptions, as far as Vienne.

W. S. SYMONDS

#### Communication of Information among Bees

SOME two or three years ago a swarm of bees entered a very small hole under the slates near the eaves of the roof of my house in the Highlands, and established themselves for the summer but died out in the subsequent winter. I infer that there were no survivors among the bees to remember the circumstance (see Appendix to Kirby and Spence's "Entomology") and to account in any degree for what occurred this summer.

The house is of four stories, and stands in the garden, in which, about fifty yards from the house, on the other side of a hedge, are my beehives. For a few days, during which there were the usual indications of swarming being imminent in one of the hives, a great many bees found their way into the lower rooms of the house; there was a constant hum of bees in one of the chimneys, at the top of which there was always a group flying about. The top of this chimney is about thirty feet horizontally from the settlement of the old swarm, and fifteen feet above it; there was also occasionally a cluster of bees on the roof of a "semi-detached" lower building (the kitchen) on the other side of the house from the old settlement, but as far as we saw no bees visited the old settlement, and nothing indicated any intention of the swarm to go there, though we expected it to make for the house and probably for the chimney I have mentioned. In due time the swarm came off and rose unusually high, and I immediately made some smoke in the chimney to prevent their entering it. Presently the swarm settled on a low apple-tree and was snugly hived in the usual way in a straw "skep" about noon. Next day, however, about 10 A.M., the swarm left its "skep" and made for the old settlement without any hesitation, and there they established themselves in spite of all we could do.

Of course the whole proceedings may have been disconnected, but the impression left on my mind was that the queen, or her counsellors, had previously "prospected," and resolved to go to the old settlement as an eligible "location," and that the common bees learned somehow that "the house" was to be their destination, but that some of them fancied the chimney, others the roof of the kitchen, and others wandered vaguely in at various open windows, while the queen knew exactly where she wanted to go, but got confused the first day.

The manner in which the bees learned that the house was to be their destination may have been that the queen in her investigations had left strong traces of herself at the chimney and on the roof of the kitchen, which attracted the bees to these places, and a general odour of royalty about the house which induced the bees to come in at the windows; but it may have been that there was some "talk" in the hive about it. In connection with

Sir John Lubbock's papers, the incidents may be worth your notice.

There has also been some question as to the distance bees go in search of "pasture." It may be worth noting that at Arisaig House, I am told, bees are to be found in the peach-house every spring at the time of the blossom, while, so far as I can learn, there are no hives within ten miles but my own, which are separated from it by an arm of the sea (Loch Ailort), a mile wide with islands, and a second arm of the sea (Loch-na-Nuadh), two miles wide without islands, the whole distance being about four miles from the hives to the peach-house.

University of Glasgow, Nov. 13

HUGH BLACKBURN

#### A New Palmistry

I HAVE lately consulted two standard works upon the proportions of the human figure to which Prof. Ecker does not refer in the suggestive paper of which I gave an abstract in NATURE (vol. xiii. p. 8), in the hope of finding some definite information as to the relative lengths of the "index" and "ring" fingers. In the first of these two works, Quetelet's "Anthropométrie" (Bruxelles, 1870), no mention whatever is made of the proportions of the several digits, whether of hand or of foot; while from the second authority, the "Proportionslehre" of Carl Gustav Carus (Leipzig, 1854), all the information that can be derived, meagre as it is, is purely inferential. In the skeleton of a hand represented at Fig. 4, Taf. iii. of this fine folio work, the "index" is considerably longer than the "ring" finger; and in the letter-press explanatory of this plate, a table is given of the lengths of the various factors of the digits, e.g. the metacarpals and the three phalanges, in "modulimminutes," constant lengths, each of which is equivalent to about seven millimetres. Now the length of the "index" is twenty-three, while that of the "ring" finger is only twenty "modulimminutes," the former thus exceeding the latter digit by about twenty-one millimetres, a difference much greater than any which has been recorded by Prof. Ecker. In the extended left hand of an *ideal* (sexless) figure, at Taf. iv. (*ibid.*), the "ring" and "index" digits are of the same length, the former being perhaps a shade longer.

Regiments and large asylums would be a fertile field for the further investigation of this interesting and highly suggestive subject.

J. C. GALTON

IN Mr. J. C. Galton's interesting article bearing the above title, in NATURE, vol. xiii. p. 8, no mention is made of the position of the hand at the time of making the observation as to the comparative length of the fingers. Perhaps Mr. Galton will kindly make it known whether Dr. Ecker has specified the position which he adopted. That the position makes some difference may be clearly seen in the following manner:—

Place the hand, back upwards, horizontally across the front of the chest, and observe the comparative length of the "index" and "ring" fingers. Then, by a motion of the wrist, moving the arm as little as possible, turn the hand outwards in the same plane, until the fingers stand at right angles to their first position, and again observe the two fingers. Naturally the "index" will appear to be longer in the first position than in the second, on account of the different condition of the muscles. Neither of these positions is likely to be adopted by anyone investigating the subject, but in any comparison of results *one and the same* position should be referred to as a standard, and this standard should specify whether the hand is held with the back or the face upwards. Dissimilarity between the two hands, as mentioned by Mr. Fryor, appears to be common.

F. T. MOTT  
Leicester, Nov. 19

I HAVE made a collection of over fifty outlines of the fingers of European hands (right and left). At present I find that the tendency in the female hand is to a proportionately longer third than index, in *both* hands, than in the male. In all the hands I have examined, the third finger of the left hand (when longer than the index) is also proportionately longer than the same finger of the right. In this series I have found only one case of an index longer than the third, and only one in which they were equal (both males). These are all carefully drawn into a pocket-book, care being taken that the hand is perfectly free from any muscular strain, which alters the result very appreciably; and the race, sex, and general physical characteristics are noted on the sheet. The list at present includes some eminent classical

scholars, a distinguished artist, and numbers of persons of more than average culture; yet there appears to be no correspondence between the mind and the length of the index finger.

R. A. N.

Extraordinary Tides

In last week's "Notes" you say, speaking of the unprecedentedly high tide of the 15th inst., that "no one seems to have expected an unusual tide." Allow me to state, sir, that in the *Spectator* of Nov. 7th, 1874, I predicted this extraordinary tide. As a matter of fact, the tide was higher than that of March 1874, through the unusually swollen state of the river by floods and the N.W. gale.

No extraordinary tide can occur this side of March 1878.

4, Buccleuch Place, Dulwich B. G. JENKINS

Further Linkage Work

In the interesting communication to NATURE, vol. xii. pp. 214-216, Prof. Sylvester gives account of the Hart and the Sylvester-Kempe "linkages." Of four points, three have work assigned. Problem: To employ the nondescript point.

First.—The Hart linkage yields the *Cissoïd*, exactly as that curve is defined. Thus, with  $p$  circling,  $q$  resting, and  $s$  tracing straight line;  $r$  traces *cissoïd*. Second.—The Sylvester-Kempe linkage yields the *Hyperbola*, in that curve's simplest vector form. Thus, with  $r$  opposite, to  $p$  resting, and  $pg, ps$  in constant directions;  $r$  traces the hyperbola whose asymptotes are these directions.

GEO. J. P. GRIEVE

Burntisland, N.B.

A Criminal Dog

I WAS so much pleased with the anecdote in NATURE (vol. xiii. p. 36) of the criminal dog who buried the cat he had murdered, that I told my wife; but I did not mention the breed of the dog.

She said, "Was it not a retriever? because they always bury their food, so that it may become *high*." I could but answer that it was a retriever, and added that I was afraid she had hit upon the real reason for the act.

R. S. CULLEY

General Post Office, Nov. 12

OUR ASTRONOMICAL COLUMN

THE BINARY STAR 44 BOOTIS.—In No. 2,064 of the *Astronomische Nachrichten*, Dr. Doberck, of Markree Observatory, has given an orbit of this binary, and a comparison with measures to the present year. The elements are—

Peri-astron passage	...	...	1783 <sup>o</sup> 01
Node	...	...	65 <sup>o</sup> 29'
Peri-astron from node on orb't	...	...	1 <sup>o</sup> 18'
Inclination	...	...	70 <sup>o</sup> 5'
Excentricity	...	...	0 <sup>o</sup> 71
Semi-axis major	...	...	3 <sup>o</sup> 093
Period of revolution	...	...	261 <sup>o</sup> 12 years.

Dr. Doberck makes no reference to Sir W. Herschel's second measure in 1802, giving for the angle 62° 59', or less than 3° in advance of his measure 1781, August 17, when the companion was first detected. The measure of 1802 was registered s.p. and "corrected by a subsequent observation to n.f.," as Sir John Herschel states in *Memoirs R.A.S.* vol. v. p. 46; but it is now pretty evident, from a projection of all the measures to 1875, that the quadrant was correctly registered s.p., and consequently the angle for 1802.246 should be 207° 1' according to our present method of reckoning. The angle calculated for this time from the above orbit is 206° 55', and this close agreement must be taken as very satisfactory evidence that Dr. Doberck has given us something like the true orbit, notwithstanding the difficulty of the case. It had been surmised that Sir W. Herschel's measures were to be increased 180°, Struve, in 1819, obtaining an angle of 228°, and Herschel and South, in 1821, 229°, but the position of the companion on the preceding

side of the principal star, instead of the following side where it had been seen in 1781, was accounted for both by Sir John Herschel in his "Micrometrical Measures of 364 Double Stars," and by Struve in "Mensuræ Micrometricæ," by supposing motion in an orbit passing nearly through the eye of the observer, with the longer axis of the ellipse but slightly inclined to the meridian. Dr. Doberck finds an inclination to the tangent plane of the heavens, of 70°. Calculating from his elements, the following appear to have been the angles and distances from 1785 to 1800:—

1785 <sup>o</sup> 0	...	Position	74 <sup>o</sup> 0	...	Distance	0 <sup>o</sup> 85
90 <sup>o</sup> 0	...	"	98 <sup>o</sup> 3	...	"	0 <sup>o</sup> 55
92 <sup>o</sup> 5	...	"	132 <sup>o</sup> 0	...	"	0 <sup>o</sup> 50
1795 <sup>o</sup> 0	...	"	162 <sup>o</sup> 7	...	"	0 <sup>o</sup> 53
1800 <sup>o</sup> 0	...	"	199 <sup>o</sup> 0	...	"	0 <sup>o</sup> 86

The calculated distance for epoch of Sir W. Herschel's measure in 1781 is 0<sup>o</sup> 89, and for that of 1802, 1<sup>o</sup> 05; the observed distances being only by estimation in diameters of the companion, giving "1/2 or 2/3 diameter" of smaller star in 1781, and "barely 1/2 diameter" in 1802, with power 460 in both years, are perhaps sufficiently well represented, though very admissible correction to one or two of the elements may diminish the distance in 1802 or increase that in 1781.

For comparison with future measures we have from Dr. Doberck's orbit—

1876 <sup>o</sup> 0	...	Position	241 <sup>o</sup> 45	...	Distance	4 <sup>o</sup> 887
78 <sup>o</sup> 0	...	"	241 <sup>o</sup> 71	...	"	4 <sup>o</sup> 928
80 <sup>o</sup> 0	...	"	241 <sup>o</sup> 97	...	"	4 <sup>o</sup> 971

THE MINOR PLANETS.—In No. 35 of the *Circulars* of the *Berliner Astronomisches Jahrbuch*, Prof. Tietjen notifies an arrangement which has been entered into by the Observatories of Leipsic, Leyden, Lund, Pola, and Vienna, for the more systematic and regular observation of the small planets. These Observatories have agreed to report to the editor of the *Jahrbuch*, every fortnight, the names or numbers of the planets which have been observed, with the dates of observation and the limits within which the planets whose positions are more uncertain have been sought. These communications will be so timed that they may arrive at Berlin on the 1st and 15th of the month, and will be there arranged, printed, and circulated. An invitation is extended to those Observatories where the small planets are occasionally, though not regularly, observed, to join in the proposed scheme. In the same manner the state of calculation as regards the various members of this group will be made known. The Milan Observatory has already engaged itself to calculation for No. 151.

Mr. Daniel Kirkwood, of Bloomington, Indiana, writes with reference to the resemblance which exists between the elements of certain minor planets, instancing as the most striking case that of No. 54, Alexandra, and No. 141, Lumen. An inadvertent application of the angle usually designated  $\omega$  (or the distance of perihelion from node) in the wrong direction, renders the similarity between the orbits of these planets somewhat less striking than in Mr. Kirkwood's communication, but there is nevertheless considerable resemblance, as the following figures will indicate:—

		Alexandra.	Lumen.
Perihelion	...	294 <sup>o</sup> 16'	341 <sup>o</sup> 32'
Node	...	313 <sup>o</sup> 49'	318 <sup>o</sup> 59'
Inclination	...	11 <sup>o</sup> 47'	11 <sup>o</sup> 33'
Excentricity	...	0 <sup>o</sup> 1987	0 <sup>o</sup> 2233
Mean distance	...	2 <sup>o</sup> 7093	2 <sup>o</sup> 7095
	Period	...	1628 <sup>o</sup> 9 days.

THE ZODIACAL LIGHT.—Those who are interested in the observation of this phenomenon will do well to be on the alert during dark evenings in the winter months. The most conspicuous exhibitions of the light in this country during the last few years have occurred in the month of January, the long standing recommendation to

expect the most notable displays in the evenings about the vernal equinox having thus been by no means justified in the result. The light was perceptible for a short time last Sunday evening, without any yellowish tinge, and the position of axis somewhat doubtful from the indifferent state of the sky. Prof. Heis's observations in December from 1851 to 1870, place the mean position of the apex on the equator in R.A.  $349^\circ$ , or with about  $82^\circ$  elongation from the sun: this refers to the eastern arm of the phenomenon.

### THE RAINFALL

THE extraordinary rainfall of the past year will make 1875 memorable in the annals of meteorology. With scarcely an exception every part of Great Britain has suffered from a plague of rain; from the Continent and from North America there come the same tidings of incessant rain and vast inundations. Even in a country so far distant as China we hear of unprecedented rains. The following statistics concerning a rainfall that occurred in China between last August 31st and September 1st will be read with astonishment. Our information is derived from the bulletins of the Meteorological Observatory of the Fathers of the Society of Jesus at Sikawei, on whose accuracy of observation we may doubtless depend. The readings show that between four and seven o'clock in the morning of September 1st the mean rainfall per hour was  $32\cdot7$  millimetres, which makes the astonishing rate of  $1\cdot287$  inch for each of those three hours. Well may the compiler remark, "We think there are few examples of such a figure, except in the case of waterspouts."

The total quantity that fell in the garden of the Jesuit Observatory during the twenty-four hours that elapsed between four o'clock on Tuesday, 31st August, and the same hour in the afternoon of Wednesday, 1st September, was 218 millimetres, or no less than  $8\cdot59$  inches for the rainfall of a single day! After this the records of rainfall in Great Britain look insignificant. Nevertheless the fall has far exceeded the ordinary statistics. At Balbriggan, a town a few miles north of Dublin, the rainfall from 9 A.M. on the 13th inst. to 9 A.M. on the 14th inst. was two inches. This is the greatest fall in twenty-four hours which occurred in that town for the last ten years.

It is important to obtain statistics from the southern hemisphere. It is probable a vast drought must somewhere compensate for the floods of water poured over a large part of the northern hemisphere.

### THE WORK OF THE CHALLENGER\*

THIS report is dated from Hilo Hawaii, August 18, and describes the cruise of the *Challenger* from Yokohama to the Sandwich Islands. The *Challenger* left Yokohama on the 16th of June, and ran an easterly course between the parallels of  $35^\circ$  and  $40^\circ$  north latitude, as far as the meridians of  $155^\circ$  east. She then turned nearly directly southwards and reached Honolulu on the 27th of July. Twenty-four observing stations were established, at each of which most of the desired observations were made.

On the 17th of June, Prof. Thomson's Report goes on, we sounded in 1,875 fathoms with a bottom of bluish-grey clay and a bottom-temperature of  $1\cdot7$  C., forty miles to the south-east of No Sima Lighthouse. The trawl was put over, and it brought up a large quantity of the bottom, which showed the clay was in a peculiar concretionary state, run together into coherent lumps, which were bored in all directions by an Annelid of the Aphroditacean group. In many cases the Annelids

were still in the burrows. Among the clay there were large lumps of grey pumice. The hyoid zoophytes were represented by a very remarkable species, apparently referable to the genus *Monocaulon* of Sars, a Corympha-like solitary polyp with adelocodonic gonophores; but instead of being of the proportions usual in its group, the stem in one of our specimens measured upwards of seven feet in height, while the polyp-head was nine inches in diameter across the proximal row of tentacles. We afterwards got another fine example of the same species at a depth of 2,900 fathoms (Station 248). The temperature of the surface of the sea stood during the day at nearly  $23^\circ$  C., considerably above the temperature of the air; and a serial sounding gave the isotherm of  $10^\circ$  C. at a depth of little more than 200 fathoms. We were therefore evidently under the thermic influence of the Japan current, which was found by observation to be running in an easterly direction at a rate of  $1\frac{1}{2}$  knots an hour. The thermometers registered a uniform temperature of  $1\cdot7$  C. from a depth of 1,000 fathoms to the bottom. About twenty Albatrosses of a nearly uniform brown plumage with whitish heads, probably the young of the common North-Pacific species in their second year's plumage, followed the ship.

On the following day there was a stiff breeze from the southward, and with a heavy sea. We sounded, however, successfully in 3,950 fathoms, our deepest sounding in the North Pacific position by dead reckoning lat.  $34^\circ 43' N.$ , long.  $144^\circ 2' E.$ , with a bottom of "red clay." The high surface-temperature continued to be maintained; and the position of the isotherm of  $10^\circ$  C., at station 239 at a depth of nearly 300 fathoms, indicates that up to this point, at all events, there was no diminution in the influence of the "Kuro-Siwa."

On the 21st the temperature-observations had a singular result. The surface-temperature gave fallen to  $18\cdot2$  C., and the belt of water above  $10^\circ$  C. was reduced in depth to considerably below 100 fathoms, while all the isotherms, at all events to a depth of 400 fathoms, rose in proportion. There seems to be little doubt, from a comparison of the American temperature-results with our own, that this sudden diminution of temperature is due to a cold surface-flow from the Sea of Okhotsk, probably through Pico Channel or Vries Strait. Very likely its effect may not be found to be constant; and at this season it possibly attains its maximum from the melting of the snow over the vast region drained by the Amoor and the Udi and Siberian rivers with a southern outflow.

On the 26th of June we sounded in 2,800 fathoms. Several forms were met with which apparently do not occur on the surface, particularly a number of species of a group which is so far as we know entirely undescribed. It seems to be intermediate between the Radiolarians and the Foraminiferas, resembling the former in the condition and appearance of the sarcode and in the siliceous composition of the test, and the latter in external form. The broken tests of these organisms are extremely abundant in the "red clay" soundings; a sufficient number of observations has not yet been made to enable us to say with certainty what is their bathymetrical distribution. From a zoological point of view the haul of the 28th was remarkably successful; there were one or two fishes, a *Scalpellum*, a number of annelids, particularly a prominent aphroditacean; Echinoderms of the genera *Pourtalesia*, *Archaster*, *Brisinga*, and *Antedon*; a fine species of *Cornularia*, several examples of *Fungia symmetrica*, and some *Actinia*. The general distribution of temperature remained much the same, the isotherm of  $10^\circ$  C. retaining its position near the 200-fathom line.

We trawled on the 2nd of July in 2,050 fathoms with a bottom of light brownish ooze with many *Globigerina*-shells. The bag brought up a number of lumps of pumice, and among them a very characteristic assemblage of deep-sea animals, the most interesting an undescribed

\* Abstract of "Report to the Hydrographer of the Admiralty on the Cruise of H.M.S. *Challenger* from June to August 1875," by Prof. Wyville Thomson, F.R.S., Director of the Civilian Scientific Staff on Board. Read at the Royal Society Nov. 18.

species of *Hyalonema*, which occurred in considerable numbers and in an excellent state of preservation. The form of the sponge-body is almost spherical, with a comparatively small oscular opening, and the coil is much shorter than in *H. Sieboldi*, in the largest specimens not more than six inches in length. One remarkable point was, that in no case was there a commensal *Palythoa* connected with this sponge; the coil was always perfectly clean. The spicules of the network and of the sarcode closely resemble those of the Japanese species, but they all present marked specific differences in detail of form.

On the 12th of July the trawl was lowered at a depth of 2,740 fathoms. The net contained very few animals, and was greatly torn and frayed; but in a kind of packet formed by an accidental folding of the net, there were about a hundredweight of black mammillated concretions, which, when they were poured out on the deck, had very much the appearance of potatoes. The external surface of the concretion was slightly rough, and a number of small animal forms, particularly a minute rhizopod in a membranous tube, nestled in the crevices. The nature of these concretions will be discussed hereafter.

On the 14th of July we reached the point lat. 38° 9' N., long. 156° 25' W., whence we turned southwards towards the Sandwich Islands. For the last few stations the temperature of the water had been gradually sinking, and the influence of the Japan current dying out; the isotherm of 10° C. was now only 100 fathoms below the surface.

On the 17th of July we sounded in 3,025 fathoms, the bottom still "red clay;" and on the 19th in 2,850 fathoms. A serial sounding taken at the latter station to 1,500 fathoms showed a considerable rise in the temperatures near the surface, the isotherm of 10° C. having again sunk to a depth of 200 fathoms, and that of 15° C. corresponding with the 100-fathom line.

On the 24th, in 2,775 fathoms, the Albatrosses which had followed the ship, to the number of four fourteen to twenty daily since we left Japan, left us. In the evening of the 27th, the *Challenger* anchored in the harbour of Honolulu.

This cruise naturally divides itself into two parts: a section about 3,170 nautical miles in length, including the stations from No. 237 to No. 253, very slightly to the northward of east, between the parallels of 35° and 38° N. lat.; and a meridional section of 1,128 nautical miles, along the meridian of 155° W. long. The first of these sections corresponds very closely in relative position with the section in the Atlantic between Sandy Hook and the Açores, and the points of resemblance and difference between them, when fully worked out, must prove most instructive. The two sections cross the two great deflections to the northward of the equatorial current, in the Atlantic the Gulf-stream, and in the Pacific the "Kuro Siwa;" and the thermic influence of the two currents is fairly contrasted. The influence of the Gulf-stream, if not absolutely greater (and this is a point which it will be somewhat difficult to determine), is at all events much more concentrated and effective, owing to the continuity of the coast-line of the American continent, to the way in which the water of the equatorial current is driven into the Gulf of Mexico and superheated there, afterwards to be kept together and ejected in a defined stream through the Strait of Florida, and to the absence of periodical winds in the Atlantic. In the Pacific, on the other hand, the main flow of the equatorial current is weakened among the passages of the Malayan Archipelago; and although a large part of it is directed northwards by the broken barrier formed by the Fiji Islands, the New Hebrides, and Papua, it almost at once enters the region of the Monsoons, where it is thwarted for half the year; and it can only be regarded as comparable with that portion of the reflux of the Atlantic equatorial current which passes outside the West Indian Islands. It passes the south coast of Japan nevertheless as a very palpable and appa-

rently a permanent current, exercising a very perceptible thermic influence to a depth of at least 300 fathoms.

In traversing the Pacific the influence of the Japan current appears to be gradually lost, while I am still inclined to believe that in the Atlantic the Gulf-stream is banked down against, and reflected from the western coast of Europe. It is a question of great complexity; but it seems to me that it is consistent with our experience that the temperature of the water of the ocean at any one place is due in a great measure to the temperature of the source of that water—not entirely due, for in passing through a long distance the temperature of even the greatest masses of water is certainly gradually altered by conduction and mixture.

The suggestions of Dr. Carpenter and Mr. Buchanan that the existence of a deep layer of warm water in the Atlantic might be connected in some way with the mean annual temperature of the area, and the absence of ocean-currents, are very suggestive; and I looked forward with great interest to an opportunity of testing them in the corresponding position in the Pacific. But there seems to be no trace of anything of the kind; as the influence of the equatorial reflux becomes weaker the temperatures fall uniformly.

To show that the conditions in the two oceans differ more in degree than in kind, I give in Plates I. and II. curves constructed from serial soundings along nearly corresponding lines in the Atlantic and Pacific. Curves A and B are added on Plate I. to show the position of the deeper belt of abnormally warm water, which makes its appearance near the coast of Europe.

Plate I.

No. of Station.	North Atlantic Ocean.		Depth in fathoms.
	Latitude.	Longitude.	
43	36° 23' N.	71° 51' W.	—
44	37 25 "	71 40 "	1700
53	36 30 "	63 40 "	2650
65	36 33 "	47 58 "	2700
69	38 23 "	37 21 "	2200
71	38 18 "	34 48 "	1675
80	35 3 "	21 25 "	2660
A A	In the Bay of Biscay.		2090
B B	Off the coast of Portugal.		1090

Plate II.

No. of Station.	North Pacific Ocean.		Depth in fathoms.
	Latitude.	Longitude.	
237	34° 37' N.	140° 32' E.	1875
240	35 20 "	153 39 "	2900
243	35 24 "	166 35 "	2800
245	36 23 "	174 31 "	2775
246	36 10 "	178 0 "	2050
248	37 41 "	177 4 W.	2900
252	37 52 "	160 17 "	2740

There seems to be little doubt that the enormous mass of cold water which fills up the trough of the Pacific is like the cold bottom-water of the Atlantic, an indraught from the Southern Sea. The more the question is investigated the less evidence there seems to me to be of any general ocean circulation depending upon differences of specific gravity. It seems certain that both in the Atlantic and in the Pacific the bottom-water is constantly moving northwards; and I am now very much inclined to refer this movement to an excess of precipitation over the water-hemisphere, a portion of the vapour formed in the northern hemisphere being carried southwards and precipitated in the vast southern area of low barometric pressure. I hope to enter fully into the discussion of this matter on a future occasion. The temperature of the water is greatly lower in the Pacific for the first thousand fathoms than in the Atlantic in the corresponding latitude of 35° N. There is one very remarkable difference between

the two basins. While in the Atlantic it seems certain that the temperature sinks gradually, though very slightly, for the last thousand fathoms to the bottom, it appears that in the Pacific the minimum temperature of 1°7 C. is reached at a depth not greater than 1,400 fathoms, and that from that depth to the bottom the temperature is the same.

The soundings from Yokohama to Honolulu are remarkably uniform in depth, the twenty-two soundings on one line which are unaffected by the neighbourhood of land giving an average of 2,858 fathoms. The nature of the bottom is also very uniform; and, according to the nomenclature which we have adopted, it is in each case noted on the chart as "red clay." It is usually, however, somewhat greyer in colour than the typical "red clay," and contains a large proportion of the tests of siliceous organisms, a proportion which increases with increasing depth, and a considerable proportion of pumice in different states of comminution and decomposition. The clay contains scarcely a trace of carbonate of lime, although the surface swarms with ooze-forming foraminifera. In some cases the trawl came up half full of large lumps of pumice, which seemed to have been drifted about till they were water-logged, and to be softening and becoming decomposed; these pieces of decomposing pumice were often coated and pervaded throughout with oxide of manganese. Over the shale area the red clay was full of concretions, consisting mainly of peroxide of manganese, round, oval, or mammillated and very irregular, varying in size from a grain of mustard-seed to a large potato. When these concretions are broken up, they are found to consist of concentric layers having a radiating fibrous arrangement, and usually starting from a nucleus consisting of some foreign body, such as a piece of pumice, a shark's tooth, or a fragment of any organism, as for instance in one case a piece of a Hexactinellid sponge, of the genus *Aphrocallistes*, which was preserved as a very beautiful fossil in the centre. The concretions appear to form loose among the soft clay; the singular point is the amount of this manganese formation, and the vast area which it covers.

We were particularly successful during this cruise in getting good samples of the fauna from great depths; and we found that the fauna of the North Pacific at depths of from 2,000 to 3,000 fathoms, although not very abundant in species, is by no means meagre. For each of six dredgings and trawlings at depths greater than 2,000 fathoms, we found along with a few fishes a fair representation of all the larger invertebrate groups; and in one dredging, No. 253, at a depth of 3,125 fathoms, we took a small sponge, a species of *Cornularia*, an *Actinia*, an annelid in a tube, and a Bryozoon. We were again struck with the wonderful uniformity of the fauna at these depths; if not exactly the same species, very similar representatives of the same genera in all parts of the world. I am glad to be able to report that everything is going on in a satisfactory way in the departments under my charge.

#### ACOUSTIC CLOUDINESS

WHEN the weight and number of the guns in action are taken into account, the following extract from "My Experiences of the War between France and Germany," vol. ii. pp. 285-9, by Archibald Forbes, will probably be regarded as the most extraordinary instance of "acoustic cloudiness" hitherto recorded. The complete reversal of the optical and acoustical conditions on two succeeding days renders the case very perfect. I am indebted for the extract to the obliging kindness of Mr. James Kenward, of Birmingham.

"The morning of the 6th presented a remarkable contrast in every respect to that of the preceding day. The latter had been cold to the chilling of the marrow, and so thick that nothing was to be seen half a mile away. The

former was clear, bright, and warm as a morning in the end of March. Yesterday the air was charged with sound; to-day there reigned the stillness of an Arcadia that knows not war. Men looked at each other in blank amazement. Had Paris, forts, big guns, bombardment, and the no-bombardment on the eastern side alike been spirited away? Had the French reply shut up our pretty Spandau toys in one day? Or, on the contrary, had those pieces of finished mechanism stove in the forts and batteries bodily? And if we were going up to Montmorency, should we see the white flag on the top of Montmartre in token that all was over? Men were reticent in expressing speculations, but at the corners of the straggling lanes of Margency I heard the words 'Capitulation,' 'Parlementaire,' muttered as the feldgendarmes and the orderly-men gossiped in little groups. Making the best of my way to head-quarters, I found head-quarters in ignorance and suspense. Nobody could interpret this strange, ghostly silence. There had come from Versailles on the previous night a telegram stating that the King was well pleased with the results which the day's bombardment had achieved. So it was plain the silence was not on our part due to coercion. 'Negotiations, then?' I suggested to my friendly interlocutor. 'No, that cannot well be,' was the reply, 'since in that case we should have received instant instructions to silence our Maas Army batteries, and this has not been the case.' 'Are they firing, then?' I asked, for it might be that I had been struck with sudden deafness. 'No, it would seem not, I can hear nothing. The silence is a puzzler, but we are sure to hear all about it within a few hours.' Determining to anticipate by personal investigation the information which was kindly promised me, I rode off to the front of Montmorency, whence there lay spread before the eye the wide panorama of the north side of Paris. Still all was silent as the grave. There was the white foreground, the ice-bound river, and the St. Denis chimneys smoking lustily according to their wont. Neither from the east nor the west came there the slightest sound of firing. A slight haze-bank hung over Le Bourget, which might have been snow, fog, or the filmy smoke of a cannonade; but, if the latter, it must have surely been audible. There I found three mounted officers, and we had a little talk about the position. They inclined to the armistice-negotiations theory, more especially as they had not heard a single shot since morning. As we spoke, there came a white jet of smoke out of the grey side of La Briche. No sound; for all the noise it made it might have been an escape of steam. But in a second or two we did hear something—the close swish of the shell, and then the explosion about fifty yards to the right. La Briche could not resist the temptation of the group. 'No negotiations, then, that is certain,' was the remark as we broke up and went our several ways.

"This action of La Briche rather intensified the puzzle, because it seemed to knock away the only explanation. I could not go to the south, but I could visit the batteries about Pont Iblon, and get at the root of the matter.

"I came on to Gonesse alone. What was my surprise to find all the German batteries from Gonesse to Sevran firing away vigorously! They had been at it since eight in the morning. In Gonesse I learned that the firing on the south side was believed to have recommenced at the same hour, and was certainly going on. Yet at Margency and Montmorency we could not hear a sound. It was all owing to the air; it was to-day as non-conducting of sound as it had been the reverse yesterday. Even in Gonesse we could not hear the guns that were thundering, so to speak, at our elbows."

The condition of things here so graphically described discloses a state of the atmosphere precisely similar to that existing at the South Foreland on the 3rd of July, 1873. There, as here, the belching of the smoke from



the 18-pounder, the howitzer, and the mortar, resembled noiseless jets of steam, projected, "so to speak, at our elbows."

JOHN TYNDALL

Royal Institution, Nov. 17

#### CHARLES BLACKER VIGNOLES, F.R.S.

THIS celebrated engineer died on the 17th instant at Hythe, at the age of eighty-three years. Although he won his fame mainly as an engineer, yet his services to science were of considerable importance. Mr. Vignoles was descended from an ancient French family which had taken refuge in England after the repeal of the Edict of Nantes. His father, Capt. Vignoles, was an officer in the 43rd Regiment of the Line, and his mother was a daughter of Dr. Charles Hutton, the celebrated mathematician and professor at the Royal Military Academy, Woolwich. When young Vignoles was only twelve months old, his father lost his life at the storming of Pointe-à-Pierre, Guadaloupe, when Sir Charles Grey, the commander of the British forces, gave the former a commission in the army. Thus his career has been an unprecedentedly long one. His grandfather, Dr. Hutton, undertook his education, and the pupil certainly turned out a credit to his teacher. For a short time before the conclusion of the great war which ended in 1815, Vignoles served under the Duke of Wellington on the Continent, and after visiting America about 1822, he returned to England and threw himself enthusiastically into the engineering profession. The railway movement was just then gathering strength, and Vignoles was associated with some of the earliest efforts to establish lines in this country. After the Liverpool and Manchester Railway Bill was thrown out of Parliament in 1824, he was, in 1825, selected by Messrs. Rennie to take charge of the new surveys which the Liverpool Committee ordered. From this time forward Vignoles was ever in the van of the railway movement, and had the foresight to predict, amid some incredulity and ridicule, to what gigantic results it would lead. In 1826 he was employed by Messrs. Rennie to make surveys for a line from Nine Elms, Vauxhall, Dorking and Shoreham, to Brighton; and in 1834 he escorted M. Thiers over the railways which had been built under his superintendence. The great French Minister's dictum was, "I do not think railways are suited for France." In England, in Ireland, on the Continent, and in America, Mr. Vignoles took a prominent part in the carrying out of great railway and other engineering works. Probably one of his greatest works was the magnificent suspension bridge over the Dnieper at Kieff, commenced in 1848 and finished in 1853, at a cost of 432,000*l.* A fine model of this is now in the Crystal Palace.

Mr. Vignoles became a member of the Institution of Civil Engineers in 1827, and was elected President in 1870, when he gave a very able address on the progress of engineering. In 1842 he gave a series of remarkable lectures as Professor of Civil Engineering at London University College. In 1855 he was elected a Fellow of the Royal Society; he was also a Fellow of the Royal Astronomical Society, and was for long a regular attendant at its meetings. The Eclipse party of 1860 was to a great extent indebted to him for all the local arrangements, and its success was mainly due to his exertions. He was also Honorary Treasurer of the Expedition of 1870, was on board the *Psyche* when she struck, and was afterwards indefatigable in aiding the necessary arrangements. In the early part of its career he took an active part in the meetings of the British Association, contributing several papers to the Mechanical Section.

As might be expected, Mr. Vignoles was a man of great energy and strong physical constitution. On the Thursday before his death he attended the annual inspection,

in his capacity of Lieutenant-Colonel, of the Engineers and Railway Volunteer Staff Corps. On the Saturday following he was struck with paralysis, and remained unconscious till his death on the following Wednesday. He was buried yesterday at the Brompton Cemetery.

#### THE GERMAN COMMISSION ON ARCTIC EXPLORATION

FURTHER details concerning the work of this Commission appear in a recent number of the *Karlsruher Zeitung*.

The Commission cannot recommend another Arctic expedition. The task of special geographical discovery, to whose solution previous expeditions have contributed, must, since the polar regions have been opened up at many points, give place to the task of exploring in detail the region of which we now have a general knowledge, and on the results thus attained to construct a sure basis for wider researches. "Without such an established basis, every new Arctic expedition might, according to the circumstances, accomplish more or less good results, but for this a considerable expenditure of public means would be the less advisable, that we may have a sure expectation, by following a different course from that hitherto pursued, of accomplishing, more slowly perhaps, but all the more surely, the exploration of the Arctic zone, and at the same time solve very important problems in science."

The Commission unanimously agree that the exploration of the Arctic region should be undertaken. The last part of the Report, without pretending to be complete, discusses very important questions in all departments of science, the solution of which is to be obtained by Arctic exploration. The majority of meteorological and hydrographic problems, many questions in the regions of terrestrial magnetism and physical astronomy, a number of questions in the department of natural science, in other words, the discovery of the laws of periodical phenomena and of the variations from these laws, cannot be accomplished by an Arctic expedition of the kind hitherto sent out. Such an expedition cannot remain for any length of time at a number of points, and can therefore furnish observations bearing only on time and place, which do not in the least enable us to conclude what would be the condition at another time.

It is otherwise with those scientific problems in which the establishment of facts is of importance, as in the majority of problems in natural history, and in many of the other regions of natural science and geography. For such problems an expedition of the usual kind would accomplish very valuable results. For the solution of other problems the establishment of observing stations is desirable, from which, through as long a period as possible, observations of periodical phenomena should be undertaken. But in order to be able to generalise the results, corresponding observations should be made from time to time at intermediate stations and in regions lying in the neighbourhood. A German expedition would thus erect observing stations on particular points, and then would make such arrangements that, according to the special circumstances of the stations, or to accomplish special scientific objects, exploring journeys could be made from the stations as a basis, by land and water, in sledges, ships, or boats. This combined system of fixed stations and exploring journeys would give us at least the prospect, by the minute exploration of any particular region in which it might be employed, of enriching our knowledge with a plentiful supply of facts.

The problems indicated by the Commission for Arctic exploration can only be fully solved by means of a connected system of stations and exploring journeys in the Arctic region, and thus the way be opened up to the hitherto entirely unexplored portion. Explorations must thus be carried on by the three great water approaches,

which lead to the polar sea — between Greenland and Spitzbergen, between Spitzbergen and Novaya Zemlya, and through Behring Strait—and which have a physical connection, which is shown very distinctly in the isothermal curves. In this undertaking the co-operation of all States having an interest in these researches should be sought. Through the simultaneous action of different States a circle of observing points would be formed, which would sub-divide a common work having the same end in view, so that the combined labour of several nations would entail less sacrifice to each than has hitherto been the case. The Commission also recommends the above principles for the guidance of other nations, and thus an international alliance might be formed through which the highest scientific results would be attained. The Commission points out that one immediate result of the Second German Expedition is that the region between the west coast of Greenland and the east coast of Spitzbergen would be a suitable field for German research. As we have already stated (*NATURE*, vol. xiii., p. 33), they recommend a principal station to be established on the east coast of Greenland, with secondary stations on Jan Mayen Island and the west coast of Spitzbergen.

In the region indicated for observation, which can easily be reached from Central Europe, and whose exploration has for European States the greatest scientific and practical interest, German explorers have made a happy commencement, and established a claim for Germany to continue the work thus begun. The Commission urge Germany to set about at once fitting out an expedition for the occupation of the above region. They believe that if diligent preparations were made, the expedition might be ready to start in 1877. Finally, they recommend the appointment of a Scientific Commission to draw up full instructions for the guidance of the expedition in all departments.

#### THE FAUNA OF THE CASPIAN SEA

OSCAR GRIMM has given in Von Siebold and Kölliker's *Zeitschrift* a brief account of his exploring expedition to the Caspian Sea last year, which will make naturalists look expectantly for the completion of his descriptions. The character of the fauna of the Caspian has interest for the evolutionist in natural history, as well as for the geologist. It will afford evidence not only of modification of animal life, but also of successions of change in physical geography. Two months were spent at Baku, and one month on board a steamboat in dredging from Baku to Krassnowadsk, thence to the Balchan Bay on the east coast, by the island of Tscheleki, southwards to Astrabad, and thence by Enzili and Lenkoran to Baku. Dredging was carried on up to a depth of 150 fathoms, and an enormous quantity of specimens was obtained, including six new fishes (*Gobius* and *Benthophilus*), twenty species of Mollusca, including four species of *Cardium*, four of *Adacna*, and three of *Dreysena*; thirty-five species of Crustacea, principally colossal forms of *Gammaridæ*; and twenty species of *Vermes*. The eastern coast adjoining the sandy steppes was almost destitute of marine life, owing to the quantity of sand blown into the sea. The western part of the sea gives depths of 517 fathoms, and has a very abundant fauna. At one haul of the dredge in 108 fathoms, not far from Baku, there were taken 350 specimens of *Gammaridæ*, 150 *Idothea entomon*, fifty colossal *Mysis*, six species of fishes, and many large Mollusca.

One hundred and twenty species in all were taken, of which eighty are new to science. Many more might be expected to reward dredgings in the deeper parts of the sea. Those already known fall into two classes: (1) those derived from still existing or already extinct species, or but slightly differing from species living in the nearest

seas; and (2) those which are identical with those of other seas. The latter are species possessing special tenacity of life, such as *Sabellides octocirrata*, *Mysis relicta*, and *Idothea entomon*.

Relationship is shown between the Caspian fauna and the faunas of the Aral and Black Seas, and the Northern Ocean. But the connection with the latter is more recent than with the Black Sea, for *Phoca*, *Coregonus leucichthys*, and other forms, not existing in the Black Sea, are common to the Northern Ocean and the Caspian. The geographical changes which Dr. Grimm conceives to have brought about these results will be better understood, and their probability may be more easily criticised, when the complete account of the Caspian Fauna is published.

#### NEW FORM OF TUBE FOR OBSERVING THE SPECTRA OF SOLUTIONS\*

WE have the honour of presenting to the Academy an eminently useful spectro-electric tube; † it realises, in fact, a certain number of advantages, which are as follows:—

1. Constancy of spark permitting prolonged observation of spectra.
2. Suppression of the meniscus, and consequently of the absorption which it produces by partly concealing the spark.
3. Electrodes enclosed in a special tube, which preserves the solution from contact with impurities.
4. Possibility of collecting entirely the substance examined.
5. Possibility of arranging a series of spectroscopic tubes, enclosing solutions of the various bodies, thus permitting rapid demonstrations and comparisons.

The closed tube A of eleven centimetres in height, and  $1\frac{1}{2}$  centimetres in diameter, is traversed by a lower platinum electrode *f*; in the mouth of A is fixed a cork stopper C, pierced by an orifice through which passes a capillary tube B. B is traversed by a platinum wire *cd*, terminated at the upper end by a ring, and at the lower end by a point *d*, opposite *f*. *d* and *f* are the electrodes. The important part of the apparatus is a small capillary tube, slightly conical, one centimetre in height, moveable, and which covers the lower electrode *f*, topping it by  $\frac{1}{2}$  millimetre.

To work the apparatus, pour into the tube A the solution to be examined, taking care that the electrode *f* and the tube B are only immersed to half their height. Let *ab* be the level of the liquid; capillary force determines the ascent as far as the point D, on which is formed an immovable drop which is vaporised when an induction current is put on by *c* and *f*. The observations may then continue a very long time without intermission, allowing the spectra to be observed and drawn with the greatest ease.

This very simple apparatus has rendered us so great service in the course of our investigations, that we cannot too strongly recommend its use to chemists engaged in spectral analysis. Never-

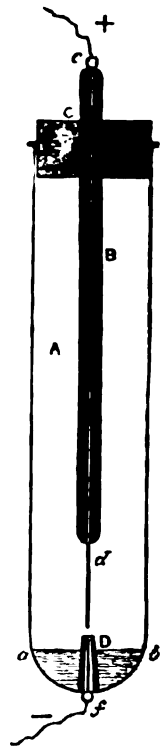

A, Tube into which the liquid to be analysed is poured. B, Capillary tube in which is fixed the platinum wire *cd*, which forms the upper electrode. C, Cork stopper closing the tube A; it supports B, and permits its being moved with little friction. D, Small capillary tube, slightly conical, covering the lower electrode *f*. *d*, Upper electrode. *f*, Lower electrode. *a b*, Level of liquid.

\* Paper read at the Paris Academy of Sciences, Oct. 26, by MM. Delachanal and Mermet. *Comptes Rendus*, t. lxxxi. No. 17, p. 726.  
† See the description of the original apparatus in the "Annales de Chimie et de Physique," 5<sup>e</sup> series, t. liii., 1874.

theless, in some cases, as for example when it is desired to observe the spectrum of ferric solutions, it is preferable to employ the original tube; \* for the flow of the liquid causes solid particles to be given off, which tend to become fixed in the electrode.

### SCIENCE IN GERMANY

(From a German Correspondent.)

IN the twenty-fifth volume of the "Zeitschrift für Wissenschaftliche Zoologie," just completed, Ehlers has given some interesting conclusions with respect to the distribution of the Chætopoda which were collected during the Porcupine expedition, by Messrs. Carpenter, Wyville Thomson, and Gwyn Jeffreys ("Beiträge zur Kenntniss der vertical Verbreitung der Borstenwürmer im Meere"). He finds, in the first place, that of all Chætopoda occurring on the European coasts of the North Atlantic Ocean, only two families show representatives in the greater sea-depths at more than 300 fathoms, and he thinks, therefore, it is not certain that any forms belong exclusively to the deep sea. Further, the conditions of temperature of the water, as they determine the horizontal distribution of Chætopoda, seem also to be of influence with regard to their vertical distribution, seeing the deeper layers of water are also the colder. Accordingly the forms that live in the cold deep sea of that zone of the Atlantic Ocean correspond with those of the coast fauna of the Arctic regions; and Ehlers thinks that they might even have a direct connection through currents which descend from the Arctic regions to the depths of warmer marine zones. It is also conceivable that the deep-sea forms, at a time when those regions of the Atlantic were warmer than they are now, were frequenters of the coast, and in proportion as the Gulf Stream heated the upper layers, they retired into the depths. For the most part they remain inferior to their Arctic congeners, perhaps because the conditions of existence in the depths are less favourable, and partly, doubtless, on account of the lack of plant life, and also the small amount of animal nutriment for the worms, there provided. Though in the greater sea depths the light is quite excluded, yet in the Chætopoda found there (with some rare exceptions) we miss neither the colours nor the eyes, which are met with in coast regions. Ehlers believes that these colours and eyes are preserved in the lightless depths, in consequence of new animals ever migrating down from the brighter layers of water, and so preventing the disappearance of these body-parts. There is, however, in the same "Zeitschrift" which contains Ehlers' work, a paper by the physiologist Ranke, on the eyes of leeches (*Hirudo medicinalis*), which may explain that phenomenon in the deep-sea Chætopoda in a different way ("Beiträge zur Lehre von der Uebergangs-Sinnes-Organen"). Ranke, on the ground of his observations on living leeches, considers that their very simply constructed eyes have also sensations of touch and taste; and, further, that they are not eyes proper, which, on occasion, also serve other ends; they are, rather, neutral organs of sense, which can act in various directions, but in no particular one so specially as sense organs more highly organised, and therefore limited to one specific energy. This appears partly from the fact that organs quite similar to these so-called eyes on the head of the leech occur also in the whole of the rest of its body, quite in the same way as the so-called side organs of fishes and amphibia, which probably afford sensations of touch. We might, then, regard the eyes of the deep-sea Chætopoda as similar indifferent organs of sense, which, even where light fails, do not discontinue their functions. In an appendix to his memoir, Ehlers further describes how the tubeworms (*Tubicola*) construct their abodes. They use their feelers only for seizing and holding the building materials,

then press these to the mouth or side of the abdomen, where they are coated with a cement secreted from numerous skin-glands in these parts of the body. So prepared, the piece has merely to be pressed on a firm bed, or the edge of a tube already formed, and there it adheres. In this way not only are new tubes constructed, but also any damages are repaired.

### NOTES

THE following are the probable arrangements for the Royal Institution Friday evening meetings before Easter 1876:—  
 Jan. 21, Prof. Tyndall, F.R.S.: The Optical Department of the Atmosphere in relation to the Phenomena of Putrefaction.  
 Jan. 28, Prof. Huxley, F.R.S.: The Border Territory between the Animal and the Vegetable Kingdoms.  
 Feb. 4, W. H. Preece: The Applications of Electricity to the Protection of Life on Railways.  
 Feb. 11, William Crookes, F.R.S.: The Mechanical Action of Light.  
 Feb. 18, Dr. C. William Siemens, F.R.S.: The Action of Light on Selenium.  
 Feb. 25, Lord Lindsay: The Transit of Venus.  
 March 3, Earl Stanhope, F.R.S.: The Ancient Sun Worship, and the Remains of it in England.  
 March 10, Prof. W. H. Flower, F.R.S.: The Extinct Animals of North America.  
 March 17, Sir Henry Sumner Maine, K.C.S.I.: The Later History of the Fief and Manor.  
 March 24, Prof. Odling, F.R.S. (subject not announced).  
 March 31, Edward B. Tylor, F.R.S.: Ordeals and Oaths.  
 April 7, Prof. Jas. Dewar, F.R.S.E.: The Physiological Action of Light, Part II.  
 The following lecture arrangements have been made:—Christmas Lectures (adapted to a juvenile auditory) by Prof. Tyndall, F.R.S.: Six lectures on Experimental Electricity. In this course the phenomena of frictional electricity will be so illustrated and its principles so explained as to enable the pupil to repeat the experiments, and to pursue the subject further, at school or at home. With this object in view the laws of the science will be elicited from facts obtained with the simplest apparatus. Prof. A. H. Garrod: Twelve lectures on the Classification of Vertebrated Animals.  
 Dr. J. H. Gladstone, F.R.S.: Eight lectures on the Chemistry of the Non-metallic Elements.  
 Dr. W. Spottiswoode, Treas. R.S.: Four lectures on Polarised Light.  
 R. P. Pullan: Three lectures on his Excavations in Asia Minor.  
 W. T. Thiselton Dyer: Four lectures on the Vegetable Kingdom; the Boundaries and Connections of its Larger Groups.  
 Prof. G. Croom Robertson: Three lectures on the Human Senses.  
 Edward Dannreuther: Two lectures on Wagner and his Trilogy (with pianoforte illustrations).

THE Stockholm *Nya Dagligt Allebanda* of the 4th inst. contains some account of the return voyage of the *Pröven* from the mouth of the Yenesei, after the departure of Nordenskjöld. The information is sent by Dr. Théel Kjellman, to whom, it will be remembered, Nordenskjöld gave over the command of the *Pröven*. The *Pröven* left Dickson Harbour, at the mouth of the Yenesei, on the 19th August, and set her course towards the north-east part of Novaya Zemlya. On the 23rd August she was found to be already in 75° 24' N. lat., and 66° 24' long. E. from Greenwich, and so a little to the south of Cape Middendorf, on the north-east coast of Novaya Zemlya. This peculiar circumstance can only be explained by a very strong north-westerly current going from the Ob and Yenesei out over the Kara Sea. At Cape Middendorf, where ice was met with which extended eastwards as far as the eye could reach, the expedition was becalmed for six days. During this time a considerable amount of dredging work was done, with abundant results. That animal life is here uncommonly rich at the sea-bottom may be inferred from the fact that when a swab was allowed to remain in contact with the bottom for a few minutes it was covered over with animals: sea-stars by hundreds, with

\* See "Annales de Chimie et de Physique," Third Series, t. iii., 1874.

the most beautiful nuances of red, numerous, and colossal bush-like Alectos, Crustacea, and Mollusca stuck fast on its strands. On the 28th a start was again made, and a number of immense glaciers coming down to the sea were passed; the coast was rocky and very wild. The following day anchor was cast in Udde Bay. Marine vegetation was uncommonly abundant here, which is all the more interesting, as it has been stated that the Kara Sea is devoid of all plant life. Vegetation on land, on the contrary, was exceedingly scanty. Some small withered willows met the eye here and there. The fell-poppy (*Fjellvalmon*) alone yet bare flowers, but even these the autumn had almost destroyed. "The whole of nature produced the impression of indescribable desolation." On the 3rd September the *Prøven* sailed into the mouth of Matotschkin Strait, where the expedition remained till the 11th September. They then steered homewards, and after experiencing exceedingly tempestuous weather, the *Prøven* entered the harbour of Tromsø on the 3rd October. "We have," the letter concludes, "during this summer sailed over known and unknown seas more than 6,000 (English) miles; we have visited regions whither expeditions for more than three hundred years have attempted in vain to come; we have made rich collections in all departments of natural science. What more can man desire from such a journey?" In Petermann's *Mittheilungen* for December, along with some account of the expedition, is a map showing the route outwards and home of both parties. Nordenskjöld had reached St. Petersburg on the 17th instant.

In his will, dated Oct. 16, 1875, Sir Charles Wheatstone bequeaths all his scientific books and instruments, as well as his medals and diplomas, to the Corporation of King's College, London, together with a legacy of 500*l.* for the purchase of scientific instruments. To the Royal Society he bequeaths the portraits of the Hon. Robert Boyle, and of all the other scientific men in his possession, together with a legacy of 500*l.* to be added to the Wollaston Donation Fund.

It is stated that Prof. Huxley has accepted the invitation of the Senatus of the University of Edinburgh to take charge again of the Natural History Class during next summer session.

THE *Challenger* arrived at Valparaiso on the 19th inst.

THE following gentlemen have been appointed as a Commission to consider the claim of the Scottish Meteorological Society on Government, a claim which we may state has already been reported on by the Duke of Devonshire's Commission:—Sir Wm. Stirling Maxwell, Dr. Hooker, Col. Strachey, Messrs. Francis Galton, Brassey, D. Milne Home, Farrer, and Lingen.

PETERMANN'S *Mittheilungen* for December contains a translation of Mr. Stanley's letters, with a clear map embodying the results of his circumnavigation of Lake Victoria Nyanza, and showing at the same time Speke's route of 1858, and that of Speke and Grant in 1861-62. In an introduction to the letters, Dr. E. Behm discusses the results obtained by Mr. Stanley. The *Daily Telegraph* of Tuesday publishes two letters from the late unfortunate M. Linant de Bellefonds, describing his sojourn at Mtesa's and his meeting with Mr. Stanley.

THE same number of the *Mittheilungen* contains the first part of an elaborate and important paper by Oscar Loew, giving an account of Lieut. Wheeler's second expedition into New Mexico and Colorado in 1874, and pointing out the important scientific bearings of the results obtained. He pays a well-deserved tribute of praise to the enterprise of the U.S. Government, in accomplishing the survey of so large a portion of their extensive territories in so comparatively short a time.

AN interesting letter appears in yesterday's *Daily News* from Mr. Smithurst, the engineer of the steamer which made the

voyage up the newly discovered Baxter River in New Guinea, referred to in Sir Henry Rawlinson's address at the Geographical Society last week. The river seems to be a magnificent one, and could evidently be made navigable to a considerable distance inland. The exploring party found the banks to consist mainly of mangrove swamps, though, near the end of the journey, high clay banks with *Eucalyptus globulus* were found. Scarcely any natives were seen, though there were frequent signs of their being about. Mr. Smithurst refers to a very remarkable bird, which, so far as we know, has not hitherto been described. The natives state that it can fly away with a dugong, a kangaroo, or a large turtle. Mr. Smithurst states he saw and shot at a specimen of this wonderful animal, and that "the noise caused by the flapping of its wings resembled the sound of a locomotive pulling a long train very slowly." He states that "it appeared to be about sixteen or eighteen feet across the wings as it flew, the body dark brown, the breast white, neck long, and beak long and straight." In the stiff clay of the river bank Mr. Smithurst states that he saw the footprints of some large animal, which he "took to be a buffalo or wild ox," but he saw no other traces of the animal. These statements are very wonderful, and before giving credence to them we had better await the publication of the official account of the voyage. A very fair collection of rocks, stones, birds, insects, plants, moss, and orchids has been made, which will be submitted to a naturalist for his opinion. The dates of Mr. Smithurst's communication are from August 30 to Sept. 7.

THE long-standing Chancery suit of the King of Portugal *v.* Carruthers has at length been terminated by a compromise. The suit arose out of the will of the late eminent African explorer, Dr. Welwitsch, who had explored a portion of Central Africa at the expense of the Portuguese Government, and had made large and important botanical collections. These collections were left by will to the British Museum; but Dr. Welwitsch's right to so leave them was disputed by the Portuguese Government. The compromise finally arrived at is to this effect:—A declaration that the King of Portugal is entitled to all the collections; the King, as an act of grace and favour, paying the defendants 700*l.* in full discharge of all demands; that the study set (the best) and the next best set of the collections should be separated from the other collections; that the British Museum should have the second best set as a gift from the King, and that the King should have all the other sets, and should distribute them as he may think proper.

WE learn from the *Gardener's Chronicle* that M. E. André, well known as a landscape gardener in this country as well as on the Continent, and also as the editor of the *Illustration Horticole*, is about to undertake a botanical exploration in Brazil, Peru, Ecuador, and New Granada.

M. GABRIEL DE MORTILLET, the learned sub-director of the St. Germain's Museum, has been appointed President of the Paris Anthropological Society for 1875-76.

TWO new zoological gardens have recently been established and opened in the United States of America, at Philadelphia and Cincinnati, and both appear to be making good progress. The Superintendent of the former is Dr. Dorner, who was lately scientific secretary of the Zoological Garden at Hamburg, and has quitted Europe in order to inaugurate the new institution in America.

THE meeting of Orientalists to be held in September next at St. Petersburg is to be accompanied by an exhibition of Oriental manuscripts, coins, arms, implements, and other objects illustrative of the history and industry of the East. The meeting will be directed by an Imperial Commission, presided over by Prof. Gregorieff, the well-known geographer of Central Asia,

and including the names of Peter von Lerch, Victor von Rosen, and Daniel Chvlosou. MM. Gregorieff and Lerch are ready to receive objects intended for exhibition.

At a meeting of the Fellows of the Royal Society of Edinburgh, held on Monday, the 22nd inst., the following were elected office-bearers for the session 1875-76:—President, Sir William Thomson, LL.D. Vice-Presidents: Rev. W. Lindsay Alexander, D.D., the Right Rev. Bishop Cotterill, David Milne Home, LL.D., Prof. Kelland, Lord Neaves, David Stevenson, C.E. Secretary, Prof. H. Balfour. Secretaries to ordinary meetings: Professors Tait and Turner. Treasurer, David Smith. Librarian, Prof. Maclagan. Members of Council: Alexander Buchan, J. Matthews Duncan, M.D., Prof. George Forbes, Andrew Fleming, M.D., Prof. Geikie, Sir Alexander Grant, Thomas Harvey, LL.D., John G. M'Kendrick, M.D., Arthur Mitchell, M.D., Charles Morehead, M.D., Ramsay H. Traquair, M.D., Robert Wyld, LL.D.

THE session of the Poitiers Meteorological Congress was opened on the 18th inst. M. Leverrier was present. The future Association is to be composed of sixteen departments: Loire, Loire et Cher, Loiret, Indre et Loire, Maine et Loire, Loire Inférieure, Vendée, Charente Inférieure, Deux Sèvres, Charente, Haute-Vienne, Vienne, Indre, Sarthe, Corrèze, and Creuze. The Gironde, which is to become the centre of another branch of the Association, sent three delegates. The proceedings are to be published, but the sittings were not public.

It is officially announced that it is the purpose of the U.S. Government to make a complete and representative collection of the mineral products of the United States, which shall illustrate the mineral resources of the country and its mining and metallurgical progress at the forthcoming International Exhibition to be held in Philadelphia.

In consequence of the time at the Manchester meeting of the Iron and Steel Institute being insufficient to allow of the reading and discussion of several papers that were upon the programme, a supplementary general meeting is being held in London to-day in the rooms of the Council of the Institution of Civil Engineers. Besides discussions on papers read at Manchester, Mr. G. J. Snelus will read a paper on fireclay and other refractory materials; Mr. William Hackney on the manufacture of anthracite coke in South Wales; Mr. C. J. Homer on the North Staffordshire Coalfield, with the ironstones contained therein. Suggestions will be submitted to this meeting for introducing such modifications in the rules and regulations as will in future admit of dealing fully with the various subjects that may be brought before each meeting of the Institute.

At its last sitting the French Geographical Society broached a scheme for inducing the several French Railway Companies to place at each station a map of the vicinity, with indications of the most notable historical or economical facts connected with the district. It appears that this is the universal practice on Brazilian railway lines.

A THIRD and cheaper edition of the translation of Dr. F. A. Pouchet's work, "The Universe," published by Messrs. Blackie and Sons, has been issued. We reviewed the work in our first volume (p. 259), when we expressed our belief that it would do much to foster a love of pure science in the young. This cheaper edition, though a few illustrations and notes have been omitted, is still a handsome and beautiful work, well adapted for a present to boy or girl.

It is expected that the buildings for the Yarmouth Aquarium will be completed by the 1st of June, 1876. Mr. Saville Kent has been appointed naturalist and manager of the aquarium.

AMONG recent additions to the Manchester Aquarium are nine examples of the Sterlet (*Accipenser ruthenus*) from St. Petersburg,

a species that has hitherto, in this country, been on public exhibition in the living state at Brighton only. The fine Sturgeon obtained from Colwyn Bay for the Manchester tanks some six months since is still doing well.

It is said that the French National Library is to be opened every evening from 8 to 10. It is an important innovation which has been tried with success at the library of the Conservatoire des Arts et Métiers, and has existed for years at the Bibliothèque St. Généviève, in the Quartier Latin, for the use of students.

EXPERIMENTS have been tried with success for using locomotive engines on Paris tramways.

THE International Medical Congress, which this year met at Brussels, will hold its next meeting at Geneva, in September 1877.

THE Italian Expedition for exploring the interior of Africa will leave in January next, and will be absent three years.

THE members of the Metropolitan Scientific Association lately paid a visit to the recent excavations in the Surrey Commercial Docks. One of the most important results of the visit was the discovery of what, on further examination, will doubtless prove to be a line of fault hitherto unsuspected, and if further inquiry confirm the accuracy of the engineer's section, another line of fault will have to be added to future geological maps of this district.

A MOVEMENT has been set on foot at Philadelphia, the Society of Arts *Journal* states, since Mr. Cunliffe Owen's visit to that city, for the establishment of a Museum of Science and Art of a character similar to our own South Kensington Museum.

MR. SERJEANT COX will publish, early in January, the first volume of a treatise on "The Mechanism of Man," being a reproduction, re-written, re-arranged, and greatly extended, of his work entitled "What am I?" which has been for some months out of print.

A PAPER was read at the meeting of the Psychological Society on Thursday week, by Mr. G. Harris, LL.D., F.S.A., vice-president, on "Caligraphy as a test of Character," in which, after remarking on the various modes in which character in each person is exhibited, and on the infinite diversities of handwriting, he adverted to the peculiarities which display character, and illustrated his theory by exhibiting a number of original autographs, including those of Napoleon I., Wellington, Nelson, Brougham, Horne Tooke, Southey, Cowper, Sheridan, Cobbett, Bulwer Lytton, and Charles Dickens, commenting on the contrast between the writing of the two latter. A discussion followed, in which Mr. Serjeant Cox, the President, Prof. Leone Levi, and others took part.

THE additions to the Zoological Society's Gardens during the past week include an Arabian Baboon (*Cynocephalus hamadryas*) from Arabia, presented by Mrs. M. A. Moore; a Pampas Deer (*Cervus campestris*) from Uruguay, presented by Capt. Hairby; a Herring Gull (*Larus argentatus*) European, presented by Mr. P. Gipps; a Western Slender-billed Cockatoo (*Nymphicus pasinator*) from W. Australia, presented by Mr. W. J. Irving; a Golden Tench (*Tinca vulgaris*), European, presented by Mr. S. C. Hincks; a Capybara (*Hydrochærus capybara*) from S. America, two Central American Agoutis (*Dasyprocta punctata*), two Yellow-winged Blue Creepers (*Certhia cyanea*), two All-green Tanagers (*Chlorophonia viridis*), two Naked-throated Bell Birds (*Chasmorhynchus nudicollis*), two Yellow Hangnests (*Cassicus persicus*), a Sulphury Tyrant (*Pitangus sulphuratus*), a Silver Blue Tanager (*Tanagra cana*), a Blue Grosbeak (*Guiraca cyanea*), five Pileated Finches (*Coryphospingus pileatus*), from Brazil; five Darwin's Pucras Pheasants (*Pucras darwini*), from China, deposited.

## SCIENTIFIC SERIALS

THE *Journal of the Chemical Society* for October contains but one paper communicated to the Society, viz., a lengthy communication on the chemistry of tartaric and citric acids, by Mr. R. Warington. The author has had considerable experience in the manufacture of these acids, having been for some years chemist to the factory of Mr. J. B. Lawes. The author's experiments prove that the citric acid of commerce contains one molecule of water corresponding to the formula  $C_6H_8O_7, H_2O$ . Some interesting results have been brought to light in the course of some experiments made with a view to determine the water of crystallisation in various samples of the acid. Thus in one determination a specimen of the powdered acid lost the whole of its water over sulphuric acid in a few days, at a temperature of  $16^\circ$ . In another experiment the powdered acid lost but a mere trace of water *in vacuo* over vitriol for some days, while the same acid heated to  $100^\circ$  lost its normal amount of water. Results of an equally contradictory nature were obtained with various other samples of the acid tried at subsequent periods. It has been proved also that a strong solution of citric acid undergoes considerable contraction when mixed with water.—The next section of the paper relates to the acidity and commercial value of the different lime, lemon, and bergamot juices supplied for the manufacture of citric acid. The nature of some of the acids existing in the concentrated juices is to be made the subject of further research; up to the present time, in addition to citric, formic, acetic, and possibly propionic, acids have been detected. It appears, however, that the organic acids other than citric which exist in the juice are chiefly non-volatile, and have soluble calcium salts. Phosphoric acid has also been found, and there is reason to suspect malic and aconitic acids, the latter being produced by the concentration of the juice. With regard to calcium citrate, it has been found that the amount of water contained in this salt varies according to the mode of preparation, a result demanding further investigation. The author next gives details of the method employed for analysing the citric acid liquors. With regard to tartaric acid, it is found that a strong solution contracts even more than citric acid when mixed with water. The author then proceeds to consider the qualitative reactions of tartaric, metatartaric, and ditartaric acids. Contrary to the statement given in books, it has been found that calcium acetate yields a crystalline precipitate of calcium tartrate, even in dilute solutions of tartaric acid. Free tartaric acid also is precipitated by calcium chloride in the presence of alcohol. The reactions with the acetates of lead and barium have likewise been studied. With regard to the amount of water in calcium tartrate, the author concludes that the salt has no definite composition at  $100^\circ$ . A very complete series of experiments upon the solubility of potassium bitartrate has been made, and the remainder of the paper is devoted to the materials used for the manufacture of tartaric acid, viz. lees, argol, and tartar, and the methods of analysis employed in their valuation. Mr. Warington deserves credit for thus contributing to the general store of knowledge from the experience gained in the chemical factory. A great deal of manufacturing chemistry is at present carried on without any regard to the scientific principles involved, and if manufacturers would only be somewhat more free in communicating apparently inexplicable facts to the scientific world, the advantage gained could not but be mutually beneficial. To quote the author's own words:—"A large amount of information is acquired in the laboratories of our great manufacturing concerns; most of this might be published without any injury to the individual manufacturer. Especially is this true of analytical methods, and the publication and discussion of these would do much to remove the disgrace to which science is often subjected from the wide discrepancies of commercial analyses." We cordially echo the hope "that the publication of these notes may lead to many similar communications."—The remainder of this part is occupied by abstracts of papers from British and foreign journals.

*Poggendorff's Annalen der Physik und Chemie*, No. 10, 1875. In this is given the remaining portion of Prof. Stein's article on the formation of sound; and from his analysis of the motions of tuning-forks he concludes that only displacements of the nature of condensation and rarefaction yield sound: that the strength of the tones depends, among other things, on the size of the sounding mass; and that only transversal or rectilinear excursions produce resonance. With these data he explains a number of phenomena; the disproportionate loudness of forks held near

the ear, &c.—MM. Kundt and Warburg give the concluding part of their researches "On friction and heat-conduction of rarefied gases." After discussing the capability of their apparatus for determining coefficients of heat-conduction, they show that these coefficients are independent of pressure within 150 mm. to about 1 mm. for air and carbonic acid, and 150 mm. to 9 mm. for hydrogen. They tried to produce an actual vacuum in regard to heat-conduction, and by drying to  $200^\circ$  they reduced the conduction to a small fraction of its original value. The co-efficient for hydrogen (in accordance with Maxwell's theory and Stefan's experiments) they found to be 7.1 greater than that of air; while that of carbonic acid was 0.082 of that of hydrogen, which is considerably smaller than by Maxwell's theory.—M. Edlund gives an experimental demonstration that galvanic resistance is affected by the motion of the conductor. He made a current pass in two opposite directions from the middle part of a tube, through water that was sent through the tube; and with a galvanometer proved that the resistance was less where the galvanic current went *with* the liquid one.—There is another electrical paper, in which Dr. Bleekrode recommends ebonite as preferable to glass in many ways for the discs of "electro-machines." He gives a *résumé* of the various modifications of the Holtz machine that have appeared, and describes several observations with the ebonite electro-machines.—M. Gian has a paper on the change of phase of light polarised, through reflection, parallel to the plane of incidence.—M. Emsmann describes a curious phenomenon bearing on binocular vision; while M. Vogel gives an account of spectral observations on the Red Sea and Indian Ocean, and in the blue Grotto of Capri.

*Transactions of the Royal Society of New South Wales* for the year 1874.—This number contains the following, among other papers:—Description of eleven new species of Terrestrial and Marine Shells from North-west Australia, by Mr. John Brazier, C.M.Z.S.—Iron Pyrites, by Mr. J. Latta.—Nickel Minerals from New Caledonia, and Iron Ore and Coal Deposits at Wallerawang, N.S.W., by Prof. Liversidge.—Some of the results of the observation of the Transit of Venus in New South Wales (with diagrams), by Mr. H. C. Russell, Government Astronomer.—The Transit of Venus as observed at Eden, by the Rev. Wm. Scott.

*Bulletin de l'Académie Royale des Sciences*, tom. xl. No. 8.—The two original communications in the "Classe des Sciences" are a long article on arithmetical operations, by J. C. Houzeau, and a description of some fossil plants from the "Poudingue de Burnot" (Lower Devonian), by Dr. A. Gilkinet. The two species are *Filicites pinnatus* (Coemans) and *Filicites lepidorachis* (Coemans), which latter Dr. Gilkinet removes from the Ferns and places among the Lycopods, under the name *Lepidodendron Burnotense*. There are three plates of figures.

## SOCIETIES AND ACADEMIES

## LONDON

Royal Society, Nov. 19.—"On the Physiological Action of Vanadium," by John Priestley, Platt Physiological Scholar, the Owens College, Manchester. Communicated by Prof. Gamgee, F.R.S.

Thirty-one experiments are detailed, in which frogs, a pigeon, guinea-pigs, rabbits, dogs, and cats were made use of. From these experiments it is gathered:—

1. That vanadium is a poisonous substance.
2. That the symptoms of poisoning are, in general, similar, whatever the method of the introduction of the salt into the animal system.
3. That the symptoms of poisoning which appeared in one or other of the various classes of animals above mentioned are: paralysis of motion; convulsions, local or general; rapidly supervening drowsiness, or indifference to external circumstances; congestion of alimentary mucous membranes; discharge of sanguinolent fluid feces; presence of glairy, fluid mucus in the intestines after death; certain changes in respiration, and, coincidentally, a fall in temperature; drowsiness and feebleness of pulse. In addition the heart was always irritable after death; consciousness and sensibility to pain seemed unimpaired; and no diminution could be detected in the powers of muscle and nerve to respond to stimulation.

4. That the lethal dose for rabbits lies between 9.18 mgr. and 14.66 mgr. of  $V_2O_5$  per kilogram of rabbits.

The author details a number of experiments undertaken with



the view to gain more exact information as to the action of the salt of vanadium upon particular functions. The methods of experiment and the precautions observed are fully described.

Chemical Society, Nov. 18.—Prof. Abel, F.R.S., president, in the chair.—The Secretary read a paper by Mr. T. M. Morgan, on ethyl-phenyl acetylene.—The second communication, on narcotine, cotarnine, and hydrocotarnine, Part 2, by Mr. G. H. Beckett and Dr. C. R. A. Wright, is a continuation of their investigations of this subject.—Mr. W. Noel Hartley then gave an account of the presence of liquid carbon dioxide in mineral cavities, in which he proves, from the physical properties of the liquid enclosed in a cavity of a quartz crystal in his possession, that it is carbon dioxide.—The last paper, by Mr. W. H. Perkins, was a preliminary notice on the formation of coumarin, cinnamic and other similar acids.

Meteorological Society, Nov. 17.—Dr. R. J. Mann, president, in the chair.—Sergeant James Conroy, R.E., Morris Jones, L.R.C.P., A. H. Leycester, Sir David L. Salomons, Bart., and James P. H. Walker, were balloted for and duly elected Fellows of the Society. The following papers were then read:—Some remarks on the reduction of barometric readings with a form of table for combining the corrections for index-error, temperature, and altitude, by William Marriott. Readings of the barometer to be of any scientific value must be corrected for index-error, temperature, and height above mean sea-level. There is not much difficulty in applying the first two, but it is a very troublesome thing to obtain the proper corrections for altitude if the station be more than 100 feet above sea-level. The author has found that a great number of observers make some very extraordinary mistakes in applying this correction, and gives a few as specimens. He attributes the difficulty in applying this correction to the unsatisfactory explanation accompanying the tables as given in the different manuals on meteorology and to the fact of the corrections being only given for two pressures, viz., 27 inches and 30 inches. He then submits a table which gives the sea-level pressure on the left hand and the reading of the barometer at the station corresponding to that pressure on the right hand, with the altitude correction between them. In conclusion he submits a form of table in which is combined the corrections for index-error, temperature, and height above sea-level, which is the means of saving much time, besides reducing the liability to error.—On a continuous self-registering thermometer, by W. Harrison Cripps. The thermometer consists of six coils of glass tubing, the first five being wound concentrically round an axis, each coil lying within the other, in such a manner as to form a spiral glass wheel 4 inches in diameter. The sixth coil is moved slightly away from the others, so that it shall form the circumference of a circle 5 inches in diameter, the centre being the axis around which the spiral tube is coiled. Pivots are attached to either end of the axis, which rest on two parallel metal uprights. The tubing is filled with spirit, and mercury and a small quantity of air are enclosed in the large coil. The thermometer works in the following manner: when the spirit contracts on cooling, the expansion of the included air keeps the column of mercury in contact with it; this immediately alters the centre of gravity, and the wheel begins to revolve in a direction opposite to that of the receding mercury. On applying heat, the mercury passes forwards and the wheel moves in the opposite direction. The thermometer is made to record somewhat in the same way as the recording aneroid barometer.—On a self-regulating atmometer, by S. H. Miller, F.R.A.S. After several years' experimenting with evaporating dishes of different forms under various conditions, the author has arrived at the conclusion that none of the contrivances which have come under his own observation are entirely satisfactory. After remarking upon the conditions which a good evaporator should fulfil, he proceeds to describe a self-regulating one which he has devised and which has now worked satisfactorily for several months. The apparatus consists of an open cylinder 8 inches diameter, surmounted by a brass rain-gauge rim which receives the water from which the evaporation takes. This vessel is surrounded by another cylinder 15 inches in diameter and closed at the top, which is divided into two compartments, upper and lower. The upper one is filled with water to keep the level in the inner cylinder always constant, and the lower one receives the overflow rainfall. The amount of evaporation is determined by weighing the apparatus.

Zoological Society, Nov. 16.—Mr. Osbert Salvin, F.R.S. in the chair.—Mr. Sclater exhibited the upper horn of a Two-horned Rhinoceros that had been shot in March last by Lieut.

Col. C. Napier Sturt, in the valley of the Brahmapootra. Mr. Sclater remarked that this seemed to prove conclusively the existence of a two-horned species of Rhinoceros in Assam, which would probably turn out to be the same as that from Chittagong, now living in the Society's Gardens.—Mr. Sclater read an extract from a letter addressed to him by Dr. N. Funck, director of the Zoological Gardens, Cologne, stating that the bird figured in Mr. Sclater's recent article on the Curassows as *Pauxi galati* var. *rubra*, was the true female of *Pauxi galata*.—Mr. H. Seebohm exhibited and made remarks on a series of rare and interesting birds and eggs from the tundras and deltas of the Petchora River, North-eastern Russia, collected there by Mr. J. A. Harvie Brown and himself during the present year.—Mr. A. H. Garrod read some notes on the Manatee (*Manatus americanus*) recently living in the Society's Gardens.—Dr. Günther, F.R.S., read a third report on the collections of Indian reptiles obtained by the British Museum, and gave descriptions of several species new to science.—A communication was read from Mr. E. Pierson Ramsay, containing a list of birds met with in North-eastern Queensland, chiefly at Rockingham Bay.—A second communication from Mr. Ramsay gave a description of the eggs and young of *Rallina tricolor*, from Rockingham Bay, Queensland.—A third communication from Mr. Ramsay contained the description of a new species of *Pæcilodryas*, and a new genus and species of Bower Bird, proposed to be called *Scenopaus dentirostris*, from Queensland.—A communication was read from Mr. Sylvanus Hanley, containing the description of a new *Cyclophorus* and a new *Ampullaria*, from Burmah.—A communication was read from Dr. J. S. Bowerbank, F.R.S., containing further observations on *Alcyonellum spaciosum*, Quoy et G., and *Hyalonema mirabilis*, Gray.—Mr. Arthur G. Butler read a paper on a collection of butterflies from the New Hebrides and Loyalty Islands, and gave descriptions of some new species.—A second paper by Mr. Butler contained particulars of a small collection of butterflies from Fiji. Mr. Butler also read the descriptions of several new species of Sphingidæ.—A communication was read from Mr. W. H. Hudson, containing remarks on Herons, with a notice of a curious instinct of *Ardetta involucris*.—A communication was read from Dr. Otto Finsch, in which he gave the description of a new species of Crowned Pigeon from the southern end of New Guinea, opposite Yule Island. Dr. Finsch proposed to call this bird *Goura scheepmakeri*, after Mr. C. Scheepmaker, of Soerabaya, who had transmitted a living specimen of it to the Zoological Gardens, Amsterdam.

Entomological Society, Nov. 3.—Sir Sidney Smith Saunders, C.M.G., president, in the chair.—This being the first meeting of the session in the new rooms of the Society at 11, Chandos Street, Cavendish Square, the President delivered an inaugural address, pointing out the advantages which might be expected from the library and meeting-room being brought into juxtaposition on a more central site; and also from the library being open to members during three days in each week instead of one day only.—Mr. Oscar Lamarche, of Liège, was elected a foreign member.—Mr. W. C. Boyd exhibited mines of *Heliosela sericella* in oak. He had succeeded in rearing the insects by confining them with a young oak plant, and thus was enabled to discover their habits, which had hitherto been unknown. The mines were situated in the footstalks of the leaves.—Mr. M'Lachlan exhibited a living apterous female of a terrestrial Trichopteran insect, *Enoicyla* (probably *E. pusilla*, Burm.) He had recently bred it, with others, from cases forwarded to him by Mr. Fletcher, of Worcester, the discoverer of the insect in this country. Mr. M'Lachlan gave an account of its structure and singular habits. The perfect insects emerge in November, and the males are furnished with ample wings.—Mr. Champion exhibited several rare Coleoptera captured by him in Kent and Surrey.—Mr. Phipson exhibited a *Catocala nupta*, with several *Acaris* on a portion of one of the anterior wings, instead of on the body, as is usually the case.—The Rev. H. S. Gorham read descriptions of some new species and a new genus of *Endomyzidi*.—Mr. Arthur G. Butler communicated "a list of the Lepidoptera referable to the genus *Hypsa* of Walker's list, with descriptions of new genera and species."—Mr. Edward Saunders communicated a second part of his Synopsis of the British Hemiptera Heteroptera.—Mr. Charles O. Waterhouse read descriptions of some new genera and species of Heteromorous Coleoptera (*Haopidae*), chiefly from Terra del Fuego. The specimens had been brought to this country by Mr. Charles Darwin, and had been described many years ago by Mr. Water-

house, sen., but the manuscript had been unfortunately lost, and the insects had remained unnoticed till the present time.

## BERLIN

German Chemical Society, Nov. 8.—A. W. Hofmann, president, in the chair.—J. Landauer described a blowpipe-apparatus consisting of two bottles, one of which contains air, while the other, filled with water, is placed above and is connected by a tube with the air-bottle. The water replacing the air produces the blast.—T. Grabowsky has found amongst the products chlorine forms with acetone, a liquid of the formulæ  $C_6H_7Cl_3O$ , and another liquid  $C_6H_7Cl_3O$  (trichlorinated oxide of mesitylene).—The same chemist has studied anew the transformation of chloral into chloralid and solid chloral.—P. Griess has obtained betain by the action of iodide of methyl on glyocol.—S. P. Sadler appears to have transformed glycerine into tartroic acid by means of diluted fuming nitric acid.—V. von Richter reverted to a reaction formerly observed by him, through which nitrobromobenzol and cyanide of potassium form cyanobromobenzol, and consequently a bromobenzoic acid, of which the acid group  $CO_2H$  is *not* corresponding in position to the nitro-group of the original compound. He has repeated the experiment with bibromo-nitro-benzol, and finds corresponding exchanges to take place in their case. He also described the formation of certain di-tri- and tetra-bromo-benzols.—F. Beilstein and A. Kurbatov, by adding chloride of antimony to nitrobenzol and passing chlorine gas into it, have obtained a good yield of meta-chloronitrobenzol and higher chlorides.—T. A. Roorda Smit prepares acetate of ammonium and acetamide by means of carbonate of ammonium. The same fluids, nitrobenzol and sulphite of ammonium, yield anilosulphite of ammonium  $C_6H_5NHSO_3NH_4$ . The same chemist has found thioanilide,  $C_6H_5NH-S-NHC_6H_5$ , a yellow oil, amongst the products of the reaction of chloride of sulphur on aniline.—Ira Remsen communicated researches on the action of potassium on succinate of ethyl and on the action of ozone on carbonic oxide.—The President then read to the meeting an autobiographical sketch by F. Wöhler, not intended for publication, of which the following is an extract:—His father, as well as a friend of the family, encouraged his pleasure in collecting natural objects, and experimenting. In 1814 he was sent to the grammar-school of Frankfort. He was backward particularly in mathematics, partly because he was constantly occupied in collecting minerals. Dr. Buch in Frankfort was his first serious instructor in chemistry. Buch published remarks on selenium conjointly with Wöhler. Hagen's old treatise, based on the phlogistic theory already used by his father, was his first guide, but was soon exchanged against more modern views and books. His room was changed into a chemical laboratory; he learnt to engrave on copper, and collected antiquities; but his great pleasure was the construction of a Volta-battery of 100 couples and the reduction of potassium by means of it, as well as by heat alone. He was fond of bodily exercises, such as swimming and shooting. In 1820 he went to the University of Marburg, but was offended by one of the professors, who forbade his making chemical experiments while he was studying medicine! He therefore continued his studies in Heidelberg. The great physiologist Tiedemann became his friend, and he published researches on the change that organic acids undergo through passing the human body. He obtained a prize for this paper, and used it for his dissertation as Doctor of Medicine. He still had the intention of entering into the practice of a profession. He worked in Gmelin's laboratory, but never heard any lectures on chemistry. The sketch does not enter into his life in Sweden, described in a former paper. After returning from Sweden his friendship with Liebig commenced in Frankfort, to cease only with Liebig's death. In 1825 Leopold von Buch proposed him as teacher of chemistry of the newly founded School of Industry (Gewerbeschule) at Berlin. He accepted the place, and was named Professor in 1828. He derived great benefit from living in friendly intercourse with Magnus, H. and G. Rose, and Mitscherlich. He remembers with enthusiasm the influence of Humboldt and his eloquence. Humboldt was president of the Association of Natural Philosophers at Berlin, and the contrast between his never-ceasing flow of language and the silence of Berzelius is humorously described in the following anecdote. During an excursion of the Association, Wöhler had to take his seat, as he says, on account of his thinness, in a carriage nearly filled already by the stoutest members of the Association, viz. Humboldt and Berzelius. The former held forth with his usual readiness, when Berzelius suddenly broke out in Swedish: "Mr. Wöhler, what

eloquence! I cannot stand it any longer!" Fortunately Humboldt's all but universal knowledge did not comprise the Swedish language. In Berlin Wöhler published his text-book (Grundriss) of chemistry, at first anonymously. Soon afterwards he left Berlin for Cassel. In 1829 he visited France together with Magnus; in 1835 England. In 1836 he was named successor of Stromeyer as Professor of Chemistry in Göttingen.

## PARIS

Academy of Sciences, Nov. 15.—M. Frémy in the chair.—The following papers were read:—On meridian observations of small planets at the Greenwich and Paris Observatories during the third trimestre of 1875, by M. Leverrier.—On the density of pure platinum and iridium and their alloys, by MM. Sainte-Claire Deville and H. Debray. The numbers obtained (about 21.5 for platinum and 22.4 for iridium) are higher than those found hitherto.—Researches on the composition of dissolved acids and salts, by M. Berthelot.—Memoir on measurement of the affinities between liquids of organised bodies by means of electromotive forces, by M. Becquerel. He studies the electromotive force obtained from the white and the yolk of an egg, from the arterial and venous blood of dogs, and from each of these with albumen, the reactions between plant liquids, and between them and animal liquids, the electro-capillary effects of sulphurous liquids in contact with liquid exuded from the skin, &c.—Examples of the contemporaneous formation of iron pyrites in thermal springs and in sea water, by M. Daubrée.—On the capillary theory according to the Amaryllidæe (Part 1, Alstræmeria), by M. Trécul.—Fifteenth note on the electric conductivity of moderately conducting bodies, by M. Du Moncel.—M. Janssen presented four cases of natural history specimens from the Japanese Government.—On the representation of figures of geometry of *n* dimensions by correlative figures of ordinary geometry, by Mr. Spottiswoode.—On the development of the fruit of Coprin, and the supposed sexuality of the Basidiomycetes, by M. van Tieghem.—Theory of hail, by M. Cousté.—On the employment of nickel deposited electrically to protect the magnets of compasses against oxidation, by M. Duchemin.—Application of the principle of analytic correspondence to the demonstration of the theorem of Bezout, by M. Saltel.—Observations of the planet Jupiter, by M. Flammarion. He notes (*inter alia*) the appearance of white elliptic spots followed by shadows. Some sketches are given.—On some combinations of titanium, by MM. Friedel and Guérin.—Solution of platinum in sulphuric acid during the industrial process of concentration, by M. Scheurer Kestner.—On the presence of a new alkaloid, ergotinine, in spurred rye, by M. Tanret.—On the rôle of carbonic acid in the phenomenon of spontaneous coagulation of blood, by M. Glénard.—Reply to M. Mathieu and Urbain's last note on the same subject, by M. Gautier.—On the embryogeny of the flea, by M. Balbiani.—On larval forms of Bryozoa, by M. Barrois.—Note on the storms of November 6 to 11, 1875, by M. Marié-Davy.

## CONTENTS

	PAGE
THE OXFORD BOTANIC GARDEN . . . . .	61
Lommel on Light. By W. F. B. ( <i>With Illustrations</i> ) . . . . .	62
DAKWIN ON CLIMBING PLANTS . . . . .	65
OUR BOOK SHELF:—	
Willson's "Report of the Meteorological Reporter of the Government of Bengal" . . . . .	64
LETTERS TO THE EDITOR:—	
Oceanic Circulation.—JAMES CROLL . . . . .	66
Refraction of Light and Sound through the Atmosphere.—Dr. ARTHUR SCHUSTER . . . . .	67
Evidences of Ancient Glacier Action in Central France.—Rev. W. S. SYMONDS . . . . .	67
Communication of Information among Bees.—Prof. H. BLACKBURN . . . . .	68
A New Palmistry.—J. C. GALTON, F.Z.S.; F. T. MOTT; R. A. N. . . . .	65
Extraordinary Tides.—B. G. JENKINS . . . . .	69
Further Linkage Work.—Geo. J. P. GRIEVE . . . . .	69
A Criminal Dog.—R. S. CULLEY . . . . .	69
OUR ASTRONOMICAL COLUMN:—	
The Binary Star 44 Bootis . . . . .	69
The Minor Planets . . . . .	69
The Zodiacal Light . . . . .	69
THE RAINFALL . . . . .	70
THE WORK OF THE "CHALLENGER." By Prof. WYVILLE THOMSON, F.R.S. . . . .	70
ACOUSTIC CLOUDINESS. By Prof. J. TYNDALL, F.R.S. . . . .	72
CHARLES BLACKER VIGNOLES, F.R.S. . . . .	73
THE GERMAN COMMISSION ON ARCTIC EXPLORATION . . . . .	73
THE FAUNA OF THE CASPIAN SEA . . . . .	74
NEW FORM OF TUBE FOR OBSERVING THE SPECTRA OF SOLUTIONS. By MM. DELACHANAL and MERMET ( <i>With Illustration</i> ) . . . . .	74
SCIENCE IN GERMANY . . . . .	75
NOTES . . . . .	75
SCIENTIFIC SERIALS . . . . .	76
SOCIETIES AND ACADEMIES . . . . .	78

THURSDAY, DECEMBER 2, 1875

THE GOVERNMENT AND THE POLLUTION  
OF RIVERS

*Pollution of Rivers. What Means can be adopted to prevent the Pollution of Rivers?* A Paper read at the Social Science Congress, Plymouth and Devonport, September 1872, by William Hope, V.C. (London, 1873.)

*Food Manufacture versus River Pollution.* A Letter addressed to the Newspaper Press of England, by the same Author. (London: Stanford, 1875.)

THE question of River Pollution, one of undoubted importance to the country at large, has been once again raised by Mr. Hope, so well known for his untiring zeal in the cause of sewage farming, in the two above-named pamphlets. As involving questions of science—or at least of applied science—we feel called upon to offer some remarks upon the subject, the more so as it is one having such unquestionable sanitary bearings as to have been made the subject of Select Committees, Royal Commissions, and of at least three Parliamentary Bills.

We shall in the first place give a brief abstract of Mr. Hope's pamphlets, in order to lay before our readers the present state of the sewage question, before proceeding to consider the manner in which the subject has been handled by the Legislature.

In the first-named pamphlet the author passes in review the chief processes which have been proposed for preventing the pollution of rivers by sewage, classifying all systems under two divisions—"those which profess to deal with part only of the sewage, and those which profess to deal with the whole." The inefficacy of the former is summed up in the following words (page 5):—

"But supposing that they really accomplished all they are intended to effect, the sewage question would still be as far from solution as ever, for the part of the total refuse which they profess to deal with is only about a half per cent. of the whole."

Of processes professing to deal with the whole of the sewage the first noticed are those precipitation schemes in which the sewage matter is supposed to be precipitated by the addition of some chemical substance. The so-called "A B C" process is considered at some length, and its not very creditable history traced; analyses of the various precipitating mixtures employed by this company are given, beginning with that first employed which the author distinguishes as "Moses" (because stated by the patentee to have been first revealed to Moses in the wilderness and communicated by him to the children of Israel!), and concluding with that in use at Leeds at the time of reading the paper.

When we state that this mixture consists of alum, blood, clay, and charcoal refuse from Prussian blue works, our readers will at once perceive the justice of the sentence pronounced by Mr. Hope—that none of the ammonia in solution is precipitated, but runs away in the effluent water. We may furthermore recall to mind the fact that the process as carried on at Leicester and Leamington, with a mixture containing the same ingredients in different proportions, was made the subject of an exhaustive inquiry by the Rivers Pollution Commis-

sion, and justly condemned by that body in their second Report, on the grounds of its failing to remove the organic polluting substances in the state of solution. The same objections are applicable to Forbes' phosphate of alumina process, and to Anderson's process, which are the next considered. Mr. Whitthred's phosphate of calcium process is spoken of somewhat more hopefully, although at the time of reading the paper it was in a very early stage of development, while Weare's peat charcoal process is unhesitatingly condemned—"the effluent water resulting from it is, as a matter of fact, still sewage."

General Scott's hydraulic cement process, which consists in precipitating lime and clay in the sewage, is effective in clarifying and to a great extent deodorising the sewage by the removal of suspended matters in the form of "sludge," but from a sanitary point of view the sewage question is untouched, as the inventor does not profess to deal with the effluent water.

The purification of sewage by its direct application to land as effected by irrigation next receives consideration, the author pointing out that this is really an effective means of disposing of sewage—a statement fully borne out by every scientific authority who has examined into the method. Without at present entering too fully into details, we may state that the author's experience has led him to the conclusion that the successful treatment of sewage as a manure depends upon its thorough intermittent downward filtration through the soil, with due precautions against overflowing the land. By those who have followed the question from the beginning, it will be remembered that the chemical principles of "downward intermittent filtration" were first discovered in the laboratory of the Rivers Pollution Commission, and its efficiency made known in their first Report. The chemistry of the process, it is scarcely necessary to add, is accelerated oxidation, and Mr. Hope had been independently led to adopt this principle as applied to irrigation on an experimental sewage farm at Romford. The remainder of the pamphlet is chiefly devoted to what we cannot but consider as a fruitless discussion upon the precise meaning of the terms "irrigation" and "intermittent downward filtration," it being contended that the two processes are really identical—an opinion in which we feel constrained to differ from the author, since, although the involved principles are most probably the same, the methods of application are essentially different. The results of the early experiments upon the Romford farm were made known to the British Association Committee at the Brighton meeting, and are thus summarised by the author:—

"Although the soil is exceedingly siliceous, and ill-adapted for the retention of manure, yet out of every 100 parts of nitrogen applied in the sewage, no less than 40 were actually converted into crops, 50 parts were unaccounted for (remaining chiefly in the soil), and only 10 parts escaped in the effluent water, of which again only a fraction was still in an organic form."

The second pamphlet is a spirited appeal to the press to take up the sewage question, but as it relates chiefly to the financial aspect of the matter, it is not well adapted for abstracting in these columns. It may be stated, however, that the author therein admits that he has met with heavy losses in the working of the Romford farm, because, in his own words, "he has not had the sewage of Romford to convert." The original outlay, it seems, had been based

upon the assumption of his receiving the sewage from a population of 8,000, instead of which the amount actually received was that due to a population of about 3,000.

Mr. Hope has thus done excellent service in continually directing attention to and practically demonstrating, often at great pecuniary sacrifice, the applicability of the irrigation scheme to the disposal of sewage. It is true that the Towns Sewage Commission of 1865, in their third Report, did not speak favourably of the process, stating that their analyses proved that the effluent water from the Rugby works contained about the same quantity of dissolved organic impurity as the raw sewage, but it is now known that the process of analysis employed by them gave fallacious results, and analyses by the Rivers Commission (First Report) show that the process removes an average of 81·7 per cent. of the nitrogen, and 68·6 per cent. of the carbon contained as *dissolved* organic impurity, and 97·7 per cent. of the *suspended* organic pollution.

So much for irrigation. The other plan recommended by the Commission, Frankland's "downward intermittent filtration," is equally if not more effective. An average of 87·6 per cent. of nitrogen and 72·8 per cent. of carbon contained as *dissolved* organic pollution is removed by the operation, and *all* suspended impurities. We may further state that the plan has been applied by Mr. Bailey Denton to the sewage of Merthyr Tydvil, and has been in successful operation at that town for a period of three years.

Two effective schemes for the treatment of sewage—either of which might be employed according to the locality—are thus offered, so that, the sewage question being practically settled, let us now consider the action of the Government in the matter.

It is at least fifteen years since the efficacy of irrigation was first made known, and seven years since the discovery of intermittent filtration. In a letter on the sewage question published in 1865 by Mr. Hope, it is stated that "there have already been six Select Committees and two Royal Commissions on the question, independently of the Main Drainage Committee of the Metropolitan Board of Works, which has investigated the subject for five long years, and these Committees and Commissions have published no less than ten reports." A Rivers Pollution Commission was formed in 1865 and replaced by another in 1868, which continued its work down to 1874. These Commissions have cost the country from 40,000*l.* to 50,000*l.*, and in their laboratory the various processes devised for the purification of sewage and other foul liquids have been quantitatively examined and the results made known in no less than nine consecutive reports. Remedies for the different forms of pollution have been clearly and consistently pointed out, and various recommendations suggested for legislation. The standards of polluting liquids proposed by the Commission to be fixed by Act of Parliament have been substantially approved of both by English and Continental chemists of eminence. Now the members of a Royal Commission are presumably appointed because specially qualified for the inquiry, a presumption which has been amply testified in the case of the Rivers Commission. Notwithstanding this—notwithstanding that a code of standards has been proposed for legislative enactment—in spite of the fact that practical and efficient remedies do already exist for the [disposal of sewage,

down to the present time nothing whatever has been done by the Government. The Duke of Northumberland's Bill of 1873 embodied, it is true, all the recommendations of the Rivers Commission, but, most wonderful to relate, in the Rivers Pollution Bill brought in last session, the whole of the work done by that Commission is totally ignored; and the Bill moreover shows that its framers were totally unacquainted with the advancement of science in this direction during the last twenty years.

Confronting these facts with a statement in Mr. Hope's second pamphlet, that "the Registrar-General's returns, confessedly incomplete from various causes, show that 'sanitary authorities' have been killing by means of enteric fever no less than 14,000 persons per annum," we now leave the subject to the serious consideration of the Legislature.

### THE MANCHESTER SCIENCE LECTURES *Science Lectures for the People, delivered in Manchester.*

First, Second, Third, Fourth, Fifth, and Sixth Series.  
1866-74. 3 vols. (Manchester: Heywood.)

IT is now nine years since Prof. Roscoe made the bold experiment of ascertaining whether the working men of Manchester would appreciate the value of scientific instruction given in a plain but correct manner, and illustrated by suitable experiments and diagrams. The magnificent success that attended the early efforts of Prof. Roscoe has led the experiment to be repeated yearly until it is now, we hope, a settled institution. In the preface to one of the series we learn that each lecture, on an average, has been attended by nearly 1,000 persons, and an additional and wider audience has been secured by the verbatim reports of the lectures which are bound together in the volumes before us. Published at a penny each, from 5,000 to 10,000 of each of these lectures have been sold, and the demand for back numbers still continues.

Certainly it is to be hoped, as Prof. Roscoe remarks, "that the example of Manchester may be followed by other large towns, for surely nothing can at the present time be more important than to infuse into the minds of the people an idea of that scientific truth which is rapidly being recognised as not only lying at the foundation of our material welfare, but also of our social and moral well-being." We are aware that many of our large towns are doing good work in this direction by the lectures regularly arranged in connection with some local institution; witness, for example, the immense audiences attracted by the admirable lectures yearly given in connection with the Midland Institute at Birmingham. But the lectures at these and similar institutions are chiefly frequented by the middle classes, whereas we are assured that at the Manchester lectures the class of persons present was chiefly working men, for whom the lectures were designed, and who by their marked attention and interest invariably showed how keenly they appreciated the information that was given. It is said that to make working-men lectures a success, a very low entrance fee must be charged, and this involves a pecuniary loss that must be met by local subscriptions. This must necessarily be true of the first course or two, when the people will not pay for that of which they have had no experience. But

we question the wisdom of not allowing these Manchester lectures to be self-supporting. Working men are now absolutely better paid than the great majority of clerks and *employés* in the Civil Service, and their expenditure is less heavily taxed than those who esteem themselves in a higher social scale. Mechanics and others can therefore well afford to pay whatever is necessary for these lectures, and we cannot but think it is an unwise thing to establish the idea that fustian can have for a penny what is charged sixpence or a shilling to cloth. If a penny entrance-fee is too firmly rooted to be dislodged with impunity, boxes might be put in the room for contributions by the audience, who might be urged to make the lectures self-supporting. Moreover, the profits on the sale of these reports of the lectures must be large and ought to go some way towards meeting the expense of the lectures themselves. After all, the main secret of success in any popular lecture scheme is to have some one responsible person, like Prof. Roscoe, who, year after year, has unsparingly used his influence and his time in this good cause.

We must add a few words about the books before us. When upon opening our parcel we found the editor of NATURE had sent us these lectures with a request for a review of them, we felt he had set us to a hopeless task. What sane solitary reviewer dare venture to criticise the collective wisdom of Professors Huxley, Tyndall, Roscoe, Gladstone, Geikie, Balfour Stewart, Odling, Clifford, W. C. Williamson, Wilkins, Ward, Jevons, Drs. Carpenter and Huggins, Mr. Spottiswoode, Sir John Lubbock, and other famous men who make up the brilliant array of Manchester lecturers?

It is hardly needful to say that all the lectures in these volumes are good, and some well repay careful perusal. Many of the lectures are so fascinating that it is difficult to put the volumes aside. What, for instance, can be more charming than Prof. Geikie's lecture on the Ice Age in Great Britain, or Sir John Lubbock's lecture on Modern Savages, or Prof. Stewart's on the Sun and Earth? And we envy those who were present at such experimental lectures as Prof. Tyndall's on Crystalline Forces, Prof. Abel's on Gun Cotton, or at Prof. Roscoe's or Dr. Huggins', and others we have not space to name. The books before us are therefore well worth preserving, for though the lectures are popular they are in no instance claptrap; and whilst within the comprehension of all classes, they will also be found not unworthy of perusal by men of culture.

Mr. Pitman, who reported the lectures, has evidently done his work faithfully and well, and Mr. Heywood who publishes them has clothed the volumes in a new and attractive dress.

We would venture, however, to suggest to Prof. Roscoe—whose name at the foot of each preface is the only editorial mark—that it would be desirable to have a responsible editor when such permanence, as these volumes indicate, is given to the lectures. Reading one of Dr. Carpenter's lectures, for example, there is a continual reference to diagrams and maps which, though present to the audience, are not so to the reader; and to some other lectures the same remark applies. Moreover, before binding up the lectures, the authors, we think, ought to have been informed that a volume was to be

issued, and so the opportunity afforded them of making any corrections or additions to their lectures they might find necessary. Then a better table of contents of each volume would be an advantage, and the names of the lecturers should be attached to the titles of the lectures in the contents. In the first series the names of those who gave the short courses on Chemistry, Zoology, and Physiology are entirely omitted both in the index and in the lectures themselves. A reader opening on p. 119 of the first volume finds the course on physiology beginning, "The subject, my friends, upon which I am going to speak to you this evening, &c.," but who the speaker is he will be perplexed to find. Incidentally the omitted names happen to be mentioned by Prof. Roscoe in the preface. Such little matters as these might readily be amended by proper care on the part of the publishers.

W. F. B.

#### RECENT AUSTRALIAN EXPLORATIONS

*Explorations in Australia; with an Appendix on the Condition of Western Australia.* By John Forrest, F.R.G.S. (London: Sampson Low and Co., 1875.)

DURING the last three years there has been an admirable activity among the Australian colonists in the exploration of the great tract of unknown land in the centre of the southern continent. It was long ago surmised that this interior was either occupied by a great lake or lakes, or was in the main a barren desert, but only within the last two years has its real condition been conclusively demonstrated. The most prominent names in recent exploration are those of Giles, Gosse, Ross, Lewis, Warburton, and Forrest. The first two were baffled in their attempts to cross the country; even though Gosse was provided with camels, he only reached close on the 130th degree of E. long. when he had to return eastwards. Ross, in 1874, explored a considerable previously unvisited tract to the S.W. of the Neale River, while Lewis explored, in 1874-5, the region to the W., N., and N.E. of Lake Eyre. Col. Warburton has the honour of having been the first to cross the country, starting from Alice Springs on the telegraph line in April 1873, and eight months after, reaching the west coast. His narrative we noticed in vol. xii. p. 46. Mr. John Forrest though yet a young man, has perhaps done more than any recent explorer to make known the real nature of the hitherto unknown or imperfectly known regions. He is, we believe, a native of West Australia, a member of the Colonial Survey, and well qualified in every respect for the trying task of Australian exploration, and the Colonies would do well to make liberal use of his services in order to obtain a satisfactory idea of the resources of their country.

The volume before us contains an account of three separate exploring journeys made by Mr. Forrest. The first of these was a comparatively short trip to the north-east from Perth, as far as the 123rd degree of E. long., accomplished between April and August 1869. The object of this journey was to endeavour to find some traces of the unfortunate Leichardt, who twenty-seven years ago quitted Moreton Bay to cross the continent, but whose fate is still a mystery. We need hardly say that Mr. Forrest's journey was in vain, so far as this

object is concerned, though he brought back much valuable information concerning the country traversed. The latter portion was over comparatively unknown ground; and Mr. Forrest discovered a remarkable series of salt lakes extending from about 119° to 122° E. long., and between 28° and 29° S. lat. The country is somewhat hilly along the 29th parallel, with granite and sandstone rocks. Here he was on the edge of the dreary spinifex desert which has daunted so many explorers.

Mr. Forrest's second journey was a much more important and extensive as well as hazardous one; it was indeed along the same route as that in which the dauntless Eyre suffered so terribly thirty-five years ago. With a small party, and after making excellent arrangements with a vessel to meet them at a certain point, he set out from Perth on March 30, 1870, came S.E. to the coast, and travelled along the great Australian Bight, reaching Adelaide on Aug. 24, without loss. He kept considerably more inland than did Eyre, and was in every respect more fortunate, though there was frequently considerable suffering from want of water. His report of the country traversed is much more favourable than Eyre's; large grassy tracts, extending many miles inland, being found along nearly the whole length of the Bight. Water is the great want, yet, since Forrest's journey, settlers have been attracted to the region, and we believe preparations are being made to connect West Australia with the eastern colonies by means of the telegraph.

Mr. Forrest's third journey was a much more formidable undertaking, and in all respects of more importance than either of the two previous ones. Its object was to discover decisively the real nature of the mysterious interior, and thus make an important contribution to scientific knowledge, as well as to let the Australians know what are the resources of their immense continent, not much less in area than continental Europe. The expedition was carefully organised, though it did not cost much above 600*l.*, and consisted of four white men, two blacks, and a large number of horses to carry provisions, equipment, &c., as well as for riding. The party set out from Perth on March 18, 1874, and after reaching 26° S. lat. in 117° E. long., proceeded in a generally eastward direction along that parallel, until on Sept. 27 the telegraph line was struck in 27° 7' 50" S. lat. Mr. Forrest's route was thus on an average about 400 miles S. of that of Colonel Warburton. After the first few entries in his journal, Mr. Forrest's narrative becomes somewhat tedious from its sameness, though the intelligent and energetic leader is not to blame for this. As has been the case with nearly all previous inland Australian expeditions, the daily occupation of the present one was to hunt for water; this is the burthen of every day's entry in the journal. Mr. Forrest has the same tale to tell as Colonel Warburton had of the more northerly route—apparently endless spinifex plains, varied with sand-hills, sandstone cliffs, granite rocks, a few trees, and, in Forrest's case, with rare grassy plains, but with scarcely enough of water all the way to fill a fair-sized mill-pond. Forrest's party, however, notwithstanding that they had no camels, fared much better, both in the matter of food and drink, than did Warburton's; only one of the horses actually died, and comparatively few had to be abandoned. Once only were they attacked by the natives, who were dis-

persed by a shot or two that did little damage. Not many natives were met with, though signs of them were frequently seen, and they seem to have been watching the expedition along most of the route.

Mr. Forrest sums up the results of his third journey as follows:—

"The whole of the country, from the settled districts near Champion Bay to the head of the Murchison, is admirably suited for pastoral settlement, and in a very short time will be taken up and stocked; indeed, some already has been occupied.

"From the head of the Murchison to the 129th meridian, the boundary of our colony, I do not think will ever be settled. Of course there are many grassy patches, such as at Windich Springs, the Weld Springs, all round Mount Moore, and other places; but they are so isolated, and of such extent, that it would never pay to stock them. The general character of this immense tract is a gently undulating spinifex desert—*Festuca (Triodia) irritans*, the spinifex of the desert explorers, but not the spinifex of science. It is lightly wooded with acacia and other small trees, and, except in a few creeks, there is a great absence of any large timber.

"The prevailing rock, which crops out on the rises and often forms low cliffs, in which are receptacles for holding water, is *light red sandstone* (desert sandstone, tertiary). The only game found in the spinifex is a kangaroo rat, commonly called the 'wurrup'; but in the grassy openings there are many kangaroos, and often emus, also a rat known as the 'wurrung.' These animals are very good eating, and formed a valuable addition to our store department. At the permanent waters there were always myriads of bronze-winged pigeons, and also the white cockatoo with scarlet crest, called the 'chocolate'; also the 'beacoo,' or slate-coloured parrot. Generally, however, with the exception of the crow and hawk, birds were not very numerous except round water. Whenever a sheet of water was found we found ducks, and in Lake Augusta swans and ducks were innumerable."

Though the expedition became ultimately a race for water and life, yet Mr. Forrest found opportunities of carefully noting some of the principal features and productions of the country passed through, and the geologist and botanist especially will find a good deal in all the three narratives to interest them. There are a few spots on the cross-country route of Forrest where a well-provisioned expedition could encamp for months; and if the Colonial Government were to follow the advice recently given by the German Commission in reference to Arctic exploration, and send out a properly equipped scientific expedition to a suitable centre from which varied observations could be made, the scientific, and therefore the practical results, would, we believe, be of great value. This, we think, is the method that ought now to be pursued, at least in conjunction with ordinary exploring expeditions.

Mr. Forrest has made in his three narratives a contribution of high value to the literature of Australian exploration. We are glad to see he has met with so much honour in his own country, though there was no occasion to increase so largely the bulk of his work by newspaper reports of the various meetings held in his honour. Appended are a scientific list, by Baron von Mueller, of the plants collected in the third expedition; a report, by Mr. Brough Smyth, on the geological specimens; and General Weld's report, of September 1874, on the condition of Western Australia, with three pages of statistics.



The maps of the three routes deserve a word of praise. They have been plotted with great care, and the notes along the route are so numerous and full of information, that they form an admirable epitome of the whole work. The few illustrations are interesting; that especially of the Spinifex Desert gives one a good idea of this horror of Australian exploration.

### OUR BOOK SHELF

*Official Guide-book to the Manchester Aquarium.* By the Curator, W. Saville Kent, F.L.S., F.ZS. Third edition. Twentieth thousand. (Michaelmas, 1875.)

THE Manchester Aquarium, situated in the Alexandra Park of that city, has now been opened to the public for more than two years, and has attained considerable success, although we believe it has not quite realised the expectations formed of it by its original promoters. Next to the Brighton Aquarium, that of Manchester is the largest amongst the six principal institutions of this kind existing in the country. The series of tanks, including the deep sea, shallow, and fresh-water groups, is sixty-eight in number, surpassing that of any other aquarium, while their linear frontage falls little short of 700 feet, which is but slightly less than that of the well-known establishment at Brighton. The building itself is of the plainest possible design, and at first sight seems as if it had been originally destined for a church of some kind. It consists of a high central oblong nave and two narrow side aisles. Being lofty and well lighted, however, it affords excellent accommodation for the smaller tanks which line it on both sides, as well as for the two fine large tanks, upwards of forty feet in length, which are situated at the two extremities. The proprietors of the Manchester Institution have been moreover fortunate in securing the services of a competent scientific naturalist as its director, an advantage shared by few if any of the sister establishments. Mr. W. Saville Kent transferred his services from Brighton to Manchester some two years ago. One of the last things he did at Brighton was to prepare the excellent Handbook to the Aquarium there which has been already noticed in this journal. We have now before us a copy of the third edition of the same author's "Guide-book to the Manchester Aquarium," prepared somewhat after the same fashion. After a few words of introduction describing the building and the general management, the sixty-eight tanks and their contents are discussed successively. A large amount of information upon the various fishes and other animals which they contain is thrown together in a very popular and readable form, and woodcuts are introduced illustrating the more attractive and noticeable objects exhibited. The Guide-book is concluded by a chapter on the principles of management of aquaria generally, which cannot fail to be of service to those who are interested in such matters, and which proves that Mr. Kent is fully master of the subject of which he treats.

*Elementary Science Manuals. Botany for Schools and Science Classes.* By W. J. Browne, M.A. Lond. (Belfast: W. Mullan, 1875.)

AN unfavourable impression of this little book is created at first sight by the obvious imitation, in the style in which it is got up, of Macmillan's series of "Science Primers." Such a plagiarism may generally be taken as a confession on the part of author or publisher that the work has not sufficient merits of its own to stand without adventitious assistance. This, however, is not the case in the present instance; and our depreciatory criticisms are almost exhausted. We had, it is true, marked certain passages in the margin for correction; but they are but few. The most important is the resurrection of the old blunder (twice over) of the existence of "spongioles" at the

extremities of the root-fibres; and this is the more remarkable as the work from which the illustrative woodcut is copied does not make this mistake. The statement in the preface, however, that the book "contains all the subjects required for the First B.Sc. Examination in the University of London," must be taken *cum grano*. There is no index; and the deficiencies have therefore to be made out by careful inspection; but we find no description whatever of the process of fertilisation (although there is a diagram to represent the entrance of the pollen-tube into the embryo-sac), and no adequate one of that of respiration, this term being erroneously applied, as is so often the case, to the process of assimilation. But what can you expect for eightpence? You get, at all events, a great deal for your money; and the morphological and structural portion is on the whole so well done as to render the little book of great use to the beginner. Indeed we do not know any purely elementary work in which this part is more satisfactory. A few technical errors will doubtless be noticed and corrected in future editions. The illustrations, seventy-six in number, though not new, are very good and serviceable.

A. W. B.

### LETTERS TO THE EDITOR

[The Editor does not hold himself responsible for opinions expressed by his correspondents. Neither can he undertake to return, or to correspond with the writers of, rejected manuscripts. No notice is taken of anonymous communications.]

#### Hoffmeyer's Synoptic Weather Charts

WILL you kindly draw the attention of your readers to the fact that the second year of Capt. Hoffmeyer's synoptic charts of the weather in Northern Europe and Atlantic, commencing with Dec. 1874, is now about to be issued.

The subscription, as before, will be 12s. 6d. per quarter, including postage of the monthly parts.

I shall be glad to receive names of gentlemen who are willing to encourage the undertaking, which is carried on at Capt. Hoffmeyer's own expense. ROBERT H. SCOTT, Director

Meteorological Office,  
116, Victoria Street, London, S.W.

#### Collomia

ON reading Mr. Duthie's communication (vol. xii. p. 494) on the capsules and seeds of *Collomia*, I presumed that some one would be ready to indicate the use of the mucilage and threads of the seed-coat; but I now notice that Mr. Bennett (vol. xii. p. 514) supposes that it "still remains to be discovered." An obvious and sufficient explanation will be found in A. Gray's "Structural and Systematic Botany," as far back as the edition of 1845. In the later editions, all of them now old, it is twice referred to. On p. 40, after mentioning that these gelatinous threads, or the like, occur on many seeds or seed-like fruits of various orders, it is said: "They may subserve a useful purpose in fixing light seeds to the ground where they lodge, by means of the moisture of the first shower they receive." And on p. 321, where forms of this apparatus are described, it is added: "This minute mechanism subserves an obvious purpose in fixing these small seeds to the moist soil upon which they lodge, when dispersed by the wind."

The seed of a *Collomia* or *Gilia*, when wetted, forms a *limbus* of three or four times its diameter; this would involve a multitude of grains of sand, and ballast the seed most effectually in the situations where or at the time when alone it could germinate.

A. GRAY

Herbarium of Harvard University,  
Botanic Garden, Cambridge, Mass., Nov. 16

#### Sir Thomas Millington and the Sexuality of Plants

IN your article last week on the Oxford Botanic Garden, reference is made to Sir Thomas Millington, the Savilian Professor of Botany, as having in 1676 "first divined the fundamental fact of sexual reproduction in flowering plants." In a review in the columns of the *Academy*, of the English edition of

Sachs's "Text-book of Botany," by Prof. E. R. Lankester, the Savilian Professor is also spoken of as having "discovered the sexuality of plants." It would interest students of the history of botany to know to what extent the writer of either of these articles is able to corroborate this statement by reference to Sir Thomas Millington's writings. In his recently published "History of Botany," Prof. Sachs gives the following account of this alleged discovery:—"In all histories relating to the subject of sexuality, a certain Sir Thomas Millington—otherwise unknown in the history of botany—is mentioned as deserving of the credit of having first indicated the stamens as the male sexual organs. The only information, however, which we have in support of this is contained in the following statement by Grew in his 'Anatomy of Plants,' 1682, p. 171, ch. 5, § 3:—"In conversation on this subject"—viz., on the part played by the stamens (termed by Grew the 'attire') in the formation of seeds—with our learned Savilian Professor, Sir Thomas Millington, he gave it as his opinion that the 'attire' serves as the male organ for the production of the seed. I at once replied that I was of the same opinion, gave him some reasons for it, and answered some objections which might be made to it."\* In the first edition of Grew's work, 1671, he attributes no sexual function to the stamens; but in the edition of 1681 he thus continues, in substance:—"It appears firstly, that the 'attire' serves to separate certain superfluous portions of the sap in order to prepare for the production of the seed. Just as the foliature (floral leaves) serves to carry away the volatile saline particles of sulphur, so the 'attire' serves to diminish and adjust the atmospheric portions, in order that the seed may become more oily and its principles better fixed. The flowers have therefore usually a more powerful odour than the 'attire,' because the saline is stronger than the atmospheric sulphur, which is too subtle to affect the senses. An analogy drawn from the animal kingdom follows, which is hardly quotable; but Sachs points out how wonderfully any germ of truth in Grew's hypothesis was corrupted by the chemical theories and strivings after a false analogy of the day. It is difficult to see that there was really any advance in this hypothesis upon the state of knowledge in the time of Theophrastus (B.C. 371–286), who distinctly recognised some individual plants as male, others as female. Whatever merit also is due to Millington must, unless there is other record of his services, be at least equally shared with Grew.† It does not appear, however, that either of these botanists even attempted to confirm their conclusions by experiment. The merit of the first discovery of the true function of the stamens is assigned by Prof. Sachs to the German botanist Camerarius, in his "De sexu plantarum epistola," published in 1694. This tract closes with an ode, reminding one of Darwin's "Loves of the Plants," beginning thus—

"Novi canamus regna Cupidinis,  
Novos amores, gaudia non prius  
Audita plantarum, latentem  
Igniculos, Venereque miram."

ALFRED W. BENNETT

6, Park Village East, London, Nov. 29

### The Late Eclipse

ON my return from India I should like to say a few words about some letters which appeared in the *English Mechanic* during my absence. Mr. Proctor, and a writer signing himself "A Fellow of the Royal Astronomical Society," comment in these letters on the result of the late Eclipse Expedition. It would be better if these discussions were postponed until the results are published by the Royal Society, but if writers who have not heard anything beyond a few short telegrams take it upon themselves to enlighten the public as to the value of photographs which they have not seen, a few remarks of one who has seen them become necessary.

If the telegrams written by me have given rise to the misunderstanding, I am sincerely sorry for it. I have had no personal interest either in the success or the failure of the expedition. The Royal Society has done me the honour to entrust me with the task of carrying out a programme sanctioned in detail by the Eclipse Committee. This I have done to the best of my ability, and in wording the telegrams in question I avoided, carefully any expression which might have raised expectations, not to be fulfilled.

\* I have not Grew's work at hand, and am therefore retranslating Sachs's translation.

† Grew was born in Coventry in 1628, and died in 1711; in 1677 he was appointed Secretary to the Royal Society.

filled on the arrival of the photographs. If the impression has been propagated that the expedition has not obtained any results of great importance, it is the fault of those who, thinking I had an interest in exaggerating the importance of the results, have taken away from the meaning of my words, which in reality remained far below the truth.

There cannot be the slightest doubt that the photographs obtained by the prismatic camera are full of interest and importance. They solve the question in which part of the spectrum the chief photographic rays of the corona are situated. They open out almost an entirely new field of inquiry, answering questions which could never have been answered by any other method, and suggesting new questions to be answered hereafter.

I should have liked to postpone the question whether it is possible to photograph in all its details the spectrum of the corona in the time available during eclipses, until Mr. Proctor's long-promised mathematical solution has appeared. As, however, we have had to wait for it already a considerable time, I venture to submit to your readers the following considerations:—The prismatic camera is a spectroscope without collimator. It has given us photographs after one minute's exposure, and would have done so in less time under more favourable atmospheric conditions. If we add a collimator and telescope to this camera, we shall have an arrangement similar to that which actually was employed for the photographs of the spectrum. If the lens of the telescope is, as regards diameter and focal length, like that of the camera; if, further, the focal length and diameter of the collimator lens is such that it would collect all the light which passed through the objective of the telescope, if the slit plate was removed, the only diminution the intensity of the light would be caused by the absorption through the two additional lenses and by the diffraction of the slit. The influence of diffraction can be reduced to a minimum by suitably altering the aperture of the collimator lens and by using a slit not too narrow. We should thus have an instrument capable of photographing the spectrum of the corona in one minute.

This is not the place to discuss whether the failure of the spectroscopic cameras was due to atmospheric causes, to the instruments employed, or finally, to my own fault. It will, I believe, be found hereafter, that the experience gained by even these failures will prove useful on future occasions.

In enumerating the results of the expedition the photographs of the corona and the sketch taken by the Hon. H. N. Shore ought not to be forgotten. The time observations were conducted with as much accuracy as the instruments permitted.

Sunnyside, Upper Avenue  
Road, N.W., Nov. 20

ARTHUR SCHUSTER

### Lommel's Optics

I AM indebted to Prof. W. N. Hartley for a correction in my review of Lommel's Optics, the proof-sheets of which did not reach me in time for revision. The translator of the work is evidently right in using the term naphthalin red for the body which exhibits the fluorescent spectrum depicted in Fig. 6 in the article. The substance in question, Prof. Hartley states, is also called Magdala red, and has the elegant chemical name of Azotrinaphthylidiamine. I am also obliged to my friend Prof. H. M'Leod for pointing out that the mode of exhibiting the formation of the rainbow described by Prof. Lommel, is to be found in Jamin's "Cours de Physique" (tome 2, p. 782), although the substitution of a spherical flask filled with water for a solid glass globe, as described by Jamin, is more appropriate and convenient. Pouillet (tome 2, p. 769) also gives, I see, a somewhat similar experiment, using a cylindrical glass vessel filled with water.

W. F. B. ("the Reviewer of Lommel's Optics")

### The Rainfall

IN NATURE, vol. xiii., p. 70, under the head of "The Rainfall," you allude to the extraordinary rainfall for 1875 in Great Britain, and call it a plague of rain; you further call attention to the astonishing fall of 1.287 inches for each of the three hours between 4 and 7 A.M. on the 1st of September last, at Sikawei, in China; and to the total quantity that fell there during the twenty-four hours that elapsed between 4 P.M. on August 31 and the same hour on the day following, viz. 8.59 inches.

I believe that a very heavy rainfall indeed was registered in South Devon in September last, the fall in one hour and in a total of twenty-four being unprecedented; but I have mislaid

the record. It would be interesting to have this accurately stated, and more widely published.

At Bangalore, in the Mysore Province, I once registered an inch and a quarter in twenty minutes; and seven and eight, and more inches have been occasionally gauged during a heavy twenty-four hours' fall, notably so in 1856, when disastrous floods occurred. Somewhere about that period a most extraordinary fall of rain occurred at Madras. I regret that I have not the record by me, but I am right in saying that more than twenty-three inches fell in twenty-four hours! and that more than seven inches fell within six hours! This was gauged at the Madras Observatory, and registered every hour; the statement can therefore be easily corroborated by a reference to the superintendent at that place. A coffee planter on the western Ghauts of Mysore told me that at Hoolikul he had gauged, in August 1874, 13½ inches in one day, and 10½ the next. He described it as a sullen, intermittent, continuous downpour, the monotony of which was very depressing. At Mahabeshwar, on the same line of Ghauts, the average fall is 240 inches, chiefly in the four or five months, from May to September inclusive; while at the Cherrapoonji Hills, not very far from Calcutta, the average fall is over 600 inches, or (say) seventeen yards of rain! My notes are in a book that I left in India, but I am within the mark in what has been stated above.

The meteorology of India would furnish many startling incidents. It has not hitherto been sufficiently attended to, or recorded, and much valuable time has been allowed (like the rainfall) to run by; but attention is now, I believe, being paid to its systematic registry, and to the publication of accurate results. I have some interesting records, however, of the Province of Mysore, which I would gladly place at your disposal should you desire to have them.

J. PUCKLE

A New Palmistry

It is the old story—"In striving to be concise, I have become obscure." If Mr. Mott will refer to my abstract of Prof. Ecker's paper, he will find directions as to procedure, very briefly stated, I will grant; for I, and others too, more competent to judge than myself, had no idea that the subject would attract the attention which it has done. At Mr. Mott's desire, however, I give him a literal translation of Prof. Ecker's directions (*op. cit.* p. 73) in full:—

"With regard to the method of measurement on living individuals, I will merely remark that the hand must be simply laid, with the fingers closed together, upon a board or a piece of paper, upon which a well-defined perpendicular line has been drawn. With this latter the axis of the middle finger and its metacarpal bone is made precisely to coincide. Every lateral movement of the middle finger naturally alters also the position of the other fingers, and every movement of the fingers upon the metacarpal bones towards the pollex turns to the advantage of the position of the index, while that toward the little-finger-edge of the hand to the advantage of that of the ring-finger. The tips of the fingers (without nails *à la Chinois*) are then outlined with a pencil, halved longitudinally; its cut surface being applied against them."

JOHN C. GALTON

Nov. 29

I HAVE made a number of determinations of the relative lengths of the "index" and "ring" fingers of both hands, the results of which, I think, very decidedly show that there is a great dissimilarity between the two hands. The hands of twenty-two persons were examined; in ten there was similarity between the hands as regards the relative lengths of the two fingers in question; in twelve there was dissimilarity. In the case of eight out of the ten the "ring" was longer than the "index"; in one case the "index" was the longer, and in the remaining instance the two fingers were of equal length. Of the twelve cases which exhibited dissimilarity, six had the "ring" longer than the "index" in the left hand, and five in the right hand; four had the "index" longer than the "ring" in the left hand, and in three the same relation existed in the right hand.

M. M. PATTISON MUIR

The Owens College, Manchester, Nov. 27

Faye on the Laws of Storms

M. FAYE's paper on cyclones and waterspouts, of which you have lately published a full abstract, seems very unsatisfactory. The statement in NATURE, vol. xii. p. 401, of the laws of the cy-

clone's motion is no doubt true, but it is avowedly not original. But the succeeding parts, where the dynamics of the subject are treated of, cannot be sufficient—I think I may say cannot be sound—because they take no account of the very remarkable facts of the geographical distribution of cyclones. If M. Faye's theory were true and complete, cyclones ought to be equally common in all equatorial and tropical regions, except perhaps that they ought to be commonest in the hottest parts. So far is this from being the case, that they are strictly local phenomena. They are formed in the West Indian seas, but not in the South Atlantic; in the Indian Ocean, both north and south of the equator, but much oftener on the eastern than on the western side of India; and, I believe, off the coast of California, but not that of Peru. Their periodicity is equally remarkable. In the West Indian and in the Chinese seas they occur chiefly at the end of summer, but in the Bay of Bengal after the equinoxes.

All these facts point to the origin of the cyclone, not, as M. Faye seems to think, in eddies formed in the upper currents of the atmosphere—how could eddies be formed in currents so totally free from obstructions?—but in eddies formed by the meeting and conflict of the two trade-winds where one of them is drawn across the equator. This hypothesis agrees with observation, and harmonises all the geographical facts relating to cyclones.

This simple and true theory is stated in a paper on the Law of Storms by Prof. Maury, in NATURE of June 12, 19, and 26, 1873. It had previously been stated for the Bay of Bengal, as the result of an examination of particular storms, by Mr. Meldrum, in a paper read before the Meteorological Society of Mauritius, and reported in NATURE, vol. ii. p. 151; and a letter of mine in NATURE, vol. iv. p. 305, maintained the probability of all cyclones so originating.

I think M. Faye is as unsatisfactory on waterspouts as on cyclones. I hope to follow this by a letter on waterspouts.

JOSEPH JOHN MURPHY

Old Forge, Dunmurry, Co. Antrim, Nov. 16

OUR ASTRONOMICAL COLUMN

SATELLITES OF URANUS.—There are many amateurs in this country who possess instruments quite competent to show the two larger or exterior satellites of the planet Uranus. With the view to facilitate the identification of these objects, their angles of position and distances from the centre of Uranus are given below for 14h. Greenwich mean time for the last ten days of the present year, with the intention of continuing them while the planet is most favourably placed for observation as regards position and distance from the moon's place. They are deduced from the very convenient tables appended by Prof. Newcomb to his discussion of the observations of the satellites with the 26 inch equatorial at Washington, forming Appendix I. to the Washington Observations for 1873:—

At 14h. G M.T.		TITANIA.		OBERON.		
Dec.	Pos.	48°0	Dist. 20'8	Pos.	64°2	Dist. 23'1
20	..	18'3	.. 32'3	..	33'8	.. 34'6
21	..	359'6	.. 32'1	..	18'1	.. 43'4
22	..	329'2	.. 20'5	..	6'1	.. 45'3
23	..	249'6	.. 16'6	..	352'9	.. 39'4
24	..	206'1	.. 29'3	..	331'4	.. 28'3
25	..	186'4	.. 33'9	..	285'2	.. 20'0
26	..	163'4	.. 25'4	..	233'4	.. 26'1
27	..	100'8	.. 14'9	..	208'8	.. 37'6
28	..	36'2	.. 25'0	..	194'7	.. 44'9
29	..	12'9	.. 33'9	..	182'9	.. 44'6
30	..	353'2	.. 29'7	..	168'4	.. 36'9
31	..	311'3	.. 17'0	..	142'2	.. 25'5

The above angles are reckoned as is usual in measures of double stars, *i.e.*, from the N. point round by the east. The apparent diameter of Uranus by the Malta determination of Lassell and Marth will be 3".87 on December 25th. With this value, should it be found more convenient, the arc values may be reduced to distances in diameters of the planet.

THE MINOR PLANETS.—No. 156 is announced as having been discovered by Herr Palisa, at Pola, on Nov. 22, in R.A. 2h. 54m., and N.P.D. 70° 23': it is of

the twelfth magnitude.—From observations on Nov. 2 and 7 Herr Palisa has calculated circular elements of No. 153, which place the ascending node in longitude  $228^{\circ} 31'$ , with an inclination of  $6^{\circ} 57'$ . The mean diurnal motion assigned on this hypothesis ( $447''$ ), if it were reliable, would make the period of this planet considerably longer than that of any other member of the group, but it will be necessary to wait till elliptical elements on a fair extent of observation are in our hands, before attributing to No. 153 a revolution so much in excess of the rest.

PUBLICATIONS.—(1) P. A. Hansen. *Ueber die Störungen der Grossen Planeten insbesondere des Jupiter*. A posthumous memoir published in vol. xi. of the "Proceedings" of the Mathematical Class of the Royal Saxon Society of Sciences. The analytical developments forming the subject of the first part of this treatise are applied especially to the case of the planet Jupiter; the perturbations of latitude by Saturn, and the perturbations by Uranus, Neptune, Mars, the Earth, Venus, and Mercury are exhibited numerically; and from Herr v. Glasenapp, who was engaged in this part of the work up to the time of Prof. Hansen's decease, may, it is announced, be expected the complete calculation of the perturbations of longitude and radius-vector of Jupiter by Saturn.

(2) J. N. Stockwell. *Theory of the Moon's Motion*.—This is a republication in an extended form of an investigation which appeared in the *Astronomische Nachrichten*, Nos. 2,024—2,026, wherein the mathematical developments are given in greater detail, with the addition of those applying to the formulæ for latitude. The author hopes to find time to continue his investigations in the same direction, so as to complete the developments of the perturbations of the moon's motions by means of the differential equations given in this first chapter. In the author's introductory remarks on the labours of those eminent mathematicians who have taken up the lunar theory, in referring to Prof. Hansen, there is no mention of his "Fundamenta nova investigationis orbitæ veræ quam Luna perelustrat," Gotha, 1838; or his "Darlegung der Theoretischen Berechnung der in den Mondtafeln angewandten Störungen," the first part of which appeared in 1862, and the second in 1864.

(3) Dr. Franz Melde. *Theorie und Praxis der Astronomischen Zeitbestimmung*, &c. (Tübingen, 1875).—The author, Professor in the University of Marburg, explains that in the course of lectures on the determination of time by astronomical observations, he had found the want of a work in which the subject should be treated both in a theoretical and practical point of view, and in the present volume of 500 pages he has presented a very detailed discussion of time-determinations after the methods generally employed. The transit-instrument, its arrangement, mounting, and errors, with the methods of regulating it; the sextant, more particularly as regards its use for ascertaining time by corresponding altitudes of sun or stars, time by occultations, refraction, aberration, precession, &c., are explained at length. The volume, it will be seen, is one of a special character, and will be a desirable addition to an astronomical library.

#### DR. R. VON WILLEMOES-SUHM

IT is with the deepest regret that I have to intimate the death of Dr. Rudolf von Willemoes-Suhm, at sea, on our passage from Hawaii to Tahiti. He had not been in his usual robust health for some months, having suffered occasionally from indolent boils on different parts of the body. On Sept. 6 he applied to the surgeon for advice. He had had a rather severe shivering fit the day before, and an inflamed spot on the face began to show symptoms of erysipelas. The swelling and inflammation of the face increased during the next week; it extended over the forehead; and the fever and delirium attending erysipelas

became more pronounced. On the morning of Sept. 13 he sank into a state of collapse, and died at three o'clock in the afternoon.

This sad occurrence has of course thrown a heavy gloom over our little party. From the commencement of the voyage Dr. v. Willemoes-Suhm devoted himself with unremitting industry and zeal, and in the best possible spirit, to the objects of this expedition. He has already published, in connection with our work, a paper in the *Annals and Magazine of Natural History*, "On a terrestrial Nemertine from Bermudas;" a long paper in Linnean Proceedings, on the deep-sea Crustacea of the cruise; "On the development of *Umbellularia*," in the *Annals and Magazine*: "On the Development of *Lepas fascicularis*," a paper sent to the Royal Society from Honolulu; and the notes on Crustacea which have been incorporated from time to time in my letters and reports. He has also written some interesting letters to Prof. von Siebold, describing the general zoological results of the cruise, which have been published in the *Zeitschrift für Wissenschaftliche Zoologie*. He leaves a fine series of drawings, with full descriptions, chiefly illustrating the development of surface Crustacea. For example, the development of species of the genera *Euphausia*, *Sergestes*, and *Amphion* is traced through all its stages. He leaves also an ample official journal in two large volumes. The loss of his valuable assistance in working up the final results of the expedition must, I fear, seriously affect their completeness.

Rudolf von Willemoes-Suhm was a native of Schleswig-Holstein; his family now reside in the neighbourhood of Rendsburg, where his father holds a high official appointment. He was about twenty-eight years of age when he died. He studied in the Universities of Göttingen and Bonn; he showed very early a strong taste for natural history in all its branches, and when quite a boy he published papers on the habits of European birds. Shortly after he left the University, he was appointed Privat-Docent in Zoology in the University of Munich, where he was associated with Prof. von Siebold, with whom he was extremely intimate, and whose place he frequently took in the lecture-room when the professor was prevented from teaching by indisposition. In 1868 he visited Italy and made zoological observations at Spezzia. In the summer of 1870 he made a series of observations on various marine animals, *Halicryptus*, *Balanoglossus*, &c., which formed the subject of his thesis on being appointed Privat-Docent in Munich.

In the summer of 1872 he went to the Faeroe Islands. He published some of the results of his investigations there in *NATURE* and elsewhere, but unfortunately a large series of zoological drawings which represented the greater part of his work was lost *in transitu*. It was from the accident of his calling upon me in Edinburgh, on his return from Faeroe, while there was still a vacancy on the staff of the *Challenger*, that he joined the expedition.

Among the more important of his publications are—  
"Helminthologische Notizen," I. (*Zeitschrift für Wissenschaftliche Zoologie*, Bd. xix., 3 Heft.)

"Helminthologische Notizen," II. (*Ibid.* Bd. xx., 1 Heft.)

"Zur Entwicklung von *Schistocephalus dimorphus*" (*Ibid.* Bd. xix., 3 Heft.)

"Biologische Beobachtungen über Niedere Thiere" (Leipzig, W. Engelmann, 1871) contains: "On a young calcareous sponge;" "On the development of an appendiculate Distoma;" "On *Balanoglossus kufferi*;" "On *Halicryptus spinulosus*;" "On *Priapulius caudatus*;" "On the development of some Polychæte Annelids, *Etone*, *Terebella*, and *Spirorbis*;" "On the natural history of *Polystoma integerrimum* and of *P. ocellatum*."

Dr. von Willemoes-Suhm was a man of unusual acquirements and culture; besides having a wide and accurate knowledge of the literature of natural science, he

was a good classical scholar, and could converse with perfect fluency in English, French, German, Danish, and Italian; and could read with ease nearly all the modern European languages. He made some strong friendships among his colleagues, and his acknowledged ability and his manner and address, which were eminently those of a polished gentleman and man of the world, won for him universal respect and esteem.

Altogether I looked upon Rudolf von Willemoes-Suhm as a young man of the very highest promise, perfectly certain, had he lived, to have achieved a distinguished position in his profession, and I look upon his untimely death as a serious loss not only to the expedition in which he took so important a part, but also to the younger generation of scientific men among whom he was steadily preparing himself to become a leader.

C. WYVILLE THOMSON

H.M.S. *Challenger*, Tahiti, Oct. 1

### THE PENIKESE SCHOOL

OUR readers will regret to hear that the Anderson School of Natural History in Penikese Island, U.S., has come to an untimely end, and will no doubt regret still more that it has done so amid much unpleasant feeling between those chiefly concerned. We shall endeavour to state fairly the facts of the case.

Mr. Anderson, who is a wealthy merchant, made a gift of Penikese Island and 50,000 dollars in cash to the late Prof. Agassiz, in order to enable him to start a school for the practical teaching of natural history. This sum, it may well be believed, was only sufficient to start the school, erect buildings, furnish apparatus, and other necessities. No one can complain that Mr. Anderson did not also endow the school, and during the life-time of the elder Agassiz there seems to have been no difficulty as to funds. On his death, his son, Mr. Alexander Agassiz, undertook to carry on the school. This he did, we believe, very unwillingly, as he knew there were no funds available for the daily business of the school, and he did not consider the island a suitable location for such an institution unless largely endowed. Moreover, it was his father's earnest wish that he should devote most of his time and energy to the Museum at Cambridge. However, he consented to conduct the school on condition that Mr. Anderson would contribute the sum of 10,000 dollars towards its support for the next three years. The first intimation of any dissatisfaction on the generous donor's part seems to have been made to the trustees at the end of 1874, when he sent them 1329.60 dollars to pay off debts which had been incurred, announcing at the same time that this was the last contribution he would make. The trustees seem, nevertheless, to have made every effort to carry on the school. A member of Prof. Agassiz's family contributed a guarantee fund of 3,000 dollars, and appeals were made in all directions, but without anything like success. Clearly the trustees and the teachers themselves could not be expected to carry on the school at their own expense, and all that they had any right to look for from Mr. Anderson was the balance of the 10,000 dollars which he promised; why he failed to contribute this, we are unable to say. Had he done so, those interested in the success of the school would have had time to set about raising something like an endowment fund, and a fine opportunity would have been afforded to the U.S. Government to show their appreciation of practical scientific teachers and scientific research. As it was, the only course which seemed left to the trustees, when everything is taken into account, was to close the school and sell off the furniture and aquaria. Mr. Anderson seems to have considered himself ill used and insulted by the trustees, and Mr. Agassiz in particular; but so far as the facts are known to us, we certainly believe he is mistaken. Mr. Agassiz has duties of the highest importance to attend to in connection with

the Cambridge Museum, and he could not possibly be expected to waste his time and energy on an undertaking in whose success no one seemed to be interested. He seems to us to have acted in a straightforward and honourable manner, and only to have given up the school when he saw there was no possible hope of getting funds to carry it on. Mr. Anderson, for some reason which does not appear, seems to have lost his temper, and may naturally have been annoyed that the public did not come forward in support of the school which he so generously founded. The result is certainly to be regretted, but we hope that Mr. Agassiz and Mr. Anderson may come to a better understanding, and that even if the school be not again started, the latter will see that the former has acted all along in the interests of science, whose servant he is. To have touched the Agassiz Memorial Fund, now 347,000 dollars, as some one suggested should have been done, was simply impossible; it was collected for a special purpose.

Mr. Agassiz took two of the most promising Penikese pupils into his laboratory at Newport, and intends, we believe, as soon as the necessary means can be collected, to establish a school at some more suitable locality.

### THE THEORY OF "STREAM LINES" IN RELATION TO THE RESISTANCE OF SHIPS\*

#### II.

IT might at first sight appear that I have now the materials for the proof of my chief proposition, the assertion of the unresisted progress of a submerged body; for such a body might be assumed to be surrounded by a system of imaginary pipes, as shown in Fig. 8; and each of these pipes being in equilibrium

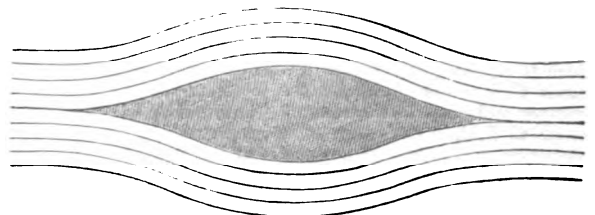

FIG. 8.

endways, that is to say, the flow of fluid through it not tending in the aggregate to move it endways, neither, it might be said, would the flow of fluid tend to move the submerged body endways. But this reasoning would not be sound. The pipes we have hitherto been considering have been of uniform sectional area throughout their length, an assumption which has been necessary to the treatment pursued, as the velocity has in each case been assumed to be uniform throughout the pipe. The section of the pipe may have been square, circular, trapezoidal, or any other form; but the area of the section has been assumed to be the same throughout the length of the pipe.

But pipes of uniform sectional area do not truly represent the flow of a fluid past a submerged body. I shall presently ask you to consider the fluid as flowing past the body through a system of imaginary pipes; but to render the assumption admissible, the sides of the imaginary pipes must not be so placed as to interfere with the established course of the fluid, whatever that may be; in other words, if, for the sake of illustrating the behaviour of the fluid, we assume that it is divided into streams or filaments flowing through imaginary pipes, we must accept such a form for those imaginary pipes that their sides exactly follow the paths of the adjacent particles of fluid.

Now such a rule may, and probably will, require the imaginary pipes to be of varying sectional area throughout their length. Therefore, before we can apply the analogy of the flow of fluid through pipes to the flow of a fluid past a submerged body, it is necessary to consider the behaviour of fluid in pipes of varying sectional area.

It is, I think, a very common but erroneous impression, that a

\* Address to the Mechanical Section of the British Association, Bristol, August 25, 1875; by William Froude, C.E., M.A., F.R.S. President of the Section. Revised and extended by the author. Continued from p. 52.

fluid in a pipe exercises, in the case of its meeting a contraction (see Fig. 9), an excess of pressure against the entire converging surface which it meets, and that, conversely, as it enters an enlargement (see Fig. 10), a relief of pressure is experienced by the entire

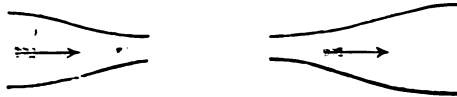

FIG. 9.

FIG. 10.

diverging surface of the pipe. Further, it is commonly assumed that, when passing through a contraction (see Fig. 11), there is



FIG. 11.

in the narrow neck an excess of pressure due to the squeezing together of the fluid at that point.

These impressions are in no respect correct; the pressure at the smallest part of the pipe is, in fact, less than that at any other point, and *vice versa*.

If a fluid be flowing along a pipe which has a contraction in it (see Fig. 12), the forward velocity of the fluid at B must be



FIG. 12.

greater than that at A, in the proportion in which the sectional area of the pipe at B is less than that at A; and therefore while passing from A to B the forward velocity of the fluid is being increased. This increase of velocity implies the existence of a force acting in the direction of the motion; that is to say, each particle which is receiving an increase of forward velocity must have a greater fluid pressure behind it than in front of it; for no other condition will cause that increase of forward velocity. Hence a particle of fluid, at each stage of its progress along the tapering contraction, is passing from a region of higher pressure to a region of lower pressure, so that there must be a greater pressure in the larger part of the pipe than in the smaller, and a diminution of pressure at each point corresponding with the diminution of sectional area; and this difference of pressure must be such as to supply the force necessary to establish the additional forward velocity required at each point of the passage of the fluid through the contraction. Consequently, differences of pressure at different points in the pipe depend simply upon the velocities at those points, or, in other words, on the relative sectional areas of the pipe at those points.\*

It is simple to apply the same line of reasoning to the converse case of an enlargement. Here the velocity of the particles is being reduced through precisely the same series of changes, but in an opposite order. The fluid in the larger part of the pipe moves more slowly than that in the smaller, so that, as it advances into the enlargement, its forward velocity is being checked; and this check implies the existence of a force acting in a direction opposite to the motion of the fluid, and each particle being thus retarded must therefore have a greater fluid pressure in front of it than behind it; thus a particle of fluid at each stage of its progress along a tapering enlargement of a pipe is passing from a region of lower pressure to a region of higher pressure. As is well known, the force required to produce a given change of velocity is the same, whether the change be an increase or a decrease. Hence, in the case of an enlargement of a pipe, as in the case of a contraction, the changes of velocity can be satisfied only by changes of pressure, and the law for such change of pressure will be the same, *mutatis mutandis*.

In a pipe in which there is a contraction and a subsequent enlargement to the same diameter as before (see Fig. 11), since the differences of pressure at different points depend on the differences of sectional area at those points, by a law which is exactly the same in an enlarging as in a contracting pipe, any points which have the same sectional area will have the same pressures,

\* See Supplementary Note B.

the pressures at the larger areas being larger, and those at the smaller areas smaller.

Precisely the same result will follow in the case of an enlargement followed by a contraction (see Fig. 13).\*

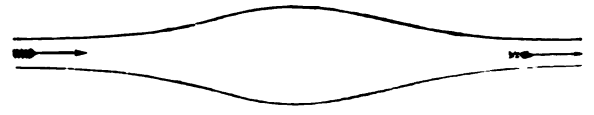

FIG. 13.

This proposition can be illustrated by experiments performed with water.

Figs. 14, 15 show certain pipes, the one a contraction followed by an enlargement, and the other an enlargement followed by

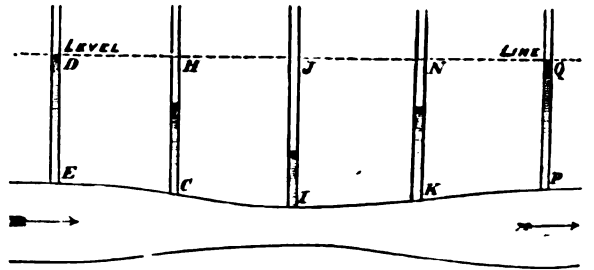

FIG. 14.

a contraction. At certain points in each pipe, vertical gauge-glasses are connected, the water-levels in which severally indicate the pressures in the pipe at the points of attachment.

In Fig. 14 the sectional areas at P and E are equal to one another. Those at C and K are likewise equal to one another, but are smaller than those at P and E. The area at I is the smallest of all. Now, if the water were a perfect fluid, the pressures P Q and E D would be equal, and would be greater

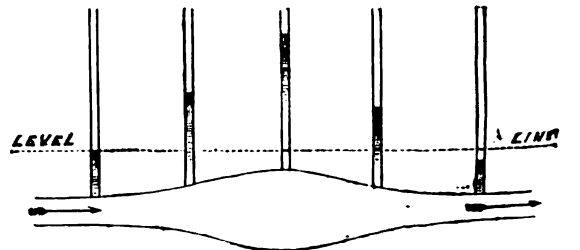

FIG. 15.

than CH and KN. CH and KN would also be equal to one another, and would be themselves greater than I J.

The results shown in Fig. 15 are similar in kind, equal pressures corresponding to equal sectional areas.

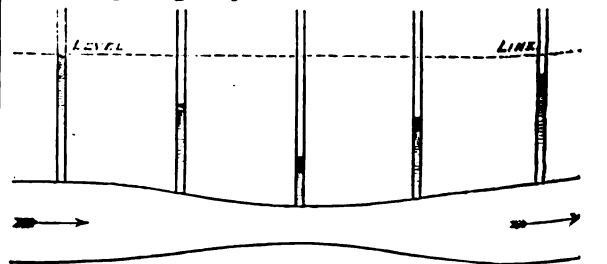

FIG. 16.

As water is not a perfect fluid, some of the pressure at each successive point is lost in friction, and this growing defect in pressure is indicated in the successive gauge-glasses in the manner shown in Figs. 16, 17.

\* In a perfect fluid, we may say in a sense, the *vis viva* of each particle remains constant. If the particle is stationary, the *vis viva* is entirely represented by the pressure; if it be under no pressure, the *vis viva* is entirely represented by the velocity; if it be moving at some intermediate velocity, the *vis viva* is partly represented by the pressure and partly by the velocity.



As the pressure of the perfect fluid in the pipe at any point depends upon the sectional area at that point, it follows that the amounts of the pressures are independent of the distance, as

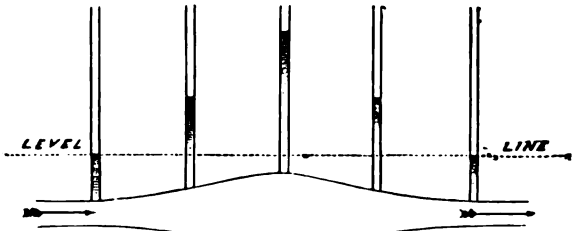

FIG. 17.

measured along the pipe, in which the area of the pipe alters; so that if in the pipe shown in Fig. 18 the areas at all the points marked A are equal, if also the areas at all the points marked B are equal, and so also with those at C and D, then the pressures

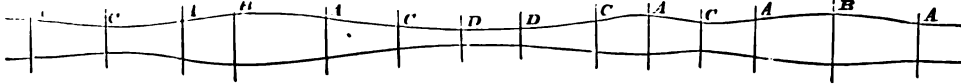

FIG. 18.

sitions which I have been elucidating will be seen to be verified step by step, if due allowance be made for the effect of friction.

A cistern (see Fig. 20), in which a definite head of water is maintained, discharges itself through a continuous series of pipes,

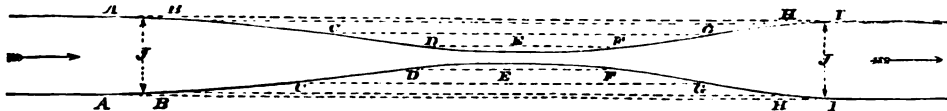

FIG. 19.

At the various critical features are fitted gauge-glasses such as have been described, so that the level at which the water stands in each indicates the pressure in the pipe at the point of attachment.

at all the points A will be the same, the pressures at all the points B will be the same, and so with those at C and D.

Since, then, the pressure at each point depends on the sectional area at the point and on that only, it is easy to see that the variations in pressure due to the flow are not such as can cause any total endways force on the pipe, provided its sectional area at each end is the same.

Take the pipe shown in Fig. 19. The conical portion of pipe A B presents the same area of surface effective for endways pressure as does the conical portion H I, only in opposite directions. They are both subject to the same pressure, being that appropriate to their effective mean diameter J. Consequently the endways pressures on these portions are equal and opposite and neutralise one another. Precisely in the same way it may be seen that the endways pressures on B C, C D, D E, exactly counteract those on G H, F G, E F; and in precisely the same way it may be shown that in any combination whatever of enlargements and contractions, provided the sectional area and direction of the pipe at the two ends are the same, the total endways effect impressed on the pipe by the fluid flowing through it must be *nil*.

In the experiment I am about to show you, the several propo-

which in the local changes of diameter exhibit the several characteristic features which have been under consideration.

From *a* to *b* at the outlet end we have a contraction followed by an enlargement; from *e* to *g* the diameter is uniform, from

The series of pipes is laid out on an [inclination which represents the mean resistance due to friction, or the "head" lost by friction, between the cistern and the outlet, in other words, the hydraulic mean gradient.

The mean diameter of the contracted part between *a* and *b*

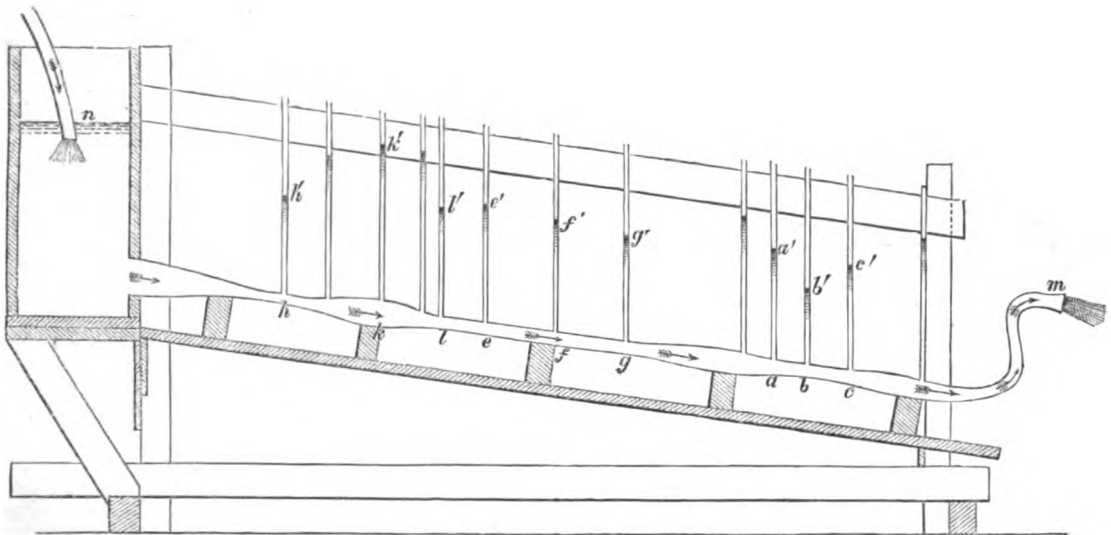

FIG. 20.

has been so determined by well-known hydraulic rules, that when it is compared with the adjoining parallel pipe, the hydraulic gradient shall be the same in each.

You observe that while the levels at which the water stands in the several gauge-glasses corresponds from end to end with the gradient from the head in the cistern to the head at the outlet;

when examined in detail, they verify throughout the propositions I have been establishing. Broadly speaking, where the diameter is smallest, the pressure falls most below the mean gradient; at the points where the diameters are equal, the pressures allowing for the gradient are equal, and what is a quantitative verification, the gradient, or loss of head per foot between *a* and *b*,

as indicated by the gauge-glass levels  $a'$  and  $b'$ , is identical with that indicated by  $d' f' g'$ , the gauge-glass levels connected with the parallel pipe.

In dealing with pipes of varying sectional area I have hitherto treated only of the modifications caused in the forward motion of the particles of fluid; for I have limited the argument to cases where the alteration in sectional area of the pipe is so gradual that, practically, the only alteration in the motion of the particles is that in their forward velocity; but I have previously shown that tortuosity in a pipe of uniform diameter does not introduce endways pressure, provided the initial and terminal directions are the same; and it is easy to see that an elongated system of such gradually tapered pipes as we have been considering, may be also tortuous without introducing endways pressure. Now tortuosity of flow is but another word for sideways deviation of flow.

This leads us up to the case of more sudden contractions or enlargements in pipes, where the particles next the sides of the pipes have to follow their surfaces and must therefore be moved rapidly sideways in their course.

We will, for simplicity, consider the case of a contraction (see Fig. 21), and one in which the pipe resumes the same diameter beyond the contraction.

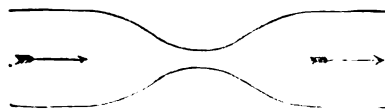

FIG. 21.

The particles along the central line pursue a straight course, and are subject only to the changes of pressure necessary to induce the changes of velocity.

To consider the behaviour of the other particles, let us assume that we insert a number of perfectly thin partitions (see Fig. 22), which we lay in such a manner that they exactly follow the paths of the particles of fluid at each point, so as not in any way to affect their motion; these partitions are quite imaginary, and merely assist us in looking upon the entire fluid in question as divided into a number of small streams. These streams are generally curvilinear, and vary in sectional area; and at the point beyond the contraction where the pipe resumes its former sectional area, we shall naturally find these minor streams occupying the same sectional area as before, and moving with the same velocity as before.

Now each of these small streams is exactly represented by a stream of fluid flowing within a pipe, that pipe being curvilinear and gradually varying in sectional area, and its two ends being of the same sectional area and in the same straight line. We have seen that in the case of such a stream, the sum total of all the forces due to its motion has no resultant longitudinally; and this will be equally the case, whether the envelope of the stream

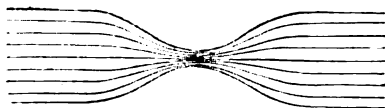

FIG. 22.

be an actual pipe or the mutual pressure of adjacent streams; this envelope will not be moved endways by the flow of the fluid. What is true of each stream is true of all put together; and thus it follows that the whole body of fluid which these separate streams constitute does not exert any endways force; or, in other words, there will be equilibrium of fluid forces throughout the passage of the fluid through a local contraction in a pipe such as we have been considering. The same line of argument evidently holds good in the case of an enlargement, where the pipe beyond the enlargement regains the same diameter as before.

In illustration of the conclusions which have been thus far established, if we had a perfect fluid with which to try the experiment, we might exhibit a very instructive and striking result.

Assume a perfect stream of fluid flowing through a pipe of very large diameter, ABC, with a contraction in it at B, as shown in Fig. 23, and that the equal pressures at A and C on either side of the contraction are indicated by the head of fluid in pressure-gauges A D, C E—the pressure at B, which will be less, being represented by the height BF. Now, the condition of the pipe at A will be just the same if we suppose the pipe supplied from a large cistern G, as shown in Fig. 24; and the

appropriate pressure at A will be maintained, if the fluid stands in the cistern G at a height H, equal to the head A D in the pressure-gauge. So, again, the condition of the pipe at C will be the same if the pipe discharges into a cistern, I; and the appropriate pressure at C will be maintained, and can only be

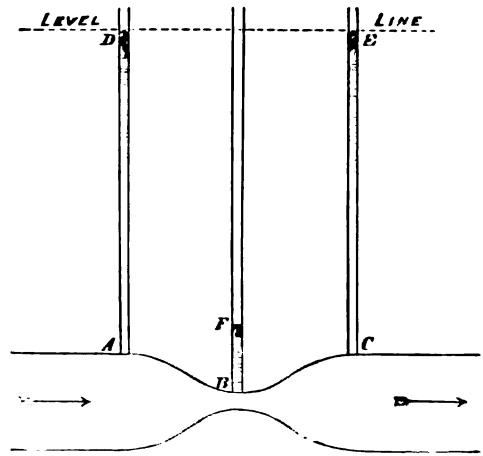
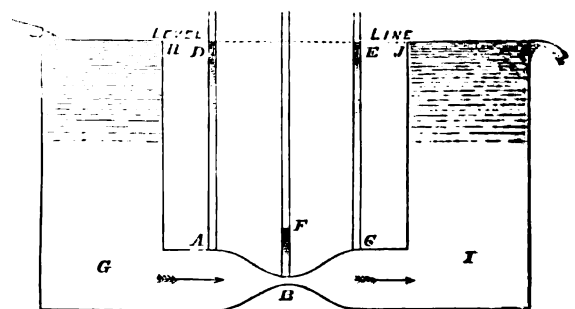

FIG. 23.

maintained, if the water in the cistern stands at a height J, equal to the head C E in the pressure-gauge, which is, in fact, the same level as H in the cistern G; so that if we once establish the motion through the pipe A B C, and maintain the supply of fluid, we shall have the fluid running rapidly, and continuing to run with unabated rapidity, from one cistern into another, though both are at the same head.

If we take such a condition of things that the pressure at B is zero, or, in other words, if the velocity at B is that due to the head A D, then we might cut the pipe at B and separate the two cisterns as shown in Fig. 25, and we should find the fluid issuing at B in a jet, and re-entering the pipe again at K, and rising as before in the cistern I to the same level with a perpetual flow.

The experiment here suggested is, if rightly understood, only a specialised instance of the properties of what in the previous experiment was termed a contraction followed by an enlargement; it is in fact as if in that experiment the diameter of the contracted part had been so far reduced that the pressure within it would have sunk apparently to zero, that is to say, in reality to the pressure of the atmosphere; in that case, of course, the pipe which enclosed that portion of the stream would have become simply an inert envelope, and might have been removed without affecting the dynamic properties of the stream. Theoretically indeed with the frictionless fluid the contraction of jet might be carried so far as not merely to obliterate all positive pressure, but to produce a negative pressure equal to that of the



atmosphere. For in fact the conditions thus brought into operation would be in effect identical with those which would exist were the experiment performed *in vacuo*, and the head in cistern and at the outlet were both increased by 34 feet; but the theoretical possibility thus indicated is greatly curtailed by friction, and the illustrative experiment I am about to exhibit deals only with the case in which the pressure at the contraction is reduced

apparently to zero, or in reality as I have said to that of the atmosphere.

In the apparatus as here arranged, consisting of the discharging and the recipient cistern, with the intervening jet-orifice and recipient-orifice, the overflow of the recipient cistern is at 18 inches above the centre of the orifices.

As I continue to fill the discharge cistern, you observe the jet shoots across the open space between the orifices, and the water-level continues to rise in the recipient cistern; and so long as the head in the former is maintained at a moderate height above that in the latter, the whole of the stream enters the recipient orifice, and there is no waste except the small sprinkling which is occasioned by inexactness of aim, and by the want of exact circularity in the orifices.

When the head in the recipient has reached the overflow, and thus remains at a steady height of 18 inches above the orifices, the complete reception is insured by maintaining a head of  $20\frac{1}{2}$  inches in the discharging cistern, or an excess of head of  $2\frac{1}{2}$  inches on the discharge side; and this excess, in effect, represents the energy wasted in friction.

You observe that as I diminish the supply of water and allow the excess of head in the discharger to become reduced, a steadily increasing waste becomes established between the orifices; and it is interesting to trace exactly the manner in which the friction operates to produce this result.

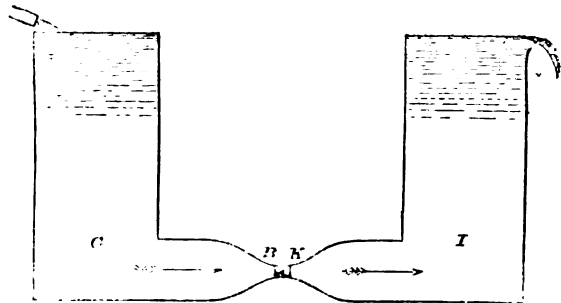

FIG. 25.

If the conoids of discharge and reception are tolerably short as they are here, it is the outer annule or envelopes of the stream which are in the first instance affected, that is to say retarded, by friction, and the escape or waste between the orifices implies that this surface-retardation has reduced the velocity of those envelopes below that due to the head in the recipient; thus an annular counter-current is able to establish itself, and in fact constitutes a counter discharge from the recipient.

As the quantity of water which actually enters the recipient, or in other words the speed of the inflow, is reduced, the friction which belongs to that part of the stream is reduced also, but that which belongs to the issuing jet is unabated, and this circumstance virtually magnifies the waste; it is probable, however, that to the last the velocity of the central zones of the jet remains equal to that due to the head in the discharger, and hence you will observe that unless this is reduced below the level of the overflow, the head in the recipient is fully maintained to that level, though the whole quantity discharged is wasted between the orifices.

When the supply is altogether cut off, both cisterns simultaneously empty themselves, the two jets meeting between the orifices, and becoming spread into a beautiful plane disc or film of water at right-angles to the line of discharge; but you will notice that from some inequality in the commencement of the action, and to some extent probably from a quasi-instability in the equilibrium of the double discharge, one of the jets will presently for a moment get the better of the other and drive it back so as almost to arrest its flow, and thus for the moment arrest also the waste of head on that side; but the momentary excess of head thus occasioned almost instantly asserts its superiority, producing a jet of superior force, and thus driving back for a moment the opponent by which it had just before been mastered. Thus a curious oscillation of discharge ensues, which is to a large extent a true dynamic phenomenon somewhat analogous to that which becomes established in an inverted syphon partly filled with water, if for a moment the head is increased in one of the legs; the reaction which in the syphon is furnished by its continuing through the bend, is, in the case before you, furnished by the dynamic reaction of the jets, but the circumstances here

involve an instability which does not exist there, so that the small initial disturbance presently magnifies itself into one of considerably greater range.

This curious corollary phenomenon of the alternated retardation of discharge, though not strictly relevant to the main object of the experiment, is nevertheless highly interesting in itself and tends to enlarge our apprehension of some of the characteristic features of fluid dynamics.

(To be continued.)

## NOTES

TUESDAY being St. Andrew's Day, the anniversary meeting of the Royal Society, as required by their charter, was held. The President, Dr. Hooker, began his address with a few remarks on the large number of eminent Fellows whose names appeared in the death-list of the past year, and then gave a summary of the numerous measures for "the improvement of natural knowledge" undertaken by the Society. These comprise the publication of papers in the "Philosophical Transactions," in a separate form; preparation of additional volumes of the catalogue of scientific papers; the labours of committees in connection with the Transit of Venus Expedition, and the researches of naturalists in Kerguelen and Rodrigues; the Eclipse of the Sun Expedition to Siam, the Polar Expedition, the voyage of the *Challenger*, and of the Committees appointed to consider the suggested modification of the regulations under which candidates are elected into the Society. The auditors' report showed that the pecuniary resources of the Society were in a satisfactory condition, and Dr. Hooker mentioned the bequests made to the Society by the late Sir C. Wheatstone and Mr. H. Dircks. The medals were then presented, the Copley medal to Dr. Hofmann, a Royal medal to Mr. Crookes, and a Royal medal to Dr. Oldham (at present in India), through Prof. Ramsay. The proceedings terminated with the election of council and officers (comprising the list of names already published) for the ensuing year. We hope to refer at length next week to the President's address. The anniversary dinner was held at Willis's Rooms, Dr. Hooker in the chair, supported by the Marquis of Salisbury, Lord Cardwell, Mr. W. H. Smith (of the Treasury), the Right Hon. Robert Lowe, Mr. Farrer, Admiral R. Hall, Mr. Lyon Playfair, Dr. Hofmann, Mr. Crookes, and a large number of the Fellows of the Society and their friends.

ON Monday night there was a pleasant and lively meeting at the Royal Geographical Society, over Mr. Stanley's work on the Victoria Nyanza. The paper read was by Col. Grant, C.B., the old companion of Speke, and he awarded hearty praise to Stanley, whose work he estimated as of high geographical importance. At the same time he showed that Stanley's discoveries seemed to confirm the discoveries of Speke as far as these went. The former estimates the circumference of the lake at 890 geographical miles, which coincides essentially with Speke's estimates. Sir Samuel Baker spoke much to the same effect as Col. Grant, both as regards Stanley and Speke, as did also Capt. Burton, while Mr. Edwin Arnold acted the part of Stanley's representative. It was announced that the Church Missionary Society are to take advantage of King Mtesa's invitation to send out missionaries; Sir Samuel Baker believes that the good Mtesa mistook Stanley for Livingstone, whom he had been informed might be expected from the south. Sir H. Rawlinson read some extracts from Col. Gordon's letter on the Albert Nyanza, which he trusted would also be explored by Mr. Stanley.

THE Queen has conferred upon Dr. W. B. Carpenter, F.R.S., the honour of the Companionship of the Civil Division of the Order of the Bath.

THE Royal Academy of Sciences of Berlin has elected Dr. Frankland and Prof. A. W. Williamson, of London, corresponding members of the section of Physics and Mathematics.

MANY of the readers of NATURE will be grieved to hear that Prof. Friedrich Albert Lange died at Marburg, after severe suffering, on the 21st of November. A great career was opening before him when he was smitten by the illness which killed him. His principal work is the "History of Materialism," a second edition of which he had completed shortly before his death. This work will long remain a monument of honour to his memory—an ensample alike of comprehensive learning and of profound and elevated thought.

THE three vacant seats on the Senate of the University of London have been filled by the appointment of Dr. Hooker, Pres. R.S., and the Dean of Lincoln (Dr. Blakesley), directly by the Crown, and Mr. J. G. Fitch on the nomination of Convocation.

WITH reference to Dr. Acland's late pamphlet on the future site of the Oxford Botanic Gardens, in the form of a letter to Dr. Hooker, the Professor of Botany (Mr. Lawson) draws attention to the fact that the question of retaining them upon their present site or of removing them to the Parks is now *sub judice*, and that till Council deems fit to announce the result of their deliberations it would be highly inexpedient for the Professor of Botany to enter into any discussion on the matter, and he requests members of the University to suspend their judgment until such time as the question can be placed before them in all its bearings.

DR. L. S. FORBES WINSLOW has been appointed to the chair of Psychological Medicine at Charing Cross Hospital.

TELEGRAMS from Prof. Palmieri state that the interior of the crater created by the last eruption of Vesuvius has given way. A dark smoke issues from the volcano, and he thinks an eruption is consequently to be expected, but perhaps not immediate.

FROM additional notes on the Meteorological Congress at Poitiers which we have received, we learn that nineteen departments surrounding Poitiers are formed into a permanent meteorological union called "Ouest-Oceanien," for the purpose of organising weather forecasts in the interests of agriculture, and of tracing the paths of thunderstorms. Another similar association will be established at Bordeaux for the south-western provinces. Next year the "Ouest-Oceanien" will hold its second yearly meeting at Tours. It has been decided that a barometer, constructed on an improved plan by M. Redier, shall be sent to each chief town of an *arrondissement*, as also the telegrams from the Paris Observatory giving the meteorological news transmitted by the international service. The resident meteorologists are to take advantage of these general warnings in issuing special predictions. These efforts will promote the meteorological investigations and multiply the number of observers. It is expected that the Paris Observatory will commence to issue daily bulletins and maps similar to those which for a long time have been issued by the U.S. Signal Service, showing up to what extent their predictions have been warranted by facts. M. Alluard, Director of the Puy de Dôme Observatory, was present at the Congress, and gave interesting details as to the state of the works, which are progressing favourably. In the course of a few months the observations will begin at the top of the mountain, and by the month of May next the works will be opened for inspection by men of science of all nations. The presence of a large number of delegates from various parts of France enabled the Congress to pass resolutions of so general a character as to insure everywhere uniformity of action, and the establishing, on a satisfactory basis, of an *Atlas Météorologique de la France*.

THE *South Australian Register* contains a short account of the exploration of the large river in New Guinea referred to in our last number. The details are given in connection with the report of the return of Mr. Macleay's expedition in the *Chevert*, which

became disorganised, Mr. Macleay and Capt. Edwards having disagreed. The scientific portion of the expedition proceeded to New Guinea in a "missionary vessel, probably the *Ellangowan*, the same which is reported to have sailed up the Baxter River. The details, evidently supplied by some one who had been on board the *Ellangowan*, published in the *Register*, are substantially the same as those given in Mr. Smithurst's letter. Large cloven hoof tracks are reported to have been seen, as also the monstrous bird referred to by Mr. Smithurst. Lieut. Robert H. Armit, R.N., writing to the *Daily News*, states that the position of the supposed newly-discovered river in New Guinea, as given by Mr. Smithurst—lat. 8°38' S., long. 141°59' E.—clearly proves it to be none other than the one discovered by the officers of her Majesty's ship *Fly*, and which to this day bears the name of that vessel.

PROF. HENRY'S Smithsonian Report for the year 1874, the *New York Nation* states, gives a good account of the management and varied usefulness of the Institution. Among the publications in progress or contemplated are a "complete index to all the species of plants of North America, with their synonyms and all descriptions and important references to them;" a new and enlarged edition of Schott's "Tables of Rain and Snow in the United States;" a general discussion of the winds of the globe; a discussion of all the observations made on the temperature of the U.S. from the earliest times; and a work on the geographical distribution of American thunder-storms. The papers which usually accompany the Report and give it a permanent value are in this case Arago's eulogy on Laplace, Mailly's on Quetelet, and Dumas's on De la Rive; Prof. Hilgard's interesting lecture on tides and tidal action in harbours; De Candolle's notable chapter advocating the English as a dominant language for science; a translation (continued from the previous report) of Morin's elaborate treatise on warming and ventilation; and a letter, by Prof. Warren du Pré, on the so-called North Carolina earthquakes, which literally "made so much noise" in February and March of last year. Prof. du Pré attributes the shakes and explosions to volcanic or earthquake energy, but Prof. Henry inclines to think them caused by either a gradual depression or elevation of the mountain. The stories of issuing smoke and flame were fabulous. The last sixty pages of the Report are given up to Ethnology, with a view to presenting as complete information as possible concerning the location and character of ancient earthworks in America. The accounts here given range from New York to Oregon in one direction, and to Florida and Mississippi in others.

M. BONNAT, a French explorer of the Gold Coast, who had been taken prisoner by the Djuabin, has managed to escape, and is continuing his work along the banks of the Volta, under the protection of Ashantees, amongst whom he is said to have become a favourite.

THE Auricula is said to be the only Alpine plant which has come into general cultivation in the gardens of the rest of Europe. In a pamphlet entitled "Die Geschichte der Aurikel," Prof. Kerner traces the history of the discovery and cultivation of this plant, from the time of L'Escluse (Clusius), who first transplanted this species and the hybrid *P. pubescens*, Jacq., in 1582 from the Tyrolean Alps to Belgium. The latter species, and not the true *P. Auricula*, L., which quickly disappeared from cultivation, is believed by Prof. Kerner to be the real ancestor of the cultivated auriculas of our gardens. The two were known at the time of Clusius under the names of "Auricula-ursi L." and "Auricula-ursi II.," from the supposed resemblance in the shape of the leaves to that of the ear of a bear. The hybrid *P. pubescens*, which had been lost from the German and Austrian Alps for nearly three centuries, was rediscovered by Prof. Kerner in 1867 in a single locality in the Tyrol.

A VERY severe shock of earthquake occurred at Gisborne, New Zealand (east coast), on Sept. 14. Strong shocks were also experienced at Wellington and Blenheim.

A NEW monthly magazine is to be started at Dunedin, of the same character as the *Contemporary Review*.

ACCORDING to a letter published in the *East Anglian Times* of Nov. 24, it would appear that the Corporation of so important a town as Ipswich still authorises the use of local mean time within its liberties, and the business of the place is actually regulated by its edict. Railway time has there a distinct meaning, being 4 min. 40 sec. later than that in general use. We believe that Norwich is in an equally unscientific state as regards time-keeping. It is quite time that an end was put to this absurdity, and we hope some pressure may be brought to bear upon the authorities to effect the long-delayed and desirable introduction of Greenwich time.

IN the October number of the *Quarterly Journal of the Meteorological Society of London*, appear several papers of interest, including one by Dr. Mann, the President, on some practical points connected with the construction of lightning conductors, one by Mr. Symons on a white rain or fog bow, and two very valuable and suggestive papers by the Hon. Ralph Abercrombie, on certain small oscillations of the barometer, and on barometrical fluctuations in squalls and thunderstorms. It may be suggested that the printed "Discussions" on the several papers, however interesting to the members, might be curtailed with great advantage.

THE tri-daily Weather Maps of the United States for the first six months of the present year, issued under the vigorous direction of Brigadier-General Myer, have been received. They show with admirable clearness and distinctness, by the style of printing in colours adopted, the outstanding features of the weather thrice a day. These truly magnificent maps give in every case the weather probabilities for each of the great divisions into which the States have been grouped for this purpose, that are likely to follow within the twenty-four hours then *next ensuing*, and also the actual weather which has been experienced during the *past* twenty-four hours. This method is deliberately adopted by the Office for the express purpose of exhibiting equally its successes and its failures in issuing the weather probabilities, and with the further view of receiving assistance from scientific men, who are thus put in possession of materials for studying the subject, by which the rules that have led to the successes may continue to be followed, and those which have caused the failures may be avoided.

MR. STANFORD has published a handy map of India, showing the route originally sketched for the Prince of Wales's tour. Its moderate price and clearness will recommend it to many who wish to follow the Prince in his wanderings.

THE *Bulletin de la Fédération des Sociétés d'Horticulture de Belgique* for 1874, published under the authority of the Ministry of the Interior, gives evidence of the extent to which horticulture is made a scientific study in that little kingdom. It contains the reports of no less than twenty-five horticultural and agricultural societies affiliated to the Federation; and a list of twenty-one practical questions, for the best solution of which prizes, varying in value from 100 to 500 francs, are offered. There is also appended Prof. Morren's biographical notice of Clusius, to which we have already alluded, and a third edition, completed to October 1875, of the list of the Botanic Gardens, chairs of Botany, and Botanical Museums, throughout the world.

AN admirable epitome of our knowledge respecting the vegetable palæontology of the United States is contained in M. Leo Lesquereux's reprint, "A Review of the Fossil Flora of North

America," printed under the authority of the Department of the Interior. An idea will be conveyed of the wonderful advance of this knowledge in recent years, by the statement that in 1850 Brongniart described in his "Végétales Fossiles" eighteen species of land-plants from North America, whereas upwards of 1,000 species are now known. Of the numerous fossil plants brought by Dr. H. F. Hayden from his exploration of the Western Territories, and found in strata belonging to the Cretaceous formation, by far the majority are remains of Dicotyledons, and included within all three sections, of Apetalæ, Gamopetalæ, and Polypetalæ; and as far as reliance can be placed on characters derived from the foliage alone, a large number belong to genera widely distributed at the present time. The Lower Lignitic flora, on the contrary, belonging to Tertiary times, presents far less resemblance to that at present prevailing in the northern part of North America, but is of a much more southern type.

A BELGIAN practitioner has published a work on the "Maladies which are special to Mystics," the purport of which is to show that Louise Lateau and other persons of the same description might be really total abstainers from food for a lengthened period. The *Revue Scientifique* announces that the Belgian Society of Medicine has ordered that work to be published in its *Comptes Rendus*. M. Charbonnier, the author, advocates the theory that people may subsist without food because the nitrogen from the air can be admitted into the circulatory system, when the body has been emaciated by long abstinence. Feeding on air is an economical way of keeping soul and body together.

AT the opening of the Belfast Natural History and Philosophical Society, the president, Prof. Hodges, delivered an address, in which he reviewed the industrial progress of the North of Ireland. The address was fully reported in the *Northern Whig* of Nov. 11, and has since been separately reprinted.

WE have received the programme of the Cambridge Higher Local Examinations for 1876, for all who have completed the age of eighteen years before January next. The examinations are for both men and women, and the successful candidates are divided into two groups, those who obtain honours and those who do not. The subjects of examination are divided into six groups, one of which includes botany, geology, zoology, and chemistry. The programme seems to us carefully drawn up; an excellent selection of text-books is given.

#### PROF. NORDENSKJÖLD ON THE JENISEI

THE following extract from a letter from Prof. Nordenskjöld to Mr. Oscar Dickson, dated Tomsk, Oct. 13, appears in the *Göteborgs Handels Tidning*. It describes his exploration of the river Jenisei after the departure of the *Pröven* on its homeward journey. Nordenskjöld, Lundström, and Stuxberg left the mouth of the Jenisei on August 19, in a boat built for the purpose, and well provisioned and equipped:—

"The course was taken along the shore within the multitude of low bare rocky islands which bound the mouth of the Bay of Jenisei on the north, and are named in the Russian maps, Severo-Wostotschnoi Ostrow (North-east Islands). The sounds between these islands were thought to be sufficiently deep even for large vessels, though perhaps a little fouled by rocky ground. With a favourable wind and smooth water we sailed without any considerable rest in forty-two hours without a break to Cape Schaitanskoi, arriving there the night before the 21st, thoroughly drenched and worn out with our long watch. During this time we landed only at two places, the first time at a point within Jewremow Kamen, the last rocky promontory which occurs on the eastern bank of Jenisei for a distance of 100 Swedish (upwards of 600 English) miles.

Jewremow Kamen itself consists only of a peculiarly formed dolerite rock fifty or sixty feet high. At the bank were still collected, but for the last time during our passage up the Jenisei, true marine animals; an Appendicularia, Clu, large Beroidæ, various Medusæ, &c. By a land excursion here we

had already obtained a *Harpalus*, two species *Staphylini*, a number of *Acaridæ* and *Poduridæ*, a species of dew-worm,\* &c., and as at the *Pröven's* anchorage, the vegetation has a stamp deviating very much from the flora of *Novaya Zemlya*. Large bush plants, even the dwarf birch, were completely absent, and the ground was in no case covered with a true mat of grass.

The other place where we landed for a little was *Krestowskoje*, a now deserted *simovic* (a place inhabited both summer and winter), which, however, to judge by the number of the houses and the way in which they were fitted up, must once have had its flourishing period. All household articles were removed, and literally there was not to be found an iron nail in the wall; a proof that the inhabitants had not died out, but migrated. The vegetation in the neighbourhood of the huts was extraordinarily luxuriant, the grass and plants forming a real obstacle in walking, certainly occasioned by the quantity of fertilising animal matter which had been collected here during the time when fishing and hunting were carried on.

The surface temperature of the water was, on our arrival at the mouth of the *Jenisei* + 7.8° C., but sank during the storm of the following days to + 1.5° C. At *Jewremow Kamen* it was + 2.5° C., but rose afterwards in the neighbourhood of *Krestowskoje* to + 11° C., a temperature which it afterwards retained during the whole of our journey. The water was brown in colour, but was often at the sides coloured by clayey streams.

A little south of *Jewremow Kamen* the eastern side of the *Jenisei* is occupied by sand-banks twenty to thirty feet high, and sloping steeply towards the river. At the river bank the tundra commences, an endless, inconsiderably undulating plain, full of low marshes and small shallow pools of water, and overgrown with a sparse vegetation, whose flowering time was now almost completely over. Instead we found at our first night quarters (*Cape Schaitanskoj*) great quantities of ripe cloud-berries, the taste of which, excellent in itself, was on this occasion heightened by the circumstance that they were for us the first fruit of summer. The red whortleberry (*Lingon*) and the cranberry (*Odon*) were also found here, if in small quantity. *Cape Schaitanskoj* was the most northerly point on the *Jenisei*, where we found the dwarf birch; and the same place, by *Dr. Stuxberg's* discovery of a species of *Physa*, becomes the most northerly locality for land and fresh-water mollusca.

After having rested at *Cape Schaitanskoj* we sailed on with a favourable wind to *Sopotschnaja Korga*, where the hard wind and a shallow lying off it, the extent of which it was impossible to distinguish during the dusk of the evening, compelled us to lie to earlier than we otherwise intended.

*Sopotschnaja Korga* (the toe of the boot) forms a low promontory projecting far out into the *Jenisei*, which, as numerous ruins of houses show, was formerly inhabited, but is now deserted.

A great part of the promontory was occupied by heaps of drift-wood, large stems, with branches and roots broken off, thrown up over each other in an endless chaos, it being possible to go forward between them only with difficulty and care. The trees that lie nearest the water are quite fresh and in good condition. Other tree stems lying farther from the bank and cast up there a century or centuries ago, are in all possible intermediate states from fresh to completely decayed wood. Between the stems there frequently occur deep holes filled with black stinking water. Heaps of drift-wood like those at this place, though perhaps somewhat smaller, are found almost everywhere farther down towards the mouth of the river, but higher up there occur only scattered pieces of drift-wood, and at some places these are entirely wanting. The point was, besides, strewn with a number of other fresh-water ponds, more or less grown up with water mosses, and full of sticklebacks, Branchiopoda, and other fresh-water Crustacea, and giving the botanist an opportunity of collecting various grasses and water-plants not found farther north (*Carex chondrorhiza*, *Hippuris vulgaris*, *Juncus castaneus*, &c.) Higher up, on drier places, the ground was sparingly covered with *Empetrum nigrum* and *Andromeda tetragona*, and on the steep slopes with which the ground terminates towards the promontory, there is a luxuriant vegetation a couple of feet high, consisting of grass and other plants. The locality was, on the contrary, extremely poor, as well in Mammalia and birds as in insects, and even the holes and paths of the lemming, by which the land on the coast of *Novaya Zemlya* is crossed in all directions, are found here only in limited number.

\* Its occurrence is remarkable on this account, that the ground here, with the exception of an inconsiderable stratum which thaws in summer, is constantly frozen all the year round.

"We sailed on until we finally succeeded in finding a convenient landing-place in the neighbourhood of a little river, *Mesenkin*, which there falls into the *Jenisei* on its right bank." Here they obtained a Cossack, *Feodor*, as guide. While waiting for the guide, the party employed themselves "in examining the natural history of the locality, in making solar observations to determine the position of the place, &c. It appeared by these that our resting-place was situated only about four Swedish (over twenty-four English) miles south of our former landing-place. *Mesenkin's* low river valley is, however, much better protected from the winds of the polar sea than the low promontory at *Sopotschnaja*, and the influence of this was plainly recognisable by its much richer vegetation.

"What first meets the eye on landing is a thicket of dark green bushes about four feet high, which are found to consist of alder (*Alnus fruticosa*). Between the alder-bushes, and protected by them, our botanist found a number of well-grown plants—*Sanguisorba*, *Galium*, *Delphinium*, *Hedysarum*, *Veratrum*, &c. The *Salix* bushes were also higher here than at former places, the mat of grass more abundant, and the slopes of the sandhills in the interior of the country were adorned with a number of new types—*Alyssum*, *Dianthus*, *Oxytropis*, *Saxifraga*, *Thymus*, &c.

"As has been mentioned in a former letter, we found at the part of *Jalma* visited by us neither small stones nor sub-fossil shells in the fine sand. East of the mouth of the *Jenisei* the sand is coarser, and contains both sub-fossil shells and large and small stones. The sub-fossil shells, according to information given to me at *Dudinka*, occur in some places in so large masses that they form true shell banks. At the places visited by us the shells were found not in proper layers, but only scattered through the sand. Immediately at the first glance it appeared that the shells collected by us here belonged in preponderating number to species with which we had become acquainted in the living state during our dredging in the seas of *Kara* and *Obi-Jenisei*.

A sample of the stones which occur in the sandy strata of the tundra was always found at the river bank where we lay, when the lighter particles of sand were washed away, and many important contributions towards a knowledge of the way in which the tundra is formed, and of the nature of the rocks which afforded material for the masses of sand here collected together, were to be obtained. No erratic blocks comparable in size to the erratic blocks in our country occur here, a circumstance which I regard as a proof that the sandy strata of the tundra, at least in these regions, are not of glacial origin. I ought, however, to remark that on a small stone here and there there could be observed striae and scratches completely resembling those found on moraine blocks. But in such cases these scratches have clearly been formed either by the sliding of the earthy stratum or by the action of the river ice.

"In the northern part of the tundra I could never discover among the stones washed out from the sand any blocks of granite or gneiss, but they consisted for the most part of different kinds of basalt with numerous cavities containing lime and zeolites. Besides there occurred, especially at *Cape Schaitanskoj*, in not inconsiderable number, blocks of marl and sandstone, containing fossils partly of marine origin, partly containing rolled tree stems, more or less carbonised or petrified. Pieces of brown and pit coal were also found here in not inconsiderable number.

"On Aug. 26, early in the morning, our guide joined us, accompanied by five other Russians settled in that region. . . . After having talked for some time with our friendly guests, who were exceedingly interested in our expedition, we continued our journey, during which we had splendid calm weather, to *Cape Gostinoi*, where we took our midday rest.

"After resting a little at midday at this place, we sailed on, and came after various wanderings in dusk and mist during the night before Aug. 27, to land at a low promontory, at the mouth of the river *Jakowiewa*.

"Our next resting-place was a specially attractive fishing station at a small sound between the *Briochowski Islands*, the most northerly of the labyrinth of islands which occupy the channel of the *Jenisei* between 69½° and 70°.

"On Aug. 28 we rowed on between a number of islands covered with a luxuriant vegetation, and commonly terminating towards the river with a steep slope, down which large masses of peat tumbled here and there. At such places we could see that the island originally consisted of a sand-bank cast up by the river, which in the length of time was covered first with masses of drift-wood, and afterwards with a luxuriant vegetation which gradually gave origin to a thick stratum of peat, of which the



part of the island above the surface of the water is mostly formed.

"Towards evening we lay to at the Nikandrow Islands in the neighbourhood of a fishing-station still inhabited. Jenisei is renowned for its richness in large eatable fish-species. . . . I hope some months after our return home to be able to exhibit to those among us who are interested in fishing, specimens of most of the varieties of fish occurring here. During our sailing up the river between Dudinka and Jeniseisk, I caused specimens of all the species of fish which we could procure from the river to be carefully deposited in a cask filled with spirit. This collection will be sent to Stockholm *via* St. Petersburg, by a merchant settled in Jeniseisk.

"Like most of the settlers on the lower course of the Jenisei, the inhabitants at Nikandrow fishing-station kept a number of dogs which are believed to be of the same race as the dogs used on Greenland, for draught. The dogs are employed in summer to tow boats up the river, and in winter for all sorts of carriages. Yet the dog, for reasons stated in the introduction to Middendorff's 'Sibirische Reise,' is considered quite unfit for long journeys over uninhabited tracts, if several hunting or fishing stations are not to be met with in the course of the journey. In such cases reindeer are always employed.

"Early next day we sailed, or more correctly, rowed on, the weather being calm and beautiful. We rested at midday in the neighbourhood of a now deserted *simovie* on the southern part of Sopotschnoi Island. Hence we continued our journey first to Cape Maksuninskoi, where we visited a Samoyede family that had set up their skin tent here in order to collect the necessary stock of fish for winter; afterwards to Tolstoj Nos, a still inhabited, well-built *simovie*, where the people living there received us in a very friendly way, and received the account of our journey with great interest and astonishment."

From here the party made haste to catch the last steamer at Saostrowskoj, in the neighbourhood of Dudinka, which they did on Aug. 31.

"We were yet far north of the Arctic circle, and as many imagine that the region we had now passed through, the so little-known tundra of Siberia, is a desert waste, either covered by ice and snow or by an exceedingly scanty moss vegetation, it is perhaps the place here to declare that this by no means is the case. On the contrary, we saw, during our passage up the Jenisei, snow only at one place, a deep valley cleft of some fathoms' extent, and the vegetation, especially on the islands which are overflowed during the spring floods, was remarkable for a luxuriance to which I had seldom before seen anything corresponding.

"The fertility of the soil and the immeasurable extent of the meadow land and the richness of the grass upon it had already called forth from one of our hunters, a middle-aged man, who is owner of a little patch of ground between the fells in Northern Norway, a cry of envy of the splendid land our Lord had given 'the Russian,' and of astonishment that no creature pastured, no scythe mowed the grass. Daily and hourly we heard the same cry repeated, though in yet louder tones, when we some weeks after came to the lofty old forests between Jeniseisk and Turuchansk, or to the nearly uninhabited plains on the other side of Krasnojarsk, covered with deep *tchornosom* (black earth)—in fertility certainly comparable to the best parts of Scania, in extent exceeding the whole of the Scandinavian peninsula. This direct expression of opinion by a veritable if unlearned agriculturist may perhaps not be without its interest in judging of the future of Siberia.

"During this very summer three separate Russian expeditions have travelled through Siberia with the view of ascertaining the possibility of improving the river communication within the country. These expeditions have, according to unofficial communications made to me in Jeniseisk, come to the conclusion that it is possible for a sum of 700,000 roubles to make the Angara (a tributary of the Jenisei) navigable to Lake Baikal, and to connect the Obi with the Jenisei and the Jenisei with the Lena. How great an extent of territory the proposed river communication will embrace is best seen by considering that the territory drained by the Obi-Irtisch and the Jenisei alone is of greater extent, according to Von Baer's calculation, than the river areas of all the rivers (the Danube, Don, Dnieper, Dniester, Nile, Po, Ebro, Rhone, &c.), which fall into the Black Sea, the Sea of Marmora, and the Mediterranean. Part of this territory indeed lies north of the Arctic circle, but here too are found the most extensive and finest forests of the globe; south of the forest region proper there stretch out terri-

tories, several hundred leagues in extent, level, free of stones, covered with the most fertile soil, which only wait for the plough of the cultivator to yield the most abundant harvests; and farther to the south the Jenisei and its tributaries run through regions where the grape ripens on the bare ground: just now, as I write this, I have before me a bunch of the finest Siberian grapes. May the future show that sea communication between these lands and Europe has now been fairly inaugurated.

"A. E. NORDENSKJÖLD."

### SCIENTIFIC SERIALS

*Der Naturforscher*, October 1875.—In this number is given an observation by M. Coulier, that while a cloud was formed in a vessel containing a little water, when an attached caoutchouc balloon was first compressed, then allowed to expand, no cloud was thus produced if the vessel had stood some time at rest, or if the air had been filtered; and the author's view was confirmed that small particles in the air were what caused the formation. M. Mascart has found that strongly ozonised air is not robbed of its cloud-forming action by filtering.—There are two valuable papers in meteorology, one by M. Hann, on the variability of daily temperature, and another in which M. Kerner offers an explanation of the fact that there is, in the Swiss valleys, in late autumn and winter, a middle warm region limited both below and above by a colder.—In physiology we note some interesting researches by M. Bernstein as to what is the highest pitch of tone a muscle may be made to give by electric stimulation. Above 418 vibrations per second of the spring contact, the muscle tone (the same as that of the spring) was distinct, though weaker; at 1,056 vibrations no distinct tone was observed, only a noise. But if the *nerve* were stimulated to the latter degree the muscle gave a tone, not indeed the same as the spring, but a fifth, sometimes an octave, lower. The upper limit beyond which the muscle ceased to give the same tone with the spring (in this arrangement) seemed to be about 933 vibrations. Under chemical stimulus of a nerve, the connected muscle gave a tone like that in natural contraction.—There is also a suggestive paper by M. Delboeuf on the theory of sensation, and M. Hirschberg describes observations on a boy who acquired sight at seven years of age; they favour, he considers, the empiristic theory of sight-perceptions.—In a paper on the origin of the deep-water fauna of the Lake of Geneva, M. Forel thinks the entire fauna of the Swiss lakes are descended from forms which have migrated (up the rivers) since the melting of the glaciers, and have afterwards been differentiated.

*Zeitschrift der Oesterreichischen Gesellschaft für Meteorologie*, Oct. 1.—Dr. Wild, Director of St. Petersburg Observatory, relates the circumstances which led to the Imperial assent being given in June last to the scheme for the establishment at Pawlowsk, distant about an hour by railway from St. Petersburg, of an observatory to be affiliated to the central institution for terrestrial physics over which he presides. The Central Observatory was built twenty-six years ago in an open and quiet space outside the capital. Houses and streets have, however, rapidly been constructed around it, masses of iron are in proximity, and noise and smoke disturb physical measurements, magnetic and meteorological observations. Herr Wild knew that there were serious objections to the removal of the whole establishment into the country, as has been done at Vienna, and determined to recommend a separation into two divisions, one observing and the other administrative, in imitation of the London Meteorological Office and Kew Observatory, the relations to the public of the Russian being similar to those of the English Meteorological Department. On his making this proposal at the Academy of Sciences last autumn, Prince Nicolajewitsch generously presented for the purposes of the new observatory a large piece of ground in his park at Pawlowsk. There will be no reduction in the estimate for the Central Observatory, in order that local observations may be continued, and the accumulated records of former years worked out.—Dr. Hellmann contributes a paper on the physical conditions of the higher atmospheric strata, in which he discusses the observations made in May 1872 by the U.S. War Department at the summit (1,915 metres high), and at the base of Mount Washington, New Hampshire. It appears among other results that the mean difference of temperature for 100 metres of ascent between the hours of 6 A.M. and 6 P.M. and 9 P.M. and 12 P.M. at night was '69° C., and that the difference between 4 and 5 P.M. was '83 and at 6 A.M. only '48° C.; that in 17·4 cases per cent. the wind at the top was the same in

direction as that below ; and that the diminution of temperature with increasing height was greater in clear than in cloudy weather. This last result is in agreement with that of Herr Hann, derived from observations taken at Praya West and Victoria Peak.

SOCIETIES AND ACADEMIES

LONDON

Royal Society, Nov. 19.—“On some Elementary Principles in Animal Mechanics. No. VII. The Law of Fatigue.” By the Rev. Samuel Houghton, M.D. (Dubl.), D.C.L. (Oxon), F.R.S., Fellow of Trinity College, Dublin.

The approximate law of muscular action, which I have called the law of fatigue, is thus expressed :—“When the same muscle (or groups of muscles) is kept in constant action until fatigue sets in, the total work done multiplying by the rate of work done is constant.”

The following experiments, in illustration of this law, were performed in Trinity College during the spring of the present year.

I instructed a number of medical students, chosen at random, to raise dumbbells of varying weight, one in each hand, in the transverse plane, with hands supinated, raising and lowering the weights in equal times regulated by the beat of a pendulum. This process was continued until the distress of the fatigue produced became intolerable, and the number of times each weight was lifted was noted. The students were required to count “one-two,” in time to the beat of the pendulum, so as to prevent them from counting the total number of lifts of the weight. Prof. Macalister assisted me in these experiments ; and one of us counted the number of lifts, while the other compelled the experimenters to observe the conditions of the experiment, which were :—

1. To keep time with the pendulum.
2. To raise the weight in the transverse plane.
3. To supinate the hands.
4. To abstain from all bending of the knees or spinal column.

For each experiment I chose twenty students at random, using altogether about fifty different students ; and no individual was experimented upon again, until an interval of forty-eight hours had elapsed. The object of this arrangement was to avoid the effects of “training.” In my first Table I give the mean result of twenty different students ; and in my second Table I have selected one student, set aside for the purpose, and experimented upon, once a week, so as to prevent the influence of “training.”

Let *W* denote the total work done, and *T* the time of doing it ; then, by the law of fatigue,

$$\frac{W^2}{T} = \text{constant} \dots \dots \dots (1)$$

If *w* be the weight held in the hand, and *a* be half the weight of the arm, and *n* the number of times the weights are lifted ; since the time of raising and lowering the arms is constant, *n* is proportional to *T*, and the law of fatigue gives the formula

$$(w + a)^2 n = A \dots \dots \dots (2)$$

where *A* is an unknown constant. In the following Table I give the values of *w* and the mean value of *n* for twenty distinct persons. The time of lift is in all cases *one second*.

TABLE I.—Mean of Twenty Experiments.

No.	<i>w</i> .	<i>n</i> (obs.)	<i>n</i> (calc.)	Diff.
	lbs.			
1.	2.56	131.80	128.0	+3.8
2.	4.25	87.55	78.3	+9.2
3.	5.87	47.35	53.5	-6.2
4.	6.87	40.25	43.7	-3.5
5.	7.75	34.60	37.1	-2.5
6.	9.75	27.15	26.8	+0.3
7.	14.00	17.20	15.4	+1.8

The column containing the calculated values of *n* was obtained from equation (2) by using the values

$$a = 3.50 \text{ lbs.}$$

$$A = 4699.$$

These values were obtained by finding the value of *a*, which renders *A* most nearly a constant, or

$$\frac{\delta A}{A} = \text{minimum.}$$

This Table gives 7 lbs. for the mean weight of the arm of all experimented on, a result which accords with the known facts.

In Table II. I give the results obtained from a single student, as already described, each value of *n* being a mean of several experiments, closely concurrent.

TABLE II.—Mr. Samuel Warren.

No.	<i>w</i> .	<i>n</i> (obs.)	<i>n</i> (calc.)	Diff.
	lbs.			
1.	2.56	140.0	137.5	+2.5
2.	4.25	91.0	86.4	+4.6
3.	5.87	63.0	60.1	+2.9
4.	6.87	43.0	49.0	-6.0
5.	7.75	40.0	42.5	-2.5
6.	9.75	32.0	31.0	+1.0
7.	14.00	18.5	17.9	+0.6

The calculated values of *n* were found from equation (2), using the values

$$a = 3.9 \text{ lbs.}$$

$$A = 5737.$$

which were obtained from the principle of least variation of *A*, or

$$\frac{\delta A}{A} = \text{minimum.}$$

In the accompanying diagrams I. and II., I have plotted the cubical hyperbola represented by equation (2) ; and also the several observations which lie sufficiently near the curve to justify me in considering the law of fatigue to be a first approximation to one of the fundamental laws of muscular action. I have elsewhere\* shown that the law of fatigue corresponds with other experiments based on different data.

If we consider the *useful work* only, we have from equation (2),

$$\text{useful work} = wn = \frac{A w}{(w + a)^2} \dots \dots \dots (3)$$

This equation represents a cuspidal cubic, whose ordinate has a maximum value, when *w* = *a* = half the weight of the arm.

The foregoing observations are in accordance with this deduction, as may be seen from Table III.

TABLE III.—Useful Work.

No.	<i>w</i> .	<i>wn</i> (so experiments).	<i>wn</i> (Mr. Warren).
	lbs.		
1.	2.56	338	358
2.	4.25	372	387
3.	5.87	277	370
4.	6.87	276	295
5.	7.75	268	310
6.	9.75	264	312
7.	14.00	241	250

It is to be observed, that in the foregoing experiments the muscles in action were not allowed to *rest* during the whole time of work.

Linnean Society, Nov. 18.—Dr. G. J. Allman, F.R.S., president, in the chair.—The following paper was read :—On the organisation and systematic position of the Ornithosauria, Part I., by Prof. H. G. Seeley, F.L.S. The different results obtained by investigators who have written upon Pterodactyles, led the author to propose a method of research in Comparative Anatomy by which the true nature of these animals could be determined. It consists chiefly in an attempt to distinguish between the characters which make animals members of a class of Vertebrata, and the characters which make those animals members of vertebrate ordinal groups. The class characters were regarded as furnished by the soft vital organs, while the ordinal characters are derived from the skeleton. This was illustrated by an argument tending to show that since the form of brain,

\* “Principles of Animal Mechanics” (London, 1873).

and the peculiar respiratory organs of birds, are class characters, any animal would be a member of the class *Aves* which possessed them; and since the form of skull, of vertebrae, of the carpus and tarsus are ordinal characters in the existing sub-class of birds, they will not necessarily be found in an extinct sub-class or order of *Aves*. He then showed that Pterodactyles have the brain identical with the bird's brain in every detail; and the pneumatic perforations of the bones for the prolongation of air-cells from the lungs into the bones were identical in both types and are found in no other group of animals. Hence it was concluded that, judged by class characters, Ornithosaurs must be placed in the class *Aves*. The author then gave an analysis of the characters of the Ornithosaurian skeleton. In the skull, he thought that the bone hitherto named post-frontal is the quadrato-jugal, and that although the malar bone meets the quadrato-jugal bone, there are no reptilian features in the skull, and nothing which is inconsistent with the Avian organisation. The vertebral column is the most reptilian part of the skeleton in being procelous, but the fore limb was shown to be constructed on the Avian plan; the carpus being nearly identical in both groups; while the elongated finger for flight was proved by its carpal articulation to be the index finger as in birds; and in one Pterodactyle it contained two phalanges, as in birds. The petagial membranes of the Pterodactyle were also shown to be extensions of the similar membranes of birds. The characters of the pelvis and hind limb were less unlike those of a bird than had been supposed, the tibia terminating distally in a trochlear end formed as in birds by the ankylosed proximal tarsal bone. From the whole skeleton (excluding the evidence of the cerebral and respiratory characters) the author concluded that it is impossible on morphological grounds to exclude the Ornithosauria from the Avian class, and that their resemblances to reptiles are not more important than their resemblances to mammals.

Geological Society, Nov. 17.—Mr. John Evans, V.P.R.S., president, in the chair.—Mr. Robert Elliott Cooper, C.E., 1, Westminster Chambers, Victoria Street, S.W.; Mr. George Fowler, Assoc. Inst. C.E., Bastford Hall, Nottinghamshire; and Mr. William Frecheville, Assoc. Royal School of Mines, 51, Scarsdale Villas, Kensington, W., were elected Fellows of the Society.—On a new modification of Dinosaurian Vertebrae, by Prof. Richard Owen, F.R.S. The peculiar modification of the Dinosaurian vertebra noticed by the author occurs in *Tapinocephalus Atherstoni* and *Pareiosaurus bombadens*. In the dorsal vertebrae of the former the centra are nearly flat on both fore and hind surfaces, a structure to express which the author proposes the term "amphiplatyan." The hind surface is very slightly the more concave. The middle of each surface is pierced by a small foramen leading into a cylindrical canal, first slightly expanding and then rapidly contracting to a point, which meets the apex of the similar hollow cone coming from the opposite surface. Similar characters were observed upon the free surface of the anterior sacral and upon that of the posterior of four ankylosed sacrales. The dorso-lumbar vertebrae of the *Pareiosaurus* had centra relatively longer than those of *Tapinocephalus*. Their articular surface is subundulate, convex along a fourth of the periphery, concave at the centre, where there is an excavation corresponding to that in *Tapinocephalus*, but a relatively wider aperture, a rather more constricted canal, a shorter terminal cone, and an interval of osseous tissue separating the apices of the cones from the fore and hind surfaces. In what is probably the first cervical vertebra of the same Dinosaur, the centrum is so concave on both surfaces as to become amphicoelian. In these unossified tracts of the middle of the centrum in the two genera above mentioned the author sees indications of a persistent trace of the primitive "chorda dorsalis;" and he calls attention to the resemblance thus set up between these probably Triassic Dinosaurs and the lower Ganocephalous reptiles of the Carboniferous series, in which, however, the vertebral centra are more widely perforated.—On the presence of the Forest-bed Series at Kessingland and Pakefield, Suffolk, and its position beneath the Chillesford Clay, by Mr. John Gunn. In this paper the author described a section from the cliff at Kessingland and Pakefield, from the examination of which he arrived at the conclusion that the Forest-bed series underlies the Chillesford Clay and sands. At the foot of the cliff there is an estuarine deposit forming the soil of the Forest-bed, consisting of blue clay and gravel, the "Elephant-bed" of the author's former paper. Above this is the Forest-bed, containing large stools and stems of trees, but no fossil bones. This is followed by a fresh-water deposit, consisting of black soil with fresh-water shells, corresponding to a simi-

lar bed at Mundesley and Runton known as the "Unio-bed," and including the "Rootlet-bed" of oozy clay, regarded by Mr. Prestwich as an indication of the forest. The author considers the supposed rootlets to represent brushwood which succeeded the true forest. Above this come Fluvio-marine deposits, in which Cragshells occur, although but rarely. To this division the author was inclined to refer the Norwich Crag, which at Bramerton underlies the next division, regarded by the author as the Chillesford Clays and Sands. Of the overlying deposits the first is supposed to be the "Pebble-bed" by the author; it has been regarded as Middle Drift, and the uppermost is Upper Boulder-clay. The paper was illustrated by the exhibition of a fine series of bones, chiefly Cervine, from the lowest deposit noticed by the author.

Physical Society, Nov. 27.—Prof. G. C. Foster, F.R.S., vice-president, in the chair.—The following candidates were elected members of the Society:—Prof. Osborne Reynold's, M.A., Prof. H. J. Smith, M.A., LL.D., Prof. R. B. Clifton, M.A., F.R.S., C. Busk, J. Thomson, J. W. W. Waghorn, W. Esson, M.A., F.R.S., F. W. Bayly, and Prof. R. W. Emerson Mac Ivor.—Prof. Guthrie briefly described Dr. Kerr's recent experiments to show that glass, resin, and certain other substances exhibit a depolarising effect when under the influence of powerful electrical tension, and he exhibited the arrangement of apparatus employed in the research. He also showed certain experiments connected with the investigation.—Dr. Guthrie then made a communication on "Stationary Liquid Waves," in continuation of that which he made to the Society in June last. If water in a cylindrical vessel not less than 9 inches in diameter be agitated by depressing and elevating a flat circular disc on its surface at the centre, a form of oscillation is set up which the author terms "binodal." He finds that these fundamental undulations in an infinitely deep circular vessel are isochronous with those of a pendulum whose length is equal to the radius of the vessel, and further, a fact which is extremely interesting, that the motions of the pendulum and water keep together throughout their entire paths. An arrangement was exhibited for experimentally demonstrating these facts. To the upper end of a short pendulum with a heavy adjustable bob is attached a cardboard sector in the plane of vibration of the pendulum. A silk thread, attached to the edge of this sector, carries a small paraffin disc which rests at the centre of the surface of the water contained in a cylindrical vessel. The pendulum-length is adjusted until the motion of the disc is isochronous with that of the water when the two are not in contact. Two other forms of motion may be produced in cylindrical vessels, namely (1), by alternately compressing and extending opposite ends of a diameter as in the motion of a bell—this gives two diametral nodes at right angles to each other; and (2), by rocking the vessel, which gives a single diametral node. Each of these has its own period of vibration, the last being the slowest. They may be superimposed on each other, and a rotation of the water, however great, does not interfere with their formation. In rectangular troughs a binodal and a mononodal wave system may be established. The former is induced by raising and depressing a wooden lath at the middle of the surface, and the latter by tilting. Binodal vibration in a circular trough may be compared with a vibrating pair of triangular laths, and in rectangular troughs to the balancing of two rectangular laths. In this latter case the nodes are at  $\frac{1}{4}$  of the trough length from each end. Some discrepancies are met with when we compare times of vibration in rectangular troughs of various lengths, and these are due to a scraping action which takes place against the ends of the vessel. The result of the experiments on binodal motion in rectangular vessels is to show that the undulations are isochronous with the oscillations of a pendulum whose length is  $\frac{2}{\pi}$  times that

of the trough. The chief points in connection with this subject to which the author referred as still requiring explanation, are: (1) Why are the motions pendular? (2) How is it that in circular binodal motion the times are identical with that of a pendulum of the given length? and (3) What is the mathematical connection between the individual motion of each particle and that of the mass? Mr. Lodge thought that valuable results might be obtained by treating the mass of moving water as a pendulum with two bobs oscillating about the node. This might be specially useful with small oscillations, when the surface is practically plane.

Anthropological Institute, Nov. 23.—Colonel A. Lane Fox, F.S.A., President, in the chair. The President read a full

report, prepared by himself, on the excavations lately made by the Exploration Committee of the Anthropological Institute in Cissbury Camp, near Worthing, Sussex, and illustrated it by a series of diagrams and models and a large collection of flint implements, flakes, &c. The animal remains found in the excavations, including the skeleton of a woman, were exhibited and described by Professor Rolleston, F.R.S.

Institution of Civil Engineers, Nov. 23.—Mr. Thos. E. Harrison, the president, in the chair. The paper read was On experiments on the movement of air in pneumatic tubes, by M. Charles Bontemps, Engineer in the French postal service.

## EDINBURGH

Scottish Meteorological Society, Nov. 15.—At a meeting of the council of this society there was read a correspondence between Mr. Archibald Young, Fishery Commissioner, and Mr. T. Stevenson, the honorary secretary, regarding an investigation into the habits of the salmon.—Besides other elaborate investigations of a national character which the society has at different times undertaken, an inquiry, suggested by the president, the Marquis of Tweeddale, into the meteorological conditions which are supposed to affect the migrations of the herring, is being carried out by Mr. Buchan. For this purpose the temperature of the sea is observed at different parts of the coast; and stations where maximum and minimum thermometers are constantly immersed have been established. The investigation into the habits of fishes is now to be further extended to those of the salmon. For some years back observations have been made by Mr. Paulin on the depth and temperature of the water and the takes of fish in the Tweed, and these are being discussed by Mr. Paulin and Mr. Buchan. Observations were also made for some years on the temperature of the Doon in Ayrshire. But the inquiry suggested by Mr. Young has more especial reference to the question of the earliness or lateness of the different rivers, which among other causes may be found to be due to the temperature of the fresh water as compared with that of the salt water into which the rivers discharge. It is hoped that by means of this investigation the causes which produce late and early rivers may be elicited, and the best times for closing and opening different rivers for fishing may be more satisfactorily determined than at present. On the suggestion of Mr. Young, different late and early rivers have been selected for observation, and the necessary arrangements for carrying these on are being established, and those connected with the river Ugie, in Aberdeenshire, are now completed, and the observations will be commenced immediately. At Peterhead the Harbour Commissioners have on the suggestion of Mr. Stevenson established a station for thermometers under continuous immersion, which has for some years been superintended by Mr. Boyd, who is a member of the Committee, and who has kindly undertaken, in connection with the sea-temperatures at Peterhead, to ascertain those of the fresh waters of the Ugie.

## DUBLIN

Royal Irish Academy, Nov. 8.—Dr. Stokes, F.R.S., president, in the chair.—Dr. S. Ferguson, V.P., read a paper On the alleged literary forgery respecting Sun-worship on Mount Callan.—The Secretary read a paper by Dr. Doberck, On the binary stars, 44 Bötis, ζ Cassiopeiæ, and μ Draconis (this paper will appear in an early number of the "Transactions.")—Dr. Macalister read Notes on anomalies in the course and distribution of nerves in man. The following parts of vol. xxv. of "Transactions" were laid on the table:—Part 16, Researches on the Structure of the Spines of the Diadematidae, by H. W. Mackintosh plates 31\* to 33; part 17, on Nine-point Contact of Cubic Curves, by Dr. Hart; part 18, Experiments on the Movements of Water in Plants (part ii.), by Prof. M'Nab, M.D.; part 19, on the Binary Stars α Coronæ, τ Ophiuchi, γ Leonis, ζ Aquarii, 36 Andromedæ, and ι Leonis, by Dr. Doberck; part 20, Report on the Superinduced Divisional Structure of Rocks called Jointing, and its Relation to Slaty Cleavage, by Dr. W. King (plates 34 to 38); this part concludes vol. xxv., and is accompanied by a title-page and table of contents; also the July and October parts of the "Proceedings."

## PARIS

Academy of Sciences, Nov. 22.—M. Frémy in the chair.—The following papers were read:—Thermal researches on citric acid, by MM. Berthelot and Longuiné.—Remarks on the interpretation of two tables of chemical analyses, by M. Duchartre. This refers to treatment of beet.—On the periodicity of

great movements of the atmosphere, by M. Sainte-Claire Deville. From two years' observations he shows a quadruple, dodecuple, and tridodecuple period in recurrence of barometric maxima and minima in the year.—Continued observations of eclipses of the satellites of Jupiter, made at the Observatory of Toulouse, by M. Tisserand.—New observations on the law of expansion in steam-engines, by M. Ledieu.—Remarks on the Balænidæ of the Japan seas, *à propos* of the cranium of a Cetacean of this group sent to the Museum by the Japanese Government, by M. Gervais.—M. Pierre exhibited a specimen of fibres of remarkable length and tenacity, obtained by setting a stem of *Lavatera*.—On the mechanism and the causes of changes of colour in the chameleon, by M. Bert. There are two sets of nerves, the one bringing the coloured corpuscles out to the surface (and comparable to vaso-constrictor nerves), the other bringing them under the dermis (corresponding to the vaso-dilator nerves). Each cerebral hemisphere commands nerves on both sides of the body, and is generally excited through the eye on the other side; but it acts chiefly on nerves of the vaso-constrictor type on its own side, and the other kind on the opposite side. Blue violet rays act directly on the corpuscles, bringing them to the surface.—Granitic diluvium in the neighbourhood of Paris; Lithology of the sands of Beynes and St. Cloud, by M. Salvétat.—On the electrolysis of bodies of the aromatic series, by M. Goppelsroeder.—On the fixation of atmospheric nitrogen in soils, by M. Truchot.—Water of the Vanne, and distilled water; examination of the salt of brine, by M. Monier.—On the construction of lightning conductors, by M. Saint-Edme.—On the formation, structure, and decomposition of the swellings produced on the vine by Phylloxera, by M. Max. Cornu.—Observations on the planet Jupiter (continued), by M. Flammarion.—New examples of representation, by geometrical figures, of the analytical conceptions of geometry of  $n$  dimensions, by Mr. Spottiswoode.—On employment of marine chronometers in the German navy, by M. Peters.—On co-ordinated surfaces, such that at every point considered as centre of a sphere of constant radius, the normals to the surfaces, form in this sphere the apices of a spherical triangle of constant area, by M. Aoust.—On the numbers of Bernoulli, by M. Le Paige.—On a reaction of the homologues of ethylene, which may explain their absence in the natural petroleum, by M. Le Bel.—Remarks *à propos* of the discovery of gallium, by M. Mendeleef. In accordance with a law he enunciated in 1869, he thinks the new metal may be ekaaluminium.—On the saccharification of amylaceous matters, by M. Bondonneau.—On stripping off the leaves of the beet, by M. Violette.—Troilite; its true mineralogical and chemical place, by Mr. Lawrence Smith.—On certain alterations of agates and silice, by M. Friedel.—On explosive compounds; influence of the fuse on compressed gun-cotton, by MM. Champion and Pellet.—Researches on the functions of the spleen, by MM. Malassez and Picard. The increase of globular richness in the blood of splenic tissue is not due to concentration of blood, for the quantity of iron diminishes.—On the ichthyologic fauna of the Isle of Saint Paul, by M. Sauvage.—Examination of rain-water in the udometers of Paris Observatory, Oct. 14 to Nov. 15, 1875, by M. Gerardin.—On the action of monohydrated and trihydrated phosphoric acid on coagulation of blood, by M. Oré.

## CONTENTS

	PAGE
THE GOVERNMENT AND THE POLLUTION OF RIVERS . . . . .	81
MANCHESTER SCIENCE LECTURES. By W. F. B. . . . .	82
RECENT AUSTRALIAN EXPLORATIONS . . . . .	83
OUR BOOK SHELF:—	
Saville Kent's "Official Guide-book to the Manchester Aquarium" . . . . .	85
Browne's "Elementary Science Manuals" . . . . .	85
LETTERS TO THE EDITOR:—	
Hoffmeyer's Synoptic Weather Charts.—ROBERT H. SCOTT, F.R.S. . . . .	85
Colomia.—A. G. . . . .	85
Sir Thomas Millington and the Sexuality of Plants.—ALFRED W. BENNETT, F.L.S. . . . .	85
The Late Eclipse.—DR. ARTHUR SCHUSTER . . . . .	86
Lommel's Optics.—W. F. B. . . . .	86
The Rainfall.—COL. J. PUCKLE . . . . .	86
A New Palmistry.—JOHN C. GALTON; M. M. PATTISON MUIR . . . . .	87
Faye on the Laws of Storms.—JOSEPH JOHN MURPHY . . . . .	87
OUR ASTRONOMICAL COLUMN:—	
Satellites of Uranus . . . . .	87
The Minor Planets . . . . .	87
Publications . . . . .	88
DR. R. VON WILLEMOES-SUHM. By Prof. WYVILLE THOMSON, F.R.S. . . . .	88
THE PENIKES SCHOOL . . . . .	89
THE THEORY OF "STREAM LINES" IN RELATION TO THE RESISTANCE OF SHIPS, II. By WM. FROUDE, F.R.S. (With Illustrations) . . . . .	89
NOTES . . . . .	93
PROF. NORDENSKJÖLD ON THE JENISEI. By Prof. A. E. NORDENSKJÖLD . . . . .	95
SCIENTIFIC SERIALS . . . . .	97
SOCIETIES AND ACADEMIES . . . . .	98

THURSDAY, DECEMBER 9, 1875

## SCIENTIFIC AGRICULTURE

FARMING is a complex business. It embraces a greater variety of objects and interests than any other industrial pursuit. Its two great ends are the production of crops and the production of animals. It is among the oldest occupations of man. Its history has been very peculiar. In our own day the system of farming pursued by the great bulk of occupiers of land is far behind the state of agricultural knowledge; and many of the practices of the most enlightened of our farmers are based on empirical data. Various agencies have been proposed for promoting agricultural progress. For the instruction of the mass we must look chiefly to the diffusion of agricultural knowledge through the medium of ordinary schools and colleges, as was pointed out some time ago in NATURE. For further progress in the acquisition of accurate knowledge we must look chiefly to experimental investigations.

In Germany they have had in operation for some years a number of experimental stations which are partly supported by the State, and which are said to work satisfactorily. France and other European countries are following the example of Germany. Recently the subject has been ventilated in Great Britain. It has been forced on our attention by a number of persons who are seemingly desirous of giving to the farmer every aid which science can suggest.

British experience of experimental stations is very limited. We happen to have one at Rothamstead in England, which was described in NATURE last year, and which we owe to the enterprise of Mr. John Bennett Lawes, F.R.S., the great manure manufacturer. He has for upwards of thirty years used a part of his estate for experimental purposes. He has published the results in a vast number of papers. The whole is the work of the man himself. He has had no aid from the Government or any agricultural society, and no advice from any committee or public body. He has obtained a larger body of facts in relation to manures and cropping, and the feeding of animals, than all the agricultural societies in the empire put together. It is manifestly desirable to dwell on his labours and to contrast them with the more public system projected elsewhere.

To Mr. Lawes' experiments I hope to be able to devote another paper before long. For the present I shall merely draw attention to the circumstances on which, in my judgment, the success which has attended his labours has depended. Mr. Lawes has not had an unqualified success, especially in drawing inferences from his facts. But his writings afford ample evidence of great earnestness of purpose. His manly, outspoken language shows that he loves truth for its own sake. He has had ample resources; and he has had the motive of self-interest, as well as love of knowledge, to stimulate him in his investigations.

Here, then, we have a private individual who, unaided by the State, or by any scientific body, has made a greater number of useful experiments than all the experimental farms of European Governments put together. Had the British Government established experimental stations

before Mr. Lawes commenced, would he have established his? And if not, would British agriculture have derived more useful results from the governmental stations than from his?

These are questions which cannot be answered by direct evidence. We possess, however, data which enable us to throw light upon them. It is notorious that the agriculture of Scotland has made great progress within the past one hundred years. The improvement of agriculture within that period has been greater in parts of Scotland than in any part of England. Yet the demand for means of effecting further progress is greater among the most advanced farmers of Scotland than among the most advanced English farmers. There is no man in Scotland who has come forward, or offers to come forward, to do for Scotland what Mr. Lawes has done and offers to do for England. The friends of agricultural progress in Scotland are endeavouring to effect, by co-operation, what the private enterprise of Mr. Lawes is doing for England. The subject has been discussed in English agricultural classes, more or less, for several years. The discussion has during the past few weeks assumed a practical shape to which it may be useful to refer. A member of the Council of the Royal Agricultural Society of England, Mr. Randell, desires to "prove, by a series of experiments, under every variety of soil and circumstances, how far the accuracy of the estimated value of manures obtained by the consumption of different articles of food as given by Mr. Lawes, is confirmed by practical results." Mr. Randell was supported by the Earl of Lichfield and Lord Vernon, and the matter was referred to the Chemical Committee of the Society. Mr. Randell has so far confined himself to one point, which has been suggested to his mind by the passing of the Agricultural Holdings Act of 1875. If one or more stations be established, the experiments would of course cover a wider field. The question arises at once, how are the experiments to be directed? Could Mr. Lawes be induced to act as Director-General? He could be assisted by a representative council. In due time the best man to succeed him would appear.

In Scotland the movement has of late been agitated with energy and intelligence. The Royal Agricultural Society of that country, better known as the Highland Society, has a large surplus fund, and contains among its members the leading gentry, many enlightened professional men, and a great array of intelligent farmers. It has been suggested that some of this fund should be applied to the maintenance of experimental stations. Several reports and suggestions have been made. It is said that a sum of 700*l.* a year, and no more, is available for the purpose.

One of the reports goes on to state that "considering the advantages which had already been derived from chemistry in its application to agriculture, it was expedient to reorganise a chemical department under the cognisance of the Society, for the purpose of conducting investigations on all subjects relating to agriculture; and that in connection therewith a series of carefully conducted experiments in the open ground be instituted." The directors found that the Society had at its disposal, for the purpose of the chemical department and field experiments, a sum of 700*l.*, which they recommended should be set aside for a period of seven years. In

carrying out these recommendations they suggested that the 700*l.* should be expended as follows:—"Chemist's salary, 300*l.*; agricultural inspector's salary, 150*l.*," &c.

The report must render it plain to anyone who has had experience in experimental work of the kind contemplated that this part of the recommendation is based on imperfect knowledge. What evidence is there in the history of the Society, or elsewhere, which goes to show that the best man to initiate and conduct investigations on all subjects relating to agriculture should be a professional chemist? Such a man should have a good general knowledge of all the sciences relating to agriculture. He should be well known as a man of broad views and great grasp of mind. He should, moreover, be thoroughly conversant with the details of modern agriculture. He should have given evidence of being imbued with an ardent desire to elicit truth, as well as of his taste and fitness for conducting experiments. We submit that a really good chemist, possessing all these qualifications, can seldom be found. If he exists in Scotland, let him by all means be made director of the proposed station or stations; not, however, because he is a chemist, but because he is the best man. There are many chemists who would doubtless be glad to accept such an appointment, and who would be as unfit for it as for the direction of the Channel fleet. It seems incredible that any body of thoughtful men would propose to trust the initiation and direction of experiments on crops and animals to a man who would not necessarily know anything of the habits of either.

A most peculiar part of the report of the committee to which the Highland Society referred the consideration of this question is the remuneration (150*l.* a year) they propose for an agricultural inspector. If the views of the committee were acted on, the *bonâ fide* value of the experiments would depend on this officer. He should be an accomplished agriculturist. He should possess great intelligence, the highest personal character, and the most rigid love of truth, as well as the sternest sense of duty. He would be expected to initiate experiments from which results of national importance would flow. And this is the man for whom the munificent sum of 150*l.* a year is proposed! If a man like Mr. Lawes were to undertake the duty, he would accept no remuneration. In this case 150*l.* a year may be a fair sum to cover travelling and other expenses. But if a competent man is to be employed who cannot afford to work gratuitously, a salary equal to that of the average of intelligent professional men must be offered. This part of the Report has been already denounced in strong and emphatic language; and we understand it has been opposed by leading members of the Society who value science and appreciate the work to be done. The action of the committee has been openly exposed by Mr. David Milne Home, an ardent advocate of the application of science to agriculture, and by Mr. John Wilson, of Eddington Mains, a truly enlightened farmer. These gentlemen contend that the directing head or body should have the power to call in the professional aid of the best chemist or chemists, and such other experts as may be needed. This view is based on common sense. If they prevail in the councils of the Society, we may expect to see ere long in Scotland agricultural stations which in all human probability will give a new stimulus to agricultural progress. If they fail, and

the work is entrusted to men who are not in every way equal to it, we may get an annual crop of worthless or misleading results, like those which have formed so large a portion of our agricultural literature.

While the Royal Agricultural Society of Scotland is discussing these matters, a local Agricultural Association formed in Aberdeenshire has actually fixed sites for five stations, at which experiments will be conducted for three years. The Marquis of Huntley is president of the Society, and Mr. Barclay M.P., is among the active members. A sum exceeding 1,000*l.* has been already subscribed. For the present the experiments will be confined to the determination of the best states in which to apply phosphates and nitrogen. Each plot is to be 1-112th part of an acre. It is to be regretted that potash and one or two other constituents of plants will not be tried. In some respects the scheme devised by the Association corresponds with that which I have carried out at Glasnevin for several years, and the results of which I have not, owing to pressure of other work, been able to publish. In the Glasnevin experimental ground the several crops are crossed by the manures; and thus we bring out the results in a striking way, and guard against inequalities in the soil. We also raised three consecutive grain crops without manure before commencing the experiments.

THOMAS BALDWIN

### THE NEW GEOMETRY

*Syllabus of Plane Geometry* (corresponding to Euclid, Books i.-vi.) Prepared by the Association for the Improvement of Geometrical Teaching. (London: Macmillan, 1875.)

THE readers of NATURE are so well acquainted with the genesis and growth of the Association whose syllabus has recently been given to the public, that we are relieved from all necessity of explaining what objects it has in view. The main result of its five years of labour is this Syllabus, and we shall here briefly exhibit some of its chief features. It is a double syllabus, being a syllabus of geometrical constructions and a syllabus of plane geometry. The former is very brief, and contains such constructions as can be made with the ruler and compasses only. This subject of constructive geometry has been tried in many schools of late and has been found generally to answer the end in view. Boys thus obtain some idea of the objects of pure geometry and of what is involved in the postulates of the science. The more important syllabus is prefaced by a Logical Introduction—not that the Association wishes "to imply by this that the study of geometry ought to be preceded by a study of the logical independence of associated theorems." The opinion of the compilers is "that at first all the steps by which any theorem is demonstrated should be carefully gone through by the student, rather than that its truth should be inferred from the logical rules here laid down. At the same time they strongly recommend an early application of general logical principles." The President, in one of his addresses, states that the object of this introduction is "to guide the teacher immediately, and the student ultimately." It contains certain general axioms (as the whole is greater than its part), and taking as its typical theorem, if  $A$  is  $B$



then  $C$  is  $D$ , it explains what is meant by its *contrapositive* (if  $C$  is not  $D$ ,  $A$  is not  $B$ ), by its *converse* (if  $C$  is  $D$ ,  $A$  is  $B$ ), and by its *obverse* (if  $A$  is not  $B$ ,  $C$  is not  $D$ ). This last term we have heard strongly condemned; it was substituted (see Fifth Annual Report) for the more usual term *opposite* on the ground that, in logic, two opposite propositions cannot be true together. The terminology, however, to our mind, is a matter of no great consequence. For proving converse theorems frequent use is recommended in the work of a "Rule of Identity" here given, *i.e.* if there is but one  $A$  and but one  $B$ , then if  $A$  is  $B$ , it necessarily follows that  $B$  is  $A$ . (De Morgan's illustration is given in Wilson's Geometry.)

The *Straight Line* is the subject of Book i., and takes up five sections, Angles at a point, Triangles, Parallels and Parallelograms, Problems, and Loci. Here, in the definitions, we have two difficulties to meet, What is a *straight line*? what is an *angle*? The former is defined to be "such that any part will, however placed, lie wholly on any other part if its extremities are made to fall on that other part." The latter is stated to be a "simple concept incapable of definition;" its nature, however, is explained and illustrated in some detail. Parallel straight lines are defined as in Euclid, and Playfair's axiom is Axiom 5. Theorem 21 (Euc. i. 27) is proved as the contrapositive of Theorem 9 (Euc. i. 16); Theorem 22 (Euc. i. 29) by Rule of Identity, using Axiom 5. Book ii. treats of *Equality of Areas* (Theorems, Problems); Book iii. is on [the *Circle*. Here a novelty is the treatment of Tangents in two sections, directly, then by the method of limits. Some, if not all, of De Morgan's suggestions ("Companion to British Almanac, 1849) on this subject have been adopted here. The Syllabus so far is not a novelty to many of our readers. Those possessed of Mr. Wilson's "Elementary Geometry" (3rd edition) will know that he has in the main, if not altogether, adopted the lines laid down in the Association's work, adding proofs in full, and much interesting illustrative matter. It hardly needs our saying that the method of superposition is freely used, and that alternative constructions are indicated.

We come now to Books iv. and v., which cover pretty much the same ground, except that in the former book we have the subject of proportion and its application treated in a thoroughly rigorous method, which is a simplification of Euclid's mode of treatment by multiples. In the latter book the same subjects are treated in a confessedly incomplete manner (for commensurables only) for the use of students whose capacities or time may be limited.

Similar figures, areas, loci, and problems complete Book v.

We shall conclude our notice by taking a few extracts from the report made by the committee appointed by the British Association "to consider the possibility of improving the methods of instruction in elementary geometry."

"It seems advisable that the requisite uniformity should be obtained by the publication of an authorised syllabus, indicating the order of the propositions, and in some cases the general character of the demonstrations, but leaving the choice of the text-book perfectly free to the teacher. . . . The committee recommend that the teaching of practical geometry should precede that of theoretical

geometry, in order that the mind of the learner may first be familiarised with the facts of the science, and afterwards led to see their connection. With this end the instruction in practical geometry should be directed as much to the verification of the theorems as to the solution of problems. . . . It appears that the principle of superposition might advantageously be employed with greater frequency in the demonstrations, and that an explicit recognition of it as an axiom of fundamental assumption should be made at the commencement. . . . The committee think also that it would be advisable to introduce explicitly certain definitions and principles of general logic, in order that the processes of simple conversion may not be confounded with geometrical methods."

The Syllabus now published is under the consideration of this body of distinguished mathematicians, who will report upon its merits and discuss the advisability of giving it the authority of the British Association. In the mean time it will be of considerable service if teachers will practically test it for themselves, and make known their views of its adaptation or want of adaptation for the end proposed. We may remark that Def. 38 (when a straight line intersects two other straight lines, it makes with them eight angles, which have received special names in relation to one another) is not quite correct, for the three lines may cointersect, and then six angles only are formed. Introduce the words "in two distinct points" between "straight lines," and "it makes."

#### ESKIMO TALES AND TRADITIONS

*Tales and Traditions of the Eskimo, with a sketch of their Habits, Religion, Language, and other Peculiarities.* By Dr. Henry Rink. Translated from the Danish by the Author. Edited by Dr. Robert Brown. With numerous Illustrations drawn and engraved by Eskimo. (Edinburgh and London: Blackwood and Sons, 1875.)

DR. Rink is probably the greatest living authority on all matters connected with the Greenland Eskimo. The high value of his contributions to our knowledge of Greenland and its people is universally admitted. The English reading public, and English ethnologists especially, will no doubt be grateful to him for having put his "Eskimo Tales and Traditions" into an English dress. The translation is perfectly idiomatic and altogether creditable to the author.

Not the least valuable portion of the work is the introduction, treating of the Eskimo themselves, in which, in a few short chapters, Dr. Rink presents a succinct and clear statement of all that is at present known of these interesting people. For his present purpose Dr. Rink divides the Eskimo into seven groups, groups which, we think, have quite marked enough distinctions to be regarded as convenient for most other purposes; they are as follows:—1. The East Greenlanders; 2. The West Greenlanders; 3. The Northernmost Greenlanders or Arctic Highlanders of Sir John Ross; 4. The Labrador Eskimo; 5. The Eskimo of the Middle Regions, from Baffin and Hudson Bays to Barter Island, near the Mackenzie River; 6. The Western Eskimo, from Barter Island to the west and south; and 7. The Asiatic Eskimo.

Anything like national or tribal union, however, seems untraceable, although at various periods, no doubt, the small communities of particular districts have united against a common enemy. The only communities which Dr. Rink can trace as anything like permanent are—1. The Family, the tie which unites the various members of which seems to be very strong; 2. The Housemates, or inhabitants of a house; for generally, except recently in some parts of Danish Greenland, one house sheltered two or more families which necessarily had many things in common, and many mutual duties and obligations; and 3. Place-fellows, or the inhabitants of the same hamlet or wintering-place, among whom communism in certain matters was distinctly recognised. Dr. Rink describes with some fulness the principal laws with regard to property and gain which are recognised as regulating the life of these three divisions of the various Eskimo groups.

Dr. Rink is strongly of opinion that the Eskimo are an indigenous American people, who have been pushed northwards by the intrusive Indian tribes, who are frequently referred to in the Tales contained in the volume, under the name of "Inlanders." In the frequent reference to conflicts and other dealings with the Inlanders Dr. Rink finds a confirmation of his theory, but we think it would equally well support a theory which maintained that the Eskimo themselves are the intruders. We are inclined to think that the theory broached by Mr. C. R. Markham in the R.G.S. "Papers on Arctic Geography and Ethnology" (1875) is quite as consistent with all the facts as Dr. Rink's, if not more so. Mr. Markham adduces very cogent reasons for believing that at no very remote period the Eskimo entered America from Asia by Behring Straits, driven to do so by the pushing northwards of the hordes from Central Asia. We doubt if these Tales and Traditions will help us much towards a knowledge of the origin and early history of the Eskimo. Indeed we doubt very much if we have yet data sufficient to authorise us to pronounce with any-thing like confidence on the subject.

The volume contains in all 150 Eskimo tales and traditions, some of which, however, are only fragments. They have been taken down from the recital of natives of South and North and East Greenland and of Labrador. A vast amount of material was thus collected, many of the tales being evidently variants of one original. This material Dr. Rink has redacted, "all the variations being most carefully examined and compared for the purpose of com-

posing a text such as might agree best with the supposed original and most popular mode of telling the same story." For general purposes this method is, no doubt, quite satisfactory, but if these tales and traditions are to be of any service in enabling us to trace the origin of the Eskimo, the investigator should have before him all the supposed variations of the same original. By comparing these with each other, and with similar materials obtained



Womaa with a Child in the amowt or hood (after present fashion). Godthaab.

from the Western and Asiatic Eskimo, and with the neighbouring Siberian and Indian tribes, we should think it not unlikely that some valuable hints might be obtained as to the Eskimo migrations. No one is more competent than Dr. Rink for such a task, if undertaken without prepossession in favour of any hypothesis.

The tales are roughly divided into ancient and recent. The former may be regarded as the property of the whole

nation, and many of them Dr. Rink believes to be far older than a thousand years. Probably they originated when the Eskimo lived together before their migrations began, and while it is not unlikely that most of them took their rise in some actual incident, they have all evidently been much changed and elaborated by the introduction of the mythical and supernatural. The second class are limited to certain parts of the country, or even to certain people related to each other, "thus presenting the character of family records." But the recent, like the ancient, tales have all more or less of the mythical element in them, and indeed it is mainly from the tales and traditions as a whole that a knowledge of the elaborate and intricate Eskimo mythology has been obtained. The Eskimo have peopled the air, the earth, and the sea with a multitude of supernatural beings; they live as much in an unseen, but to them real and populous, world, as they do among the hard realities of their land and seas. It is very characteristic of them that they have placed their heaven where we have placed our "bad bit," as they call it in Galloway, under the earth, as being so much warmer than the ungenial sky, to which their wicked are condemned to freeze eternally. Of the comparatively modern tales a very few relate to the collision which took place in the fourteenth and fifteenth centuries between the Eskimo and the Icelandic colonists who had been settled in South Greenland since the eleventh century. One relates to two Eskimo who were taken to Europe by some of the early explorers of Greenland, and in both cases the mythical has been largely introduced, affording a good example of how these stories have grown, and showing that while a basis of truth exists in the older stories, the older they are the more difficult it would be to get at it.

While many of the stories are really interesting, there is a great deal of sameness about most of them. Many of them relate to feats of strength, which, formerly at least, seem to have been much admired by the Eskimo. Indeed, it is evident that it was no uncommon thing among them for men to go through a regular and well-devised system of "training" in order to develop muscle and endurance. A large number of them relate to the means adopted by the people to carry on the struggle for existence both against the stern powers of nature that everywhere meet them and against the cunning and competition of their fellows. The satisfaction of revenge and spite form the subject of many, as also the sacrifices made by friend for friend and by the members of a family for each other. Altogether they show the Eskimo to be on the whole gentle, hardy, hospitable, capable of strong attachment, but often capriciously revengeful and spiteful, even to his dearest friend. There is very little of the tender element of love in these stories, an element which figures so prominently in the folk-lore of most other nations. These stories also show that the Eskimo have the poetic temperament in a very fair degree, though most of them are artless enough, and many of them quite objectless and tame in the result. They very frequently remind us of the Brownie tales of Scotland, and some fragments of poetry which Dr. Rink gives, have quite an Ossianic ring about them. The best complete stories are much too long to permit of our extracting one here, though the following short one is a fair example:—

"The inlanders and the coast-people in the beginning were friends. A servant-maid called Navaranak used to be sent out by the inlanders to the coast-people in order to fetch back *matak* (edible whale-skin), and in exchange brought them reindeer-tallow; but after a time she grew weary of this work, and resolved to free herself by making them enemies. For this purpose she told the inlanders that the coast-people were going to attack them, and to the coasters she asserted that the inlanders were making ready to invade them. At length she provoked the inlanders to such a degree that they resolved upon attacking the coast-people. They chose a time when they were well aware that the men had all gone out hunting, and, accompanied by Navaranak, fell upon the helpless women and children. In their fright some of the mothers killed their own children, but one woman who was pregnant fled down beneath the ledge; and when Navaranak was sent back by the inlanders to find her out, she promised her all she possessed not to betray her. Some also escaped by hiding themselves among the rocks, but all the rest were killed. When the men returned, those who were left alive ran down and told them what had happened; and on coming up from the beach to their houses and beholding all their dead, the men were almost desperate. When the time came for flensing and cutting up the whale, Navaranak did not arrive as usual; she seemed to have disappeared altogether. When summer had again come round, the men prepared a great many arrows, and set out for the interior to take revenge on the inlanders. On their way they called out, as was their wont, "Navaranak, come on; we have got *matak* for thee!" but no one appeared. Again they went on a good distance, and then repeatedly called out, "Navaranak" &c. And this time she answered the summons, and went up to them. On noticing their arrows, she was about to take flight. Reassuring her, however, they told her she had no need to do that. When she had ventured quite close to them, they asked her where her countrymen were to be found, and she said, "Further away in the interior of the country;" but now they made her fast to a rope, and dragged her along with them until she perished. At length they arrived at a very large lake, where the tents of the inlanders were pitched all around, and they saw people going out and in. But they waited till all had entered the tents, and then they made their attack. Arrows came flying from both sides; but those of the inlanders soon grew fewer in number, and the coast-people remained all unwounded. When they had done with the men, they went inside, killing women and children; and having thus satisfied their revenge, returned to their homes.

There can be no doubt about the scientific value of this addition to our Arctic literature. To anyone who wishes to have a succinct and trustworthy account of all that is known of the Eskimo, we could not recommend a better work. The tales themselves are perfectly novel, and many of them quite interesting enough and full of queer adventure to become favourites with omnivorous boyhood and even dainty girlhood.

The illustrations, all things considered, are creditable to the native artists who drew and engraved them. By the kindness of the publishers we are able to reproduce a specimen.

#### OUR BOOK SHELF

*A Report on Trichinosis as observed in Dearborn Co. Ind., in 1874.* By George Sutton, M.D., Aurora, Ind. (Reprinted from the Transactions of the Indiana State Medical Society, 1875.)

THE literature of Trichinosis bids fair to become co-

extensive with that of all the other parasitic diseases rolled together. Whilst one can but admire the energy displayed by our Transatlantic brethren in turning every scientific discovery to practical account, we must at the same time observe that only a very few of the voluminous reports received by us from the various States contain matter sufficiently novel to demand extended notice at our hands. Dr. Sutton's report, admirable as it is in many respects, forms no exception to the general rule. By European helminthologists the recognition of Trichinosis in the human subject is no longer spoken of as a "recent discovery," seeing that Zenker, whose merit in this relation is supreme, diagnosed the "loathsome disorder" in 1860, whilst the antecedent steps in the chain of evidence were long previously established by Leuckart and Vichow (1859), Herbst (1850), and so on backwards, until we come to the date of the original discovery of the worm as a nematoid by Paget, and its subsequent description by Owen (1835). We may go even further back than this, and point to Wormald and Hilton's previous and independent recognition of the calcified trichina capsules, and also to their still earlier detection by Peacock (1828), to say nothing of the evidence in favour of Tiedemann (Froiep's *Notizen*, 1822). We must dissent altogether from the view expressed by Dr. Sutton, that Trichinosis probably caused "the ancient Jew to prohibit the use of pork" as food. On the other hand, we are glad to perceive that our author adds his testimony to the view previously taken by ourselves and others, that there is no connection between trichinosis and the so-called "hog cholera." In this regard Dr. Sutton would have done well to have consulted Prof. Verrill's various papers (*American Journal of Science and Arts; Report of Connecticut Board of Agriculture*, 1870), and, if possible to him, also, our own subsequent contribution, on *Stephanurus* (NATURE, vol. iv. p. 508). Lastly, we can only remark that if Germans will not abandon their habit of eating "smoked sausages" they must expect to be trichinised. Clearly, the fault is their own.

T. S. COBOLD

*The Sea.* By Jules Michelet. (London and Edinburgh: Nelson and Sons, 1875.)

MICHELET, as our readers know, wrote a number of works on subjects which suggest a scientific treatment—"L'Oiseau," "L'Insecte," "La Mer," and "La Montagne." The present volume is a translation of the third mentioned, and we believe that at least one of the others has been put into an English dress. These works can hardly be regarded as scientific, except in so far as Michelet seems to have taken laudable pains to acquaint himself, before writing, with some of the principal and especially the most interesting facts which science has discovered in connection with his various texts. For really the titles of his quasi-scientific works are only texts, or rather themes, round which he accumulates a vast variety of more or less appropriate facts, reflections, and word-pictures. He might indeed be regarded as the rhapsodist of science, a man of distinctly poetic or imaginative temperament, excited to enthusiasm by reflections on the facts furnished to him by science. Of course no one would think of resorting to Michelet's works to study any of the subjects he thus treats, but nevertheless his works have their uses from a scientific point of view, uses which we have often referred to in speaking of popular scientific works. "The Sea" will no doubt attract many English readers now that it is translated, and notwithstanding its rhapsodical nature it contains a very fair amount of really useful and trustworthy information concerning marine physics and marine life. But, as in his other works, Michelet skips about his subject on all sides, poses it in every possible attitude, sings about it from every possible point of view. The illustrations are charming, and the book as a whole is got up with great taste. The Messrs. Nelson have done well in publishing such a translation.

## LETTERS TO THE EDITOR

[The Editor does not hold himself responsible for opinions expressed by his correspondents. Neither can he undertake to return, or to correspond with the writers of, rejected manuscripts. No notice is taken of anonymous communications.]

### The Dresden "Gorilla"

IT is a mere chance that I did not see the numbers of NATURE from Sept. 30 till to-day, and I therefore missed the note (vol. xii. p. 482) about the female chimpanzee of the Zoological Garden of Dresden, said to be a young gorilla. In my opinion there can be no question that this ape is not a gorilla. It is only a very fine specimen of a chimpanzee with a darker face than usual, it is true, but this is by no means sufficient in the present state of our knowledge to separate it specifically from *Troglodytes niger*. I only mention here the one characteristic referred to in NATURE—"the slight webbing between the fingers." There is no webbing at all between the fingers which deserves to be called so, and there is a fundamental difference from the hand of a gorilla, not only in respect to this characteristic, but also in respect to the proportion of the fingers to each other. The hand of the Dresden specimen is very long and slender; the hand of the gorilla, even of the young one, is known to be broad and short fingered. But there is a long series of reasons which clearly speak against the supposition that this specimen is a gorilla, and I really do not perceive how anyone can advance this opinion after a very insufficient inspection. It is not enough to say, "I take the specimen for a gorilla;" scientific reasons are needed, and that, too, from some one who really understands the question; it was at least very rash to come out with *this* gorilla. As soon as anyone of the supporters of the opinion that this chimpanzee is a gorilla shall have published scientific reasons, I will take occasion to report about it, and to discuss these reasons. Till then there is no reason whatever to go deeper into the matter, and to regard this ape as anything other than a *Troglodytes niger*.

The two specimens of Birds of Paradise, about which I wrote to you some time ago (vol. xii. p. 434), are now in the Zoological Garden of Berlin.

A. B. MEYER,

Director of the Royal Natural History  
Museum of Dresden

Dresden, Dec. 3

### Dr. Stoliczka's Collection of Mammals

I SEND you an extract of a paper lately published in the *Journal of the Asiatic Society of Bengal* by Mr. W. T. Blanford, on the mammals collected by the late Dr. Stoliczka in Yarkand, &c., and have italicised one or two of the more important sentences. These show how the value of the fine collection has been materially reduced by the appropriation of the finest heads of ruminants, &c., after Dr. Stoliczka's death. The collection before its arrival in Calcutta was known to contain some splendid heads of *Ovis poli*, and other wild sheep, all of which were carried at the expense of the Indian Government from Yarkand over the Karakoram *via* Kashmir to India, a long and costly journey. The finest of these heads, it is well known, have passed into private hands, while the Government Museum in Calcutta cannot show a specimen of decent size. The whole should have passed intact to the above museum, and would have been there examined, and the duplicate specimens sent to the Indian and British Museums here in England. The extract from Mr. Blanford's paper tells its own tale, and I think it would do good to let the fact of the partial destruction of a valuable collection of an able naturalist be more widely known than to the few readers of the *Journal of the Asiatic Society of Bengal*. Every specimen in the collection was as much public property as the munitions in a Government store, and could not be disposed of by any member of the Government or mission.

Extract from the "*Journal of the Asiatic Society of Bengal.*"  
Vol. xlv. Part II., 1875.

"List of Mammalia collected by the late Dr. Stoliczka when attached to the Embassy under Sir D. Forsyth in Kashmir, Ladák, Eastern Turkistan, and Wakhan, with descriptions of new species. By W. T. Blanford, F.R.S., F.Z.S.

"The collections made by Dr. Stoliczka in Kashmir, Ladák, Kashgar, and Wakhan comprise a very fine series of Mammalia, the description of which has been entrusted to me by Mr. Hume, who has undertaken the general direction, besides a very large share in the details of a work intended to be a memorial of our

late friend. It is of course impossible to supply the place of the naturalist whose collections I shall do the best to describe, for with him has perished much knowledge of the habits and distribution of the animals, and although this want can be partially atoned for by the copious notes he has left behind, much unfortunately can never be replaced. . . . There is always more difficulty in procuring specimens of Mammalia than in collecting terrestrial animals belonging to most of the other classes of vertebrata and invertebrata, and this is especially the case with the larger forms. It is consequently not to be expected that the species represented will be more than a portion of those inhabiting the country. Still the collection is rich in some respects, and especially in kinds of rodents, and it adds largely to our knowledge of the fauna of Western Tibet and Eastern Turkistan. *The larger mammals, indeed, were originally better represented, but after Dr. Stoliczka's death many specimens appear to have been removed from the collection.* Such at least was the case with the ruminants. In a private letter which Dr. Stoliczka wrote to me, he told me he had sent twenty-two skins of wild sheep from Kashgar. Of these only eleven—seven males and four females—are now forthcoming, and not one of these has fine horns. There is not a single specimen of *Ovis poli* from the Pamir, the original locality, although I have reason to believe that Dr. Stoliczka brought away one head at least. Lastly, there are skeletons of wild sheep and ibex in the collection of which the heads have disappeared. It is highly probable that other specimens besides those of *Ovis poli* have been similarly made over to private individuals. The value of the collection has been seriously diminished by its being broken up, and the finest specimens distributed, before it had been examined." &c.

(True extract.) H. H. GODWIN-AUSTEN,  
Superintendent Topographical Survey of India

#### Glands of the Cherry Laurel

IN NATURE (vol. viii., p. 245) Mr. Thiselton Dyer, in answer to a correspondent, says that he knows of no explanation of the purpose or origin of the nectariferous glands on the back of the leaf of the cherry laurel. Mr. Darwin ("Origin of Species," sixth edition, p. 73) says: "Certain plants excrete sweet juice, apparently for the sake of eliminating something injurious from the sap; this is effected, for instance, by glands at the base of the stipules in some Leguminosae, and at the backs of the leaves of the common laurel. This juice, though small in quantity, is greedily sought by insects; but their visits do not in any way benefit the plant." Glands cannot be considered very complex modifications of cellular tissue. They exist on all parts of plants, and contain a great variety of secretions. Mr. Darwin and others have shown that they perform the varied functions of secreting nectar to attract insects to flowers, of secreting odorous matter for the same purpose, of absorbing ammonia from rain-water and the products of decomposed or digested animal or vegetable matter, and of secreting acids capable of digesting solids. The existence of free acids in the plant would be injurious to it, so that their excretion would be beneficial to it apart from any digestive function which they may in some cases perform. The glands of the laurel are so far unspecialised that they are by no means constant in number or size. As their attracting insects is of no service to the plant, the nectar must be said to be excreted; but, being what Sachs has termed (p. 629) a "secondary product of metastasis," it should be looked upon rather as a physiologically accidental excretion than as positively injurious, as a substance which, having ceased to take part in the processes of growth, has not acquired an indirect function as has the nectar of flowers. To account for the position of the glands it may be suggested that, as in other evergreens, the leaves of the laurel are "reservoirs of reserve material" in which metastasis, including the separation of the "formative materials" from the "secondary products," mainly takes place (Sachs, p. 627).

G. S. BOULGER

8, Westbury Road, Harrow Road, W.

#### Saw-fish inhabiting Fresh Water

I AM not aware if a curious fact connected with the lake near Manila has been noticed by any traveller.

The Laguna de Baij is a large sheet of water some ninety miles in circumference, divided by an island and two peninsulas, from which it is often spoken of as the "lakes." This lagoon receives the waters of the small rivers of the provinces of the Laguna and Morong, and its only outlet is the river Pasig, which flows

into the bay between the military city and suburbs of Manila. The volume of water discharged by the Pasig is augmented by that of another river which joins the main stream some eight or nine miles from Manila, and during gales in the S. W. monsoon, which prevent the free egress of the water, the Pasig overflows and covers the flat land round Manila.

The water of the lake is quite fresh, and after settling, perfectly potable. At certain times the waters of the lake of Baij possess an urticating property which makes bathing very disagreeable from the irritation they produce. The natives (who account for everything in some way or other) attribute this to the Pistia, a plant which is so abundant as to fill up small bays and form floating islands of considerable size. Great quantities of this plant are carried down the river into the bay, and are seen sometimes a long way out at sea, killed and yellow from the effect of the salt water. Sections of the leaves are beautiful microscopic objects. The lake is separated from the Bay of Manila by a few miles of very flat land, and there can be little doubt that before this barrier was thrown up it formed part of, or at least communicated with, the bay. One proof that the waters were once salt is the existence of a bank of fossil oysters at the point of Julu-julu, some twenty miles from the outlet by the river. When this barrier was raised the waters of the lake became gradually fresh from the influx of those of a number of small rivers which drain the surrounding provinces, the only outlet for which (as before mentioned) is the river Pasig.

The peculiarity to which I have alluded is the existence of a species of small shark and numbers of Saw-fish (*Pristis*) in the perfectly fresh water of the lake. They are seldom or never met with in the river, but there is a fishery in the lagoon in which numbers of the latter are taken. The flesh is eaten, the livers give a good deal of oil, and the snouts of the larger specimens make very formidable weapons, which the natives use and which are at times sent down to Manila as curiosities. These saw-fish, now living in perfectly fresh water, have no doubt become gradually accustomed to the change, as has been the case with the marine species of Crustacea discovered by Prof. Löwen in the fresh water lakes of Sweden.

I am unable to describe the sharks, which I think from the account given me are a small species of dog-fish, quite harmless. Very different, however, are a larger kind inhabiting the brackish water of the lake of Bombon, in which is situated the active volcano of Taal (south-east of the great lake, about twenty or twenty-five miles distant by road). This kind of shark is feared by the natives, who avoid bathing at points which they frequent.

Manila

W. W. WOOD

#### Observations on Fish

IN May last the writer dug a tank within the premises at Garden Reach. About the end of July it was stocked with young fish of several kinds, among others a species of carp, called by the natives "Kutlah," which abounds in the turbid waters of the Hooghly, within the range of the tides. The fry varied from half an inch to an inch in length, some even smaller. The "Kutlah" does not breed in fresh water, but attains an extraordinary size in a wonderfully short time in ponds. So very rapid has been the increase of the fish in question, that the fact seems worthy of chronicle in the pages of NATURE. On Sept. 22, the tank was swept with nets to catch one or two fish of the pike species that had been introduced accidentally with the others, and attained a size that rendered them dangerous to the fry of other kinds. In the net several dozens of the "carp" referred to were taken; one of the largest weighed 14 oz., and measured 11 inches from the end of the upper lip to the tip of the tail, 1½ inches thick behind the shoulder, and ¾ inches in breadth; the others were only one or two ounces lighter.

The tank (pond) in which these fish thrive so marvellously is only 65 feet long by 58 feet broad, and 13 feet deep. The natives, many of whom live within the compound, wash their rice and other food in the water, preparatory to cooking, furnishing the fish with a large amount of food. As the writer saw the tank dug and the fish put in, there cannot be a doubt about their increase in the short space of three months from small fry barely an inch long, to fair-sized fish 11 to 14 oz. in weight, measuring from 10 to 11 inches.

ROBERT U. S. MITCHELL

#### Misti and its Cloud

IN NATURE, vol. xii. p. 487, Mr. Stevenson gives an interesting example of the genesis of clouds, due to hills of about

\* See NATURE, vol. i. p. 454.

900 feet high. Something similar is well known to the inhabitants of Arequipa, Peru. The city is built at the base of the extinct volcano "Misti," which rises above the plaza of Arequipa to a height of about 12,500 feet; Arequipa itself being over 7,000 feet above the level of the sea. It is not an uncommon occurrence (during the fall of the year, February and March) in the morning, from sunrise till about ten o'clock, to see a succession of clouds rolling along the summit from N.E. to S.W., much as if huge masses of white smoke were issuing from the extinct crater. These clouds are either suddenly shot upward by meeting the current from the S.W. and lost at a distance of from 30,000 to 40,000 feet to the eastward from the summit, or else, rolling over the summit, they are carried by the easterly breezes till they become absorbed by the dryer and warmer air of the region to the southward of Misti.

It must be remembered that between Arequipa and the sea, at a distance of not more than thirty miles, extends the great sandy desert of Islay, having an average breadth of about twenty-five miles, and before the days of the railroad the great terror of all travellers from the sea-coast to the interior. Of course the winds blowing across this desert (a part of the great rainless belt



of Peru) are greatly heated at all seasons of the year. The eastern slope of Misti, on the contrary, forms the edge of the elevated plateau extending for more than 150 miles to the eastern slope of the Andes, having an altitude of from 10,000 to 14,000 feet, and the amount of rain falling in this district is very great.

The formation of the cloud, seen from Arequipa on the summit only of Misti, is plainly seen from the railroad leading to Puno, which, after leaving Arequipa, makes a gigantic sweep northward round the Chacharni Mountains, and winds its way eastward behind Misti at a height of about 12,500 feet above the level of the sea. There I have several times seen masses of vapour, condensed into huge white clouds rolling along the slopes of Misti, travel up with great rapidity towards the summit, and either follow its crest as described above, or become at once reabsorbed on reaching the top. This shows plainly that the clouds seen from Arequipa are not due to volcanic action; the Indians also all agree in stating that there is no tradition among them of Misti having been active. I enclose a sketch of Misti and its cloud from a photograph obtained during my visit to Peru.

ALEXANDER AGASSIZ

Cambridge, Mass., Nov. 6

#### The Effect of Waves

It is generally believed that at a moderate depth the influence of heavy waves ceases, and that during a hurricane all is quiet a few fathoms beneath the surface. If this be correct, why should a swell show such a marked increase in height when it rolls over the edge of soundings?

On the parallel of Cape Clear, in longitude 15° W., seamen are familiar with this phenomenon, although the depth is nearly

five hundred fathoms; at times it is so marked that the dead reckoning may be checked by carefully noting the increase in the depth of the hollow of the waves. Shortly after the edge of soundings is passed the sea becomes more regular, and consequently less dangerous to deeply laden vessels.

Anyone who has watched during a moderate breeze the commotion of the water close to a quay wall can form a good idea of the ocean when it receives its first check against the Irish Plateau; the great waves twist around each other, run up and down in heaps, and then fall suddenly as if bereft, in a great measure, of their forward motion.

Again, it is a well-known fact that during a "norther" in the Gulf of Mexico the frailest vessels weather out the storm if they can cross the edge of the Campeachy Banks; a striking proof that at a depth of over fifty fathoms there is sufficient abrasion to destroy the force of the heaviest wave in a very effectual style. On one occasion the writer witnessed this remarkable fact by running from a turbulent sea into comparative smooth water in this locality.

On George's Shoals, off Nantucket, during a heavy gale, the New York pilots and masters of coasting vessels assert that sand is frequently left on deck after a sea has broken on board, although the depth of water may be twelve or fourteen fathoms. It must require an enormous amount of ebullition at the bottom to raise such dense matter to the surface through such a distance; for a cubic foot of ordinary sea-sand weighs about 100 pounds.

In this wild spot the tide, which frequently runs with a velocity of three miles per hour, would assist the lifting power of the wave if running counter to it. During a winter gale, when the strong springs are thus running, the confusion of the sea is indescribable, although the depth may be thirty fathoms. The shortness of the sea (*i.e.* the distance between the crests of the waves) on the banks of Newfoundland, where the soundings are from thirty to fifty fathoms, is noticed by all the navigators of the Western Atlantic, as it reduces the speed of an ocean steamer more than the heavier waves of deeper water with a similar force of wind will do. It is evident that this can only arise from the friction of the bottom, as the waves increase in height when deeper water is reached a short distance to the eastward.

In the Gulf Stream north of the Straits of Bemine, after a "norther" has blown a few hours, the surface of the sea is covered with lanes of weed, although only a few patches might have been seen before the commencement of the gale. As these lanes are often at a considerable distance from shoal water, which lies at right angles to the direction of the current and wind, it is evident they must have grown near the spot where they float, and been torn from their moorings by the mechanical force of the waves.

W. W. KIDDLE

#### OUR ASTRONOMICAL COLUMN

THE TOTAL SOLAR ECLIPSE OF 1605, Oct. 12.—Clavius, observing the solar eclipse of April 9, 1567, at its maximum, remarked "a narrow ring of light round the moon which he supposed to be the margin of the solar disc." Kepler, however, maintained that this could not be in reality a portion of the sun, because the moon's apparent diameter at the time must have been greater than that of the sun, and he concluded, as Prof. Grant relates in his "History of Physical Astronomy," that the sun must have been totally covered by the moon while the narrow ring of light was visible, a phenomenon again exhibited in the total eclipse of Oct. 12, 1605, which was observed at Naples. Of this eclipse Kepler says (*De Stella Nova in pede Serpentarii*)—"Accuratè rectum fuisse totum Solem, quod quidem non diu duraverit; in medio, ubi Luna, fuisse speciem quasi nigrae nubis; circumcirca rubentem et flammeum splendorem, æqualis undique latitudinis, qui bonam cœli partem occupaverit: E regioni Solis, versus Septentrionem, cœlum obscurum planè, et cum profunda nox est; stellas tamen non visas."

Adopting the same system of elements of the lunar motions, employed in previous calculations of past eclipses, the results of which have appeared in this column, we have the following elements of the eclipse to which Kepler refers:—





Around the circumference were placed upright slabs of limestone three feet high, and at least ten bodies had been lodged in the grave, arranged in a sitting posture with their backs against the slabs, and the hole had then been filled up. The teeth showed that the majority were of middle age, whilst the remainder included old persons and children still retaining their milk teeth. The limestone slabs projected a few inches above the present surface of the soil, so that if the grave had ever been covered with an earth mound the latter must have been removed, perhaps washed away. The only artificial object found was one solitary potsherd; hence there is no evidence to prove or disprove any speculation which may be indulged respecting the people whose burial-ground had been thus laid open in the interest of science. It is perhaps safe to conclude that all the bodies found in the grave were placed there at one and the same time.

The Salt Cave, near the Mammoth Cave, and rivalling it in the size of some of its branches, was difficult of access, on account of loose rocks which had fallen from the roof, and of a stream of falling water running off between them. Having effected an entrance, the descent of a steep hill of loose rock led into a large gallery several miles in length, the floor of which was covered with fallen rocks. Small areas were occasionally found, however, where no such masses presented themselves, but where fires had been kindled, and where small piles of stones had been raised around a small central hole having ashes and remnants of burnt sticks at the bottom; whilst on the adjacent rocks there were in some cases found small bundles of sticks tied with bark, and of a convenient size to be placed in the holes, thus indicating that they had been brought into the cave to be used as lights and as firewood.

Further on, in a small chamber never previously visited by a white man, there were seen on the cave earth the imprints of feet shod with peculiar braided moccasins or sandals. In some of the side chambers were found a great number of cast-off sandals, very finely made of the twisted leaves of some rush braided in a careful and artistic way. The manner of braiding was identical with that of the straw sandals from China, but the form of the sandal itself was different. About twenty-five of these sandals, of various sizes and of slightly varying designs, but all worn through at toe and heel, were found in the interior chamber of the cave.

A piece of cloth more than a foot square, and finely and regularly woven, probably from the inner bark of some tree, was also found, and was especially interesting from having been dyed or coloured with black and white stripes, and from having in one place been mended by darning.

Mr. Putnam also exhibited bunches of the bark used to make the cloth, and of different degrees of fineness; a number of pieces of bark, twine, and rope, some made of twisted strands simply, whilst others were of a five-strand braid and of a more pliable substance; a small piece of quite a delicate fringe or tassel of neatly braided fibres; a number of reed "torches," generally burnt at one end; a few small fragments of burnt wood, one of them showing the rough cutting of a flint axe; several fragments of a large gourd, of a species probably not indigenous; two flint arrow-points; a few fragments of shells of the *Unio*; and a few feathers of probably the wild turkey. All the specimens of cloth, &c. from Salt Cave were extremely brittle, and had only been preserved by saturating them with gelatine and afterwards mounting between glass. No bones or other relics indicative of the food of the cave people were found, nor was there any evidence of human interment, though the earth in one of the chambers had been disturbed; the state of Mr. Putnam's health, however, prevented him from making anything like an exhaustive examination. It is encouraging to know that it is intended to continue the work until more is ascer-

tained of the archæology of this large group of important American caves.

The discovery, in 1812-15, of bodies buried with care in some of the caves of Kentucky and Tennessee, and of the numerous articles found with them, was alluded to by Mr. Putnam, who stated that since his return from Kentucky he had examined the body, and what remained of the very large number of articles found with it, that was so widely known as the "Mammoth Cave Mummy" sixty years ago. This body, in reality found in Short Cave, had been taken to the Mammoth Cave, eight miles distant, for exhibition. The relics had been sadly neglected, and many of the articles found in the grave had been lost and others had gone to decay; still enough remained, at the rooms of the American Antiquarian Society at Worcester, to identify the articles found in Salt Cave as the same in material, design, and structure as those found with the body in Short Cave, so that he had thus secured undoubted osteological characters to go with the articles of clothing, &c., of the Salt Cave people, and he thought that we could, with little doubt, class this people among the more highly civilised and agricultural of the prehistoric races of America.

#### SCIENCE IN ITALY\*

JUDGING from the number of scientific papers that we are in the habit of receiving from Italy, we are glad to infer that the restoration of political unity and freedom has also brought about a revival of that intellectual vigour which we are accustomed to associate with the names of Dante and Tasso, Galileo and Torricelli. When Italy was divided, and each State politically oppressed, her best men were in exile, and their best scientific work was expressed in a foreign tongue. Research was not only not encouraged, it was practically prohibited. It seems incredible, but it is nevertheless true, that the Austrian and Bourbon Governments, in their dread of novelty, would not allow the results of modern research to be taught in the schools. The text-books reproduced the exploded science of the past, in which the modern theory of dew, for example, was ignored; so that Melloni (whose best work was done in Paris, and its results published in French journals), in making a series of observations on the nocturnal cooling of bodies in the neighbourhood of Naples, wished to show that the laws of terrestrial radiation were the same in Italy as in countries where there was more political liberty. We have it on the authority of Matteucci, that he and others, when they revisited their native land, were placed under the surveillance of the police, not from the fear of their meddling with politics, but on account of the scientific reputation which conferred distinction upon them.

Under such circumstances science could not flourish, and the time has perhaps been too short since Italy recovered her freedom to enable her to do much more than revive the glories of the past, and to seek encouragement in the example of the great men who have gone before. Hence it is that in the papers before us, points are discussed in connection with objects of Italian discovery, such as the electrophorus and the condenser, in which old names are curiously mingled with new. Thus Becaria, Cæpinus, Priestley, Volta, and Avogadro are asso-

\* "On Certain Principles of Electrostatics." A series of experiments. By Prof. G. Cautoni. "Su Alcuni Principi," &c. (Milan, 1873).—"On Certain Controversial Points in Electrostatics." Note by the same. (Milan, 1873).—"Important Observations of Becaria on Electrical Condensers." By the same. Read before the Royal Society of Science and Literature of Lombardy, Feb. 30, 1873.—"On the Polarisation of Electrics." By the same. Read December 4 and 18, 1873.—"On the Limits of Resistance in Electrics." By the same. Read April 23, 1874.—"Experiments in Electrostatics." Paris 1 and 2. By the same. Read June 25 and Dec. 24, 1874.—"The Discoveries of Fusinieri; historical notes illustrated by an account of some of his instruments preserved in the Civil Museum of Vicenza." By G. Nardi. "Le Scoperte del Fusinieri," &c. (Vicenza, 1875).—"The Theory of the Combination of Gases by means of Solids, as elaborated by Fusinieri, in 1824," &c. By G. Nardi. Read before the *Accademia Olimpica*, 19th May, 1875. "La Teoria," &c. (Vicenza, 1875.)

ciated with Faraday, Tyndall, and a host of modern Italian physicists, whose names we are sorry to say are not so familiar to us. Prof. G. Cantoni's numerous papers, the titles of some of which are given in translation above refer to minute but interesting points in connection with the electrophorus and condenser, in which certain views of Beccaria (1769) and of Volta (1775) are revived and defended and connected with Faraday's theory of electrical induction and the action of the Holtz machine. The title at the head of our list refers, not to papers read before the Lombard Academy, as in the case of the last five, but to a neat little pamphlet which gives an account of forty-nine experiments, and the inference to be drawn from each one, and illustrated by a number of wood engravings representing the arrangement of the apparatus. One portion of the object of these papers is to confirm and extend Faraday's beautiful theory. Indeed, the subject, with the exception of the Holtz machine, has been so extensively investigated by Faraday, Snow Harris, and others, that we do not feel called upon to give an analysis of these ingenious papers. Among the instruments for estimating charge we miss the elegant scale beam electrometer, the hydrostatic electrometer, the electrical balance, the unit jar, and other instruments contrived by Harris and used by him with so much effect. Indeed, Harris's last work on "Frictional Electricity" (1867) seems to be unknown to the Italian physicists. In this work some of the points in question have already been considered experimentally.

Signor Nardi's first pamphlet is a curious exemplification of the dearth of original scientific research to which we refer. When men have but little of their own, they are proud of the wealth of their ancestors. We do not say this is wrong, although its expression sometimes takes an amusing form. Thus, our author, who is Director of the Royal School of Technology at Vicenza, in his visits to the museum of that town, frequently cast an admiring eye on certain cases that contained some of the apparatus of the physicist Fusinieri, who in his own day occupied a respectable position in science, and whose results, when true, have since been absorbed into the great body of science. Hence his name is not much known out of Italy; but, in his native town, his memory is naturally and very properly cherished; so that, when holding a centenary festival in honour of his birth, in February last, the good citizens of Vicenza were naturally grateful to be reminded as forcibly as possible of the genius of their hero. Our author had long regarded these relics with curiosity, until, stimulated by the prospect of this festival, he felt an ardent desire to accomplish something. He says:—"The exquisite politeness of the keepers of this museum, first, that of Monsignor Pietro Canonico Doctor Marasca, and then that of Monsignor Ludovico Canonico Gonzati, threw open to me the sanctuary [that is, they unlocked the cases]. Their encouragement imparted to me the courage to do something, which I now publish in time for the public festival, which I may emphatically term national, in honour of him who is now revered as one of the most eminent physicists of this age."

Guided by the published collected works of Fusinieri, our author examines every article and fragment of the imperfect collection thus thrown open to his inspection. No devotee before the shrine of a saint could display more ardour. If successful in tracing a bit of apparatus to its original use, he is in ecstasy; if unsuccessful, in despair. He has no misgivings as to the originality of his hero, or as to his absolute superiority in all the varied controversies in which he was engaged. Perhaps the most memorable of these (and to which the second pamphlet above cited is devoted) is on some of those obscure catalytic phenomena in which chemical combination is effected by means of certain solids which themselves escape apparently unchanged. Signor Nardi claims for Fusinieri the merit of having refuted Faraday's theory on this

point, and of establishing the true theory on a sound basis. And what is this theory? It is, that "platina determines upon its surface a continual renovation of concrete laminae of the combustible substance of the gases or vapours, which, flowing over it, are burnt, pass away, and are renewed: this combustion at the surface raises and sustains the temperature of the metal." Faraday, in his sixth series of "Electrical Researches" (Nov. 1833), in referring to this theory and its author, says:—"I cannot form a distinct idea of the power to which he refers the phenomena." Certainly the revived discussion of the theory has not tended to throw more light upon it.

Considering the wide range of subjects that occupied Fusinieri's attention from the date of his first publication in 1819 to that of his latest in 1850, we must speak in the highest terms of his industry. His works, collected into three large volumes, contain memoirs on Geometry, the Mechanical Sciences, the Electrical Sciences, Terrestrial Magnetism, Optics, Heat, Meteorology, Astronomy, Chemistry, and Molecular Mechanics. But it is surprising how little influence all this labour had on science in general. We seldom meet with Fusinieri's name out of Italy; and the reason is, not that science is unjust, but that she is stern, and requires discovery to be both new and true, before she welcomes the discoverer. Now it must be confessed that Fusinieri is not original. In his best work there is always something reflected from a greater mind than his own. One of his most striking experiments is to show the repulsive force of heat, for which purpose two slightly convex surfaces of glass are screwed together, so as to exhibit Newton's rings, and heat being applied, the rings contract, and the central tint descends in the scale, until the whole vanishes. But in so capital a result as this we are reminded of Fresnel, while the actual experiment was performed by Baden Powell two years before the date of Fusinieri's paper. Fresnel dates from 1825, Powell 1835, Fusinieri 1837; and yet Signor Nardi attaches an inscription to the lenses in the museum to the indefinite effect that "Long before 1837, Fusinieri made with these and other glasses the discovery of the repulsion of heated bodies." In like manner Fusinieri has a long series of researches on the cause of the colour in metals exposed to heat, while Davy decided by a single experiment that it is due to oxidation. He inclosed a bright surface of steel in an atmosphere of nitrogen, heated it, and there was no colour; he raised it to the same temperature in air, and colour was immediately produced. Fusinieri's theories may be more original than his facts, but then they are not accepted. His best known theory is perhaps that which confers a material body on electricity, because it is capable of conveying matter from place to place, and varying its properties with the kind of matter conveyed and acted on. Nor is his theory of dew, in opposition to that of Wells, more favourably received. Our author laments that Wells's theory is the result of a series of illusions, which has seduced many, and he regrets that the latest sad example of this leading astray is in the case of one John Tyndall, who is so infatuated as to believe in Wells; and yet this theory which was so clamorously received and crowned by the Royal Society depends merely on a spider's thread!

Much of the science of Fusinieri arose out of the questions of the day, and it is to his credit, considering the difficulties of his position, that he endeavoured to keep pace with the scientific mind of his time. He is, however, eminently controversial, disputing whenever opportunity offered, and persisting in his views, even though all, his fellow-countrymen included, are against him, his last opponent being Melloni. He is also very sanguine, and fancies he has solved great and difficult questions, should a single experiment turn out satisfactorily to himself. Thus, when by the action of light on an acid solution of ferrocyanide of potassium he obtained

Prussian blue, he fancied he had settled the grand and difficult problems connected with the colouring matter of leaves. While the isolated position of Fusinieri, and the want of contact with better scientific minds than his own, will account for this, we must not forget that the abject political condition of the land and the narrow jealousy of its multiplied rulers made it difficult for a man to work intellectually or to teach properly, so that we may well express our admiration that one so hampered has achieved so much, and set so good an example to his more fortunate countrymen. May their scientific efforts prosper!

C. T.

## SCIENCE IN GERMANY

*(From a German Correspondent)*

HERR W. SIEMENS has recently made the following interesting communication to the Academy of Sciences of Berlin:—

It has been shown by Willoughby Smith and by Sale that crystalline selenium conducts electricity better when illuminated than when in darkness. The specific conductivity, however, of selenium rendered crystalline by heating from 100° to 150° C. is very small and extremely variable; and also the increase of the conductivity through illumination is very inconstant, so that it is impossible to establish a determinate dependence of the conductivity on the illumination.

Herr Siemens has succeeded, by continuous heating of amorphous selenium to a temperature of 210°, as also by cooling of melted selenium to 210° (at which temperature, long continued, the selenium passes into a coarse-grained crystalline state), in producing another modification of the crystalline selenium, which has considerably greater conductivity, and retains it, and conducts electricity metallically, so that with increase of temperature the conductivity decreases. The action of light on this modification of crystalline selenium is much greater, and apparently quite constant. By fusing in two flat spirals of wire, about 1 millimetre apart, between two leaves of mica in coarsely crystalline selenium, he has obtained an exceedingly sensitive measure of light. Dark heat rays are *without direct influence* on the conductivity, and heating of the selenium, as already mentioned, *diminishes* the same. Diffuse daylight even doubles the conductivity of this light-measure, and direct sunlight increases it sometimes *more than tenfold*. The increase of conductivity of the coarse-grained selenium through illumination takes place very quickly. And similarly, the diminution of it, on shutting off the light, occurs, apparently, at once; but a longer time is required before the state corresponding to darkness is again fully established. The increase of the conductivity is not proportional to the light intensity, but a function of it, which comes near the proportion of the square root of the light intensities.

Herr Siemens hopes this interesting property of selenium may be utilised for construction of a reliable photometer.

W.

## NOTES

EVERY one will hear with genuine regret of the proposed resignation by Prof. Max Müller of the Chair of Comparative Philology in Oxford University. He has resolved to take this step on the ground that he begins to feel the need of rest, and that he wishes to be able to devote all his attention to the ancient language and literature of India. He has just finished, he says, the work of his life, the *Editio Princeps* of the text and commentary of the oldest of the sacred books of the Brahmans, the oldest of the Aryan world. It was this which first brought him to England in 1846, and it was in order to be able to stay in England that he accepted the duties of professor. Dr. Müller

was appointed to the Chair of Natural Philology in 1868, in which year it was founded and endowed. "I have," he justly states, "satisfaction that I leave the new science of language, to which my work as Professor has been mainly devoted, firmly established in the system of academic studies, and that the University will find among my pupils several quite able to fill my place." It will not be an easy matter, we fear, to find a worthy successor.

THERE has just been placed in Westminster Abbey a marble scroll bearing an appropriate inscription to the memory of Jeremiah Horrocks. The movement for such a memorial was commenced some time ago, and is referred to in *NATURE*, vol. x. p. 190, and xi. p. 31. The scroll is affixed to the pedestal of the monument of John Conduitt, nephew of Sir Isaac Newton, which is situated at the extreme west end of the north side of the nave, and exactly opposite that of Newton, at the extreme east end. The inscription is as follows:—

In Memory of

JEREMIAH HORROCKS,  
Curate of Hoole, in Lancashire,Who died on the 3d of January, 1641, in or near his 22d year;  
Having in so short a life

Detected the long inequality in the mean motion of Jupiter and Saturn:

Discovered the orbit of the Moon to be an ellipse;

Determined the motion of the lunar apse:

Suggested the physical cause of its revolution;

And predicted from his own observations the Transit of Venus,

Which was seen by himself and his friend William Crabtree

On Sunday the 24th of November (O.S.) 1639:

This Tablet, facing the Monument of Newton,

Was raised after the lapse of more than two centuries, December 9, 1874.

The friends of Horrocks are indebted for the inscription to the joint labour of the Dean of Westminster and Prof. H. J. S. Smith. It is a simple act of justice to state that the idea of this tablet was suggested by two ladies, Mrs. Orme and Mrs. Patmore, and that upon the latter has fallen the burden and heat of the day so far as the correspondence with subscribers is concerned.

M. LE VERRIER, as President of the Scientific Association of France, has received the handsome sum of 2,300 francs from M. P. Bischoffsheim to meet the balance of the expense incurred during the important and refined experiments conducted by M. Cornu, towards determining with great precision the velocity of light, an expense which otherwise must have been borne by the eminent savant who directed the experiments.

CONSIDERABLE dissatisfaction is felt among the Fellows of the Linnean Society at the delay in the publication of the zoological papers communicated to it. The zoological paper last published in the Journal is dated Dec. 17, 1874, and that in the Transactions, Nov. 19, 1874. It is said that there are at least a dozen awaiting publication, and the number is likely to be increased. There is reason to fear that no zoological paper communicated during the present year will appear before the end of it.

A REPORT is widely circulating in Oxford University to the effect that Lord Salisbury, its Chancellor, is endeavouring to obtain the issue of a Commission for inquiring into the question of University Reform. Another form of the report is that the Commission will have an executive character. A third rumour names Mr. Gladstone as one of the Commissioners. But nothing certain is known upon the subject at Oxford.

THE January number of the *Practitioner* will contain a memoir of the late Dr. Francis E. Anstie, by Dr. Buzzard, with a portrait engraved on steel. This number will also contain some of Dr. Anstie's unpublished researches on alcohol.

DR. BURDON SANDERSON announces that the first of his annual course of Lectures on Comparative Pathology will be given at the University of London, on Wednesday next, Dec. 15. Subject—The Pathology of Inflammation.

WE are glad to see that the movement for organising a University College of Science and Literature in Bristol is so far advanced that a meeting of the subscribers will be held in Bristol on Saturday next, to authorise the committee to take the necessary steps to incorporate the College. In a telling article in Monday's *Western Daily Press* the need of such an educational institution in Bristol, as well as in all our other industrial centres, is forcibly shown. The increasing importance of scientific knowledge even in our most trivial manufactures is well pointed out; only by thoroughly training the rising generation can we hope to compete successfully with foreign manufacturers. It is a hopeful sign to find the subject taken up by the newspaper press in the spirit which animates the article referred to.

THE Vivisection Commissioners, having now received the evidence of a large number of witnesses, will not meet again for some weeks. They will then assemble to examine a few more witnesses, after which it is announced they will at once proceed to consider their report.

THE French Society of Aerial Navigation held its anniversary meeting on the 3rd December, under the presidency of M. Paul Bert. M. Bert delivered, before a full audience, an address reviewing all the scientific ascents executed during the year. The Society, after hearing a lecture by M. Tissandier, illustrated with dissolving views, awarded him a prize. A similar reward was given to the President of the London Aeronautical Society.

THE Cambridge Board of Natural Sciences Studies report that the period of three years for which the University agreed to pay 100*l.* a year towards the expenses of Dr. Dohrn's Zoological Station at Naples will expire next year, and they have had under consideration the expediency of recommending a continuance of the grant. For the sum of 100*l.* the University has hitherto had the exceptional privilege of occupying two of the large working tables. Dr. Dohrn is unable to continue the offer of accommodation on the same terms, but offers one or two tables of 75*l.* per table. The Board, considering the claims upon the Worts' Travelling Bachelors' Fund, do not think it right to charge that fund with two tables at the increased price; and, therefore, recommend that one table be retained by the University for five years at the rate of 75*l.* per annum. The Board have reason to believe that very valuable work has been done by nominees of the University at the station, and the Cambridge Museum enriched by important specimens procured from it. Mr. T. W. Bridge, scholar of Trinity, and Mr. J. F. Bullar, of Trinity, have been nominated by the Board of Natural Sciences Studies to study at the Zoological Station, Naples, until July 1876.

THERE will be an examination at Christ's College, Cambridge, for scholarships and Exhibitions in Natural Science on April 4, 1876. The examination will be open to any one, and there is no restriction as to age. This examination will be held at the same time as similar ones in connection with Sidney Sussex and Emmanuel Colleges, the candidates of either of these colleges being eligible at the other two in default of properly qualified candidates at these colleges.

DR. GUSTAVUS HINRICHS has written in the *Popular Science Monthly* an interesting account of one of the most remarkable meteors of recent times, which lighted up the entire State of Iowa and neighbouring parts of the States of Missouri, Illinois, Wisconsin, and Minnesota, at 10.20 P.M., on Friday, Feb. 12, 1875. This meteor is stated to have become visible at a height of about 150 miles above Pleasantville, Iowa, to have descended at an angle of about 45°, its course being at first a little to E. of N., but deviating gradually more and more to E. in a curved line. It divided into two in passing over the N.W. township of Keokuk country, and finally exploded at a height of ten miles over a point three miles S.W. of Norway, one of the stations on the Chicago and North-Western Railway. It was the

smaller portion of the meteor which produced the meteorite shower in Iowa and Amana townships of Iowa County. Two dollars a pound being given for all meteors collected, a large number have been gathered together varying in weight from 75 lbs. to 2 oz., and amounting in all to upwards of 500 lbs. A woodcut is given, showing nine of the fragments, drawn to one-seventh of their natural size, and a small map with the positions in which the meteors have been found. A map, defining the course of the meteor from all the observations made would have been a useful addition to the paper.

THE *Meteorological Bulletin* of the Pyrénées-Orientales for the year 1874, published under the auspices of the department and the town of Perpignan, contains the following:—(1) *Résumé* of the daily observations referring to agricultural meteorology and the state of vegetation collected at Collioure during 1873-74, by M. Ch. Naudin, Member of the Academy of Sciences; (2) Returns of the state of the crops in Roussillon during the same time, by M. Labau, Director of the school-farm of Germainville; (3) Notice of the thunderstorms observed in the department of the Pyrénées-Orientales, by M. Tastu, Chief Engineer; (4) Tables of the rainfall measured at the different stations of the department during each month of the year, with a sketch of the specialities of the rainfall of last year, by Dr. Fines; and (5) Meteorological observations made at fifteen stations in the department. The close union now being drawn in France between meteorology on the one hand, and agriculture and horticulture on the other, as evinced by the Annual Report of the Meteorological Commission of the Pyrénées-Orientales, as well as by the subjects brought under special consideration at the Meteorological Congress of Poitiers, speaks well for the future of French meteorology.

THE *Agricultural Students' Gazette* is a small quarterly publication, evidently issued under the auspices of the authorities of the Royal Agricultural College at Cirencester, and which is professedly edited by students of that Institution. Such a publication ought to be eminently useful. It should aid in promoting an enlightened system of agricultural education, which is one of the great wants of the age. If well conducted, the journal cannot fail to assist in making known the merits of the College and of kindred institutions. It does not rival any existing periodical. While edited by students, the chief articles are contributed by professors. To No. 3 Prof. Church contributes a valuable paper on the flesh-forming matter of root-crops. Among the other contributions we would refer to a short but interesting paper from the pen of Prof. McNab, on mould, and another on sewage farming, written by one of the students, Mr. John D. Custance. Prof. Wrightson contributes a paper on the improvement of poor clay pastures, which has evidently been carelessly if not thoughtlessly put together. This periodical merits our best wishes. We see no reason why it should not in due time occupy a leading place among our scientific agricultural journals.

PROF. KERNER, of Innsbrück, has published an interesting pamphlet on the Hybrid *Primulacæ* of the Alps. Of these he enumerates no less than twenty-five belonging to the genus *Primula*, four to *Androcæce*, and two to *Soldanella*; some of which have been treated as independent species, as that between *P. subcaulis* and *officinalis* under the name *P. brevistyla*, DC., and that between *P. superauricula* and *hirsuta* under that of *P. fubescens*, Jacq. By far the majority (twenty) of the *Primula*-hybrids belong to a single section, *Auriculastrum*, the remainder to *Primulastrum*. Of "derivative-hybrids"—that is, those resulting from the crossing of a hybrid with one of its parent-forms—he knows only one or two certain instances. In two separate reprints, "Floristische Notizen" and "Ueber einige Pflanzen der Venetianer Alpen," Prof. Kerner describes several new plants of the Southern Alps.

ON November 1 a Stenographic Exhibition was opened in a room of the Pedagogic Museum of the College, Rome. Stenography at the present day occupies a very important part in the requirements of public life, and we believe the effort to encourage its study by a public exhibition will lead to useful results. On the walls of the room were a list of the Italian towns that had a school or society for stenography. The only method followed is that of Gabelsberg-Noe. On a table in the centre of the room were stenographic attempts of every kind, from large plates for elementary study to the smallest and most minute works. In one case, Dante's "Divine Comedy" was copied out into a book of Lilliputian dimensions. On a post-card one stenographer had written 3,660 words. The committee who arranged the exhibition wish to reproduce on the historical wax tablet the stenographic marks with which Tiro wrote the speeches of Cicero.

ON November 2 took place the opening ceremony of the scholastic year of the University of Rome. Prof. Scalzi read a critico-historical exposition of a collection of surgical apparatus belonging to lithotomists and oculists of the sixteenth and eighteenth centuries, which he found among families of the province of Umbria. Prof. Scalzi gave some very interesting details, showing that these instruments were invented in Italy, and not by foreigners, as has been supposed. He showed also that the study of the original instruments was of great interest in connection with the history of the progress of the surgical art. On two tables were arranged eighty instruments which had belonged to surgeons of Novicia and Delle Preci in Umbria. Many of these instruments, it was interesting to observe, resembled those found at Pompeii and others found at Ravenna.

A REPORT by Mr. Frank Buckland, on the fisheries of Norfolk, recently issued, states as a remarkable fact that large numbers of sea trout are annually caught off the coasts of that county, though the rivers which flow through it are naturally incapable of producing *Salmonida*. The fish thus caught are visitors from the salmon rivers in the north, viz., the Tyne, the Tees, the Coquet, and the Tweed. The object of this visit to the coasts of Norfolk and Suffolk is to find food, which exists in abundance in the shape of the spawn and fry of the many varieties of fish which abound in those waters. The report contains much interesting matter relative to the crab, lobster, and other sea-coast fisheries, and to the fisheries in the fresh-waters of Norfolk and Suffolk.

THE *Comptes Rendus* for October 4 last contains a paper on the interpretation of the sphygmograph trace, by M. Bouillaud. The author gives reasons, which we think peculiarly unsatisfactory, in favour of the sphygmograph trace—a curve now fairly understood—supporting an assumption of his that each cardiac revolution consists of two periods of action and two of repose, instead of one systole and its associated secondary consequences.

OUR readers will find, in the current number of the *Ibis* a short account of the late veteran Swedish ornithologist, Carl J. Sundevall, whose excellent investigations, especially with reference to the Passerine birds, have done much towards the development of sound classificational principles.

WE would direct the special attention of our zoological and geological readers to a paper by Prof. Owen in the current number of the *Quarterly Journal of the Geological Society*, on a fossil Sirenian animal from Jamaica, previously described by him, and named *Prorastomus sirenoides*. In this animal the premaxilla of each side gives indications of having supported three not large teeth, at the same time that there were eight teeth of the molar series above and below, on each side. The species was considerably smaller than the Manatee; the skull and atlas vertebra are the only parts known; in conjunction with

*Felsinotherium forrestii* it fills an important gap in our knowledge of the pedigree of the Sirenia.

THE *Geographical Magazine* for December contains a paper of great value on the Amu Darya region, by N. P. Barbot de Maruz, who in the summer of 1874 made a journey from Fort Alexandrovski, in the Caspian, to the foot of the Thian-shan. He describes the principal geological features observed along the route, and promises a full report of his researches when he has been able to arrange his abundant materials. Another paper, by Mr. Ravenstein, describes Mr. Stanley's recent discoveries, and is illustrated by two good maps, one of the Victoria Nyanza, principally according to Mr. Stanley, and another of the regions of the Upper Nile, embodying the results of the explorations of Burton, Speke, Grant, Stanley, Baker, Long, and others.

PARTS 10, 11, and 12 (in one), of the well-conducted Italian geographical journal, *Cosmos*, are to hand. The following are the principal papers:—A letter from F. Giordano, giving some account of the condition of New Guinea, in reference to a proposal to make use of some part of it as an Italian penal settlement. Another letter, from Dr. Beccari, describes some results of his investigations into Papuan ethnology. The first of a series of papers on Arctic Geography gives the results of recent Arctic exploration in the Baffin's Bay and Spitzbergen directions.

WE learn from the *American Naturalist* that State Associations of Archaeology have been formed in Indiana and Tennessee, similar to that already existing in the State of Ohio. Their field of work is most extensive and important.

ON Thursday, November 26, at 6.35 P.M., an earthquake shock was distinctly felt at Lyons. The commotion, which travelled northwards, lasted from fifteen to twenty seconds.

A SHOCK of earthquake was felt at Naples on Dec. 6, and also throughout the provinces of the Basilicata, Terra di Lavoro, and Salerno.

THE additions to the Zoological Society's Gardens during the past week include a male Prince Alfred's Deer (*Cervus alfredi*), born in the Gardens; a Green Monkey (*Cercopithecus callitrichus*) from West Africa, presented by Mr. C. F. Wood; a Macaque Monkey (*Macacus cynomolgus*) from India, presented by Miss Kate Symonds; two Alligators (*Alligator mississippiensis*) from North America, deposited; twenty-nine Basse (*Labrax lupus*); a Grey Mullet (*Mugil capito*), and six Cottus (*Cottus bubalis*) from home seas, purchased.

#### THE DIFFERENCE OF THERMAL ENERGY TRANSMITTED TO THE EARTH BY RADIATION FROM DIFFERENT PARTS OF THE SOLAR SURFACE

THE observations relating to the temperature of the polar regions, referred to in the article (vol. xii. p. 517), at first led to the supposition that the rays projected from the north pole of the sun transmit a perceptibly greater energy to the actinometers than the rays from the opposite pole. Subsequent observations having positively established the fact that the polar and equatorial zones transmit equal intensities, it became evident that some other cause than difference of temperature within the polar regions influenced the actinometers. The only valid reason that could be assigned in explanation of the anomaly being the considerable angle subtended, and the consequent difference of zenith distance of the opposite poles of the sun, my table of maximum solar intensity for given zenith distances (prepared from data collected during a series of years) was consulted, in order to ascertain the influence of zenith distance. The observations indicating a higher temperature at the north pole, it should be mentioned, had been made while the sun's zenith distance ranged between 32° and 33° at noon. Now the table referred to shows that there is a difference of radiant intensity of 63°-63' - 63°-40' = 0°-23' F. between the stated zenith distances. The mean angle subtended by the sun being fully thirty-two minutes,



it will thus be seen that, owing to the absorptive power of the terrestrial atmosphere, the radiant intensities transmitted from the opposite poles of the luminary differ considerably. The magnitude of this difference, adequate to explain the discrepancy under consideration, need not excite surprise if we consider that thirty-two minutes of zenith distance involves an additional depth of more than half a mile of atmosphere to be penetrated by the rays projected towards the actinometer from the *south* pole of the sun. The foregoing facts show the necessity of taking the difference of zenith distance between the opposite poles into account in making exact observations of the sun's polar temperature, especially at the lower altitudes where the secant of the zenith distance increases rapidly.

Regarding the calorific energy of the radiation emanating from the border of the sun, I deem it proper to present the following brief statement. Several observations during the early part of the investigation pointed to the fact that increased energy is transmitted to the actinometers by radiation from the sun's border. Again, considerable irregularity was observed in the progressive diminution of the force of radiation towards the circumference of the solar disc. It was shown in the preceding article (vol. xii, p. 520) that the radiation from the border zone, 1' 42" wide, occupying one-fifth of the area of the solar disc, transmits 0.638 of the intensity transmitted from an equal area at the centre of the disc. Of course it will be supposed that the rate of the diminution of intensity within the zone thus ascertained is much greater near the border of the photosphere than at the middle of the zone. Such, however, is by no means the case, notwithstanding the assumption of physicists that the heat transmitted by radiation from the border is very feeble. In order to test the truth of the indications referred to showing considerable radiant energy at the border of the photosphere, a very careful investigation was made, Sept. 9, 1875, by means of screens excluding the rays from the solar disc, as shown in Figs. 12 and 13. The diameter of the screen represented in Fig. 12 being 154.06 millimetres, covered nine-tenths of the area of the disc; while the screen shown in Fig. 13, being 145.25 millimetres, covered four-fifths of the disc. It will be well to mention that the dimensions of the screens referred to correspond with the angle subtended by the sun when the earth is in aphelion. Accordingly the distance between the actinometers and the screens

was adjusted previous to the observation, viz. shortened, in order to compensate for the increase of the angle subtended by the sun. Agreeable to the stated dimensions of the screens, it will be found that the zone represented in Fig. 13 is 1' 42", while the zone in Fig. 12 is 49' 6". The mean width of the latter is consequently situated only 24' 3" from the border of the photosphere.

The following table shows the intensities transmitted to the actinometers from the zones represented in Figs. 12 and 13:—

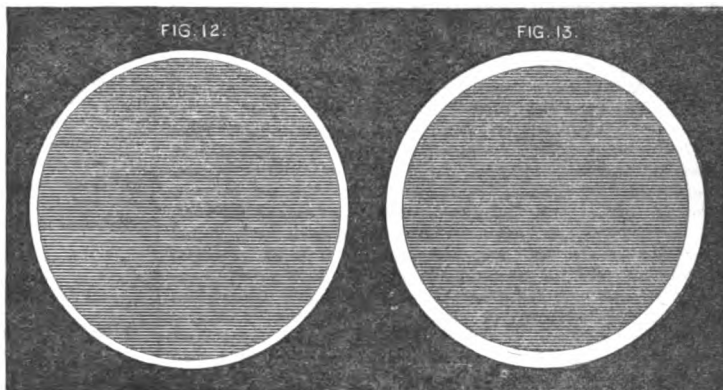

Time.	Zone, Fig. 13. Cent.	Zone, Fig. 12. Cent.	Rate of difference.
4'	2° 011	1° 333	1.333 = 0.662 2.011
5'	2° 248	1° 471	1.471 = 0.654 2.248
6'	2° 425	1° 583	1.583 = 0.652 2.425
7'	2° 485	1° 666	1.666 = 0.670 2.485
			Mean = 0.660

The rate of difference inserted in the last column, it will be noticed, is not quite so consistent as in the table contained in the previous article recording the observations made Aug. 25. The

FIG. 14.

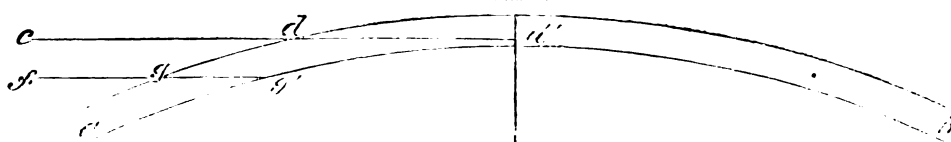

discrepancy is, however, not material, the difference between the lowest and the mean rate being 0.008. It will be seen on inspecting the registered intensities, that the border zone represented in Fig. 12, whose area is only one-half of the area of the zone in Fig. 13, transmits 0.660 of the intensity of the latter. This at first sight indicates an extremely disproportionate transmission of heat from the narrow border zone; but it should be considered that the inflected radiation imparts relatively more heat to the actinometer exposed to the radiation from the narrow zone than from the wide zone. It will be readily understood that since the inflection of the calorific rays is 14" 7" (see preceding article, page 519), the first-mentioned actinometer receives radiant heat from 14' 7" + 49' 6" = 64" 3"; while the actinometer exposed to the radiation from the wide zone receives heat from 1' 42" + 14" 7" = 116" 7". Consequently, the

radiant heat emanating from the narrow zone will be  $\frac{64'' 3}{116'' 7} = 0.551$  of that transmitted from the wide zone, hence somewhat more than one-half. Our investigation therefore proves that the radiant heat transmitted from the narrow border zone represented in Fig. 12 is 0.660 - 0.551 = 0.109 more intense than that transmitted from the zone represented in Fig. 13, although the

mean distance of the latter is twice as far from the border of the photosphere as the mean distance of the former. The singular fact thus revealed can only be accounted for by supposing that internal radiation is not incompatible with the constitution of the photosphere, and by adopting Lockyer's views expressed in the Senate House at Cambridge, 1871, that "the photosphere must be a something suspended in the solar atmosphere." Let *a b*, Fig. 14, represent a section of the "suspended" photosphere, and *d c*, *g f*, rays projected towards the earth. Agreeable to the conditions mentioned, and in view of the fact that the force of radiation from incandescent gases presenting equal areas, varies nearly as their depth, we are warranted in concluding that since the depth *dd'* is greater than *gg'*, the radiant heat transmitted from the photosphere by the ray *dc* will be greater than that transmitted by the ray *gf*. It should be observed that the energy transmitted towards the earth by *dc* suffers a greater diminution than the energy transmitted by *gf* in consequence of the greater depth of the solar atmosphere penetrated. Hence the augmented energy established by our investigation, does not show the full amount of the increase of radiant heat transmitted from the border of the sun.

J. ERICSSON

THE GRAPHIC METHOD OF REPRESENTING MUSICAL INTERVALS \*

THE object of the paper was to explain a method of representing musical intervals, which was very useful in giving a clear idea to the mind of relations often complex and obscure.

The author pointed out that there was a natural tendency to refer the positions of musical notes to positions in space. It was by no means clear that there was any real physical or physiological relation between the two things, but somehow or other the idea had become so firmly rooted in the mind that it had developed itself in expressions of every-day use. For example, it was customary to call a note with rapid vibrations a *high* note, and one with slow vibrations a *low* note. Few people considered whether there was any natural justification for these terms; probably there was none, but they had existed almost ever since music had taken a definite form, and had given rise to the form of notation employed to express the positions of musical sounds.

It followed from this that the musical idea of distance between two notes, which was technically called a musical interval, might be considered as having an analogy between the high and low positions of the two notes respectively, a greater interval being represented by a greater space, and *vice versa*; and carrying this idea out to its full extent it became possible to represent musical intervals to the eye in such a way as to convey ideas of comparative magnitude precisely analogous to the impressions which these intervals would make on the ear. This the author called the *graphic* method of representing intervals.

The idea of such a method had been embodied from early times in the word *scale*, which was derived from the Latin *scala*, a ladder, thereby clearly implying an analogy between the spaces of the steps and the intervals of the notes. Mr. Hullah, in some of his elementary books, had actually made use of a diagram of a ladder for this purpose, and he had introduced the improvement of representing the intervals between the third and fourth and between the seventh and eighth steps (of the diatonic major scale) as only half the length of the other degrees, thereby embodying, in a graphic mode, the distinction in magnitude between the whole tones and the semitones. What the author proposed to do in this paper was merely to establish this mode on definite principles, and to give it more capability and more accuracy.

It was well known that the scientific definition of a musical interval was expressed by the ratio which the vibration-number of the higher sound bore to that of the lower one, and it had been shown that the idea of the magnitude of the interval in a musical sense might be expressed by the logarithm of this ratio. Hence, by plotting down this logarithm with a scale of equal parts, and drawing a line of that length, such a line would be a correct graphic representation of the magnitude of the interval.

The author explained the mode of doing this in a simple practical way, which might be put in practice by anyone, with the aid of a small table of logarithms, as easily as working a simple sum in arithmetic; and he calculated and laid down several examples in the presence of the audience. It would be, he said, sufficiently accurate to express the distances in three places of figures, as, for example:—

The interval of an octave would be expressed by a line whose length was—

= log. 2 ... ..	= 301
That of a major— Sixth = log. $\frac{5}{4}$ ... ..	= 222
That of a minor— Sixth = log. $\frac{8}{5}$ ... ..	= 204
That of a fifth— = log. $\frac{3}{2}$ ... ..	= 176
That of a fourth— = log. $\frac{4}{3}$ ... ..	= 125
That of a major— Third = log. $\frac{5}{3}$ ... ..	= 97
That of a minor— Third = log. $\frac{6}{5}$ ... ..	= 79

And so on for any others.

It would be seen how truly these numbers corresponded to the ideas of the intervals existing in musical practice, for, according to the usual musical rules—

Fifth + Fourth ... ..	= Octave.
Major Sixth + Minor Third ... ..	= Octave.
Minor Sixth + Major Third ... ..	= Octave.
Major Third + Minor Third ... ..	= Fifth.
Fourth + Minor Third ... ..	= Minor Sixth.

And so on.

The author then, as a more extended illustration of the principle, showed the process of determination of the exact positions of the various notes of the modern musical scale, including all the accidental sharps and flats necessary for chromatic purposes and for modulation; and he proceeded to draw the same on a large diagram, making the octave 3 feet long. This enabled the audience to appreciate clearly many delicate points of intonation, which were difficult to be conveyed to the mind by any process of verbal description, and which the author explained and commented on in their theoretical and practical bearings. He also drew a corresponding scale on the plan of equal temperament, and pointed out the more important differences between this and the true scale, concluding with some remarks on the subject of intonation generally.

THE SWEDISH ARCTIC EXPEDITION

THE following extracts are taken from a letter addressed to Mr. Oscar Dickson, of Gothenburg by Dr. F. R. Kjellman, who (and not his brother Dr. Theél Kjellman, as was stated by mistake in NATURE, vol. xiii. p. 75) was in command of the *Pröven*, the vessel of the Swedish Arctic Expedition during the return voyage from the mouth of the Jenesei to Norway. The *Pröven* left the mouth of the Jenesei on the 19th August, fell in with ice on the 23rd in 75° 22' N. lat. and 66° 30' E. long. from Greenwich; sailed along the edge of the ice until, a little south of Cape Middendorff, it was found to connect itself with the land so as to bar all passage northwards. The *Pröven* then turned south and was carried by a current twelve miles south of Matotschkin Scharr.

"Before going farther I may perhaps be permitted to make some remarks on the higher vertebrate animals which we found to inhabit or visit the Kara Sea. The walrus occurs here plentifully, and has of late years been the object of exterminating pursuit on the part of the Norwegians. At many places on the Samoyede peninsula and White Island we saw great herds of these beautiful animals. The Kara Sea has three species of seals, *Phoca barbata*, *hispida*, and *Grønlandica*. The last-named was that which we saw most frequently and in greatest numbers. Off Obi and Jenesei white fish (? dolphins) were very common, and on the east coast of Novaya Zemlya we saw a large fin-whale (*Jenkvai*). If I add that one day, as we lay becalmed between Udde Bay and Matotschkin Scharr, an ice-bear quite unexpectedly came swimming out to our vessel, where he, of course, soon met his death, I have named all the mammalia we saw during our navigation of the Kara Sea. The bird world was exceedingly poor. I may almost say that it was a great rarity to see a tern or a mew. The alka (*Uria Brünnichii*), which occurs in such immense numbers on the west coast of Novaya Zemlya, is believed to be absent on the east coast. We saw here only one, and it appeared to have gone astray. Only some few species of fish were observed."

The *Pröven* passed through Matotschkin Scharr on the 10th and 11th September, arriving at Hammerfest on the 26th of the same month, and at Tromsø on the 3rd October. Dr. Kjellman sums up the scientific results of the expedition as follows:—

"We botanists have endeavoured not only to ascertain what species of plants Novaya Zemlya possesses, but also to get an insight into the varying distribution of the different species, the nature of the vegetation at different localities, in different latitudes, at varying heights above the sea, at varying distances from the seashore, &c. We have made a great number of such observations, and thereby will, I believe, be in a position to give such an account of the vegetation of Novaya Zemlya as will satisfy the requirements of science. Of flowering plants we have rich collections from Matotschkin Scharr, from many places on the west coast of Southern Novaya Zemlya, from Waigats Island and the mainland lying opposite to it, from the Samoyede peninsula and the region lying round Dickson's Harbour, and these collections contain a considerable number of species new to those localities. The phanerogamic vegetation of Novaya Zemlya has a strong resemblance to that of Spitzbergen, but at the same time, as might be expected from

\* Abstract of a paper read by W. Pole, F.R.S., Mus. Doc., Oxon., at the second meeting of the Musical Association for the Advancement of the Art and Science of Music on Dec. 6, at the Beethoven Rooms, Harley Street, Mr. Bosanquet in the chair.

its position, has a more southern stamp. This appears partly by Novaya Zemlya being much richer in species than Spitzbergen, of which species several occur which belong to families not represented on Spitzbergen, and partly by the vegetation of Novaya Zemlya being richer in individuals. At many places, especially in the more southerly parts of the land and the interior of the fiords, the ground is covered with thickly-matted plants, to which there is nowhere on Spitzbergen anything corresponding. Their closeness and variety of colour often awoke our surprise and astonishment. The phanerogamic vegetation of Novaya Zemlya connects itself by means of common species not only with that of Spitzbergen, but also with the floras of Arctic America and northern Norway, and that of the shores of the Gulf of Bothnia and the Asiatic Continent.

"The more southern character exhibited by the phanerogamic vegetation of Novaya Zemlya, as compared with that of Spitzbergen, is as good as absent in its marine algae. The same dissimilarity is also apparent with regard to the fauna. The land fauna is more southern, the marine fauna is high Arctic. The most of the marine algae known to exist at Spitzbergen are found at Novaya Zemlya, and of the species collected here there is only one that is wanting on the coasts of Spitzbergen.

"Of fresh-water algae, mosses, and lichens, we have made considerable collections. Of mushrooms, on the contrary, we obtained very few. Either it was a bad mushroom year on Novaya Zemlya, or else, what is less probable, this class of plants is very sparingly distributed on these islands.

"As on the coasts of Greenland and Spitzbergen, so in the parts of the Polar Sea we now visited, the surface of the sea at certain places which appear to be sharply defined is quite full of diatomaceæ. A belt of special richness we found on the north coast of Norway, extending in an easterly direction from North Cape to the mouth of Tana Fiord; another, less rich and of less extent, we found in the neighbourhood of the Samoyede peninsula.

"Through the researches of Th. von Heuglin, we have already a good knowledge of the vertebrates of Novaya Zemlya. The attention of our zoologists has, however, been directed to this group of animals, and by their observations our knowledge of them has been very considerably extended. This specially holds good of the birds.

"Along the whole west coast south of Matotschkin Scharr, as well in the open sea as in the fiords and sound where we sailed through and lay at anchor, dredging has been assiduously carried on. The rich collections thus made will certainly, when they are examined, afford a very complete idea of animal life in this region. Few species of animals were previously known as existing here, and as to the distribution of the different species along that extensive coast all information has hitherto been wanting.

"Among the zoological work a conspicuous place is occupied by a rich insect collection by which the knowledge that we previously had of Novaya Zemlya's insect world will be very considerably extended. Formerly from this region only four or five species of insects were known. The expedition's collection consists of about 500 specimens, and includes numerous representatives of nearly all the orders of insects.

"Most important, however, in a zoological aspect, appear to me the numerous dredgings which were carried on in the Kara Sea, and which prove that in this sea there is, as has been already mentioned, abundant animal life of very various types. The collections made here are large, and must be specially valuable for zoological science as coming from a considerable region of the Polar Sea, of which the zoology is little known, but especially because this extent of sea exhibits in different tracts so considerable dissimilarities with respect to depth, content of salt in the water, &c."

#### BOTANICAL NOTES

THE CALCUTTA BOTANICAL GARDENS.—Dr. King's report on the Royal Botanical Gardens, Calcutta, for the year ending March 31, 1875, to which we have recently referred (vol. xii. p. 541), contains some interesting notes on the cultivation of useful plants, especially the Para rubber plant (*Hevea brasiliensis*) and the Ipecacuanha (*Cephalis ipecacuanha*). With regard to the former, Dr. King is of opinion that the plants will not thrive in that part of India. Mr. Collins, in his report on the Caoutchouc plants, describes the *Hevea* as growing in their native country in situations where the heat is not generally above 87° Fahr. in the afternoon, and below 74° at night, and

shows, on the authority of Wallace, that the temperature in the caoutchouc districts during three years only once reached to 95°, the greatest heat being about 2 P.M., when it ranges from 89° to 94°, and never lower than 73°. The meteorological returns for Calcutta show a wide difference between the Brazilian and the Indian climates. Another Caoutchouc plant, however, the *Vahca madagascariensis*, Boj., a climbing apocynaceous shrub, native of Madagascar, promises to thrive much better than the *Hevea*. The fact of the plant being of climbing habit militates considerably against its value as a cultivated plant, owing to the difficulty in providing supports as well as in obtaining the caoutchouc. Nevertheless, it is a kind highly valued in the English market, realising a price next to Para rubber. With regard to Ipecacuanha, which has been shown to require much care and attention as to soil and situation, we learn that a number of sets of plants were put out during the early part of the year at different spots at low elevations in the Cinchona reserve at Sikkim; warm, well sheltered situations, with good virgin soil, were chosen. "Some of the plants thus put out were protected by the natural shade of the forest, others by a sloping thatch of grass. Until the arrival of the cold weather all went well, but the unusually low temperature that prevailed during that season was fatal to the majority of the plants." Dr. King further says that he is "driven reluctantly to the conclusion that it is doubtful whether ipecacuanha can be successfully cultivated as an out-door crop in Sikkim." Further trials, however, are to be made before its experimental cultivation is recommended to be abandoned.

*Eucalyptus globulus* has had its share of attention in India, and without considering the question of the truth or otherwise of its reputed value, it is proved that although it grows quickly and with vigour on the Neilgherries and Khasia hills at 5,000 to 8,000 feet above the sea, it cannot be induced to live even for a year or two in the hot plains of India. Dr. King's description of the fine old Banyan tree, "one of the greatest curiosities and ornaments of the place," will, we are sure, be read with interest. He says: "Although considerably damaged by the cyclone of 1864, which carried away two of its largest arms, this fine tree continues to grow vigorously. It now covers an area of ground 800 feet in circumference; its trunk girths 51 feet, and from its branches no fewer than 170 aerial roots are sent down to the ground, some of them being more than ten feet in circumference. This fine old tree supports quite a colony of orchids, ferns, and creeping plants of about twenty distinct species, and gives shelter to innumerable birds. Its exact age is not known, but, considering how rapidly banyans grow, it probably does not much exceed that of the garden, and is therefore less than a century."

GUM ARABIC.—In a recent number of the *Revue des Sciences Naturelles*, Prof. Charles Martins, of Montpellier, draws attention to a peculiar mode of exudation of gum arabic from the *Acacia verec* of Senegal. On the authority of Schweinfurth, quoted in the "Pharmacographia," p. 206, it is stated that this tree, exclusively, yields the fine white gum of the countries bordering the Upper Nile, and especially of Kordofan. It is described as growing to a height of about twenty feet, and though the gum is one of the principal productions of the colony, being collected in large quantities by the Moors, who exchange it for European commodities, no notice occurs of any peculiarity in its formation or collection; indeed, it is stated that "the gum generally exudes from the trees spontaneously, in sufficient abundance to render wounding the bark superfluous. The Somali tribes of East Africa, however, are in the habit of promoting the outflow by making long incisions in the stem and branches of the tree. In Kordofan the lumps of gum are broken off with an axe, and collected in baskets." Prof. Martins shows that the exudation of the gum is often promoted by the growth of a species of *Loranthus*, his observations being founded on actual specimens of branches of the *Acacia* upon which the parasite had formed. In several instances the gum had exuded in a vermicular form always at the point of union of the parasite with the stock. This union of the two plants forms, as is usual with other *Loranthaceae* species, an irregular, gnarled-like protuberance, from which are given off both the branches of the *Acacia* and also of the *Loranth*, each of which is very distinct from the other, those of the *Acacia* being spiny and more slender than those of the parasite. Rather than this mode of exudation being rare, it would seem to be of frequent occurrence. M. Martins considers the parasite to be a new species of *Loranthus*, for which he proposes the name of *Loranthus senegalensis*, placing it near *L. portegoniis*, DC.

## SOCIETIES AND ACADEMIES

LONDON

Royal Society, Nov. 25.—“On the Replacement of Electro-positive by Electro-negative Metals in a Voltaic Cell,” by J. H. Gladstone, Ph.D., F.R.S., Fullerian Professor of Chemistry in the Royal Institution, and Mr. Alfred Tribe, Lecturer on Chemistry in Dulwich College.

It is well known that one metal exerts a greater chemical force than another, and is capable of displacing it from its combinations. Among those metals with which we are familiar, potassium is looked upon as the most powerful; and it is a certain fact that calcium, barium, strontium, aluminium, and magnesium have been isolated by its agency. It could scarcely be expected, therefore, that any other metal could directly replace potassium. If such should happen, we should have an instance of reversal, and should expect to find, on examination of the conditions, an agent capable of doing just the reverse work of what is usually assigned to affinity.

It is also well known that in a simple voltaic cell, such as zinc connected with platinum in dilute hydrochloric acid, the more powerful or electro-positive metal, zinc, displaces the hydrogen that is in combination with chlorine, and the hydrogen makes its appearance against the less powerful or electro-negative metal, platinum. The chemical theory of galvanism supposes that the force originates in the chemical action which takes place between the zinc and the acid; the contact theory supposes that it originates in some unexplained manner in the opposite electrical condition of the two metals induced by their contact. If the chemical theory be the true one, it is evident that a zinc-platinum cell can only become active when the binary liquid contains hydrogen or some metal which is less powerful than zinc. If, for instance, we were to employ a potassium-salt instead of a hydrogen compound, it is inconceivable, on the pure chemical theory, that there should be any action at all.

Such an action, however, does take place if we substitute the chloride of potassium for the hydrochloric acid; the zinc combines with the chlorine, and the potassium is set free in some form against the platinum, manifesting itself by the presence of free alkali and hydrogen gas. The same holds good with chloride of sodium, or ammonium, or barium, strontium, calcium, or magnesium.

This action is slow; but if magnesium be used instead of zinc, it takes place sufficiently rapidly to be easily observed, and we have therefore studied the action of platinum and magnesium in connection.

After an account of the experiments, the paper concludes as follows:—

If one metal in conjunction with another more electro-negative than itself will decompose the salt of a more positive metal, it may be expected, *à fortiori*, that it can decompose one of its own salts. Instances of this are not wanting.

Magnesium connected with platinum will decompose a magnesium salt, the almost insoluble hydrate of magnesium being found adhering to the negative metal. The deposition of zinc on the plates of an old-fashioned battery, when the battery is pretty well exhausted, is a well-known phenomenon. In our experiments with copper and silver in conjunction in a solution of nitrate of copper, we never succeeded in reducing the galvanic action to *nil* by our utmost efforts to exclude all oxygen, and the whole of the present inquiry originated in an experiment described by us before the Physical Society, that mercury and gold in conjunction would decompose mercuric chloride, with deposition not only of lower chloride, but also of metallic mercury upon the gold.

These experiments are inexplicable on the theory that the chemical action supplies the whole of the decomposing force, but show that there is an antagonistic force produced somewhere in the circuit which is greater in amount than the superior affinity of potassium over magnesium for the negative radicals.

Little doubt can be entertained but that this force is called into existence by contact; but our experiments do not teach us whether the energy requisite to keep up the action results from the disappearance of heat at the junction of the metals or contact of the metals and liquids (an idea that has long been in our minds), or at the expense of some other form of energy. Of course a momentary disappearance of heat would give only a momentary supply of voltaic energy; but since the loss of heat would be constantly made up by absorption from surrounding objects, the action would be continuous.

Linnean Society, Dec. 2.—Dr. G. J. Allman, F.R.S., president, in the chair.—Mr. J. G. Baker made some remarks on *Pyrus Briggsii*. The following papers were then read:—On Polynesian Ferns of the *Challenger* Expedition, by Mr. J. G. Baker. The new species amounted to ten or twelve, closely allied to species already known, and establishing no new genus.—Genera and Species of Liliaceæ, by Mr. J. G. Baker. The present instalment, completing the series, comprises the Tribes Anthericæ and Eriospereæ; the latter characterised by remarkably woolly seeds.—Botanical Notes from Darjeeling to Tongle, by Dr. C. B. Clarke.—On *Edgaria*, a new genus of Cucurbitaceæ, by Dr. C. B. Clarke.

Chemical Society, Dec. 2.—Prof. Abel, F.R.S., president, in the chair.—Dr. J. H. Gladstone read a paper, by himself and Mr. A. Tribe, on the decomposition of alcohol and its homologues by the joint action of aluminium and its halogen compounds. The action on alcohol gives rise to hydrogen and aluminic ethylate, a greenish white fusible solid.—The second communication, a note on incense resin, by Dr. J. Stenhouse and Mr. C. E. Grove, was read by the latter. The authors have succeeded in obtaining a crystalline substance and a liquid hydrocarbon from it.—Mr. J. Spiller gave a notice of the occurrence of native calcium chloride at Guy's Cliffe, Warwickshire; after which Mr. G. S. Johnson described certain sources of error in the ultimate analysis of organic substances containing nitrogen, upon which an interesting discussion took place.—The other papers were: On certain bismuth compounds, by Mr. M. M. P. Muir; and On bismuthiferous tesseral pyrites, by Dr. W. Ramsay.

Royal Microscopical Society, Dec. 1.—Mr. H. C. Sorby, F.R.S., president, in the chair.—A number of presents were announced, including an injected specimen of the ova of *Amphiuma* presented by Mr. Beck.—A very useful addition to microscopes with concentric rotating stage was exhibited by Mr. Crouch, by which the instrument could be accurately adjusted to the centre of the stage when different objectives were employed.—Dr. Lawson exhibited and described a new apparatus termed the *Hematimètre*, designed by M. Hagen and constructed by Nachet, for the purpose of estimating the number of corpuscles in a given quantity of blood.—Mr. A. W. Bennett called attention to some minute organisms which he had discovered upon the leaves of *Drosera* and other carnivorous plants, and which he regarded as being intimately connected with the process of nutrition.—A very interesting paper was read by Prof. W. Rupert Jones, on Foraminifera with special reference to their variability of form. The subject was profusely illustrated by large diagrams, models, &c.

MANCHESTER

Literary and Philosophical Society, Nov. 2.—Mr. R. Angus Smith, F.R.S., vice-president, in the chair.—Mr. Peter Spence, F.C.S., &c., exhibited a piece of 2 to 3-inch lead pipe in which the metal had been entirely transformed into galena, the crystallisation being visible through the whole of the specimen. The pipe had been used for the conveyance of gas ammoniacal water, and was sunk under ground. A considerable leak of gas-water having occurred, a constant atmosphere of sulphide of ammonium would surround the pipe, and this seems to have been the cause of the conversion of the lead into sulphide, as only that part of the pipe which was in the vicinity of the leak was found to be transformed.—On the principle of the electro-magnet constructed by Mr. John Faulkner, by Prof. Osborne Reynolds. The magnet which forms the subject of this paper consists of a soft iron bar with a flat plate attached to one end, and surrounded by a coil of wire in the same way as the ordinary electro-magnet. Outside this coil is placed a tube of soft iron of the same length as that portion of the interior bar which projects beyond the plate; this tube has flat ends, one of which is in contact with the plate, while the other comes up flush with the end of the bar, so that a plate or keep placed over the end is in contact with both the bar and the cylinder. The magnet is excited in the ordinary way, by connecting the ends of the wire which forms the coil with the poles of a battery. When thus excited this magnet exhibits certain peculiarities as compared with a common magnet. The object of the paper was to suggest explanations of these phenomena.

Nov. 16.—Rev. William Gaskell, vice-president, in the chair.—On an instrument for measuring the direct heat of the Sun, by Prof. Balfour Stewart, F.R.S. The instrument generally em-

ployed for giving the radiant energy of the sun's rays acts upon the following principle:—In the first place the instrument is sheltered from the sun, but exposed to the clear sky, say for five minutes. Let the heat so lost be termed  $r$ . Secondly, the instrument is turned to the sun for five minutes. Let the heat so gained be termed  $R$ . Thirdly, the instrument being now hotter than it was in the first operation, is turned once more so as to be exposed to the clear sky for five minutes while it is shielded from the sun. Let the heat so lost be termed  $r'$ . It thus appears that  $r$  denotes the heat lost by convection and radiation united, when the instrument, before being heated by the sun, is exposed for five minutes to the clear sky, while  $r'$  denotes the heat lost by these same two operations by a similar exposure after the instrument has been heated by the sun; and it is assumed that the heat lost from these two causes during the time when the instrument is being heated by the sun will be a mean between  $r$  and  $r'$ , and hence that the whole effect of the sun's rays will be in reality  $R + \frac{r+r'}{2}$ . Now although this assumption

may in the average of a great number of experiments represent the truth, yet in many individual cases it may be far from being true. It would therefore seem to be desirable to get rid of this uncertainty by constructing an instrument in which we are sure that the causes of variability are not allowed to operate. These causes of variability I have attempted to get rid of in the following manner. With the help of Mr. Jordan, mechanican at Owens College, the following instrument has been constructed. It consists of a large mercurial thermometer with its bulb in the middle of a cubical cast-iron chamber, this chamber being of such massive material that its temperature will remain sensibly constant for some time. The chamber with its thermometer has

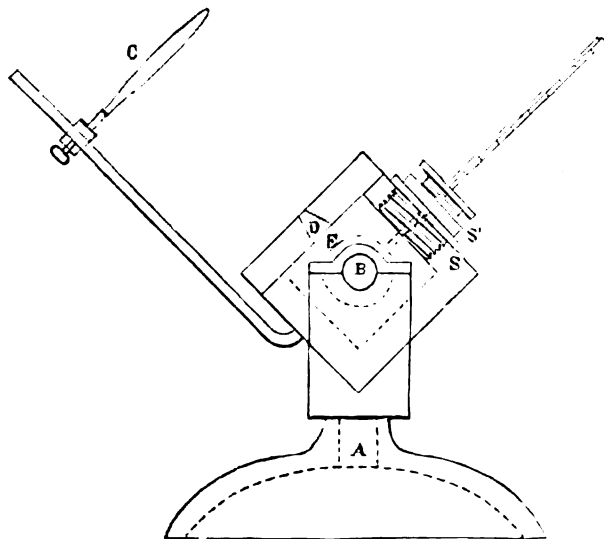

a motion in azimuth round a vertical axis A, and also a motion in altitude round a horizontal axis B. A 3-inch lens C of 12 inches focal length is attached by means of a rod to the cubical chamber, so as to move with it. The nature of this attachment will be seen in the figure. Thus the whole instrument may be easily moved into such a position that the lens, as well as the upper side of the chamber which is parallel to the plane of the lens, may face the sun, and an image of the sun be thrown through the hole D in the side of the chamber upon the thermometer bulb E. The stem of the thermometer protrudes from the chamber as in the figure. A screw S, somewhat larger in diameter than the bulb of the thermometer, is made use of to attach the thermometer to its enclosure, and a smaller screw S', pressing home upon india-rubber washers, enables the thermometer to be properly adjusted and kept tight when in adjustment. In the present instrument the internal diameter of the chamber is two inches, while the bulb of the thermometer is about 1½ inches in diameter. The scale of the thermometer is very open, more than an inch going to one degree. I have generally allowed the image of the sun given by the lens to heat the thermometer bulb for one minute, during which time an increase of temperature, not exceeding in any case two degrees, has been produced. As far as principle is concerned there appears

to be no objection to the present instrument; nevertheless it is open to a very serious practical objection. The scale being so very open, the stem comprehends only a few degrees; frequently, therefore, the temperature is such that the extremity of the mercurial column is either below or above the stem. Now the thermometer has a small upper chamber, and by means of a method of manipulation well known to those who work with thermometers, it is possible to add to or take away from the main body of mercury in the bulb, so as to keep the end of the mercurial column always in the stem. But experience has convinced me that for a thermometer with such a large bulb, frequent manipulation of this kind is not unattended with danger to the bulb. On this account the instrument in its present form is, I conceive, unsuited for steady work in an observatory from year to year. It is however possible, without any appreciable sacrifice of the scientific principle of the instrument, to alter it in such a manner as to remedy this defect. Without altering the size of the bulb, I should propose for a permanent instrument a stem say eighteen inches long with a bore of such diameter that the stem should embrace a range of temperature between 20° Fahr. and 92° Fahr. Thus somewhat less than five degrees will go to the inch. The stem might be protected from the risk of accident by an appropriate shield. Let such a thermometer be heated for two minutes and the size of the lens be somewhat increased. In this case a rise of something like 5° Fahr. will be obtained, and this heating effect might very easily be estimated to one hundredth of the whole, while the same thermometer would serve for all the temperatures likely to occur in these islands during the course of the year. I ought to add that a pasteboard cover, gilded on the outside, is made to surround the chamber, and also that between the lens and the chamber there is a pasteboard shield with a hole in it to permit the full rays from the lens to pass—the object of this shield being to prevent rays from the sun or sky from reaching the instrument. In such an instrument  $r$ , or the change taking place in the thermometer before exposure to the sun, will in all probability completely disappear, while  $r'$  will be extremely small. At any rate we may be quite certain that  $R + \frac{r+r'}{2}$  will accurately represent the heating effect of the sun.

We may probably suppose that in the same instrument the lens (which must always be kept clean) will always stop the same or nearly the same proportion of the solar rays. But the lens of one instrument may not stop the same proportion as that of another instrument. This, however, is no objection if it be borne in mind that the instrument is a differential one. In practice there would be some standard instrument which would be retained at a central observatory, and all other instruments would, before being issued, be compared with it. It would be thus possible to compare together the indications of various instruments working in different places, provided that these before being issued had their co-efficients determined at the central observatory.—On a colorimetric method for determining small quantities of copper, by Thomas Carnelley, F.C.S., Demonstrator in the Chemical Laboratory of Owens College. Communicated by Prof. H. E. Roscoe, F.R.S.

## BERLIN

German Chemical Society, Nov. 22.—A. W. Hofmann, president, in the chair.—V. Gomp-Besanez has discovered diastatic ferments, transforming fibrine and albumin into peptones in malt and in linseed and hemp-seed, proving thereby a hypothesis of Hooker and Darwin respecting the power of plants for dissolving starch, &c. (expressed in Darwin's "Insectivorous Plants," p. 362).—F. Salomon, in a paper on the formation of anhydrides in chemical reactions, tries to explain why sulphocarbonate of ethyl treated with methylate or potassium yields sulphocarbonate of methyl, while *vice versa* sulphocarbonate of methyl and ethylate of potassium yield sulphocarbonate of ethyl. He supposes that in these reactions CSO is set free and reacts on methylate or on ethylate of potassium.—H. Skraup described a product of the action of chlorine on ferricyanide of potassium, perhaps  $\text{FeCy}_6\text{K}_2$ .—L. Barth has obtained a ferrocyanide of tetramethylammonium (yellow crystals) by saturating ferrocyanic acid with tetramethylammonium-hydrate.—L. Barth and C. Senhofer, in preparing disulphobenzolic acid, have found this acid to be, when prepared at a moderate temperature, metadisulphobenzolic acid, at a higher temperature paradisulphobenzolic acid; the former yielding isophthalic, the latter terephthalic acid; both, however, by fusion with potash yielding resorcinic.—C. Senhofer has prepared naphthalintetrasulphurous acid,  $\text{C}_{10}\text{H}_6(\text{SO}_3\text{H})_4$ , by treating naphthalin with oil of vitriol and

phosphoric anhydride.—O. Hausmann, by distillation of  $\beta$ -naphthoate of calcium, has obtained a ketone identical with the one that  $\beta$ -naphthoyl-chloride and naphthalin yield by heating them with zinc.—C. Jaeger, by fusing nitrosophenol with potash, has obtained azophenol,  $C_6H_4(OH)NNC_6H_4(OH)$ , crystals of the constant melting-point  $214^\circ$ .—Robert Schiff has succeeded in producing nitroso-thymol,  $C_{10}H_{13}(NO)OH$ , by treating thymol with nitrite of potassium and sulphuric acid. Nitrosothymol yields nitrophenol when oxidised with ferricyanide of potassium. Nitrothymol has been transformed into amidothymol and diazothymol by the ordinary methods.—O. Rembold, by treating ellagic acid ( $C_{14}H_8O_6$ ) with zinc powder at high temperatures, has obtained a new isomeride of anthracene, to which he gives the name ellagene (melting-point,  $88^\circ$ , boiling-point,  $252^\circ$ ; its chinone insoluble in sulphite of ammonium, yielding itself no precipitate with picric acid). Ellagic acid boiled with potash yields a new acid ( $C_{14}H_8O_6$ ), which, by sodium amalgam (?) and water, is transformed into the acid  $C_{14}H_{10}O_7$ .—F. Schardinger described nitro-derivatives of anthraflavone.—A. Vogel showed absorption-bands of manganic, uranic, and chromic salts; also absorption-bands of hydrate of cobalt, which, suspended in water, shows absorption-bands on D and between D and C. They appear also in the presence of nickel with great clearness. Sulphocyanate of iron shows an absorption-band between G and E.—A. Pinner, who from 1870 up to the present time has studied the derivatives of what he considered croton-chloral, has now come to the conclusion that the greater part of his researches have been erroneous, in as far as all the compounds described by him contain two atoms of hydrogen more than he has alleged. Thus what has been called crotonic chloral is really butyric chloral. Its derivative with hydrocyanic acid is not trichloroangelic, but trichlorovalerianic acid. Its product of oxydation and subsequent reduction are not chlorocrotonic, but chlorobutyric acids. Potash does not produce a chloride  $C_3H_5Cl_2$ , but chloride of allylene ( $C_3H_4Cl_2$ ), which by sodium is not transformed into "a new hydrocarbon,  $C_3H_4$ ," of which he has lately taken the trouble of giving a structural formula, but into allylene,  $C_3H_4$ .—W. Weith has proved the sulpho-ureas produced by the action of aniline on ethylic isosulphocyanide, and of ethylamine on phenylic isosulphocyanide, to be identical. Oxide of lead transforms them into an imide,  $C(NC_2H_5)(NC_6H_5)$ ; and the action of aniline and of  $HClNC$  also produce identical derivatives.

GENEVA

Society of Physics and Natural History, Nov. 4.—Prof. Calladon published in 1872 (tome xxi. of the Memoirs of the Society) a paper on the effects of lightning on trees, &c. A case of a pyramidal poplar struck by lightning on August 4 last, near Rolle, in the Canton de Vaud, enabled him to verify some of his previous conclusions, and to add some new observations. The flash which struck this tree, situated 11 metres from the shore of the Lake of Geneva, left perfectly intact the upper portion. At seven-eighths of its height commences the trace left by the lightning, in the form of a wound (*plaid*) three to four centimetres in width, and from seven to eight centimetres in depth. This wound descends as far as the ground, turning round the trunk in the form of a screw, and describing four-fifths of the complete circumference of the tree. Fragments of wood of various sizes were projected to distances as far as fifty metres. Some are pierced by jagged holes, indicating a violent eruption of the electric fluid from the interior to the exterior, the track of the fluid having probably been in the layer which separates the albumen from the old wood or duramen. The places where the emission of the fluid occurred are sometimes indicated by spots of a red colour, similar to the effect which might be produced on wood by the application of a hot iron. They correspond to a slight depression of the surface of the wood. The wound of the tree is turned from the shore of the lake, lightning striking more readily plants which grow near watercourses, visible or underground.

PARIS

Academy of Sciences, Nov. 29, M. Frémy in the chair.—The following papers were read:—Theorems in which there is a condition of equality of two segments taken on normals and tangents of curves of any order and class, by M. Chasles.—Reply to notes of M. Duchartre and M. Violette, *à propos* of stripping off the leaves of beet, by M. Cl. Bernard.—Memoir on organic elements considered as electro-motors, by M. Becquerel.—Examination of a piece of wood petrified by subcarbonate of lime

found at Bourbonne-les-Bains, in a Roman cesspool, by M. Chevreul. This is regarded as confirming the author's theory of petrefaction given in 1866.—Mineralisation of organic *débris*, vegetable and animal, in the thermal water of Bourbonne-les-Bains, by M. Daubrée.—Thermal researches on phosphoric acid, by MM. Berthelot and Louguine.—Atmospheric perturbations of the hot season of 1875; group of rains from 21st to 24th of June; Flood of the Garonne, disasters at Toulouse, by M. Belgrand. The floods of the Garonne since 1770 have always been in spring or early summer, and, almost without exception, the maximum of rain and flood has been on the 23rd of June.—Reply to some objections raised by our recent communications on the useful effect of steam injectors, by M. Ledieu.—M. Daubrée presented a flattened angular meteorite sent by Prof. Hinrichs, from Iowa.—On the coefficient of capillary flow, by M. Guerout. The flow is in a horizontal tube; and in the case of alcohols the coefficients do not form a regular series; they diminish for alcohols richer in carbon; but bodies of similar composition and density often differ in fluidity.—On the composition of arable land in Auvergne; importance of phosphoric acid for its fertility, by M. Truchot.—On a system of irrigation of meadows by means of rain-water, in mountainous and impermeable regions, by M. Le Play.—On the Meteorological Observatory of the Pic du Midi de Bigorre (Hautes-Pyrenees), by General de Nansouty.—On some indications of the existence of Edentata at the commencement of the miocene epoch, by M. Gaudry.—On the contraction produced by rupture of the battery current, in the case of unipolar excitation of nerves, by M. Chauveau. The negative pole has but little aptitude to produce contraction at opening. Positive or negative, the opening contractions are distinguished for their brevity and equality.—On the poisonous principle in damaged maize, and its application in pathology and therapeutics, by M. Lombroso. The action is like that of strychnine.—On the earth-worms of the Philippine Islands, and of Cochinchina, by M. Perrier.—Application of a theorem, complementary of the principle of correspondence, to determining, without calculation, the order of multiplicity of a point O, which is a multiple point of a given geometrical place, by M. Saltel.—On the discussion of equations of the first degree, by M. Rouché.—On the points of a curve or a surface, which satisfy a condition expressed by a differential equation or partial derivatives, by M. Halphen.—Crystallised sulphocarburet, from the interior of a mass of meteoric iron, by Mr. Lawrence Smith.—On the nature of flame, according to Galen and Aristotle, by M. Calliburcés. The experiment of the two candles, as proving that flame is a phenomenon produced by ignition of gas, is carried back to Aristotle.—On certain anatomical details of *Sarcoptes scabiei* and its numerous varieties, by M. Megnin.—On the muscoid cilia of the common mussel, by M. Sabatier. These organs have affinity with muscular tissue when they are agglutinated, and with vibratile cilia when dissociated and isolated.

CONTENTS

	PAGE
SCIENTIFIC AGRICULTURE.—By Prof. THOMAS BALDWIN . . . . .	101
THE NEW GEOMETRY . . . . .	102
ESKIMO TALES AND TRADITIONS ( <i>With Illustration</i> ) . . . . .	103
OUR BOOK SHELF:—	
Sutton's "Report on Trichinosis." By Dr. T. S. COBOLD, F.R.S.	105
Michelet's "The Sea" . . . . .	106
LETTERS TO THE EDITOR:—	
The Dresden "Gorilla."—Dr. A. B. MEYER . . . . .	106
Dr. Stoliczka's Collection of Mammals.—H. H. GODWIN-AUSTEN . . . . .	106
Glands of the Cherry Laurel.—G. S. BOULGER . . . . .	107
Saw-fish inhabiting Fresh Water.—W. W. WOOD . . . . .	107
Observations on Fish.—ROBERT U. S. MITCHELL . . . . .	107
Misti and its Cloud.—Prof. ALEXANDER AGASSIZ ( <i>With Illustration</i> ) . . . . .	107
The Effect of Waves.—Capt. W. W. KIDDLE, R.N. . . . .	108
OUR ASTRONOMICAL COLUMN:—	
The Total Solar Eclipse of 1605, Oct. 12 . . . . .	108
The Minor Planets . . . . .	109
LIST OF MAMMALS OF YARKAND . . . . .	109
ARCHÆOLOGICAL RESEARCHES IN KENTUCKY AND INDIANA . . . . .	109
SCIENCE IN ITALY. By C. T. . . . .	110
SCIENCE IN GERMANY. By W. . . . .	112
NOTES . . . . .	112
THE DIFFERENCE OF THERMAL ENERGY TRANSMITTED TO THE EARTH BY RADIATION FROM DIFFERENT PARTS OF THE SOLAR SURFACE. By Capt. J. ERICSSON ( <i>With Illustrations</i> ) . . . . .	114
THE GRAPHIC METHOD OF REPRESENTING MUSICAL INTERVALS. By Dr. POLE, F.R.S. . . . .	116
THE SWEDISH ARCTIC EXPEDITION . . . . .	116
BOTANICAL NOTES:—	
The Calcutta Botanical Gardens . . . . .	117
Gum Arabic . . . . .	117
SOCIETIES AND ACADEMIES . . . . .	118



THURSDAY, DECEMBER 16, 1875

## HAECKEL'S HISTORY OF CREATION

*The History of Creation.* From the German of Ernst Haeckel, Professor in the University of Jena; the translation revised by Prof. E. Ray Lankester, M.A., F.R.S., Fellow of Exeter College, Oxford. In two vols. crown 8vo, pp. 374, 401; 15 lithographic plates, woodcuts, and genealogical tables. (London: King and Co., 1876.)

HAVING in a review of Prof. Haeckel's "Anthropogenie" (see NATURE, vol. xi. pp. 4, 22) criticised both the manner and the substance of his popular lectures on Evolution, it is unnecessary to repeat what was then said. The "Schöpfungsgeschichte" is the earlier work of the two; it deals more with the general question of the evolution of the Organic Kingdom and less with its special application to Man; its tone is somewhat more moderate, and its statements and plates are less highly coloured. But the object and the style of both books are essentially the same, and they will be praised or condemned together.

Even in the short time since the delivery of the present lectures several points have been established which necessitate a modification of the views here expressed. The origin of the urino-genital organs has been proved in the classes as yet completely examined to be from the middle layer of the embryo; the embryology of Amphioxys and of Mollusca has been elucidated—by none more than by the editor of this translation; the placental classification of Mammalia, never accepted by all zoologists, has been almost reduced to the same rank as Waterhouse and Owen's cerebral system; the true nature of Lichens has been cleared up, and relations between Algæ and Fungi have been established which disturb the roots of the genealogical tree on Plate V. Moreover, Dr. Dohrn's bold speculations lately published in his pamphlet "Der Ursprung der Wirbelthiere und das Princip des Functionwechsels," have brought the question of degradation of many lower forms as well as of the genetic relations of Vertebrata into a new phase. It is remarkable how little the previously well-known instances of "degraded forms" are considered in these lectures. Surely some of the numerous twigs of the fifth, sixth, and fourteenth plates might have been turned downwards.

But whatever may be thought of the advantage of exhibiting together established truths and more or less erroneous speculations, in a dogmatic and controversial form, before an uncritical audience, there is no question of the value of these lectures to naturalists. They awaken thought, provoke criticism, and stimulate inquiry.

Turning from the subject-matter to the translation, we must call it an exceedingly good one. No one who has not tried knows the difficulty of presenting a continuous work in a foreign language to an English reader so as to drop the idiom and yet retain its character. If a page of the body of the work be compared with Prof. Haeckel's own preface—written in very good English, but as a foreigner writes—the reader will see at once how much he is indebted to the lady who, we are told, made the first draft, or to Mr. Lankester, who revised it.

The following passage is a fair specimen of the book:—  
"Of the twelve species of men distinguished in the following table [namely Papuan, Hottentot, Caffre, Negro, Australian, Malay, Mongolian, Arctic, American, Dravidian, Nubian, Mediterraneanese, beside hybrids], the four lower species are characterised by the woolly nature of the hair of their heads; every hair is flattened like a tape, and thus its section is oval. These four species of woolly-haired men (*Ulotrichi*) we may reduce into two groups, 'tuft-haired' and 'fleecy-haired.' The hair on the head of tuft-haired men (*Lophocomi*), Papuans and Hottentots, grows in unequally divided tufts. The woolly hair of fleecy-haired men (*Eriocomi*) on the other hand, in Caffres and Negroes, grows equally all over the skin of the head. All *Ulotrichi*, or woolly-haired men, have slanting teeth, and long heads, and the colour of their skin, hair, and eyes, is always very dark. All are inhabitants of the Southern Hemisphere: it is only in Africa that they come north of the equator. They are, on the whole, at a much lower stage of development, and more like apes than most of the *Lissotrichi*, or straight-haired men. The *Ulotrichi* are incapable of a true inner culture and of a higher mental development, even under the favourable conditions of adaptation now offered to them in the United States of North America. No woolly-haired nation has ever had an important history.

"In the eight higher races of men which we comprise as straight-haired (*Lissotrichi*), the hair of the head is never actually woolly, although it is very much frizzled in some individuals. Every separate hair is cylindrical (not like a tape), and hence its section is circular (not oval).

"The eight races of *Lissotrichi* may likewise be divided into two groups—stiff-haired and curly-haired. Stiff-haired men (*Euthycomi*), the hair of whose heads is quite smooth and straight, and not frizzled, include Australians, Malays, Mongolians, Arctic tribes, and Americans. Curly-haired men, on the other hand, the hair of whose heads is more or less curly, and in whom the beard is more developed than in all other species, include the Dravidians, Nubians, and Mediterranean races."

The Caucasian, or to adopt Fr. Müller's less recognised name, the Mediterranean race, is divided into four sub-races by the aid of language: these are (1) the Caucasians proper of Georgia and the surrounding mountainous district; (2) the Basques; (3) the Semitic nations, including not only the Arabs and Jews (*Eusemites*), but also the Hamitic or "Dyssemitic" Egyptians and Berbers, with some other African tribes; (4) the great Indo-Germanic or Aryan race, including Indo-Persians, Greeks, Italians and Kelts, Slavonians and Teutons. The following passage concludes the chapter:—

"The third and most important main branch of primæval Malays, the curly-haired races or *Euplocomi*, have probably left in the Dravidians of Hindostan and Ceylon that species of man which differs least from the common primary form of the *Euplocomi*. The principal portion of the latter, namely, the Mediterranean species, migrated from their primæval home (Hindostan?) westwards, and peopled the shores of the Mediterranean, South-Western Asia, North Africa, and Europe. The Nubians in the north-east of Africa must perhaps be regarded as an offshoot of the primæval Semitic tribes who migrated far across Central Africa almost to the western shores.

"The various branches of the Indo-Germanic race have deviated furthest from the common primary form of ape-like men. During classic antiquity and the middle ages, the Romanic branch (the Græco-Italo-Keltic group), one of the two main branches of the Indo-Germanic species, outstripped all other branches in the career of civilisation; but at present the same position is occupied by the Germanic. Its chief representatives are the

English and Germans, who are in the present age laying the foundation for a new period of higher mental development in the recognition and completion of the theory of descent. The recognition of the theory of development and the monistic philosophy based upon it, forms the best criterion for the degree of man's mental development."

A noteworthy feature in the present translation is the attempt Mr. Lankester has made to use English equivalents for the technical terms of anatomy and zoology. The facility with which Prof. Haeckel invents terms, and the habitual use in German of vernacular phrases in scientific writing, made this a good opportunity for trying an experiment which the translator has before now recommended. The result shows great ingenuity and good judgment, and is probably as successful as the conditions of the attempt allow.

It will be generally admitted that the English language is incomparably richer and more flexible than the French, while it lacks the precision and neatness which with ordinary French writers is apt to become too mechanical and uniform, but in the hands of a master produces the most perfect instrument for scientific exposition. On the other hand, German is far more cumbersome and undisciplined than English, but has a slovenly ease, a picturesque force and a power of adaptation and word-making, which reminds one of our own language in the first half of the seventeenth century.

A French scientific writer cannot make a new term or form a compound in his own language, but must construct a Greek compound (often ill-formed), and even this must be modified so as to assimilate it to French pronunciation. And comparing the style of Bichat and of Cuvier with that of contemporary writers, we see that the stiffness and severity of the language has increased during the present century. Germans, on the other hand, can invent compounds without limit in number or in length, and can introduce foreign terms as they are wanted, even declining them in accordance with the German prepositions against which they are thrown.

The English language has much less power of forming compounds, though poets like Tennyson and Morris show us how flexible it becomes in powerful hands; but it has a remarkable capacity for assimilating foreign words. The unequalled richness of the language chiefly depends on its having so many synonyms, and this again on its composite character. The choice of words like friendship, amity; righteous, just; begin, commence; wax, increase; weariness, fatigue; spue, vomit; raise, erect; fruitful, fertile, gives peculiar accuracy, character, and delicacy to modern English.

If purely English words were to be generally adopted in science, we should, in the first place, be obliged to shock modern decorum in a way that would be practically impossible. Germans still write of *Kothenlleerung*, *Wollustorgane*, *Asterbildung*; but such plainness of speech would be intolerable in English. Even such words as sweat, spue, spit are much better kept for rhetoric and poetry than used as physiological terms.

Moreover, our purely English names are too popular to be tied down to technical definition. The word "worm," for instance, applied by Milton to the serpent, and universally to the larva of diptera, can never be limited to correspond with the class Vermes. The objection that

English terminology is not "scientific" can only mean that it is not scientifically accurate. To make it so would injure it for every other purpose.

Surely it is better to speak of the *ophidian* character of a vertebra than to call it "serpentine" or "snake-like." The first word refers to the anatomical distinctions of the class Ophidia, the second to the peculiar, lateral, wriggling locomotion of these animals, and the last to their supposed mental characteristics. In the same way *avian* is a better scientific term than "bird-like," \* *mammalian* than "beastly," and *piscine* than "fishy;" because those are at once recognised as referring to the technical characters of the classes Aves, Mammalia, and Pisces respectively, while these suggest far more vividly the special peculiarities which common observation associates with them.

It must however be admitted that a vernacular synonym is often of value. It brings an unobvious fact vividly and clearly before one. Thus the phrases, "a fox is a kind of dog," "a tiger is only a large cat," "the swordfish is a sort of mackerel," are certainly more easily remembered than corresponding statements in "scientific" language.

The simplicity and directness of idiomatic English is often an advantage as a matter of style.

For teaching botany to children, and generally for explaining scientific facts to persons unfamiliar with technical names, it is often desirable to use vernacular terms, either to avoid disgusting them with hard words to begin with, or to fix the attention on facts rather than names and prevent the learner supposing that he has made a step in knowledge when he has learned to call hardness impenetrability, or a buttercup *Ranunculus*.

Lastly, for the probably increasing number of persons who study science without having learnt Greek, it is of great importance that even when using technical names they shall know the English synonym as a kind of ready translation. When everyone wrote in Latin many terms which are now become technical were simply descriptive. Thus "the passage from the third to the fourth ventricle of the brain" was certainly never meant to be a proper name, nor was "the waterpipe of Sylvius:" but now when "iter," "aquæduct," "tympanum," "cilium," have become restricted to single objects, it is well that their meaning should be readily apprehended by the use of appropriate English synonyms. At all events the attempt was worth making, and we will conclude this notice by giving a list of some of the synonyms used by Mr. Lankester.

Cotyledon	= Seed-lobe or germ-leaf.
Nucleus	= Kernel.
Nucleolus	= Kernel-speck.
Cytod (su rely this should be cythode).	
Catallacta	= Flimflam balls.
Labyrinthulæ	= Tramevears.
Diatomacæ	= Flintcells.
Rhizopoda	= Raystreamers or Rootfeet.
Algæ	= Tangles or waterweeds.
Labiatæ	= Lipblossoms.
Gamopetalæ	= Bell-flowers.
Ctenophora	= Combjellies.
Lamelibranchiata	= Mussels.
Gasteropoda	= Snails.
Crustacea	= Crabfish.

\* The prettily invented word "unbirdly" occurs in Cowley's fine Ode on Liberty—

"Even to the universal tyrant love  
You homage pay but once a year,  
None so degenerate and unbirdly prove  
As his perpetual yoke to bear."

Sagitta	= Arrowworm.
Tunicata	= Sea-sacs, including sea-squirts ( <i>Phal-lusia</i> ), and sea-barrels ( <i>Salpa</i> ).
Chitonidæ	= Beetle-snails.
Tetrabranchiata	= Chamber-poupls.
Pycnogonida	= Nobody-crabs.
Arthropoda	= Insects.
Insecta	= Flies.
Phocidæ	= Sea-dogs.
Sirenia	= Sea-cows. (This order is allowed to remain in unnatural alliance with Cetacea.)

We have noticed a few verbal errors, such as "cetæ" for "cete," "coecum" for "caecum," two misprints on p. 308, and an unlucky form of the name of an African tribe on p. 330.

The plates are excellently reproduced, and the print, paper and index show the care with which these two volumes have been prepared.

P. H. P. S.

### BURTON'S GORILLA LAND AND THE CONGO

*Two Trips to Gorilla Land and the Cataracts of the Congo.* By Richard F. Burton. Two vols. (London: Sampson Low and Co., 1876.)

THE journeys here recorded were made so long ago as 1862 and 1863. Since that time Capt. Burton has not been idle; between exploring and publishing the results of his explorations he has sufficient excuse for having kept from the public for so long the narrative of his trips to the Gaboon and the Congo. Moreover, as he says himself, Africa moves so slowly, that ten years makes scarcely any appreciable change on a locality. The publication of the work at the present time is opportune, as public attention is being directed to the region with which it is concerned; the German African Society have taken up the Congo district as a *point de départ* for the interior, and although the expedition sent out has not been so successful as might be wished, still Dr. Pogge and Dr. Lasaulx, according to the latest news, are endeavouring to push inwards from Loanda. There have been several explorers on the same ground since Capt. Burton visited it twelve years ago, and there have been many previous explorers—the stretch of coast included in the two narratives contains some of the earliest Portuguese settlements; but as was shown in his recently-published book on Iceland, this widely experienced traveller and keen observer can shed new and unexpected light even on the most frequently trodden paths. The present work will be found a substantial contribution to our knowledge of the Gaboon and Congo districts, especially in the matters of geography, topography, and people.

Capt. Burton's visit to the Gaboon extended over only a few weeks in March and April 1862, but during that time, his first volume shows, he managed to see and to learn much. He is nothing if not unflinchingly true to his opinions, and these, as usual, he expresses freely and without respect of persons throughout the two volumes. He gives rather an unpleasant picture of the character and condition of the French trading establishments on the Gaboon, and indeed has not much praise to bestow on any of the establishments, French, Portuguese, or English, which he has occasion to mention in his work. Capt. Burton's chief object in visiting the Gaboon was to obtain some specimens of Gorilla, and, if possible, get a

young one alive. He did not, however, get a shot at one during all the time of his visit; but a fine specimen was sent him by a native before he left, which, in a sadly deteriorated condition, now rests in the British Museum.

The traveller made a trip in pursuit of "our big brother," as he calls the animal, to the south side of the river, and gives some very graphic pictures of the degraded natives who inhabit the many villages of the district. His remarks on the customs of the people, the Mpongwe, as they are called, especially their marriage and religious customs, are extremely interesting. This chapter is interspersed with many shrewd philosophical remarks, in Capt. Burton's well-known style, on human customs generally, and shows extensive knowledge derived both from reading and experience. What he says upon the curious resemblance between certain customs among the Mpongwe and other West-Coast tribes, and the religious rites of the Jews, seems to us of real value. He also refers to what has been done to obtain a knowledge of the language of these people. His lively description of the troubles he had with the slippery and lazy natives in seeking the Gorilla will be found very amusing. With reference to the habits of the Gorilla, Burton substantially confirms the statements of Du Chaillu, though in some few points the matter-of-fact Englishman shows that the Frenchman had given way to exaggeration; e.g., in the matter of the elaborately-constructed canopied nest or hut, Capt. Burton thinks Du Chaillu must have been deceived by some vagary of nature. The natives ridiculed the idea, and all that Capt. Burton saw were heaps of dried sticks built in forks of trees, and which a schoolboy might have taken for birds' nests. One entire chapter is devoted to "Mr., Mrs., and Master Gorilla," in which are discussed the results of his own and of other observations. It includes a historical account of references to the Gorilla, from Hanno the Carthaginian, downwards; the geographical limits of the animal are pointed out, as well as the modifications which ought to be made in Du Chaillu's account.

Capt. Burton made a trip down the coast for a few miles and another up the river to the Fan (Fan he spells it, to indicate that the *n* is strongly nasalized cannibals; but the existence of cannibalism, in the ordinary sense of the term, seems doubtful. They do roast and eat portions of their enemies slain in battle, but this evidently is regarded as a quasi-religious rite. As might be expected, Capt. Burton indulges in a brief dissertation on anthropophagy in general, bringing to bear upon it much knowledge of the customs of peoples in various parts of the world. With regard to the Fans, Du Chaillu's account led him to expect to see "a large-limbed, black-skinned, ferocious-looking race, with huge mustachios and plaited beards. A finely-made, light-coloured people, of regular features and decidedly mild aspect, met my sight." On the whole, the Fans seem to be a very fair specimen of savage man. Capt. Burton gives details concerning the various tribes at the head and to the east of the Gaboon, about whom little or nothing is as yet known, and points out the suitability of the river as a *point de départ* for exploration in Inner Africa. One chapter is devoted to the geography of the Gaboon region. On the voyage back Capt. Burton visited Corisco Island in the bay of that name, about which and the missionaries

upon it he gives some interesting details. A good map of the coast districts for two degrees on each side of the equator accompanies the first volume.

The second volume refers to a visit made in July—September, 1863, to the Congo and the Portuguese settlements on the adjoining coast. Concerning these settlements many valuable and curious facts are given throughout the volume, both historical and as the result of the traveller's own observation at the colony of Loanda. Capt. Burton notes a considerable improvement in the morals and manners of the settlers as compared with previous accounts. The picture of the English establishments at Loango is not a very bright one. He paid a visit to Calumbo on the Cuanza or Quanza river, and mentally noted an exploration eastwards which he pur-

posed to make in the future, but which he is glad to see has been taken up by Capt. von Homeyer. Ambriz to the north of Loanda was visited, and a short trip inland was made, during which, of course, many notes are made on the character and customs of the people. Ambriz has recently come to the front in connection with the German African expedition.

The chief interest of the second volume is connected with the Congo river, up which Burton journeyed as far as the Yellala, or rapids, which he calculates to be between 116 and 117 miles from the mouth, the total fall in that distance being 390 feet, of which 195 feet occurs between the Yellala and Boma, 64 miles. From the Great Rapids to the Vivi or lowest rapids, a distance of five miles, the fall is 100 feet. Some important facts are given as

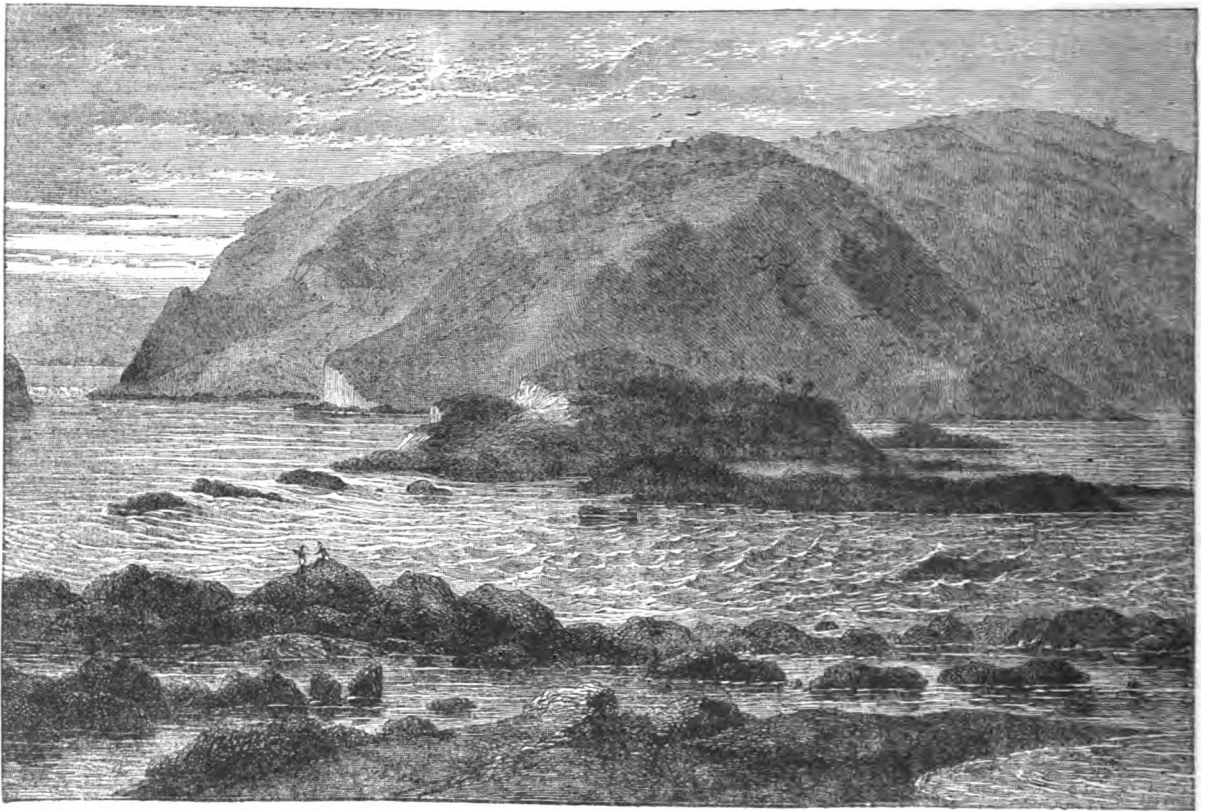

The Yellala (rapids) of the Congo River.

to the character of the Congo mouth and the changes which are constantly taking place, which must even yet be of value to chart constructors. Considerable details are also given concerning the delta or series of islands at the mouth of the Congo, and a chapter is devoted to the explorations of previous travellers. An amusing account is given of his interview with the native king at Banza Chisalla, a few miles above Boma, and in this connection an attempt is made to account for the fondness for what seems to us a most ridiculous dress on the part of African and other savage potentates. The author gives a minute and graphic description of the river and its many reaches

between Boma and the rapids; the scenery on the banks is often quite Rhine-like in its character. The river itself Capt. Burton regards as one of the noblest in the world. With a valley area of 800,000 square miles, it has a yearly mean volume of 2,500,000 cubic feet per second, nearly four times that of the Mississippi, which has a very much larger drainage area. In this connection some interesting data are introduced concerning the four great African arteries, the Nile, the Niger, the Zambeze, and the Congo or Nzadi, as Capt. Burton makes the true native name to be. In the chapter, "Notes on the Congo River," which contains the summary of the explorations of previous travellers, Capt. Burton discusses the probable

connection of the Congo with the water system of Central Africa. This chapter altogether is one of the most valuable in the book.

On his way to the rapids he was detained for some time at the village Banza Nokki, near one of the upper reaches of the river, and of course took the opportunity of studying the people, who seem to have been but little affected by the labours of the Portuguese missionaries who lived among them for so many generations. The district Burton describes as a perfect paradise, the country lovely, and the climate all that can be desired. Very full details are given as to the ways of life of the people, their various customs, their superstitions, their language, &c. After the usual vexatious delays, Capt. Burton was able at last to set out on Sept. 16 for the cataracts of the Congo. These and their surroundings, the character of the country on the river banks and of the people dwelling near, are described in his usual graphic style, and with consider-



Fetish boy (Congo district), showing dress during the novitiate at puberty.

able minuteness. He had hoped to be able to push on as far as Nsundi, upwards of 100 miles beyond the Yellala, but the difficulties thrown in his way by the chiefs on whose expensive favour he was dependent, compelled him to return. In a chapter on "The Slaver and the Missionary on the Congo River," he records opinions which are well deserving the attention of all who not only wish well to the native African, but who desire that the best means be taken for developing the immense resources of that continent, and of tropical countries generally. He concludes "with the hope that the great Nzadi, one of the noblest and still the least known of the four principal African arteries, will no longer be permitted to flow through the White Blot, a region unexplored and blank to geography as at the time of its creation, and that my labours may contribute something, however small, to clear the way for the more fortunate explorer." There can be no doubt that his labours, short as his time was, have added materially to our knowledge of the region visited, and his work must henceforth be regarded as one of the chief authorities, not only on the river and its geography, but on its people, and to a considerable

extent its natural history and meteorology. Like all Capt. Burton's narratives, it is complete and comprehensive, and includes far more than the mere title would lead us to expect; it cannot fail to greatly interest and instruct every intelligent reader.

An excellent chart of the river from the sea to the rapids accompanies the second volume, and the illustrations to both volumes add to its value and interest. Appended are some meteorological data, a list of plants collected in the Congo, at Dahome, and the island of Annabom, and a list of heights of stations on the Congo computed from observations made by Capt. Burton.

#### THE GERMAN NORTH SEA COMMISSION

*Jahresbericht der Commission zur wissenschaftlichen Untersuchung der deutschen Meere in Kiel für die Jahre 1872, 1873.* Im Auftrage des Königlich Preussischen Ministeriums für die landwirthschaftlichen Angelegenheiten, herausgegeben von Dr. H. A. Meyer, Dr. K. Möbius, Dr. G. Karsten, Dr. V. Hensen, Dr. C. Kupffer. 1 Abtheilung. (Berlin, 1875.)

THE Prussian Minister of Agriculture has just published Part I. of the Report of the Commission appointed to inquire into the scientific conditions of the German Ocean at Kiel (for the years 1872, 1873). This Report forms a very important document, filling a small folio volume of 170 pages, with 12 plates and a chart. The editors are Drs. H. A. Meyer, K. Möbius, G. Karsten, V. Hensen, and C. Kupffer. The Report on the currents, temperature, and specific gravity of the sea-water, based on 255 observations made from July 21 to Sept. 9, 1872, is by Dr. H. A. Meyer, and to it there is appended a memoir "On the Air in Sea-water," by Prof. Dr. Oscar Jacobsen. The marine flora of the district is reported on by Drs. Magnus and Schmidt. The only Phanerogams met with were *Zostera marina* and *Z. nana*, and *Potamogeton pectinatus*. Of Algæ, excluding the Diatoms, 116 species are recorded. Of these, *Callithamnion membranaceum* and *Chytridium tumefaciens* are described by Dr. Magnus as new species; the former was found growing over the stems of *Sertularia abietina*, between Sprogoe and Corsoer, in from twenty to thirty fathoms, the latter protruding from the cells of *Ceramium flabelligerum*; these new species are well illustrated in two plates. The presence of claspers is noticed in *Plocamium coccineum* intertwining between Annelid tubes. *Hildebrandtia rosea*, Kütz., is held to be quite a distinct form from *H. rubra*, Meneg., though by Harvey it and *H. sanguinea*, Kütz., were all regarded as one and the same thing. *Hapalidium confervicola*, Kütz., is recorded, but nothing added to clear up our ignorance of this curious little alga. *Bonnemaisonia asparagoides*, Ag., was found bearing both Conceptacles and Antheridia on the same stem. *Myrionema orbiculare*, J. Ag., is the name given with much doubt to a form found very common on the sea-grass. The plant is not figured, but appears to differ from any known species of *Myrionema*: if proved to be generically distinct, the author proposes the name *Asco-cylus* for a genus to receive it. *Chytridium tumefaciens* is described as a new species, growing on the root-hairs and stem-cells of *Ceramium flabelligerum*, taken near Edinburgh. In the description of this species and in the

details given about *Ch. plumule*, Cohn, the interesting question turns up as to what these Chytridia really are. Magnus treats them as a family of Algæ; Henfrey always, we believe, regarded them rather as the products of diseased protoplasm, if not modifications of the antheridial structures of some of the Confervoids. Their apparently common occurrence on Floridæ as well as on Confervoids, ought to enable this question to be definitely answered. Magnus is satisfied that the so-called Antheridea of *Callithamnion dispar* figured by Harvey in Tab. 227 of the "Phycologia Australica," are only Chytridia; certainly the figures represent a very antheridium-like structure, and the original dried specimen from which the figure was drawn is marked "fruit of an abnormal character," and on examination proves rather to favour Magnus's view.

Allogologists, especially those engaged with the description of marine Algæ, have been rather neglectful of describing the minute details to be met with in the structure of the cells of Algæ. The arrangement of the cells, *inter se*, is necessarily studied, as on it the classification of the group depends; but the appearance and arrangement of the cell-contents will, we think, prove to be of as much importance in the investigation of the marine Algæ as it has proved to be in that of the unicellular freshwater forms.

Adolf Schmidt, of Aschersleben, describes the Diatomacæ met with; there are three plates representing 134 forms or portions thereof. These are apparently photographs from drawings of the author.

The zoological results are given in eleven memoirs, with eight plates.

F. E. Schulze describes the Rhizopods and Cœlenterata; O. Schmidt the Sponges; K. Möbius and Bütschli the Echinoderms; K. Möbius the Vermes and Copepods; Kirchenpauer is to describe the Bryozoa, C. Kupffer the Tunicata, Metzger and H. A. Meyer the Mollusca, Metzger the Crustacea, and Möbius and Heincke the Fishes.

A long list of Foraminifera is given. H. B. Brady's papers on the synonymy of this group do not appear to have been consulted; an apparently new species of *Gromia*, about 8mm. in length, is described and figured. Some minute and doubtful-looking forms are described and figured as *Psammosphæra fusca*, n. g. et sp., *Storthosphæra albida*, n. g. et sp., and *Asterodiscus arenaceus* n. g. et sp.

Several new genera and species of Sponges are described and figured by O. Schmidt.

Among the Cœlenterates a new species of *Aglaophenia* (*A. moebii*) is figured and described, and *Kophobelemnion Leuckartii* is figured from a perfectly fresh specimen.

No very rare species among the Echinoderms is catalogued, and some common forms are absent.

Of the Vermes, seventy-six species of Annelida, fourteen of Turbellaria, five of Gephyrea, two of Chætognatha, and one Leech are enumerated. Although some of the species were collected off the very shores of Scotland, yet MacIntosh's works on the British Nemertians seem to have been overlooked in the determination of the species. A remarkable new form near *Phascolosoma* is described as *Crystallophrison nitens*. Almost the whole body is thickly encircled with colourless shining scales. The scales are

somewhat wedge-shaped, with the narrow edge imbedded in the skin. This new species was dredged off the Silver Pit on the edge of the Dogger Bank. Further investigation may cause this species to be relegated to the Echinoderms. Three new species of worms are described.

The Second Part, containing the remaining orders, has just been published, and shall be reviewed in a second notice. To the British naturalists these Reports will be most valuable, but their form of publication may cause them to be easily overlooked; we have therefore noticed them somewhat in detail. E. P. W.

#### OUR BOOK SHELF

*The Origin of the Sun's Heat and the Chemical Constitution of the Matter of his System.* (Troy, N.Y., 1875.)

THE author's name does not appear on the title-page of this pamphlet, so that it was not till we had inflicted ourselves with its contents that we discovered at the end the signature William Coutie. The author, judging from the present production, is referable to that class of visionary speculators which includes among its numbers circle-squarers, seekers for perpetual motion, and those who perform what we may call arithmetical juggles with the atomic weights of the chemical elements. First comes a preface containing an extract from Priestley's narrative of the discovery of oxygen to which we shall again refer; after which follows a page headed "From the Acid Relations of the Elements" 1871, from which we select the two first paragraphs:—"I have now examined all the well-known elements with so much care that I cannot believe any general mistake possible, and find they are all compounds of hydrogen and three others whose weights are exact multiples of the weight of hydrogen. It is probable, therefore, they are all hydrogen; but before saying more I would request the aid of your skill in proving the above by experiment or the favour of your remarks so that I may correct errors or make the subject more clear or complete." We now lay before our readers the state in which Mr. Coutie leaves the question of the origin of the sun's heat. After demonstrating to his own satisfaction that none of the existing hypotheses are sufficient to account for this supply of heat, the author makes a series of statements leading up to the following conclusion, which must be allowed to speak for itself:—"As the energy of the earth in its orbit is 26,900 miles, and the reversing force of gravity in a year is four times greater, or 107,600 miles, and the energy required to melt ice  $142\frac{1}{2} \times 772$  feet = 20 miles, the reversing of its motion by gravity, if converted into heat, would melt the weight of itself of ice 5,380 times a year, and would melt a mass of ice equal to the mass of the sun in 60 years, or in the same time the whole known heat of the sun would. But if the sun's heat is the direct result of this action, the total heat of the sun ought not to be the equivalent of the reversed energy of the earth, but ought to be the equivalent of the whole system; but it is the equivalent of the earth's energy in orbit. We have therefore found what we sought for, and, as usual in such cases, it is not as we expected, and if we had hit it exactly, we would have found ourselves as far as ever from the end of that chain which stretches across infinity. We therefore withdraw our surmises and leave it as it is to the labours of others." The next section treats of "the nature and relations of the chemical elements," the research (?) which has led to the results announced having been undertaken because the atmosphere of the earth mainly consisting of nitrogen the author determined to find out what nitrogen was "with a view of finding the process by which the system is formed." It is probably out of respect for



his reader's feelings that the author does not at once disclose the astounding discovery which is to revolutionise chemical science, but leads the imagination gently up to it—first informing us that he has spent his life in trying to practise the precepts of Newton and Watt—then indulging in a series of disparaging remarks on modern chemical theory, which remarks we may state *en passant*, perfectly bristle with mis-statements. The discovery which we are now approaching is, we are told, the result of an attempt to apply mechanical principles to chemistry—then the author lets us into a *trait* of his personal character, after which comes the *dénouement*. Here it is: "What I claim is the discovery of an element whose weight is 5; it combines directly with nitrogen, and forms fluorine, chlorine, bromine, and iodine; with carbon, and forms oxygen and silicon (*sic.*); and with hydrogen and forms sulphur and lithium." This extraordinary and pantogenic element "is best described as being the opposite of hydrogen," which "opposition constitutes its energy, and this energy constitutes, or rather will constitute the science of chemistry. Its combinations, direct and indirect, with hydrogen, carbon, and nitrogen, form all the other elements except phosphorus." In the new chemistry potassium is "ammonia acid," sodium, "ammonium acid," lithium, and sulphur, "hydrogen acids," &c. We find no evidence in the pamphlet of the method employed in discovering the new element—before listening to Mr. Coutie's vague speculations, chemists will be justified in calling upon him to produce his *Pantogen*, and describe its properties—at present it exists only on paper. We may appropriately conclude this notice with a quotation from Priestley, printed by the author in the preface to the present rhapsody. "For my own part I will frankly acknowledge that at the commencement of the experiments recited in this section, I was so far from having formed any hypothesis that led to the discoveries I made in pursuing them, that they would have appeared very improbable to me had I been told of them." Mr. Coutie lays this missile so very temptingly within our reach, that we may be excused for throwing it at his very fragile fabric.

The author's language does not properly fall into our province, but enough has been quoted to give our readers a fair specimen of its quality;—of Mr. Coutie's science no further criticism is necessary.

R. M.

### LETTERS TO THE EDITOR

[The Editor does not hold himself responsible for opinions expressed by his correspondents. Neither can he undertake to return, or to correspond with the writers of, rejected manuscripts. No notice is taken of anonymous communications.]

#### Theophrastus versus Millington

In a letter in *NATURE*, vol. xiii. pp. 85, 86, Mr. Bennett appears to contend—

1. That if the credit of suggesting the true function of the stamens of flowering plants is to be attributed to either, it belongs to Grew rather than to Millington.

2. But that even the views of the former were not materially in advance of those of Theophrastus.

First, as to a bibliographical matter, Mr. Bennett speaks of a second edition of Grew's book. There is no such thing. The "Anatomy of Plants," 1682, contains four books; the first of these was published in 1671, the second in 1673, the third in 1675. The fourth book, not published till 1682, contains the celebrated passage on the sexuality of plants. This was read before the Royal Society, Oct. 26 [Nov. 9], 1676.

Turning to p. 172, we find Chap. V. "Of the Use of the Attire" (stamens).

In § 1 he alludes to the "Secondary use." This (book i. p. 39) he explains to be the provision of food for animals.

"We must not think that God Almighty hath left any of the whole Family of his Creatures unprovided for; but as the Great Master, some where or other carveth out all; and that for a great number of these little Folk, He hath stored up their

peculiar provisions in the Attires of Flowers; each Flower thus becoming their Lodging and their Dining-Room both in one."

Having given this proper recognition to the pious teleology of the time, he proceeds to remark in § 2 that "the Primary and chief Use of the Attire is such as hath respect to the Plant itself." He infers this very conclusively from the constant occurrence of stamens, even when the more conspicuous parts of the flower are wanting.

Then in the § 3 he tells us how Sir Thomas Millington gave him the clue—

"In discourse hereof [not as Mr. Bennett puts it, but on the nature of the Primary use of the Attire] with our Learned Savilian Professor, Sir Thomas Millington, he told me he conceived, That the Attire doth serve as the male, for the Generation of the seed."

In § 4 he proceeds: "I immediately reply'd, 'That I was of the same opinion; and gave him some reasons for it, and answered some objections, which might oppose them.'"

Surely it is hardly necessary to comment on this charming little history. Grew gets the hint of the true solution from his friend, immediately perceives its importance, and eagerly proceeds to apply it to facts and to explain away apparent difficulties in accepting it. Surely scientific historians can hardly set aside Grew's own modest pleasure in attributing the discovery to Millington.

Next, however, we are told it is no discovery at all. It will be sufficient, in answer to this, to quote from p. 172 a few lines, omitting unnecessary analogies.

"The Globulets [pollen grains] and other small particles . . . in the Thecæ [anther-cells] are as the vegetable spermæ which . . . falls down upon the seed-case [ovary] or womb, and so touches it with a prolifick virtue."

To say that Theophrastus in the fourth century B.C. possessed all the detailed information necessary to come so near the truth as Grew did in this statement, shows a wanton disregard for facts which it is sad to contemplate even though it be a momentary *lapsus* in the case of Mr. Bennett.

As to attributing all the credit in the matter to Camerarius, I cannot do better than appeal to an authority of which no one can question the impartiality.

Sprengel, in his "Historia rei Herbariæ," vol. ii. pp. 14, 15, has the following remarks:—

"Una fere cum Grewio Jacobus Bobartus, horti Oxoniensis præfectus, experimenta cum Lychnide dioica instituit (1681), quæ ovula in capsula obvia hauquaquam secunda esse, dum filamenta apicibus suis seu antheris careant, docuerunt. Id e Sherardi ore accepit Patricius Blair ("Botan. Essays," p. 243). Mox etiam Jo. Raius eandem sententiam, de fecundandi functione antherarum (1686) . . . uberrime et optime defendit. Unde elucet, *quantopere aberrant à veritate*, qui Rud. Jac. Camerarium inventorem credunt, licet plura hic argumenta pro sexuum differentia adduxerit. Cum historia spermat nationum arrogantiam, fatendum etiam est, Anglorum gloriam esse, quod primi tum phytomixtum doctrinæ, quam sexualem dicunt, fundamenta jecerint."

There really is no case for discussion. Everyone is familiar with the fact that a large amount of time, paper, and ink may be wasted in contentions of this kind, and it is to be regretted that Mr. A. W. Bennett should employ his energies in furnishing additional experimental proof on this head. That the writer in *NATURE* and the reviewer of Sachs were each and severally justified in their allusion to Millington is also clear enough.

A. B. C.

#### Estimation of Fractions

THE question of "Personal Equation in the Tabulation of Thermograms," &c., which was recently considered in this journal, is but a portion of the general subject of the estimation of fractions, and the various influencing causes connected with it. Having made some experiments on this matter some time ago, and more fully of late, I subjoin some of the results, as it is a subject on which there seems but little accurately known in general, and which is important in thousands of readings made every day.

The experimental readings were made with appliances varying in each case, but in all cases the whole space or division was perfectly free from any visible marks besides the movable index, as they might bias or help the division; also the reader avoided noticing during each set of readings whether they were mostly + or - the truth, as this would bias the judgment. Moderate sunlight shining on white paper led to more accurate results than

diffuse daylight. Each result stated below is the mean of from ten to fifty readings under fairly favourable circumstances.  $d$  is used for the whole division or space on which the position of the index was estimated; and  $i$  is the inch, which is the unit used throughout.

(1) The first question is the average amount of error made by different persons with regard to the fraction of *division*; in fact, the personal variation of average error. This on a 10-inch space was—

By A	mean error	$d \div 112$
" B	"	$d \div 60$
" C	"	$d \div 50$
" D	"	$d \div 36$
" E	"	$d \div 21$

(2) The average amount of error with regard to the fractions of an *inch* (the *divisions* being too small to see the above fractions of them) were—

By A	on space of $i \div 41$	mean error	$i \div 1890$
" A	"	$i \div 139$	" $i \div 3200$
" C	"	$i \div 41$	" $i \div 1640$

Under the best circumstances and reading with the right eye, A's mean error is only  $i \div 5000$  on the space of  $i \div 139$ ; and as the distance was about six inches, this is  $\frac{1}{1000}$  of the distance; agreeing with the size of the smallest line visible, which is about  $\frac{1}{1000}$  to  $\frac{1}{2000}$  of the distance according to circumstances, but without any *shadow* to the wire examined. As to the observers, A has had practice lately in measuring; B had much practice some years ago; C and E are ladies of artistic tastes but unmetrical; D is moderately accustomed to measuring, but has a difference between the focus of his eyes. It would be highly interesting to have a good collection of statistics on this question, from among surveyors, mechanics, and the unmetrical classes. I proceed to readings for other points, made by A.

(3) The mean errors on spaces of various lengths stand thus:—

10 $i$ space,	mean error	$d \div 112$
1 $i$ "	"	$d \div 89$
( $i \div 41$ "	"	$d \div 70$ read by right eye only)
$i \div 41$ "	"	$\therefore d \div 106$ if read by both eyes.

Thus the size of the division does not seem to much affect the estimation, the extreme difference being 4 : 5. If the angular width of a space exceed  $5^\circ$  it is not so easily grasped by the eye, though the error is not perceptibly increased till it exceeds  $20^\circ$ . The  $i \div 41$  space was read with a magnifier, ( $\times 3$ ), so it was equivalent to  $i \div 14$ .

(4) The relative error of the first guess (or the numerical idea produced instantaneously at the first glance) and the most carefully considered readings stand thus:—

First sight.	Carefully considered.	Ratio.	Distance of observer.
10 $i$ space, $d \div 55$	$d \div 114$	2.1 : 1	110 $i$ or 11d
1 $i$ " $d \div 54$	$d \div 78$	1.4 : 1	18 $i$ " 18d
$i \div 139$ " $d \div 13.6$	$d \div 13$	1 : 1	6 $i$ " 840d

apparently indicating that the first guess is worst where the space is rather too wide angularly to be grasped by the eye at once; and therefore that the want of grasp is the defect corrected by consideration.

(5) The effect of looking at the space askew was tried by viewing it at  $30^\circ$  to either side; shifting sides ten times so as to avoid any gradual change in the quality of the reading, and so as to call up the contrast more strongly. The results of careful readings were:—

	In sum of errors.	
	per cent.	
10 $i$ space to right hand	31	69
10 $i$ " left "	45	55

and it was noticeable that the fraction nearest to the reader was invariably guessed smaller at first sight, than it appeared on careful examination, showing that the tendency to diminish the nearest side which is noticeable in the above percentage of the space to right hand, was still stronger at first, and was corrected by consideration.

So far the results have been independent of differences between the eyes, but it would seem that these are considerable from the following:—

(6) Comparison of the percentage of + and - errors of the two eyes separately; the sum of the amounts of errors being taken, and not the number of errors.

	Right eye.		Left eye.	
	+	-	+	-
1 $i$ space	55	45	58	42
1 $i$ "	75	25	34	66
$i \div 139$ "	92	8	28	72
Mean	73	27	39	61

The elements of this mean, and all others after, are weighted by the number of observations. As in all these readings the zero was to left hand, it would seem that each eye imagines the fraction on its own side smaller than it really is, this being in exact accordance with the effect produced by both eyes viewing the object from one side. See (5).

(7) When both eyes are used together the readings appear to be well balanced on an average:—

	per cent.	
	+	-
10 $i$ space	42	58
1 $i$ "	59	41
Mean	53	47

The variations, however, of different series of readings are as wide as + 80, - 20; and + 20, - 80; this may be partly due to temporary rest of one eye, involuntarily; and to a slightly skew view of the space.

(8) The comparative amount of error of the two eyes stands thus:—

	Right :	Left ::
1 $i$ space	100	109 white light
1 $i$ "	100	120 coloured lights
$i \div 139$ "	100	150 on silver
Mean	100	121

So 5 : 6 is the relative error of the right and left eyes.

(9) The relative errors of each eye separately and of both together are:—

	Right eye.	Left eye.	Mean of both.	Both used together.
1 $i$ space	1.52	1.64	1.59	1.00

So that the advantage of two eyes over one is more than  $\sqrt{2} : 1$ , which it would be, if regarded as the mean of two readings; the excess of 1.59 over  $\sqrt{2}$  may be due to the restraint of keeping one eye shut. The accuracy seems to be about  $\sqrt[14]{}$  the number of eyes.

(10) A most important practical question is that of the influence of colour on the error of estimation. On trying this with coloured glasses the results were most unexpected.

	Relative amount of error.			
	No glass.	Blue.	Green.	Red.
1 $i$ space	1.0	.81	1.06	1.70
1 $i$ "	1.0	1.17	.88	1.23
Mean	1.0	.99	.97	1.46

The two series (each of ten readings with each colour) are given to show how far uniform the results are; they were read on different days, completely reversing the order of the four columns; and they were equally divided between the eyes, five by right and five by left.

I had expected that red would hold about the above relation to white; but that green, and especially blue, would have been worse; the colours were spectrally tolerably pure, except the blue, which contained some yellow. The badness of blue on the second trial in diffuse daylight is accounted for by a want of sufficient light; blue containing such a small proportion of light-rays.

So far I have remarked on those points which are perhaps, or probably, not due to idiosyncrasies; the question of partiality for certain digits is clearly a personal error, as has been demonstrated in NATURE; so it is not worth noting further, as its interest in individual cases is confined to the observer, who should try (being "forewarned") to be "forearmed," and so allow for it in reading; of course a series of statistics on it would have much interest.

(11) One point, however, which is probably alike in all is the relative amount of error in different parts of a scale; the mean I find to be thus:—

0 to 1	1 to 2	2 to 3	3 to 4	4 to 5	5 to 6	6 to 7	7 to 8	8 to 9	9 to 10
.65	1.53	1.36	1.52	1.47	1.54	2.2	1.30	1.09	1.14
-	+	-	+	+	+	+	-	-	-

The + and - below show the mean error in that digit to exceed or fall short of the mean of all (1.44). The readings are on a 1-inch space. Thus it is apparent that the errors exceed the mean in the four middle digits, and fall short of it in the others with but one exception.

Now, the practical results which may be deduced from these data are as follows:—

From (1), that there is considerable variation in accuracy of estimation; yet, in persons fit to estimate, it may be put at  $d \div 50$  up to  $d \div 100$ ; and therefore as the maximum error in some hundreds of readings is only about three times the average error, it is useless (and, worse than that, confusing) to have divisions smaller than  $20 \times$  the quantity required to be read. The application of this result to surveyors' rods, &c., would be very conducive to ease in distant reading.

From (2), that for ordinary eyes about  $i \div 2000$  is the mean error of reading (with one eye only), and therefore that  $i \frac{2}{3} \frac{5}{8} \frac{7}{8}$  is the smallest size useful for reading with the naked eye; consequently any closer divisions than these ( $\frac{1}{8}$  of an inch) are detrimental because of the greater confusion they introduce.

From (4), that in small divisions no consideration is necessary, as the first instinctive impression is nearly, or quite, as accurate as careful estimation.

From (5), that it is important not to look at a space askew; and that if unavoidable, careful consideration is desirable.

From (6), that in reading a series of observations of one amount, the right and left eyes should be used alternately to equalise the + and - errors.

From (8), that the right eye should be used in preference to the left.

From (9), that both eyes should be used wherever possible.

From (10), that red is the worst colour for measures, and that green or blue are as good as white; so that blue and white would probably be the best practically, and more distinct from vegetation, &c., than the green at a distance.

From (11), that more care is required in readings in the central portions of a space than at the ends. This is as true on spaces of  $i \div 41$  as on  $10i$  spaces.

Of course some of these results may be *personal errors*, and not generally true, but at least this notice will perhaps call the attention of those accustomed to estimation to the subject, and so elicit some definite statistics. There are many other interesting questions which I have not touched on here as being of less consequence, and not affecting practical questions so much as the foregoing results; these results it is to be hoped may lead to a better acquaintance with a subject of such practical importance.

W. M. FLINDERS PETRIE

Bromley, Kent

#### The late Dr. von Willemoes-Suhm

IN the list of papers given in Prof. Wyville Thomson's obituary of the late Dr. von Willemoes-Suhm (*NATURE*, vol. xiii., p. 88), is omitted—"Notes on some young stages of Umbellularia, and on its Geographical Distribution;" ("Ann. and Mag. Nat. Hist.," 4th ser., vol. xv., p. 312, and pl. xviii. A.) This animal is a Pennatulid, and was obtained during the *Challenger's* cruise at depths from 1,375 to 2,600 fathoms. It is usually associated with decidedly deep-sea forms.

To this may be added two papers which were read at the meeting of the Royal Society on Dec. 9th, "On the Development of *Lepas Fascicularis*, and the '*Archizoia*' of Cirripedia;" and "Preliminary Remarks on the Development of some Pelagic Decapoda." J. C. G.

#### Seasonal Order of Colour in Flowers

I HAVE often noticed during spring and summer that flowers appear to follow the spectrum from the blue of the wild hyacinth to the deep scarlet of our summer flowers. Will any of your correspondents tell me if during spring the actinic rays of the sun are in greater force, and whether these chemical rays are those which revivify seeds and plants after their winter's hibernation? During autumn I have noticed the same gradations in the colours of flowers.

C. E. HERON ROGERS

Retford, Notts, Dec. 7

#### OUR ASTRONOMICAL COLUMN

ATLAS PLEIADUM,  $\Sigma$  453.—Has anyone provided with a large telescope examined this object of late for duplicity? It appears very improbable that Struve's epoch of

1827 can have been put upon record through an illusion. We find in "Mensurae Micrometricae," p. 2:—

1827.16 Position  $107^{\circ}8$  Distance  $0''.79$  Mag. 5 and 8.

It is then termed "duplex difficillima." On subsequent examination, 1830.25, the position was found to be  $29^{\circ}2$ , and the distance only  $0''.35$ . In 1831 and 1832 it was not seen double with the Dorpat refractor under a power of 600. Struve remarks, "si justa est anni 1827 notatio, quod vix dubitare potest, cum nullum observans dubium expresserim, motus in hoc systemate egregie celer inesse debet." From 1840 to 1847, Mädler observing with the same instrument, says he always found the star "quite round," and to our knowledge a few years since the star was pronounced single after close scrutiny with more than one of the larger telescopes.

THE "GEGENSCHHEIN" OF THE ZODIACAL LIGHT.—The last number of the "Monthly Notices of the Royal Astronomical Society" contains some interesting remarks by Mr. Backhouse, of Sunderland, bearing upon this phenomenon of the zodiacal light, as observed by him between the years 1871 and 1875, which are the more notable, as the observer does not appear to have been aware of its previous observation, and consequently the particulars he has placed upon record afford a very satisfactory confirmation of the existence of this feature of the light. The "gegenschhein" consists in an elliptical patch of light almost directly opposite the sun's place, with the greater axis nearly in the plane of the ecliptic. Attention was first directed to it in the year 1854 by Herr Brorsen (the discoverer of the comet of short-period—February 1846)—while observing at Senftenberg in Bohemia. It may be inferred that it is generally difficult to distinguish or trace, with certainty, as even Prof. Heis, of Münster, with his excellent vision and long practice, did not succeed in verifying Brorsen's observations for several years (*Zodiacallicht-Beobachtungen*, Heis, 1875). Observations of the phenomenon will be found in various numbers of the "Astronomische Nachrichten." Brorsen thought this opposition-glow of the zodiacal light was more distinctly seen near the vernal than the autumnal equinox; the observations of Heis are in January, April, and in December. There are also observations by Schmidt at Athens, Schiaparelli at Milan, &c.

THE COMET OF 1729.—This very remarkable body presented a case which is quite unique in the history of these interesting denizens of the solar system. It was visible without telescopic aid, or with little optical assistance, at distances from the earth and sun not greatly inferior to those to which any other comet has been followed even with such an instrument as the Poulkova refractor, and it may be inferred was of very different constitution.

The comet was first detected by Sarabat, an ecclesiastic of the Jesuit order, at Nismes, on the 31st of July; the moonlight, which was then on the increase, prevented his seeing it on the following evenings until Aug. 8, when the moon being totally eclipsed, he recovered the comet and gave intimation of his discovery to Cassini at Paris, by whom it was observed on forty-four nights between Aug. 31 and Jan. 18 following. Cassini saw the comet without fixing its position until the end of the same month. While it was visible with difficulty to the naked eye, in a 16-foot telescope it appeared "en forme d'une petite étoile nébuleuse avec une chevelure autour d'elle, dont l'étendue paraissait au moins aussi grande que le diamètre de Jupiter, vu avec une pareille lunette." This is about the extent of our information relating to the aspect of the comet.

The best orbits are those of Burckhardt (hyperbola and parabola), published in the "Connaissance des Temps" for 1821. If we employ the parabolic elements we find the following distances of the comet from the sun and earth expressed in units of the earth's mean distance from the sun:—

12h G.M.T.	Distance from Sun.	Distance from Earth.
1729, July 31 ... ..	4'065 ... ..	3'121
" Aug. 8 ... ..	4'072 ... ..	3'134
1730, Jan. 18 ... ..	4'452 ... ..	5'152
" " 31 ... ..	4'499 ... ..	5'225

For comparison with these distances take the case of the great comet of 1861, which was observed by Mr. Otto Struve at Poulkova till 1862, May 1, when its distance from the sun was 4'46, and from the earth 4'70; or that of Mauvais's comet of 1847, followed by Bond with the great refractor at Cambridge, U.S., till 1848, April 21, and then distant from the sun 3'85, and from the earth 4'40; or again, the case of the celebrated comet of 1811, last seen by Wisniewsky at Novo-Tcherkask, 1812, August 17, when the radius-vector was 4'54, and the distance from the earth 3'50.

#### RÜTIMEYER ON TRACES OF MAN RECENTLY DISCOVERED IN THE INTERGLACIAL COAL-BEDS OF SWITZERLAND

THE last number of the *Archiv für Anthropologie* contains a short but important article by the eminent zoologist of Basle, Prof. Rütimyer, on some traces of man recently discovered in the interglacial coal-bed at Wetzikon. Escher von der Linth first called attention to the fact that at several places in East Switzerland, especially on the eastern shore of Lake Zurich from Wetzikon to Utznach, and again in the neighbourhood of the Lake of Constance, there are beds of coal, which are not only covered by, but which also repose on, well-marked glacial deposits, thus clearly proving the existence of more than one period of extreme cold, as first remarked by Morlot, and since confirmed by many observers, and especially by Geikie.

These interglacial coal-beds contain numerous remains of plants and animals, among the most interesting being those of *Elephas antiquus* and *Rhinoceros merkkii*. The remains of plants are indeed so numerous that Dr. Scheuermann, of Basle, has been in the habit of breaking up himself all the coal used as fuel in his house, in search of vegetable remains. In doing so he was struck on one occasion by observing a number of pointed rods lying side by side, and he placed the block of coal containing them in the hands of Prof. Rütimyer.

Prof. Rütimyer has now given a description and figures of these rods, from which it is clear that they have been intentionally pointed, and that they formed a portion of rough basket or wattle work. They are four in number, and are closely embedded in the coal, which they precisely resemble in colour, while the texture is that of the ordinary wood found in these coal-beds. Moreover, as is usual in such cases, the stem has been compressed, so that the section is not circular but oval. According to Prof. Schwendener, the wood is that of *Abies excelsa*. The points bear evident traces of cutting, while at one part of the rods are marks as if of a string wound round and round them. Here, then, we appear to have clear evidence of the existence of man during one of the warm intervals of the glacial epoch. J. L.

#### THE THEORY OF "STREAM LINES" IN RELATION TO THE RESISTANCE OF SHIPS \*

##### III.

In this treatment of the propositions concerning the flow of fluid through pipes, I have at length laid the necessary foundation for the treatment of the case of the flow of an infinite ocean past a submerged body. I have shown these propositions to be based on principles which are undeniable, and the conclusions

\* Address to the Mechanical Section of the British Association, Bristol, August 25, 1875; by William Froude, C.E., M.A., F.R.S. President of the Section. Revised and extended by the author. Continued from p. 93.

from which, when in any way startling or paradoxical, you have seen confirmed by actual experiment.

I have dealt with the case of a single stream of uniform sectional area (and therefore of uniform velocity of flow) enclosed in a pipe of any path whatever; I have dealt with the case of a single stream of very gradually varying sectional area and velocity of flow; and I have dealt with the case of a combination (or faggot, as it were) of such streams, each to some extent curved and to some extent varying in sectional area, together composing the whole content of a pipe or passage having enlargements or contractions in its course; and in all these cases I have shown that, provided the streams or pipe-contents finally return to their original path and their original velocity of flow, they administer no total endways force to the pipe or channel which causes their deviations.

I am now going to deal with a similar combination of such streams, which, when taken together, similarly constitute an infinitely extended ocean, flowing steadily past a stationary submerged body; and here also I shall show that the combination of curved streams surrounding the body, which together constitute the ocean flowing past it, return finally to their original direction and velocity, and cannot administer to the body any endways force.

The argument in this case is, in reality, precisely the same as that in the case of the contractions and enlargements in pipes which I have already dealt with; for, in fact, the flow of the ocean past the stationary submerged body is only a more general case of the flow of fluid through a contracted pipe; but, though the cases are really the same, there is considerable difference in their appearance; and therefore I will proceed to point out how the arguments I have already used apply equally to this case.

Every particle of the fluid composing the ocean that passes the body must undoubtedly follow some path or other, though we may not be able to find out what path; and every particle so passing is preceded and followed by a continuous stream of particles all following the same path, whatever that may be. We may, then, in imagination, divide the ocean into streams of any size and of any cross-section we please, provided they fit into one another, so as to occupy the whole space, and provided the boundaries which separate the streams exactly follow the natural courses of the particles.

I before suggested a similar conception of the constitution of the ocean flowing past the stationary body, and there pointed out that the streams forming this system must not only be curved in order to get out of the way of the body, but might each require to have to some extent a different sectional area, and therefore a different velocity of flow at different points of their course. If we trace the streams to a sufficient distance ahead of the body, we shall there find the ocean flowing steadily on, completely undisturbed by, and as we may say ignorant of, the existence of the body which it will ultimately have to pass. There, all the streams must have the same direction, the same velocity of flow, and the same pressure. Again, if we pursue their course backwards to a sufficient distance behind the body, we shall find them all again flowing in their original direction; they will also have all resumed their original velocity; for otherwise, since the velocity of the ocean as a whole cannot have changed, we should have a number of parallel streams having different velocities and therefore different pressures side by side with one another, which is an impossible state of things.\*

Although, in order to get past the body, these streams follow some courses or other, various both in direction and velocity, into which courses they settle themselves in virtue of the various reactions which they exert upon one another and upon the surface of the body, yet ultimately, and through the operation of the same causes, they settle themselves into their original direction and original velocity. Now the sole cause of the original departure of each and all of these streams from, and of their ultimate return to, their original direction and velocity, is the submerged stationary body; consequently the body must receive the sum total of the forces necessary to thus affect them. Conversely this sum total of force is the only force which the passage of the fluid is capable of administering to the body. But we know that to cause a single stream, and therefore also to cause any combination or system of streams, to follow any courses

\* In an imperfect fluid it is possible to have parallel streams having different velocities and the same pressures side by side with one another, because, in an imperfect fluid, change of velocity may have been communicated by friction instead of by difference of pressure.

changing at various points both in direction and velocity, requires the application of forces the sum total of which in a longitudinal direction is zero, as long as the end of each stream has the same direction and velocity as the beginning. Therefore the sum total of forces (in other words the only force) brought to bear upon the body by the motion of the fluid in the direction of its flow, is zero.\*

I have now shown how it is that an infinite ocean of perfect fluid flowing past a stationary body cannot administer to it any endways force, whatever be the nature of the consequent deviations of the streams of fluid. The question, what will be in any given case the precise configuration of those deviations, is irrele-

vant to the proof I have given of this proposition. Nevertheless it is interesting to know something, at least, of the general character which these deviations, or "stream-lines," assume in simple cases; therefore I have exhibited some in Figs. 26, 27, which are drawn according to the method explained by the late Prof. Rankine.

The longitudinal lines represent paths along which particles flow; they may therefore be regarded as boundaries of the streams into which we imagined the ocean to be divided.

We see that, as the streams approach the body, their first act is to broaden, and consequently to lose velocity, and therefore, as we know, to increase in quasi-hydrostatic pressure. Presently

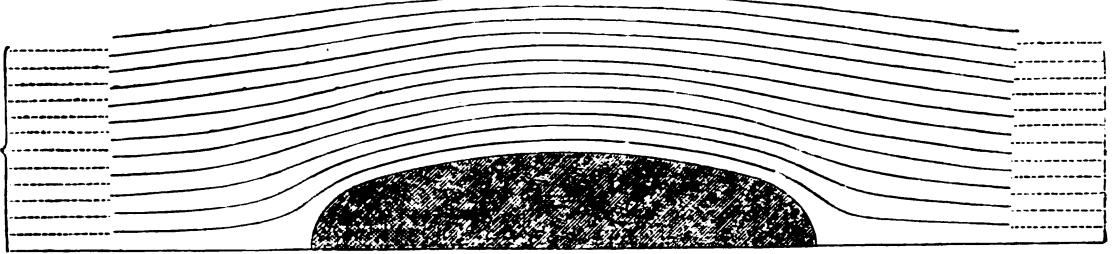

FIG. 26.

they again begin to narrow, and therefore quicken, and diminish in pressure, until they pass the middle of the body, by which time they have become narrower than in their original undisturbed condition, and consequently have a greater velocity and less pressure than the undisturbed fluid. After passing the middle they broaden again until they become broader than in their original condition, and therefore have less velocity and greater pressure than the undisturbed fluid. Finally, as they recede from the body they narrow again until they ultimately resume their original dimension, velocity, and pressure.

Thus, taking the pressure of the surrounding undisturbed fluid as a standard, we have an excess of pressure at both the head and stern ends of the body, and a defect of pressure along the middle.

We proved just now that, taken as a whole, the fluid pressures could exert no endways push upon the stationary body. We now see something of the way in which the separate pressures act, and that they do not, as seems at first sight natural to expect, tend all in the direction in which the fluid is flowing; on the contrary, pressure is opposed to pressure, and suction to

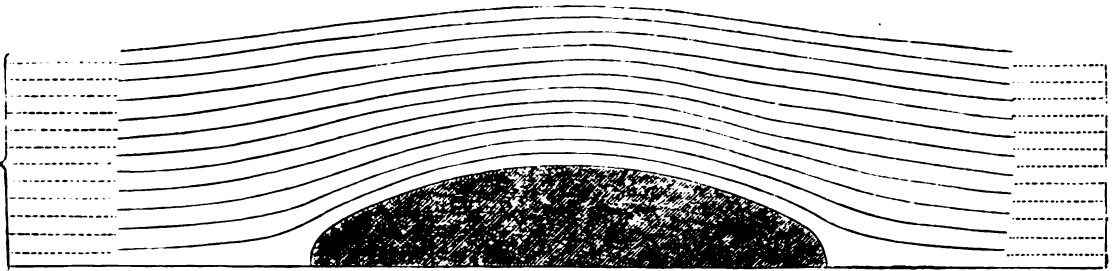

FIG. 27.

suction, and the forces neutralise one another and come to nothing, and thus it is that an ocean of perfect fluid flowing at steady speed past a stationary submerged body does not tend to push it in the direction of the flow. This being so, a submerged body travelling at steady speed through a stationary ocean of perfect fluid will experience no resistance.

We will now consider what will be the result of substituting an ocean of water for the ocean of perfect fluid.

The difference between the behaviour of water, and that of the theoretically perfect fluid is twofold, as follows:—

First. The particles of water, unlike those of a perfect fluid, exert a drag or frictional resistance upon the surface of the body as they glide along it. This action is commonly termed surface-friction, or skin-friction; and it is so well-known a cause of resistance that I need not say anything further on this point, except this, that it constitutes almost the whole of the resistance experienced by bodies of tolerably easy shape travelling under water at any reasonable speed.

Secondly. The mutual frictional resistance experienced by the particles of water in moving past one another, combined with

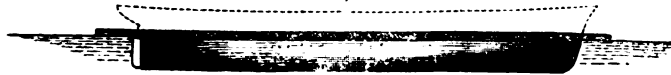

FIG. 28.

the almost imperceptible degree of viscosity which water possesses, somewhat hinders the necessary stream-line motions, alters their nice adjustment of pressures and velocities, and thus defeats the balance of stream-line forces and induces resistance. This action, however, is imperceptible in forms of fairly easy shape. On the other hand, angular or very blunt features entail considerable resistance from this cause, because the stream-line distortions are in such cases abrupt, and degenerate into eddies, thus causing great differences of velocity between adjacent particles of water, and great consequent friction between them.

\* See Supplementary Note C.

"Dead water," in the wake of a ship with a full run, is an instance of this detrimental action.

So far we have dealt with submerged bodies only; we will now take the case of a ship travelling at the surface of the water. But first, let us suppose the surface of the water to be covered with a sheet of rigid ice, and the ship cut off level with her water-line, so as to travel beneath the ice, floating, however, exactly in the same position as before (see Fig. 28). As the ship travels along, the stream-line motions will be the same as for a submerged body, of which the ship may be regarded as the lower half; and the ship will move without resistance, except that due

to the two causes I have just spoken of, namely surface-friction and mutual friction of the particles. The stream-line motions being the same in character as those we have been considering, we shall still have at each end an excess of pressure which will tend to force up the sheet of ice, and along the side we shall have defect of pressure tending to suck down the sheet of ice. If, now, we remove the ice, the water will obviously rise in level at each end, so that excess of hydrostatic head may afford the necessary reaction against the excess of pressure; and the water will sink by the sides, so that defect of hydrostatic head may afford reaction against the defect of pressure.

The hills and valleys thus formed in the water are, in a sense, waves; and, though originated in the stream-line forces of the body, yet when originated they come under the dominion of the ordinary laws of wave-motion, and, to a large extent, behave as independent waves.

The consequences which result from this necessity are most intricate; but the final upshot of all the different actions which take place is plainly this—that the ship in its passage along the surface of the water has to be continually supplying the waste of an attendant system of waves, which, from the nature of their constitution as independent waves, are continually diffusing and transmitting themselves into the surrounding water, or, where they form what is called broken water, crumbling away into froth. Now, waves represent energy, or work done; and therefore all the energy represented by the waves wasted from the system attending the ship, is so much work done by the propellers or tow-ropes which are urging the ship. So much wave-energy wasted per mile of travel is so much work done per mile; and so much work done per mile is so much resistance.

The actions involved in this cause of resistance, which is sometimes termed "Wave-Genesis," are so complicated that no extensive theoretical treatment of the subject can be usefully attempted. All that can be known about the subject must, for the present, I believe, be sought by direct experiment.

Having thus briefly described the several elements of a ship's resistance, I will proceed to draw your attention more particularly to certain resulting considerations of practical importance. Do not, however, suppose that I shall venture on dictating to shipbuilders what sort of ships they ought to build: I have so little experience of the practical requirements of shipowners, that it would be presumptuous in me to do so; and I could not venture to condemn any feature in a ship as a mistake, when, for all I know, it may be justified by some practical object of which I am ignorant. For these reasons, if I imply that some particular element of form is better than some other, it will be with the simple object of illustrating the application of principles, by following which it would be possible to design a ship of given displacement, to go at given speed, with minimum resistance, in smooth water—in fact, to make the best performance in a "measured mile" trial.

I have pointed out that the causes of resistance to the motion of a ship through the water are: first, surface-friction; secondly, mutual friction of the particles of water (and this is only practically felt when there are features sufficiently abrupt to cause eddies); and thirdly, wave-genesis. I have also shown that these are the *only* causes of resistance. I have shown that a submerged body, such as a fish, or torpedo, travelling in a perfect fluid, would experience no resistance at all; that in water it experiences practically no resistance but that due to surface-friction and the action of eddies; and that a ship at the surface experiences no resistance in addition to that due to these two causes, except that due to the waves she makes. I have done my best to make this clear: but there is an idea that there exists a kind of resistance, a something expressed by the term "direct head-resistance," which is independent of the above-mentioned causes. This idea is so largely prevalent, of such long standing, and at first sight so plausible, that I am anxious not to leave any misunderstanding on the point.

Lest, then, I should not have made my meaning sufficiently clear, I say distinctly, that the notion of head-resistance, in any ordinary sense of the word, or the notion of any opposing force due to the inertia of the water on the area of the ship's way, a force acting upon and measured by the area of midship section, is, from beginning to end, an entire delusion. No such force acts at all, or can act; as throughout the greater part of this address I have been endeavouring to explain. No doubt, if two ships are of precisely similar design, the area of midship section may be used as a measure of the resistance, because it is a measure of the size of the ship; and if the ships were similar in

every respect, so also would the length of the bowsprit, or the height of the mast, be a measure of resistance, and for just the same reason. But it is an utter mistake to suppose that any part of a ship's resistance is a direct effect of the inertia of the water which has to be displaced from the area of the ship's way. Indirectly the inertia causes resistance to a ship at the surface, because the pressures due to it make waves. But to a submerged body, or to the submerged portion of a ship travelling beneath rigid ice, no resistance whatever will, be caused by the inertia of the water which is pushed aside. And this means that, if we compare two such submerged bodies, or two such submerged portions of ships travelling beneath the ice, as long as they are both of sufficiently easy shape not to cause eddies, the one which will make the least resistance is the one which has the least skin surface, though it have twice or thrice the area of midship section of the other.

The resistance of a ship, then, practically consists of three items—namely, surface-friction, eddy-resistance, and wave-resistance.

Of these the first-named is, at least in the case of large ships, much the largest item. In the *Greyhound*, a bluff ship of 1,100 tons, only 170 feet long, and having a thick stem and sternposts, thus making considerable eddy-resistance, and at ten knots visibly making large waves, the surface-friction was 58 per cent. of the whole resistance at that speed; and there can be no doubt that with the long iron ships now built, it must be a far greater proportion than that. Moreover the *Greyhound* was a coppered ship; and most of the work of our iron ships has to be done when they are rather foul, which necessarily increases the relative importance of the surface-friction item.

The second item of resistance, namely the formation of eddies, is, I believe, imperceptible in ships as finely formed as most modern iron steamships. Thick square-shaped stems and sternposts, more especially the latter, are the most fruitful source of this kind of resistance.

The third item is wave-resistance. To this alone of the three is the stream-line theory directly relevant, and here, as we have seen, it rather suggests tendencies, than supplies quantitative results, because, though it indicates the nature of the forces in which the waves originate, the laws of such wave-combinations are so very intricate, that they do not enable us to predict what waves will actually be formed under any given conditions.

There are, however, some rules, I will not call them principles, which have to some extent been confirmed by experiment. At a speed dependent on her length and form, a ship makes a very large wave-resistance. At a speed not much lower than this, the wave-resistance is considerably less, and at low speeds it is insignificant. Lengthening the entrance and run of a ship tends to decrease the wave-resistance; and it is better to have no parallel middle body, but to devote the entire length of the ship to the entrance and run, though in this case it be necessary to increase the midship section in order to get the same displacement in a given length.

With a ship thus formed, with fair water-lines from end to end, the speed at which wave-resistance is accumulating most rapidly, is the speed of an ocean-wave the length of which, from crest to crest, is about that of the ship from end to end.

I have said we may practically dismiss the item of eddy-resistance. The problem, then, to be solved in designing a ship of any given size, to go at a given speed with the least resistance, is to so form and proportion the ship that at the given speed the two main causes of resistance, namely surface-friction and wave-resistance, when added together, may be a minimum.

In order to reduce wave-resistance we should make the ship very long. On the other hand, to reduce the surface-friction we should make her comparatively short, so as to diminish the area of wetted skin. Thus, as commonly happens in such problems, we are endeavouring to reconcile conflicting methods of improvement; and to work out the problem in any given case, we require to know actual quantities. We have sufficient general data from which the skin resistance can be determined by simple calculation; but the data for determining wave-resistance must be obtained by direct experiments upon different forms to ascertain its value for each form. Such experiments should be directed to determine the wave-resistance of all varieties of water-line, cross section, and proportion of length, breadth, and depth, so as to give the comparative results of different forms as well as the absolute result for each.

An exhaustive series of such experiments could not be tried with full-sized ships; but I trust that the experiments I am now



carrying out with models, for the Admiralty, are gradually accumulating the data required on this branch of the subject.

I wish in conclusion to insist again, with the greatest urgency, on the hopeless futility of any attempt to theorise on goodness of form in ships, except under the strong and entirely new light which the doctrine of stream-lines throws on it.

It is, I repeat, a simple fact that the whole framework of thought by which the search for improved forms is commonly directed, consists of ideas which, if the doctrine of stream-lines is true, are absolutely delusive and misleading. And real improvements are not seldom attributed to the guidance of those very ideas which I am characterising as delusive, while in reality they are the fruit of painstaking, but incorrectly rationalised, experience.

I am but insisting on views which the highest mathematicians of the day have established irrefutably; and my work has been to appreciate and adapt these views when presented to me.\*

No one is more alive than myself to the plausibility of the unsound views against which I am contending; but it is for the very reason that they are so plausible that it is necessary to protest against them so earnestly; and I hope that in protesting thus, I shall not be regarded as dogmatic.

In truth, it is a protest of scepticism, not of dogmatism; for I do not profess to direct anyone how to find his way straight to the form of least resistance. For the present we can but feel our way cautiously towards it by careful trials, using only the improved ideas which the stream-line theory supplies, as safeguards against attributing this or that result to irrelevant or, rather, non-existing causes.

(To be continued.)

### THE CHANNEL TUNNEL—SUBMARINE EXPLORATIONS†

AN important Report in connection with the proposed Channel Tunnel has just been issued by the French Submarine Railway Association, giving the results of a detailed examination of the French coast, and of soundings taken in the bed of the Channel during the past autumn. The subject has on previous occasions been referred to in the pages of this Journal; ‡ but before giving an account of the recent explorations it may be well briefly to refer to what has already been done.

A tunnel under the Channel has long been talked of, and many schemes have been brought forward; but the only one which has been received with general favour is that of Sir J. Hawkshaw, who proposes to carry the tunnel from the South Foreland to near Sangatte. In 1864 Mr. E. C. H. Day was employed by Sir J. Hawkshaw to make a geological survey of the neighbouring coasts with the view of obtaining some guide as to the probable outcrops beneath the Channel; the map thus produced was published with the early statements of the Company. In 1866 borings were made on both coasts to prove the succession of the strata at points near which the tunnel was to leave the shores; that on the shore at St. Margaret's Bay traversed 240 feet of upper chalk and 296 feet of lower chalk, and was stopped in the gault at a depth of 567 feet from the surface. The boring on the French coast was put down a little north of Sangatte; it passed through 70 feet of drift-sand, &c., 190 feet of chalk with flints, 284 feet of chalk without flints, and was stopped at a depth of 551 feet from the surface owing to an accident to the hole. This boring, therefore, did not reach the Upper Greensand, and the depth to this bed was estimated from information obtained in the deep boring at Calais. This accident was unfortunate, because, owing to a misreading of the accounts of the Calais

\* I cannot pretend to frame a list of the many eminent mathematicians who originated or perfected the stream-line theory; but I must name, from amongst them, Prof. Rankine, Sir William Thomson, and Prof. Stokes, in order to express my personal indebtedness to them for information and explanations, to which chiefly (however imperfectly utilised) I owe such elementary knowledge of the subject as alone I possess.

† *Chemin de Fer Sous-Marin entre la France et l'Angleterre. Rapports sur les Sondages exécutés dans le Pas de Calais en 1875.* Fol., Paris, 1875.

‡ Vol. i. pp. 160, 303, 631. Prof. Hébert made a communication to the meeting of the British Association at Bristol, on the folds likely to occur beneath the Channel. (See NATURE, vol. xii. p. 407.)

boring, I believe that the thickness of the lower chalk was considerably over-estimated at Sangatte.

At a later date soundings were taken along the line of the proposed tunnel, and at varying distances to the south-west of that line; the instrument used penetrated the bottom for a few inches, and brought up specimens of the ocean floor. The larger number of these were from the superficial covering (sand, &c.), but many brought up pure chalk, and several specimens of gault were obtained near the English coast. This examination was not detailed enough to test very severely the geological map; but so far as the information went it tended to confirm the previous surveys; the only difference then observed was that the gault appeared to run rather further north towards Dover than would have been expected. But it may be doubtful whether such small borings always give trustworthy evidence on this point. The lowest beds of chalk are very clayey, and when thoroughly saturated with water are often quite dark and bluish in colour. In fact, these lowest beds, when freshly exposed in railway cuttings, have been at first mistaken for gault by good observers.

No further explorations have been made till the present year. The concession to the Company was voted by the National Assembly on the 2nd of August, and was signed by Marshal MacMahon on the 5th of the same month. Anticipating the result of the vote the Company commenced work in July. By means of a steamer, soundings were taken on the bed of the Channel. A tube was fixed at the bottom of the sounding-lead, by means of which specimens were brought up. Various appliances were used, but tubes of from 20 to 22 millimètres in diameter, and 15 to 20 centimètres long were found to give the best results. The number of soundings taken per day varied according to circumstances; it averaged 70 or 80, but sometimes reached 100.

The Commission entrusted with the explorations was presided over by M. Lavalley, and consisted of MM. Delesse, Potier, and Lapparent as geologist, and M. Larousse as hydrographer. The position of the boat was at each observation carefully determined by bearings on landmarks. Every specimen collected was marked and sent to Paris for future determination and reference. In all 1,522 soundings were made; 753 specimens of the bottom were obtained, of which 335 have been determined with certainty.

The results show that the outcrop of the gault makes a bend to the north just off the French coast. The Commission carefully tested this district by divers (the water being shallow), and they believe that this bend is due to an anticlinal fold of the strata, and not to a fault; the dip of the beds probably not exceeding 10°. From the French waters across the Channel as far as the observations went (to within about five miles of the English coast), the beds run with great regularity. Supposing the observations to be trustworthy, there cannot be a transverse fault of any magnitude along this line. But the outcrop of the gault lies further to the south than was expected; in fact, it is striking direct for Folkestone church. As before remarked, the earlier observations showed the gault near the English shore to run a little further to the north than was expected; so that here there must either be a roll of the beds or a fault with a downthrow to the south-east.\* The engineers point out the importance of following up this inquiry, and doubtless it will be done as early as possible next year.

No one has expected to tunnel through twenty miles of chalk without meeting with a fault, and therefore the possibility of encountering one near the English shore need cause no uneasiness. It may give no extra trouble, or yield no more water than the rest of the work. Faults are often cut in coal workings under the sea, but they do

\* Mr. G. H. Kinahan, writing to me last year, expressed his belief in the existence of a considerable fault in the Channel, with a downthrow to the south-east.

not cause any uneasiness or extra expense on this account. For the rest the explorations are highly satisfactory, and the extension southwards of the gault is no disadvantage.

Besides the outcrop of the "craie glauconieuse," which almost corresponds to the outcrop of the gault, the engineers profess to have determined the line between the "craie de Rouen," or lower chalk, and a nodular bed which lies above it. One cannot help feeling doubts as to the possibility of this being done, with any degree of certainty, by the means at their disposal. It is, however, important to fix if possible the breadth of outcrop of one of the beds; because, the thickness being known, we can thus estimate the dip. The soundings, as interpreted by the Commission, show that the dip is greatest near the French coast, and that it gets gradually less towards the English coast. Borings at and near Calais show that the dip there lessens towards the north, and by analogy it may be inferred that towards the proposed tunnel the beds under the sea will also lessen in dip.

It is proposed to continue the soundings further north, with the view of fixing exactly the outcrops of the higher beds of chalk. As the report states, if these attempts are successful we shall know exactly, and not by hypothesis, the geological structure of the strait. We shall know too the geological structure of the bed of the sea better than we now know that of much of the dry land; for no geologist has attempted to trace out all the chalk divisions on either coast; they have been measured in the cliffs, but not mapped in detail inland.

The Commission recommends that a new and larger borehole be put down at Sangatte with the view of testing the water-bearing qualities of the chalk at different levels, and of proving the exact thickness of the chalk. It is proposed to carry the hole through the gault and into the Palæozoic rocks, with the view of testing whether these rocks are absorbent, and capable of carrying off water from the tunnel. The possibility that they may serve this purpose has been suggested by the present writer.\* The Commission proposes to test the point, but observes that it is unlikely to be the case. The Palæozoic rocks yield water near Lille, though they have not done so at Calais and Harwich; this may be because the old rocks are only slightly permeable, and if so they will be only slightly absorbent. It was on this ground that Prof. Prestwich proposed to tunnel through the Palæozoic rocks.

The Commission has examined in great detail the chalk of the French cliffs, and the results of their observations are drawn in a section in this Report. W. Phillips in 1819 published a description of the cliffs on each side of the Channel. So far as his observations go they are exact, and need no correction; later observers having only worked out the beds in greater detail. The Report refers in terms of well-merited praise to this early work of Phillips, but it is slightly in error in stating that English geologists have done nothing since his time. The Geological Survey has been over the ground; the maps are published, and descriptions have been given by Mr. Whitaker. Mr. Dowker has also studied the higher chalk of Kent.

The Report contains a large chart showing the positions of all the soundings, and is further illustrated by sections and diagrams in the text. It is one of the most valuable publications which has yet appeared on this important subject, and is well worthy of the reputation of its distinguished authors.

W. TOPLEY

#### NOTES

IT is with great regret that we hear of the death of Mr. R. C. Carrington, F.R.S., whose name is so intimately associated with solar observation, which indeed he was the first to start in this country. His failing health of late years, was no doubt due to his unceasing assiduity. For seven and a quarter

\* Quart. Journ. Science, April 1872.

years scarcely a single day passed that Mr. Carrington did not make an observation on sun-spots. The book which contains these observations, published by Williams and Norgate, partly at the expense of the Royal Society, is one of the astronomical works of which England has good cause to be proud. Up to his death Mr. Carrington was engaged in designing and planning instruments of more than curious construction, which he intended eventually to fit up in his observatory. Before he took up sun-spot observations he constructed charts and a catalogue of the circumpolar stars, into which he introduced the most minute accuracy. The "Redhill Catalogue" will long be consulted by the practical astronomer.

AT the meeting of the Royal Society on Thursday last, the following Fellows were appointed Vice-Presidents of the Society for the ensuing year:—Mr. William Spottiswoode, M.A.; Prof. J. Couch Adams, LL.D.; Captain F. J. O. Evans, R.N.; Dr. A. C. Günther, M.A., and Dr. William Pole, C.E.

COUNT SALVADORI, of the Royal Museum of Turin, has recently described in the "Annals of the Civic Museum of Natural History of Genoa," a large new rapacious bird, discovered by the naturalist D'Albertis in New Guinea, which he proposes to call *Harpypsopsis novæ Guinææ*. The existence of this bird probably gave rise to the exaggerated report of the enormous "eagles" which were seen during the voyage up an unexplored river in New Guinea, recently published in the *Daily News* (NATURE, vol. xiii., p. 76.)

AT Monday's meeting of the Royal Geographical Society the paper read was by Mr. Octavius Stone, on the discovery of the Mai-Kassa or Baxter River, New Guinea. Mr. Stone sailed up the river in the missionary vessel *Ellangowan*, and the account given is essentially the same as that which has already appeared in our journal, though Mr. Stone seems to make no mention of the monstrous bird referred to by Mr. Smithurst (vol. xiii., p. 76.) At the furthest point reached (about 100 miles from the mouth) the Mai-Kassa was ten yards wide, although the depth was still two fathoms. Even so far in the interior it is influenced by four half-tides daily, as when the first waters meet the sea a rebound is caused, so that the second half-tide is of slightly longer duration than the first. The rise of tide at the furthest point is from 3 feet to 4 feet, but its waters are entirely fresh. It is on account of the sluggish motion and continued depth of this river that Mr. Stone believes it may run for another 100 miles into the interior. A boa-constrictor was shot, 15 ft. 3 in. long, having a protuberance in his body 14½ inches in diameter, which, when cut open, proved to be the body of a whole kangaroo only partially digested.

LAST Saturday's meeting at Bristol, under the presidency of the Mayor, in connection with the proposed University College of that city, was quite a successful one. A constitution, sufficiently comprehensive, was adopted, on the basis of which the general committee were empowered to incorporate the college, and to prepare the necessary legal documents. Thus the college may now be regarded as fairly set afloat, and judging from the enthusiasm of the meeting we should think it likely that it will soon be at work. Out of 40,000*l.* which were wanted, 22,000*l.* have been collected mainly in Bristol and neighbourhood; besides which, it is stated, some colleges at Oxford are willing to give 1,000*l.* a year towards University teaching at Bristol. Among those who spoke were Prof. Jowett and the Rev. Mr. Robinson, of New College, Oxford.

WE are authoritatively informed that the delay which has this year taken place in the zoological publications of the Linnean Society will not occur again, and has depended on causes over which the zoological secretary has no control, and for which he is not responsible.

PROF. MAX MÜLLER has been elected a Knight of the Order of Maximilian for Science and Art. The election to this Order, as to the Order *pour le mérite*, rests with the Knights themselves, and is confirmed by the King of Bavaria.

OUR letter last week (p. 106) on the late Dr. Stoliczka's collection of mammals was from Major H. H. Godwin-Austen, Deputy Superintendent of the Topographical Survey of India.

WE take the following from the *Pull Mall Gazette* :— In his last book ("Ziele und Wege der heutigen Entwicklungsgeschichte") Prof. Haeckel, the great apostle of Evolutionism in Germany, announces the discovery of the following law :—"In all the magnificent scientific institutes founded in America by Agassiz, the following empirical law, long recognised in Europe, has been confirmed,—viz. that the scientific work of these institutes and the intrinsic value of their publications stand in an inverse ratio to the magnitude of the buildings and the splendid appearance of their volumes." "I need only refer," he adds, "to the small and miserable institutes, and the meagre resources with which Baer in Königsberg, Schleiden in Jena, Johannes Müller in Berlin, Liebig in Giessen, Virchow in Würzburg, Gegenbaur in Jena have not only each advanced their special science most extensively, but have actually created new spheres for them. Compare with these the colossal expenditure and the luxurious apparatus in the grand institutes of Cambridge, Leipzig, and other so-called great universities. What have they produced in proportion to their means?"

IT is stated in communications received by the Scottish Meteorological Society from their observers in Iceland, that the volcanic eruptions continued till the 18th October, but since then no fresh eruptions have been noted. Up to the 4th inst. the weather in Iceland continued to be remarkably mild, little snow had fallen, and frost had been only of occasional occurrence.

The *Times* Naples correspondent, writing under date Dec. 7, gives details concerning the state of Vesuvius, which confirm Prof. Palmieri's prognostication referred to by us in a recent number (p. 94). The mountain is evidently in a state of great internal agitation, and all the circumstances seem to forbode an early eruption. There have been several earthquake shocks recently in Naples and the surrounding region, one of the most alarming being at 3.24 A.M. on the 6th. Prof. Palmieri does not, however, consider Vesuvius to be the centre of the disturbances; he is inclined to place it at Puglia.

A BOMBAY telegram states that a severe shock of earthquake was felt on Sunday last at Lahore and in the Peshawur district. Several lives were lost.

NEWS has been received lately from Gen. Nausouty and one of his friends who are spending the winter on the Pic du Midi, one of the most elevated mountains in the Pyrenean range, for the purpose of registering meteorological phenomena. The temperature of 22° cent. below zero C. was recorded during the recent cold weather. The observers, however, felt no inconvenience, as the interior temperature of the observatory was always kept above + 10° C. Last year this was impossible, and the observers were obliged to give up their task and to return to warmer regions, being almost starved and frozen to death when retreating.

ON December 5, at two o'clock in the afternoon, a slight earthquake was felt at Blidch, province of Algiers; the duration was only two seconds. A great storm was raging.

THE *Gazetta Medica di Roma*, which has reached its fifth number, is a journal we would commend to the attention of those interested in scientific medicine. It is well conducted and printed, and the original articles seem to us to be of a high class, creditable altogether to Italian medical research.

THE Auckland (New Zealand) *Southern Cross* hears from Taupo that Mount Tongariro is in a high state of activity, throwing stones for a distance of eight miles from the crater. All the springs and geysers in the neighbourhood are in full play, and some wonderful sights may be seen in this extraordinary region.

AT Rotherham the Committee formed in the town to conduct the Science Classes contains the following: a Clergyman of the Established Church holding the rank of Doctor of Divinity, a Unitarian Minister, a Wesleyan Minister, a Primitive Methodist Minister, and an Independent Minister. We do not need to point the moral.

A NEW periodical has been started in Paris, under the title of *Tour de France*. It records excursions within the borders of the French Republic, and contains maps and illustrations. It will do for France what the *Tour du Monde* does for foreign parts, its aim being to remind Frenchmen of the natural resources and beauties of their own land.

IN the beginning of 1876 there will be opened at Paris, in the Champs Elysées Palace, an exhibition, including all the objects relating to the exploitation of railways and electric telegraphs. This exhibition will interfere in no way with the contemplated Electrical Exhibition which is to take place in 1877.

MR. CASELLA, the well-known scientific instrument-maker, has sent us a specimen of a compass which will be a great boon to the many who are ignorant of the difference between the magnetic and the geographical poles, and of the fact that an ordinary compass points to the former and not to the latter, the difference in this country at present being about 19°. The great advantage of Mr. Casella's "unmistakable true north compass," is that it points to the true or geographical north, being corrected for use in the United Kingdom, and capable of adaptation to any locality in any part of the world. It is a card compass of beautiful workmanship, swings with perfect ease, and by means of a black cone on a white ground, the merest tyro can read it. It is made in various sizes, and sold at various prices, and deserves to come into extensive use.

THE projected programme of vegetable products issued by the Commission of the International Horticultural Exhibition, proposed to be held at Amsterdam in 1877, is one of the best, if not the best, we ever remember seeing. It contains a list of fourteen distinct articles, upon each of which information of the fullest description is asked, from a complete set of specimens of any particular plant of economic value through its various species or varieties down to the implements used in the collection or preparation of the product and the books or writings bearing on the subject. In the matter of vegetable fats and oils, as well as in paper materials, large fields of work present themselves, and much matter of great interest may be exhibited. If the exhibition is carried out in accordance with the designs of the projectors it cannot fail to be most successful and interesting.

TWO lectures, suited for a juvenile audience, will be given in connection with the Society of Arts, on Tuesday, January 4, and Tuesday, January 11, by Dr. W. B. Carpenter, F.R.S., on "The Wonders of the Microscope." The lectures will commence at 7 P.M., and will be illustrated by the oxyhydric and electric lights.

A SAD balloon accident occurred at Vincennes, near Paris, on the 8th inst. The balloon *Univers* having started at 11 o'clock in the morning descended with terrific force thirty-five minutes later from an altitude of 1,000 feet. The balloon was in charge of Eugene Godard, one of the most experienced French aeronauts. Eight persons were on board, amongst whom were Col. Laussedat and some officers who had made the ascent for topographical

purposes. Four persons were injured and the others experienced severe bruises. The real cause of the catastrophe is to be investigated officially by M. Giffard, the celebrated French engineer. At present it is supposed that the band of india-rubber which acts as a spring gave way under influence of the frosty weather.

THE Italian Geographical Society (the *Daily News* Roman correspondent telegraphs) held its first monthly meeting of the winter session on Sunday. Capt. Barrattieri read the report of the Society's expedition to the Tunisian Sahara last June. It gave interesting details of the journey to Gabes, to the Island of Gerba, and to other islands, described the country minutely, and proved the impossibility of the French project for connecting the Sahara with the Mediterranean by canal. The next paper, that of Deputy Caperio, on the latest explorations of Lake Victoria, dwelt on the importance of investigating the sources of the Nile between the mountains parallel to the coast and Lake Victoria. This was the task of the Italian expedition.

IN illustration of some remarks in the address of the president, Mr. H. R. Robson, of the Scottish Institution of Engineers and Shipbuilders, the number of the *Transactions* of that Society just published contains a large and carefully executed plate exhibiting a section of the Sub-Wealden bore-hole to the depth of 940 feet.

No. 166 of the *Notisblatt des Vereins für Erdkunde zu Darmstadt und des Mittelhainischen geologischen Vereins* contains a detailed résumé of the meteorological observations made at Darmstadt during 1874, accompanied with a neat and cleanly constructed diagram showing the daily and monthly results; and also the maximum and minimum temperatures, rainfall, and fog at six stations, during September 1875, in the Grand Duchy of Hesse. Among the many points detailed in the summary for Darmstadt may be noted the dates of the last and the first snow in the course of the year, the last and first frost, the last and first frost-day, mean temperature being  $32^{\circ}$  or lower; the number of frost-days each month, and of summer-days, temperature being  $77^{\circ}$  or higher, and the particular days on which thunder and other weather-phenomena occurred. From November to June the ozone was greatly in excess during the night, but during the other months the excess occurred during the day. Among other matters, there is an interesting table of the mortality during September last from various diseases, at thirteen towns in the Grand Duchy. The deaths from diarrhoea alone, which amounted to sixty-two, were a sixth of the whole. This high diarrhoea death-rate, which is three times greater than that of London during the same season, and the unequal manner in which these deaths, as well as deaths from phthisis, convulsions, and brain diseases, are distributed among the thirteen towns, suggest the desirableness of an inquiry into their sanitary conditions.

AT recent meetings of the Executive Committee of the British Pharmaceutical Conference, grants amounting in all to 75%, were made to a number of chemists for the purpose of obtaining material to enable them to carry on scientific researches into the nature and properties of certain substances used in pharmacy.

THE additions to the Zoological Society's Gardens during the past week include a Yellow-fronted Amazon (*Chrysotis ochrocephala*) from Demerara, presented by Mrs. Sproston; a Tree Sparrow (*Passer montanus*), two Mountain Linnets (*Linaria flavirostris*), European, purchased; a West African Python (*Python seba*) from West Africa, presented by Mr. W. H. Berkeley.

AT the annual meeting on the 4th inst. of the Huddersfield Naturalists' Society, the Secretary read a satisfactory report. The number of members is 134, the finances are in a flourishing condition, and during the past year twenty-two papers have been read.

### ON SOME PROPERTIES OF GALLIUM

IN a communication just made to the French Academy, M. Lecoq de Boisbaudran states that he has succeeded, after considerable labour, in obtaining salts of gallium sufficiently pure to give, in addition to the gallium spectrum, only faint traces of the zinc lines Zn  $\alpha$  144.62 and Zn  $\gamma$  150.05.

After adding a few facts regarding mixtures of gallium and zinc, he proceeds to examine certain reactions of the pure salts.

1. The electric spectrum of chloride of gallium, a little concentrated, is very brilliant. The line 417 is much brighter than the line 404. The author did not observe any other line attributable to gallium; there certainly are none of notable intensity, under the conditions. The colour of the spark in chloride of gallium is a beautiful clear violet.

2. In the gas flame he got only the line Ga  $\alpha$  417, and very faint and fugitive, even with a salt which gave a brilliant electric spectrum.

3. The chloride and the sulphate of Ga are precipitated by  $\text{NH}_3$ , but the precipitate is redissolved, in great part, in an excess of  $\text{NH}_3$ . Taking up with HCl the portion not dissolved by  $\text{NH}_3$ , and recommencing the operation, all the Ga is promptly obtained in ammoniacal solution.

4. An ammoniacal solution of sulphate or chloride of Ga is precipitated in the cold or hot state by an excess of acetic acid. The liquor must be extremely diluted.

5. The chloride and the sulphate of Ga are not precipitated in the cold state by the acid acetate of ammonia, but the reaction takes place on heating.

6. The sulphate of Ga is soluble in a 60 per cent. alcohol solution.

8. A salt was obtained which the author believes to be ammoniaco-gallic alum; though, in default of sufficient quantity, he was unable to analyse it or measure the angles.

9. The alum of Ga is soluble in cold water, but, on heating, the salt is decomposed, and the liquor becomes greatly troubled.

10. This alum is not decomposed in the hot state by water with addition of acetic acid.

11. It crystallises very easily in cubes and octahedra, presenting exactly the aspect of ordinary alum; its solution, evaporated under the microscope, also presents the characteristic changes of known alums.

12. The crystals do not act on polarised light (between two Nicols giving extinction).

13. A small crystal was kept some time under a layer of water, then transferred to a slightly supersaturated solution of alumino-ammoniacal alum; it immediately increased in size, and caused the crystallisation of the liquor.

14. With ammonia in excess, the alum of Ga behaves like the other salts of this metal; a portion of the oxide is precipitated, the other portion remains in solution.

15. The very acid solution of  $\text{Ga}_2\text{Cl}_6$  is precipitated by the yellow prussiate.

16. The ammoniacal solution of sulphate of Ga is decomposed by the voltaic current. Metallic gallium is deposited on the platinum plate serving as negative electrode. The positive electrode is covered, at the same time, with a whitish pellicle, which is easily detached from the platinum, and is insoluble in a large excess of  $\text{NH}_3$ . In a first operation 1.6 mgr. of Ga were deposited in 4h. 30m. on a platinum plate of about 185 square millimetres surface. The surface of the positive electrode was about 877 sq. mm. The battery consisted of five bichromate couples (zincs: 17 cm.  $\times$  10 cm.) coupled in tension. The author presented to the Academy a specimen weighing 3.4 mgr.; it was deposited in 5h. 40m. on a surface of about 123 to 124 sq. mm. The positive electrode 877 sq. mm.; the current furnished by ten bichromate elements (as above) coupled in tension.

17. Electrolytic gallium forms a very adherent layer; it is hard; it is polished with difficulty by friction with an agate burnisher. A better polish is obtained by strong compression under the burnisher; the metal thus acquires great brightness, and appears whiter than platinum. When the electric current and the relative dimensions of the electrodes are properly regulated, the gallium presents a beautiful dull surface of silvery white, finely granulated, and interspersed with small brilliant points, which the microscope shows to be crystals.

18. Gallium, deposited on a platinum plate, is not much oxidised during washing in cold or boiling water, nor on being dried in free air raised to about  $200^{\circ}$ . It decomposes water acidulated with HCl in the cold state, and (more rapidly) in the hot state, with a brisk liberation of hydrogen.

The salts of Ga which M. Lecoq de Boisbaudran has used in his researches, have been from the blend of Pierrefitte; he has, however, found the new metal in other ores of zinc, and notably in a transparent blend from Santander. He believes Ga will be met with in all blends. The Ga he extracted from the blends comes really from these minerals, and not from metallic zinc.

The author's last researches have confirmed the rarity of gallium in blend. The extreme sensibility of the spectral reaction led him even to over-estimate the quantities obtained. "I do not think I exaggerate," he remarks, "in saying that in my first observation I possessed at the most  $\frac{1}{100}$  of a milligramme of the new substance dissolved in a very small drop of liquid. The spectral analysis of so small a quantity of matter would have been impracticable before the considerable reduction I made in the dimensions of the apparatus for obtaining electric spectra, and without using very small sparks.

"If, as I suppose, there is no error as to the nature of my alum of Ga, the existence of this salt fixes the atomicity of the new element, and attributes to its oxide the same chemical function as that of alumina. The oxide of gallium, then, will be written  $Ga_2O_3$ ."

The author, in conclusion, refrains, for the present, from discussing the theoretical considerations raised in a recent note by M. Mendeleeff. Questions of the kind have long interested him; but he thinks it very probable that without the particular method followed in the present research, neither M. Mendeleeff's theories nor his own would soon have led to the discovery of gallium.

### SCIENTIFIC SERIALS

*American Journal of Science and Art*, November.—The original articles in this number are:—On the variation in the strength of a muscle, by F. E. Nipher.—Studies on magnetic distribution, by H. A. Rowland. This, Part I., is on linear distribution, and the scope is indicated by the titles of the sections: 1. Preliminary Remarks; 2. Mathematical Theory; 3. Experimental Methods for Linear Distribution; 4. Iron Rods magnetised by induction; 5. Straight Electro-magnets and permanent Steel Magnets; 6. Miscellaneous Applications.—(Estivation and its terminology, by Asa Gray.—A note in relation to the mass of meteoric iron that fell in Dickson County, Tenn., 1835, by J. L. Smith.—Specific gravity balance, by Roswell Parish. The object of this is to determine the specific gravities of minerals, and other solids heavier than water, without the use of exact weights and without mathematical computation.—A paper on Southern New England, by Prof. Dana.—Iowa county meteor and its meteorites, by N. R. Leonard.—On the post-Pliocene fossils of Sankoty Head, Nantuck Island, by A. E. Verrill. This article, referring to the paper by Desor and Cabot (Geol. Soc. Lond., 1849), purports to correct some matters of detail in that paper, and raises the number of known species from seventeen to sixty, of which a list is given.—In the short articles under "Scientific Intelligence" are:—Arithmetical relations between the atomic weights; Evidence of glacial action on the summit of Mount Washington; Discovery of the horns of an extinct species of ox in Ohio.—The two following reports are noticed: On the geology and resources of the region in the vicinity of the 49th parallel from the Lake of the Woods to the Rocky Mountains; A reconnaissance of the Black Hills of Dakota made in the summer of 1874.—In an appendix Prof. O. C. Marsh contributes a paper on the Odontornithes, or birds with teeth. After recapitulating facts he has already contributed, he gives this classification:—Sub-class, ODONTORNITHES: A. Teeth in sockets; vertebrae biconcave; sternum with keel; wings well developed; order, *Ichthyornithes*. B. Teeth in grooves; vertebrae as in recent birds; sternum without keel; wings rudimentary; order, *Odontolca*. There are two plates in illustration of this paper.

*Zeitschrift der Oesterreichischen Gesellschaft für Meteorologie*, Oct. 15.—In the concluding part of his article on the higher atmospheric strata, Dr. Hellmann gives the following results:—(2) Moisture: time of maximum, upper station, 4.30 P.M.; lower station, 5.43 P.M.; time of minimum: upper station, 7.3 A.M.; lower station, 7.30 A.M. The daily variation at the upper station is only half that at the lower station. From a table of relative humidity we learn that the air is much moister at the upper station and removed by an almost constant quantity from saturation. In the morning and evening the lower air is the moister, at midday the upper. (3) Wind. Easterly winds were

less prevalent at the summit than at the foot of Mount Washington, in the proportion of 1:2. It is now well ascertained that the wind at ordinary heights increases in strength daily from early morning till about 2 P.M., and then decreases until about 9 P.M. Herr Hellmann was surprised to discover a variation exactly contrary to this to hold on the summit. In fact, the least velocity occurs about 1 P.M., the greatest after 12 at night; while at the foot the usual variations were followed. Dove explains the generally observed increasing velocity in the morning in our climate by the combined action of a large mass of heated air ascending in the east, and the prevalence of westerly winds. In the evening the heated area would lie westward, the two influences would oppose each other and the wind would decrease in velocity. Similarly the diminution of velocity from early morning to mid-day at great heights may be caused by the overflow westward of the air heated in an area east of the station opposing the prevailing west wind, and the acceleration in the afternoon by the overflow eastward from the heated area now in the west adding itself to the west wind. In agreement with this view is the fact, shown by observations on the Rigi, that velocity in summer is least about mid-day, much greater in the early morning and late evening, and in winter on the contrary, in harmony with the variations at low levels. The greatest observed velocity was ninety-six miles an hour. While this storm blew aloft a calm reigned below. But is it not likely that a current was drawn upwards by it? We have no instruments to register vertical currents. With respect to the relation of temperature to height, clearly it cannot be simply formulated, and will differ according to the altitude at which the daily ascending current flows off laterally. (4) Clouds. There was more cloud and fog at the summit about midday than at other times, and, roughly speaking, the amount of cloud varied inversely as that below during the daytime.

*Memorie della Societa degli Spettroscopisti Italiani*, March, contains a table by Father Secchi, showing the number of protuberances and spots viewed, and the number of days on which observations were made during each revolution of the sun from April 1871 to March 1875, in all forty-two revolutions. The number of protuberances or spots seen during each revolution, divided by the number of days, gives an average for each day; this in 1871 was about 26 for protuberances and 100 for spots, and decreases gradually down to 5.45 for protuberances and 18.8 for spots, in March last. Drawings of the chromosphere for January, February, and March, by Secchi and Tacchini, also accompany this number.

May.—A paper by Prof. Bredichin, on spectroscopic observations of the sun, referring to the relation between spots and prominences, or the latter being the cause of the former. A long series of observations by Prof. Tacchini, from February to June 1873, showing the positions on the sun in which prominences containing magnesium or giving the 1474 line were seen. The maximum number of positions in which magnesium was observed for any one day was sixty, and the same number for the 1874 line.—Prof. Pisati contributes a paper on the theories of electro-static induction.

June.—Prof. Tacchini writes on a method of determining the angles of position of spots and faculae. In this case the image of the sun is thrown by the eye-piece of the telescope on to a screen on which is a divided circle, with which the image of the sun coincides.—Father Secchi contributes a paper on the solar prominences observed from April 1871 to June 1875. Accompanying this paper are tables showing the number of prominences in each ten degrees of solar latitude, together with their heights and sizes.

July.—A note on the presentation of a medal to Prof. H. Draper by the United States Government for his assistance in preparing for the Transit of Venus.—Observations of the positions in which prominences containing magnesium occurred during July 1873, by Prof. Tacchini.—Drawings of chromosphere during March and April 1874, by Secchi and Tacchini.

August.—A continuation of table by Tacchini, showing positions on sun where prominences containing magnesium occurred during August and September 1873.—Prof. Tacchini writes on observation of the Perseids of last August, in which he gives the mean radiant point as 2h. 50m. and + 53° 8' 6".

*Verhandlungen der k. k. geologischen Reichsanstalt*. Vienna, Sept. 30.—In this number Dr. Schimper describes the geological conditions of the district of Arrho, in Abyssinia, and a curious apparently volcanic phenomenon met with there. The district is a cleft-crossed plain near (and below the level of) the

Red Sea, from which it is separated by a low range of hills. The gentle rains at one part of the year supply sufficient moisture to heat the iron pyrites scattered over the surface of Arrho to a mild glow; the substance is decomposed, lixiviated, and brought into combination with several combustible matters, and eruptions like those of volcanoes take place; slime cones are formed from four to twelve feet in height, from which, as from pipes, issue steam and flame. These generally ephemeral formations consist of mud which is mixed with sulphur and salt, and in the dried cones may be found almost pure sublimated sulphur. The general appearance of the place is like that of pulp boiling in a huge, angular, zig-zag cauldron. The phenomenon continues till increased rains lay the ground under water, after disappearance of which at the end of the rain periods, a hard salt crust, several inches thick, covers the ground.—The trachytes of the island of Cos are described by Dr. Dölter; Dr. Stäche gives an account of the eruptive rocks in the Ortler region and the mountain group of the Zwölfer-Spitz in Upper Vintschgau; and Dr. Hörnes, of observations in the district where the Rienz takes its rise.

SOCIETIES AND ACADEMIES

LONDON

Royal Society, Nov. 25.—On the production of Glycosuria by the effect of oxygenated blood on the liver, by F. W. Pavy, M.D., F.R.S.

The conclusions arrived at are that the amyloid substance found in the liver is a body which tends to accumulate in certain animal structures under the existence of a limited supply of oxygen, and that it is through the liver exceptionally receiving the supply of venous blood it does, that the special condition belonging to it is attributable. It is also shown that the undue transmission of oxygenated blood to that organ at once induces an altered state, which is rendered evident by the production of glycosuria.

On the Structure and Relations of the Alcyonarian *Heliopora carulea*, with some account of the anatomy of a species of *Sarcophyton*; notes on the structure of species of the genera *Millepora*, *Pocillopora*, and *Stylaster*, and remarks on the affinities of certain Palæozoic Corals, by H. M. Mozeley, Naturalist on the Challenger Expedition.

The title of this paper indicates the nature of its contents. The author has not been able to decide whether *Millepora* is one of the actinozoa or belongs to the hydrozoa as stated by Prof. Agassiz. *Heliopora* is undoubtedly alcyonarian.

Mathematical Society, Dec. 9.—Prof. H. J. S. Smith, F.R.S., president, in the chair.—Major J. R. Campbell and Prof. G. M. Minchin were elected members.—Prof. Clifford read a paper on the transformation of elliptic functions, in which he attempted to apply Jacobi's geometrical representation of the addition-theorem in elliptic functions to the theory of their transformation.—Prof. Cayley spoke on a system of algebraical equations connected with Malfatti's problem. The communication was an extension of a paper by the same gentleman in the *Cambridge and Dublin Mathematical Journal*, tom. iv., 1849, pp. 270-275.—The chairman next communicated three short notes: 1. On a problem of Eisenstein's. If  $p$  is an uneven prime, the function  $4 \frac{x^p - 1}{x - 1} = Z$  can always be expressed in

the form  $Y^2 - (-1)^{\frac{1}{2}(p-1)} p X^2$ , where  $X$  and  $Y$  are rational and integral functions of  $x$ , having integral coefficients. This is a theorem of Gauss. Eisenstein's problem (*Crelle's Journal*, vol. xxvii. p. 83) is "to determine the cases in which the equation  $Z = Y^2 - (-1)^{\frac{1}{2}(p-1)} p X^2$  admits of a multiplicity of solutions, and to ascertain the law connecting the various solutions, when there is more than one." The solution of this problem is as follows:—If  $[T, U]$  is any solution whatever in integral numbers of the equation  $T^2 - (-1)^{\frac{1}{2}(p-1)} p U^2 = 4$ , and  $[X, Y]$  is any one given solution of Gauss's equation, then all the solutions of Gauss's equation are comprised in the formula—

$$\left[ \frac{1}{2} (TX + (-1)^{\frac{p-1}{2}} p UV), \frac{1}{2} (UX + TY) \right].$$

Thus if  $p = 4n + 3$  the equation admits of but one solution (the four solutions  $[\pm X, \pm Y]$  being regarded as but one) except in the case  $p = 3$ , when it admits of three; if  $p = 4n + 1$ , the equation admits of an infinite number of solutions. That the

functions  $[\frac{1}{2}(TX + pUV), \frac{1}{2}(UX + TY)]$  are all of them solutions of Gauss's equation is evident; the proof that this formula comprises all the solutions of the equations is less elementary, because it depends on the irreducibility of the function  $Z$ . There exists a general theory of the representation of rational and integral functions of  $x$  by quadratic forms; such representation being, of course, only possible when the given function of  $x$  is capable of resolution into two factors by the adjunction of a quadratic surd.—2. On the joint invariants of two conics, or two quadrics. Let  $P$  and  $Q$  be two conics, and let 1 2 3 be any triangle self-conjugate with regard to  $P$ . Let also  $P_1, P_2, P_3$  be the rectangles of the points 1, 2, 3, with regard to the conic  $P$ , these rectangles being taken upon transversals measured in any fixed direction; and let  $Q_1, Q_2, Q_3$  have similar meanings with regard to the conic  $Q$ , the direction of the transversals being

also fixed. Then the expression  $\frac{Q_1}{P_1} + \frac{Q_2}{P_2} + \frac{Q_3}{P_3}$  has the same

value for all self-conjugate triangles of  $P$ ; and is, in fact, that invariant of  $P, Q$ , which is linear with regard to  $Q$ , and quadratic with regard to  $P$ , and the evanescence of which expresses that  $Q$  harmonically circumscribes  $P$ . The corresponding theorem in the geometry of the straight line is: "If  $Q_1, Q_2, P_1, P_2$  are two pairs of fixed points on a line, and if  $A_1, A_2$  is any pair of harmonic conjugates of  $P_1, P_2$ , the value of the expression

$$\frac{A_1 Q_1 \cdot A_1 Q_2 + A_2 Q_1 \cdot A_2 Q_2}{A_1 P_1 \cdot A_1 P_2 + A_2 P_1 \cdot A_2 P_2}$$

is independent of the particular pair  $A_1, A_2$  considered." From this theorem, the result given above for two conics follows immediately; from it the corresponding property for two quadrics may be inferred, viz.:

$$\frac{Q_1}{P_1} + \frac{Q_2}{P_2} + \frac{Q_3}{P_3} + \frac{Q_4}{P_4} = \text{constant};$$

and so on for quadratic functions containing any number of indeterminates. 3. On the equation  $P \times D = \text{constant}$ , of the geodesic lines of an ellipsoid. From this equation (in which  $P$  is the perpendicular from the centre upon the tangent plane at any point of the geodesic, and  $D$  is the semi-diameter parallel to the tangent line of the geodesic) it is convenient to be able to infer directly the principal properties of the geodesic line, without having first to transform the equation into  $M$ . Liouville's form,  $\mu^2 \cos^2 i + \nu^2 \sin^2 i = a^2$ . In Dr. Salmon's "Geometry of Three Dimensions," the theorem of the constancy of the sum or difference of the geodesic radii vectores, drawn from any point of a line of curvature to two umbilics, is thus demonstrated. And it is worth while to add (though it is very improbable that the point has not been noticed before) that a proof of the theorem that two geodesic tangents of a line of curvature which intersect at right angles, intersect on a sphericonic, may similarly be obtained without transforming the equation. Let  $Q$  be the point where the two geodesic tangents intersect at right angles,  $O$  the centre of the ellipsoid; let  $c = OQ$ , and let  $a, b$  be the semi-axes of the central section parallel to the tangent plane at  $Q$ . The two geodesics make angles of  $45^\circ$  with the lines of curvature at  $Q$ : hence, for either of these geodesic lines,

$D^2 = \frac{2a^2 b^2}{a^2 + b^2}$ . Let  $Q'$  be a second point where two geodesic tangents to the same line of curvature intersect at right angles; then  $\frac{2 P^2 a^2 b^2}{a^2 + b^2} = \frac{2 P'^2 a^2 b^2}{a'^2 + b'^2}$  because  $P \times D$  has the same

value for all geodesic lines touching the same line of curvature. But  $P^2 a^2 b^2 = P'^2 a'^2 b'^2$ , because parallelepipeds circumscribing an ellipsoid with their faces parallel to conjugate diametral planes are equal. Hence  $a^2 + b^2 = a'^2 + b'^2$ . But also  $a^2 + b^2 + c^2 = a'^2 + b'^2 + c'^2$ .  $c = c'$ , and  $Q$  and  $Q'$  lie in the same sphericonic. Mr. Tucker (in the absence of the author) brought before the Society a paper by Mr. H. W. Lloyd Tanner on the solution of certain partial differential equations of the second order, having more than two independent variables. The equations considered are included in the form—

$$\sum_{i=1}^n \sum_{j=1}^n V_{ij} \frac{d^2 x}{dx_i dx_j} + V_0 = 0 \dots (1)$$

where  $V_{ij}, V_0$  are functions of

$$x_1 \dots x_n, p_1 \left( \equiv \frac{dx_1}{dx_i} \right) \dots p_n \left( \equiv \frac{dx_n}{dx_i} \right), \dots$$

and it is proposed to investigate the conditions that (1) should be soluble in terms of arbitrary functions, the arguments of



which are definite functions of  $x_1, \dots, x_n$ ; and when these conditions are satisfied to determine the solution. Three cases arise for discussion: (1)  $n - 1$  of the arguments independent, (2)  $n$  of them independent, (3)  $n + 1$  of them independent. The paper concludes with a note on the application of a similar method to equations of an order higher than the second.

Zoological Society, Dec. 7.—Mr. George Busk, F.R.S., V.P., in the Chair.—Mr. Sclater read an extract from a letter addressed to him by Mr. H. A. Wickham, on the occurrence of the large blue Hyacinth Macaw, (*Ara hyacinthina*) near Santarem, on the river Amazons.—Mr. Sclater exhibited and made remarks on a Skin of *Hypocolinus ampelinus*, Bp, obtained by Mr. W. T. Blanford, in Upper Scinde, to the west of Shikapur.—Prof. Owen, C.B., read the twenty-second part of his series of Memoirs on Dinornis. This part contained a restoration of the skeleton of *Dinornis maximus*.—Mr. J. W. Clark read a paper on the Eared Seals of the islands of St. Paul and Amsterdam, to which he added a description of the Fur Seal of New Zealand from specimens kindly furnished by Dr. Hector. Mr. Clark further read copious extracts from the narratives of the older Explorers in these seas, and attempted to reconcile the notices given by them with the subsequent description of Naturalists.—A communication was read from the Rev. R. Boog Watson, on the generic peculiarities of the distinctively Madeiran Achatinas of Lowe.—A communication was read from Dr. Hermann Burmeister, Director of the National Museum, Buenos Ayres, containing the description of a new species of *Dolichotis*—which Dr. Burmeister proposed to call *Dolichotis salmicola*.—Mr. W. T. Blanford communicated particulars respecting some large Stags' Horns, obtained by the Expedition to Western Turkestan to which the late Dr. Stoliczka was attached as Naturalist, said to have been brought originally from the Thian Shan Mountains. These horns were of very large size, each measuring 51 inches in length round the curve.—Mr. Blanford, considering that these horns clearly showed the existence of a species hitherto undescribed, gave a full description of them, and proposed to give the name of *Cervus custephanus* to the animal to which they belong.—Dr. O. Finsch communicated some notes on *Phaenomanes iora*, Sharp, and *Abrornis atricapilla*, Blyth, and pointed out that the first named bird is identical with *Iora lafresnayei* of Malacca, while *Abrornis atricapilla*, said to be from China, is in fact a *Myiodiodes pusillus*, Wils., a well known North American bird.—A second communication from Dr. Finsch contained the description of a bird from the Arfak Mountains, New Guinea, which appears to form a new genus and species. This Dr. Finsch proposed to call *Pristornamphus versteri*.—A third communication from Dr. Finsch gave the characters of six new Polynesian birds in the Museum Godeffroy at Hamburg.—A communication from Mr. J. Caldwell, contained some notes on the Zoology of the Island of Rodriguez.—Dr. E. Von Martens communicated a list of the Land and Fresh Water Shells collected by Mr. Osbert Salvin in Guatemala in 1873-74.

Geological Society, Dec. 1.—Mr. John Evans, V.P.R.S., president, in the chair.—M. Rodolfo de Arteaga, William Henry Barnard, the Rev. J. Clifford, M.A., Lieut.-Gen. Robert Fitzgerald Copland-Crawford, R.A., Walter Derham, B.A., James Duigan, George R. Godson, the Rev. Algernon Sydney Grenfell, Sir David Salomons, Bart., Aubrey Strahan, B.A., William Thomas, Edward Wethered, F.C.S., the Rev. Burgess Wilkinson, and Edward Alfred Wunsch were elected Fellows of the Society. The following communication was read:—On the granitic, granitoid, and associated metamorphic rocks of the lake-district.—Parts III., IV., and V., by Mr. J. Clifton Ward, of the Geological Survey of England and Wales. Part III. On the skiddaw granite and its associated metamorphic rocks. The subject was treated under the three heads of (1) Examination in the field, (2) Microscopical examination, (3) Chemical examination, and the following were the general results arrived at. The metamorphism of the skiddaw slate extends for many miles around the several granitic masses, and commences by the formation of small spots which become developed into chialtolite crystals. The chialtolite slate passes into spotted schist, by the great increase of the small oblong spots arranged along planes of foliation, and mica appears. The spotted schist graduates into mica-schist, which, however, often retains to the last faint spots, and occasionally chialtolite crystals. The junction between the mica-schist and the granite is generally rather abrupt. On the whole, chemical and field evidence especially are against regarding the granite, now exposed, as the result of the extreme metamorphism

of the skiddaw slates immediately around it; but whether it may not have resulted from the metamorphism of underlying parts of the same series is an open question. The great contortion of the mica schist around the granitic centres may be in part due to, at any rate, partially intrusive character of the granite. In an appendix abstracts of papers by various authors who have written in connection with the subject were given.—Part IV. On the quartz felsite, syenitic, and associated metamorphic rocks of the lake district. This part was treated under the same three heads of field, microscopical, and chemical evidence as the last. The quartz felsite of St. John's Vale, and the syenitic granite of Buttermere and Ennerdale, lie for the most part at the junction of the volcanic and skiddaw series, and seem by their line of strike, and by the occasional presence of bands of slate or volcanic rock enclosed within or running through them, to represent the transition beds between the two series, metamorphosed in great measure *in situ*. Both microscopical and chemical evidence demonstrate the possibility of this process. Evidence gathered in the field, and microscopical and chemical examination, all seem to suggest that the rocks of Carrock Fell, &c., represent the base of the volcanic series, consisting largely of contemporaneous traps, thrown into a synclinal, the axis of which ranges generally east and west, and metamorphosed into rocks of greatly varying character, such as sphærolitic felsite, hypersthene, and diorite. Although all the various masses treated of were probably formed in the main by the metamorphism of beds *in situ*, it is probable that some parts of the resulting magma became occasionally intrusive among and absorptive of higher beds. In an appendix notices of papers on these rocks by other authors were given.—Part V. General summary. In this part the leading results of the four preceding divisions of this memoir were briefly brought forward, followed by the discussion of various considerations relating to metamorphism, under the following heads:—1. Granite at various depths; 2. How far granite may be an ultimate universal product of metamorphism; 3. Distribution of metamorphism (selective metamorphism); 4. Classes of metamorphism. The paper was illustrated by a large geological map of the northern part of the Lake district, by a geological model of the Keswick district, by rock specimens, and large coloured photographs taken from water-colour microscopic drawings made by the author.

Physical Society, Dec. 11.—Prof. Gladstone, F.R.S., president, in the chair.—The following candidates were elected members of the Society:—C. Higgins and S. O. Thompson, B.A., B.Sc.—In the absence of Prof. G. C. Foster, Mr. Lodge exhibited and described a simple form of chronoscope for measuring short intervals of time, which Prof. Foster has recently devised. In experiments commenced about eight years ago the apparatus consisted essentially of three parts: 1. An arrangement for releasing the bullet or other body whose fall was to be timed, when the apparatus is employed for such determinations; 2. An arrangement for directing a gauged stream of water into a vessel during the time occupied by the fall of the body; and 3. A platform to receive the falling body. The stream of water was directed into the vessel by means of a bent funnel brought under a constantly flowing stream by an electro-magnet. But this apparatus had two serious defects, one of which was caused by the difficulty of accurately gauging the stream, and the other by the inertia and consequent sluggishness of movement of the funnel. The arrangements, however, for dropping and receiving the bullet being satisfactory, were finally adopted. The former is simply a clip one side of which is a spring, and this forms the armature of a small electro-magnet. On completing the circuit the spring is drawn aside and the bullet released, momentarily breaking a current which passes through it, as subsequently described. The bullet, at the end of its fall, strikes a small mahogany table, so arranged that the blow slightly depresses it, and permanently breaks the same current, which in the interval has been closed by a subsidiary wire. The author abandoned the method of indicating the commencement and end of the fall by an independent electro-magnet and, substituting the trace made on blackened paper by a vibrating tuning-fork for the stream of water, he registered them by perforations made by induction-coil sparks in the blackened paper, a method suggested by the description of Beetz chronoscope. The apparatus is difficult to describe without the aid of diagrams, but the following will perhaps sufficiently indicate the general arrangement. The two terminals of the secondary coil are connected, the one with the tuning-fork, and the other with the metallic drum on which the blackened

paper is carried. The other connections are as follows:—The current passes from one pole of battery to spring of releasing apparatus (which is also connected with one terminal of a separate condenser), thence through the bullet to the fixed portion of the clip, and by a wire to the lower table, which is also in electrical connection with the face of the electro-magnet which releases the bullet, in order that the current may be completed immediately the falling body is released. From this table the current passes through an adjusting screw to one terminal of the primary wire of the induction coil which is connected with the other condenser terminal. The other pole of the battery is connected with the primary. The spark in each case is caused by the breaking of the current which takes place when the bullet is released and when it strikes the table, the perforations in the black paper of course being made in the trace produced by the tuning-fork. It is hardly necessary to mention that the releasing electro-magnet is worked by one or two independent cells. The author considers that with a fork making sixty-four complete vibrations in a second the error, in determining an interval of not more than two or three seconds, should not exceed  $\frac{1}{1000}$ th of a second, and that with a more rapidly vibrating fork probably much greater accuracy might be attained. Mr. Lodge made four experiments before the Society with falls of 2 ft. and 1 ft., from which the value of gravity was found to be 32.21. Prof. Guthrie inquired whether the instrument was sensitive to the influence of temperature on the time of vibration of the tuning-fork. Mr. Ladd suggested that the pressure of the marker on the end of the tuning-fork might hinder its vibration, and referred to difficulties which Capt. Noble had met with in the working of his chronograph. Mr. Lodge stated that experiments had only been made in a laboratory having a fairly equable temperature, and that therefore the effect of considerable changes of temperature had not been ascertained. He considered that the slight resistance referred to by Mr. Ladd would rather tend to diminish the amplitude of vibrations than to change their number per second.—Prof. McLeod then described and exhibited an arrangement for ensuring that the charge given to a Leyden jar shall not exceed any fixed limit. Through a cork in the upper end of a bell-glass passes a brass rod, insulated through its entire length by means of a glass tube, through which it passes freely. To the upper end is attached a brass knob, and the lower end is pointed and provided with a screw-thread, so that it can be set at any distance within, or through, a hollow brass ball, perforated below and rigidly fixed to the glass tube. Within the bell-glass is a loose cage of perforated sheet zinc and a vessel containing strong sulphuric acid. The whole stands on a metallic plate to secure a good earth connection. The action is as follows:—If the rod be screwed down so that the point projects through the hollow ball, the upper knob and lower metallic plate being connected with the two poles of a Holtz machine, only short sparks can be obtained, because a large amount of electricity escapes at the point; but if the rod be raised so that the rod barely enters the hollow ball, at the top, no escape takes place from it, and the machine will give its full length of spark. By varying the position between these two extreme limits, any required length of spark or amount of charge for an interposed Leyden jar can be obtained.

Entomological Society, Dec. 1.—Sir Sidney Smith Saunders, C.M.G., president, in the chair.—Mr. W. A. Forbes exhibited a variety of the Burnet Moth (*Zyana filipendula*), with yellow spots, of which he had bred a number from larvæ taken near Winchester.—Mr. Champion exhibited some rare British Coleoptera.—Mr. William Cole exhibited carefully-executed drawings of the pupæ of a species of the Dipterous genus *Ephya*, which he had taken clinging to the stems of grass, in blackish water, near Southend, Essex.—The President referred to the numerous parasites found on bees of the genus *Osmia*, and remarked that M. Jules Lichtenstein had recently obtained *Zonitis frausta* from the cells of *Osmia tridentata*; and likewise *Euchalus vetusta*, Duf., from its desiccated adult larvæ, in the same way that *Halticella osmicida* effects its metamorphosis, thus making the thirteenth parasite recorded as infesting this particular species of bee.—A paper was communicated by Dr. Burmeister, of Buenos Ayres, giving a description of a new genus belonging to the family *Scaritidae* (nearly allied to *Clivina*), taken on the shore of the river Uruguay, near the town of Concordia.

PARIS

Academy of Sciences, Dec. 6.—M. Frémy in the chair.—On the constitution of phosphates, by MM. Berthelot and Louguinine.

—Atmospheric perturbations of the hot season of 1875, by M. Belgrand.—On the colouring matter of fruits of Mahonia, and the characters of the wine these fruits give by fermentation, by M. Ls. Pierre.—On the astronomical phenomena observed in 1597 by the Dutch in Novaya Zemlya, by M. Bailla.—Note on the double touch process of magnetisation, by M. Gauguain.—On the temperature of elevated layers of the atmosphere, by M. Mendeleeff. The temperatures observed there are constantly higher than those calculated; this is accounted for by aqueous vapour.—On the transparency of flames and of the atmosphere, and on the visibility of scintillating lights, by M. Allard. From experiment he adopts 0.81 as mean value of the coefficient of transparency of flame, referred to the centimetre of thickness traversed. The absolute intensity of flame increases more rapidly than the weight of oil consumed, but the amount of light absorbed in passage of rays through the flame increases still more rapidly.—On the distribution of magnetism in circular or elliptical steel plates, by M. Duter.—On some properties of gallium, by M. Lecoq de Boisbaudran. This is noticed fully elsewhere.—Note on a derivative by hydration of cellulose, by M. Aimé Gerard.—Researches on the constitution of albuminoid matters, by M. Schutzenberger.—On the development of the fruit of *Chaetomium*, and the supposed sexuality of Ascomycetes, by M. van Tieghem.—On new fossil pieces discovered in the phosphorites of Quercy, by M. Gaudry.—On the virulent state of blood of healthy horses, killed by falling or asphyxia, by M. Signol. The blood taken from the body after sixteen hours proves rapidly fatal to goats or sheep inoculated with it (twenty-four drops). Motionless bacteria are present, but there is no sign of putridity.—Discovery of the 157th small planet at Marseilles on Dec. 1. Ephemerides and observations of planets lately discovered, by M. Stephan.—Observations of planets (152) and (154) made at the Paris Observatory, by M. Prosper Henry.—On the isochronism of the spirals of chronometers, by M. Caspari.—Note on the distribution of magnetism in the interior of magnets, by MM. Trève and Durassier.—On the fermentation of fruits, by MM. Lechartier and Bellamy.—On panification in the United States, and the properties of hops as ferment, by M. Sacc.—On the presence, in present seas, of a type of Sarcodaria of the secondary strata, by M. Fischer.—On larval forms of Bryozoa, by M. Barrois.—On the organisation of Acarians of the family of Gamasides; characters showing that they form a natural transition between hexapodan insects and Arachnida, by M. Megnin.—Nidification of the rainbow fish of India, by M. Carbonnier.—On the ferns and Lycopodiaceæ of the islands St. Paul and Amsterdam, by M. Fournier.—On the influence of stripping off the leaves of beet on production of sugar, by M. Corenwinder.

BOOKS AND PAMPHLETS RECEIVED

BRITISH.—The Native Races of the Pacific States of North America. Vol. iv.: Hubert Howe Bancroft (Longmans).—The Movements and Habits of Climbing Plants: Charles Darwin, M.A., F.R.S. (Murray).—Medical Plants. Part 2: R. Bentley, F.L.S., and H. Trieman, M.B. & L.S. (Churchill).—Milk in Health and Disease: A. Hutchinson Smeed (Newman).—Magnetism and Electricity: F. Guthrie (Wm. Collins, Sons and Co.).—Hermann's Human Physiology. Translated by A. Gamgee, M.D. F.R.S. (Smith and Elder).—Pyrology, or Fire Chemistry: Wm. A. Ross (Spott).—Timber and Timber Trees: Thomas Laslett (Macmillan).—Discoveries and Inventions of the Nineteenth Century: R. Routledge, B.Sc., F.C.S. (Koutledge).

CONTENTS

	PAGE
HARKERL'S HISTORY OF CREATION. By P. H. P. S. . . . .	121
BURTON'S GORILLA LAND AND THE CONGO ( <i>With Illustrations</i> ) . . . . .	123
THE GERMAN NORTH SEA COMMISSION. By E. P. W. . . . .	125
OUR BOOK SHELF:—	
" The Origin of the Sun's Heat and the Chemical Constitution of the Matter of his System" . . . . .	126
LETTERS TO THE EDITOR:—	
Theophrastus versus Millington.—A. B. C. . . . .	127
Estimation of Fractions.—W. M. FLINDERS PETRIE . . . . .	127
The Late Dr. von Willenoes-Subm.—J. C. G. . . . .	129
Seasonal Order of Colour in Flowers.—C. E. HERON ROGERS . . . . .	129
OUR ASTRONOMICAL COLUMN:—	
Atlas Pleiadum, 2 453 . . . . .	129
The "Gegenschein" of the Zodiacal Light . . . . .	129
The Comet of 1729 . . . . .	129
RUTIMEYER ON TRACKS OF MAN RECENTLY DISCOVERED IN THE INTER-GLACIAL COAL-BEDS OF SWITZERLAND. By J. L. . . . .	130
THE THEORY OF "STREAM LINES" IN RELATION TO THE RESISTANCE OF SHIPS, III. By Wm. FROUDE, F.R.S. ( <i>With Illustrations</i> ) . . . . .	130
THE CHANNEL TUNNEL.—SUBMARINE EXPLORATIONS. By W. TOPLEY . . . . .	133
NOTES . . . . .	134
ON SOME PROPERTIES OF GALLIUM . . . . .	136
SCIENTIFIC SERIALS . . . . .	137
SOCIETIES AND ACADEMIES . . . . .	138
BOOKS AND PAMPHLETS RECEIVED . . . . .	140

THURSDAY, DECEMBER 23, 1875

*LORD DERBY ON THE ENDOWMENT OF SCIENTIFIC RESEARCH*

WE do not think it possible to estimate too highly the value of Lord Derby's address last Friday at Edinburgh, and his statements as to the rapidly widening fields of science and the increasing value of the results of scientific research. We shall simply content ourselves with quoting the very remarkable views he put forth as to the duty of the State with regard to the encouragement of research, views which, when we consider the character of the speaker and his official position, must be regarded as of the greatest significance. After speaking of the all-absorbing nature of scientific research, of the necessity of complete devotion to a special department in order to achieve success, and of the "world-wide benefit" of scientific results, Lord Derby said :—

"Science, above all, needs leisure, and I hope it is not utopian to look forward to the possibility of a far ampler provision being made for its prosecution by competent persons than exists at present. I do not refer merely or principally to help from the State; though, speaking for myself, I should not grudge it in such a cause. But the spirit of patriotism which animated founders of schools and colleges and public benefactors of former days is not extinct; in some directions it is more flourishing than ever. An American banker lately gave half a million to help the poor of London; a well-known Scotch gentleman has given the same sum within the last few years in aid of the Kirk of Scotland; money is never wanting at either end of this island when men see their way to make a good use of it. When have schools, hospitals, public parks, museums, institutes been more abundant than at the present day? Science has no endowments, or next to none; but only because the interest in that class of subjects is comparatively new, and rich men, who want to do some good with their capital, have not looked much in that direction as yet. Is it too sanguine a hope that we may see individual liberality take a form which hitherto it has rarely taken? Who knows how many discoveries might be worked out, how many conquests of man over nature secured, if for, I do not say a numerous body, but even for some 50 or 100 picked men, such modest provision were made that they might be set apart, free from other cares, for the double duty of advancing and of diffusing science? Who can measure what has already been lost to England and to the world, when intellects capable of the highest kind of original work have been wasted, not by choice, but by necessity, on the common drudgery of every-day life? I know very well that to some extent that must continue to be the case; it is visionary to contemplate a state of society in which every man will find exactly the employment that suits him; in human life, as in nature, there will always be a vast apparent waste of power. But we may at least reduce that waste where we see it going on; original capacity is not so common that we can afford to throw it away, nor so difficult to discover that we may excuse ourselves by saying we did not see it. I am quite aware that endowments of all sorts are discountenanced by a certain class of thinkers, of whom I speak with re-

spect, but who, I think, argue from the abuse of a thing against its use. The fact remains that the most enduring and valuable work done in the line of pure science will not bring a shilling to the man who does it; and while that is so (and one does not see how it can be otherwise), there seems nothing unreasonable in saying that society shall, in one way or another, make provision for those who are doing so much for society. Nor do I see that the risk of jobbing in such matters is great. Men who work to make money, or men who care for reputation of the popular sort, do not choose such pursuits as those of which I am speaking. And, making all allowance for the little jealousies and rivalries from which no profession is free, I believe that there is seldom any difficulty in picking out the best qualified candidates for professorships and appointments of that kind where there is an honest wish to find them. I go into no detail; I indicate no special plan. I had rather, for my own part, see action taken by the community than by the State, or, at least, I should wish to see the community largely helping the action of the State; but whatever is done, or whoever does it, I think that more liberal assistance in the prosecution of original scientific research is one of the recognised wants of our time. How far that assistance can be obtained by the utilisation of ancient endowments is a question partly of principle, partly of detail. I do not agree with the extreme views which have been put forward on either side in regard to it. I cannot follow the reasoning of those who say that the State has no right to divert endowments from one purpose to another. There must be a regulating power somewhere, else changes which, by common consent, lapse of time has made necessary could not be effected; and whether that power is vested in a Court of Justice or in a Commission, it is equally the power of the State. To my mind, so far as right is concerned, the Legislature may do what it chooses in regard to any endowment, without injustice, provided only that the rights of living individuals are respected. How far it is politic to use that power is another matter. Push its exercise too far, and you kill the bird that lays the golden eggs. Men give or leave funds, not for the promotion of useful public purposes in the abstract, but for some special form of public usefulness that has taken their fancy. You never hear of a fortune left to the Chancellor of the Exchequer to employ as he thinks best for the public service. One man cares for schools, another for hospitals, and so forth; and unless intending benefactors have a reasonable security that the general purpose for which they leave their money will be respected, the stream will soon dry up. More than that, I consider, they ought not to ask. Respect the founder's object, but use your own discretion as to the means; if you do not do the first, you will have no new endowments; if you neglect the last, those which you have will be of no use."

We need not add one word of our own in support of these views; the case on behalf of the endowment of research, which we have long advocated on the grounds stated by Lord Derby, could not be more forcibly put. It may, however, be useful to collect for reference the opinion of the country as expressed through the daily press.

The *Daily News* thus endorses Lord Derby's views :—

"The real advancement of science needs, as Lord Derby says, leisure, and the power and opportunity of purely disinterested study. In this sense all scientific men will agree with Lord Derby that science needs more help. We have, indeed, in England, some very illustrious living examples of men who not only teach, as a daily and laborious duty, the methods and results of scientific investigation, but who have themselves, in a precious and hard-earned leisure, carried that investigation far forward along paths hitherto untrodden. But it has occurred to every reader of their writings to ask what they might have added to the world's knowledge had they been able to devote their whole time and strength to their favourite pursuit. There is a growing conviction that investigation of this kind, as apart from teaching, ought to be encouraged by the State. Lord Derby would not grudge it help, even from national resources; but he throws out a suggestion which may be commended to the notice of men who, like the late member for Bridport, have money to leave, and are on the look-out for heirs. We have, as Lord Derby says, bequests of all kinds; and it would be a welcome sign that science had been made popular, even in a sense he would approve, if bequests of large sums to endow original research should come into fashion."

The *Daily Telegraph* says:—

"And here the speaker could not but touch on the question of the better endowment of scientific research, which he disposed of by heartily wishing that such benevolent people as give half a million to a charity, or to the Kirk of Scotland, would turn the stream of Pactolus upon the dry ground of natural science. There is no soil which would yield back more profitable harvests. A discovery in mechanics or physics benefits all mankind; and great investigations are undoubtedly kept in abeyance for want of the help which society does not, and the Government cannot, bestow. Lord Derby, indeed, expressed himself willing to advocate all that could be done in this direction by a Government; but his opinion is that the community must take up the question, if anything really large was to be hoped for, though something might, perhaps, be effected by the careful application of old endowments, upon which point the Lord Rector uttered some observations balanced so finely that a pinch of the dust of a 'dead founder' would turn his well-trimmed scales."

The *Globe* speaks as follows:—

"Valuable as were the hints suggested on what may be described as the conduct of intellectual life, still greater interest attaches to Lord Derby's observations on the subject of scientific research and University Reform. On the former topic scientific men have sometimes talked rather wildly of late, as if it were the duty of the State to provide an elaborate scheme for the endowment of science. Lord Derby did not accept this view; but he distinctly laid it down that the community has not yet realised the vastness of its obligations to science, and that, when it does so, much larger funds will be devoted to its encouragement than are now available. He also declared that, for his own part, he would not object to the State doing something to foster original research. These utterances will be eagerly fastened on by scientific men, but it may perhaps be questioned whether the difficulties in the way of definite action are not somewhat underrated. By what test would it be possible to select the men who should be supported for the purpose of extending the bounds of science? And if this difficulty were overcome, how could an assurance be given that the opportunities secured would be applied to the best advantage? Would it not be necessary to associate duties with the rights conferred on successful candidates? These and other obstacles may not be insuperable; but they will have to be thoroughly considered before a large additional expenditure is undertaken on behalf of science. Perhaps the best solution would be a generous endowment of scien-

tific professorships—by private liberality, if possible—in connection with which there would be teaching to some slight extent, but not so much as would interfere with work of a high kind."

According to the *Hour*—

"Perhaps that which will seem to English readers the most important part of Lord Derby's address is that relative to the importance of scientific research."

The *Scotsman* has the following:—

"Lord Derby does not know much about science, but he knows enough to have a clear view of the truth that 'science, in the strict sense of the word, can never be popular.' He also sees plainly enough that, as a consequence of this, science as a pursuit can never pay. Nothing in his address is more important or more just than his plea for the endowment of science, coupled as it is with an expression of his individual willingness that some aid should be given to science by the State. It is plain, too, that Lord Derby thinks that something might be got from our older endowments for this object, without doing injustice to anyone, living or dead."

The *Glasgow Herald* thus writes:—

"Scientific culture seems to command the largest share of Lord Derby's sympathies. Those who have the taste for the investigation of material objects 'have the satisfaction of knowing that while satisfying one of the deepest wants of their own nature, they are at the same time promoting, in the most effectual manner, the interests of mankind.' There is, in other words, the investigation of the unknown, and a service of utility rendered to mankind. Then, the charm of scientific studies to Lord Derby lies in their definiteness. The student is held down to the facts of nature; if he investigates them at all he must investigate them thoroughly. He knows nothing till he knows all that the facts reveal. Popular science is, to his mind, a misnomer. Science can never be popular, for its study involves leisure, careful industry, and patient waiting and watching. He is so convinced of the advantages of cultivating the study of nature that he would not be averse to a Government endowment."

It will thus be seen that public opinion, so far as we at present have been able to glean it, approves of the views expressed by Lord Derby; we cannot therefore doubt that Government will take an early opportunity of giving them practical effect.

#### AFRICAN HANDIWORK

*Artes Africanæ.* By Dr. Georg Schweinfurth. With twenty-one lithographic plates. (London: Sampson Low and Co., 1875.)

THE title of this work may perhaps be thought too comprehensive, the author having, wisely as we think, confined himself to the arts of the negro tribes visited by him in the vicinity of the White Nile between the equator and about 12° north latitude.

Africa may be divided into three regions, corresponding to the movements of trade. In the northern half of the continent where Islamism and firearms have penetrated, home-made goods have been supplanted by European commodities and the last traces of native industry threaten shortly to disappear. An intermediate zone in which the cotton stuffs of Europe are made the chief articles of trade intervenes between this and the interior, where European goods are unknown and native arts are found in their most primitive condition. It is to a portion of this latter region that Dr. Schweinfurth's work relates.

The tribes of the White Nile were first visited by Consul Petherick in 1857-8, and many specimens of their arts which were brought home by him have since been

dispersed. A considerable number have, however, since found their way either into the Christy collection, or into Col. Lane Fox's Anthropological collection at Bethnal Green, and have been described in greater or less detail. But with the exception of a brief account of the war weapons of this people which was contributed by Mr. Petherick to the *Journal of the United Service Institution* in 1860, including numerous illustrations, no original account of their native arts has been published until the appearance of the present work.

The tribes referred to in this volume are named Dinka, Dyur, Bongo, Mittu, Niam Niam, Bellanda, Monbuttu, Sere, and Kred, and as a rule the same types of art with innumerable but closely-allied varieties pervade the whole of them. Imitation of natural forms, that invariable characteristic of primitive arts, is not less frequent here than amongst other savages; thus we find amongst the Bongo, bells and rattles in imitation of leguminous fruits, and iron thorns upon the heads of spears, both named and copied from the Makrigga, a thorny shrub of the district which no doubt was used and served as a model for these barbarous weapons before the introduction of iron. Notwithstanding the prevalence of iron, the Mittu and some other tribes still employ an arrow with a hard wood point or fire-shaft in preference to the iron ones, which carry only one-third the distance although with greater accuracy of flight.

The partiality for doubling certain objects without in most cases the least practicable utility being perceptible is noticed by the traveller as a characteristic of Central African art. Thus we find double points to roofs, double pipe-bowls, double lance-heads, double spoons, and double bells included amongst the objects illustrated. The art of the carpenter, as with most savages, appears to be confined to carving household utensils such as seats, tables, dishes, boxes, mortars, musical instruments, canoes, &c., out of a solid block; the joiner's art seems almost unknown, the only exception here recorded being a sleeping-bench of the Monbuttu tribe, in which the framework of Raphia stalks is fastened to the feet by pegs of hard wood. One of those curious transformations so common in savage art is seen in the case of the broad mushroom-headed club, "Bollong." This club has been described by Mr. Petherick, amongst the Dor tribe, as a weapon for cracking skulls. The broad head, which is obviously a monstrous development of the ordinary club head, appears to have suggested its employment as a seat by sticking the pointed handle into the ground and sitting on the head. Accordingly we find that amongst the Dinka, Dyoor, Madi, and Gani, the upper surface of the head has been made perfectly flat, in order to adapt it to this new use, whilst at the same time preserving its efficiency as a weapon. The wooden parrying-stick or shield, "Kwrr," constructed of one piece with a hollow for the hand carved out in the centre, has been noticed by Mr. Petherick amongst the Mundo, and is here figured as a Dinka weapon. Its close resemblance to the Australian parrying-shield, Tamarang, and to one from an Egyptian tomb, now in the Louvre at Paris, has been noticed by Col. Lane Fox in his catalogue of his collection at Bethnal Green. Dr. Schweinfurth compares it to a specimen from the Pacific Isles now in the Berlin Museum. Should this turn out to be correct, and not a

mistaken locality, it will add another link to the area of distribution of this peculiar form of weapon. Parrying-sticks, without the hand hole, are undoubtedly employed in some of the Pacific Isles. The bow-shaped parrying-shield, "Dang," represented by Mr. Petherick, now in the Bethnal Green collection without a string, is here represented with a string attached, showing that although now used exclusively as a parrying weapon, it was without doubt derived from the bow, which it resembles, and that the curved ends have been retained for a totally different use from that which they served originally. The identity of this weapon with a Caffre implement figured in Wood's "Africa" is, however, doubtful, as it appears not unlikely the latter may be a musical instrument.

Several illustrations are given of the peculiar iron boomerang of the Niam Niam, here called "Pingah" but known as "Hunga Munga," or "Shanger Mangor," by the Musgu of Soudan, and Kulbeda in Upper Sennaar. The distribution of this class of weapon and its varieties has been traced by Col. Fox in his catalogue, where it is shown to be common to the greater part of the black races of mankind, including the Australians and the aborigines of Central India; but we have here some additional points of interest in connection with the African variety. We now learn from Dr. Schweinfurth that, like the Australian weapon, it is thrown by the Niam Niam, so as to rotate in a horizontal plane, which, though anticipated, has not been distinctly stated by former travellers. We learn also from this work that the wooden variety of this weapon, called "Trumbash," a name which is sometimes also applied to the iron variety, and which was first noticed by Sir Samuel Baker in Abyssinia, is in use amongst the Mohammedan negro tribes throughout the district between that country and Lake Tsad. This weapon, described as a flat two-edged projectile of wood, curved more or less sickle-like, and wider towards the point, is undoubtedly the original of the whole class, and from its resemblance to the Dravidian and Australian forms of it, affords one of several links which connect the arts of those black races of the southern hemisphere, which are supposed by Prof. Huxley, and by Prof. Haeckel after him, to have been derived from a now submerged paradise in the Indian Ocean.

To our knowledge of the iron-work of these tribes Dr. Schweinfurth also adds some important details, but it is remarkable that he should not have especially noticed the peculiar ogee-sectioned blade, sunk on alternate faces, which is such a characteristic feature of the iron implements of all Africa, from the Caffres on the south-east to the Fans on the west, and which, like the double bellows, connect them with the iron-workers of Sudia and Burmah. It is true that illustrations of this peculiar blade, so far as the shading enables us to judge, are given in the plate of Niam Niam spear-heads, but without comment. They are absent in the plate of Bongo spear-heads, and it would be interesting to know whether this is an accidental omission, or whether the Bongo form is in this respect an exception to the custom prevalent amongst other tribes of iron-workers.

The plates are well executed, and though not furnished with a scale, as is desirable in such works, the dimensions are given in most cases.

It might be suggested as an improvement to future travellers, that in the arrangement of the plates more attention should be paid to varieties, and that the several forms should be placed side by side according to their affinities. There is no point of so great interest to the scientific student of early culture as the allied varieties of form. As a rule with exceptions, it may be said that arts which are indigenous present greater varieties than those which are exotic, and hence the importance of studying minute differences, more especially in cases where, by means of gradual variation, transitions to other types or other uses may be traced. A few finished drawings are no doubt valuable in order to give a correct idea of the leading types; but for the varieties, outline drawings on a smaller scale in the style of the illustrations of "Demmin's History of Arms," are all that is needed, and enable these transitions to be given at a trifling cost. With these additions, and with due attention to such other matters relating to savage art as are suggested in the "Anthropological Notes and Queries," published by the British Asso-

ciation, we would earnestly commend the example of Dr. Schweinfurth to all travellers, for, as he truly says in his preface, "Hurry is needed: the destructive tendency of our industrial productions obtruding themselves upon all the nations of the earth menaces, sooner or later, to sweep away, even in Africa, the last remnants of indigenous arts." Of the utility of such a work as this no anthropologist or antiquary can doubt. There is, however, one remark of the author's to which we would draw special attention, and which he in this work reiterates with commendable emphasis:—"A people, as long as they are on the lowest step of their development, are far better characterised by their industrial products than they are either by their habits, which may be purely local, or by their own representations, which, rendered in their rude and unformed language, are often incorrectly interpreted by ourselves. If we possessed more of these tokens we should be in a position to comprehend better than we do the primitive condition of many a nation that has now reached a high degree of culture."

#### RECENT FRENCH EXPERIMENTAL PHYSIOLOGY

*Physiologie Experimentale.* Travaux du Laboratoire de M. Marey. (Paris: G. Masson, 1876.)

UNDER the auspices of the Minister of Public Instruction of France are published from time to time volumes of the "Bibliothèque des Hautes Études." The

work before us is one of these, and its value will be fully appreciated by any physiologist or physicist who has once glanced at its well illustrated pages. It contains several papers by M. Marey, mostly on points connected with the employment of the "graphic" method of depicting the magnitude and duration of dynamical phenomena both physical and physiological, and two by Dr. François-

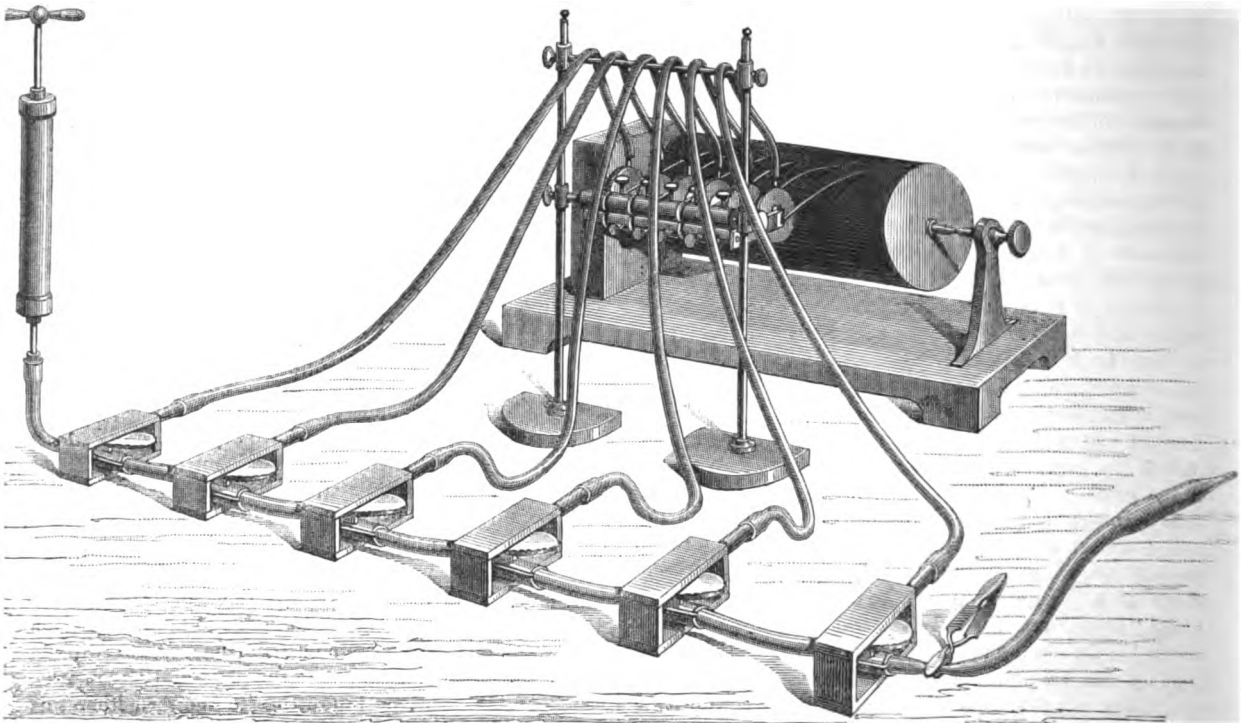

FIG. 1.

Franck on the anatomy and physiology of the vascular nerves of the head.

The most important of the memoirs by M. Marey is, in our estimation, that on "the movements of liquid waves, undertaken with a view of assisting in the theory of the

pulse." Of this we will give a short account on the present occasion.

M. Marey's extraordinary mechanical skill has enabled him to devise and construct an apparatus by means of which he has been enabled to represent synchronously,



by the graphic method, the moment of origin and the conformation of the wave produced in every part of an india-rubber tube distended with fluid. A glance at the accompanying figure (Fig. 1.) will indicate the method employed. The wave is produced by the movement of the piston of the pump at the left side of the figure.

It is transmitted along the continuous horizontal tube in the foreground, which is made to record the movements of six equidistant spots twenty centimetres apart, on the revolving drum, covered with smoked paper, in the background, by means of the delicate system of double "tambours," or elastic-covered drums and levers which have been introduced and so much employed by the author. The tubes connecting the tambours, being of the same material and of equal length, any error from irregularity in the rate of transmission along them is avoided. A pair of forceps, as in the figure, close the experimental tube just beyond the point of attachment of the last of the tambours.

When a positive wave, in other words, one of compression, is transmitted along this tube, thus arranged, it is seen that the levers rise one after the other, beginning at that nearest the piston; and that immediately the last one begins to rise, a second wave commences in the opposite direction. There is still more to be learnt from the curves recorded on the smoked cylinder, which are reproduced in Fig. 2, from an actual experiment. In this figure the six undulations are those of the six levers, the lowest being that of the portion of the tube nearest the piston, and the highest that of the furthest end. The trace of a chronograph vibrating fifty times a second is given below the lowest of the curves. Perpendiculars projected from the summits of each of the curves upon the chronograph trace would be separated by equal intervals if, during the different parts of its course, the rapidity of transmission of the wave were uniform. But it is seen from the figure under consideration that, although in traversing each 20 centimetres of the tube the wave takes about one-fiftieth of a second, and so travels at the rate of about 10 metres a second, nevertheless its rapidity is not absolutely uniform, being at its maximum at its orifice of entry, and after it has become slower again, slightly increasing in velocity in the neighbourhood of the closed end. There is therefore a double change in the velocity of the wave.

When it has reached the extremity of the tube the wave takes a reverse course, and returns through each of the recording drums to the place from which it started. This reflected wave is indicated by the down-turned arrows in Fig. 2; the direct one and its secondary companions having

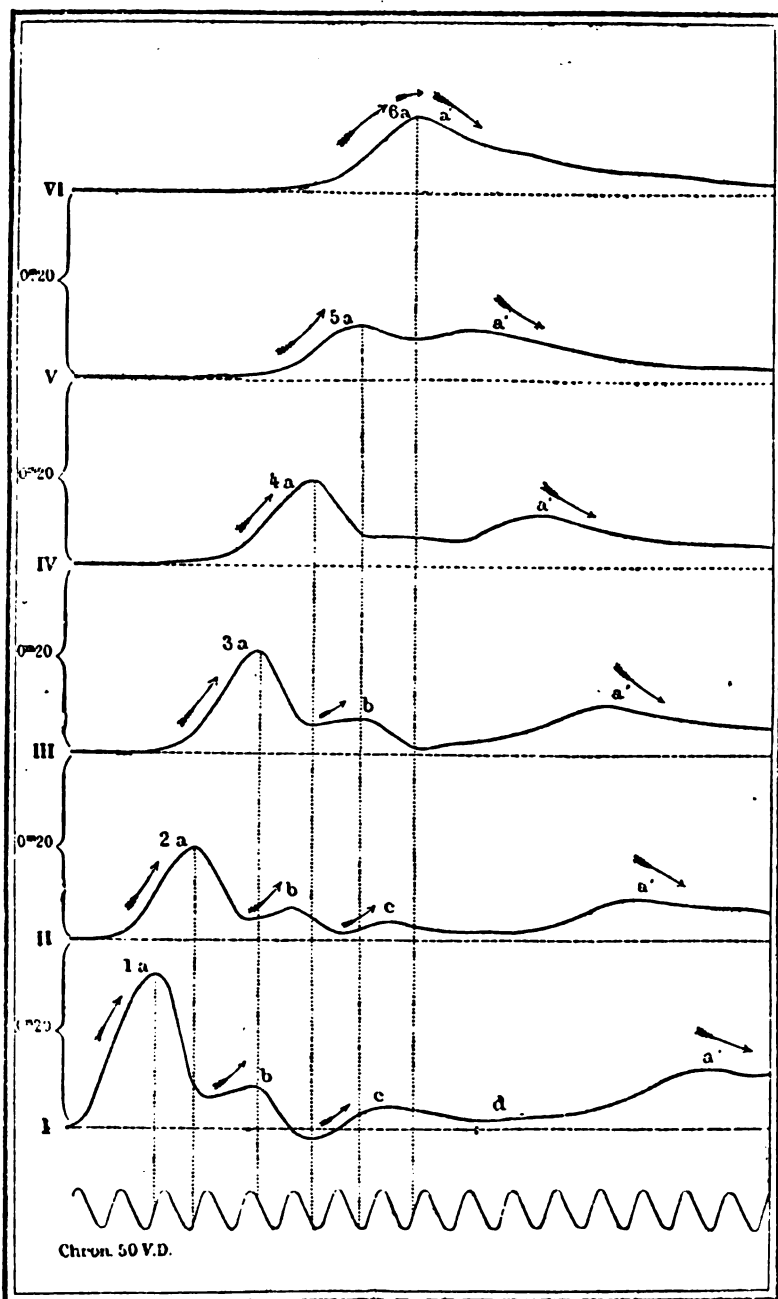

FIG. 2.

upturned arrows above them. By varying the distance of the occluding forceps from the last recording tambour the time of commencement of the reflected wave can be similarly varied.

It is interesting to observe that in a paper on the movement of the pulse-wave in the human arte-

ries,\* Mr. Garrod has shown that the pulse-wave augments its rapidity as it gets further from the heart, a result which is specially interesting in connection with those of M. Marey on the undulations in closed tubes, the blood system being similar in all respects.

With reference to the changes of the height of the undu-

augmentation in its rapidity. This depends on the elasticity of the tube, which tends to distribute the pressure in the different parts of the liquid column.

It will be seen from Fig. 2 that the primary direct wave is followed by a more or less numerous series of secondary diminishing minor waves. They are dependent on the rapidity with which the liquid is forced into the elastic tube. The reflected wave may also give rise to secondary undulations. The whole of the foregoing results are represented in a most vivid manner by the translation of their results stereoscopically or into a figure of three dimensions, represented in Fig. 3. We have never before seen results of a similar kind similarly depicted.

Among the other results arrived at by the employment of the same instrument, M. Marey has shown that *negative* waves, that is of absorption, obey exactly the same laws as do *positive* waves, or those of compression; also, in tubes opened at their distant end, if the aperture is large, no reflected wave is produced, at the same time that the intensity of the undulation diminishes from one to the other end, and its rapidity also gradually.

(To be continued.)

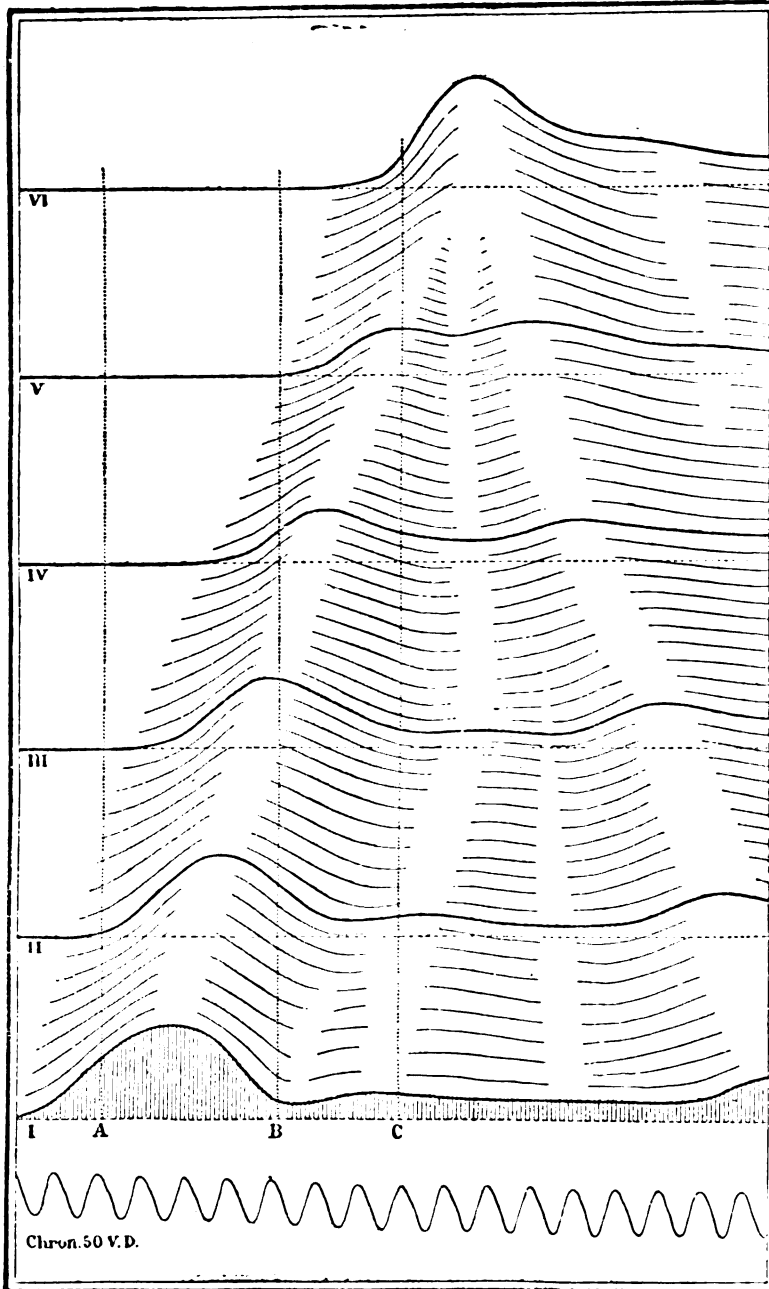

FIG. 3.

lation in different parts of its course, it can be proved that the wave has its maxima of intensity at its two ends, its minima in the intermediate part of its course. The wave also changes in form during its progress, this change consisting essentially in a diminution in its amplitude and an

valuable information conveyed, information in itself calculated to interest in a high degree any healthy mind, and which the compiler has had skill enough to put into shape without detracting from its interest.

While we congratulate the publishers on their successful attempt to elevate the quality of drawing-room litera-

\* "Proc. Royal Soc.," 1875, p. 150.

*THE ARCTIC WORLD*  
*The Arctic World: its Plants, Animals, and Natural Phenomena.*  
 (London and Edinburgh: Nelson and Sons, 1876.)

THE Messrs. Nelson have in the present work made a praiseworthy attempt at innovation on the usual style of drawing-room book; for that "The Arctic World" is meant mainly for the drawing-room table its whole appearance indicates. The work is something more than a mere picture-book, though its pictures are certainly a striking attraction. The compiler of the text has made an honest, and, we believe, remarkably successful, attempt to carry out the promise of the title-page, and present a satisfactory account of the physical phenomena, the plants, animals, people, and scenery of the entire round of the Arctic regions. There is really a great amount of solid and accurate and

ture, we also rejoice, in the interests of science, that they think there is some chance of such a work becoming a commercial success; for thus, in the judgment of practical men, there exists a considerable public who are able to understand, appreciate, and enjoy a work which is largely scientific in its character. This is an additional sign of the general advance in intelligence which has been going on in recent years, and of the fact that the results of scientific research are gradually taking a place in the public estimation of equal importance with the results of literary effort. We sincerely wish "The Arctic World" an extensive circulation; the publishers certainly deserve to be rewarded for the venture they have made.

Although the text is of substantial value, still,

the most striking feature in this beautifully got-up book is its pictures, which are most, if not all, of French workmanship, and are really beautiful in execution, with that touch of artistic exaggeration which the French manage to impart to the most commonplace woodcut. These pictures, upwards of 100 in number, render the work a most attractive one, and besides, of themselves, are calculated to convey not a little information concerning the Arctic regions, the varied life, animal and human, and scenery of which they represent with considerable fulness. They are in all respects so attractive, that they can be looked at over and over again without any diminution of interest.

In the first chapter the author points out briefly and

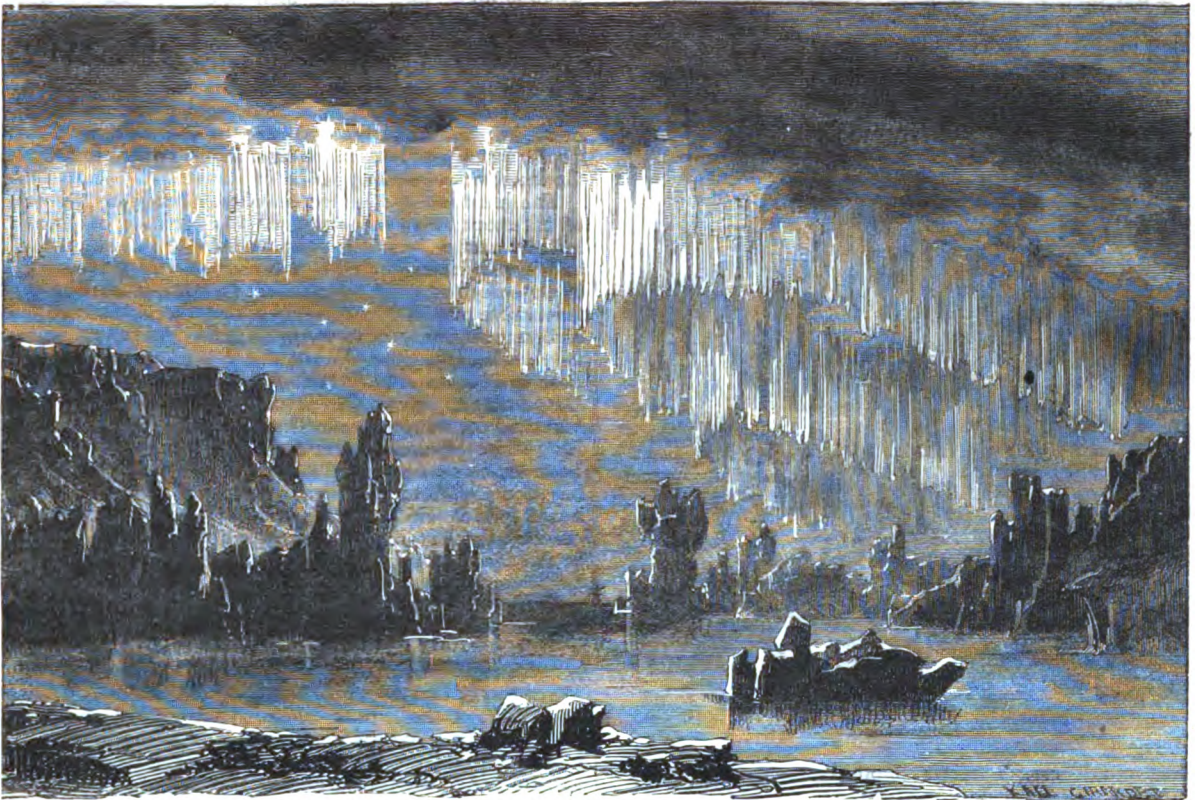

The Aurora Borealis.

forcibly the scientific and practical gains which may be expected from Arctic exploration, and which were fully set before the public in connection with the Arctic expedition, which no doubt is now upon or beyond the "threshold of the unknown region." He gives a short sketch of the geographical features of the Arctic region, of its surface in relation to snow and ice, and of the general character of life in the Polar World. In the second chapter an interesting account is given of some of the most striking phenomena of the region, the scenery, atmospheric phenomena, the aurora, and some of the most prominent astronomical features. The nature and formation of icebergs are pretty fully discussed in the next chapter, and the various forms of ice to be met with in the Arctic regions described; after which comes an interesting account of some of the

forms of animal life to be met with in the Polar Seas, and the methods of capturing it. Then follows a well-written account of the most trustworthy researches on the nature and formation of snow and ice in connection with the constitution and movements of glaciers. Vegetable life is described in Chapter V., as also the connections, habits, and uses of the principal land-animals and birds. A slight divergence is made in Chapter VI., in order to give a brief account of Iceland its scenery, its physical phenomena, and the life and character of the people; this chapter is written in a tone that Capt. Burton would probably think too highly pitched. In the three succeeding chapters the characteristics and mode of life of the various people who inhabit the Arctic regions are set forth with considerable

fulness. The Eskimo, the Lapps, the Samojeses, the Ostraks, the Jakuts, the Tungusi, the Tchuktche, the principal groups of people in short that inhabit Arctic America, Europe, and Asia, all come in for detailed notice, and that in a manner calculated both to interest and instruct. It is the same with respect to all the other matters referred to in the work: we are too apt when thinking of the Arctic World to limit the term to Greenland or Arctic America at most, forgetting how much more the term includes. In the present work the whole region within the Arctic Circle, all round, is included, and its various features, phenomena, and life described with greater or

avail themselves of the opportunity afforded by the "Notes of Travel" of again learning, from his own pen, other incidents in the short and far from uneventful career of the enterprising semi-Swedish traveller and fluent writer.

The posthumous "Notes" edited by Mr. Lloyd—who performed the same service with reference to another of Mr. Andersson's works, "The Lion and the Elephant"—contain, besides the descriptions of the habits of some few of the birds and animals of the districts in question, the account of the doings of the author during the last four or five years of his life, a period in which the political differences between the neighbouring South African tribes of Damaraland and Namaqua Land compelled him to devote more time to trade and the disputes which arose therefrom, than to geographical and biological research.

Not long after his marriage, in 1861, Mr. Andersson purchased of the Walwich Bay Mining Company, on the winding up of their affairs, their extensive establishment—Otjimbingue—in Damaraland, with the object of making it a trading station for cattle and ivory. In a war which arose between the Damaras and Namaquas Andersson found himself constrained to become the leader of the former; during this he sustained, from a bullet, a wound in the leg smashing the upper end of the right tibia and fibula, which was long in healing, and rendered him lame for the short remaining period of his life.

The great injury done to his trading operations, the loss of his stock, and the probability of further outbreaks, led the author, who was still suffering from his wound, and further incapacitated by repeated attacks of dysentery, in his enfeebled state, to entertain the idea of establishing favourable trading relations with the Portuguese settlers of Benguela, north of the river Cunené. With this object in view he left Cape Town, where he had spent some time on account of his health, in May 1866, once more for Damaraland. Namaqua marauders continued to harass him, and he started from Ondonga for the Cunené in May 1867. He reached that river in the middle of June; however, he never crossed it because of the bad treatment he received from the ferrymen and from his state of health, which will be best understood from his own note on the day following that on which he reached it. He died in the Ovampo wilderness, where he was buried by no one but a youthful and faithful attendant, Alex Ericson.

During his illness he spent much of his time in collecting the materials for a work on the ornithology of South-west Africa, a book which was to have been published in a profusely illustrated and otherwise costly form by Messrs. Day and Son. This important addition to our knowledge of the African avifauna the author never saw in print; but since his death it has been produced in a more unassuming form, under the able and careful editorship of Mr. J. H. Gurney, under the title of "The Birds of Damaraland;" now a standard volume of ornithological literature.

The notes on the habits and powers of the vulture will interest naturalists, as will the attempt to distinguish a second species of ostrich, said to differ from *Struthio camelus* in that the male bird is slightly larger, whilst the female is jet black, like the male, instead of greyish; and the young is of a sooty brown. *Machaerhampus anderssoni*, or Andersson's Porm obtained from Otjimbingue, is fully described, as are the Kori Bustard (*Eupodotis kori*), the Rufous-crested Bustard (*E. ruficrista*), Rupell's Bustard (*E. rupelli*), and a few other birds. Mr. Lloyd tells us in his preface that, among numerous papers, Andersson left behind him "Notices of several of the quadrupeds indigenous to Damaraland and the neighbouring countries." These it was his original intention to incorporate in the present work, but to preserve the continuity of the narrative they were, with the exception of a single chapter on the Leopard and its congeners, omitted, though not without hope that at some future



Kamschatkans.

less minuteness. The last chapter contains a brief *resumé* of the course of Arctic discovery.

The work altogether is one of the most interesting and trustworthy of its kind we have had the pleasure to come across; we do not know of any similar book which gives a more satisfactory account of the principal features of the Arctic World. Boys and girls we are sure would consider it a treasure; and to all old boys and full-grown girls who desire "something fresh" both to read and to look at, we can heartily commend it.

#### OUR BOOK SHELF

*Notes of Travel in South Africa.* By Charles John Andersson. Edited by L. Lloyd. (London: Hurst and Blackett, 1875.)

THOSE who are acquainted with the late Mr. C. J. Andersson's "Lake N'gami," "The Okovango River"—discovered by him—or any of his other writings, will gladly



time they may be submitted to the public, as we wish they may be.

In conclusion, we may remark that, with the exception of a few descriptions of personal symptoms, which would have been much better left out, Mr. Andersson's "Notes on Travel in South Africa" forms an interesting and instructive volume to the general reader, as well as the student of geographical and natural science.

### LETTERS TO THE EDITOR

[The Editor does not hold himself responsible for opinions expressed by his correspondents. Neither can he undertake to return, or to correspond with the writers of, rejected manuscripts. No notice is taken of anonymous communications.]

#### A New Cetacean from New Zealand

I HAVE just received from Dr. Julius Von Haast of Canterbury, New Zealand, for presentation to the Zoological Society, an account of what appears to be a new species of Ziphioid Whale.

As far as can be at present ascertained, for, unfortunately, the heads only of three individuals, and these not in a perfect state, were obtained, it is nearly allied to the genus *Mesoplodon*, *Gervais*, but differs from the known species in the possession of a row of small pointed, conical, recurved teeth, about twenty in number, in the hinder part of the upper jaw, in addition to the usual single large tooth, placed near the middle of the ramus of the mandible. This is a very interesting circumstance as connecting the peculiar dentition of the ziphioids with that of the ordinary dolphins.

Another fact, new in the history of the Cetacea of this group, is that they belonged to a shoal of twenty-eight, all stranded together on one of the Chatham Islands, whereas all previously recorded examples have been either solitary or in pairs. It is evident that the attention which the naturalists of New Zealand are paying to the Cetacea, will throw much light on the history of the order, and it is to be hoped that they will persevere in collecting and preserving every specimen which may come within their reach. Dr. Haast's paper will be read at the next meeting of the Zoological Society. W. H. FLOWER

#### Evidences of Ancient Glaciers in Central France

MY attention has been recently called to a communication on the above subject which appeared in *NATURE*, vol. xiii. p. 31, from Dr. Hooker. Not having myself observed any traces of glacial action in the Mont Dore, and finding that M. l'Abbé Lecoq, whose examination of every portion of the district was most painstaking and exhaustive, has declared his conviction that no such traces exist, may I be permitted to remark that the evidence produced by Dr. Hooker does not appear very conclusive on the question? It consists of the occurrence of some large fragments of trachyte in the floor of the valley in which the Dordogne takes its rise, "the head of which occupies a noble amphitheatre immediately under the highest summit of Mont Dore," which "seen from a height above, were presumably huts, haystacks, or glacially transported blocks." The next day the doctor descended into the valley for a fuller examination of these blocks, and found himself "amongst a group of magnificent boulders that had evidently been deposited (?) by an ancient glacier which had flowed from the rocky amphitheatre at the head of the valley;" "others were seen further down the valley, its stream meandering among the blocks."

Now this description together with all that follows, and which I need not quote, strongly reminded me of a large assemblage of *albris* of trachytic rocks which on my last visit to the Mont Dore in 1860, I observed exactly in the position indicated by Dr. Hooker in the valley of the Dordogne, and which had been the result of a prodigious landslip or fall of a huge slice of the cliffs above; nearly a thousand feet high, forming the left flank of the valley as we look up it extending for upwards of half a mile. This landslip had occurred, if I remember rightly, in the previous winter, and was by no means an unprecedented occurrence, as the ruins of several older "eboulements" along the same line of cliffs attested. The summit of the cliffs consisted of a solid bed of trachyte perhaps fifty feet in thickness, and the action of frost on the waters infiltrated into the vertical joints of this rock tended to detach occasionally blocks of it which in large num-

bers, and many of them of enormous size, had evidently fallen from above on the floor of the valley. Some of these bore exactly the appearance of those described and figured by Dr. Hooker, and with every deference to his high authority, I cannot but suspect that they are the identical rocks which he, somewhat hastily, perhaps, concluded could only have been transported by "an ancient glacier descending from the neighbouring head of the valley." Should this prove to be the case, as no other evidence of the action of glaciers in the Mont Dore has been produced, it is presumable that M. Lecoq's view is correct, that none such are to be found. G. POULETT SCROPE

Fairlawn, Cobham, Surrey

#### Science Classes and Penny Lectures in Birmingham

IN *NATURE*, vol. xiii., p. 82, is an article on "The Manchester Science Lectures," in which it is stated that the popular lectures at the Midland Institute Birmingham "are chiefly frequented by the middle classes," while "at the Manchester lectures the class of persons present was chiefly working men for whom the lectures were designed.

This statement, although not absolutely incorrect, conveys quite a false impression respecting the Birmingham lectures; the fact being that the Midland Institute has two Departments, the "General" and the "Industrial," the former being designed for the middle classes, and the latter for artisans, &c. As the history of the popular scientific teaching at this Institute includes some instructive practical experience, a few reminiscences of the leading facts may be interesting.

The Institute commenced its working existence in October 1854 with three classes, one for Physics meeting on two evenings per week, one for Chemistry also on two evenings per week, and one on Popular Physiology and the Laws of Health meeting on one evening per week. These were all conducted by myself—then the only teacher of the Institute—at the rooms of the old Philosophical Institution, 7, Cannon Street. They were attended by men and boys, for the most part artisans and *bona fide* students. The first course on Chemistry comprised about 90 lectures, that on Physics about 130, and that on Physiology about 30 lectures.

The number of students and the general success of these lectures exceeded the expectations of the promoters of the Institute, and refuted the predictions of the large proportion of influential Birmingham men who loudly expressed their anticipations of failure.

Such was the beginning, but ere long we were threatened with a repetition of the old experience of the old Mechanics' Institution, and other similar efforts that had failed in Birmingham, and upon which failures these gloomy predictions were founded. The Chemistry class, which was the largest at first, sustained its numbers and attendance during what I may call the combusive stage of its existence, that is, so long as the three oft-quoted essentials of successful chemical lectures "the flash, the bang, and the stink," were maintained; but when we came to the metals, to mere precipitates, equations, analysis, &c., the numbers seriously declined.

The Physics class, which began more modestly, kept up its numbers rather better; there, the progress was from the heavy business of statics and dynamics, to the more wonderful phenomena of heat, light, and electricity. The physiology class was the smallest from the first, but held on pretty steadily to the end of the course.

On completing the first course of each subject we encountered a check that threatened our very existence. The numbers diminished, and this diminution became alarming with the third course on Physiology (which commenced before that of the other subjects). The alarming element was not merely the diminishing number of students, but the obvious cause of this diminution. We were evidently exhausting our raw material. The total number of Birmingham artisans who desired the amount of scientific instruction we offered them was but limited, and the majority of these had attended the first courses, and in the ordinary progress of normal generation they were not reproducible with a rapidity at all corresponding to the repetition of our courses of instruction. What was to be done?

This difficulty of course presented itself more forcibly to me than to anybody else as the facts were more directly before my eyes, and naturally led to serious reflections. To have shortened the courses of instruction, to have made them lighter and more popular, would have sacrificed our main object, seeing that I had already gone as far in that direction as sound instruction permitted. What then?

My own early experience suggested a solution. Might I not deliver some well advertised public scientific lectures of a sufficiently light and sensational character to captivate the intellect by the natural bait of wonderment? If so, the systematic classes might be fed by their means.

My first idea was, considering the poverty of the Institute at that time, to charge twopence or threepence for admission to such lectures, but on communicating my scheme to Mr. Arthur Ryland, the Vice-President of the Institute, he improved it materially by suggesting that the charge for such lectures should be one penny, and that they should be called "Penny Lectures."

The Council assented to this, and on Jan. 22, 1856, I commenced the first course of Twelve Penny Lectures in the Lecture Theatre, Cannon Street.

The lecture theatre was crowded throughout the course, which served its intended purpose of supplying an outline of the grasp of Physical Science. This course was followed by others. I continued them every Tuesday evening during above nine months of each year until July 1863, when I left Birmingham. They were always well attended but with some degree of fluctuation. The smallest attendance was during a course on the Birmingham manufactures, and the best attendance when subjects connected with combustion, electricity, or my own travelling experiences were treated and well illustrated.

I do not at all presume to describe these lectures as nearly equal to the Manchester lectures that have been lately delivered. They were necessarily extemporised, as may be supposed from the fact that, with the exception of an occasional volunteer (four or five lectures per annum), I delivered them all myself, and at the same time conducted the Lectures on Chemistry, Experimental Physics, Junior and Ladies' Classes, and the Practical Analytical Class in the Laboratory, besides being compelled to supplement my very small salary by writing newspaper articles.

I mention this to show how much may be done by small means. The Institute was so poor at its beginning that I was obliged to fit the lectures to the small stock of apparatus we possessed, and lecture on whatever subjects I could best illustrate. The average outlay upon illustrating these early lectures did not exceed three or four shillings each.

Nevertheless their object was fulfilled. The Penny Lectures fed the Science Classes, which without such aliment would have been starved and extinguished in their infancy. Their success led to the establishment of the "Penny Readings" of the Midland Institute in 1857 or 1858, which were, I believe, the first of these entertainments that have since become so popular and so much degenerated. These again were followed by the Penny Arithmetic Classes and the other Penny Classes which have since formed one of the leading and most important features of good work done and doing in Birmingham.

The egotism of the above narrative will possibly be pardoned, seeing that the experiences of the early struggles of the Science Classes of the Midland Institute have been so often repeated where similar efforts have been made, and are likely to be continued so long as the prevailing inefficiency or total absence of scientific instruction in our primary schools remains. The success of these Penny Lectures, in spite of all their shortcomings, in creating a demand for more thorough instruction indicates an available means of rendering science classes successful in other places. My advice to all concerned in the promotion of such classes is that they should make no compromise in reference to the classes themselves, by attempting to bring in them the subjects down to the level of present requirements of the majority, but that instead of this, they should, by means of very popular, attractive, aye, even sensational public penny lectures, excite curiosity, and create an interest in science among those they desire ultimately to teach.

Being now in the confessional I may as well admit that I practised several small illegitimate devices to keep my audiences together, one especially copied from the young lady who occupied "the thousand and one nights," that of leading the subject up to some amusing experiment just at the end of the lecture, and then discovering that it was time to conclude, and therefore that the experiment must be shown next Tuesday. The small boys who occupied the front seats and applauded all the explosions soon found me out, but they came next week nevertheless, and some of these who at first were blue-fire pupils only, ultimately joined the classes and became satisfactory students. Therefore the Penny Lecturer should not be too rigidly regardful of his own scientific dignity, but Barnumise to some extent, when he can thereby advance towards the high object he seeks to attain.

"Should this meet the eye" of any disconsolate projector and manager of a failing Mechanics' Institution or similar effort, let him try Penny Lectures forthwith, not musical or dramatic lectures, but lectures on the most wonderful of natural phenomena, including as much scientific explanation as the audience can digest, and at the same time let him prepare to supply the solid class instruction for which such lectures should ultimately create a demand.

W. MATTIEU WILLIAMS

Belmont, Twickenham

#### Proposed Optical Barometer

I WAS led the other day to consider the possible effect of changes of barometric pressure on the ultimate destination of light passing through lighthouse refracting agents, and although I was satisfied that such changes cannot produce any effects of practical importance, the idea occurred to me that a glass prism might be used as a barometer. When a refracting prism is successively immersed in media of different refractive indices the ultimate angular deviation of the ray will, as is well known, depend in each case on the relative indices of the glass and the medium surrounding it at the time of the experiment. And as the refractive index of atmospheric air varies with its density, the amount of deviation of the refracted ray will be a measure of the density of the air, *i.e.* will give the means of ascertaining the reading of the barometer at the time.

If the ray of light were made to pass through a number of refracting and totally reflecting prisms the deviation would be increased. If with these prisms a microscope were combined the prisms might be used as a barometer. Or if the ray be received obliquely on a number of pieces of glass having parallel faces and slightly separated from each other, although there would be no angular deviation there would be horizontal displacement which would admit of being measured by a microscope. How far such an application would be of practical value is certainly doubtful, as the effects of changes of temperature on the prism itself might interfere with the very limited range of the instrument. Or again, it is possible that easterly, westerly, or other currents—or perhaps differences in the hygrometric state of the atmosphere—may affect the index of refraction otherwise than by the mere changes of density which they produce. But if such be the case, the refracting prism will be useful in determining the existence and amount of such variations in the refrangibility of the atmosphere.

Edinburgh, Dec. 13

THOMAS STEVENSON

#### Seasonal Colour in Flowers

THE "blue of the wild hyacinth" (see vol. xiii. p. 129) is anticipated by the yellow of the primrose, the daffodil, the marsh marigold, the coltsfoot, the lesser celandine (*Ranunculus Ficaria*), and especially the winter aconite. We may add as contemporaries the buttercup, the yellow deadnettle, and the cowslip. The furze blooms in autumn and winter, and the golden broom in spring; the dandelion and the groundsel flower during the greater part of the year. The "deep scarlet of our summer flowers," represented in Britain by the poppies and the pimpernel only, is accompanied by the no less vivid blue of the cornflower, the wild chicory, the viper's bugloss (*Echium*), whose blossoms change from red to blue as they approach maturity, the flax, and the various campanulas. I say nothing of white flowers; but it is worth notice that the hepatica, bugle (*Ajuga*), and milkwort (*Polygala*), vary to almost precisely the same shades of blue, white, and pink, at quite different seasons.

R. A. PRYOR

Hatfield, Dec. 17

#### Glands of the Cherry Laurel

THE nectariferous glands on the back of the leaf of the cherry laurel (vol. xiii. p. 107) are present also, I believe, in all the Drupaceae. The position is not in all cases the same; but when the glands are not found on the back of the leaf, they may be seen on the petiole. Ants may often be found drinking this leaf-honey; and I heard, two or three years ago, that the same attraction had brought many hive-bees to the laurels in a garden at Sidmouth.

E. H.

#### OUR ASTRONOMICAL COLUMN

VARIABLE STARS.—Nos. 2065-67 of the "Astronomische Nachrichten" contain another of Prof. Schönfeld's



important contributions to our knowledge of the variable stars, the eighth of a series commenced in No. 1628, ten years since. The observations discussed in the last communication were chiefly made in 1874, but there are also observations of several objects to the middle of the present year. In the comparisons of the observed epochs of maxima and minima with those calculated, the elements in Schönfeld's second Catalogue (Manheim, 1875), which should be in the hands of every observer of variable stars, have been employed, while in a few cases new elements are given.

Mira Ceti was at minimum 1874, Nov. 20 (mag. 8.6), and at maximum 1875, March 4 (mag. 2.5), the latter being about eight days later than is deduced from Argelander's formula of sines.—T Tauri, the star adjoining the variable nebula in Taurus (Hind, 1852), has exhibited irregular fluctuations between the years 1868 and 1875; previous to 1868 it had occasionally been as bright as 9.5, but according to Schönfeld's observations since that year, it has not been higher than 10.3, while at a maximum, 1871 Nov. 25, it was only 12.0, and at another very certain one, 1874 Feb. 10, it was 11.7. Schönfeld states that the nebula of 1852 was invisible in the Manheim refractor (6.5 inches aperture) during the whole period 1868-75, while the small nebula detected by Mr. Otto Struve immediately preceding this was only occasionally glimpsed. This spot requires to be closely watched with large instruments.—U Geminorum was satisfactorily observed at a maximum, 1874 Feb. 4 (mag. 9.6), 111 days after the preceding one; another maximum may be expected at the beginning of January next, or possibly in the last days of the present month; since the discovery of this star in 1855, it has shown variation of period between about 70 and 150 days.

R Crateris, the star following  $\alpha$ , which Sir John Herschel describes (Cape Obs., p. 448) as of "a most intense and curious colour," and "scarlet, almost blood colour," has exhibited during the last ten years a slight variation estimated from 8.2 to 8.9 mag., but the observations have not afforded any ground to assist in determination of elements.—S Virginis has been twice observed by Schönfeld at minimum viz., 1874, April 20 (mag. 12.5), and 1875, April 26 (mag. 12.4), which he believes are the first minima yet secured; at certain maxima this star becomes distinctly visible without the telescope (mag. 5.7).— $\chi$  Cygni attained a maximum 1874, Nov. 9, mag. 4.7, or about midway between  $\phi$  and  $\eta$  Cygni; this epoch is upwards of two months later than the date assigned by Argelander's formula in the Bonn Observations, vol. vii., but the extreme difference between the formula and observation appears to have occurred in 1870, when it exceeded three months; the star must be near a maximum at the present time.—R Vulpeculæ: the further observations support the addition of the term depending on E<sup>2</sup> introduced in Schönfeld's last catalogue; he remarks that a uniform period would involve differences from the observed epochs amounting to twenty-two days, while these epochs are uncertain to three days at the most.—S Pegasi. This star, detected by Mr. Marth at Malta, 1864, Nov. 24, when its magnitude was 8.3, was at maximum 1874, July 8 (mag. 7.3): it must not be confounded with the star which first appeared upon our list of variables as S Pegasi, the insertion of which probably arose from an error of observation. The position of the variable for 1876.0 is in R.A., 23h. 13m. 46s; N.P.D., 81° 48'.8.

The following are Greenwich times of geocentric minima of Algol according to the third elements of Schönfeld (Der Lichtwandel des Sterns Algol in Perseus. Manheim, 1870).

	d.	h.	m.		d.	h.	m.		
1875.	Dec.	24	15	7	1876.	Jan.	2	5	35
"	"	27	11	57	"	"	16	13	41
"	"	30	8	46	"	"	19	10	30
					"	"	22	7	20

The next maximum of Mira Ceti may be expected about January 17.

THE MINOR PLANETS.—M. Bossert has calculated elements of the small planet discovered by M. Paul Henry at Paris, Nov. 2, from which it appears the planet is not identical with No. 98, Dike, as surmised by Prof. Tietjen, and the actual number in this group, therefore, stands at 157. The best orbit of Dike is that of MM. Lœwy and Tisserand (*Comptes Rendus*, 1872, Feb. 19), and is subjoined with M. Bossert's for No. 152, for the sake of comparison.

	No. 98, Dike.	No. 152.
Longitude of perihelion ...	240° 35' 34"	80° 0' 3"
Ascending node ...	41 43 42	41 28 49
Inclination ...	13 53 18	12 10 13
Angle of eccentricity ...	13 47 30	4 42 59
Log. semi-axis major ...	0.446639	0.49582
Long. from equinox of ...	1868.0	1875.0

Circular No. 37, issued by Prof. Tietjen, contains ephemerides of Sylvia, Austria, No. 148 with elements from two months' observations, No. 150, No. 151 from elements founded on three weeks' observations, No. 152, No. 153, and No. 156: a circular orbit of the latter places the ascending node in 253° 52', with an inclination of 4° 42'.

COGGIA'S COMET, 1874.—Dr. Schmidt, Director of the Observatory at Athens, publishes the first portion of the results of his observations on the appearance of the great comet of 1874, between May 3 and July 23, when he believes to have glimpsed the tail for the last time. The observations refer to the brightness of the nucleus as viewed in the telescope, and of the head of the comet seen with the naked eye, the apparent length of the tail, and semi-diameter of the coma; the measures are not reduced to actual values, in the absence of a complete ephemeris from good elements. On June 9 and subsequently the nucleus was always remarked to be yellow, and the mean of its apparent diameters, given by Dr. Schmidt, would be, for the earth's mean distance, about 0.65, or 290 miles, as we find by taking the distance of the comet from the earth, deduced from one of the best parabolic orbits.

HUMAN ANATOMY AS A PART OF THE BIOLOGICAL CURRICULUM

WE would draw the attention of our readers to the following "minute" from Cambridge, dated Dec. 2:—"The Board of Natural Sciences Studies report that the study of human anatomy in the University is at a disadvantage in consequence of its not occupying a more prominent and definite position in the Natural Sciences Tripos. It is found from experience that medical students who are candidates for the Natural Sciences Tripos relinquish the study of human anatomy until after the examination for the Tripos, and many are therefore deterred from making the attempt to obtain a degree with honours. Further, the more distinct recognition of human anatomy in the examination for the Tripos cannot fail to elevate the character of the teaching and study of it in the University as a branch of science, especially as it is contemplated by the Board that the subject of human anatomy shall include the mechanism of the human body, the comparison of its parts with those of lower animals, its development, &c. In proposing this addition to the subjects of the Natural Sciences Tripos it is not intended to add to the number of subjects with which students are expected to be acquainted; but the subjects represented in the examination are now so numerous and extensive that they have become practically, to a large extent, alternative, and the additional subject would, it is thought, prove attractive to a large number of students. The addition would also help to maintain the connection between the schools of Natural Science and Medicine.

The two days allowed for the examination in practical work in the second part of the examination is scarcely sufficient, and as the number of candidates increases, more time will certainly be required. The Board recommends some alterations in and additions to the regulations for the Natural Sciences Tripos, which will accomplish the object it has in view."

The Biological Schools of the older Universities, on account of their recent origin, are still in a far from settled state. Men who have had a previous education in some other medical school enter as undergraduates, and on more than a single occasion these have had the opportunity of demonstrating to the less highly educated of their year how great is the value of a knowledge of human anatomy, and how excellent a scientific training it forms.

The Board of Natural Science Studies at Cambridge mention as the first claim in favour of the greater stress which it desires to lay on anatomy, that medical students suffer from its omission, and are tempted to delay their special work. We are not among those who believe that the Universities will ever form good medical schools. The advantage of the University curriculum is that it prolongs the higher education through the period during which the mind is acquiring its reasoning powers, and, as a result, tends to strengthen these by continually varying the material to be reasoned on. Except as far as the production of teachers of the subjects it inculcates are concerned, it has not, and ought not to have, any direct ulterior objects in view. If medicine is to be specially studied we see no limits to the extension of the subjects embraced within it. The practice of medicine by most is hardly more than a trade, and why, as such, it should be more highly favoured than any other special training it is difficult to understand.

The arguments in favour of making human anatomy a part of the biological education are of a very different nature, and are insuperable. The study of zoology may be commenced at either end, with the simplest protozoa, or with a foundation of human anatomy. Both of these have their advantages. A glance at the previous education of those who are, at the present day, devoting themselves to the subject, shows that almost all who commenced it after having mastered human anatomy, have devoted themselves to the vertebrate sub-kingdom; whilst those who have commenced without any or with but little knowledge of anthropotomy, have taken to the invertebrata. The intricacy of the higher forms, and the standard of comparison afforded by the structure of the human frame, naturally leads to a comparison of this with those of its closest allies, and consequently places the vertebrata in a more favourable position for investigation. It also helps to develop a greater interest in human anatomy from the light thrown on it by those of less elaborate organisation.

The student who commences with the lowest sub-kingdoms has to acquire his training as well as his facts from the simpler forms, amongst which there is so little correlation that he is led to lay little stress on that general uniformity of type which seems to him to detract from the interest of a group apparently presenting so little variety among its different members.

Under the existing system, therefore, the tendency of the University education is to develop invertebrate rather than vertebrate zoologists, and this condition is capable of being modified in the direction of improvement by the introduction of human anatomy into the biological curriculum; for then those who take up such subjects might have the opportunity of acquiring the knowledge of vertebrate anatomy to an extent which would place them in a position that would prevent them from laying themselves open to the correction, by any anthropotomist, of their otherwise shallow information on vertebrate structure.

As to the character of the human anatomy which is

required by the student of biology, it is a mistake to suppose that it is exactly that needed by the surgeon or medical man. In almost all manuals of the subject great stress has to be laid on relational anatomy, because this is the aspect of the subject required by them. Nevertheless a very fair and biologically valuable knowledge of the structure of the human body can be acquired without any necessity for so much time being spent in the mastery of the exact relations, through the whole of their course, of vessels and nerves. A thorough training in osteology, the disposition of the various viscera and nerve centres, and the structure of the organs of sense, together with a comparatively slight acquaintance with the exact course followed by each nerve, artery, and vein, is all that is required by the majority of comparative anatomists. Upon such a basis any special regional relationships might be mastered in a short time with but little difficulty, and if the student afterwards commenced a medical training, he would do so on a footing of peculiar advantage.

The latter part of the report above quoted attracts attention in another direction also. From it we learn that "the subjects represented in the examination are now so numerous and extensive that they have become practically to a large extent alternative." This we very much regret, and we are convinced that this tendency in the direction of the system adopted at Oxford will be as little satisfactory as it has proved in that University. It has the effect of turning out a number of narrow specialists, instead of, as it ought to do, starting the student in some definite direction with a fund of general information, which he will find invaluable after he has taken his degree.

#### THE BIRDS OF THE PELEW ISLANDS \*

THE eighth part of the "Journal des Muséum Godeffroy," which has been lately issued at Hamburg, contains an interesting article upon the Birds of the Pelew Islands, from the pen of the well-known ornithologist, Dr. Otto Finsch, of Bremen. This group of islands, until recently almost unknown to naturalists, has of late years been visited by several collectors in the employment of the House of Godeffroy, who have transmitted to Europe full series of specimens of its natural productions. Dr. Finsch, in conjunction with Dr. Hartlaub, has already published various notices of these collections, and given descriptions of several new and most interesting species which they contained. The present memoir gives a *résumé* of the previous articles, and adds a complete account of all that is yet known concerning the ornithology of this far-removed group of islands. The total number of species of birds as yet ascertained to occur within their limits is fifty-six, of which twelve are peculiar to the group, and are not known to be found elsewhere. Perhaps one of the most remarkable facts connected with the ornithology of the Pelew Islands is the occurrence of a Jungle Fowl (*Gallus bankiva*)—being the species generally recognised as the original of our domestic fowl—in a wild state. It is possible, however, that this may be an introduction. It is singular also to note that the Nicobar Pigeon (*Caloenas nicobarica*) has spread thus far to the west. Noteworthy again is the entire absence, so far as is hitherto known, of parrots and finches in these islands. Dr. Finsch's excellent text furnishes complete details upon these and other points of interest, and contains full authorities for the occurrence of all the species attributed to the avifauna of the Pelew Islands. Five well-executed coloured plates give illustrations of some of the rarer species and adorn the work. Of the physical features of these islands an account has already appeared in a former number of the same journal, together with an excellent map of the group.

\* "Zur Ornithologie der Südsee-Inseln." I. Die Vögel der Palau-Gruppe. Von Dr. Otto Finsch in Bremen. "Journal des Muséum Godeffroy," Heft viii., 1875.

THE VOYAGE OF THE "CHEVERT" TO NEW GUINEA

MR. WILLIAM MACLEAY, of Sydney has, in a letter to the *Sydney Herald*, given an account of his expedition to New Guinea, an abstract of which, though so small in its results, will no doubt interest our readers.

The *Chevert* sailed from Port Jackson on the 18th of May last with a crew of twenty, together with a doctor, four zoological and three botanical collectors, Captain Onalow, and Mr. Macleay. The ship was fitted up chiefly with the object of making collections in all branches of Natural History in the islands of Torres Straits and in New Guinea.

The voyage from Sydney to Cape York occupied a month, five days being spent in the Palm Islands, and six at Cape Grenville. On the 4th of June a stoppage was made at Brookes Island, and on the next day on the north-west of the North Barnard Isles, in the latter case with the object of getting a species of *Ptiloris* peculiar to the island, and Mr. Masters was so fortunate as to procure a male and two female specimens in the course of the afternoon. The next stage was Fitzroy Island, where a few birds were obtained; but much progress was prevented by the dense brushwood, which was also found in Palm Island.

On the next day the *Chevert* anchored off a low wooded sandbank, marked on the chart "Low Wooded Isle." It was surrounded by an extensive coral reef, the first seen on the voyage. They afterwards reached Turtle Keef, opposite the Endeavour River, passing a belt of country on the mainland which looks very promising. A belt of low land near the coast was backed up by steep hills of about 2,000 feet elevation, the whole densely wooded, with numerous landlips, showing a dark red soil. On June 8th, Number 4 Howick Group was reached, after passing a mainland which consisted, for a long distance back, of bare sandhills with elevated patches, forming Capes Bedford, Flattery, and Lookout. The next stage was Flinders Island, near which the land is very rough and rocky. Two days took them to Cape Grenville, where they supplied themselves with water. The weather being stormy and wet, not many specimens were procured. The land in the neighbourhood is the most barren that can be imagined. The rock is a kind of metamorphic sandstone, with sometimes a sub-horizontal stratification, quite vertical on the hills, with sharp laminated edges. The vegetation is scanty, the lower hills being clothed with coarse grass, dwarf grevilles, &c.; the higher ranges being thinly clothed with acacias, banksias, and pandanus; the declivities and gullies alone being densely wooded; whilst near the water's edge the mangrove predominates. The natives are tolerably numerous, and for Australians above the average, well grown and developed. They know a little English, can appreciate tobacco and biscuits, and are good workers. They adopt the practice of cutting the ear-lobe into thin strips, as do the natives of Cape York, the islands of the Torres Straits, and New Guinea.

On the 18th of June, after sailing through Albany Passage, the *Chevert* anchored in Mud Bay. The settlement of Somerset, of which some years ago the Government had hopes, has proved unsuccessful, except as a pearl fishery, on which occupation about 700 men are employed. The fishing-ground lies almost entirely to the west of Cape York, and extends from Endeavour Straits and the Gulf of Carpentaria northwards to the very shores of New Guinea. Diving dresses are much employed in the fishery.

The vessel was detained in Mud Bay till June 26th for the Sydney mail. Not much collecting-work was accomplished in the densely-wooded, but *passure* neighbourhood, which is entirely composed of a very hard ferruginous sandstone. She then took a course due north to Warrior Island, a distance of sixty miles, stopping off the Sue Islands, where the anchorage is perfectly covered with masses of the young pearl shells. Warrior Island is a mere sandbank of small extent, and without vegetation; but it is the birthplace and home of the strongest, most numerous, and most adventurous of the races inhabiting the Torres Straits, who closely resemble the inhabitants of New Guinea.

On June 28th the *Chevert* proceeded on its course to New Guinea, making for the entrance to the Katow River. They dropped anchor  $1\frac{1}{2}$  miles from the mouth of that river, and the village of Mohatta. The following morning they were visited by two canoes with about twelve men in each. In one was Maino, the head-man of the village, in the other Owta, the head-man of a village three miles further west. They came on board with the utmost confidence, though they could never have seen so big

a vessel before. It was explained to them, through interpreters, that the visit was a friendly one, with no other object than the collection of specimens; both Maino and Owta expressing a desire to assist, and inviting the crew ashore. Shortly afterwards twenty-two of the men landed in the fishing and surf boats, and were received at the village by the elder members of the tribe seated in a circle upon a large piece of new matting. They would not join in the company and participate in the smoking; those forming the circle consequently arose, perhaps not the best pleased.

The village consists of seven houses, exactly like those described by Jukes in the voyage of the *Fly*. Each house is ninety or 100 feet long, elevated about 6 feet from the ground, and covered with a thick thatch. The ends are open, and on each side are the sleeping places of the inmates. Each house holding about 50 people, so the population of the village must have been about 350. The houses are built near the sea, and are everywhere surrounded by mud, filth, and stench. The people are powerful and well made, jet black, with straight foreheads and Jewish noses, the projecting jaws of the Australian being absent. The hair is woolly, but grows in small tufts, which, when long, form close, compact ringlets; and it is not uncommon for the people, not here only, but at Warrior and Darnley Islands, to cut off their hair when thus grown into ringlets, and convert it into a wig for their own use. The men are quite naked; some being marked like the Australians with seams on the shoulders, all cutting the lobes of their ears into fantastic shapes and piercing the rim all round, and ornamenting it with coloured wool or fibre. They seem fond of ornaments of birds' feathers for the head, and necklets of pearl-shell. The women are kept from the view of strangers, but they are in no way beautiful. They are the hewers of wood and drawers of water. Their clothing is a scanty loin-covering, with ornaments of cassowary feathers round the knees and ankles.

Almost the only weapons of defence are bamboo bows and four-feet arrows. They use kava, said to be obtained some distance up the country. They are great navigators, their canoes, of great size, being formed of excavated trunks of large coral trees (*Erythrina*). Their supply of animal food is chiefly from pigs, which, both wild and tame, are numerous.

The appearance of the country is the same everywhere. In some places the mangrove seems to grow out into the sea; in others, as at Mohatta, there is a beach closely belted by coconut palms, and behind, everywhere the same absolutely level mud flat, without the slightest apparent rise as far as the eye can reach, and all densely covered with trees of all sizes and kinds, never reaching more than three or four feet above the sea and river level. The driest spots have been selected by the natives for their banana and taro plantations. They also cultivate yams, sago, and bread-fruit.

All efforts to penetrate the jungle proving ineffectual, an attempt was made to navigate the river in a steam launch and surf boat. At its mouth the Katow is about 200 yards wide, rapidly narrowing to 60 yards, and soon to 30 yards. For the first two miles Mr. Macleay and his party, accompanied by Maino and Owta, passed through a dense forest of mangrove, beyond which the river was edged by a palm nearly 50 feet in height. Behind these was the lofty and interminable forest. After ascending the river for between eight and nine miles they were abruptly stopped by a tree of great size which had fallen, or been felled, across the river. They had to return in order to obtain instruments for removing the obstruction. As they in this however never succeeded, they had to return to Warrior Island, whence they made for Darnley Island, at which place some successful dredging was accomplished. This they left on Aug. 13 for Hall Sound, on the east side of the Gulf of Papua, which they reached after much difficulty from adverse winds. The ship's captain declined to go further on this account. Yule Island forms the sea face of this Sound, and the opening on the north side between the island and the main is merely a shallow sandbank. The anchor was dropped close to the north-west point of the island, opposite the residence of Signor D'Albertis, the enthusiastic Italian naturalist, which can be seen perched on the side of a clear hill, about 100 feet above the water. Signor D'Albertis had established himself on Yule Island some months previously, in this his second expedition to New Guinea, and though, as Mr. Macleay tells us, he has encountered serious difficulties from the desertion of most of his men, the loss of his boat, and robbery by the natives, he still persists in holding his ground and prosecuting the object of his wanderings—the collection of objects of natural history. Assuredly if pluck, per-

severance, and determination can command success, Signor D'Albertis ought to be successful.

The island is about six miles long, picturesque, and healthy-looking. The soil is rich, and the plantations of the natives are numerous. The geological formation consists entirely of a calcareous sedimentary rock, containing numerous remains closely resembling recent forms. The appearance of the opposite shore of New Guinea is very different from that at Katow. Mangrove swamps are intersected by salt-water creeks, with low ranges of well-wooded open forests behind; beyond which the country seemed to become very rough and mountainous, with a stupendous mountain chain, on a clear day distinctly visible from the magnificent peak of Mount Yule on the west, to Mount Owen Stanley on the east. The natives of the country hereabouts are light-coloured, of medium size and active. Their hair is not woolly, and is generally worn long, being tied up in a chignon behind. They do not use tobacco, but chew the betel leaf. They wear a very tight belt, carrying a small piece of cloth. They seem to be timid and inoffensive, greedy and thievish. The women appear to be the rulers, and they are far from reticent in the presence of strangers. Some of the younger ones are tolerably good-looking; they wear showy loin dresses, and are tattooed about the breasts and belly. Their villages and houses are clean, and generally on sloping ground; they have a house in every village for the reception of guests; their mutual relations seem most friendly. They pay considerable attention to cookery, and manufacture pottery, cloths, and nets of excellent quality.

Mr. Macleay remained on Yule Island until Sept. 2, collecting and exploring. No Birds of Paradise were obtained, although many plumes were seen in the hands of natives. No Tree Kangaroo nor Cassowary was seen. He then, on account of adverse winds, returned to Cape York, and so terminated this unsuccessful attempt to explore New Guinea.

It may be mentioned that Dr. James, the surgeon, Mr. Knight, one of the botanists, and Mr. Pollard, one of the taxidermists from the *Chevert*, have undertaken an independent expedition to New Guinea on their own account, which though so much more unassuming than the one above described, may on that account have greater chance of success.

### NOTES

DR. GEORGE BENNETT, of Sydney, has been in correspondence with Signor D'Albertis, the Italian naturalist now residing on Yule Island, off S. E. New Guinea. From him we learn that Sig. D'Albertis is on most friendly terms with the islanders; that he has made several excursions on to the main land, though in so doing he has been much delayed on account of his boat having been stolen by four of his own men. He afterwards, however, managed to purchase a canoe, and has visited five villages, the language of the natives of which he can now speak pretty well. On the coast he finds a fauna and flora much resembling North Australia, but inland, on the mountains, the Papuan vegetation predominates. He has succeeded in obtaining a perfect specimen of his new bird of paradise, *Paridisa raggiana*, and has shot a second specimen of the ground tree-kangaroo, *Dorcopsis luctuosa*. His health is excellent; but an Italian companion has suffered from fever and slight sunstroke.

LIEUT. CAMERON has earned a high place as an explorer by the work which he has so successfully and so quietly accomplished. It will be remembered that Cameron was sent out in 1873 to find Livingstone, whose fate was then unknown. On his way to Tanganyika he learnt the fate of the great traveller, but continued westwards and determined to carry out an exploration on his own account. After surveying a great part of Lake Tanganyika and discovering what he thought was likely to prove an outlet to the westward, he proceeded to the Lualaba for the purpose of finding out whether that river is connected with the Congo or the Nile system. The latest news that Sir Henry Rawlinson had to announce in his address to the Geographical Society about a month ago was that at the end of May 1874, Cameron had finally left Ujiji for the West. The telegrams just received are very brief, and announce that he came out at

Benguela and reached Loanda on Nov. 19, with fifty-seven followers, "all well." Cameron was forced by adverse circumstances to abandon the Congo route, and followed the water-sheds between the Zambesi and Congo. He has thus accomplished the rare feat of marching right across the continent, and will no doubt bring home many additions to our knowledge of central tropical Africa.

THE Professorship of Physiology in the University of Glasgow will be vacant at the end of the present session on account of the resignation of Dr. Andrew Buchanan.

WE have received from Prof. Mohn, Christiania, a printed paper giving a brief *résumé* of the meteorology of Norway for 1874. Monthly results of temperature are stated for forty-one stations, and of rainfall for thirty stations, and these results are compared with averages of previous years for those stations at which observations have been continued for some time. These forty-one stations show an increase in the number of the stations of previous years, and we have much satisfaction in learning that, as the result of a recent special grant by the Norwegian Government, the stations have still further increased to fifty, and that each of them has been furnished with minimum thermometers and with new thermometer screws. Of the stations sixteen are supplied with Fortin's barometer, sixteen with the Kew barometer, thirty-one with wind-vanes and velocity-plates, thirty-seven with rain-gauges, thirty-two with dry and wet bulb hygrometers, nine of the coldest stations with hair hygrometers, and all of the fifty with aneroids. In Prof. Mohn's energetic and able hands highly valuable results may be looked for from these changes and additions in the further development of the meteorology of Norway, which plays so prominent a part in the meteorology of Europe.

THE *American Naturalist*—the recognised organ of intercommunication between naturalists in America—will pass, at the commencement of the coming year, into the hands of Messrs. H. O. Houghton and Co., of Cambridge, Mass. It will still be under the able editorship of Dr. A. S. Packard, jun., who will be assisted by a number of eminent men of science, in all departments. Indeed, the list of expected contributors for 1876 is a very strong one. The amount of matter in each number will be increased, and articles will be introduced of a more popular character than heretofore. We are glad to take this opportunity of again calling the attention of English naturalists to this excellent periodical.

M. DUMAS, the distinguished Perpetual Secretary of the French Academy of Sciences, has been elected a member of the Académie Française in room of the late M. Guizot. Science has now two representatives amongst the grantees of French literature—M. Claude Bernard and M. Dumas.

SIR HENRY RAWLINSON, President of the Geographical Society, has been elected a foreign member of the Geographical Society of Paris.

THE *Pall Mall Gazette* is informed that Mr. Max Müller has been asked to accept a professorship at Florence, at the highest salary ever offered to a professor in Italy.

A TELEGRAM dated Adelaide, the 18th inst., states that Mr. Giles's exploring expedition (see vol. xii. pp. 135, 194), fitted out by the Hon. Thos. Elder, M.L.C., has arrived at Perth, Western Australia, direct from Adelaide. This is the third expedition that has crossed Central Australia within the last two years. The first was that under Col. Warburton, from the telegraph line westwards, generally between 20° and 21° S. lat.; then Mr. Forrest crossed from Perth to the telegraph line by a route about 5° farther south. Mr. Giles's route, we believe, has been much farther south than Mr. Forrest's; judging from previous news, probably about 100 miles from the south coast.

A TELEGRAM from Naples, Dec. 19, states that Prof. Palmieri reports from the observatory near Vesuvius that fire has appeared in the interior of the crater, and expresses his opinion that an eruption of long duration may be expected. A volume of black smoke rose from the volcano on the morning of the 19th. A telegram of the 20th states that the fire in the crater is gradually increasing in strength, and that the instruments of the observatory are in motion.

A REUTER'S telegram of Dec. 21 states that the New York papers publish advices from Porto Rico stating that the town of Arecibo in that island had been wholly destroyed by an earthquake. Only two churches and six houses are stated to be left standing.

DURING the recent heavy floods, the low-level districts of Somersetshire have been submerged beyond precedent, so that it has been possible to sail across country for twenty miles. Many farms and cottages had to be abandoned, and for the first time the railways beyond Bridgwater were covered with several feet of water. One of the results of the flood was the driving from their haunts of great numbers of rats, some of which might have been seen by railway passengers to have taken refuge in willows and other trees along the line. Deserted houses were also taken possession of. In one case a labourer, on proceeding to his cottage by boat to obtain some necessary articles, was about getting into the bedroom window, when he found the room swarming with starving rats, whose demonstrations were so threatening that had he not made a hasty retreat there was every probability he would have been eaten up alive.

THE third annual dinner of the students of the Royal School of Mines took place on Friday the 19th inst., at the St. James's Hall Restaurant. In spite of the unavoidable absence of many who had expressed their intention of being present, the students, associates, and professors mustered to the number of nearly sixty.

A COMMITTEE was appointed some time ago by the Geographical Society of Paris to arrange for the erection of a building for its special use. A large sum of money has been collected, partly by loans, partly by private subscription and grants from the Society. Further proceedings have, however, been stopped, the Prefet of the Seine having intimated his intention to erect an establishment in which several of the learned societies of Paris are to have meeting rooms and libraries, and in which collections will be located at the expense of the city.

A *Daily News* telegram announces that the Italian Geographical Society has resolved that its exploring expedition to equatorial Africa shall start at the end of next January, so as to reach Ankober, the capital of the Kingdom of Shoan, before the rainy season. From Ankober, the expedition will penetrate the Galla country, in a south-west direction, towards the Victoria Nyanza Basin. Subscriptions for defraying the expenses will be received by the Italian Geographical Society in Rome.

THE Admiralty have made arrangements with Mr. Allen Young, the experienced Arctic voyager, to communicate with the entrance of Smith's Sound in the summer of 1876, in hopes of obtaining some information of the proceedings of the Arctic expedition.

IN Nos. 2 and 3 (1875) of Guido Cora's *Cosmos*, just to hand, is the first instalment of a paper, by Giacomo Bove, giving an account of a journey to Borneo; Sarawak and Labuan were visited, and an ascent of Kini Balu is described. In continuation of the papers on recent expeditions to New Guinea a useful *résumé* of our knowledge of the island at the end of 1875 is given; there are also letters from Beccari, D'Albertis, and L. Cambiaso of the *Vettor Pisano*. Two maps illustrate these New Guinea papers.

IN accordance with the will of Prof. Jungken, of Berlin, the *London Medical Record* states, his collection of scientific works and all his surgical instruments have been presented by his widow to the Augusta Hospital, and a letter of thanks has been sent to her by the Empress Augusta. The Royal Saxon Academy of Sciences at Leipzig has also received a donation from the late Dr. Hermann Härtel of 30,000 marks, to be expended in helping German students to prosecute scientific inquiries. -

AT the annual meeting of the Eastbourne Natural History Society on the 8th ult. the Secretary read a satisfactory report. The President, Mr. F. C. S. Roper, announced that ninety-one additions had been made to the fauna and flora of the district during the year.

IN the form of a supplement to the December number of the *Journal of Botany*, Mr. W. B. Hemsley publishes an "Outline of the Flora of Sussex," a list of all Phanerogams and Vascular Cryptogams known to occur within the county, with their authorities.

THE *Garden* announces an addition to its attractions in the form of a "coloured plate (full-page size) of a beautiful or rare flower or fruit, of proved value for our gardens, and executed in the best style of art." The aim is to illustrate, as nearly as may be in their natural colours, the finest of new flowers and fruits. The specimens which we have seen are really beautiful, and the enterprise deserves encouragement.

M. H. GIFFARD has reported on the Paris balloon accident to which we referred last week. He finds that during the process of inflation the net and the canvas got frozen together, the consequence being that during dilatation of the latter, the net could not yield freely, and therefore exerted pressure on the canvas, which broke suddenly near the valve. Precautions will be taken in future to prevent a similar occurrence.

AN examination will be held at Clare College, Cambridge, on March 28 and three following days, when a scholarship in Natural Science of the annual value of 60*l* for two years will be offered for competition. Particulars by application to the tutor, the Rev. W. Raynes. A Natural Science Scholarship at Caius College, of the same value, will be offered for competition on April 4. Particulars from the Rev. N. M. Ferrers, tutor of Gonville and Caius College.

THE Cambridge University Natural Science Club commenced the October Term by the formation of a new code of rules. The officers for the term were—President, A. J. Jukes Browne, B.A.; Vice-president, J. F. M. H. Stone; Hon. Sec., A. F. Buxton. Six papers have been read during the Term, usually followed by interesting discussions—"On the evolution of fossil forms," by A. J. Jukes Browne, B.A. (St. John's); "The motion of glaciers," by T. W. Bridge (Trinity); "Darwin's Insectivorous Plants," by J. F. M. H. Stone (St. Peter's); "Huxley's classification of animals," by A. F. Buxton (Trinity); "'Typical' number of somites in arthropoda," by A. M. Marshall, B.A. (St. John's); "Molecular energy," by E. B. Sargant (Trinity). There were sixteen members in residence.

THE fourth number of volume ii. of the Cincinnati *Quarterly Journal of Science*, edited by S. A. Miller and L. M. Hosea, has lately been issued, and, we regret to learn, closes the series of this publication. During the short period of its existence it has been the medium of presenting a number of original scientific papers especially relating to the palæontology of the Mississippi Valley, which will render it a necessary work of geological and zoological reference.

A ROMAN Society has commenced excavations quite close to the monument of Minerva Medica. They have come upon some very interesting things, among which are the paintings that

adorned a columbarium. The Roman archaeologists and artists believe that these paintings are of the Augustan age, and are of great value both to science and art. In making preparations for constructing the central hall in the Conservatory Palace at the Capitol, a ground-plan has been discovered supposed to be that of the Temple of the Capitoline Jupiter, to which Dionysius gave a surface of 4,000 square feet. In the same place has been found a column of large size, which appears to belong to the Temple of Jupiter Optimus Maximus. Excavations in other places have brought to light additional fragments of antiquarian interest.

THE Secretary of the Interior, in his annual report to the President of the United States, commends in high terms the work of the Geological and Geographical Survey of the Territories, and presents the following brief summary of the results for the season of 1875:—The survey under Dr. Hayden continued its labours of the two preceding years in the Territory of Colorado. The field of work during the past season was the southern and western portions of said Territory, and including a belt, fifteen miles in width, of the northern border of New Mexico and the eastern border of Utah. The survey was divided into seven parties, four of which were devoted to topographical and geological labours, one to primary triangulation, one to photographic work, and one to the transportation of supplies. The survey of the southern and south-western portions of Colorado has been completed, so as to make six sheets of physical atlas, designed by this Department, leaving unexplored only the north-western corner thereof, which can be surveyed by a single party during the coming year. The districts explored in the past season were not so mountainous as those of the previous years, but were quite remote from settlements, and in perhaps the most inaccessible regions of this continent. The total area surveyed is about 30,000 square miles, portions of which were very rugged. Much of this area is drained by the Colorado river, and is mainly a plateau country cut in every direction by deep gorges or canons, the sides of which show, for geological investigations, admirable sections of the strata forming the earth's crust. The topography of the district surveyed was elaborated in detail by the aid of the plane-table. The exploration of the remarkable prehistoric ruins of Southern Colorado, glimpses of which were obtained the preceding season, was continued with great success. They were traced down the canons to the Colorado river in New Mexico, Utah, and Arizona, and their connection established with the cliff cities of the Moquis of the latter Territory. Hundreds of cave-dwellings, of curious architecture and many miles from water, were found in the sides of the gorges, and the ruins of extensive towns discovered in the adjacent plains, indicating the former existence of a people far more numerous and advanced in the arts of civilization than their supposed descendants of the present day. Of these ruins many interesting sketches, plans, and photographs were made, and a valuable collection of flint weapons, earthenware and other specimens, was gathered. The materials thus obtained will enable the survey to present an exhaustive report on this interesting subject. The photographer of the survey obtained a series of mountain views on plates twenty-four inches long by twenty wide, or larger by several inches than any landscape photographs ever before taken in this country.

A FRENCH clerical journal, quoted by the *Revue Scientifique*, maintains that the tolling of the church bell is of much greater efficacy than the use of lightning-rods in warding off the effects of a thunder-storm, and advises the faithful to resort to the former means in preference to the latter.

THE *Revue Scientifique* announces the death, at Zurich, of the chemist Prof. E. Kopp, "one of the creators of the atomic theory."

THE Institution of Naval Architects has issued a list of subjects on which communications are desired.

THE American Institute of Mining Engineers held a meeting at Cleveland, Ohio, October 26–28. Its proximity to several of the large iron and steel works and the interest taken by its President, Prof. A. L. Holley, in the details of the Bessemer process, caused the meeting to be more especially devoted to that class of subjects. Prof. Holley in his opening address referred to several improvements which ought to be made in the iron and steel manufactures. Among the papers of scientific interest relating to mining subjects was a mention by Mr. Charles A. Ashburner of the discovery of coal-beds in the Vespertine sandstone of Pennsylvania. Mr. Ashburner is one of the assistant geologists of the Second Geological Survey of Pennsylvania. There have been a few scattered instances of discoveries of coal in the Vespertine rocks, and such beds have been designated as false coal-measures. The present discovery may, however, serve to modify our notions as to that sub-carboniferous formation. In a tunnel passing through Sideling Hill, Huntingdon County, Penn., in cutting the Vespertine sandstones, there were found not less than nineteen beds of coal; their thickness varies from one to thirteen inches; collectively they would make a thickness of four feet. The coarseness and false bedding of the Vespertine strata indicate a period of frequent agitation and numerous local currents; but the presence of coal-beds shows that considerable spaces of repose must have intervened, and that the changes were slowly effected.

AT the meeting of the Norfolk and Norwich Naturalists' Society, on Nov. 30, the Secretary read a short paper from Dr. Lowe on the occurrence of a rare microscopic fresh-water Alga (*Clathrocystis aruginosa*, Hen.) at Anmer, near Lynn. In June 1870 Dr. Lowe discovered a large quantity of it in the lake at Sandringham in the form of a green scum. In October of the present year he again discovered it growing in a pond at Anmer, two miles from Sandringham, his attention being attracted by the peculiar scum which he at once recognised as *Clathrocystis*. It seems probable that it has recently been introduced at Anmer by the agency of wild fowl.

THE additions to the Zoological Society's Gardens during the past week include a Haste's Apteryx (*Apteryx hastes*) from New Zealand, presented by Baron Ferdinand von Muller; a Marginated Parrakeet (*Tanygnathus marginatus*) from the Philippine Isles, presented by Master Hugh Sutton; two Bengal Leopard Cats (*Felis bengalensis*) from Cashmere, presented by Mr. W. A. Cuthell; a Bay Antelope (*Cephalophus dorsalis*) from W. Africa, received in exchange; an Ocelot (*Felis pardalis*) from S. America, a Hoffmann's Sloth (*Choloepus hoffmanni*) from Panama, a Duck Falcon (*Falco anatum*) captured at sea, purchased; a pair of Peacock Pheasants (*Polypectron chinquis*) from Burmah, deposited.

### SCIENTIFIC SERIALS

*Jahrbücher für wissenschaftliche Botanik*. Herausgegeben von Dr. N. Pringsheim. Band x. Heft II.—In the present number of Pringsheim's well-known and valuable year-books there are four papers, all of them of considerable interest. The first is by Dr. J. Reinke, of Göttingen—Contributions to the anatomy of the secreting organs, occurring especially on the serrations of certain foliage-leaves. It has been observed that in many plants the serrations of the leaves act as glands and secrete in many instances a mucilaginous substance, and in others resin, or a mixture of mucilage and resin, called blastocolla by Hanstein. Reinke has carefully examined the structure of these secreting organs in a large number of dicotyledonous plants, but has not made any exhaustive micro-chemical investigation of the secretions themselves. His observations show that the serrations of the leaves of Dicotyledons are in general the bearers of peculiar organs of secretion, whose activity may cease even while the leaf is in the bud, or at a later period. *Asculus* and plants with



spiny leaves apparently have no such secreting organs. In respect to the secretion itself, it is in the bud either a fluid mucilage or resin, while in the full-grown leaf it is only a watery or somewhat mucilaginous fluid. The paper is illustrated by two plates, on which are figured the glands of *Prunus avium*, *Kerria japonica*, *Vicia faba*, *Betula alba*, *Corylus avellana*, *Eonymus japonicus*, *Ribes multiflorum*, *Epilobium Dodonai*, *Catalpa syringifolia*, *Clerodendron fragrans*, and *Viola odorata*.—The second paper, on the process of fertilisation in the Basidiomycetes, is by Dr. Max Reess. Every day renders it more and more probable that the receptacles, or fruit-bearers, of the Basidiomycetes are, like the sporocarps of the Ascomycetes, the result of the fertilisation of a carpogonium. The researches of Reess now under consideration, those of Van Tieghem, and lastly, those of Dr. Eduard Eidam, in the *Botanische Zeitung*, 1875, p. 649, all tend in the one direction, and lead us to look with very great caution on the results obtained recently by Mr. Worthington Smith, and published in the *Gardener's Chronicle* for October. Reess has examined the early stages of *Coprinus stercorearius*, Bulliard, which develops rapidly, and could be easily obtained. The ripe spores of *Coprinus stercorearius* are ellipsoidal in shape, pointed towards each pole, and average eleven mic. mill. long by six mic. mill. broad, having a brown epispodium. Germination begins by the protrusion of the endosporium in the form of a colourless papilla at one, rarely at both, the poles of the cell. The process is a rapid one, and at the ordinary temperature of a room occurs in from four to five hours after sowing. The mycelia rapidly develops and branches frequently, so that in three or four days the mycelia from a single spore will form a patch from 14 to 2 mill. in circumference. At first the mycelium is formed of a single much-branched cell filled with colourless homogeneous protoplasm, numerous vacuoles forming in the older parts as branching proceeds. At the end of the second day numerous transverse walls appear in the mycelium, and a little later the hyphæ are seen to anastomose. In from three to four days after the germination of the spores, special bearers of minute rod-like cells appear. They are more or less long cylindrical cells with protoplasm, and they bear at their ends, or sometimes at the side, the short, straight rod-like cells. These grow until they have attained a certain length, then they divide, and the upper one drops off, a process which may be repeated two or three times, so that at about the end of two days, when the entire protoplasm of the bearers has disappeared, the process stops, and then the bearers themselves may fall off. When this occurs a little pile of about fifty to sixty rod-like cells may be noticed. These rod-like cells might be confounded with conidia, but further observation has shown that they cannot germinate, and there is now no doubt whatever that they are spermata, and therefore male cells. The youngest stage of the fruit-bearer is a thick, more or less irregularly-shaped hypha thread, densely filled with protoplasm, and resembling the earliest stage of the carpogonium of *Asrobolus*. The next stage is the fertilisation by means of the spermata which attach themselves to the branching sacklike structure, and as the spermata at once lose their contents, the empty wall contrasts strongly with the protoplasm of the carpogonium. After fertilisation the carpogonium becomes more and more tortuous and branched. The spermata of *Coprinus* are therefore male cells; their bearer the antheridium, while their function is the fertilisation of the carpogonium. As a consequence of fertilisation the carpogonium develops into the fruit-bearer of the fungus. The process described by Reess will thus be seen to have a very close resemblance to the fertilisation of the Floridææ, such as *Nemalion* and *Batrachospermum*.—The third paper is on the "Germination of the spores of *Gyathus striatus*, Willd., one of the Gasteromycetes," by Dr. R. Hesse, with one plate. The spores germinate by the protrusion of the endosporium at one, rarely at both, poles, a single hypha thread three or four times the length of the spore being formed. Transverse walls then appear, and the free end of the thread separates into a number of small cells, but the further history of these minute cells has not been studied.—The fourth and last paper in this number is "On the development of certain flowers with especial reference to the theory of Interposition," by Dr. A. B. Frank, with three plates. The author gives the results of his researches on plants belonging to the natural orders Papilionacææ, Geraniacææ and Oxalidacææ, Malvacææ, and Primulacææ. Many important observations are made in reference to the order of succession of the parts of the flowers, the development of diplostemonous flowers, and of flowers with superposed stamens. The paper is however not one that can be usefully abstracted. Altogether this number of

Pringsheim's *Jahrbuch* maintains its well-known high standard of excellence, and is well illustrated.

The first part of the twenty-fifth volume of Von Siebold and Kolliker's *Zeitschrift für Wissenschaftliche Zoologie* (Nov. 1874) contains an article of 100 pages by E. Ehlers, of Erlangen, on the vertical distribution of the marine chaetophorous annelids, based on the specimens secured in the *Porcupine Expedition*. In the same article is included M. Claparède's report on the chaetophorous annelids brought home by the *Lightning*. The forms are carefully described, new species are added, and the results are excellently tabulated. It is concluded that all the families of polychaetous annelids which are known as littoral inhabitants on the Atlantic coasts of Europe, excepting the Telethuseæ and Hermellidææ, are represented in the deep-sea fauna; that beyond the littoral region a greater or less depth does not influence the character of the annelid fauna; that temperature influences it just in the same manner as temperature influences the littoral annelids. Four very excellent plates, chiefly of annelid appendages, are given.—Karl Möbius gives a detailed account of the anatomy of the Rotifer *Brachionus plicatilis*.—Dr. F. C. Noll describes *Kochlorine hamata*, a new genus and species of boring Cirripede, boring into *Haliotis* and other shells, differing from *Cryptophialus* and *Alcippe* in lying free in the artificial cavity in the shell, and in other important particulars.—The second part (March 1875) opens with a contribution by W. Repiachoff to the embryology of *Tendra zostericola*.—Prof. Ranke describes minutely the supposed organs of hearing in *Acridium cerulescens* and the eyes of the leech.—Dr. Claus describes the shell-glands of *Daphnia*, identifying them with the segmental organs of annelids, and with the kidneys of vertebrates.—Dr. H. Dewitz writes on the structure and development of the sting and the ovipositor in several common Hymenoptera and the Grasshopper, which he calls *Locusta viridissima*, instead of using the generic name *Gryllus*.—O. Bütschli contributes some "preliminary observations" on the first steps of development in Nematodes and Snails.—Dr. von Willemoes-Suhm's third letter from the *Challenger* concludes the number.—The third part (May 1875) contains as its *pièce de résistance* a very valuable memoir, by Dr. C. Claus, on the development, organisation, and systematic position of the Argulidææ. *Argulus foliaceus* is the species chiefly described, both in its development and adult state. Dr. Claus concludes that it is useless to describe a distinct species of *Argulus* for every fish on which it is parasitic. It is established that *Argulus foliaceus* is parasitic on a great variety of fishes, also on toads and tadpoles, and even on the Axolotl. It appears that *Argulus* reproduces itself not only in early spring but also in summer and autumn with great freedom. For many reasons Dr. Claus places the Argulidææ among the Copepoda, and constitutes them a sub-order under the name Branchiura.—Dr. L. Stieda describes the structure of the central nervous system of Axolotl; the brain he asserts to be of a more completely embryonic type than any whose structure has been carefully examined.—E. Metschnikoff describes the early development of *Geophilus*. He finds that its larva differs from those of Chilognathous Myriopods in having its yolk-mass inside instead of outside the alimentary canal.—Oscar Grimm gives an account of the results of his dredgings in the Caspian Sea last year, resulting in the discovery of eighty new species.

*Zeitschrift der Oesterreichischen Gesellschaft für Meteorologie* Nov. 1.—Dr. Hann contributes an article on the meteorology of the Punjab, founded on the reports made by Mr. Neil for 1871, and by Mr. Calthrop for 1872.—Prof. Buys Ballot gives a table showing the tension of aqueous vapour at eighteen places in Russia for each month. It appears that at all stations the tension is below the average from November to April, and above it from May to September, and at some places in October. The influence of height, latitude, longitude, and proximity of the sea is plainly indicated by the table.

*Journal de Physique*, October.—In this number M. Penaud describes some researches on aviation, and apparatus for mechanical flight, for which a prize was recently awarded him by the Paris Academy.—Some experiments by M. Moreau are given as showing that a fish with swimming bladder undergoes variations of interior pressure, and that it adapts itself to different heights not by a mechanical action exercised on the bladder by means of its muscles, but by changing the quantity of air contained in the organ.—The penetration of electricity into badly-conducting substances has been sufficiently demonstrated, but there is still a good deal of confusion as to the mode of its action. M. Neyreneuf here endeavours to give precision to ideas

on the subject. He finds, *inter alia*, that in the case of a compound insulating plate between two armatures, the electrification of the two extreme plates is the same as that of a single plate (*i.e.* positive on the side of the positive armature, negative on the side of the negative), and the *persistent* electrification of the intermediate plates is also the same; but at the moment of separation these plates may appear positive and negative on both their faces.—M. Righi contributes a mathematical note on the laws of electromotive forces, and there is the usual amount of matter abstracted from other serials.

## SOCIETIES AND ACADEMIES

### LONDON

Royal Society, Dec. 9.—On the Development and *Lepas fascicularis* and the "Archizoëa" of Cirripedia, by the late R. von Willemoes-Suhm, Ph.D. The author shows that the *Archizoëa gigas* of Dohrn is the nauplius of *Lepas australis*, a form closely allied to *L. fascicularis*. The life history of the latter is described.

Preliminary remarks on the Development of some Pelagic Decapoda, by the late R. von Willemoes-Suhm, Ph.D. The genera described are *Amphion*, *Sergestes*, and *Leucifer*. The first passes through a true Zoëa stage, *Amphion* itself being, as Dohrn has shown, adult. The larvæ of *Leucifer* and *Sergestes* pass through an *Amphion* stage. The form *Elaphocaris* of Dohrn is proved to be the larva of a *Sergestes*. The form *Erichthina* of Dana is proved to be the larva of a *Leucifer*.

Dec. 16.—On the Structure and Development of the Skull in the Batrachia, by W. K. Parker, F.R.S. The author makes some corrections in his memoir on the skull of the frog, specially showing that the hyoid arch does not coalesce with the mandibular. The skull of *Dactylethra* and *Pipa* are described. The indications of vertebral segmentation in the cephalic part of the notochord are demonstrated in a manner which has much theoretical interest in relation with the theory of Goethe and Oken.

On the development of the spinal nerves in Selachians, by F. M. Balfour, B.A. The author shows that both the roots of the spinal nerves arise as outgrowths from the involuted epiblast of the neural canal, the posterior first, and by the more complicated process.

Chemical Society, Dec. 16.—Prof. Abel, F.R.S., president, in the chair.—Dr. C. R. A. Wright read a paper by himself and Mr. G. H. Beckett, on narcotine, cotarnine, and hydrocotarnine (Part iii.), in which the authors brought forward experimental evidence of the constitutional formula for hemipinic acid, opianic acid, and meconin.—Dr. H. E. Armstrong then gave an account of researches by Mr. Harrow and himself, on the action of alkaline sulphites on the haloïd derivatives of phenol, and on the action of nitric acid on tribromophenol.—Mr. E. Nelson subsequently made a communication on the sebates of the alcohol series, after which papers were read by the Secretary, on the compounds of ether with anhydrous metallic chlorides, by Mr. P. P. Bedem, and observations on variations in the composition of river waters, by Mr. J. Andrews.

Royal Astronomical Society, Dec. 11, 1875.—Prof. Adams President in the Chair.—Mr. Burton read a paper on the Southern nebulae 30 (Bode) Doradus and the nebulae about  $\eta$  Argus. Mr. Burton had while stationed at Rodriguez on the Transit of Venus Expedition made drawings of these nebulae with a 12½ inch silver on glass reflector, and on his return had compared them with Sir John Herschel's drawings. After a careful comparison he was not disposed to think that there had been any great change in either of the nebulae since the date of Sir John Herschel's observations.—Mr. Ellery, of the Melbourne Observatory, described the observations which they had made of the same nebulae with their great Melbourne 4-foot reflector. He was inclined to think that rapid change could be traced not only in the details of the nebulae but also in the relative positions and magnitudes of the stars which appeared to be involved in them.—Mr. Ellery also read a paper on the results of some experiments with Huygen's parabolic pendulum for obtaining uniform rotation. The instrument he had used consisted of a heavy weight or bob attached by a thin flexible band of watch-spring steel to the upper part of a piece of metal cut into the form of the evolute of a parabola. This was attached to the upper part of a revolving axis so that the contrivance formed a conical pendulum, in which when the rate of motion was increased the bob or pendulum flew away from the axis and wound the watch-

spring band round the evolute of the parabola. He found that with this contrivance a very uniform rate of motion was obtained, and it seemed to be independent of the weight which was placed on the bob of the pendulum and of variations in the driving power used.—A paper by Mr. With on the structure of Coggia's Comet was read. On the night of the 8th July, 1874, an oscillatory motion of the fan-shaped jet in front of the nucleus was observed. The fan seemed to tilt over from the preceding towards the following side and then for an instant appeared sharply defined, then it became nebulous and all appearance of structure vanished. These pulsations and appearances of structure occurred several times at intervals of from three to eight seconds.—Mr. Ranyard read a paper on the duplicate structure of Coggia's Comet. He showed two drawings each made on July 14, 1874, the one by Mrs. Newall with the great refractor at Gateshead, and the other by Mr. With at Hereford. Both drawings showed that on that evening there were two faint parabolic arcs, which intersected one another in front of the nucleus. The axes of the arcs were parallel to one another, and were separated by a distance of about 1°. During the earlier evenings of July the parabolic arcs within the envelope of the comet had been drawn by several observers as double and overlapping, but the axes of the two sets of parabolic arcs were much less separated than those of the arcs visible on the evening of the 14th. Mr. Ranyard suggested that possibly a disruption was going on similar in character to the disruption which took place in Biela's comet as it approached perihelion in 1846.—Father Perry showed some photographs of the transit of Venus which had been sent to him from Manila. They appeared to show the body of Venus projected on a bright background outside the sun's limb. It was suggested, however, from other evidence, that the photographs must have been taken from drawings. Lord Lindsay and Mr. Brothers, after an examination of the photographs, both inclined to the latter view.

Meteorological Society, Dec. 15.—Dr. R. J. Mann, president, in the chair.—William Ellis, F.R.A.S., Kaufmann J. Marks, Thomas Read, and Philip Wright, F.C.S., were elected Fellows of the Society. The following papers were read:—On the registration of sunshine, by R. H. Scott, F.R.S. This paper is on the continuous record of sunshine and rainfall obtained at Kew for September 1875; the latter by Beckley's rain-gauge, the former by a method originally proposed by Mr. J. F. Campbell, of Islay, F.G.S. This consists in the use of a sphere of glass to concentrate the sun's rays, and a strip of cardboard is placed on a frame concentric with the sphere and distant from it by its own focal length. The sun when it shines burns a hole in the cardboard, the length of the trace being regulated by the duration of the sunshine. It remains to be proved whether such a record is of real practical value, as it affords no measure of the heat of the sun.—On the rainfall at Calcutta, by R. Strachan. These observations were made at the Office of the Surveyor-General, and extend over a period of twenty-eight years, *viz.*, from 1847 to 1874. The most rain falls in July, but the heaviest downfalls are most frequent in June, and heavy downfalls are more frequent in August than in July. The greatest number of days of rain is in July, but the number is almost the same for August. December has the least frequency and amount of rain. The dry season includes November to April, during which on an average 6.04 inches of rain fall, on 12 days out of 181, or 1 out of 15 days. The wet season is from May to October inclusive, during which 61.60 inches of rain fall, on 84 days out of 184, or about 1 in 2 days. There is therefore ten times as much rain in the wet season as in the dry, and nearly seven times as many rainy days. The mean annual rainfall is 67.64 inches on 96 days.—On the use of the rotatory thermometer (*Thermomètre fondé*) on board ship, by R. H. Scott, F.R.S. This paper showed that the mean of 76 days' observations made by Capt. Heggum, of the *Rozelle*, on a voyage from Liverpool to Calcutta only differed by  $-0^{\circ}.4$  from the mean of the observations made in the ordinary way.—On the moon's influence in connection with our extremes of temperature, by George D. Brumham.—Mr. Scott exhibited a complete set of instruments, with thermometer screen, &c., as used at the Russian meteorological stations.

Anthropological Institute, Dec. 14.—Col. A. Lane-Fox, president, in the chair.—Mr. M. J. Walhouse read a paper on the belief in Bhutas—devil and ghost—worship in Western India. Although the lower castes and classes in India acknowledge and reverence the Brahminical gods, their familiar household cultus is much more especially addressed to inferior super-

natural beings analogous to the evil spirits, devils, ghosts, and goblins of European superstition. According to Hindu doctrine there are ten classes of such beings, the first seven of which are demons created aboriginally with the world or by acts of the higher gods on whom they wait as attendants or servants receiving some share of their worship, and avenging any omission or neglect of ceremonies due. Though not invariably, they are for the most part evilly-disposed towards human kind. But the last three classes of whom the paper more particularly treated, are exclusively of human origin, being malignant discontented individuals, wandering in an intermediate state between a heaven and a hell, intent upon mischief and annoyance to mortals, chiefly by means of possession and wicked inspiration, every aspect of which ancient ideas as well as of the old doctrine of transmigration they exemplify and illustrate. They are known by the name of Bhūta. The author went on to show how most of the evils and misfortunes of life were attributable to the Bhūta influence; death from violence, evil possession, diseases in families and in cattle, stone throwing, &c. He then described the priestly use of those supposed powers, the cure of diseases, the conduct of festivals, and dances. It was also pointed out how close was the similarity between the occurrences under Bhūta influence and the prevalence of a belief among European nations in witchcraft, demoniacal possessions, "levitations," ghosts, invisible powers, dancing manias, and the like. The Bhūta embles and ceremonies were also described and compared with those of the Todas and other hill tribes. The paper contained accounts of several well authenticated trials consequent on Bhūta interference and punishment. A series of Bhūta (Turanian) gods was exhibited by the author as illustrative of the wide difference between Turanian and Aryan art.—Mr. Groom Napier read a paper on the localities whence the tin and gold of the ancients were derived; and a paper by Mr. Bertram F. Hartshorne on the Weddas of Ceylon, was also read.

Royal Microscopical Society, Nov. 24.—The president, Mr. H. C. Sorby, F.R.S., described and exhibited his new contrivance for measuring the position of the absorption bands in spectra. The new apparatus and its principle of action may thus be described:—When polarised light passes along the line of the principal axis of quartz, it does not suffer double refraction and depolarisation, but *circular* polarisation. The result is that when the quartz is  $\frac{1}{4}$  inch thick, and placed between two Nicol's prisms, the spectrum of the light transmitted through it exhibits seven well defined black bands, which gradually move up or down the field of the spectrum on rotating one of the Nicols, returning to the same place at each half-revolution. In order to make use of this property in measuring the wave-lengths of different parts of any spectrum, the lower Nicol is permanently fixed in a mounting connected with an ivory circle, each half of which is divided into ten large divisions, and these again into five smaller, so that it is easy to read off to the  $\frac{1}{10}$  part of a half revolution. This of course corresponds to  $\frac{1}{20}$  of the intervals between any two of the seven bands. Placing the circle at the zero point, the other Nicol's prism can be rotated until the bright line of sodium is all but invisible in the centre of total interference of the second band, counting from the red end. The position of all the other bands is then also definite and constant. By using a diffraction spectroscopie the wave-lengths of all the bands and of each  $\frac{1}{10}$  interval can be calculated and arranged in a table and the smaller intervals can be filled up by interpolation. There is then no difficulty in determining the wave-length of the centre of any well-marked absorption band seen in the spectrum of any substance which is compared side by side with that of the quartz; for which purpose the binocular form of apparatus described by Mr. Sorby is the most convenient. The number of the band counting from the red end is easily seen, and the fractional interval is easily measured by rotating the ivory circle until the centres of the bands are made to exactly coincide. In the case of well-marked absorption-bands consecutive readings differ by only what is equivalent to one-millionth of a millimetre of wave-length, and the means of several observations differ considerably less than that. By proper attention to the illumination of both spectra there appears to be no serious difficulty in measuring the position of well-defined absorption-bands to within one-millionth of a millimetre of wave-length, which is quite as near as appears to be necessary in the case of the spectra for which the instrument is designed.

Geologists' Association, Dec. 3.—Mr. Wm. Carruthers, F.R.S., president, in the chair.—On quartz, chalcedony, agate, flint, chert, jasper, and other forms of silica geologically consi-

dered, by Prof. T. Rupert Jones, F.R.S. After noting a few of the salient mineralogical features of quartz, pointing out the difference in specific gravity between fused quartz (2.2) and ordinary quartz (2.6), the author passed on to chalcedony, which bears a similar relation to quartz that barley-sugar does to sugar-candy. No definite crystallised structure can be observed; but a fibrous appearance may generally be noted, at right angles to the planes of deposit, which latter often render the mass flaky. In some specimens this fibrous structure gradually becomes stronger, close-set, minute, crystalline prisms being visible in the fracture, and these pass into regular quartz crystals. The sub-crystalline structure of chalcedony is not yet thoroughly worked out. On account of the unequal resistance of some chalcedonies in agates to the action of hydrofluoric acid, by which certain layers are eaten away, cut agates have been prepared in slabs which take printer's ink and give impressions of their concentric structure, and of the channels of infiltration (See *Transact. R. Acad. Vienna, &c.*). Speaking of the formation of the angles in "fortification-agates," the author was inclined to accept the hypothesis of the chalcedonic silica having replaced calcite or a zeolite; a portion of an agate, comprising flat transverse layers of chalcedony, with quartz and calcite, being exhibited in illustration. The porous nature of agates, and the facilities thus afforded for the absorption of colouring matter, artificially introduced, were alluded to as connected with the minute prismatic structure. The properties of flint are somewhat different; it is less translucent, more conchoidal in fracture, and never fibrous in structure. Aggregations of silica were stated to be present in every limestone, either in the form of common flint or as hornstone, or some variety of chert, and were regarded by the author as being due to the replacement of carbonate of lime by silica. But as this mineral rarely succeeds calcite (crystallised calcic carbonate) as a pseudomorph, it is only the amorphous, or detrital, carbonate of lime of the organisms constituting the limestone that becomes changed into, or replaced by, silica (as flint), and not the crystallised material of Echinodermata structures (whether spines, plates, stems, or ossicles), nor of *Inoceramus, Ostrea, Terebratula, &c.* These latter, however, in some cases are, replaced by *orbicular silex*. When such unchanged organisms are abundantly present in flint, or when they have left cavities after removal by water, or when other partially altered organisms abound in the flint, it appears coarse-grained and is called "chert." The fine calcareous detritus which filled the internal canal of encrinital stems, the perforations of echinite tests, the parasitical borings of oyster-shells and belemnites, the tubules of sponges, the cavities of sea-urchins, shells, foraminifera, &c., has been changed, atom by atom, into exquisite silicious casts of such hollows and interiors, and are exposed to light by the natural or artificial removal of the calcareous enclosure. In some beds of chalk the pseudomorphosis of the limestone has taken place near and around Sponges; elsewhere, without Sponges, large masses of Polyzoan Chalk have been silicified (France, Maestricht, &c.); also Orbital and Nummulitic limestones (West Indies, Alps, &c.) Freshwater limestones (Paris, Asia Minor, &c.) Encrinital limestone (Carboniferous, Britain, and Tasmania). The white surface of a fresh chalkflint, of whatever shape it may be, shows by its rough subreticular surface, dotted with unchanged microzoa and fragments of shells, the extent of the creeping, pseudomorphic change between the nodule and the matrix, and the replacement by silica has been through just so much chalk or other limestone as the nodule or tabular mass represents in size. Even some vertical flint-veins in chalk the author believes to consist of the two altered walls of a fissure, which has been traversed by water with silex in solution; for chalk fossils remain sometimes *in situ* in such vein flint. The author believed that in the south of England, at least, it is rare for sponge-structure to be itself converted into flint. This substance represents the calcareous mud filling the cavities of the sponge, the tissue having generally been lost, or remaining only as a ferruginous stain. Hollows in flints due to the removal of involved sponge-tissue have been lined, by infiltration, with either quartz-crystals or mammillary chalcedony. The specks, blotches, lines, and some other markings apparent on weathered flint, the author thinks, in many cases, arise from differences in the texture of the flint, due to the various organic substances inhabiting or buried in the calcareous mud now represented by pseudomorphic silex. Among such organisms, he suggests that the recent thread-like Foraminifera (*Botallina, &c.*) of the Atlantic ooze may have had their analogies in the Cretaceous mud, giving rise to some straight and cross-lined markings on the weathered surfaces of broken flint, and somewhat similar,

but raised, figures on the outside of nodules. Siliceous sinter, both stalagmitic and granular, resulting from hot siliciferous springs, as in Iceland, New Zealand, Colorado, &c., was next noticed; and it was suggested that some of the flint in the Purbeck "cap" at Portland may have been siliceous sinter. Hyalite and opal and its varieties were alluded to. The orbicular siliceous "beekite" was exhibited, and referred to the deposition of silica around angular fragments of limestone, which at the same time it has replaced to some thickness. The origin of the "potato-stones," or siliceous geodes, in the Triassic beds of Somersetshire is similarly pseudomorphous. In some honestones we have extremely fine compact sand cemented by silica; thus approaching one of the two very different kinds of "chert;" other kinds belong to siliceous schists and altered argillaceous rocks. Jaspers the author was disposed to view, for the most part as altered argillaceous rocks; though some are opaque chalcidones. Beds of shell and clay may be traced into iron-flint (Eisenkiesel) and other jaspery rocks. In Griqualand-west, South Africa, there are miles of bedded jaspers, highly contorted, varying in colour and character according to the nature of the original clays and sand-rocks, which were crushed and folded by lateral pressure, and altered by the accompanying hydrothermal agency (See G. W. Stow's sections). Such jaspers, lydites, and jaspery schists have great geological importance in many parts of the world, inasmuch they hold up the surface of the country by resisting denudation.

## CAMBRIDGE

Philosophical Society, Nov. 15.—Mr. Trotter said that since reading his paper "On some Waterholes in the Gormer Glacier," his attention had been called to a passage in Agassiz (Nouvelles Etudes sur les Glaciers, Paris, 1847, p. 101), in which a similar phenomenon was described as having been first observed by Dr. F. Keller. There could be no doubt that the description in Agassiz referred to the same phenomenon as had been described by Mr. Trotter, and that therefore these holes had been first noticed by Dr. Keller, and described in 1847. Mr. Trotter however thought Dr. Keller's explanation of the phenomenon unsatisfactory, and adhered to his own as contained in the paper in question.—The following communications were made:—(1) By Mr. F. M. Balfour on the behaviour of Nucleus during Segmentation. The following observations were made upon the eggs of Scyllium and Pristiurus. At a late stage of the segmentation of these eggs most of the segments contain nuclei, but in some of them there is to be seen in the place of the nucleus a peculiar body. This has the shape of two cones with their bases in apposition. In each cone a series of striae radiate from the apex to the base; and between the two is an irregular row of granules. From the apex of the cone there further diverge into the protoplasm of the cell a series of lines. The author regards these peculiar bodies as metamorphosed nuclei in the act of dividing. He points out that the simple division of the nucleus, as well as its complete disappearance, accompanied by the formation of two fresh nuclei, are well authenticated modes of behaviour of the nucleus during cell division. These two processes can only be connected on the supposition that in the second case the two fresh nuclei are formed from the matter of the old nucleus. The author considers that there exist in Selachians modes of behaviour of the nucleus intermediate between the two extremes mentioned above, and points out that in the peculiar striation of the body he described there are indications of the streaming out of its matter into the surrounding protoplasm; while on the other hand it never completely vanishes. It therefore affords an instance where part of the matter of the nucleus divides and part streams out into the protoplasm of the cell to be again collected to assist in the formation of two fresh nuclei. The author further states that he has found other bodies intermediate between the cone-like bodies mentioned above and true nuclei; and regards these also as nuclei in the act of division, where a still larger bulk of the protoplasm of the nucleus becomes divided and a smaller part rises with the surrounding protoplasm.—(2) By Mr. Foster, On the effects of Upas Antiar on the Heart. A summary of this paper will be found in the Proceedings of the Society.

## PARIS

Academy of Sciences, Dec. 13.—M. Frémy in the chair.—The following papers were read:—On the laws of magnetic induction, by M. Jamin.—On the theory of refining of glass, by M. Frémy.—On the heat of dissolution of precipitates, and other little soluble substances, by M. Berthelot.—Researches on sulphines, by M. Cahours.—Atmospheric perturbations of

the hot season of 1875; inundations in the south of France, by M. Belgrand.—Note accompanying the presentation of micro-metric plates, for measurement of solar images, by M. Janssen.—Report on reclamations with reference to the decree given on request of the Governor of Algeria, concerning importation into Algeria of fruit and forest trees from France, by MM. Dumas, Blanchard, and others. The Commission think a line should be drawn through the points Phylloxera has reached in a northward direction, and that the exportation should be authorised of all plants accompanied with an authentic certificate stating they are from territory at least 40 to 50 kilometres north of this line.—On the temperature of elevated layers of the atmosphere, by M. Mendeleeff.—Exposition of a new method for the resolution of numerical equations of all degrees (first part), by M. Lalanne.—On destruction of the vegetable matter mixed with wool, by MM. Barral and Salvétat. They give lists of substances which destroy and those which do not destroy the vegetable fibre. The first action of the former is to remove part of the water from the fibre and carbonise it.—Researches on the constitution of fibroin and of silk, by MM. Schutzenberger and Bourgeois.—Comparative study of instantaneous and continuous electric currents in the case of uni-polar excitation, by M. Chauveau.—On a fish of the Lake of Tiberias, the *Chromis paterfamilias*, which incubates its eggs in the buccal cavity, by M. Lortet. The male fish sucks in the eggs from a sandy hollow (where the female has deposited them) and passes them in among the folds of his branchiae, where they go through the usual stages.—Researches on the respiratory apparatus and mode of respiration of certain Brachyuran Crustaceans (land crabs), by M. Jobert.—Lithological examination of green chalk sand, by M. Meunier.—On the discussion of a system of simultaneous linear equations, by M. Meray.—On the calorific intensity of solar radiation and its absorption by the terrestrial atmosphere, by M. Crova.—On the action of flames in presence of electrified bodies, by M. Douliot.—Note on the sulphocyanates of the radicals of acids, by M. Miquel.—On the saccharification of amylaceous matters, by M. Bondonneau.—Influence of stripping off the leaves, on the weight and saccharine richness of beet, by MM. Champion and Pellet.—On the embryology of Tunicata of the group of Lucizæ, by M. Giard.—Meteorological observations in a balloon, by M. Tissandier. This voyage was made on Nov. 29. At 1,500 m. a remarkable bank of ice-crystals (in whirling motion) was passed through. The balloon rose to 1,776 m., and from about 1,100 m. upwards, a rise of temperature was observed.

## BOOKS AND PAMPHLETS RECEIVED

BRITISH.—A Brief Account of Bushman Folk Lore: W. H. J. Bleek, Ph.D. (Trübner).—Euclid Simplified: J. R. Morell (H. S. King).—Map of India. To illustrate the Travels of H.R.H. the Prince of Wales (W. and A. K. Johnston).—Botany for Schools and Science Classes: W. J. Browne, M.A. (Belfast, Mullin).—Gorilla Land and the Cataracts of the Congo: Capt. R. F. Burton (Sampson Low).—Explorations in Australia: John Forrest (Sampson Low).—List of Works on the Geology, &c., of Cornwall: W. Whitaker (Truro, J. R. Netherton).—The Geological Story briefly told: J. D. Dana (Trübner).—The History of Creation: Ernst Haeckel (H. S. King).—A Physician's Notes on Ophthalmology, and series: J. Hughlings Jackson, M.D.—The Natural History of Eugenia Viridis: E. Parfitt.—Tissandier's History and Handbook of Photography. Edited by J. Thompson, F.R.G.S. (Sampson Low).

## CONTENTS

	PAGE
LORD DERBY ON THE ENDOWMENT OF SCIENTIFIC RESEARCH . . .	141
AFRICAN HANDWORK . . .	142
RECENT FRENCH EXPERIMENTAL PHYSIOLOGY ( <i>With Illustrations</i> ) . . .	144
THE ARCTIC WORLD ( <i>With Illustrations</i> ) . . .	146
OUR BOOK SHELF:—	
Andersson's "Notes of Travel in South Africa" . . .	148
LETTERS TO THE EDITOR:—	
A New Cetacean from New Zealand.—Prof. W. H. Flower, F.R.S.	149
Evidences of Ancient Glaciers in Central France.—G. POULETT SCROPE, F.R.S.	149
Science Classes and Penny Lectures in Birmingham.—W. MATTIEU WILLIAMS . . .	149
Proposed Optical Barometer.—THOMAS STEVENSON, C.E.	150
Seasonal Colour in Flowers.—R. A. PRYOR . . .	150
Glands of the Cherry Laurel.—E. H. . . . .	150
OUR ASTRONOMICAL COLUMN:—	
Variable Stars . . . . .	150
The Minor Planets . . . . .	151
Coggia's Comet, 1874 . . . . .	151
HUMAN ANATOMY AS A PART OF THE BIOLOGICAL CURRICULUM . . .	151
THE BIRDS OF THE PELEW ISLANDS . . . . .	152
THE VOYAGE OF THE "CHEVERT" TO NEW GUINEA . . . . .	153
NOTES . . . . .	154
SCIENTIFIC SERIALS . . . . .	156
SOCIETIES AND ACADEMIES . . . . .	158
BOOKS AND PAMPHLETS RECEIVED . . . . .	160

THURSDAY, DECEMBER 30, 1875

## MONTEIRO'S ANGOLA

*Angola and the River Congo.* By Joachim John Monteiro. Two vols., with map and illustrations. (London: Macmillan and Co., 1875.)

ALTHOUGH Angola is one of the oldest, if not the oldest, European colony in Africa, there are probably few other discovered regions in that continent about which English readers at least know so little, and we suspect that the Portuguese themselves know even less about its people, its productions, and its physical geography. And yet it is about four hundred years since the Portuguese planted their first colony on the coast. True there are a number of memoirs of old date, in Portuguese and in English, relating to the country, including the narrative of quaint Andrew Battell, who was for years a prisoner in Angola; but these are all pre-scientific. Recent travellers have told us a good deal about the lower Congo, and Burton, as we recently noticed, made brief visits to some of the Portuguese settlements further south, and in his own way has told us much worth knowing. Henceforth, however, there can be no doubt that Mr. Monteiro's work will be regarded as the authority on the country, more especially when it is supplemented by the various memoirs on the natural history of Angola which he has contributed to the proceedings of the Linnean and other societies, and to scientific journals. Mr. Monteiro spent many years in the country, evidently in connection with mining operations, and during that time had opportunities of visiting and exploring most if not all of the principal districts from the Congo to Mossamedes, frequently penetrating many miles inland. Mr. Monteiro is an Associate of the Royal School of Mines, and his work proves him to be well qualified not only for geographical exploration, but for the investigation of the natural history and physical conditions of a country. He is evidently quite at home in geology, zoology, botany, and meteorology, and has a skilled eye for the points which a traveller ought to note in the natives whom he visits. To the natural history of the country, our naturalist readers no doubt know, Mr. Monteiro has made several important contributions. On the Portuguese settlements and colonists, on the various native tribes, on the geographical and physical features, and on the natural history of Angola the work before us contains such abundant information, that no one but a specialist need go further to obtain a satisfactory knowledge of the country in all its aspects. Mr. Monteiro writes in a simple, straightforward style, indulges but little in speculation, conjecture, or moralising, and every page is so full of interesting and important facts, clearly told, that the reader will feel constantly in a state of satisfied enjoyment. Most of the information in the work has been obtained at first hand; in the few instances where it is otherwise Mr. Monteiro is careful to point out the source and its value. So far as a full and trustworthy account of Angola is concerned, it seems to us that it would be difficult to supersede the work before us.

The name Angola Mr. Monteiro applies to all the country from the Congo to Mossamedes, a distance of about nine degrees of latitude. On the north, however,

the Portuguese possessions extend no farther than Ambriz, a good many miles south of the Congo, while on the south they extend as far as Cape Frio in 18° 20' S. lat. The author chooses the Congo as the northern boundary, that being the strong natural limit of the climate, fauna, and ethnology of the region. Chapter I. contains a brief account of the history of Angola to the beginning of the present century, translated from the Portuguese of Feo Cardozo. Throughout the work Mr. Monteiro gives an account of all the principal Portuguese settlements along the coast, and has frequent occasion to refer to the inland districts presided over by a *chefe* or sub-governor. The general impression left on the reader will be one of utter mismanagement, pusillanimity, and oppression. The country as a whole is a fine one, capable of extensive development in many directions, and might be made an extremely valuable possession to Portugal, if the most ordinary care were bestowed upon it. The officials are all underpaid, and with very few exceptions are as corrupt as can well be imagined. The poor natives are plundered on all hands, and a country which might be made to add materially to the resources of the world, is almost entirely profitless through being in the hands of a people too ignorant and too lazy to turn it to any account.

There are a considerable number of tribes scattered up and down the region described by Mr. Monteiro. These tribes vary considerably in language, customs, physique, and intelligence, none of them, however, standing very high in the last-mentioned attribute. The author had many opportunities of studying the natives of Angola, and the ethnologist will find much valuable information in the work. Mr. Monteiro has but a poor opinion of the capacity of the African, and but little hope for his future. He believes that all the efforts hitherto made to elevate and civilise him have failed, and his conclusions on the subject coincide essentially with those of Burton and with those of most other authorities who have examined it dispassionately. Unless under the judicious superintendence of the white man, Mr. Monteiro does not believe there is any hope of the negro ever attaining to any considerable degree of civilisation; and as whites can flourish in very few parts of Africa, "the negro must ever remain as he has always been, and as he is at the present day." Moreover, any advantages which the negro has hitherto derived from the white races have been more than counterbalanced "by the creation of an amount of vice and immorality unknown to the negro in his native or unsophisticated state." Many, no doubt, will be inclined to think that Mr. Monteiro takes much too hopeless a view of the future of Africa and Africans. It is certainly hard to believe that no means will ever be discovered of developing the resources of a country which might be made to yield so much. No doubt, if this is ever to be accomplished, it must be mostly by means of native labour under white superintendence. But with the author's general conclusions on the African question we have no doubt that all who have dispassionately considered must in the main agree. Angola itself is on the whole a comparatively healthy region, and, with ordinary care, Europeans need have little difficulty in getting acclimatised. On this subject, Mr. Monteiro gives some valuable hints; he is of the same opinion as Capt. Burton as to the use of stimulants in tropical countries; from his own experience and from observa-



tions, he infers that their judiciously moderate use is indispensable to complete health.

With regard to the almost hopeless stupidity of the negro, the author gives a curious instance. He employed a number of natives while mining malachite at Bembe. He says:—

“It was great trouble to teach the natives the use of the pick and shovel, and the wheelbarrow was a special difficulty and stumbling-block;—when not carrying it on

“The character of the negro is principally distinguished not so much by the presence of positively bad, as by the absence of good qualities, and of feelings and emotions that we can hardly understand or realise to be wanting in human nature. It is hardly correct to describe the negro intellect as debased and sunken, but rather as belonging to an arrested stage. There is nothing inconsistent in this; it is, on the contrary, perfectly consistent with what we have seen to be their physical nature. It would be very singular indeed if a peculiar adaptation for resisting

so perfectly the malignant influences of the climate of tropical Africa, the result of an inferior physical organisation, was unaccompanied by a corresponding inferiority of mental constitution. It is only on the theory of ‘Natural Selection, or the survival of the fittest’ to resist the baneful influence of the climate through successive and thousands of generations—the ‘fittest’ being those of greatest physical insensibility—that the present fever-resisting, miasma-proof negro has been produced, and his character can only be explained in the corresponding and accompanying retardation or arrest of development of his intellect.”

In his second chapter the author gives a very clear account of the physical conditions of Angola, whose aspect, productions, and climate present considerable variety both north and south, and from west to east. Contrary to the generally received opinion, Mr. Monteiro doubts whether the Congo, with its vast body of water and rapid current, drains any large extent of country in an easterly direction to the interior, beyond the first rapids. He is inclined to believe that the river, or its principal affluent, after going in a N.E. direction for a comparatively short distance, bends to the southward and will be found to run for many degrees in that direction. It would be vain to theorise on the question, which happily may be set at rest by Lieut. Cameron, who is expected to arrive in this country in a week or two; the information he must have obtained about the watersheds between the Zambesi and the Congo may enable us to form some notion of the upper course and approximate length of the river. Mr. Monteiro’s general conclusion seems, however, at present a very probable one. “From the few and insignificant streams traversing Angola to the coast, which at most only reach sufficiently far inland to have their source at the third elevation or central plateau, it would seem that a great central depression or fall drains the waters

of this part of Africa in either an easterly or southerly direction.”

The alternation of swamp and dense forest which is characteristic of so much of the West Coast of Africa, ends completely on arriving at the River Congo, and a total change, Mr. Monteiro tells us, to the comparatively arid country of Angola takes place.

“I may say that, without exception, from the River

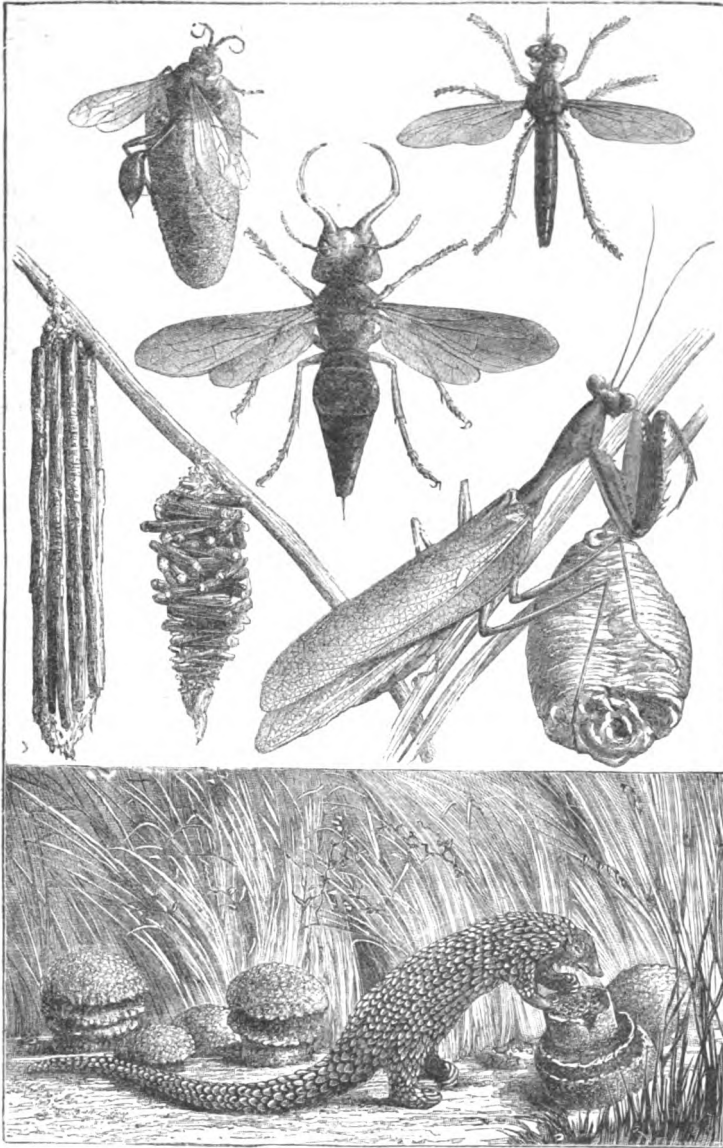

*Pelofagus spirifex* and nest—Devil of the road (*Synagris cornuta*)—*Dasytus* sp.—Caterpillars' nests—Mantis and nest—*Manis multiseutatum* and Ants' nests.

their heads, which they always did when it was empty, two or three would carry it; but the most amusing manner in which I saw it used, was once where a black was holding up the handles, but not pushing at all, whilst another in front was walking backward, and turning the wheel round towards him with his hands.”

† The following bold and ingenious theory as to the character of the native Africans is at least worthy of consideration:—



Congo to Mossamedes no dense forest is seen from the sea, and from thence not a single tree, it is said, for hundreds of miles to the Orange River. A little mangrove, lining the insignificant rivers and low places in their vicinity, is all that varies the open scrub, of which the giant *Adansonias* and *Euphorbias* have taken, as it were, exclusive possession. Nowhere on the coast is seen more than an indication of the wonderful vegetation, or varied beauty and fertility, which generally begins at a distance of from thirty to sixty miles inland.

"At this distance, a ridge or hilly range runs along the whole length of Angola, forming the first elevation; a second elevation succeeds it at about an equal distance; and a third, at perhaps twice the distance again, lands us on the central high plateau of Africa."

Each of these successive elevations is accompanied by a corresponding change in the character of the vegetation. This varied vegetation Mr. Monteiro describes

with considerable minuteness as he makes his way from the Congo to Mossamedes, stopping at many places to make minute explorations of the country around. As we have said, Mr. Monteiro has chosen the Congo as the northern boundary of Angola, because it presents a well-marked line of division in respect of climate, fauna, nature, and customs, between Angola and the rest of the west coast. He refers to some very remarkable facts in confirmation of this. The Congo is the southern limit of the gorilla and of several species of monkeys and even of birds, butterflies, and insects. He says truly that it would well repay a naturalist to investigate the number of species the Congo cuts off; it is a pity he had not time to undertake the work himself; no one could be more competent.

With regard to the universal fetishism of the natives,

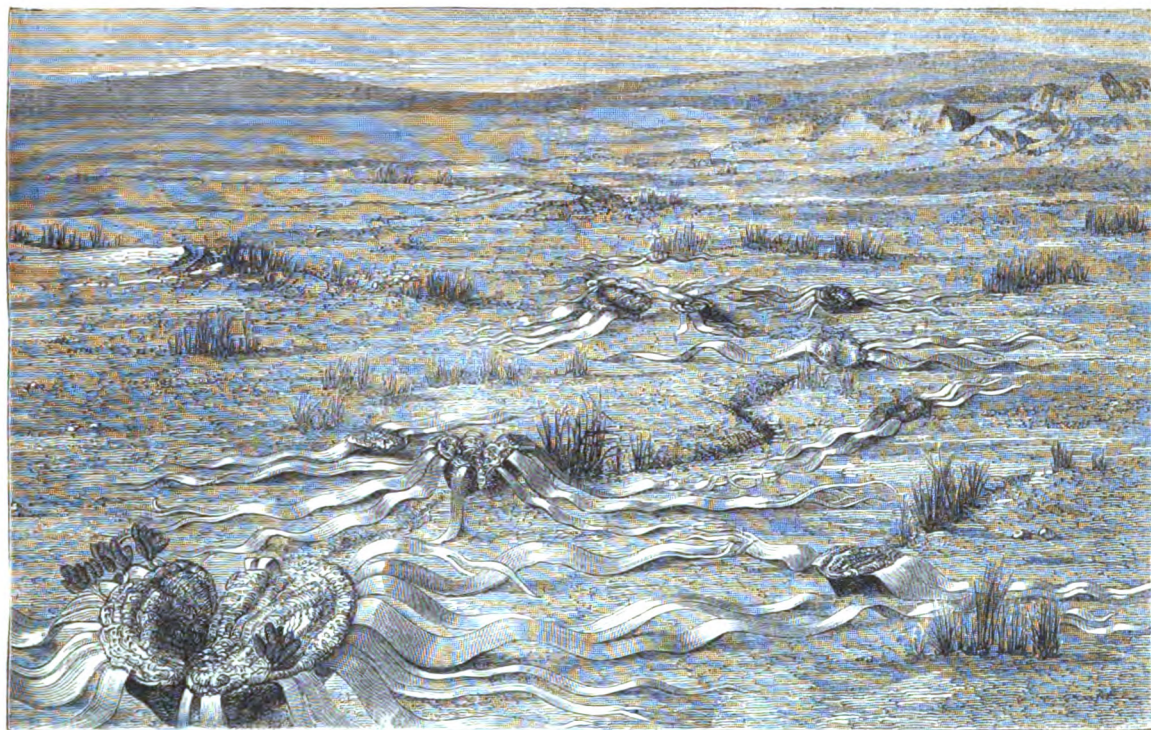

Welwitschias growing in a plain near Mossamedes.

Mr. Monteiro gives abundant information, much of which we are sure will shed a new light on this degrading and depressing superstition. It seems almost impossible to eradicate it. Many of the Angolan tribes were converted and educated by the old Portuguese missionaries, and to this day many of the tribes transmit the "trick," as Mr. Monteiro calls it, of reading and writing. But this seems to have had no effect in abolishing fetishism, but on the contrary has rather furnished it with new materials on which to flourish. In some respects fetishism seems to resemble the Polynesian "tabu." "Fetish" is often used as equivalent to *charm* or *magic*, and many objects are used by the natives to carry about with them to be used as charms against evil, and in some places rude houses are built as a dwelling for a fetish, who may be represented by a rude image. But besides this it is possible to fetish a person, or thing, or animal, in the same way as

in some of the Pacific Islands certain objects may be tabu. Certain animals are fetish, and these a native dare not injure; and indeed it seems possible and easy to render anything whatever fetish, and once at least Mr. Monteiro took legitimate advantage of the custom for his own protection. Their fetishes have, however, no power for good or evil over the white man, who belongs to another and more powerful god than do the natives, who themselves received the idea of God or Creator from the Portuguese missionaries.

The Celis and Mucelis, tribes dwelling inland from Nova Redondo to the north of Benguella, are, Mr. Monteiro believes, the only cannibals in Angola; the Quinundos, a superior tribe to the south of the Quanza, are not so, "though a traveller who made a few days' trip up the river has asserted they are." The natives on the Quanza and to the south for many miles are great be-

keepers, constructing hives which they keep in trees. Some families possess as many as 300 or 400 hives.

About Mossamedes the *Welwitschia mirabilis* is found growing, and the country about the river San Nicolau, 14° S. lat., seems to be its northern limit. Mr. Monteiro sent home specimens of the plant, flower, and cones, which supplied Dr. Hooker with some of the materials for his monograph on the plant.

It is impossible in our limited space to give any adequate idea of the abundant information contained in these volumes; we can only assure our readers that if they wish for satisfactory information about the country, the people, the fauna, the flora, the geology, the mineralogy of Angola, they will find it here. While an excellent idea of the country as a whole will be obtained, the author gives minute details of a very large number of animals and plants, of the geology of certain parts, and as to the various minerals which may be obtained, and especially concerning the various tribes, their characteristics, customs, implements, and other matters. The numerous illustrations add not a little to the value of the work.

#### WORKS ON THE BLOWPIPE

*An Introduction to the Use of the Mouth-Blowpipe.* By Dr. Theodore Scheerer and H. F. Blanford, F.G.S. Third Edition. (London: Frederick Norgate, 1875.)

*Pyrology; or, Fire Chemistry.* By Major W. A. Ross, R.A. (London: E. and F. N. Spon, 1875.)

THE first of these volumes is a third edition of a well-known little work, the second edition of which was published in 1864. We think that it still holds its place as the best elementary book on the application of the blowpipe to the determination of minerals, although but few changes have been made in the text.

Major Ross's work on "Pyrology" is an imposing volume illustrated with coloured lithographs. The preface looks more like an article in a well-known daily paper than the opening of a scientific treatise, for in the space of a few pages the names of Neri, Cassius, Pattinson, Herbert Spencer, Bacon, Sir W. Hamilton, Hume, Kant, Mrs. Marcet, Walpole, Bonaparte, Grimaldo, and Hook are alluded to, often in a flippant and tiresome way. The introduction is much in the same style, and we are told that "precisely the same operations of the mind are necessary to analyse a murder or a miracle as a mineral," and that "the general, the detective or the logician deduces probabilities from facts . . . and the physicist or pyrologist has first to elicit facts, which he calls reactions, from which probabilities are concluded." A passage which occurs on page 10 deserves notice. In it the author states that "the various spectra in the orange, green, violet, and indigo, &c., are due to the vapour of substances composed of combinations of hydrogen, oxygen and carbon, and thus that such lines seen in the solar spectrum should scarcely without further evidence be, as they now generally are, attributed to the vapour of burning terrestrial metals in the solar photosphere, but that our metals should rather be supposed to be composed of these elements in different proportions." Spectroscopists will hardly consider the evidence he adduces in support

of this hypothesis to be satisfactory, for it rests on no better foundation than the fact that when small fragments of zinc, lead, silver, aluminium and other metals are heated before the blowpipe flame in a bead of phosphoric acid each metal with the exception of tin, gold, platinum, and mercury is decomposed into a brick-red oxide, a brownish black gelatinous mass, and bubbles of some gas which smells like phosphuretted hydrogen.

An interesting and careful history of the use of the blowpipe is then given, at the conclusion of which the author alludes to his own labours, and after a careful examination of the work, we are convinced that we shall best do him justice by stating the principal observations that he claims as his own. These are—a method of detecting soda by means of the orange colour which is imparted to the "pure pyrochrome of boric acid." Potash, on the other hand, being detected by the blue colour produced by breathing on a bead of boric acid which has been blown into a thin vesicle, and in which the mineral has been fused. The separation and detection of "lime and the alkaline earths" by fusion in a bead of boric acid, when the oxides congeal into small balls which float in the clear bead. The use of phosphoric acid as a solvent for certain metals, such as platinum and gold, and the adoption of sheet aluminium as a support, which, among other advantages, facilitates the roasting of arsenides and sulphides. In addition to these there are between thirty and forty other "novelties" which space will not permit us to enumerate.

The nomenclature employed in the work is rather bewildering; for instance, a flame having a conical shape is termed "a pyrocone;" a non-luminous flame tinged with colour "a pyrochrome;" and the crystallisation of substances from a state of fusion, is called "crystallignation." It will be evident that such terms become almost irritating when combined into words like "Ellychnine Pyrocone," which means a candle flame tinged with colour.

The tables for blowpipe analysis constitute a "Pyroqualitative Indicating Chart," which Major Ross has divided into fourteen columns. Taking nickel, to which he specially directs attention as showing the merits of the table, we find that its reactions are described under three heads. First, with phosphoric acid an amber brown bead or, with little of the substance, an orange bead is produced. Second, with boric acid a bead containing green fragments is obtained in the O.P. (oxyhydrogen pyrocone), and metallic fragments in the H.P. (hydrocarbonous pyrocone), and third, when the substance is heated on an aluminium fusing tray in a "charcoal mortar" before the O.P. a green hairy mass is produced. Anyone familiar with blowpipe work will be able at once to compare mentally these directions with Plattner's concise and well-known tables which, by the by, are printed in the appendix. In addition to the well known reagents he employs many of unknown or uncertain composition, such as potassic tungstic borate, mangani cobalt solution, and thus complicates effects. We may give the following as an example of the author's chemistry:—"Sulphides are instantly detected upon it (aluminium foil) by fusing them with a small fragment of soda, and saturating the hot mass with a drop or two of water, when an inkly black,

disgusting smelling precipitate of sodium sulphide is produced." It will be new to chemists that *sodium sulphide* is a black substance insoluble in water. There are a few well executed coloured lithographs, but the woodcuts, of which there are about forty, are very rough.

So much care and labour have evidently been bestowed on the preparation of the book, that we regret to be compelled to speak of it in terms of but faint praise. It is the work of an earnest enthusiast who has discovered some pretty reactions which might have at once become generally useful, had they been set forth in a clear and concise form.

#### THE ROCKS AND MINERALS IN THE MELBOURNE MUSEUM

*A Descriptive Catalogue of the Specimens in the Industrial and Technological Museum, Melbourne.* By G. H. F. Ulrich, M.E., F.G.S. (Melbourne, 1875.)

THE value of the collection of rock-specimens and minerals in the Museum at Melbourne will be much enhanced by the publication of this descriptive catalogue, which has been drawn up by Mr. Ulrich somewhat upon the model of the catalogue illustrating the collections in the Museum of Practical Geology in London. We learn from Mr. Newberry's preface that it originally formed part of the Report of the Museum presented to Parliament in 1874, and it is now reprinted with a view of making it more generally useful. Judging from the catalogue itself, we should say that the collection of rocks and minerals from the province of Victoria must be of an exhaustive character; the varieties are abundant, and embrace rocks of nearly every known description.

In drawing up this catalogue, the author has not neglected the geological conditions under which the specimens have been originally found; and along with the several varieties of granitic, plutonic, volcanic and sedimentary rock-specimens are also described the distribution and characteristics of the masses from which the specimens have been collected, together with their economic uses. In this part of his work the author has availed himself of the maps and reports of Mr. Selwyn, late Director of the Geological Survey of Victoria—whose important and successful operations in the field were brought to a close about seven years ago, by a sudden fit of parsimoniousness on the part of the Colonial Legislature. In describing the rocks, Mr. Ulrich has adopted the system of classification laid down by Zirkel in his *Petrographie* modified by the views of Von Cotta and other petrologists. But, however valuable such a classification may be when it is in the power of the observer to have constant recurrence to the aid of chemical analysis, we consider that for the field petrologist it is only occasionally available. The nice distinctions between the several species of plagioclastic felspars are only to be determined by laboratory analysis, and for the ordinary observer a classification founded on the presence or absence of quartz amongst the felspathic rocks; and on the determination of hornblende, as against augite as the basis of the pyrosenic rocks is sufficient. Daily experience, aided by microscopic examination, tends to show.

that definite species amongst rocks are but limited in number, and have little connection with geological age. On this ground we object to such terms as "diabase," with its several varieties mentioned in the *Table of Mixed Felspar Rocks*, as well as "anamesite," "felspar basalt," &c., though resting on the high authority of Dr. F. Zirkel; such being simply varieties of basalt or dolerite.

Again (in p. 24), several specimens are described under the head of "porphyry," with its varieties, in all of which quartz-grains are present. Now, if this term means anything different from "porphyry," it means a *quartzless* porphyry, as its author, Naumann, proposed. Zirkel's definition is "quartzfreier orthoklas Porphyry." The presence of free silica, therefore, renders the name inapplicable; and although the matter is of little consequence, we refer to it to show the confusion which has arisen by the introduction into petrology of an objectionable name, and its use in a different sense from that intended by the original proposer.

Those portions of the catalogue relating to the occurrence of gold will be found of much interest, and must prove useful to colonists and adventurers in search of the precious metal. The upper Silurian strata rest discordantly on the lower—as in the British Isles—and in these latter are very numerous "veins, lodes, or reefs of quartz," which traverse the beds, varying from one inch to above 100 feet in breadth. According to Mr. R. Brough Smyth's statistics for 1874, the number of these actually proved to be gold-bearing amounted to 3,367, which was being constantly added to owing to the energy of the mining population. These reefs are the original source of the gold, which is extracted directly from the quartz, but more frequently from the detrital strata derived from the denudation of the Silurian rocks, and now arranged in three divisions of "Drift," of which the oldest is the most auriferous. Associated with the gold grains are minerals and precious stones in such variety and profusion as is only granted to a few favoured spots, amongst which we notice the diamond, ruby, sapphire, topaz, zircon, garnet, amethyst, Cairngorm, opal, &c., besides metallic ores, all jostling each other amidst the stones, clay, and sand which would conceal their charms from the unpractised eye.

On the whole, the volume before us affords a remarkable illustration of the similarity of the materials which enter into the composition of the earth's crust all over the world, or at least in widely separated districts. Here at the Antipodes we have a series of rock-specimens exemplifying the rock-formations of Victoria, nearly every one of which finds its representative in the British Islands. We find similar granites, felstones, porphyries, diorites, mica-traps, dolerites, basalts, schists, serpentines and quartzites, sandstones, slates and limestones, and even the rare "nepheline-basalt" of Philip Island and Port Ray has its representative in the Wolf Rock, off the coast of Cornwall, as Mr. Allport has recently determined. As regards the drawing up of the catalogue, the most scrupulous care has evidently been exercised, both in determining the nature of the specimens themselves, and in identifying their localities; while a very good idea of the geological structure of the colony may be obtained from a perusal of its pages.



## OUR BOOK SHELF

*A Monograph of the Trogonidæ; or, Family of Trogons.*  
By John Gould, F.R.S., &c. (London: Published by the Author, 1875.)

THE completion of a second edition of Mr. Gould's "Monograph of the Trogons," is an event which ought not to pass by without a notice in this Journal. The first edition of this work, published in 1838, was one of the earliest of Mr. Gould's magnificent series. Of its fellow Monograph, that of the Toucans, a second edition was issued some time since, and the present work is a worthy companion to it. During the thirty-seven years which have elapsed since the publication of the first edition of the "Monograph of Trogons," Mr. Gould, as his brother ornithologists know full well, has by no means neglected the subject, but has from time to time brought forward descriptions of new species that have come to his knowledge from the more thorough exploration of the tropics that has of late years taken place. From these, and other sources, the number of known Trogons, which at the time of the first Monograph was thirty-four only, has now been increased to forty-six, of the whole of which splendid life-sized pictures, according to Mr. Gould's wonted practice, are given in the present volume.

Like the Parrots, the Trogons are widely diffused through the tropics of both hemispheres. Though not so strongly marked in general characters as the Psittacidæ the Trogonidæ are separated from all other known birds by the peculiar conformation of their feet, having the first and second toes permanently turned backwards, which is not the case in any other form of the class "Aves." Like the Parrots, too, the Trogons are most numerous in the New World, thirty-three out of the forty-six species being peculiar to Central and Southern America, whilst eleven are found in the Indian region, and two only in Africa. As regards habits and mode of life, there appears to be much similarity in the Trogons of all three continents. They are universally forest-haunting birds, inactive in habits, short in flight and feeding, whether their prey be insect or fruit, mostly upon the wing. Their brilliant colours offer the most remarkable compounds of emerald green and various shades of crimson and golden yellow, as will be sufficiently apparent to anyone who turns over Mr. Gould's splendidly-coloured plates. We must indeed congratulate the author on the energy and success with which, prompted by the pure love of science, he has brought out a second edition of one of the first of his many important ornithological works.

*Geologie der Kohlenlager*, von Dr. Hermann Mietzsch, Geolog der Landesuntersuchung im Königreiche Sachsen. (Leipzig, 1875).

FOR those to whom the magnificent work of Geinitz, Fleck, and Hartig, *Die Steinkohlen Deutschlands*, is inaccessible, the smaller treatise before us will prove acceptable. From the practical acquaintance of his subject gained in his professional duties, Dr. H. Mietzsch was well fitted to produce a treatise on the physical properties of coal and the phenomena connected with its place amongst the strata; while, with the industry which generally characterises German authors, he has made himself acquainted with what has been written on the subject by French and English writers, as well as those of his own fatherland, and has woven the whole into a connected account of the history of coal-mining, the properties of coal, and the conditions under which it has been found in various countries and periods, as well as the structure and mode of formation of coal-fields and coal-basins. The work is illustrated by twenty-five woodcuts, and appears to bring the subject well up to the present state of our knowledge.

E. H.

## LETTERS TO THE EDITOR

[The Editor does not hold himself responsible for opinions expressed by his correspondents. Neither can he undertake to return, or to correspond with the writers of, rejected manuscripts. No notice is taken of anonymous communications.]

## Evidences of Ancient Glaciers in Central France

WERE this a question concerning volcanic phenomena, with which Mr. Scrope is as familiar as I am with glacial ones, I might be disposed to defer to his opinion. As it is, having only his assertion that I have mistaken the results of a recent landslip (*i.e.* a spot where there are no traces of landslip, and to which no landslip could have reached) for time-worn and weathered glacier-transported blocks, I ask the readers of NATURE to pause before disposing of my powers of observation as summarily as Mr. Scrope does; remembering that the history of all glacial phenomena, from scratched boulders to lake-basins, has been successively overlooked, denied, and misinterpreted, before being understood and accepted.

The landslip to which Mr. Scrope refers, and which he describes as having occurred in 1859, under cliffs nearly a thousand feet high "on the left flank of the valley looking upwards," is in a very different position from that of the blocks to which I have directed attention. There are no cliffs whatever such as Mr. Scrope describes on the left flank of the valley anywhere near their position, nor for half a mile above it. The left flank of the valley for half a mile above them forms a very gentle slope indeed, and rises but a very few hundred feet above its floor, without cliff or rock protruding on its surface.

On the other hand, the evidences of old ice action in the Mont Dore district, and elsewhere in Central France, are as conclusive as in Western Scotland, M. l'Abbé Lecoq notwithstanding, for whose labour in his own line of research I have as high a regard as I have for Mr. Scrope's.

J. D. HOOKER

## Sir Thomas Millington and the Sexuality of Plants

THE letter of your anonymous correspondent "A. B. C.," in your issue for Dec. 16, hardly seems to need a reply, inasmuch as he has added nothing whatever to the solution of the question raised in mine, whether any writings of Sir Thomas Millington are in existence which confirm the alleged discovery by him of the sexuality of plants. From the silence of your correspondent on this point, as well as of the two writers referred to in my letter, I infer that no such writings are, at all events, readily accessible. There are, however, some statements by your correspondent which cannot be allowed to pass uncorrected.

First, as to the bibliographical matter: "A. B. C." says "there is no such thing" as a second edition of Grew's book—a somewhat rash assertion in the face of the fact that the words "The 2nd edition" are printed on the title-pages of three out of the four books which make up "The Anatomy of Plants," first published as a whole in 1682. The facts of the case are these: In 1672 Grew published a small volume under the title "The Anatomy of Vegetables begun, with a general Account of Vegetation founded thereon;" in 1682, a much larger work entitled "The Anatomy of Plants begun, with a general Account of Vegetation founded thereupon," a portion of which is a reprint of the earlier work. I fail to see why I should be held up to reproach as having almost committed a literary crime in referring to the larger as "a second edition" of the smaller work.

Now as to the more important matter. Without bringing forward a tittle of fresh evidence, "A. B. C." makes the confident assertion that it is "also clear enough" that Millington is entitled to be described as the discoverer of the sexuality of plants. In singular juxtaposition with this assertion he quotes a paragraph from Sprengel in which some half-dozen illustrious botanists are named in this connection, but Millington is not even mentioned! The preceding quotation from Grew is made to appear as if it owed its inspiration to Millington; whereas, after the graceful reference to his friend the Savilian Professor, Grew commences his account with these words:—"The sum therefore of my thoughts concerning this matter is as follows." It would seem as if, at the close of the seventeenth century, fresh insight into the phenomena of fertilisation was being gained by a number of botanists in both England and Germany; but "A. B. C." has established no right to express an opinion in so *ex cathedra* a style in favour of Millington's sole claim to the discovery. For evidence

that the observations of Kamerer of Nürnberg (Camerarius) anticipated by two years the publication of Ray's "Historia Plantarum," I must refer him and any of your readers who are interested in the subject to Sachs's "Geschichte der Botanik."

Linnæus ("Amœnitates," vol. i. pp. 329, 330) thus sums up the relative merits of Millington, Grew, Ray, and Camerarius: "Thomas Millington, eques Anglus, Professor Savilianus, primus videtur, qui insigni cura in hac veritate erudendam incubuit, viamque aperuit experientissimo Grewio. Nehemias Grew, in anatoe Plantarum, sexus diversitatem et fecundationem plantarum per farinam masculæ scrutari conatus est; cujus *hypothesisibus*, album addidit calculum temporis sui botanicum eximius Rajus. Rudolphus Jacobus Camerarius primus perspicue *demonstravit* sexum et generationem, quamvis non dubii fuit ipse expers de hac veritate, quod si moverant experimenta quæ fecerat in Cannabæ."

Now as to Theophrastus. Your correspondent makes much of the "prolific virtue" ascribed to the pollen-grains by Grew. No one, however, can have read the writings of the early Greek and Roman naturalists without having learned, that not only did they distinguish male and female flowers, but also ascribed a "prolific virtue" to the pollen. Without troubling your readers with a Greek quotation, let us hear what a commentator on Theophrastus says:—"Theophrastus ait, fructum in palma femineæ perdurare nunquam posse nisi florem maris cum pulvere super eam concusserint;" and again: "In palma maris et foemineæ coitus sit;" or again, Pliny: "Adeoque est veneris intellectus, ut coitus etiam excogitatus sit ab homine ex maribus, flore, et lanugine, interim vero tantum pulvere insperso feminis."

I hardly think your readers generally will agree with "A. B. C." in his opinion that "time, paper, and ink are wasted" in a discussion of a historical point of some interest.

Dec. 24

ALFRED W. BENNETT

#### Saw-fish Inhabiting Fresh Water

IN NATURE, vol. xiii. p. 107, Mr. Wood, of Manila, writes on "Saw-fish inhabiting fresh water," in the Laguna de Baij, Luzon, as on something curious and new. But this fact was known long ago; not only do sharks live in fresh water there, but also elsewhere on the globe. As one who mentions the saw-fish in the Laguna de Baij, I only name the famous de la Gironnière ("Aventures d'un Gentilhomme Breton," 1857). He says, p. 102: "Deux poissons de mer se sont acclimatés dans les eaux douces du lac: le *requin* et la *scie*. Le premier est heureusement assez rare, mais le second est très abondant."

The species of saw-fish mentioned is *Pristis perrotetti*, a species of very wide distribution; it has been collected in the Atlantic (West Indies), in the Indian Ocean (Zambesi), in the China Sea (Borneo), &c.

When on Luzon in the year 1872, I succeeded in procuring a series of specimens on the spot, which I brought home; they are from two to three feet long, but I saw, myself, at the fish-market of St. Cruz a specimen of about twenty feet in length. Quantities are to be seen on every market day in St. Cruz, the flesh being very cheap on account of its bad and dry quality, and only the poor mountaineers like it as food.

I took some trouble to get those smaller specimens home, because I fancied that they might possibly differ from the marine specimens (Bay of Manila). But an accurate comparison showed no difference at all, and therefore the changed conditions seem to have had no influence on the external features of the species.

The saw-fishes are said to fight violently with the crocodiles, which occur in large quantities in the Laguna, and I do not doubt the fact.

Dresden, Dec. 23

A. B. MEYER

#### Spectrum of Fish-pigment

I HAVE lately observed the spectrum of a pigment-colour found under the scales in fins and tail, mouth and eyes, of a small smelt-like fish found in St. Vincent's Gulf, S.A. They are commonly known as the Weed fish, but Mr. Waterhouse, our Curator, informs me they are the *Odax radiatus*, *O. frenatus*, *O. Richardsonii*. These fish are perfect little gems for colour, being of a bright blue green (nearly blue) in *O. Richardsonii*, and about the eye most splendid; black centre, brilliant orange ring, outside of which is a most brilliant turquoise blue ring set in deep brown.

Finding this colouring matter stained paper, I examined the scales and fins by spectroscopy, and noticed a deep band that appeared to correspond with the deep band of chlorophyll. I send a sketch of the respective spectra and a bulb and tube of the pigment in solution, which, with the pieces of tail and fins, I trust you will receive in good condition. I do not place much faith in it remaining clear and brilliant; the heat of the ship may possibly destroy or alter it. You will notice the solution is rather bluer than chlorophyll. This pigment is nitrogenous, is destroyed by heat, chlorine, acetic acid, alkalis, ammonia, and alcohol. It is soluble in water and sea-water. Sulphuric acid precipitates it with albumen of fish, but does not destroy colour. Light bleaches it. Its chemical properties are therefore distinct from those of chlorophyll.

I consider some interest attaches to this from the fact of the Parrot-fish (*Labrichthys Richardsonii*) being marked with blue stripes containing the same colouring matter; also the scales and parts in *Odax* coloured orange give a green tint almost identical in shade to chlorophyll. This yellow or orange does not give

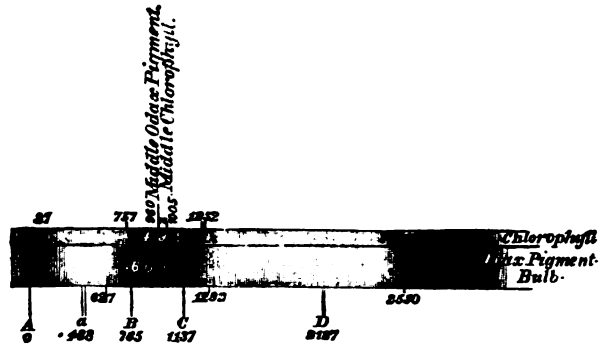

Spectra with kerosine flame on edge of *Odax* pigment and comparison with chlorophyll.

Dividing the Solar spectrum into 10,000 parts from A. bright kerosine flame on edge gives as above. The chlorophyll band is rather lighter in the centre; when solution is dilute it divides into two fine lines. Width of strong band, 495.

The *Odax* Pigment does not resolve into two lines. The centres of these two great bands *Odax Chlorophyll* are only forty-five apart. Width of band, 665; rather nebulous, especially at end of greatest refraction. Some very faint bands occur each side of D, and continue to end of nebulosity to 2,550. The bulb gives the above figure. The tube a much narrower band, but centre coincides with bulb.

any band or interfere with the spectrum of the pigment, except so far as its mere colour and general absorption at blue end arising from such colour.

Now as chlorophyll has been said to be found in some infusoriae, which I doubt, it is just possible that this or similar colouring matter is taken for it. I have been rather curious in examining animal greens in shells, and a native green silk we have here, also in the Emu egg-shell, but cannot find the slightest trace of chlorophyll band, and until I met with this I concluded no animal green yielded any band that could be mistaken for chlorophyll, and that therefore the spectroscopy was an unerring test for distinguishing between vegetable and animal organisms. This spectrum of *Odax* pigment, which possibly I may find in other species of fish, Actiniadae or Medusae, many of which are beautifully coloured, is therefore so far of interest. I trust these remarks may be interesting and lead to some inquiry in this direction.

The dry pieces of fins and tail, also a piece of stained paper, will show well if mounted in balsam. If the colour is not deep enough, cross the layers one over the other until sufficient depth of shade is obtained. I use half-inch object glass in microscope except for scales and spots, when I use quarter, and shut out all other light; single scales then show the bands well.

GEORGE FRANCIS

Laboratory Institute, Adelaide, Oct. 9

#### Function of the Ocelli of Hymenopterous Insects

My brother, Fritz Müller (Itajahy, Prov. St. Catharine, South Brazil), in his letters to me, has repeatedly started the question whether the size of the ocelli of hymenopterous insects is not dependent on their nocturnal habits. He supports this opinion by the following observations:—

1. *Apoica pallida*, one of the social wasps of Brazil, in the daytime rests quietly in its nest, which resembles the nest of our *Polistes gallica*, but is attached to the twig of a tree. During the evening it looks after flowers, and, whether sitting on them, and sucking their honey, or flying about in the moon-light, by its moonlike colour it is protected from its enemies. It differs from the allied species, which have diurnal habits, in the largeness of its ocelli.

2. One of the solitary Apidæ of Itajahy, belonging to the family of Andrenidæ (*Eophila matutina*, F. and H. Müller) has the singular habit of visiting flowers exclusively in the twilight of earliest morning, and is also provided with unusually large ocelli.

3. A species of *Dorylidæ*, probably belonging to the genus *Labidus*, found, Oct. 1875, by my brother's daughter Anna, late in the evening, flying towards the candle-light, is likewise remarkable for strikingly large ocelli. Concerning *Dorylus*, Gerstaecker says: Ocelli large, bladdered ("Ocellen gross, blasig"); and Westwood (Introduct. vol. ii., p. 216), "Mr. Burchell has informed me that the African species of *Dorylus* is nocturnal in its habits."

Can any of your readers give further information about the function of the ocelli?  
HERMANN MÜLLER  
Lippstadt, Dec. 18

#### The House-fly

SOME months ago there were several notices in NATURE as to the death of house-flies, caused by a parasitic fungus. One instance only has come under my observation.

Certainly not later than the first week of last October I saw a fly standing dead on the outside of the pane of my window, surrounded with a small cloud of dust. After a day or two the fly fell off; but the curious part of the matter is that at this moment (Dec. 20), the dust is still on the window-pane. The spaces where the legs were are left sharp and clear, and the cloud, thickest close around them and under the place of the body, thins out gradually round to the distance of above an inch. Looked at through the window-glass (I cannot get at the outside), a pocket-lens resolves it into nothing more than coarser dust, presenting much the appearance of iron filings round the pole of a magnet, in the manner it diverges from the centre. Can any microscopist inform me, through NATURE, whether the fungus actually takes root on the glass, or by what means it has been able to maintain its adherence through the many drenchings of rain and snow to which the window has been exposed during this stormy season?  
M. E.

Mountfield, Sussex, Dec. 20

#### The true Nature of Lichens

The writer of the criticism on "Hæckel's History of Creation," in NATURE, vol. xiii. p. 121, will confer a favour on British Lichenologists if he will explain what he means by asserting that "the true nature of Lichens has been cleared up" of late years.  
W. LAUDER LINDSAY

[The reviewer referred to the investigations of Prof. Schwendener, of Basel: "Untersuchungen über den Flechtenthallus" (Nägeli's *Beiträge zur wiss. Botanik*, 1868), and "Erörterungen zur Gonidienfrage" (*Flora*, May, 1872). A translation of the latter paper appeared in the *Quarterly Journal of Microscopical Science* (vol. xiii. p. 235). See also "A résumé of recent views respecting the Nature of Lichens," by Mr. Archer (*ibid.*, 1873, p. 217), and "Sexual Reproduction of Thallophytes," by Prof. Thiselton Dyer, in the same journal for last July, p. 296.—ED.]

#### The Boomerang

TRUSTWORTHY information respecting the performance of the boomerang is a desideratum. Reports from professed eye-witnesses as to its behaviour are frequently highly sensational and perplexing. It has been seen, so it is said, to strike an object with great violence and then to return to the hand of the projector! That its rapid rotation round the shortest axis passing through its centre of gravity should, as in the gyroscope, tend to make it keep its original plane of rotation, is clear. That its progressive force being expended before its rotatory force, it should tend to fall in the direction of the least resistance, *i.e.* to return on its path, need not be doubted. But striking an object with violence must, one would suppose, change its plane

of rotation; and then there would be no disposition to return on its path. In the notice in last week's NATURE of "Artes Africanæ" it is stated that the African boomerang is thrown so as to rotate in a horizontal plane; in which case, except by accident, there would be no tendency to return to the thrower, a mode of action supposed to be proper to the boomerang. Many know the toy boomerang made of card-board, "V" shaped, with one limb shorter than the other, say four and two and-a-half inches respectively. When this toy is laid on the smooth cover of a book held at an inclination of about 60°, and when the shorter limb projecting just beyond the edge of the book is struck with a smart filip of the finger so as to project it rotating rapidly at an upward angle of 60°, the toy will reach the further side of a room and return; but of course if it strikes anything its plane of rotation is changed and it falls irregularly.  
HENRY H. HIGGINS

#### OUR ASTRONOMICAL COLUMN

SMALL STAR WITH GREAT PROPER MOTION.—In vol. v. of the Madras Observations, Taylor mentions having observed in 1838 or 1839 a star of the 9th magnitude near to Brisbane 3458 (which appears not to have been found), the position of which, by three observations, is thus given for 1840:—R.A. 11h. 5m. 25.71s, N.P.D. 118° 59' 12".62.

Argelander twice observed a star of the same magnitude (Oeltzen, Nos. 11237-8) in zones 374 and 377, 1851 April 22 and 28, the mean place of which for 1850 is in R.A. 11h. 5m. 50.98s, N.P.D. 119° 1' 52".95. Assuming the identity of the stars observed by Taylor and Argelander, of which there can be little doubt, the comparison of positions for 1840 and 1850, taking the date of opposition of the star in 1838 as about the epoch of Taylor's observations, unfortunately not stated, shows an annual proper motion of  $-0.293s$  in R.A., and of  $-2''.74$  in N.P.D., or  $4''.72$  in arc of great circle in the direction  $305^\circ.5$ . If this amount of proper motion is confirmed, it will be fourth in order of magnitude of the great proper motions of stars yet satisfactorily ascertained, and the list will then stand as follows:—

	Proper Motion in Arc of great Circle.	Direction of Motion.	Magnitude.
Groombridge 1830...	7.05	145.0	7
61 Cygni ...	5.21	51.8	5½
Lalande 21185 ...	4.75	186.6	7
Taylor's star ...	4.73	305.5	9
ε Indi ...	4.63	124.8	5½
Lalande 21258 ...	4.40	282.4	8½
40 Eridani ...	4.09	212.0	4½
μ Cassiopeæ ...	3.83	115.3	5½
α Centauri ...	3.81	276.6	1

Lalande 21185, is "Argelander's second star" of Prof. Winnecke, and No. 21258 is the star called "Argelander's third" by Dr. Krüger.

If Taylor's observations of the star of ninth magnitude were made in 1839, it should be third on the above list, but the precise amount of proper motion must remain for comparison of Argelander's position obtained in 1851, with future observations, it may be hoped early in the next year.

The N.P.D. of Brisbane 3458 mentioned above, agrees exactly with that of Lacaille 4641, but the R.A. differs 1m. 8s.; the magnitudes are the same.

THE SECOND COMET OF 1702.—The first comet of this year does not figure in our catalogues of cometary orbits, no observations properly so-called having been obtained. In Europe the tail only was seen by Maraldi and Bianchini at the end of February and beginning of March. The second comet of 1702 was observed at Berlin, Paris, and Rome, in the last ten days of April and beginning of May, and orbits have been calculated by Lacaille and Burckhardt; the latter reduced the observations anew, but it does not appear what data he had besides those





along the pipe at A towards the bend. This force is administered to the fluid by the curved portion of the pipe at the bend DEF; and as the pipe is assumed to be rigid, the work of arresting the forward velocity of the fluid throws a forward stress on the pipe in a direction parallel to the line AC.

Let us now assume that to the right-angled bend AB we attach rigidly a second right-angled bend, BG, as shown in Fig. 30, in such a manner that the termination of this second bend

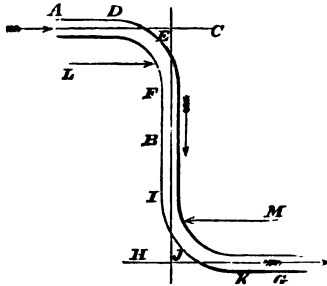

FIG. 30.

at G is parallel to the commencement of the first bend at A. Here I will again, for the present, deal only with the forces in a direction parallel to the line AC.

The fluid at B has no velocity in the direction of the line AC, and at G it has a velocity in that direction equal to the velocity which it had at A. To give it this velocity in a forward direction (I mean forward in its original direction of motion), to establish this forward momentum, requires the application of a force in the direction HG; and this force is administered to the fluid by the curved portion of the pipe at the bend IJK; and as the pipe is assumed to be rigid, the duty of establishing the forward velocity of the fluid throws a rearward stress on the pipe in the direction GH. Now as the forward momentum given to the fluid between B and G in the line GH is exactly the same as the momentum destroyed between A and B in the line AC, it follows that the rearward stress thrown on the pipe at the bend IJK is exactly equal to the forward stress thrown on the pipe at the bend DEF. Hence it will be seen that the forces acting on the rigid pipe AG, treated as a whole, balance, so far as relates to the forces parallel to the line AC, the original line of motion of the fluid—the forward stress acting on the pipe at the bend DEF being balanced by the equal rearward stress acting on the pipe at the bend IJK. These two of the forces acting on the pipe are shown by the arrows L and M, which, it must be remembered, are the only forces which act in a direction parallel to the line AC.

It will have been seen that the measure of these forces is the amount of forward momentum of the fluid which is destroyed or created; and from this it will be inferred that the forces will be the same, no matter what is the radius of the curve of the pipe, inasmuch as the curvature of the pipe does not affect the amount of the forward momentum that has to be destroyed or replaced in the fluid.

Let us next take the case of a bend in a pipe that is not a right angle, as shown in Fig. 31; and here, as before, I only

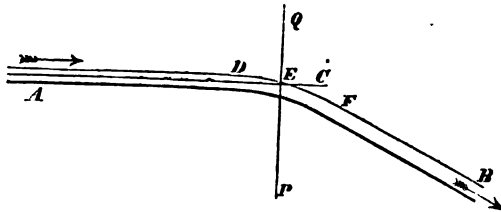

FIG. 31.

propose to deal with the forces that operate in a direction parallel to the line AC, that is, of the original motion of the fluid. Now in this case the forward motion of the fluid is not, as in the instance of the right-angled bend, entirely destroyed in its progress from A to A; only a portion of the forward motion is checked, and the same portion of the forward momentum destroyed; and the force by which it is destroyed is administered to the fluid by the curved portion of the pipe at the bend DEF, and, as in the former case, constitutes a forward stress on the pipe in the direc-

tion of the line AC, which will bear the same ratio to the stress which would follow from the destruction of the whole, as the portion destroyed bears to the whole forward momentum.

Suppose to this bend we attach rigidly another bend BG, of same angle, as shown in Fig. 32, so that the termination of this

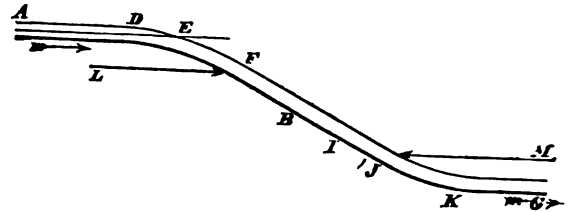

FIG. 32.

second bend at G is parallel to the commencement of the first bend at A. Here, in the portion of the pipe BG, that part of the forward velocity which was taken away has to be again given to the fluid; this requires force, which is administered to the fluid by the curved part IJK of the pipe. There is thus thrown on the pipe a rearward stress represented by M. The force required in the bend between B and G to restate completely the forward velocity, is evidently the same in amount as the force required in the bend between A and B to destroy in part the forward velocity.

It follows, therefore, that the two stresses on the pipe, represented by the arrows L and M, which indicate the forces acting on the pipe, are equal and opposite to one another, and these are the only forces acting on the rigid pipe in a direction parallel to the line AC or the original motion of the fluid at A. It follows, therefore, that in case of two right-angled bends rigidly connected, or in the case of two connected equal-angled bends of any other angle, the stresses brought on the pipe by the flow of the fluid will not tend to move the pipe bodily endways.

It will be seen also by this reasoning that the forces we have referred to do not depend on the curvature of the pipes, but are simply measured by the amount of the forward momentum of the fluid and the extent to which that momentum is modified by the total of the deflection which the course of the fluid experiences in passing the bend, or, in other words, by the angle of the bend. And from this reasoning it becomes apparent that by

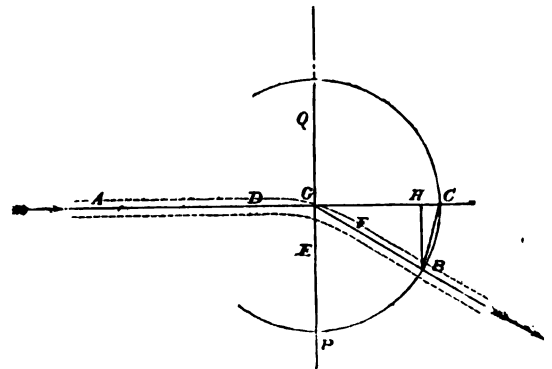

FIG. 33.

Let  $\text{AGB} =$  angle of bend.  
 Let  $\text{GC} =$  force required to destroy the whole momentum of fluid in line AC.  
 „  $=$  tension which would be put on pipe AD by a right-angled bend.  
 Then  $\text{HC} =$  force required to destroy momentum lost at the bend in the line AC.  
 And  $\text{HB} =$  force required to establish momentum acquired at bend in line AC.  
 $\therefore \text{BC} =$  total force acting on pipe.  
 This force must be in equilibrium with the tensions of pipe along BG and AC.  
 $\therefore$  the tension of pipe  $= \text{GC}$  or  $\text{GB}$ .  
 $\therefore$  the tension of pipe  $=$  the tension of pipe when the bend is right angled.  
 Therefore the tension of the bent pipe is constant for a given velocity of flow, whatever be the angle of the bend.

whatever bends or combinations of bends we divert the course of a stream of fluid in a pipe, provided the combination be such as to restore the stream to its original direction, the aggregate of the forces in one direction required to destroy forward momen-

tum are necessarily balanced by equal forces in the opposite direction required to reinstate the former momentum.

It will be useful to consider more in detail the action of all the forces operating on a fluid in a bend of the pipe; and I will return to the case of a single right-angled bend, as shown in Fig. 29. I before spoke merely of the forces acting parallel to the line AC, and said that the forward momentum of the fluid in that line had to be destroyed in its passage round the bend DEF, and that this must be effected by a force acting parallel to AC, which would throw a forward stress on the pipe, tending to force it in the direction AC. But similarly velocity has to be given to the fluid in the direction NB; and to do this a force must be administered to the fluid which will cause a reaction on the pipe in the direction BN; and as the momentum to be established in the direction NB has to be equal to that in the direction AC, which had to be destroyed, it follows that the forces of reaction upon the pipe in the directions AC and BN are equal. These forces can be met in two ways, either by securing the bent part of the pipe DEF so that it will in each part resist the stresses that come on it, or by letting the forces be resisted by the tensional strength of the straight parts of the pipe AD and BF operating in the direction of their length; and in this case we see that the tension on AD must be equal to the force acting along AC, and the tension on BF must be equal to the force acting along BN, so that in fact the forces brought into

cases, that the force required to establish sideways momentum parallel to QP cannot be directly met by the reaction of tension along the line BF of the second part of the pipe; but this force may be met by the obliquely acting tension of the pipe BF combined with the induced tension along the pipe AD. It is well known that in the case of a given force, such as that we are supposing parallel to PQ, resisted by two obliquely placed forces such as the tension along the lines DA and FB, the nearer the lines DA and FB are to one straight line, the greater must be the tension along those lines to balance a given force acting on the line PQ. Now the less the line FB diverges from the line AC, the less will be the sideways momentum parallel to QP that has to be imparted to the fluid; but at the same time and to precisely the same extent will the proportionate tension put upon the limbs DA and FB of the pipe be aggravated by the greater obliquity of their action. The sideways pull is greatest when the bend is a right angle; and then it amounts to a force that will take up or give out the entire momentum of the fluid, and it is supplied directly by the tension of the limb of the pipe at BF. If the bend is made less than a right angle, the less the bend is made, the less is the sideways pull, but the greater by the same degree is the disadvantage of the angle at which the tension on the pipe resists the pull; and it results from this that in the case of a bend other than a right angle,

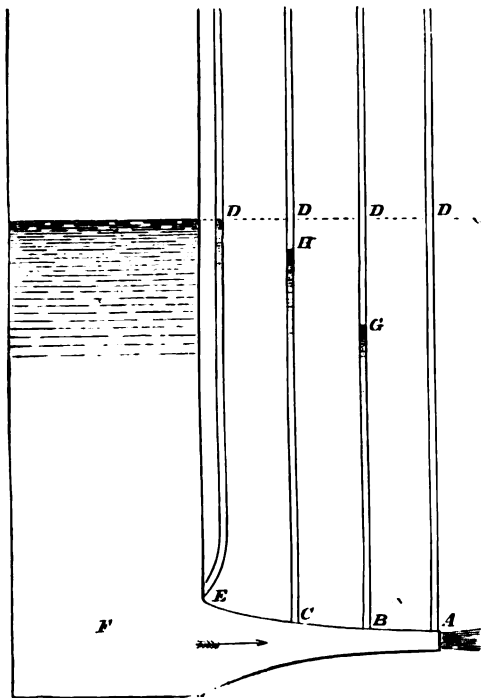

FIG. 34.

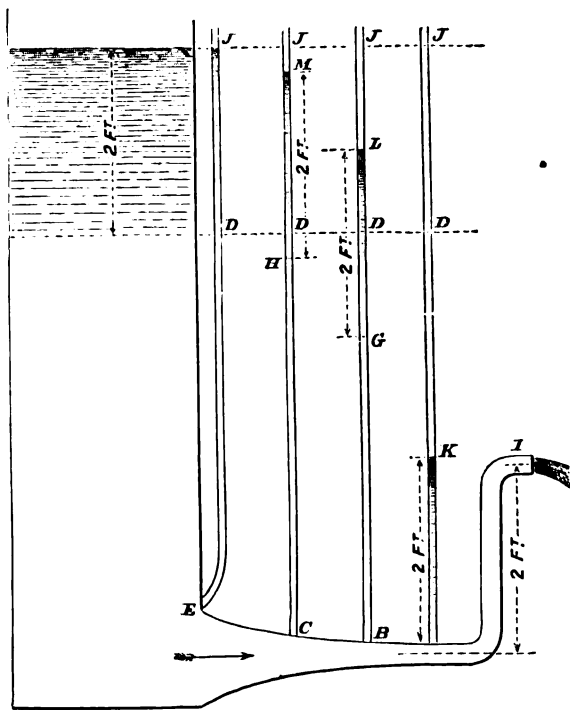

FIG. 35.

play by the right-angled bend produce a longitudinal tension on the pipe at either end of the bend equal to the force required to destroy the forward momentum of the fluid.

Proceeding to the case of the non-right-angled bend, as shown in Fig. 31: in this case, as we have seen, a portion only of the forward momentum of the fluid in the line AC has to be destroyed, also a certain amount of sideways momentum has to be created in a direction which we may consider parallel to the line QP; and the composition of the remaining forward momentum in the line AC with the created sideways momentum in the line QP, results in the progress of the fluid along the path FB; this partial destruction of forward momentum and establishment of some sideways momentum are essential to the onward progress of the fluid along FB. The bend DEF will be subject to the reaction of the forces necessary to produce these changes; and either the bend may be locally secured, or the stress upon it may be met, as in the case of the right-angled bend we have just been considering, by a tensional drag on the pipe at either end of the bend. There is, however, this difference between the

tension on the pipe is the same as in the case of a right-angled bend. A geometrical proof of this is given in Fig. 33. It is evident that the radius of curvature of the bend does not enter into this consideration, and that the forces acting are not affected by the rate of curvature of the pipe, the simple measure of the forces being the increase or decrease in the momentum of the fluid in each direction. It results from this that if a fluid be flowing along a pipe with a bend in it, no matter what may be the angle of the bend, or the radius of its curvature, the reactions necessary to deflect the path of the fluid will be met by a tensional resistance along the pipe; and this tension is equal to the force that would be required to entirely destroy the momentum of the fluid.

If we now assume any number of bends, of any angle or curvature, to be connected together (see Fig. 3), the equilibrium of each bend is satisfied by a longitudinal tension which is in every case the same; and this tension is therefore uniform throughout the pipe; for the tension at any intermediate point in a bend is clearly the same as at the ends of the bend, as we may suppose

the bend divided at that point into two bends, and there joined together by an infinitely short piece of straight pipe.

If, then, the tortuous pipe I have above referred to has its ends at A and B parallel to one another, as shown in Fig. 4, it is clear that the tensional forces at its ends balance one another, and the pipe, as a whole, does not tend to move endways.

#### NOTE B.

The law regulating these changes of pressure due to changes of velocity can be best understood by considering the case of a stream of perfect fluid flowing from a very gradually tapered pipe or nozzle placed horizontally and connected with the bottom of a cistern, as shown in Fig. 34. Let us suppose that at the points B and C the sectional areas of the pipe are severally twice and four times that at the point of exit A.

At the point of exit A the fluid is under no pressure whatever, since there is no reacting force to maintain any pressure; each particle of fluid in the issuing jet is rushing forward on its own account, neither giving nor receiving pressure from its neighbours. We know, however, what force it has taken to give the velocity which the fluid has at the point of issue A, and we measure this force by the pressure or head of fluid, lost. In the case we are considering, this head is represented by the height of the fluid in the cistern, or by the height AD.

Within the cistern, at the point E, on the same level as A, the point of issue—at this point E within the cistern, we have in effect the whole pressure due to the head of fluid equal to AD, but we have no velocity, at any rate the velocity is so small as to be inappreciable; and at the point of issue A we have no pressure at all, but we have what is termed the "velocity due to the head."

Let us suppose that at the points A, B, C, and E, gauge-glasses or stand pipes are attached so that the fluid in each may rise to a height corresponding with the pressure within the pipe or nozzle at the point of attachment.

The gauge-glass attached at A will show no pressure, thus indicating that the entire head AD has been expended in producing the velocity at the point A.

At the point B, as the sectional area is twice, the velocity is one-half that at A. Now the head required to produce velocity varies as the square of the velocity to be produced; in other words, to produce half the velocity requires one quarter of the head; thus of the whole head AD available, one quarter only, or GD, has been absorbed in developing the velocity at B, and the remainder of the pressure, which will be represented by the head BG, will be sensible at the point B, and will be exhibited in the gauge-glass attached at that point.

Again, as the pipe at C is four times the area that it is at A, it follows that, of the whole head AD, one-sixteenth part only, or HD, has been absorbed in developing the velocity at C, and the remainder of the pressure, which will be represented by the head CH, will be sensible at the point C, and will be exhibited in the gauge-glass attached at that point.

In the case I have chosen for illustration, the small end, A, of the nozzle, is open and discharging freely, and the pressure at that point is therefore *nil*. But the absolute differences of pressure at each point of the pipe or nozzle will be precisely the same (as long as the same quantity of fluid is flowing through it per second), however great be the absolute pressures throughout.

Thus, suppose that from the end of the nozzle at A a pipe of the same diameter, and of uniform diameter throughout its length, is curved upwards, so that the end of it, I, is two feet higher than A, as shown in Fig. 35; if the level of the cistern is also raised two feet, namely to the level marked J, instead of D, we shall have the same delivery of fluid as before; and the differences between the pressures at each point will be the same as before.

If we add 50 feet instead of 2 feet to the head in the cistern, and raise I to 50 feet, instead of 2 feet above the nozzle, the differences of head or pressure will still be the same, the head at A being 50 feet, that at B being BG + 50 feet, that at C, CH + 50 feet, and that at E (the cistern-level) ED + 50 feet.

To put the case into actual figures, suppose the sectional area at A to be 1 square inch, that at B 2 square inches, and that at C 4 square inches, and suppose that the fluid is passing through the nozzle at the rate of one-ninth of a cubic foot per second, we shall have a velocity at A of 16 feet per second, to generate which would require a difference of pressure between E and A, equivalent to 4 feet of vertical head. The velocity at B will be 8 feet per second, which would require a difference between E and B equivalent to 1 foot of head. That at C

will be 4 feet per second, and will require a difference of pressure equivalent to 3 inches of head. If the pressure at A be zero, the pressures at B, C, and E will be 3 feet, 3 feet 9 inches, and 4 feet respectively. If the pressure at A be 1 foot, the pressures at B, C, and E will be 4 feet, 4 feet 9 inches, and 5 feet respectively; and if the pressure at A be 1,000 feet, the pressures at B, C, and E will be 1,003 feet, 1,003 feet 9 inches, and 1,004 feet respectively, always supposing the quantity of fluid passing per second to be the same. If the quantity be different, the absolute differences of pressure will be different, but will be relatively the same. If, for instance, the quantity flowing per second be doubled, the velocity at each point will be doubled, and the differences of pressure quadrupled; so that if the pressure at A were again 1,000 feet, those at B, C, and E would be 1,012, 1,015, and 1,016 feet respectively.

To sum up—the differences of hydrostatic pressure at different points vary as the differences of the squares of the velocities at those points.

#### NOTE C.

Here again the argument given in the text suggests certain other lines of argument which some persons may feel interested in following out.

Suppose each and every one of the streams into which we have subdivided the ocean, to be inclosed in an imaginary rigid pipe made exactly to fit it, throughout, the skin of each pipe having no thickness whatever. The innermost skin of the innermost layer of pipes (I mean that layer which is in contact with the side of the body), the innermost skin, I say, of this layer is practically neither more nor less than the skin or surface of the body. The other parts of the skins of this layer, and all the skins of all the other pipes, simply separate fluid from fluid, which fluid, *ex hypothesi*, would be flowing exactly as it does flow if the skins of the pipes were not there; so that, in fact, if the skins were perforated, the fluid would nowhere tend to flow through the holes. Under these circumstances there clearly cannot be any force brought to bear in any direction by the flow of the fluid, on any of the skins of any of the pipes except the innermost skin of the innermost layer. Now, remembering that we are dealing with a perfect fluid which causes no surface-friction, we know that the fluid flowing through this system of pipes administers no total endways force to it. But it produces, as we have just seen, no force whatever upon any of the skins which separate fluid from fluid; consequently, if these are removed altogether, the force administered to the remainder of the system will be the same as is administered to the whole system, namely, no total endways force whatever. But what is the remainder of the system? Simply the surface of the body, which is formed, as I have already said, by the innermost skins of the innermost layer of pipes. Therefore no total endways force is administered to the surface of the body by the flow of the fluid.

Lastly, let us recur for an instant to the case of fluid flowing through the single flexible pipe. Here it was proved that the flow of the fluid through it, if it was anchored at the two ends, did not tend to displace any part of it, because the centrifugal forces produced by the flow of the fluid, and which must act exactly at right angles, or normally, as it is called, to the line of pipe at each point, are exactly counterbalanced by a uniform tension throughout the length of the pipe. If the flexible pipe has variations in its diameter, the differences of quasi-hydrostatic head appropriate to those variations are also normal to the surfaces of the pipe, being simply bursting-pressures. If, however, these normal forces were directly counterbalanced by equal and opposite and normal external forces or supports, it is obvious that this tension would be entirely relieved. Now, if we suppose the system of pipes which we have several times already imagined to surround the submerged body, to be flexible pipes (instead of rigid pipes, as we have before imagined them), the counterbalancing, or normal, external forces which exactly relieve the tension are supplied to each pipe by its neighbour, except in the case of the innermost skin of the innermost layer of pipes, since this innermost skin has no neighbour. In this instance the counterbalancing, normal, external forces are supplied by the rigidity of the surface of the body. Now we know that, since the tensional forces produced by the flow of fluid through a flexible pipe, whether of uniform or varying sectional area, have no sum total of endways force, the counterbalancing forces which exactly relieve this tension must also have no total endways force; and since the counterbalancing forces acting throughout the whole system have thus no sum total of endways force, it can be proved, as before in the case of the similar system of rigid

pipes, that if we remove the whole of the skins or sides of pipes, which separate fluid from fluid and which are all therefore necessarily in perfect equilibrium, the forces acting on the remainder, namely, on those skins which are in contact with the surface of the body, forces which therefore may be considered as acting simply upon the body, must also have no endways sum total.

### THE MELBOURNE OBSERVATORY

THE Board of Visitors to this Observatory made its annual visitation on June 2, 1875. Mr. Ellery, the Government Astronomer, having obtained leave of absence, the Board found the staff of officers and all the instruments in charge of Mr. White, in whose management it unhesitatingly expresses its fullest confidence.

The buildings and instruments are in good condition, and several new and important instruments have been added to the establishment during the period under notice. These include a photo-heliograph from Dallmeyer, of London, who constructed it under the advice of Dr. Warren de la Rue; an equatorial refractor of eight inches aperture, made by Troughton and Sims, under the advice of Sir George Airy; a portable equatorial, of 4½ inches aperture, by Messrs. Cook and Son, of York; and a double-image micrometer by Mr. Browning.

The various publications of the Observatory are in a forward condition. The First Melbourne General Catalogue of 1,227 Stars, for the epoch 1870, was published early in October, in time to be distributed among the different parties charged with the observation of the transit of Venus, by whom its great utility was acknowledged.

The observatory staff had much work to do in connection with the observation of the transit of Venus, not only having to make the necessary preparations for observing the transit at their own stations, but also to assist with the requisite observations for finding the positions of the stations occupied by the different nations in that part of the world. The arrangements made by the Observatory were all that could be desired.

With regard to the ordinary work of the Observatory, Mr. White reports as follows:—

"The work with the transit circle has consisted of the usual standard stars for finding the time, and the position of the instrument; close circumpolar stars, low stars for refraction, stars with which bodies had been compared off the meridian, stars culminating with the moon, the moon itself, and stars whose places were required by outside observers for any special purpose.

"The numbers of the recorded observations are as follows:—R.A. observations, 2,064; P.D. observations, 1,150; Observations of error of collimation, 111; observations of error of level and nadir, 180; observations of error of runs of microscopes, 47; observations of error of flexure, 35.

"The state of the reductions is as follows:—

"R.A. observations up to date.

"P.D. observations.—The stars observed in 1873 are reduced with the exception of 212, which require the corrections to reduce them from their apparent to their mean places. Of the stars observed in 1874, 865 are wholly unreduced, 267 have the reductions applied as far as the refraction, 45 are reduced to their apparent places, and the remaining 45 are fully reduced. Of the stars observed during the present year, 184 are fully reduced, 46 are reduced to their apparent places, and 122 are wholly unreduced.

"The magnetical and meteorological instruments are under the special charge of Mr. Moerlin. Absolute values of the magnetic elements have been made as usual once a month, and they are all reduced up to date. The photographic curves from the magnetographs, barograph, and thermographs, are developed on every alternate day, but as yet no general tabulation of them has been made; only occasional measures are taken from them for special purposes. The ordinary meteorological observations made at Melbourne and the different stations in the colony are reduced to date; the Monthly Records in Meteorology and Magnetism are prepared to the end of April, and are in the printer's hands; owing to press of work, however, in the Government Printing Office, the Records to the end of December 1874 only have as yet been received. The Yearly Report for 1873 is in hand, and that for 1874 will be prepared as soon as possible.

"The great telescope, under the especial charge of Mr. Turner, has been diligently worked during the last twelve months, except during the time that we were engaged in the special ob-

servations connected with the transit of Venus, when Mr. Turner took turns with Mr. Moerlin in observing the occultation of stars by the moon. In accordance with the strongly expressed opinion of the Board in the last Report, the work done has consisted principally of drawing the nebulae, and mapping the neighbouring stars; ten of the nebulae and clusters figured by Sir John Herschel have been carefully drawn, and the positions of the stars have been laid down from micrometric measurements. One nebula has been observed which is not to be found in any catalogue in our possession. Coggia's comet was examined on eighteen nights, and fifteen drawings of it obtained. A drawing of the nebula surrounding  $\eta$  Argus, with the stars accurately plotted in, made this year, shows no appreciable change when compared with the one made last year.

"Besides the occultation of stars by the moon, referred to before, and of which ninety-six were looked out for, and only fifteen observed, owing to the unfavourable weather of the time, a fine series of observations for positions of Coggia's comet was obtained by Mr. Ellery and myself; an observation of Encke's comet was also obtained during the present month; all of which, including the occultations, have been sent for publication to the *Astronomische Nachrichten*."

The Report concludes with a brief account of the results obtained at the four Government stations during observations of the transit of Venus.

### PROF. PARKER ON THE WOODPECKERS AND WRYNECKS

ANOTHER admirable paper by Prof. Parker, exhibiting the same industry, successful elucidation of detail, and mastery of morphological principle that have characterised all his publications, appears in the recently-issued volume of "Transactions of the Linnean Society." It is chiefly devoted to an exposition of the palatal structures of the Picidæ and Yungidæ, made intelligible by the study of nestlings and young birds. The conclusions of Prof. Huxley in his paper in the "Proceedings of the Zoological Society" for 1867 are substantiated and placed on a broader basis; and thereby another chapter has been permanently added to the history of the connection between Reptiles and Birds. The assistance which scientific naturalists all over the world may render to necessarily sedentary students like Mr. Parker, by the preservation and transmission of young specimens of various ages, is nowhere more clearly manifested than in the paper now spoken of. Mr. Parker's study of Woodpeckers, both of hard and soft parts, dates from the year 1843; and the unpublished results of that labour, in the form of minutely-careful drawings, are still of considerable value for reference. Again and again the study was resumed, with somewhat unsatisfactory results, until the opportunity of dissecting young birds and of comparing them with southern species threw sufficient illumination on the difficult problem of their palatal structure.

An introduction to the paper serves to point out the proper relations between the zoologist and the embryologist. "Each kind of labourer," says Prof. Parker, "has the greatest need of the results brought out by the other: the patient dissector waits for the treasures supplied to him by the more mercurial taxonomist; whilst he, in turn, profits by the work of one to whom a single type may serve for the labour of a year or more. Yet both are learning to look beneath the surface of things, a growing knowledge of the types showing both that close kinship is often marked by great difference in outward form, and that it is easy to be beguiled by the external likeness of forms—*isomorphic*, indeed, but far apart zoologically."

A defence is made against those who would accuse the author, as well as Prof. Huxley, "of taking a narrow view of the bird-types, touching with the point of a needle some little tract, but unacquainted with and not able to appreciate the Bird as a whole." Such an accusation charges the broadest-minded men with possessing a cast of mind which would utterly disqualify them for the distinguished positions they hold. In the present case the exclusive description of the palatal structures is easily defended: for "that territory contains parts that have undergone the greatest amount of metamorphosis of any in the whole body of a high and noble vertebrate; and moreover, being in the bird the skeletal framework of the whole upper face, these parts are, as it were, an index of the amount of specialisation undergone by any particular type—the ruling determining structures that lead to all, and really demand all, the changes that take place in the rest of the organism."

Breadth of view is indeed essential, if anywhere, in such an investigation as the present. A restricted insight and experience would fail to detect and to demonstrate the substantial unity of structure existing in the palate of Lizards and of Woodpeckers, still more to establish the more minute relationships between the Rhynchosaurian Hatteria and various members of the Woodpecker group. This is what has been done. The well-defined group of the Woodpeckers, including the sub-family of Wrynecks, is so connected by its embryonic and adult palatal structures with the Lizards, that the name "Saurognathæ" is to be substituted for the morphologically-unexpressive term "Celeomorphæ," applied to them by Prof. Huxley. Their palatal region is arrested at a most simple and Lacertian stage, whilst in other respects they are metamorphosed and specialised beyond any other kind of birds.

The characteristics of the Saurognathous type of palate may be summarised as follows:—Retention and ossification of trabecular cornua; great number and bilateral independence of the vomerine series of bones, some of which are azygous (vomeres, septo-maxillaries, median septo-maxillary); absence of a distinct mesopterygoid, represented, however, by a long process; a dagger-shaped basipalatine between the right and left bones; absence of a distinct transpalatine; abortive development of maxillo-palatine plates, and presence of a distinct palato-maxillary on the left side only.

One of the most instructive specimens figured is *Picumnus minutus*, a woodpecker from Bahia, Brazil, of about the size of the Golden-crested Wren. In it the vomeres retain in the adult the condition manifested in the young of the Green Woodpecker, and much resembling the vomeres of Hatteria. In other respects it presents resemblances to various Passerines of its own zoological area; and from it the author's imagination is led down to extinct types in which the characters of the Hemipod, the low Passerine, and the Woodpecker were existent in one generalised form—a form (and a type only a step or two above the Ostrich tribe).

Numerous hints are given in this paper which lead us to look with great interest for Prof. Parker's forthcoming paper on the Ægithognathæ (Passerines) in the Zoological Transactions; and we may fitly close this notice with a pregnant passage referring to the Ægithognathous palate, showing to what problems of surpassing import these researches are supplying an answer. "I have long been familiar with its more marked peculiarities; but its morphological importance dawned upon me when I saw that the parts of that complex face, so conjugated and so metamorphosed, were really built up of elements which had their true counterparts or "symmorphs" in the Snake. But the Snake does but repeat these parts from the Amphibia; and the Amphibia borrow them from the Cartilaginous Fishes, amongst the lowest of which, namely the Lamprey, may be found the fullest development, both morphologically and functionally, of cartilages that form the substratum of the most peculiar part of a sparrow's face."

#### NOTES

At the meeting of the Zoological Society, on Tuesday next, Prof. Huxley will read an important paper on the Anatomy of *Ceratodus* and *Chimæra*, and on the Classification of Fishes.

At the recent anniversary meeting of the French Geographical Society M. Maunoir, the General Secretary, gave a highly satisfactory report. The receipts of the Society exceed 70,000 francs; ten years ago they were only 28,000. The number of members admitted from the beginning of the year is about 350, and about 1,400 are now registered. The receipts from money taken at the doors of the Geographical Congress and from donations, amounted to 175,000 francs, and the expenses to 155,000; a sum of 20,000 francs remaining in the hands of the Society will be devoted to the publication of the congressional papers. The place of meeting of the next congress has not yet been decided upon; it will probably be St. Petersburg.

THE *Daily Telegraph* publishes further details concerning Lieut. Cameron's expedition obtained from the Madeira correspondent of the paper. Cameron, it seems, intended to remain at Loando until an opportunity arrived for sending his men home round by the Cape to the East Coast. It is understood that the traveller has accumulated some very valuable geogra-

phical materials, besides a large amount of general scientific information. It appears that he followed a large river flowing out of Lake Tanganyika in a south-westerly direction, tracing its whole course till he came upon a new lake, which he named "Livingstone." From this body of water a second large river runs westward, which Cameron, having traced it for a considerable part of its length, believes to be the Congo. It would seem that he was unable to continue along the river on account of meeting with a tribe of hostile natives. He had to choose between fighting his way through these unfriendly natives, with the risk of losing all his journals and papers, or of taking a different direction. The latter alternative seemed preferable, and though it prevented the absolute verification of his important discovery he has personally no doubt that the stream flowing out of the Livingstone Lake and the Congo are one and the same.

THE *Birmingham Gazette* understands that Sir Josiah Mason is about to make another very substantial gift to the new scientific college which he is now building at Birmingham. When the foundation-stone was laid in February last it was understood that the mere building of the college would cost 100,000*l.*, and Sir Josiah also transferred to trustees, as an endowment for the college, the piles of buildings in which his monster pen manufacture had so long been conducted. Now Sir Josiah is also about to hand over to the trustees the business itself, or rather the whole amount which he is about to receive for the concern, and which is expected to be about 100,000*l.* The whole of this sum, it is said, Sir Josiah intends to give to the college. The money will probably be invested in the names of the local gentlemen who have already been appointed trustees, and will form a permanent endowment for the institution.

A PRIVATE gentleman, being about to make a voyage to the West Indies in pursuit of objects of interest in natural science, has arranged to avail himself of the companionship and scientific services of the Rev. H. H. Higgins, of Liverpool. He will probably be away about four months cruising about the islands, and he will take with him two gentlemen—one a draftsman, and the other a collector, from the William Brown Street Museum, Liverpool. The expedition is made expressly for observations and collections in zoology and botany, and Mr. Higgins will have an opportunity of carrying on dredging operations. Very advantageous terms have, we believe, been arranged as to the division of the treasures which will be the result of the voyage. Mr. Higgins will be glad to receive suggestions with regard to the work he is about to undertake.

THE scientific public will be glad to learn that a movement has been set on foot to enlarge the existing Wigan Mining and Mechanical School, inaugurated eighteen years ago by Dr. Lyon Playfair, and now numbering nearly 200 evening students. At a public meeting held at Wigan on the 24th inst., attended by nearly all the colliery proprietors of the district, resolutions were passed, resolving to establish a permanent building with museum, laboratory, and all the appliances for giving a thorough technical education in Mining, Mechanics, Geology, Machine Construction, Steam, and Chemistry. Large subscriptions have already been promised, including 1,000*l.* from Lord Crawford and Balcarres, 500*l.* from Mr. Hewlett, the Managing Director of the Wigan Coal and Iron Company, who promise 125*l.* a year.

ON Monday the Prince of Wales opened the new Zoological Garden at Calcutta, recently formed under the auspices of the Lieutenant-Governor of Bengal.

THE Municipal Council of Paris has voted a handsome sum of money in support of the State Academies of Paris. The vote was carried by twenty-three against nineteen. The minority was composed of clericals who are opposed to the instruction given by Government, and ultra-republicans, who are opposed to the grant of any money for superior instruction.



CAPT. MOUCHEZ leaves Paris shortly to command the war vessel which is to complete the Hydrographical Survey of the Algerian coast. The expedition is expected to be away for a full year.

MR. HENRY WILLETT, the hon. secretary of the Sub-Wealden Exploration, has issued his 14th quarterly report. He states that the contractors are laudably endeavouring, at their own cost, to enlarge the bore-hole, so as to enable them to reach 2,000 feet and to produce cores undeniably satisfactory to the promoters. Mr. T. Warner, of Brighton, is willing to contribute 400*l.* in all for the next 500 feet after 2,000 feet. The ultimate decision as to the continuance of the work will rest with the central committee in London, who will, of course, be guided mainly by the question of finance.

INTELLIGENCE received at Madrid on the 28th from the Philippines announces that a terrible hurricane swept over the provinces of Albay and Camarines, in the southern part of the Island of Manilla, on the 30th of November. Two hundred and fifty persons are stated to have been killed, and 3,800 inhabited houses, the crops, and a considerable number of animals were destroyed. General consternation prevailed in Manilla.

THE French Society of Ethnography has granted its great medal to the memory of Doudard de Lagrée, the organiser of a scientific exploration on the banks of the Mekong in Indo-China.

THE official paper of the Governor-General of Algeria announces that the Algerine Meteorological Board has completed its organisation and will be very shortly placed in communication with the international service presided over by M. Leverrier. Weather telegrams from various places will be sent daily.

THE Academy of Sciences held its anniversary meeting on Monday. M. Bertrand delivered an *loge* on General Poncelet, the great geometer and mathematician, who died twelve years ago, leaving a number of most valuable books, of which a general edition has been published recently. Amongst the prizes distributed was one to M. Denayrouz for his apparatus for working in mines and for submarine explorations.

THE cultivation of coffee in India is steadily progressing, and although the introduction of the plant into the eastern portions of the country is of ancient date, it is only within the last twenty years that much attention has been given to its production. The principal plantations are situated in Mysore and the Neilgherry Hills, at an elevation of 3,000 to 4,000 feet above the level of the sea. The climate of these districts, besides being well adapted to the cultivation of the coffee-plant, is not so injurious to the health of Europeans as many other parts of the country, and it is probable that the industry will be largely developed. In 1842 the value of coffee exported from British India was 74,957*l.* Ten years later it had advanced to 84,306*l.*; in 1862 to 462,380*l.*, till in 1872 it had increased to 1,380,410*l.*

AT the same time the cultivation of tea is advancing even more rapidly, though its introduction is much more recent. The Assam tree is celebrated for its fine quality. The existence of this tea-producing country was only recognised in 1834, when Lord Bentinck introduced some Chinese growers, and the trade became firmly established. In 1842 the value of tea exported was 17,244*l.*; in 1852, 59,220*l.*; in 1862, 192,242*l.*; and in 1872, 1,482,186*l.*

THE *Journal of the Asiatic Society of Bengal*, vol. xlv. part 2, contains a paper by Capt. J. Waterhouse, Assistant Surveyor-General of India, on "Photography in connection with the Observation of the Transit of Venus at Roorkee."

THE Report of the Dundee Free Library Committee is drawn up with great care and considerable elaboration, and contains

some very useful statistics as to the numbers of books issued in various departments, and the classes to which the readers belong. As might be expected the books taken out in light and miscellaneous literature are in an overwhelming majority, though those belonging to the various sciences have a creditable amount of patronage which we hope to see gradually increase. We think a more satisfactory classification of the sciences might be adopted than that contained in the Report. The Natural History Museum connected with the Library is evidently being enriched with valuable specimens, and we are glad to see the Naturalists' Society is prospering. There is also a University Club housed in the building, which numbers 140 members, and "seeks in the first instance to foster Culture and the Higher Education, with the ulterior object of cultivating public opinion in the direction of University extension in Dundee."

THE ravages of the Phylloxera among the vines have caused many attempts to be made to discover a new kind of beverage which might take the place of the juice of the grape. The Marquis de Villeneuve reports that in China a *pseudo* wine called *Tsien-ia* is much used, which is concocted from a preparation of four plants, common in that country, and mixed together in certain proportions. The plants are dried and powdered, and made into a paste, which is sold in the form of balls or squares at the rate of about 3*l.* a pound. One square or ball will make several pints of a fermented liquor, pleasant to the taste and much resembling wine, which is much sought after by Europeans and others living in China. A factitious brandy is also prepared in the same way, and the manufacture is so simple that with a capital of 5*l.* or 10*l.* to purchase the apparatus, a man may make twenty-five gallons of "brandy" a day. The Marquis de Villeneuve affirms that the "wine" thus produced is of good quality and possesses no injurious ingredients.

PART 2 vol. i. of the "Transactions of the Watford Natural History Society" is to hand, containing the four papers read on May 13 last, besides a number of miscellaneous notes and observations.

MR. G. H. KINAHAN has published a paper read by him at the Royal Historical and Archæological Association of Ireland, on some prehistoric antiquities in the neighbourhood of Drumdarragh, Co. Antrim.

ABOUT a year ago we noticed the publication by the New England Society of Orange of the "Babbit Portfolio," containing some beautiful photographs of remarkable trees in the neighbourhood of Orange. The same Society has recently issued the "Haskell Portfolio" (after a well-known citizen of Orange), containing photographs of other fine trees, even finer in execution, we think, than the previous ones. The trees represented are the Condit Chestnut (*Castanea vesca*), the Sugar Maple (*Pyrus malus*), the Park Tulips (*Liriodendron tulipifera*), and the Essex Maple (*Acer rubrum*).

WE have received the Report of the first Annual Conference and Exhibition of the Cryptogamic Society of Scotland, held at Perth on Sept. 29, 30, and Oct. 1; both conference and exhibition seem to have been a complete success.

STATISTICIANS calculate that there are now in work some 200,000 steam-engines, with a total power of 12,000,000 horses, corresponding to the muscular strength of 100,000,000 men.

ALMOST all the Carthaginian antiquities which had been sunk with the *Magenta* have been recovered by Denayrouze's diving apparatus and submarine lamp.

THE additions to the Zoological Society's Gardens during the past week include a Black Lemur (*Lemur macaco*) from Madagascar, presented by Captain Burke; a White-fronted Lemur (*Lemur albifrons*) from Madagascar, a Night Parrot (*Stringops*

*habroptilus*) from New Zealand, a Grey Ichneumon (*Herpestes griseus*) from India, deposited; a Yellow Baboon (*Cynocephalus babouin*) from W. Africa, purchased; a Gaviol (*Gavialis gangeticus*) from India, presented by Capt. Barnet: a Common Fox (*Canis vulpes*) European, presented by Mr. W. Saville.

### SCIENTIFIC SERIALS

THE *Journal of the Royal Agricultural Society of England*, Second Series, No. xxii.—The contents of this number are most attractive. To science is assigned the leading place in the arrangement. The first paper is devoted to the Colorado potato-beetle, and is from the pen of Mr. Bates, F.L.S., who does not profess to impart any original information, and who is unable to come to any definite conclusion as to the probability of its appearing in these countries. The paper is calculated to confuse rather than to enlighten us on this point. For while in one place the author goes to show that the possibility of living specimens arriving here cannot be doubted, he observes elsewhere that the analogies of the case supply ground for confidently believing that there is exceedingly little probability of their propagating and spreading in this country. We are also told that "the creature has developed extraordinary flexibility of constitution and habits since it left its quiet home in the Rocky Mountains, and that we cannot be quite sure what it will eventually do." In another passage Mr. Bates says:—"The potato-beetle is no insidious enemy, like the majority of insect plagues, but meets the farmer in open fair fight." What does he mean by a fair fight between an insect which destroys whole fields and districts, and the helpless farmer?—Mr. Carruthers, F.R.S., consulting botanist to the Society, contributes a paper and a note on the potato disease. In the "paper" he reports on what he calls the results of the competition for the prizes offered through the Society in 1874 for potatoes which would resist the disease for three years in succession. The "note" gives a brief account of Mr. Worthington Smith's discovery of the resting spore of the potato fungus. The paper must have been written before the discovery. The truth is the discovery throws a curious shadow not only on the paper but on the course pursued by the society in connection with the whole subject. We were not quite prepared to find that the consulting botanist of this great society would be permitted to announce, as he has done in this paper, that in investigating this disease we must summarily dismiss the soil from our consideration. "Neither soil, nor methods of cultivation," we are told, "exercise any influence on the prevalence of the disease." For the present we can only say these statements are as unsound as they are astounding. The *Journal* contains a long paper on laying down land to permanent pasture, which is a joint production. The bulk of the information is given second-hand; that is to say, on information furnished by several agriculturists, a long paper is based by the joint authors. The number contains too much matter of this character. The views of an American naturalist on the Colorado potato-beetle are given in a paper by Mr. Bates. Mr. Carruthers seeks to enlighten us on the potato disease by information collected from various sources; and a number of scattered facts on one of the most important of agricultural subjects—the profitability of pasture as compared with arable land—are grouped and reviewed in a great variety of ways, some of which are calculated rather to mislead than to enlighten the reader. There are several passages in the paper which will produce the impression that the gentleman to whom has been assigned the chief part of the joint authorship is not intimately acquainted with agriculture as at present practised. We take one passage as an illustration:—"There are many persons so enamoured of a special rotation—say the four-course—that to extend the period of artificial grass to two years appears to them a violation of all the true principles of scientific farming. The four-course is their ideal of modern farming. A course of cropping which has been proved highly beneficial on some of our most famous corn-growing districts is supposed to be the only legitimate system to be pursued by intelligent farmers elsewhere." Who are the persons referred to? It may be well to remind the gentleman who wrote this paper that English farmers are calling out for more freedom of action in the cropping of their land, and that for several years past vast numbers of them have been doing that which he would appear to have discovered in 1875. We cannot at present make room for further criticism on this paper; and we are glad to be able to state that the number contains several meritorious articles.

THE *Journal of the Chemical Society* for November contains Dr. Hofmann's Faraday lecture, entitled "The Life-work of Liebig in Experimental and Philosophic Chemistry; with allusions to his influence on the development of the collateral sciences and of the useful arts." The lecture is illustrated by a portrait of Liebig, and an autotype copy of a letter from Liebig to Faraday.—Prof. J. W. Mallet contributes a paper on achromatite, a new molybdo-arsenate of lead, and Mr. W. J. Lewis a note on the crystallography of Leucaurin, being an appendix to a former paper by Messrs. Dale and Schorlemmer.—The journal contains its usual number of valuable abstracts from foreign periodicals.

*Morphologisches Jahrbuch*.—In the second part of this journal Dr. B. Solger discusses the homology of the cervical vertebrae and nerves in the Sloths, and concludes that the vertebrae up to the 22nd are homologous in *Cholecepus* and *Bradypus*, but that the homologies of the first twelve nerves cannot be determined; the nerves from the 13th to the 23rd are homologous.—Another paper by Dr. Solger describes two cartilaginous pieces in the visceral skeleton of *Chimera monstrosa*, which appear to have been hitherto unnoticed.—Dr. Hermann Fol gives an account of the so-called endostyle of Huxley in various genera of Tunicata, and appears to establish it satisfactorily as a slime-gland. Excellent figures of its ciliated and glandular epithelia are given.—Prof. Gegenbaur devotes twenty-two pages to a consideration of the omohyoid muscle, which he believes to be a remnant of a continuous muscle whose origin extended from the sternum along the clavicle to the scapula. He also gives an account, with microscopic sections, of the nipples in *Didelphys* and in *Mus dummanus*.—Dr. Carl Hasse's paper on *Amphioxus lanceolatus* is devoted to a demonstration of the structure of the eyespots, in which he finds cells which may be designated optic cells, as distinguished from the pigment-cells.—Prof. Gegenbaur occupies forty-seven pages with a detailed and very hostile criticism of Götze's recently-published work on the Development of the Toad as a basis for the Comparative Anatomy of the Vertebrata. He censures it in very many respects as empirical and unscientific.

*Jahrbuch der kais.-kön. geologischen Reichsanstalt*, band xxv. No. 2.—In this number of the *Jahrbuch*, Dr. E. Tietze, who has been some time in Persia, describes the springs and spring-formations that occur in Demavend mountain and its neighbourhood; most of the springs are thermal, and deposit large quantities of calcareous tufa.—The next paper gives details of the work done in the chemical laboratory of the Geological Survey, and includes upwards of 200 analyses.—Dr. C. Doelter describes the geological structure, the rocks, and minerals of the Monzoni Alps in the Tyrol. This paper is illustrated with a geological sketch-map and two plates of minerals.—Among the "Mineralogical communications" the most generally interesting paper is one by Professor Fuchs on the earthquakes and volcanic eruptions of 1874. He enumerates 123 earthquakes, distributed as follows:—Winter 37; (Jan. 12, Feb. 15, Dec. 10); Spring 32; (March 12, April 11, May 9); Summer 25; (June 7, July 5, Aug. 13); Autumn 29; (Sep. 9, Oct. 9, Nov. 11).—The remaining papers are these:—"On Sahlite as a rock-constituent," by E. Kallowsky; "On the chemical composition of meionite," by E. F. Neminar; "On Lievrite," by L. Sipócz; "On the minerals occurring in the metalliferous veins of the Příbram region," by F. Babanek; "On rocks from the island of Samothracia," by J. Niedzwiedzki.

### SOCIETIES AND ACADEMIES

LONDON

Royal Society, Dec. 9.—"On some Electro-magnetic Rotations of Bar-magnets and Conducting-wires on their Axes," by G. Gore, F.R.S.

In [all] the published forms of Ampère's experiment of the electro-magnetic rotation of a vertical bar-magnet or conducting-wire upon its axis by Ampère, Faraday, Sturgeon and others, the magnet or wire has either been immersed a large portion of its depth in mercury, or its middle part has been connected by a wire with a surrounding annular channel filled with mercury, and the electric current passed into or out of the magnet or wire by means of that liquid, and the mercury has formed an essential part of the arrangement.

In all published cases of rotation of bar-magnets on their axes by the influence of electric currents, the two ends of the magnet

has had *dissimilar* poles. By meditating upon certain facts connected with this subject, I concluded that, by passing a current from one end to the other of a magnetized rod or wire having *similar* poles at its two ends, the magnet would probably rotate, and experiment has demonstrated that conclusion.

Upon a thin wooden tube 15 centims. long and 7 millims. bore, I wound a cotton-covered copper wire 1·7 millim. diameter, from one end of the tube to the middle, then reversed the direction of winding, and continued to the other end and back to the middle, again reversed, and coiled to the first end of the tube; by which arrangement the passage of a current through the coils produced two similar poles at the ends of the tube, and two others of the opposite kind at the middle.

The tube being now fixed in a vertical position, a straight iron wire 15 centims. long, and 1·8 millim. diameter, pointed at its lower end, and surmounted by a brass mercury cup 5 millims. diameter, containing a drop of mercury, was supported entirely within the tube and free to rotate, by a similar cup (surmounting a fixed vertical brass rod), at the lower end of the tube; the upper end of the axial wire being kept in position by a vertical brass rod fixed above the coil and terminated at its lower end by a sharp point of platinum in the mercury cup.

A current from 6 one-pint Grove's elements, arranged as 3, being now passed through the coil, brass rods, and axial wire, the latter rotated rapidly.

A copper wire substituted for the iron one would not rotate, probably because copper is so little capable of acquiring longitudinal magnetism.

To ascertain if the coil-current simply performed the function of longitudinally magnetizing the axial wire, I took an iron wire 23 centims. long and 2·7 millim. diameter, sharp-pointed at its lower end; soldered to its upper end a double wire of cotton-covered copper, each wire being 1·7 millim. diameter, coiled the double wire upon the axial rod in two layers, and so as to enable two *similar* poles to be formed at the extremities of the axis, and terminated the copper wires by a little brass mercury-cup just above the top end of the vertical iron axis. By supporting this apparatus as the axial wire in the previous experiment, and passing the current, rotation occurred.

Reversing the direction of the current did not reverse the direction of rotation.

These experiments, produce a striking effect in a lecture, because the rotation appears to be produced without reaction of the moving part of the apparatus upon any external or fixed body.

In each of these cases of rotation, an upward vertical current entering a lower south pole or leaving an upper one, caused the upper end of the rod to rotate in the direction of the hands of a watch, and a downward current entering or leaving a north pole also produced that direction of motion, and reversing the poles in either case reversed the effect.

In each of these instances of rotation, without the aid of a current near the middle of the magnet, the coil being so constructed that the current in it could not be reversed without reversing that in the fixed conductors near it, reversing the direction of the current did not reverse that of the rotation, because the two acting influences were reversed together, and therefore each apparatus had its own direction of rotation, either right handed (☺) or left handed,\* according to the direction in which its coils were wound. It follows from this that a current, the direction of which is alternately reversed, will drive the apparatus quite as well as one in one uniform direction.

I now endeavour to increase the effect. For this purpose I substituted for the upper brass rod a fixed coil consisting of one layer of copper wire upon an iron wire axis, but having dissimilar poles at its ends and no poles at its middle part, and placed between it and the lower brass rod a right-handed one free to rotate. The opposed poles of the fixed and movable coils were of opposite kinds, *i.e.* north and south. On passing a current from a Noe's thermo-pile of 96 elements, † connected as 24, rapid rotation in a right-handed direction occurred. I now substituted for the lower brass rod another fixed coil, similar to the upper one, but of an opposite direction of polarity, and passed the current again; still more rapid rotation in the same direction took place, and the effect was very striking. In this latter instance, two south poles free to move were opposed to two fixed north poles, and in each instance the current was passed upwards.

I now substituted for the movable coil a vertical wire of iron

\* By a "right-handed" coil, I mean one the upper end of which rotates in the same direction as the hands of a watch.

† I have found this apparatus very convenient for such experiments.

13 centims. long and 1·7 millim. diameter, surmounted by a small brass mercury cup; passed the current from the thermo-pile, and obtained rotation, but less rapid than before; but by inclosing this wire in the axis of a fixed coil which produced appropriate and similar poles at its two ends, as in paragraph 3, and repeating the experiment, very great velocity of rotation was obtained. Rotation of a somewhat thicker wire of nickel was also obtained, both with and without the aid of the current in the middle fixed coil. I also tried, without the aid of the middle fixed coil, and with it, a copper wire of similar dimensions to the iron one, and obtained rotation freely. Each of these rotations agreed in direction with those of the movable coil.

The apparatus represented in the annexed sketch was employed for nearly all the various modifications of the experiment, by substituting for one or more of the coils metallic wires, &c., as desired. The upper part of the brass pillar A was capable of sliding in the lower part B, and could be fixed by a screw C, which encircled the split end of the tube B. The fine adjustment was effected by means of the screw D, the lower end of which rested upon the top of a tall brass rod inside the brass pillar. The upper and lower fixed coils or rods E and F were insulated from the brass clips G and H, and the battery was attached to the binding-screws I and J. K is a binding-screw for connecting with the upper coil or rod.

I also obtained rotation of the iron wire whilst the wire was in a horizontal position, its ends resting in hollows in the ends of the iron axes of the two fixed coils, and the ends of those axes and of the movable wire lying upon the surface of pools of mercury in small watch-glasses. The movable iron wire was inclosed in the axis of a thin iron tube within a fixed coil, having appropriate and similar poles at its ends. The current from the thermo-pile produced very rapid rotation. This result proves that the rotations are not due to terrestrial magnetic influence.

As the directions of magnetic polarity, electric current, and rotation agree with those in the different forms of Ampère's experiment, and as in most, if not all, of the previously known cases of rotation of a bar-magnet or conducting-wire on its axis an electric current passes through the end of the bar or wire, it is evident that those rotations were due, not only to the portions of current in the mercury, and fixed conductors connected with it, near the middle of the magnet or wire, but also to the influence of the currents in the fixed conductors near the ends of the magnet or wire.

[Note added September, 1875.—It having been suggested by Professors Maxwell and Stokes that the rotation in the foregoing experiments was due to the influence either of the magnetism of the fixed magnets or of the current in the fixed conductors, near the ends of the movable wire or magnet, upon the portions of current in the cups of mercury, I diminished the internal diameter, both of the upper and lower cups, from 4 millims. to 1·75 millim., and arranged the following apparatus and experiment.

The fixed upper wire was of brass 2·5 millims. diameter and 60 millims. long; it had no coil upon it, and was used as a conductor only; its lower end terminated in a fine point of a steel needle protecting 6 millims. The lower fixed wire, also used as a conductor only, was of platinum to resist the action of the mercury; it was 2·3 millims. diameter and 75 millims. long, with a cavity in its upper end 3·5 millims. deep and 1·75 millim. diameter, and containing a thin plate of ruby in its lower part, with a minute hole in the centre for the needle point to rotate in. The movable wire was 2·5 millims. diameter and 125 millims. long, its upper half being composed of soft iron and its lower half of brass; its lower end terminated in a needle-point like that of the upper fixed wire, and its upper end had a cavity and perforated ruby plate like that in the lower fixed wire. A voltaic coil 60 millims. long and 7 millims. internal diameter, composed of four layers of cotton covered with stout copper wire, was used to magnetize the iron half of the movable wire, and fixed by means of a separate support in a proper vertical position beforehand, so as to inclose in its axis the iron wire portion only. The little cups were also each half filled with a minute globule of mercury before putting the movable wire into its place.

After adjusting the wire so as to make rotation easy, a current from 6 Grove's elements of one-pint capacity, arranged as a series of 6, also as a double series of 3, was passed through the coil and vertical wires; and the direction of the portion of the current in the coil alone, also in the vertical wires alone, was varied; but notwithstanding that plenty of current passed, no signs of rotation could be detected. These results, therefore,

strongly support the opinion that the rotation in the experiments was due to the action of the portions of the current in the cups of mercury.]

Linnean Society, Dec. 16.—Dr. G. J. Allman, F.R.S., president, in the chair.—The following papers were read:—On the structure and development of the bird's skull (part II.), by W. K. Parker, F.R.S. This and the former paper are parts of a large piece of work done by the writer in this particular field. A similar paper on the skull of Passerine birds appears in the present number of the Transactions of the Zoological Society; to be followed by another on the same subject. The writer's wish to work out a large series of well illustrated papers on the bird's face arose from the new interest given to this special research by Prof. Huxley's masterly memoir "On the Classification of Birds" (Proc. Zool. Soc., April 11, 1867), and his paper "On the Classification and Distribution of the Alectoromorphæ" (Ibid, May 14, 1868). The writer has worked out this subject in two ways, viz., by exhaustive work at one type of skull, making research in every part, and also by taking a part of the skull, [the fore-face, and comparing this part in many types. The present paper is a piece of the latter kind of work, but begins with some new embryological details to serve as a supplement to his memoir on the fowl's skull (Phil. Trans., 1869); and this especially with regard to the development of that most interesting but puzzling bone, the "columella auris." This is shown to be developed in the house-martin (*Chelidon urbica*) in the same manner as in the reptilia. As Prof. Huxley sought, in his memoir, to give a morphological classification of birds based on the cheeks and palate, it has been the wish of the writer to carry on his friend's work, and to test it as well as extend and give it form and body. In the present paper the meaning of the peculiar structure of the face in crows, sparrows, warblers, &c. (Prof. Huxley's Coracomorphæ), is sought to be made plain by reference to the development and metamorphosis of the parts. In these the single vomer of the adult is shown to be constructed out of four bones and two cartilages; and all this composite structure is seen in them to be fused with the nasal capsule. This form of face, the most specialised of any of the class is called the "Ægithognathous" face or palate; and the huge army of birds possessing it are called "Ægithognathæ." Thus we have two terms for the group; first, a zoological "Coracomorphæ;" and second, a morphological "Ægithognathæ;" and these two groups are almost superimposable. In other birds, however, with open palates, the "Schizognathæ;" or with strongly closed and united palates, the "Desmognathæ," the zoological and morphological groups are not capable, in many instances, of being laid fairly the one on the other. Prof. Huxley put the Goatsuckers and Humming-birds amongst his "Ægithognathæ;" in the present paper they are shown to be as truly schizognathous as the Fowl or the Plover. In this paper the skull of these two types is largely illustrated. Many kinds of the desmognathous type of palate are described and figured, and their varieties explained. This is largely done with the birds of prey, amongst which the writer puts the Carriama (*Dicholophus*). Lastly, the schizognathous face is illustrated in the skull of the Sea-mew. Birds of the Gull tribe are shown to arise from the specialisation of the Plover type; they are a high kind of Charadriian bird. An interesting discussion followed, in which Dr. P. L. Sclater and Dr. Murie took part.—Notes on the plants collected and observed at the Admiralty Islands March 3-10, 1875, by Mr. H. N. Moseley.—On a spore of *Paritium tricuspis*, by Dr. C. King.—Supplement to the enumeration of the fungi of Ceylon, by the Rev. M. J. Berkeley and Mr. C. E. Broome. Two interesting new genera are here described, *Endocalyx* and *Actiniceps*, possibly intermediate between Myxogastres and Trichogastres.

## CAMBRIDGE

Philosophical Society, Nov. 29.—The following communication was made to the Society on the temperatures observed in a deep boring at Sperenberg near Berlin, as given in a report of a paper by Professor Mohr, of Bonn, by Mr. O. Fisher (NATURE, vol. xii. p. 545). The greatest depth recorded is 3390 feet. The temperatures are given in Reaumur's scale. The author showed that the equation

$$v = -\frac{251}{10^3} x^2 + 0.012982x + 7.1817,$$

in which  $v$  is the temperature, and  $x$  the depth, exactly represents the temperature curve. This curve will give a maximum temperature of

$$40^{\circ}.7532 \text{ R., or } 123^{\circ}.6947 \text{ Fah.,}$$

at a depth of 5171 feet. If there was no cause to disturb the temperature, it ought to conform to a straight line, given by the above equation altered by omitting the term in  $x^2$ . Consequently a cause was sought which would change such a straight line to the parabolic form. The first cause examined was a change in the conductivity of the strata depending on the depth, and it was found that a law, which would make the conductivity vary inversely as the distance of any point above the level of greatest temperature, would account for the observed facts. But it was argued that such a law was entirely improbable. The next cause examined was the effect of the percolation of meteoric water through the strata, and the result was found to be that this circumstance would account for the observed temperatures, provided the quantity of water which passed through the rock in a unit of time bore a certain ratio to the quantity of rock passed through. The quantity of water requisite to produce the effect had not been determined. It was remarked that the results of this investigation make it appear that the true law of underground temperature would be better obtained from borings of moderate than of very great depth, because the disturbance of the temperature curve from the rectilinear form is greater the further we descend.

## MANCHESTER

Literary and Philosophical Society, Nov. 8.—Alfred Brothers, F.R.A.S., in the chair.—The fauna of Cymmeran Bay, Anglesea, by John Plant, F.G.S. (part 2).

Nov. 30.—Edward Schunck, F.R.S., president, in the chair.—On the estimation of very small quantities of lead and copper, by M. M. Pattison Muir, F.R.S.E., Assistant Lecturer on Chemistry, Owens College.—On certain circumstances which affect the purity of water supplied for domestic purposes, by M. M. Pattison Muir, F.R.S.E., Assistant Lecturer on Chemistry, Owens College.

## BERLIN

German Chemical Society, Dec. 13.—A. W. Hofmann, president, in the chair.—Lothar Meyer described an experiment to show that iodine does not fuse in a vacuum-tube but only in tubes filled with air; pressure being a condition of its fusion.—E. Schunck and H. Roemer have found a new isomeride of alizarine in the residues of the manufacture of the latter body. It is soluble in cold baryta-water with a dark red colour, likewise in lime-water. Its power of crystallisation is very great; but for dyeing purposes it is useless.—L. Friedburg compared various methods for purifying sulphuret of carbon. For manufacturing purposes he recommends distillation over palm-oil; but to obtain it chemically pure he prefers the action of fuming nitric acid, which attacks the impurities only, but not the sulphuret of carbon. At the same time a violet substance is formed. Sulphuret of carbon dissolves nitrous, hyponitrous, and sulphurous acid gas.—A. Flickiger has studied the explosive decomposition of white precipitate mixed with iodine.—E. de Souga heated the amalgams of silver and of gold to the temperature of boiling sulphur and found that at this temperature they retained a considerable proportion of mercury.—V. Merz and K. Schellenberger proved cyanogen to be able to produce substitution in aromatic hydrocarbons.—F. Beilstein and A. Kurbalov described the preparation of dichloraniline and of trichloraniline by passing chlorine into a solution of aniline in acetic acid.—W. Michler has succeeded in forming a urea with four ethyl groups, replacing its four atoms of hydrogen, by passing oxchloride of carbon into diethylamine. This compound, tetra-ethylated urea is a liquid, and this fact explains that it has been overlooked by former investigators.—Aug. Laubenheimer described metachloronitrobenzol and its derivatives, viz. a chlor-azobenzol, chlor-hydrzobenzol, and chlor-oxazobenzol; compounds distinguished by their power of crystallisation.—H. Scheiding has transformed bromonitro-naphthylamine (alpha) by oxidation into phthalic acid, and draws conclusions from this fact to explain its constitution.—L. Jackson has prepared a brominated bromobenzol and a brominated soluidine.—C. Liebermann and Gissel have investigated the relationship between two compounds, viz., chrysophanic acid,  $C_{14}H_6(OH)_2O_2$ , contained in rhubarb and other plants (isomeric with alizarine); and of chrysamminic acid,  $C_{14}H_2(NO_2)_4(OH)_2O_2$ , a product of the action of nitric acid on aloes. It has generally been supposed that the latter substance is a nitro-substitution compound of the former. This, however, is now proved to be erroneous. Hydrochrysammine, the reduction-product of chrysamminic acid is now proved to be



and not  $C_{14}H_{12}N_4O_2$ , as formerly stated by Dr. Schunck. The

sulphate of this body, treated with nitrous acid, yields a new isomeride of alizarine, called chryszazine, and not chrysophanic acid, as would be the case if the former view were correct. At the same meeting, therefore, two new isomerides of alizarine have been announced, and thus of eight isomerides considered possible according to present views, seven have actually been discovered.

## VIENNA

Imperial Academy of Sciences, Oct. 14.—The following papers, &c., were communicated:—Description of a new airship, by M. Codron.—The crania of the Novara collection, by M. Zuckerhandl.—Notes from the chemical laboratory of Innsbruck University, by M. Barth and others (treating of the action of fuming sulphuric acid on benzo-sulpho-acid and benzo-disulpho-acid, some derivatives from ellagic acid, nitro derivatives of anthraflavone, new naphthalene derivatives, and ferrocyanide of tetramethylammonium).—The independent formation-law of continued fractions, by M. Günther.—The development of the Euler Algorithmus, by M. Klug.—Researches on the separation of aqueous vapour in plants, by M. Eder. He first examines the external surfaces of plants as regards permeability for aqueous vapour; then the evaporation through leafless branches; and thirdly, the behaviour, as regards evaporation, of those parts of plants that are richer in water. He then describes experiments on transpiration of leafy branches and rooted plants under various conditions of moisture, light, motion of air, &c.—On the action of glycerine on starch at high temperatures, by M. Zulkowsky.—On the heat phenomena which occur on solution of ammonia in water, and their utilisation in employment of this salt for cold mixtures, by M. Tollinger.—On hypertrophic thickening in the interior of the aorta, by M. Schnopfhagen.—On Malfatti's problem, and the construction and generalisation by Steiner, by M. Mertens.—On Cinchonin, by M. Weidel.—On the heat-equilibrium of gases acted on by external forces; on the heat-conduction of gases; and on integration of partial differential equations of the first order, by M. Boltzmann.—Observations (meteorological and magnetic) at Vienna Observatory, in July to September.

Oct. 21.—An experiment towards explaining terrestrial magnetism, by M. Benedict.—Involutions of the chords in cissoids, by M. Jahradnik.—Researches on the colouring matters of bile, part v., On the action of bromine on bilirubin, by M. Maly. He shows that the molecule of bilirubin is twice as large as has hitherto been supposed.—On the double tangents of curves of the fourth order with three double points, by M. Durège.—Researches on the nature of the salmon (*Salmo Schiffermülleri*, Bloch) found in the lakes of Salzkammergut, Salzburg, and Berchtesgaden, by M. Fitzinger.—On occurrence and biology of Laboulbeniæ, by M. Peyritsch.

Oct. 28.—On development of the elements of Crustacea, by M. Hceber.—Report on a journey in the western part of the Balkan and neighbouring regions, by M. Toula.—On a new condensation-product of gallic acid, by M. Oser.—On the green colouring matter of *Bonellia viridis*, by M. Schenk.

Geological Society, Nov. 16.—The discovery of lake dwellings in the peat-bogs near Laibach, by Ch. Deschmann. These were discovered accidentally on the occasion of a road ditch being opened, and were afterwards systematically explored for the Laibach Museum. The extent of the lake-dwellings hitherto uncovered amounts to about 600 square fathoms. They cover an area of about 13 fathoms in breadth, extending parallel to the border of the ancient lake. The piles, some thousands in number, are rammed into the clay which forms the bottom of the peat-bog, their broken ends projecting 1 or 2 feet above the clay. Above the latter lies a deposit 5-6 inches thick, containing chiefly the remains of human industry, together with bones of various animals. This again is covered by the peat to a thickness of 5-6 feet. The lake-dwellings near Laibach are of special interest on account of the great abundance of bones and harts-horn, most of them showing signs of workmanship. The remains of stag alone that were found are supposed to belong to 200 different individuals; and besides various remains of ox, buffalo, hog, wild boar, goat, sheep, bear, badger, beaver, more rarely of wolf and lynx, &c., were discovered.—On the volcanoes of the Isle of Réunion (Bourbon), by Dr. R. Drasche. The author proved that the eruptive action since the first outbursts has proceeded continually from west to east. The oldest lava streams have an acid (strachytic) character; the later, up to the present day, are basaltic.—A fossil land-turtle from the Vienna basin, by G. Haberlandt. It was found in the later Tertiary, in a quarry near Kalksburg,

and is the first land-turtle ever discovered in Austrian Niogene deposits, whilst sea and river turtles occur frequently therein. The fossil was named *Trionix precedens*.—M. Zugmaier showed an *Inoceramus* found in the Vienna sandstone near Klosterneuburg, a very important discovery in reference to the geology of the Alps, regarded as forming another proof of the justness of the views always maintained by the Austrian geologists, that the sandstone-strata bordering the northern part of the Alps belong chiefly to the Cretaceous period.—M. Paul gave a report of the results obtained by him in the course of last summer concerning the Karpathian Sandstone in Silesia, Hungary, and the Bukovina, that forms a direct continuation of the Alpine Vienna Sandstone just mentioned. He is convinced that the so-called Ropianka group of these sandstones, which contains the petroleum, belongs also to the Cretaceous formation.—M. Vacek exhibited an interesting fragment of a jaw-bone from a very small and probably young *Mastodon longirostris*, found in the Belvedere strata near Vienna. It had been presented to the Geological Institution by Lieut. Tihu.

## WELLINGTON, N.Z.

Philosophical Society, Aug. 7.—Address by the President.—Dr. W. Z. Buller, C.M.G., gives a narrative of the progress of the scientific societies in New Zealand, and the various works which have been written on the natural history of the colony, and reviews the work done by the Society during the past year, as published in vol. vii. of the "Transactions" of the New Zealand Institute:—"From year to year the scientific work of the New Zealand Institute has kept pace with the rapid progress of the colony, and the last volume of 'Transactions' (No. vii.) is in every way worthy of its predecessors, both as to bulk and quality. On a cursory perusal it is evident that our Society has done its fair share of work during the year, no less than twenty-four of the papers selected by the governors as worthy of publication having emanated from our members. As most of you are aware, our vice-president, Mr. Travers, is one of the most industrious of our working members, and the present volume contains a lengthy contribution from him, entitled 'Notes on Dr. Haast's supposed Pleistocene Glaciation of New Zealand.' The author dissents entirely from the learned doctor's views, as propounded in his report to the Provincial Government of Canterbury in 1864, and since repeated; and following up his former article on 'The Extinct Glaciers of the South Island,' he has now placed before us an able exposition of his own views on this subject. Another important paper read before the Society during the past year is that by Dr. Hector, on Whales; and the excellent plates which accompany it, from photographs by Mr. Travers, add much to the interest of the article. It contains a full description of *Neobalæna marginata*, founded on a specimen which was captured among a large school of black-fish at Stewart's Island, and forwarded to the Colonial Museum by Mr. Charles Traill; also of the 'sulphur-bottom' (*Physalus australis*), the skeleton of which is now in the Wellington Botanic Gardens; and of that interesting form of zyphoid whale known as *Berardius hectori* from a specimen cast ashore in Lyall Bay in January last. It is to be hoped that Dr. Hector will be able to carry out his intention of publishing while in England a monograph of the Cetacea inhabiting the Southern seas, for which, as he informs me, he has collected and taken home ample material. There is probably no other section of Zoology in which a contribution of this sort would be more acceptable to the savans of Europe, owing to the present neglected state of its literature and the confusion of nomenclature in which many of the species are involved. There is another article from the same pen, on New Zealand Ichthyology, which contains descriptions of no less than sixteen new species of fishes, all taken recently on our coast, thus proving that this field of investigation is far from being exhausted. In the section Botany, the first article is a paper read by Mr. Buchanan in November last, on the flowering plants and ferns of the Chatham Islands, the materials being drawn from the collection in the herbarium of the Colonial Museum, nearly the whole of which was made by Mr. Henry Travers during his two expeditions to those islands in 1866 and 1871. The article throughout bears testimony to Mr. Buchanan's usual care and accuracy, and the illustrations, five in number, are very beautifully executed. That of the so-called Chatham Island Lily (*Myosotidium nobile*), a handsome plant, with large glossy leaves and clusters of blue flowers, which I was fortunate enough to discover during a visit to the Chathams just twenty years ago, is especially noticeable. Our late president, Dr. Knight, resuming a subject in which he has already

made several important contributions to science, presents us with a valuable paper on New Zealand lichens, and with another containing descriptions of some new species of *Gymnostomum*, all the carefully drawn illustrations being from the author's own pencil. The papers on chemistry have emanated, as usual, from Mr. Skey, the analyst to the Geological Survey, the value of whose work in this department of science has already been brought prominently before you by a former occupant of this chair. I will not detain you longer, as there are several papers to be read; but I would just point out that the eminently practical treatise by Mr. Lemon, on duplex telegraphy, and the suggestive paper by Mr. Mackay, on the hot winds of Canterbury, show that other subjects have been discussed, and that the attention of our Society has not been confined to any particular branch of scientific inquiry; that, on the contrary, it has during the past year kept in view the avowed object of its existence, viz. 'the development of the physical character of the New Zealand group: its natural history, resources, and capabilities.'—A paper was read from the Ven. Archdeacon Stock, containing remarks upon a large bat that had been seen by him in 1854, which he believed to be a new variety. Mr. Kirk stated that he had seen a large bat at the Clarence River, but he had been unable to distinguish it from *Scotophilus tuberculatus*.—The President read a paper entitled "Notes on *Gerygone flaviventris*." The paper contained extracts from "The Birds of New Zealand," and observations in reply to a paper from Mr. Justice Gillies, in last year's volume of "Transactions."—A paper entitled "Remarks on Dr. Finsch's Paper on Ornithology in vol. vii. of 'Transactions of the New Zealand Institute,'" was also read by the President. The paper contained criticisms on Dr. Finsch's views respecting classification, as propounded in a paper read before the Otago Institute. A discussion ensued, in which the author of the paper and Messrs. Kirk and Graham took part, on the question, "What constitutes a species?" The President contended for the specific value of *Apteryx mantelli* of the North Island, on the ground that it was readily distinguishable from the other bird, and that the variation was constant; while Prof. Kirk agreed with Dr. Finsch, who proposes to call it *Apteryx australis* var. *mantelli*, considering that the bird discovered in the North Island is merely a variety of the species in the South—*Apteryx australis*—the slight difference between them being insufficient to warrant their separation.

Aug. 21.—J. Carruthers, C.E., Engineer-in-chief for the Colony, on volcanic action regarded as due to the retardation of the earth's rotation.—Mr. J. C. Crawford, F.G.S., On the igneous rocks of Wellington. The paper pointed out in a lucid manner the course that past explorations had taken in regard to the igneous rocks of this province, and indicated the direction that future explorations should take.

## CALIFORNIA

Academy of Sciences, Sept. 20.—Dr. Blake made some remarks on the old Sierra glacier in the neighbourhood of Johnson's Pass, at the head of the south fork of the American river. The pass forms a low gap in the mountains about 7,500 feet above the sea, and extends about a mile and a half from north to south, the summit of the mountain being nearly level for that distance. To the east of the pass and 1,000 feet below is Lake Valley, fifty miles long from north to south, and twenty miles broad in some parts; this valley contains the basin of Lake Tahoe, which has a depth of 1,600 feet. The topography of the pass is such that no moraine matter would reach the head of it until the basin of Lake Valley was filled by ice above the level of the pass, or by a glacier 1,000 feet thick, nor during the decline of the cold would any extensive glacier form there after the level of the ice in Lake Valley had fallen below the level of the pass. Such being the case, we have at the head of the American valley the results of glacial action during the middle of the glacial epoch, or at least during the time the glacier in Lake Valley was increasing from a thickness of 1,000 feet to a thickness of 1,600 or 1,700, and also whilst it was diminishing from its maximum depth down to the level of the pass. The indications are that during this period a very high summer temperature must have prevailed, alternating with the greater cold of winter. The considerations on which this conclusion is founded are, first, the fact that no permanent ice-covering could have existed at the head of the pass at the time the Lake Valley glacier had already reached a thickness of 1,000 feet, otherwise moraine matter could not have been deposited in the vast moraines now found at the head of the pass.

Notwithstanding the great winter cold and the increased snowfall, at least far on in the glacial epoch, the heat of the summers must have been more than sufficient to thaw the annual snowfall at this elevation when its thickness was not increased by inflowing glaciers. Another fact indicating the existence of a high summer temperature is the comparatively small extension of the glacier down the valley of the American river. During the height of the glacial epoch the thickness of the glacier at the head of the valley must have been 600 or 700 feet above the level of the pass, and yet the bulk of the moraine matter it transported has been deposited as terminal and lateral moraines within eight miles of the summit. As the valley in this distance has only fallen about 800 feet the melting of the ice must have been much more rapid than it would be with our present summer temperature.—Mr. Lowry, of the U.S. Coast Survey, read a paper on a modification of what is known as the three-point problem in hydrographical surveying, by which a position would be determined by means of two points the distance of which was known, and a point on the shore of undetermined distance.

## BOOKS AND PAMPHLETS RECEIVED

BRITISH.—The Universe: F. A. Pouchet, M.D. (Blackie).—Time and Time Tellers: J. W. Benson (Hardwicks).—Official Guide to the Manchester Aquarium; W. Saville Kent.—Report of the First Annual Conference of the Cryptogamic Society of Scotland.—Memorials of Harvey: J. H. Aveling, M.D. (Churchill).—Tales and Traditions of the Eskimo; Dr. Henry Rink (Blackwood).—The Sea: Jules Michelet (Nelson).—The Arctic World (Nelson).—Map of India indicating the probable Route of the Prince of Wales (Stanford).—The Cruise of the *Desper*: Captain Bax (Murray).—Solid Geometry, Vol. i.: P. Frost (Macmillan).—Water Analysis: J. D. Macdonald (Churchill).—Physics of the Ether: S. Tolver Preston (Spon).—Proceedings of the Geological Association, Vol. iv. No. 4.—Quarterly Journal of the Geological Society, No. 124.—Quarterly Journal of the Meteorological Society, No. 16.

AMERICAN.—Abstract of Results on a Study of the Genera *Geomys* and *Thomomys*: Dr. Elliott Coues, U.S. Army.—Elements of Infinitesimal Calculus: James G. Clark (Lockwood).—On a New Method of obtaining the Differentials of Functions: J. Minot Rice and W. Woolsey Johnson (New York, Van Nostrand).—Theory of the Moon's Motion: J. N. Stockwell, M.A. (Boston, Lippincott).—Systematic Catalogue of the Vertebrate of the Eocene of New Mexico: E. D. Cope, A.M. (Washington).—Address of the Ex-President Joseph Lovering before the American Association, Hartford.—A Review of the Fossil Flora of North America: Leo Lesquereux (Washington).—Monthly Report of the Department of Agriculture, U.S.—Memoirs of the American Association for the Advancement of Science, 1875 (Salem).—The Spider of the United States: N. M. Heutz, M.D. (Boston).

FOREIGN.—Jahresberichte der Commission zur Wissenschaftlichen Untersuchung der deutschen Meere in Kiel, 1873-3.—Memoire de la Société de Physique et d'Histoire Naturelle de Genève.—Classification de 40 Savons Végétaux: M. Bernardin (Gand, Annot-Bræckman).—Ueber die Störungen der Grossen Planeten insbesondere des Jupiter: P. A. Hansen (Leipzig, S. Hirzel).

## CONTENTS

	PAGE
MONTEIRO'S ANGOLA ( <i>With Illustrations</i> ) . . . . .	161
WORKS ON THE BLOWPIPE . . . . .	164
THE ROCKS AND MINERALS IN THE MELBOURNE MUSEUM . . . . .	165
OUR BOOK SHELF:—	
Gould's "A Monograph of the Trogonidae" . . . . .	166
Mietzsch's "Geology of Coal" . . . . .	166
LETTERS TO THE EDITOR:—	
Evidences of Ancient Glaciers in Central France.—Dr. J. D. HOOKER, P.R.S. . . . .	166
Sir Thomas Millington and the Sexuality of Plants.—ALFRED W. BENNETT, F.L.S. . . . .	166
Saw-fish inhabiting Fresh Water.—Dr. A. B. MEYER . . . . .	167
Spectrum of Fish-pigment.—GEORGE FRANCIS ( <i>With Illustration</i> ) . . . . .	167
Function of the Ocelli of Hymenopterous Insects.—Dr. HERMANN MULLER . . . . .	167
The House-fly.—M. E. . . . .	168
The True Nature of Lichens.—Dr. W. LAUDER LINDSAY . . . . .	168
The Boomerang.—Rev. HENRY H. HIGGINS . . . . .	168
OUR ASTRONOMICAL COLUMN:—	
Small Star with great proper Motion . . . . .	168
The Second Comet of 1702 . . . . .	168
The Total Solar Eclipse of 1909, August 11 . . . . .	169
The Zodiacal Light . . . . .	169
THE THEORY OF "STREAM LINES" IN RELATION TO THE RESISTANCE OF SHIPS, IV. By WM. FROUDE, F.R.S. ( <i>With Illustrations</i> ) . . . . .	169
THE MELBOURNE OBSERVATORY . . . . .	173
PROF. PARKER ON THE WOODPECKERS AND WRYNECKS . . . . .	173
NOTES . . . . .	174
SCIENTIFIC SERIALS . . . . .	176
SOCIETIES AND ACADEMIES . . . . .	176
BOOKS AND PAMPHLETS RECEIVED . . . . .	180



THURSDAY, JANUARY 6, 1876

## LASLETT'S "TIMBER AND TIMBER TREES"

*Timber and Timber Trees, Native and Foreign.* By Thomas Laslett, Timber Inspector to the Admiralty. Crown 8vo, pp. 352. (London: Macmillan and Co. 1875.)

IN all parts of the world where the vegetation partakes of an arboreous character, the wood is applied by the natives either for building their huts or houses, for their canoes or war-vessels, or for various domestic purposes, according to the extent of civilisation under which they live. This universal application of timber dates back to the earliest ages, and though the world's consumption of wood has been increasing ever since, and more especially in modern times, the supplies have never yet absolutely failed. Though the trade in timber, properly so called, that is for building purposes as distinguished from ornamental woods, is one of immense proportions and great value, the more general application of iron at the present day for constructive purposes has to some extent, no doubt, prevented a dearth in the timber market. Notwithstanding this substitution of iron both in shipbuilding and in general mechanical work, no absolute diminution in the quantities of timber imported into this country has been effected. On the contrary, the official returns show a gradual increase both in rough and in planed or *dressed* timber, large quantities of which now come regularly from Sweden and Norway, from Russia, British North America, and other countries.

There are but few, if any, of our commercial articles, whether they be of home or foreign produce, that have a wider range of interest or more numerous ramifications than the wood and timber supplies. Primarily the subject may be divided into two divisions, the first dealing with timber as used for constructive purposes, and the second with woods as used by the cabinetmaker or for ornamental work; and still another important division is that of dye woods.

When we consider that the value of timber chiefly for building purposes imported into this country during the year 1874 amounted to over twenty millions sterling, it is surprising that so little is generally known or so few books have been written on a subject of such great commercial and general importance. Besides the produce of our own forests, composed for the most part of oak, larch, fir, ash, beech, &c., the bulk of the wood imported from Sweden, Norway, Russia, &c., is the produce of coniferous trees, the botanical origin of which are for the most part known; but over and above these are numerous woods which, though they are and have been articles of commerce for many years past, are still quite unknown as to their botanical sources. And it is not a little remarkable that most of these unknown woods are the produce of some part of the South American continent. From Brazil and Paraguay, for instance, we are constantly receiving samples of finely-marked hard and apparently durable woods, but no information ever reaches us of the nature of the trees furnishing these woods. If collectors would only bear in mind that samples of wood with native

names only are next to valueless, and would use every endeavour to secure and bring home a flowering specimen of the tree producing any particular wood, they would be helping to develop the resources of the forests, besides contributing to the knowledge of the flora of the country. But this is a matter which does not concern the importer so long as the necessary supplies are forthcoming and remunerative prices can be realised; and it is by the agents or exporters alone at the port of shipment that this information can be obtained, consequently our knowledge of the sources of the ornamental hard woods of commerce remains pretty much as it did ten or even twenty years ago. It is true that at the several International Exhibitions, notably those of 1851 and 1862, some remarkably fine collections of woods were exhibited, but only in comparatively few cases were really trustworthy catalogues prepared. Even the British Guiana collections, which were remarkable for the size of the specimens and the care exercised in their selection, were woefully deficient in scientific nomenclature, and remain so to the present time, simply on account of the absence of flowering specimens, which should have been collected at the time of cutting the timber.

It is no doubt in consequence of these obstacles and the scant material at command that no one has hitherto been tempted to take up our timber and wood supplies as a special subject. Many are the collections that have been formed of British and foreign woods, but they have never found a champion in the same way that drugs did in the late Daniel Hanbury, who grudged neither time, trouble, nor expense in seeking authentic information in his favourite pursuit. The most complete lists of woods perhaps ever published are those contained in the Jury Reports of the Great Exhibition of 1851, where, besides notes on the qualities of the woods and their uses, their weights per cubic foot and their specific gravities are in some cases given. In 1852 a useful "Descriptive Catalogue of the Woods commonly employed in this country for the Mechanical and Ornamental Arts" was published by Charles Holtzapffel, but this book is of course now out of date, and nothing of any importance has since appeared beyond a few occasional lists and papers scattered about in different journals.

It was therefore with some satisfaction that we took up the book whose title stands at the head of this notice, with the hope that we should find it a trustworthy handbook of woods in general. It required, however, but a slight glance to show us that it was devoted almost exclusively to the consideration of timber for building or carpentry work, to the exclusion of ornamental woods. This we regret the more as the timber and hard wood trades, though distinct in themselves, are nevertheless closely allied subjects, and treated together with proper care and attention, would form a most valuable work.

Taking the book as it is, we find that a large portion of the early part is devoted to the question of the formation and structure of wood, matters which we think unnecessary in a work of this description, occupying space which might be much more advantageously used. A chapter is also given on the computation of the ages of trees and their rate of growth. After referring to the computed ages of well-known large trees, by which it has been estimated amongst others that the oak attains to an age of

810 to 1,500 years, the yew from 1,214 to 2,820, and the Baobab (*Adansonia digitata*) to 5,000 years, the author points out that these figures have been based upon the general assumption of each concentric ring of wood being the growth of one year. Speaking of his own experience, he says:—"I have carefully examined and counted the annual layers of a great many specimens—taking generally the average of the trees—with the view to show the common and comparative rates of growth, and have tabulated them to afford an opportunity of noticing any variations there may have been in the time required to form the wood in each of the several given diameters of 6, 12, 18 inches," &c. In these tables it is shown that in fifteen specimens of oak, the diameter of whose stems were in all cases 6 inches, the number of rings ranged from 12 to 49; in the same number of sections measuring 12 inches diameter they ranged from 19 to 105, and in those of 18 inches diameter from 24 to 160. In sections of Greenheart (*Nectandra Rodiazi*) of 6, 12, and 18 inches diameter, the concentric rings were respectively 37, 60, and 83, while in Mexican mahogany of the same dimensions the result showed the number of rings at 17, 30, and 44. In most cases from six to ten sections were examined, and the average so obtained.

In the matter of ordinary timber the information given is varied and tolerably complete, and the opinions of the author as regards strength, durability, and value for practical purposes may, of course, be taken as the opinion of one having experience and authority to speak on such matters. Moreover, the tables showing the breaking weights of the different woods and their specific gravities are the results of actual experiments. It is much to be regretted that in a work of this kind, which has not been produced without some care, more attention has not been given to scientific accuracy, not only in tracing out the sources of the woods mentioned, but also in bringing what botanical nomenclature has been attempted down to modern times. Thus, for instance, the "Maçaran duba" of Brazil (p. 182) might have been accredited as being a species of *Mimusops*, the "Cedro," on the following page, not as a species of "Cedar" but of *Cedrela* (*Cedrela odorata* probably), and the "Vinhatico" (p. 186) probably *Persea indica*. Again, with regard to African oak or teak, it is stated to be "probably the *Swietenia senegalensis* or *S. Khaya*," but it is well known that the durable timber commonly known under the above names is produced by *Oldfieldia africana*, a Euphorbiaceous tree. The Cuban Sabicu wood, likewise, of which the stairs of the great Exhibition building in Hyde Park in 1851 were constructed, and which, we believe, are still in use at Sydenham—such is the durability of the wood—is described as being produced by *Acacia formosa*, but it is under *Lysiloma sabicu* that any description of this wood is to be found in works of a botanical character.

It is not with the view of depreciating the value of the book that we point out these errors. In a new edition, with the aid of a botanist and a determination to extend the scope of the work so as to include all woods known in commerce, the value of the book might be considerably enhanced. As it is, however, besides the technical details there are numerous interesting facts distributed through its pages, many of which are new to us.

JOHN R. JACKSON

## RECENT FRENCH EXPERIMENTAL PHYSIOLOGY\*

*Physiologie Expérimentale. Travaux du Laboratoire de M. Marey. (Paris: G. Masson, 1876.)*

THE second of the memoirs in the work before us, by M. Marey, contains the description of a new *schema*, or dynamical model of the circulatory system, which from the ingenuity of its construction calls for special notice.

M. Marey, not satisfied with the original attempt of Weber to reproduce the phenomena of the circulation in a system of elastic tubes, nor with his own earlier efforts in the same direction, was led to the construction of the one to be noticed immediately. He tells us that all previous models were correct enough in imitating certain special points in the vascular circulation, but these were at the expense of, and to the total neglect of, others. The perfect reproduction of each phase is the end he has had in view in the construction of the new apparatus.

It can be proved without doubt that the heart takes a longer time to relax than to contract; the systolic curve, when represented graphically, is therefore more abrupt than the diastolic. To represent this on paper mechanically, the easiest method is by the employment of a cam or eccentric, which, as it turns, lifts a lever resting upon it and following the variation in its eccentricity.

In Fig. 1 the winch handle turns an axle on which two cams are fixed, the whole being connected with the two steady-arms and the immovable upright board on the left-hand side. A flywheel tends to render the rotation of the axle uniform. The irregularly-shaped eccentrics (C.V. and C.O.), the form of which will be explained further on, each move one of the smaller boards to the right of the figure, because these are pressed towards the left by the elastic spring F, and the dilatation of the cavities of the artificial heart (v and o), whilst they are being refilled. They transmit their movements through the intervention of the fixed pulleys attached to the boards, which latter again act on the artificial heart by the strain they exercise upon the cords S.O. and S.V. The action of the auricle being intermittent, the machine is so arranged that the cord S.O. is lax (as in the figure) during the time that it is at perfect rest. The ventricle never being in a state of true repose, but always in a state of contraction or expansion, it does not require the extra apparatus.

The artificial heart is constructed with caoutchouc cavities, supplied with valves to represent those in the human circulation. The *auricle* is covered with netting, to which four parallel cords, running through holes in the big board, are attached. The cords are fixed on a square piece of wood, which is kept in position by a spiral spring, and in connection with the moving board by the thread S.O. The *ventricle* has over it a case (white in the figure) to the edges of which cords are fixed, which are attached at their other ends to a board, which is put into communication with the moving board by means of the hooks and elastic rings (F), and the cord S.V. It is evident that any strain on the cords S.V. or S.O. will compress the auricle (o) and the ventricle (v) against the main board to which they are attached, and so produce a systole of

\* Continued from p. 146.

these viscera. A magnified view of this artificial heart, into the cavities of which recording "ampoules" have been introduced, is given in Fig. 2.

As to the construction of the cams, M. Marey draws a curve to represent the systole and diastole of the ventricle of the actual heart, figuring it as a simple rise followed by a less abrupt fall. He divides the linear horizontal projection of this by twenty equidistant points, from which he projects the same number of parallel vertical

lines, or ordinates. Taking a small board he draws on it a circle, from the centre of which radiate twenty equidistant lines, of which, when one has been measured off so as to equal in length the first ordinate of the cardiac horizontal curve, the others are made to correspond with the second, third, &c. On uniting by a line the extremities of these rays, a closed curve is the result, which must form the edge of the cam C.V. The cam C.O. is constructed in a similar manner from the auricular trace.

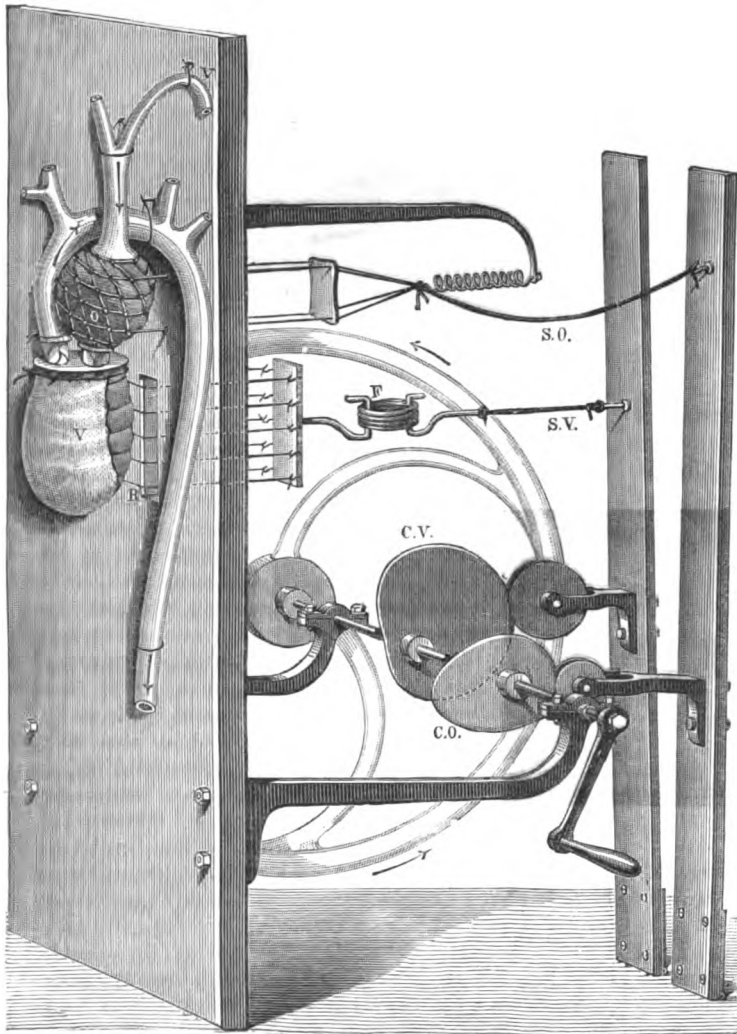

FIG. 1.

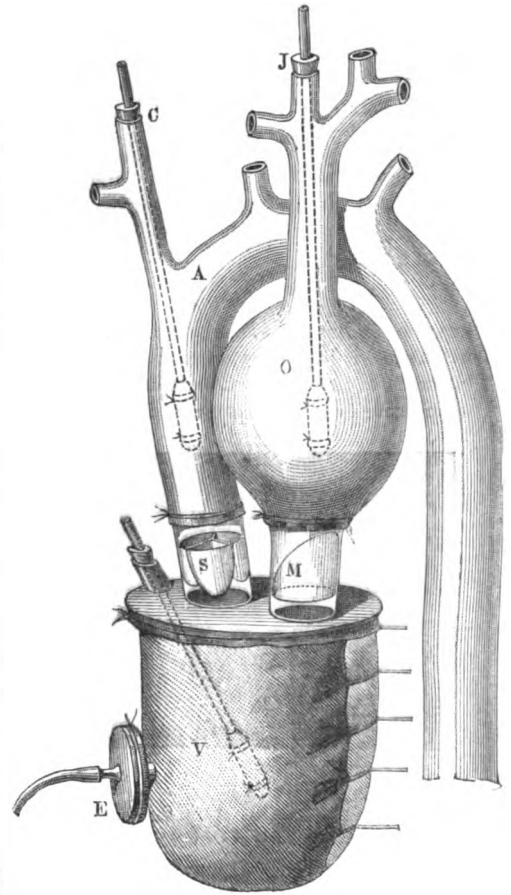

FIG. 2.

When the cams are placed on the axle of the machine in such a position that its rotation in one direction at a certain speed produces a compression (or systolic movement) by the auricular one at the interval of time before that of the ventricular which elapses between the systoles of the living auricles and ventricles, then the actual cardiac revolution is correctly imitated both in this particular and in the relative duration of the systoles themselves.

To verify the accuracy of the arrangements in the

above-described *schema*, traces have been taken from it similar to those from the auricles, ventricles, and arteries of the horse. Fig. 2 illustrates the actual position, in the artificial heart, in which the elastic ampoules (sacs filled with air) which transmit its movements to recording levers (Fig. 3) were placed; and Fig. 4 is a simultaneous tracing from the four, the fourth being that of the motion of the heart-wall at E. The top curve is that from the auricle; the next is from the ventricle; and the third from the aorta.

In Figs. 1 and 2 the proximal vessels alone are represented to save confusion.  
M. Marey claims for this his new *schema* that with it

he can reproduce all the phenomena of the cardiac circulation; at the same time that with it he can master all the theories with reference to the significance of the most

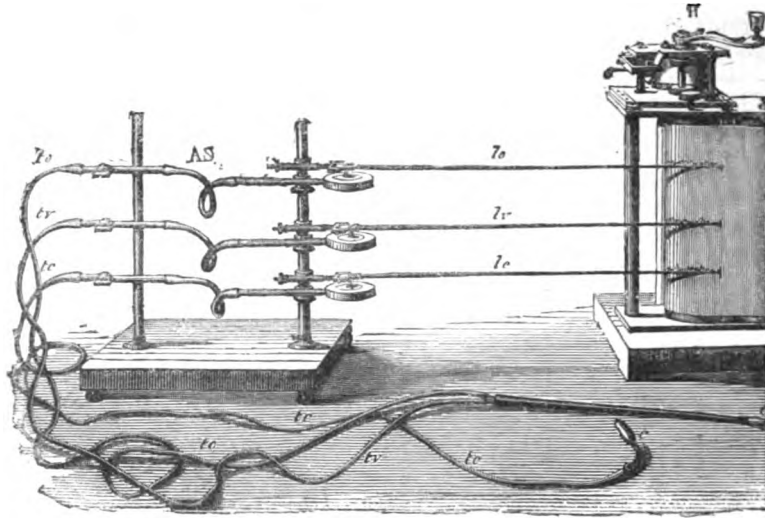

FIG. 3.

important elements of the pulsation of the heart. In this we think he is too sanguine; for there are fundamental elements of the cardiac circulation which it is quite unable to indicate even the existence of  $b_v$  means of it. One of

race-portraits. Catlin's American Indians (particularly the large copies) and Burchell's Hottentots and Bushmen, were among those of real value. But most engravings of race-types to be found in books were worthless, either wanting the special characters of the race, or absurdly caricaturing them. Now-a-days, little ethnological value is attached to any but photographic portraits, and the skill of the collector lies in choosing the right individuals as representatives of their nations. Thus the great *Anthropologisch-Ethnologisches Album* of Carl Dammann of Hamburg, completed some months ago, is one of the most important contributions ever made to the science of man. Consisting of fifty plates, portfolio size, with ten to twenty photographs on each plate, it goes far toward an adequate representation of man in all his

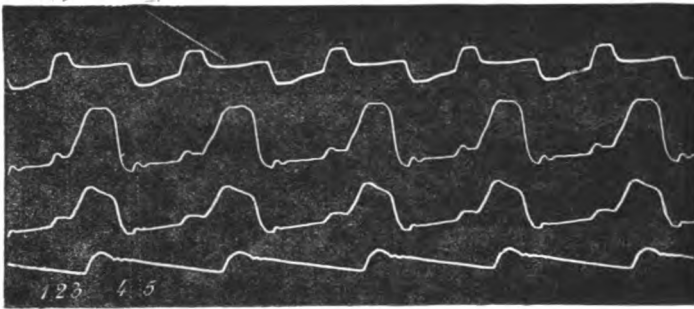

FIG. 4.

the most important of these is the fact that the relative length of the systole and diastole varies with the rapidity of the pulse, a most important point not at present sufficiently laid stress on. Another is the active diastole of the ventricle, which immediately follows the closure of the aortic valve. These and other minor considerations all go to prove that, though the new *schema* of the circulation is a great improvement upon all others yet introduced, nevertheless the exact representation of acts so complicated as the systole of muscular cavities cannot yet be imitated by the employment of the unaided mechanical powers.

varieties. A copy may be seen at the Anthropological Institute, but its cumbrousness and cost (18*l.*) are beyond the limits of most private libraries. It is therefore satisfactory that the publishers have now brought out a smaller educational atlas, price 3*l.* 3*s.*, containing from 150 to 200 portraits, in a binding suitable for a drawing-room book. We wish it all success, for it will make new anthropologists wherever it goes.

The plan on which the portraits are arranged is mainly geographical, exact race-division being from the nature of the case impracticable. Indeed one of the effects of both the large and small albums will be in a negative direction. They will do more than any quantity of written criticism to check the rash generalisation as to race so common in ethnological systems, and they will do this by impressing on the minds of students the real intricate blending of mankind from variety to variety. It is not impossible that some day the time may come for scientifically calculating the constitution of a race, on Quetelet's principle of a central type with gradually decreasing variants. But that time has not come yet, and the most

DAMMANN'S RACE-PHOTOGRAPHS

*Ethnological Photographic Gallery of the Various Races of Man.* By C. and F. W. Dammann. (London: Trübner and Co.)

THE science of anthropology owes not a little to the art of photography. It is true that in previous times some few artists took the trouble to draw careful

that can at present be done to define a race-type is vaguely to make out some of its dominant features. A good example may here be seen in Plate I., which is headed "Germanic Types," though not consisting entirely of them. The last portrait is of a Welsh market girl, and just above her is Livingstone, who as we know was from the Gaelic Island of Ulva. If there is such a thing as a Keltic type, these two portraits show it; they might very well have been father and daughter. The contrast of the dark, near-eyed, compact-featured Welsh girl with the fair North German peasant woman next her is excellent, and the Bavarian lady next again shows the difference as well as possible between South and North German.

It is needless to enumerate the peoples of each district of the globe who have contributed their cartes-de-visite to this album, but a few remarks on incidental points occur as one turns over the plates. A young newly-married couple from China suggest an answer to the question, At what age may ethnological portraits best be taken? No doubt it should be somewhere about twenty years old, more or less, when the physical type has become developed, but the influence of thought, occupation, and circumstances have not yet masked the lines of race. In these plates, the elderly Chinese broker and the Japanese gentleman aged sixty-four, are in expression curiously like what Europeans of the same age and occupations might be. Yet when they were young, the faces of these Orientals probably bore no such apparent European likeness. What an ethnologist wants is not the cast of education and experience, but the mere national face, and this must be taken young. Again, for contrast between purity and mixture of nations, it is interesting to compare Plate XII., containing Siberian tribes of comparatively uniform type, with the heterogeneous figures in the next plate from Morocco and Algeria. The gradual blending of races, of which mention has been already made, may be well studied in Plates VIII. to XI., which bring into view better than it ever has been shown before, how the Malay peculiarities are to be traced into the Chinese and Japanese types. Lastly it may be remarked that the often-repeated ethnological theory deriving the natives of America from Eastern Asia, will receive but little support from a comparison of the portraits here given from Siberia, Japan, and China on the one hand, and North America on the other.

By way of fault-finding, it may be added that the short letterpress at the foot of the plates wants revision.

EDWARD B. TYLOR

#### OUR BOOK SHELF

*The Eastern Seas: being a Narrative of the Voyage of H.M.S. "Dwarf" in China, Japan, and Formosa. With a Description of the Coast of Russian Tartary and Eastern Siberia, from the Corea to the River Amur. By Capt. B. W. Bax, R.N. With map and illustrations. (London: John Murray, 1875.)*

CAPT. BAX spent three years, 1871-4, cruising about in the waters on the east of Asia, and has written a pleasant gossip account of what he saw. He went over ground that has been often traversed, and has not much that is new to tell. Many details, especially historical, are confessedly borrowed from well-known authorities, so that the work is to some extent a compilation. An

unnecessarily large amount of space is devoted to accounts of various wrecks that occurred on the coasts near where the *Dwarf* happened to be cruising, and many incidents of trifling importance are narrated, adding considerably to the size but not to the value of the book. Probably the most valuable part of the work is that wherein the author's visits to Formosa and to the Russian coasts are described. Capt. Bax had some favourable opportunities of becoming acquainted with the Formosans, both civilised and wild, and gives some interesting details as to their appearance, manner of life, and customs; his second chapter is a history of the island from its discovery by the Chinese. There is a good map of the island, and it would have added to the value of the work had there been a map of the whole region with which the book is concerned. In his narrative of the voyage of the *Dwarf* along the coast of Asiatic Russia, some interesting facts are given as to the present condition of the Russian possessions in that quarter as far north as Nikolevsk. Capt. Bax also made an ascent of Fusi-yama, in Japan, of which he gives a pleasant account. Altogether, although the work adds very little to our knowledge of either China, Japan, or Asiatic Russia, it contains a good deal of interesting reading.

*Commodore J. G. Goodenough. A Brief Memoir. By Clements R. Markham, C.B. (London and Portsmouth: Griffin and Co.)*

THIS is a modest and well-written narrative of the life of a man whose premature death is a distinct loss to the British navy and to geographical science. Every naval officer should read it, and indeed all who wish to be inspired by the record of a noble life. The unfortunate circumstances connected with the death of Goodenough must be fresh in the memory of our readers. He undoubtedly was a martyr to what he conceived to be his duty; he fell in the attempt to conciliate the savages of Santa Cruz Island, and to assure them of the good intentions of England towards them. Had he been spared he would no doubt have done much good in this direction, as well as added to our knowledge of the Pacific Islands. Commodore Goodenough had high ideas of the scientific and other qualifications which are necessary to make an efficient naval officer, and took every opportunity to advocate these ideas. He himself was a man of varied attainments, and was a student up to the last. He took a warm interest in geographical science, and was for long an earnest advocate for a new Arctic expedition. Commander Markham and several other officers on board the *Alert* and *Discovery* had the advantage of serving under Goodenough; while Mr. C. R. Markham was himself his shipmate at an early part of his career. A good portrait is prefixed to the narrative.

#### LETTERS TO THE EDITOR

[The Editor does not hold himself responsible for opinions expressed by his correspondents. Neither can he undertake to return, or to correspond with the writers of, rejected manuscripts. No notice is taken of anonymous communications.]

Sir Thomas Millington and the Sexuality of Plants

I THOUGHT it was sufficiently obvious that Sir Thomas Millington's claims to be regarded as the discoverer of the function of the stamens in what are called hermaphrodite flowers was based upon what is stated by Grew. That I confess has always appeared to me conclusive upon the matter. I am not aware that Sir Thomas Millington ever published anything in his own name upon the subject.

With regard to Grew's book, I think Mr. Bennett is still under some misapprehension, which I trust he will allow me to point out to him. In *NATURE* (vol. xiii. p. 86) he speaks of a first edition of 1671, and also of an edition of 1681. In *NATURE* (vol. xiii. p. 166), he appears to identify the first of these with Grew's Treatise, "The Anatomy of Vegetables Begun, with a general account of vegetation founded thereupon," published in

1672. In 1682, he says that Grew published an enlarged edition of this smaller work under the *same* title. But this is not really the state of the case. The title of the large book is "The Anatomy of Plants, with an Idea of a Philosophical History of Plants." The volume has Sir Christopher Wren's *imprimatur*, which runs as follows:—

"At a meeting of the Royal Society, Feb. 22, 1683, Dr. Grew having read several *Lectures of the Anatomy of Plants*, some whereof have been already printed at divers times, and some are not printed; with several other *Lectures of their Colours, Odours, Tasts*; as also of the *Solution of Salts in Water*; and of *Mixture*; all of them to the satisfaction of the said *Society*: It is therefore Ordered, That He be desired, to cause them to printed (*sic*) together in one Volume.

"CHR. WREN, P.R.S."

The "Anatomy of Plants Begun" is simply reprinted in this volume. "The Anatomy of Leaves, Flowers, Fruits, and Seeds" is, however, printed for the first time. In the second part of this, called "The Anatomy of Flowers prosecuted with the bare eye and with the microscope," which was read before the Royal Society, Nov. 9, 1676, is contained Grew's discussion of the function of the parts of the flower in which the statement about Millington occurs.

Grew's "Anatomy of Plants" can no more be described as a second edition of the "Anatomy of Plants Begun" than Prof. Huxley's "Lay Sermons" can *collectively* be described as a second edition of any *one* essay republished in that volume.

The object of the quotation from Sprengel was to show what was his opinion of the claims of Camerarius to be considered the discoverer of sexuality in plants. As Mr. Bennett (vol. xiii. p. 166) makes a point of nothing being cited from Sprengel as regards Millington; here is what Sprengel says on that head. Speaking of Grew:—

"Summam vero meruit et seræ posteritatis gratitudinem, quod primus sexuum differentiam in partibus vel fecundantibus vel fecundandis *non invenit, sed tamen defendit* ac evulgaverit. Ipse verecunde satis et candide Thomam Millingtonium, Saviilianum professorem Oxonii nominat, qui sibi dixerit, apparatus eum seminiformem (the anthers) vices partium muscularum probabiliter gerere" ("Hist. rei Herb." li. 14).

Next as to Camerarius and Ray, Mr. Bennett says that the observations of the first antedated those of the second by two years. On Mr. Bennett's own showing the date of Camerarius's tract is 1694 (NATURE, vol. xiii. p. 86). The date of the first volume of Ray's "Historia," in which he alludes to the subject, is 1686.

As to Theophrastus it is well known that classical writers on natural history were aware that the unisexual flowers of the date required the "pulvis maris," or pollen, to enable them to set their fruit. But I am not aware that till the time of Grew and Millington the fact that the vast majority of plants contain stamens and ovaries, *i.e.*, both male and female organs, had ever been ascertained. What these persons did for the first time was to point out the function of the essential organs of the flower.

Mr. Bennett, instead of taking his facts secondhand from Prof. Sachs's no doubt excellent "Geschichte," ought to have looked into the authorities himself. He would then avoid the error of quoting non-existent editions and of drawing conclusions which would be inexpugnable if they were not based on erroneous dates.

A. B. C.

#### Article "Birds" in "Encyclopædia Britannica"

IN that portion of the article "Birds," which I have lately written for the "Encyclopædia Britannica," I said (page 729, column 2) that *Odonopteryx* had "jaws armed with true teeth," and in this respect resembled *Ichthyornis*. The mistake has just been pointed out to me, and I shall be greatly obliged by being allowed to correct it, as far as is possible, in NATURE. The sentence should run thus: "jaws armed with tooth-like processes, and in this respect differing from Professor Marsh's *Ichthyornis*."

ALFRED NEWTON

Athenæum Club, Jan. 3

#### Fertilisation in the Basidiomycetes

IN your review of Dr. Pringsheim's "Jahrbücher" (NATURE, vol. xiii. p. 156) you refer to Dr. Max Reess's paper on the Fertilisation of the Basidiomycetes; this paper you compare with the results recently obtained by Van Tieghem, Dr. Eidam, and my-

self, and you say that the observations of the three former all tend in one direction, which fact should lead botanists to look with very great caution on my results, which are somewhat different.

As I am tolerably well acquainted with the three papers first mentioned, perhaps you will kindly allow me to point out that Dr. Reess's carpogonium, and the carpogonium of Dr. Eidam, are very different bodies, and that the latter author, in the "Botanische Zeitung," even puts a note of interrogation before his own interpretation of the body he figures as a possible carpogonium.

The spermatozooids as described and illustrated by me in the *Gardeners' Chronicle* for Oct. 16 and 23 last, are not essentially different from Dr. Eidam's spermatia; they agree in size, but I maintain that the threads which bear these male bodies come direct from the cystidia, and not from the basidia, and that they are at first spherical. In Dr. Eidam's excellent plate there are sixteen germinating spores shown which do *not produce spermatia*, and in each instance the spores are shown as *ruptured*. Three other spores are shown as *producing spermatia*; now these latter spores are engraved to twice the size of the former, and all three are *unruptured*. The explanation simply is that the latter threads have not come from the spores at all, but from a cystidium—the spores engraved have not germinated, and have merely been *washed against* the spermatia-bearing threads.

As for the species experimented upon abroad (except Van Tieghem's plant), one is rare, and the other not British; the plants I have been working upon are common everywhere.

In the January number of the *Popular Science Review* will be found an illustrated paper of mine on the "Reproduction of *Agaricus lacrymabundus*." In this essay will be found not only some new facts as to the reproduction process in the Basidiomycetes, but a *résumé* of the views now generally held on this subject.

WORTHINGTON G. SMITH

#### The Late Eclipse

I FIND in NATURE, vol. xiii. p. 86, a letter from Dr. Schuster, commenting on some remarks made by me last April respecting the photographic results of the late eclipse. He appears to consider that these remarks related to him personally, which certainly was not my intention. He speaks further of a mathematical solution promised by me, for which he has "had to wait already a considerable time." I remember nothing of such a promise, nor can I conceive how I could have promised, instead of giving at once, the solution of so simple a matter. Dr. Schuster proves very readily that the spectrum of the corona can be photographed in one minute; but I am not aware that anyone has questioned the fact. What I questioned myself was whether the spectral images of the corona can be so photographed that the true extension of the corresponding coronal envelopes can be shown. To quote my own words ("Science Byways," p. 168): "The whole light" [of the corona] "acting at once to form a photograph does not show the *full extension* of the corona, the outskirts simply losing themselves through excessive faintness. . . . How, then, can a minute portion of that light produce any photographic trace" [of the outskirts]? "How much less can this minute portion show the *whole extension* of the green solar envelope?" It was the hope that this might be effected which I described as mathematically unsound.

I am so busy that I cannot enter further into this matter. But in any case the only justification of controversy respecting it would be the hope that some purpose useful to science might be subserved. This seems unlikely.

RICHD. A. PROCTOR

New York, Dec. 16, 1875

#### Blowpipe Analysis

THANKING you sincerely for the very well written and not altogether uncandid (if rather severe) review of my lately published work on this subject (NATURE, vol. xiii. p. 164), against any part of which I would not at present presume to appeal, I would ask for a corner of your valuable space to explain, with regard to "the production of a precipitate" of sodium sulphide by the addition of a drop of water to a fused mass of soda with a sulphide on aluminium plate, that the term "precipitate" undoubtedly used by me (as the reviewer says so) is obviously a "slip of the pen," for there can be no room to *precipitate* anything in a drop of water from a fused mass on aluminium plate.



What I must have meant to say is, that the sodium sulphide appears like a precipitate, *i.e.* as a powder, in the partly dissolved mass. The reason of its appearing to be black on aluminium, and not, as it ought orthodoxically to be, brown, I cannot tell, as the metal is not attacked. Perhaps my reviewer can? I only say that it is so.

May I take this opportunity of soliciting you to afford, if possible, a little more space in your valuable journal, to the admittedly neglected subject (in England) of blowpipe analysis? It is, I can assure any of our chemists who have not much employed it, a most fascinating study, which will amply repay any leisure time expended upon it.

W. A. ROSS

#### Meteor in the Daytime

DEC. 22, about 2 P.M., as our servants were sitting at dinner by the kitchen window, two of them were startled by the sudden appearance of a brilliant meteor descending in the E. with a little inclination to the N. It was not as large as the moon, but much larger than Mars or Saturn, white, and like lightning, with a very quick course, leaving a train as broad as itself, and preserving its full size till it was lost behind the top of an oak tree at a little distance, whose branches, though leafless, seem to have concealed it from view. The next day I found by means of a compass and a joined ruler, that its azimuth was E. by N., its inclination towards N. about 10°, the upper window frame, where it probably came into sight, 48°, and the top of the tree 21° above the horizon. I have not, as yet, heard of any other observation of this remarkable meteor. The position of Hardwick Vicarage, where it was seen, according to the Ordnance Map, is Long. W. 3° 4' 23", Lat. N. 52° 5' 20".

T. W. WEBB

#### Protective Resemblance in the Sloths

As "mimicry" and "protective resemblance" have chiefly been noticed among insects and the lowest of vertebrated animals, the following observation regarding the three-toed sloth, made at the beginning of this century, and therefore much in advance of the period at which attention had been directed to this subject, is, in these days, not without interest. It is taken from a work not frequently met with, namely, Baron Albert von Sack's "Narrative of a Voyage to Surinam" (London, 1810). In chap. xvi. at p. 170, he says:—"The colour and even the shape of the hair are much in appearance like withered moss, and serve to hide the animal in the trees, but particularly when it gets that orange-coloured spot between the shoulders, and lies close to the tree; it looks then exactly like a piece of branch where the rest has been broken off, by which the hunters are often deceived." The colour of the hair of the body is thus distributed in *Arctophila castaneiceps*, *A. griseus*, and *A. flaccidus* ("Notes on the Species of Bradypodidae in the British Museum," by the late Dr. J. E. Gray. Proc. Zool. Soc., 1871, p. 428, Plates xxxv.-xxxvii.).

Brants, in his "Dissertatio Zoologica Inauguralis de Tardigradis" (Lugdun. Batav., 1828), p. 28, says of the sloths:—"At provida natura, cum animanti negaverit arma et tela, velleri cum colore tribuit, quo subducatur oculis ferarum et adversariorum fere eadem ratione, ac Pallas retulit de *Pteromye volante*." The passage to which reference is made is in the "Novæ species quadrupedum e glirium ordine," p. 357:—"Dum vero in *Betuletis* præsertim vitam agunt, sapienter a natura perspexit, ut omni tempore anni exalbido canescentem colorem velleris servent, quo cortici betularum ita fiunt similes, at scandentes vix, imo sub diluculum, quo tempore præsertim excurrunt, plane non conspicui eminentibus possint, coque ab avibus rapacibus nocturnis securiores sunt." Reference is also made to Prince Maximilian of Nieuwied's "Beitrag zur Naturgeschichte von Brasilien," tome ii. s. 480.

J. C. GALTON

Dec. 29, 1875

#### Coffee in Dominica

IN NATURE (vol. xiii. p. 38, and under the head of "Coffee in Dominica"), it is stated that the "falling off in the cultivation of the coffee plant, in a soil and climate which experience showed was eminently suited to it in every respect, was due to the extensive destruction of the plants by what was there known as the coffee blight." The foregoing statement requires this qualification, that after the appearance of the coffee blight, and when the coffee crop was gradually decreasing in quantity, the

old coffee planters made no attempts to check the ravages of the destroying insect, but, in many instances, cut down the valuable trees, planted the sugar-cane, and converted their coffee-works into sugar-works. I could mention the names of several estates where what I have described was done. I think it right also to add that in some portions of Dominica, where the coffee-trees were simply abandoned, they now stand, and, considering their age and the neglect to which they have been exposed, they bear fairly well. During the last two years, and since the disastrous fall in the price of cane sugar, I have been endeavouring to re-introduce here the coffee cultivation, and, on the Tabery estate, 12,000 young trees of my own planting are doing well. You will confer a great and lasting benefit upon this beautiful but neglected and almost unknown island by calling attention to its capabilities as a coffee-producing country.

EDMUND WATT

South Chiltern, Dominica, Dec. 11, 1875

#### The Law of Storms

I HAVE to thank you for publishing, in NATURE of Dec. 2, 1875, my letter in reply to M. Faye's theory of cyclones, and I have now to submit some remarks on his theory of waterspouts.

I understand him to maintain that the dark part of the waterspout, which we see, contains a core of transparent air, which is descending at the centre of a vortex, and that the dark visible external part is a cloud formed by an ascending counter-current.

All this is unproved, and I think baseless. No dynamical reason can be assigned why there should be a downward current at the centre of the vortex. If the waterspout is formed in a vortex, which I think probable, though I am not certain of it, the vortical motion will produce not a downward but an upward current at its centre, in consequence of the diminution of barometric pressure, due to the air being thrown to the circumference by the centrifugal force. We see such upward currents formed in the little dust-whirlwinds that form themselves over streets and roads in windy weather.

Further, if M. Faye's theory were true, and if the waterspout were transparent at the centre, it could not be so well defined and solid as it usually is, nor could it be formed so rapidly.

The true theory of waterspouts is expounded in Espy's "Philosophy of Storms," a work which, notwithstanding its great error of denying the rotation of cyclones, made an era in meteorology, and, so far as I am aware, is not yet superseded.

When vapour is condensed into water, forming cloud, the latent heat of the vapour is liberated and expands the air. A simple calculation shows that, after deducting the destroyed volume of the condensed vapour, the increased volume of the air due to this expansion is between four and five times as great as the volume of the vapour before condensation. If, then, the air is nearly saturated with moisture, and the temperature in a state of convective equilibrium for dry air (that is to say, when the difference between the temperatures of any two strata is that due to the difference of their pressures), and condensation begins in any column of air, the effect of liberating this heat will be to make the air of that column warmer and lighter than the air at corresponding heights in the surrounding columns. What follows is from Espy's work, page 44:—

"It begins, by its diminished specific gravity, to rise, and then, if all circumstances are favourable, the cloud will increase as it ascends, and finally become of so great perpendicular depth, that by its less specific gravity the air below it, in consequence of diminished pressure, will so expand and cool by expansion, as to condense the vapour in it; and this process may go on so rapidly that the visible cone may appear to descend to the surface of the sea or earth from the place where it first appears, in about one or two seconds. The terms here employed must not be understood to mean that the cloud actually descends; it appears to the spectator to descend, but this is an optical deception, arising from new portions of invisible vapour constantly becoming condensed, while all the time the individual particles are in rapid motion upwards."

To this I will add as very probable, if not quite certain, that the rarefaction thus caused at the waterspout will produce an inflow of air from all sides, and this will produce a vortex at the centre; this again, by its centrifugal force, will increase the rarefaction, and thus will intensify the effect. But the commencement of the waterspout is in the way described by Espy in the above extract.

JOSEPH JOHN MURPHY

Old Forge, Dunmurry, Co. Antrim, Dec. 12, 1875

### The Glow-worm

ALTHOUGH in several Natural History Encyclopædias Scotland is excluded from the list of countries containing the glow-worm, I can aver that in Nithsdale and in the parish of Tynron, Dumfriesshire, they are quite plentiful. Yestreen, in Tynron, I observed one, to my surprise, shining by the wayside. It is a proof of the mildness of the season, no doubt, as I never saw them in December before, but have seen them several times as late as October.

When carrying one home one evening in my open hand it contracted itself and leaped out of my hand. This is a power they possess which I have seldom seen mentioned. The light in winter is much feebler than in summer, but the time was ten o'clock, or more than six hours after sunset that I saw it, whereas I never witnessed the glow of one in summer so long after dusk. Some that died with me forcibly reminded me of the poet's remark that between the rose's shadow and the very rose there was not a greater contrast than that between "the dead glow-worm and the worm that glows." J. SHAW

Tynron Schoolhouse, Dec. 26, 1875

### OUR ASTRONOMICAL COLUMN

ENCKE'S COMET.—By the calculations of Encke and others who have continued them, we are in possession of the dates of perihelion passage of the comet which bears his name, from 1786 to 1875. If these be arranged and the intervals taken between the successive dates, it will be found that in the course of these ninety years the effect of perturbation has not changed the period of two successive revolutions by a hundredth part. The revolution 1819-1822 was 10.1 days longer than that between 1815 and 1819, and the revolution 1845-1848 was 11.1 days shorter than the preceding one, and these are the largest variations exhibited. In the same period, the longest interval between two successive arrivals at perihelion is 1215.6 days, 1842-1845, and the shortest 1200.2 days, 1868-1871.

In aphelion the distance of the comet from the orbit of the planet Jupiter by the elements of 1875 is 0.915, too great to allow of any violent perturbation. In about 123½° heliocentric longitude, and 6° 50' north of the plane of the ecliptic the comet approaches the orbit of Mercury within 0.038; to bring the bodies into closest possible proximity it is necessary that the planet shall arrive at perihelion 12½ days before the comet, and we know that a very close approach to this condition took place in November 1848, whereby, on the 22nd of that month, the comet was brought within 0.0378 from the planet, a distance of about fifteen times that which separates the moon from the earth. A close encounter with Mercury appears hardly possible before the year 1904.

If the orbit of Encke's comet was fixed within its present comparatively restricted limits by planetary attraction, it seems quite as likely that this may have been occasioned by an extremely close approach to Mercury as that Jupiter at some distant period should have been the disturbing agent.

OCCULTATIONS OF THE PLANET SATURN.—We are not very fortunate in this country as regards the circumstances of the batch of eleven occultations of Saturn by the moon, which take place in successive lunations, commencing on the 22nd of March next; the only one visible in England being that on the morning of the 7th of August, and this will be a daylight phenomenon, the sun rising, at Greenwich, more than half an hour before the immersion. Of the ten occultations of the planet in 1870, three were visible here, and the occultations of that year possessed greater interest from the circumstance of the wider opening of the rings, than those of 1876 are likely to be attended with, wherever witnessed. The near approach of Saturn to the moon's limb between 1 and 2 A.M. on July 11, as viewed at Greenwich, does not appear to be converted into an occultation in any part of these islands.

While writing upon occultations, a word may be said of the close approach of the planet Jupiter to the star  $\beta^1$  Scorpii, on the morning of February 28, which is entered as a possible occultation in the American Ephemeris.  $\beta$  Scorpii is a double star, the components being of 2 and 6½ magnitudes, distance about 13", or according to the "Melbourne General Catalogue" of 1870, the smaller star follows in R.A. 0.40s., and is 11" 05 north of the brighter one. The apparent position of  $\beta^1$  Scorpii on Feb. 27 is in R.A. 15h. 58m. 14.41s., and N.P.D. 109° 28' 2.1". The *Nautical Almanac* place of Jupiter, which is from Bouvard's Tables, will probably require a correction of about +0.90s. in R.A., in which case the conjunction of planet and star would take place a few minutes after meridian passage at Greenwich on the morning of the 28th or about 5h. 40m. A.M., and the north limb of Jupiter is brought close upon the star, but there still seems likely to be a difference of some three or four seconds in N.P.D., by which small quantity the star may escape occultation. The companion is too far north to be occulted. This judgment is formed by a comparison of the latest published corrections of Bouvard, given by the Greenwich observations, and the differences between Le Verrier and Bouvard at the end of 1877.

A close approach of Jupiter to this star is recorded by the Chinese as early as the year A.D. 73; on the 12th of February the planet was very near the star, four days afterwards the star was seen having been previously hidden by the superior brightness of Jupiter; and the Chinese also report that the planet which had been very near to  $\beta$  Scorpii A.D. 512, January 12, occulted it on the 17th of April following.

### PROF. STOKES ON THE EARLY HISTORY OF SPECTRUM ANALYSIS

THE following extract from a letter, relating to the early history of spectrum analysis, from our highest English authority on physical optics, cannot fail to interest, apart from its intrinsic importance, a wide circle of readers. I have therefore obtained permission from Prof. Stokes to forward it to NATURE.

C. T. L. WHITMELL

"CAMBRIDGE, Dec. 23, 1875

... "I felt that the coincidence between the dark D of the solar spectrum and the bright D of a spirit-lamp with salted wick could not be a matter of chance; and knowing as I did that the latter was specially produced by salts of soda, and believing as I did that even when such were not ostensibly present, they were present in a trace (thus alcohol burnt on a watch-glass and a candle snuffed close, so that the wick does not project into the incandescent envelope, do not show bright D), I concluded in my own mind that dark D was due to absorption by sodium in some shape. In what shape? I knew that such narrow absorption-bands were only observed in vapours; I knew that as a rule vapours agree in a general way with their liquids or solutions as to absorption, save that in lieu of the capricious absorption of the vapour, we have a general absorption attacking those regions of the spectrum in which the vapour-bands are chiefly found. Hence as the sodium compounds, chloride, oxide, &c., are transparent, I concluded that the absorbing vapour was that of sodium itself. Knowing the powerful affinities of sodium, I did not dream of its being present in a free state in the flame of a spirit-lamp; and so I supposed that the emitting body in the case of a spirit-lamp with salted wick was volatilised chloride of sodium, capable of vibrating in a specific time, or rather two specific and nearly equal periods, by virtue of its sodium constituent; but that to produce absorption the sodium must be free. I never thought of the extension of Prevost's law of exchanges from radiation as a whole to radiation of each particular refrangi-

bility by itself, afterwards made by B. Stewart; and so I failed to perceive that a soda flame which emits bright D must on that very account absorb light of the same refrangibility.

"When Foucault, whom I met at dinner at Dr. Neil Arnott's, when he came to receive the Copley Medal in 1855, told me of his discovery of the absorption and emission of D by a voltaic arc, I was greatly struck with it. But though I had pictured to my mind the possibility of emitting and absorbing light of the same refrangibility by the mechanism of a system of piano strings tuned to the same pitch, which would, if struck, give out a particular note, or would take it up from the air at the expense of the aerial vibrations, I did not think of the extension of Prevost's theory, afterwards discovered by Stewart, nor perceive that the emission of light of definite refrangibility necessitated (and not merely permitted) absorption of light of the same refrangibility.

"Reviewing my then thoughts by the light of our present knowledge, I see that my error lay in the erroneous chemical assumption that sodium could not be free in the flame of a spirit-lamp; I failed to perceive the extension of Prevost's theory, which would have come in conflict with that error.—Yours sincerely,

(Signed)

"G. G. STOKES

"To Chas. Whitnell, Esq."

"P.S., Dec. 31.—As Sir Wm. Thomson has referred in print to a conversation I had long ago with him on the subject, I take the opportunity of describing my recollection of the matter.

"I mentioned to him the perfect coincidence of bright and dark D, and a part at least of the reasons I had for attributing the latter to the vapour of sodium, using I think the dynamical illustration of the piano strings. I mentioned also, on the authority of Sir David Brewster, another case of coincidence (as was then supposed, though it has since been shown to be only a casual near agreement) of a series of bright lines in an artificial source of light with dark lines in the solar spectrum, from which it appeared to follow that potassium was present in the sun's atmosphere. On hearing this Thomson said something to this effect: 'Oh then, the way to find what substances are present in the sun and stars is to find what substances give bright lines coincident with the dark lines of those bodies.' I thought he was generalising too fast; for though some dark lines might thus be accounted for, I was disposed to think that the greater part of the non-terrestrial lines of the solar spectrum were due to the vapours of compound bodies existing in the higher and comparatively cool regions of the sun's atmosphere, and having (as we know is the case with peroxide of nitrogen and other coloured gases) the power of selective absorption changing rapidly and apparently capriciously with the refrangibility of the light.

"If (as I take for granted) Sir William Thomson is right as to the date [1852] when he began to introduce the subject into his lectures at Glasgow (Address at the Edinburgh Meeting of the British Association [1871], page xcvi.), he must be mistaken as to the time when I talked with him about Foucault's discovery, for I feel sure I did not know it till 1855. Besides, when I heard it from Foucault's mouth, it fell in completely with my previous thoughts.

"I have never attempted to claim for myself any part of Kirchhoff's admirable discovery, and cannot help thinking that some of my friends have been over zealous in my cause. As, however, my name has frequently appeared in print in connection with it, I have been induced to put on paper a statement of the views I entertained and talked about, though without publishing.

"In ascribing to Stewart the discovery of the extension of Prevost's law of exchanges, I do not forget that it was re-discovered by Kirchhoff, who, indeed, was the first to publish it in relation to light, though the transition

from radiant heat to light is so obvious that it could hardly fail to have been made, as in fact it was made, by Stewart himself (see 'Proceedings of the Royal Society,' vol. x. p. 385). Nor do I forget that it is to Kirchhoff that we owe the admirable application of this extended law to the lines of the solar spectrum."

#### SCIENCE IN THE ARGENTINE REPUBLIC \*

THE fourth part of the Bulletin of the National Academy of Sciences recently founded at Cordova, in the Argentine Republic, completes the first volume of this remarkable work, of which we have previously given some account to our readers.† The present part is mainly occupied by the conclusion of a long article upon the vegetation of the little known province of Tucuman, in the interior of the Republic, by Dr. Hieronymus, commenced in a former number. This is based upon the observations made by the author during a long and extensive scientific journey in that province, and upon the collections amassed by Dr. Lorentz in the same districts in 1871 and 1872, which have been mainly determined by Prof. Grisebach, of Göttingen. A second important article is by Dr. D. A. Döring, and treats of the land and freshwater Molluscs of the Argentine Republic, amongst which are a considerable number of new species, and several interesting novel forms discovered by the author. A third memoir, from the pen of Dr. Burmeister, treats of the abnormal Hymenopterous insects of the Linnean genus *Mutilla*, and forms a complete monograph of the native species of this group, which will be very acceptable to entomologists. By the chronicle appended to the number, we learn that the strife which has prevailed between the Director of the Academy and the six German professors originally imported for its constitution has terminated in the signal defeat of the latter. After the expulsion of about half the number, the remainder resigned, and their places have been filled by other professors from the same country, whom we trust Dr. Burmeister will find more tractable. That they are full of work is evident by the contributions to science already published in the present volume, upon the successful completion of which we heartily congratulate the energetic and illustrious Director of the Academy of Natural Sciences of the Argentine Republic.

#### SOME UNSOLVED PROBLEMS IN THE MANAGEMENT OF THE MARINE AQUARIUM

IT would be fatal to further progress in that direction in which so much has been achieved during the last ten years, if the zoological conditions of even the most successful of existing marine aquaria were to be blindly accepted as incapable of improvement, and especially if further experiment in reference to the vexed question of aëration were to be barred by the assumption that any one of those rival systems which are typified in the practice of Brighton, Sydenham, or any other similar establishment, is necessarily the best which can be attained.

More discussion than it has yet received is due to the broad question whether the total or almost total exclusion of vegetation from public aquaria is based on necessity or philosophy; whether artificial may not be advantageously supplemented by this most natural and automatic mode of aëration; and the further question remains, to what extent must the conditions of the aquarium be modified, as regards circulation and introduction of air, in order to render practicable the establishment and maintenance of a healthy vegetation, if the propriety of its introduction

\* "Boletín de la Academia Nacional de Ciencias exactas existente en la Universidad de Córdoba." Entrega iv. (Buenos Ayres, 1875.)

† See NATURE, vol. xi. p. 553.

be once conceded as a result of theoretical considerations?

Before briefly discussing these questions, let us refer for a moment to one or two other minor points which deserve a passing consideration as bearing upon the state of the marine aquarium as a miniature sea, the health of whose inhabitants is ensured in proportion as its actual conditions approach to those of its natural prototype.

It has been suggested that the proportion of carbonic acid held in solution in the water is a matter of more importance than has been recognised, and that the effect of the constant influx of a copious and finely comminuted stream of air passing night and day through the tanks is, after pretty completely oxidising the organic matter with which their contents are charged, to displace the resulting carbonic acid, and so reduce its percentage below the normal amount present in the ocean; and a parallel has been drawn between the condition of the inhabitants under these circumstances and that of human beings breathing an atmosphere containing an abnormal proportion of oxygen.

In confirmation of this opinion, it has been pointed out that one of the prominent results of the *Challenger* researches is that animal life is abundant at the bottom of the sea, while the amount of carbonic acid held in solution in its lowest strata exceeds that of the surface layer by six or seven per cent.

Now, it is certain that, supposing all sources of further or continuous supply of carbonic acid to be excluded, the exposure to the air of any given bulk of water containing the maximum quantity of that gas which it is capable of holding in solution (or any less quantity) will finally result in its total elimination; for Dalton long ago established laws from which it follows that when water saturated with a gas, e.g. carbonic acid, is placed in contact with the open air, the whole of such gas is set free, while the water absorbs the constituents of the air.

Hence the small quantity of carbonic acid always present in sea-water is not due to absorption from the air, but to the incessantly renewed supply afforded by the oxidation of organic matter in the sea itself.

If this supply were not constantly maintained, this constituent would vanish from the ocean. Its higher percentage in the lower strata of the sea is doubtless due to three causes: 1, to the comparative stillness of the water, whereby the diffusion of the solution is retarded; 2, to the absence of direct contact with the air and exposure to the wind; 3, and chiefly, to the increased pressure, whereby solution of the gas is greatly facilitated; for under pressure of 1 atmosphere and at ordinary temperatures, 1 cubic centimetre of water dissolves in round numbers 1 cubic centimetre, or 1.529 milligrammes, of carbonic acid, while under double that pressure the absorption is double, and so forth, varying directly as the pressure, approximately.

It can hardly be doubted that this presence of a larger proportion of carbonic acid in the lowest depths of the ocean has a distinct correlation to the character of their special inhabitants.

Prof. Wyville Thomson writes: "In the 'warm area,' and wherever the bottom is covered with ooze, calcareous forms predominate, and large sandy crustaceans, with their sand-grains bound together by calcareous cement, so that the sand-grains show out, dark and conspicuous, scattered on the surface of the white shell." And again: "The dredging at 2,435 fathoms at the mouth of the Bay of Biscay gave a very fair idea of the condition of the bottom of the sea over an enormous area. . . . The surface layer was found to consist chiefly of entire shells of *Globigerina bulloides*, large and small, and fragments of such shells mixed with a quantity of amorphous calcareous matter in fine particles;" and he proceeds to trace how the gradual subsidence of this ooze is forming, under the pressure of superincumbent water, vast geologi-

cal strata, just as they have been formed for countless ages in the past.

Now, carbonate of lime is much more freely soluble in water containing carbonic acid than in pure water. Hence the abundant supply of this substance in the bed of the ocean is doubtless freely taken up into solution, to be in turn abstracted and secreted by fresh generations of living animals; and thus the carbonic acid forms, as it were, a carrier or circulating medium, if not essential to, at any rate vastly facilitating the ever-alternating processes of life and death, by which the surface of the submarine globe is being constantly and profoundly modified.

But, on the other hand, the animals kept in aquaria are essentially surface-dwellers; the tubicolous Annelids, Actiniadæ, Echinoderms, Crustacea, Nudibranchs, Mollusca, and fishes, which can be successfully kept in confinement all belong to this category, and are captured either between tide-marks or within a few fathoms of the surface. Coral-building Anthozoa perish as the subsidence of the areas in which they dwell plunges them into depths exceeding fifteen or twenty fathoms, a fact which is the basis of Mr. Darwin's simple and elegant theory of the formation of circular reefs and "atolls."

It appears that the amount of carbonic acid present in the tanks of a marine aquarium must represent the balance between the quantity evolved from decaying animal matter, exuvia, excreta, remnants of food, and the like, and that eliminated from the water by the absorption of air. It has probably never been determined, and its accurate estimation would be a problem both easy and interesting.

But in comparing or contrasting the conditions under which animals live in the confinement of the tanks with those which prevail in the open sea, it must not be forgotten that there is present in an artificial collection of animals an element wholly different from those which exist in the ocean.

In the upper layers of the sea, at any rate, the bulk of water passing over any given animal is tens of thousands of times greater than if the whole contents of the largest aquarium were circulated over it daily. In comparison, the animals are far more sparsely distributed, and dead organisms, together with rejectamenta of all sorts, are swept away by the first tide, and practically got rid of once and for all, so far as their effect on the living individual is concerned.

In the aquarium, animals are disposed in groups artificially brought into comparatively close juxtaposition, and direct oxidation is the only means of removing the various organic impurities of which they are the source.

The observations of the *Challenger* naturalists show that the amount of organic matter in surface and bottom waters is about the same, being about 2½ times as great as in intermediate strata. It corresponds, therefore, to the more abundant distribution of animal life; yet no one can doubt that the percentage of organic matter present in the aquarium vastly exceeds that in the sea, owing to the non-dilution of decomposing animal matter by any such enormous influx of pure water as is supplied by the tides and currents of the ocean.

Hence there is an evident necessity for much more direct aëration in order to prevent the accumulation of organic matter either dissolved or suspended.

*Pari passu* with aëration, the formation of carbonic acid increases, but as this substance is in turn eliminated by excess of air, experiment alone can determine whether the amount present in the aquarium, as now worked, is greater or less than that contained in either the upper or lower strata of the ocean.

We may, at any rate, safely conclude that it is of the utmost importance to have command at all times of a superabundant power of aëration.

The possibility of increasing it to meet the emergency of some sudden temporary pollution arising from the death of some of the inhabitants, the careless introduction

of excess of food, or some other casualty coming into the category of possible accidents, may be invaluable. The influx of air can always be regulated, or even stopped, while an insufficient supply might be fatal, at least to the more delicate animals.

Let us now consider briefly the larger question, whether vegetation ought to be admitted at all, and if so, under what limitations and with what precautions.

It is a proposition requiring no proof that the more nearly the actual conditions of nature can be approached in our tanks, the more likely is success to ensue, and the more varied will be both the classes and species of animals which it will be possible to domesticate and maintain in health.

An aquarium without seaweeds does indeed seem a wide departure from this standard, and inasmuch as vegetation fulfils the double function of naturally aerating the water by absorbing carbonic acid and evolving oxygen, and of affording wholesome and palatable food to fishes and molluscs, its introduction would appear highly desirable if not attended with dangers more than sufficient to counterbalance its advantages. On this point my friend Mr. Hughes writes to me as follows in a recent letter:—"I can no more see how fishes and molluscs can do without vegetation than the higher primates without cabbages. I feel certain that the mortality of fishes is due to its absence in public aquaria. In my own tanks I have seen a Blenny tugging at a mere rag of *Ulva*, black almost with age, for half an hour, to get a mouthful of 'green meat.'

"Our most beautiful family of British fishes, the Wrasses, haunt the banks of *Zostera* and *Fucus*; and they do this for more than mere play!"

The lovely tribe of Nudibranchs is practically excluded at present by reason of the absence of their natural food, the one or two species now admitted being animal feeders, and by no means the most beautiful of their class.

Why, then, are not seaweeds seen in the aquaria at Brighton, Sydenham, or Paris?

I believe the answer to be this. For some reason they do not appear spontaneously in the tanks of public aquaria; possibly because the water is deprived of all germs of vegetation by the process of filtration or purification to which it is subjected before use; more probably because, in order to secure purity, it is generally taken from deep water, where such germs are likely to be absent.

Certain it is that in water taken from near shore and not filtered, vegetation very speedily makes its appearance; and it is impossible to suppose that the gentle flow of water in the aquarium could present any obstacle to the development of germs which are not prevented from finding a resting-place and reproducing their species in every rock-pool on shores washed by the tides and lashed by the storms of the open Atlantic.

As vegetation does not spring up spontaneously in the tanks, and as the possibility of doing without it has been practically demonstrated, its introduction has been avoided because the growth of *Algæ* is so rapid that they are apt to become uncontrollable, to overgrow and hide the animals from view, and at certain seasons by their rapid decay to introduce into the tanks a large amount of decomposing matter of the most objectionable kind—difficult to remove by oxidation, and likely to be fatal to many of their delicate inmates.

It cannot be doubted that the careless or indiscriminate admission of vegetation into the marine aquarium is open to all these objections; but, on the other hand, it seems probable that its careful and judicious introduction would be productive of excellent results to the health of the animals, while there cannot be two opinions as to its adding vastly to the charm of the whole scene. To clothe, or partly to clothe, the bare and monotonous grey and yellow surfaces of rock which now form the regulation

background of our tanks with tufts of green and red seaweeds waving their delicate tresses in the gently-flowing water, would add the one thing now wanting to make the aquarium in practice what it is in theory, a miniature reproduction of rock-pools and sea-caves.

Now, the larger part of our British seaweeds are annual, and perish rapidly in autumn and winter, after producing countless zoospores from which a fresh generation of plants is to be born in due time.

These annual *Algæ* would be dangerous inmates of an aquarium, but in all three sections of the class (*RhodospERMæ*, *MelanospERMæ*, and *ChlorospERMæ*) there are perennial as well as annual species, and in the first division the plants are usually of a more delicate nature than in the two latter, of slower growth, and therefore more manageable.

We should therefore choose from among the *ChlorospERMæ* the one or two species which alone are perennial or biennial, such as *Cladophora arcta* and *Codium tomentosum*.

Unfortunately all the other species of *Cladophora* are annual, as also are those of *Enteromorpha* and the lovely *Bryopsis plumosa*, which, however, might be tentatively admitted by reason of its small size, slow growth, and singular beauty.

*Ulva latissima*, *lactusa* and *linza* are also all annual, and should certainly be introduced very sparingly, if at all, and with precautions designed to control and curtail their growth, to which reference will presently be made.

Among the *Melanosperms* scarcely any would be available. It is among the *Rhodosperms* that the ornaments of the aquarium might be chiefly sought; and although experience would doubtless prove that some species of this charming group would not flourish in confinement, probably a sufficient number would be found, whose graceful forms and attractive colouring would add immensely to the beauty of the tanks, and which would yet be sufficiently slow in growth to be under the necessary control.

What could exceed in elegance the waving fronds of *Ptilota plumosa* or the plaited tresses of *Plocamium coccineum*?

What more delightful contrast could be imagined than that of the white and pink somewhat rigid tufts of *Coralina officinalis* mingling with the bronze-coloured leaves of *Chondrus crispus*?

What more charming juxtaposition than that of *Gelidium cornutum*, with its purple-black branches, the regularity of whose sub-division almost suggests a metallic crystallisation, with the crimson ribbons of *Delesseria sanguinea*, filmy almost to transparency?

Unfortunately the elegant *Ceramiums* are all annual, but among such species as *Rhodomela subfusca*, *Polyides rotundus*, *Polysiphonia fastigiata*, *Dasya coccinea*, and a score of others, all perennial and of moderate growth, there is an abundant choice of variety in form, habit, and colour, which would certainly justify the experiment of setting apart one or two tanks in some public aquarium for their trial.

Were such an experiment to be tried, it would be desirable to use every precaution first of all to ensure a clear field by the elimination, as far as possible, of all pre-existing germs of other species than those which it is proposed to cultivate; a precaution, however, the necessity of which the appearance of existing aquaria scarcely suggests.

Freshly gathered plants might then be introduced, in all cases attached to pieces of rock or other base, which would make it easy to remove them immediately if they proved unsuitable for the purpose in question.

If a large number of young plants made their appearance on the sides or front of the tank, it would not be a serious matter to run out the contents, scrub the surfaces clean, refill it, and replace the original plants.



By using the perennial species exclusively or mainly, it would be possible to depend solely or essentially upon specimens thus attached, and having these always in reserve, ruthlessly to exterminate any young individuals which might spring up at inconvenient times and places or in superabundant numbers, although it is more probable that our marine friends would in most cases save all trouble upon this point by anticipating the process.

Whoever among the managers of our public institutions will have the enterprise to try this experiment will probably set at rest one of the unsolved problems of aquarian management, and open up a new field of public interest and of scientific research by largely extending the list of animals which it is possible to keep in a state of health in the marine aquarium.

A. W. WILLS

### THE NEW OBSERVATORY AT VIENNA

IN the *Monthly Notices* for November is an interesting paper by Dr. De la Rue on the preparations which are being made on the Continent for promoting physico-

astronomical observations. The paper refers mainly to the new observatory which is being erected at Vienna, and the illustrations which we are able to give will enable our readers to form some idea of the plan of the building.



FIG. 1 represents the south front of the observatory, the central entrance opening into the dwelling of the director, which is to the south of the large dome.

"It is scarcely necessary for me to tell the Fellows of the Royal Astronomical Society," Dr. De la Rue says, "that their favourite branch of our science, namely, the physics of astronomy, is now engaging the earnest attention of foreign professional astronomers to a greater extent than obtained only a few years ago, and that grand

preparations are now being made at several Continental State-observatories to grapple with the important truths which can only be revealed by adequate instrumental appliances such, indeed, as are far beyond the reach of most private fortunes. It was a matter of satisfaction to me to learn that photographic observatories are to be

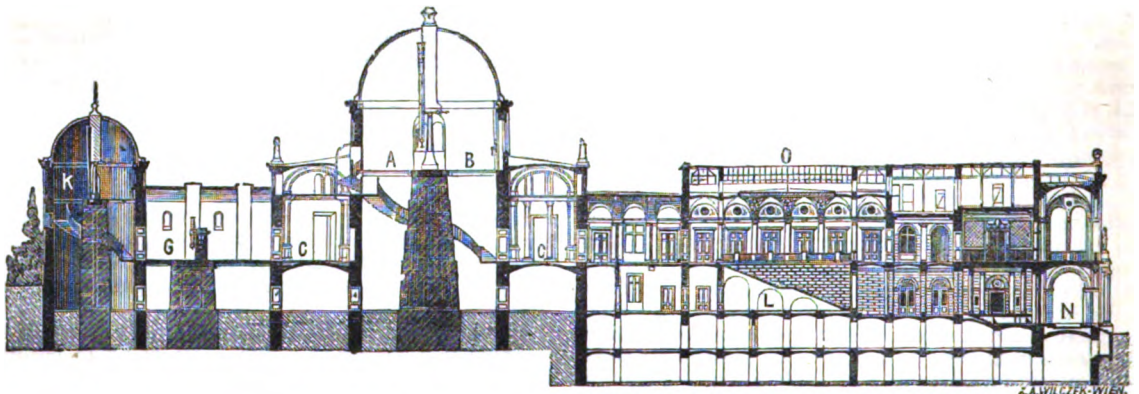

FIG. 2, drawn on a smaller scale than Fig. 1, shows the general arrangement of the establishment in plan. AB is the great dome, 42 feet in diameter; this dome is surrounded at its lower portion by the central hall CC, which will contain all the portable instruments. From this central hall access is obtained to the terraces D, adapted for observations with portable instruments or the naked eye. The rooms E and F will receive the meridian instruments, and in G is to be placed the prime vertical. The smaller domes, H, I, and K are each 25 feet in diameter; besides the instruments spoken of in the text, one of these domes will most probably be equipped with an altazimuth or a heliometer.

included in at least two of those observatories, namely, in Paris and Vienna."

Dr. De la Rue refers to the old Vienna Observatory, which was founded in the year 1753, and rebuilt in 1826-27, but has been long so crowded round by other buildings as seriously to interfere with the satisfactory performance of astronomical work. After repeated repre-

sentations to the Austrian Government, the present Director, M. C. von Littrow, obtained in 1873 the sanction of the Minister of Public Instruction, K. von Stremayer, for the erection of the building which is now approaching completion. The new observatory is about three miles to the north of the centre of the city, and was not commenced before Prof. Weiss, First Assistant at the Obser-



vatory, had visited the principal observatories in England and America, and the workshops of the first instrument makers in these and Continental countries. The site of the observatory, of which the foundation-stone was laid in June 1874, is a plateau of between 14 and 15 acres at an elevation of about 200 feet above the mean level of Vienna. The observatory is 330 feet long in the direction of north-south, and 240 feet in that of east-west. It is hoped that the building will be completed in 1877, and Dr. De la Rue, judging from the progress which had

ferable for the dwellings to have been detached, as the heated air emanating from them will be liable to disturb the definition of the instruments." We hope, however, that practically no real inconvenience will arise from this arrangement.

"From the preceding description it will be seen," Dr. De la Rue concludes, "that Austria will not be left behind in the steps which are being taken to promote physico-astronomical observations; and I sincerely hope that our own Government will ere long adopt measures to ensure to England a fair chance of honourably competing in the advancement of that branch of astronomical science which the Fellows of this Society have done so much to promote mainly from their own individual resources."

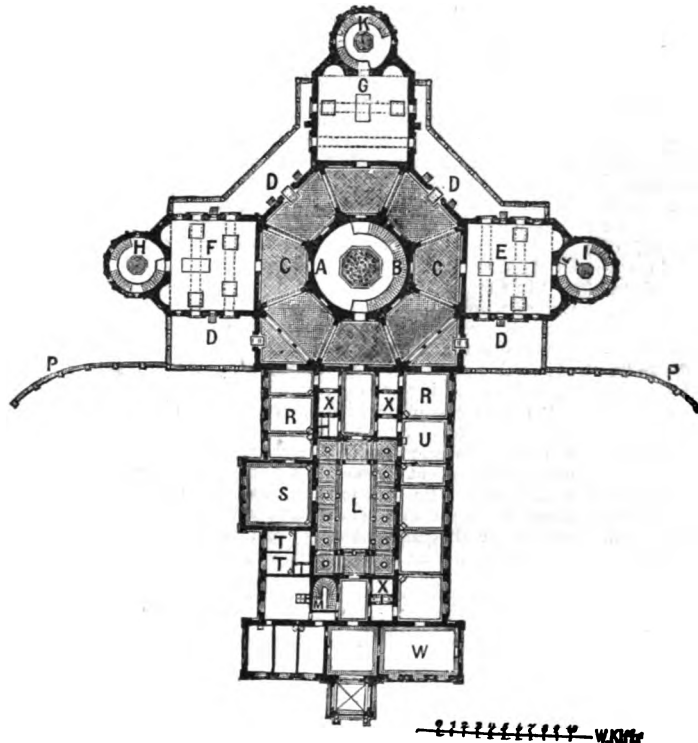

Fig. 3.—It will be seen that the first floor of the director's house is on the same level as the ground floor of the observatory; the apartments of the assistant astronomers are on the ground floor. CC show the section of the gallery surrounding the ground-floor of the great dome; L, the section of the staircase. Referring again to Fig. 2, W is the director's house in plan; S and T T, the library; U, the lecture theatre; and lastly, R, the offices.

been made when he visited it in October last, believes it will be ready to receive the instruments at that time.

The principal instrument of the observatory will be a refractor of about 26 inches aperture, to occupy the central dome of 42 feet internal diameter, both of which, as well as three smaller domes, two of which are shown in Fig. 1, are being constructed by Mr. Howard Grubb of Dublin. One of these smaller domes will contain an equatorial refractor of 12 inches aperture, by Mr. Alvan Clark, of Cambridgeport, Mass. "These two instruments, together with a meridian circle having a telescope of 8 inches aperture, and augmented by the instruments in the old observatory, will constitute the first equipment of the new establishment. Later on it is intended to place in the third dome an equatorial reflector specially adapted for photography, and also a prime vertical instrument in the room near the fourth dome, to the north of the central dome."

One arrangement, which Dr. De la Rue, with some justice, considers a drawback to an otherwise admirably arranged establishment, is that the buildings comprise the dwellings of the director, and apartments for the assistant astronomers. Although this arrangement will no doubt add to the comfort of the astronomers, "it would have been," Dr. De la Rue says, "in my opinion, pre-

THE ROYAL SOCIETY COMMITTEES

FEW outsiders are aware of the amount of administrative work done by the Royal Society by means of its numerous committees. The work in this direction done during the past year is so well set forth in the recent anniversary address (just published) of the president, Dr. Hooker, that an abstract of it will no doubt be interesting to our readers. The principal committees are the Eclipse Committee, the Transit Naturalists' Committee, the Arctic Committee, and the Challenger Committee.

The first enterprise referred to by Dr. Hooker was the Arctic Expedition, in the scientific equipment and instructions of which the Royal Society took an important part. Referring to the cruise of the *Valorous*, Dr. Hooker stated that it was through the representations of the Royal Society that Mr. Gwyn Jeffreys and an assistant were appointed to carry on temperature soundings and deep-sea dredging.

"Capt. Loftus Jones and Mr. Jeffreys dredged on the Greenland coast from 70° 30' N. lat. to the entrance of Davis's Straits, and in the Atlantic as far as 25° 58' W. long., in depths of which the greatest was 1,785 fathoms; and temperature-soundings were taken at eleven out of the twenty stations indicated in the Admiralty Instructions.

"Among the valuable results obtained are the fact that the fauna of the Greenland seas agrees with its land flora in being mainly Norwegian, there being (with the exception of the Echinoderms) an absence of many North-American forms, which, as it appears, have not been found eastward of the meridian of

Cape Chidley in Labrador. A remarkable mollusk, previously dredged at a depth of about 1,000 fathoms off the coast of Portugal by the *Porcupine*, and which, when first found in a fossil state in the newer tertiaries of Sicily was supposed to be an extinct type, reappears in the deep waters of Davis' Straits; and a *Campanularia* was found, specifically identical with one discovered this year in the opposite hemisphere, viz. in Kerguelen's Land, by Mr. Eaton, the naturalist of the Transit of Venus Expedition to that island. A most singular sponge-like diatom, named by Dr. Dickie *Synedra Jeffreysi*, with living *Globigerina* entangled in the colloid collecting-matter of its frustules, was taken in the towing-net.

"The existence of a remarkable elevation of the floor of the ocean was ascertained in lat. 56° N., long. 34° 42' W., where soundings of 690 fathoms were obtained between depths of 1,450 fathoms on one side and 1,230 fathoms on the other—an interesting fact when taken in connection with H.M.S. *Bull-dog* having found a similar elevation in lat. 59° 40' N. and long. 29° 30' W. It makes known the probable existence of a sub-oceanic ridge running N.E. and S.W. between Great Britain and Greenland."

With regard to the Transit of Venus Expedition, Dr. Hooker referred to the results obtained by the naturalists, who, on the recommendation of the Council, were appointed to accompany the expeditions to Rodriguez and Kerguelen's Land; in the former case Messrs. Balfour, Gulliver, and Slater, and in the latter the Rev. A. E. Eaton. With many of the results obtained by these naturalists our readers have already been made acquainted.

Rodriguez, Mr. Balfour has shown, is, after all, a volcanic island, possessing neither granite nor sandstone, but composed wholly of igneous rocks, with patches of coralline limestone along the coast. It belongs, therefore, geologically and geographically, to the Mascarene group. The general characters of its fauna and flora approximate very closely to those of the Mauritian group, upwards of 300 miles westward. Dr. Hooker then referred to the remains of extinct birds, including those of the Solitaire, and of extinct tortoises, which have been found in Rodriguez. Mr. Slater is of opinion that both classes of remains were entombed subsequently to the visits of Europeans. With regard to Mr. Balfour's Report on the Flora of Rodriguez, Dr. Hooker stated it as a very remarkable fact that one of the two new genera of flowering plants which have been found belonging to the natural order Turneraeae, is most closely allied to a peculiar Panama genus; and that one of the new species has only a single congener, which is a Pacific Island plant.

Mr. Eaton's Report on the Natural History of Kerguelen's Land we have already given at length in vol. xi. pp. 35, 75. Full information as to the results obtained by all the naturalists will be published, and, after a complete set has been reserved for the National Collections, the remaining specimens will be distributed. The total expenditure incurred was 1,512*l.*, of which 1,306*l.* has been contributed by Her Majesty's Government, and the rest has been defrayed out of the Donation Fund.

With respect to the Total Eclipse Expedition of April, 1875, Dr. Hooker speaks as follows:—

"Towards the close of last year (1874) the desirability of observing the total eclipse of the sun, which was to take place in India, engaged the attention of your Council; and the subject was under its consideration when a letter was received by me from His Majesty the King of Siam, offering hospitality and assistance should the Royal Society deem it expedient to appoint scientific men to observe it from His Majesty's dominions.

"Your Council being of opinion that both the importance of the occasion (totality during this eclipse being of longer duration than during any other that would be observed in the present century) and the liberal offer of His Majesty required careful consideration, appointed a committee of five astronomers and the Society's officers to report upon the feasibility of undertaking such an expedition with a reasonable prospect of success. The Committee was advised that no time was to be lost in arriving at a conclusion, as only four months would elapse before the occurrence of the eclipse.

"The first step taken was to communicate with the First Lord of the Treasury and the Secretary of State for India, and ascertain whether, should the attempt be made, Her Majesty's Government would be disposed to co-operate with the Society.

"The answers were most favourable; but still grave doubts were entertained by several of the Committee as to whether it were possible to make the necessary preparations and arrangements with sufficient completeness to secure adequate results.

"After much deliberation it was decided in the affirmative, the Committee's decision being based on the following favouring circumstances:—That confidence in its feasibility was expressed by those members of the Committee who had themselves conducted or accompanied eclipse expeditions in foreign countries; that two eminent observers, Messrs. Janssen and Tacchini, were already in India and their services available; that Her Majesty's Government would co-operate by proposing to Parliament a grant in aid of 1,000*l.*, which would be augmented by another of 300*l.* from the Donation Fund of the Society; that the Secretary of State for India and the Governor-General of India had promised active co-operation by sending an expedition to the Nicobar Islands, where, as well as in Siam, totality would be visible; that both the Indian Government and the Admiralty had granted passages in their vessels, and that the Peninsular and Oriental Company had offered to give passages to the observers and their assistants at greatly reduced rates; that His Majesty the King of Siam would defray all expenses of the party sent to his territories; and lastly, which perhaps weighed most with the Committee, was Mr. Lockyer's disinterested offer to superintend all the arrangements of observers and instruments, to prepare the instructions for their guidance abroad, and to make all the necessary telegraphic and other communications with India and the Straits Settlements previous to, and during the progress of the expedition.

"As in the case of former eclipse expeditions, invitations to take part in the observations were addressed to foreign men of science distinguished for their researches in solar physics; but

Prof. Tacchini was the only one who could accept. At the same time Dr. Vogel, of Berlin, a well-known photographer, was asked to assist, and he accompanied the expedition.

"A communication was received from M. Dumas, the perpetual Secretary of the Paris Academy of Sciences, with reference to Mr. Janssen's proposed observation of the eclipse; and instructions were sent to Singapore that every assistance should be afforded to that distinguished physicist.

"As a final result of these preliminary arrangements, there were two strong parties in position on the morning of the 6th of April, of whose members no less than six were sent out from England. One party, a combination of Italian, Indian, and English, went to Camorta in the Nicobar Islands; the other, French and English, made their way to Chulai Point in Siam. In the first party were Prof. Tacchini, Capt. Waterhouse, Prof. Pedler, Dr. Vogel, and Messrs. Meldola and Reynolds; in the second were Dr. Janssen, Dr. Schuster, Messrs. Lott and Beasley, each amply provided with assistants.

"The Committee decided that at both stations the observations should be mainly photographic; and the instruments furnished had for their object the registration of the violet spectrum of the corona and chromosphere as a whole, and that of the spectrum of an isolated portion of the image.

"Ordinary photographs of the corona and of the polariscope effects of its light were also provided for.

"In spite of the most hopeful anticipations, the weather at Camorta proved bad on the morning of the eclipse, and, as has been observed on former occasions, the reduction of the temperature, due to the withdrawal of the sun's heat, produced a mass of cumulus cloud which prevented a most thoroughly equipped party from making any observations whatever during totality.

"The success of the Siam party has been also far less than was anticipated. An unfortunate break-down in the Suez Canal, and some misunderstanding, in consequence of which the promised Government steamer was not forthcoming, caused delays which left so little time for the final adjustment of the instruments when the observers at last reached their station, that some records are altogether wanting; and the attempt to photograph the spectrum of an isolated portion of the chromosphere proved a failure.

"The most important results obtained are (1) a series of photographs of the corona, taken with a prism of small angle in front of the object-glass, which show several rings and part of the form of the outer corona; and (2) a series of views of the corona, chiefly taken at different times of exposure. The discussion of the observations has not yet been taken in hand; but it is not too early to state that several results of great interest and value have been secured.

"The King of Siam himself made a sketch of the corona and forwarded it to the Society. In common with others which accompany the reports, it does not differ very greatly from the figure photographed on the plate.

"I cannot conclude this short reference to one branch of our activity during the past session without congratulating English Science upon the fact that the eclipse was not suffered to pass unobserved, and without expressing our obligations to all those whose names will be mentioned at length in the report, who both here and abroad at each stage of the arrangements afforded us valuable assistance, not forgetting the observers themselves, who in the service of science volunteered for a duty not without risk, and from the performance of which, indeed, some have suffered in health."

Dr. Hooker next referred to the *Challenger* expedition, and to the interesting discoveries "which seem literally to have crowded along the course of the vessel." He referred to the light thrown by the *Challenger* researches on the formation of azoic clays and schists, on submarine geography, and on the distribution of pelagic life.

"In the depths of the sea, as on the surface of the land, are contiguous areas peopled by very different assemblages of living things. As on the land we ascend to meet a colder temperature, accompanied by forms of life of wider distribution than at lower elevations, so in the seas of warm and temperate regions we descend to meet with analogous conditions. The ocean thus mirrors one of the most striking features of the distribution of terrestrial life, and, mirror-like, it turns the picture upside down. Furthermore, this analogy is confined to the warm and temperate zones of the sea; in the cold zones this order of things is reversed; there, as on land, we descend to warmer temperatures, and the deepest sea is peopled by animals proper to a much lower latitude. The total result is a uniformity in the general

distribution of oceanic life that has no parallel on land; and facts in the migration of marine animals and plants that were formerly accounted for by assuming that they possessed greater powers of withstanding changes of temperature, are now accounted for by conditions more closely resembling those that obtain on the land."

Dr. Hooker then referred to the lamented death of Dr. von Willemoes-Suhm, and to the arrangement whereby Prof. Huxley has been able to act as Prof. Thomson's substitute at Edinburgh.

Speaking of the Meteorological Committee, Dr. Hooker stated that "the anomalous connection between the Royal Society and the Meteorological Office on the one hand, and between that office and the Government on the other, is likely soon to be terminated, the Lords Commissioners of the Treasury having appointed a Committee to inquire into the working of the present office, and the value of the results hitherto obtained. According to the instructions of the Treasury, the inquiry is to be directed to two principal points of scientific interest, viz. (1) How far the statistics hitherto collected have led to the discovery or confirmation of meteorological laws. (2) How far the principles upon which storm-warnings are given have been justified by results."

While pointing out that America was in some respects more advantageously situated than England for meteorological investigation, Dr. Hooker showed that, on the other hand, England has advantages for promoting the study of terrestrial meteorology that no other country has—namely, her foreign possessions and colonies, and the command of the telegraphs with which the ocean is in process of being crossed in every direction. "We have known," he says, "what it is to read at our breakfast-tables telegrams from all parts of the world of the prices of stocks and of political incidents of the previous day; why should we not, then, obtain daily statistics of the climatic conditions of these and other remote regions, and inaugurate in England a system of meteorological registration which, if its elements were obtained from but a few well-selected spots, would instruct and interest every intelligent person in the climate of the globe, and in the end lead to scientific results of great value."

Dr. Hooker cannot but think that the Committee of the Treasury will have the opportunity of recommending to Her Majesty's Government the adoption of measures that would greatly increase the scientific efficiency and public interest of the Meteorological Office.

Dr. Hooker referred in terms of disappointment to the unexpected interpretation which has been put by the Law Lords on the terms of the Gilchrist bequest, whereby no part of it can be allotted to "the advancement of learning" *i.e.* of research, but all to the propagation of knowledge. Dr. Hooker hopes that a future and more enlightened generation "will introduce into the theory and practice of the law an interpretation of the 'advancement of learning' more in harmony with scientific ideas and the requirements of the age."

The president concluded his address by alluding to the Government Loan Collection of Scientific Instruments, which is being formed at South Kensington.

"In the proposed exhibition not only are modern scientific methods and instruments, and the various methods of practical instruction in science to be fully dealt with, but it is also proposed that the history of science shall be illustrated by the actual instruments which have been employed from the time of Galileo downwards, in those critical experiments and discoveries which mark the principal stages along the road of progress."

#### THE FRENCH ACADEMY AWARD OF PRIZES

AT the anniversary meeting of the Paris Academy of Sciences on Dec. 23 the following prizes were awarded as the result of the competition for 1875:—

1. Grand prize in the Mathematical Sciences, not awarded, and the subject re-set for competition in 1878—"Investigation of the elasticity of crystalline bodies from the double point of view of experiment and theory."

2. Grand prize in the Physical Sciences. The subject was, "To investigate the changes which take place in the internal organs of insects during complete metamorphoses." The prize was awarded to M. Künckel, Assistant-Naturalist at the Paris Museum.

3. The Poncelet prize, to M. Darboux, for his analytical and geometrical works.

4. The Montyon prize in Mechanics, not awarded.

5. The Plumey prize of 2,500 francs was awarded to M. Madamet, French naval engineer, for an apparatus invented by him to indicate at any moment the number of turns made by a marine steam-engine by the simple inspection of a dial, and without the need of employing a watch.

6. Fournayron prize of 1,000 francs, to M. Sagebien.

7. The Lalande prize in Astronomy, to M. Perrotin, of the Toulouse Observatory, for his astronomical work generally, but specially for his discoveries of small planets.

8. The Lacaze prize in Physics, 10,000 francs, to Prof. Mascart, for his researches on the solar spectrum, on the measure of the dispersion of gases, on the influence which the motion of the earth has on optical phenomena, and for his investigation of the rate of light.

9. Montyon prize in Statistics, to M. Borius.

10. The Jecker prize of 5,000 francs awarded to M. Edouard Grimaux for numerous researches in Chemistry, more especially in chemical synthesis.

11. The Lacaze prize in Chemistry, 10,000 francs, to M. Favre, Dean of the Faculty of Sciences of Marseilles, for his great work on the transformation and equivalence of chemical, physical, and mechanical forces. It was while pursuing his researches in thermo-chemistry, commenced thirty years ago in conjunction with Silbermann, that M. Favre was led to investigate the great question of the equivalence of work effected by forces of different origin. M. Favre, giving an experimental demonstration of the most ingenious of Joule's views, made use of his mercury calorimeter, in the form of a thermometer in whose reservoir may be placed one or more elements. He thus established that the heat developed by resistance to the passage of electricity in the conductors of a simple voltaic couple, is simply borrowed from the total heat due to the chemical action which engenders the current; if this resistance to the passage of electricity be annulled we obtain, as the work of the pile with closed circuit, the quantity of heat which will be due to chemical action alone without the transmitted electricity.

12. The Barbier prize in Medicine, to Prof. Rigaud.

13. The Desmazières prize divided between M. Eugène Fournier, author of two memoirs on the Ferns of Mexico and of New Caledonia, and M. Emile Bescherelle, author of two memoirs on the Mosses of the same countries.

Prizes 14, 15, and 16 not awarded.

17. Grand prize in Medicine and Surgery, to M. Onimus.

18. Montyon prize in Medicine and Surgery. These prizes, of 2,500 francs each, were awarded to M. Alph Guérin, M. Legouest, and M. Magitot respectively. "Encouragements" of 1,500 francs each were awarded to M. Berrier-Fontaine, to M. Pauly, and to M. Raphaël Veyssière.

19. The Bréant prize not awarded.

20. The Godard prize in Medicine, awarded to M. Alph. Hergott.

21. The Serres prize not awarded; but a reward of 3,000 francs was given (1) to M. Campana for his researches on the anatomy and physiology of the respiratory and digestive apparatus, and of the serous membranes of birds; and (2) to M. Georges Pouchet for a MS. work on the development of the skeleton, and especially the cephalic skeleton of osseous fishes compared with that of some other vertebrates.

22. The Chaussier prize in Medicine, of 10,000 francs, divided between M. Gubler, M. Le Grand du Saulle, MM. Bergem and l'Hôte, and M. Manuel.

23. The Montyon prize in Experimental Physiology, 764 francs, to M. Faivre, Dean of the Faculty of Sciences of Lyon, for his researches on the functions of various parts of the nervous system of insects. M. Faivre has established that among insects the localisation of function and the division of physiological work, are carried further than is generally supposed.

24. The Lacaze prize in Physiology, 10,000 francs, awarded to M. Chauveau, Director of the Veterinary School of Lyon, for his researches on virulent and contagious diseases. M. Chauveau has proved that the virulent activity of the vaccinal, variolar, and glandular virus is not due to the liquid, as a whole, but oftenest to corpuscles which are held in suspension. M. Chauveau has, moreover, discovered that the agents of contagion have not only as a vehicle the liquids which come from the bodies of the sick, but that they may be transmitted to healthy animals by means of air and water. He shows that the human variola is a distinct malady by itself, of which the primary source is the organism of the horse.

25. Montyon prize, in connection with unhealthy occupation, 2,500 francs, to M. Denayrouse for his invention to protect workmen while in the midst of an irrespirable medium.

26. The Tremont prize, 1,000 francs, having been awarded for three years, 1873-75, to Prof. A. Cazin, an "encouragement" of 500 francs was awarded to M. Sidot for his researches on the various conditions of carbon and on the protosulphuret of carbon.

27. The Gegner prize of 4,000 francs was awarded to M. Gaugain to assist him in pursuing his researches on electricity and magnetism.

28. The Laplace prize, consisting of a complete collection of the works of Laplace, was awarded to M. Bonnefoy, "dux" of the École Polytechnique in 1875.

### NOTES

PROF. HUXLEY, on Tuesday last, at the Zoological Society, in his paper on *Ceratodus*, in describing the brain of that fish for the first time, showed how closely it approached that of the Lepidosiren, and how that in some points it resembled the Selachian rather than the Ganoid type. He gave cogent arguments against the theory of Gegenbauer with reference to the typical conformation of the fore limb, and laid special stress on the affinities of the animal with *Chimera*.

THE Crown Prince and Princess received the leading German scientific men on Monday at Berlin, in order to confer upon the means of securing an adequate representation of Germany in the exhibition of scientific instruments to be held in London next May. Besides Doctors Achenbach and Falck, the Ministers of Commerce and Education, there were present Herren Kirchhoff, Dubois-Reymond, Dove, and Foerster, as physicists; Herren Hoffmann and Maghellans, as chemists; and Herren Reuleaux and Siemens as representatives of mechanical science. Mr. Cundiffe Owen, the Director of the South Kensington Museum, was present at the audience. A German committee was formed to promote the objects of the meeting. This is the latest adhesion to the scheme, and we are now able to say that the arrangements are complete in the case of Germany, the United States, Belgium, Holland, and Switzerland. In all these countries, committees appointed by Government are collecting instruments either for the Research, the Historical, or the Educational department.

THE following extract from the Order Paper of the Legislative Council of New Zealand, Oct. 19 last, seems to show that a supposed prehistoric man may perhaps become the subject of a judicial inquiry. The skeleton in question was exhumed in the course of excavations made for Moa bones and associated human remains by Dr. Haast, as detailed in his paper ("Trans. N.Z. Institute," vol. vii.), and as that author holds strongly to the Palæolithic age of the deposit, while others assert its comparatively recent date, it will be interesting to observe what light the coroner's inquest will throw on the subject:—"The Hon. Mr. Mantell to move, That there be laid upon the table copies of any proceedings at any inquest held upon a body found, under suspicious circumstances, in a cave known as the 'Moa Bone Point Cave,' at Sumner, in the Province of Canterbury, on Saturday, Oct. 19, 1872, whose skeleton is reported to be in the Christchurch Museum. And, in the event of no such inquest having been held, that the Government lay upon the table a statement of the reasons why no inquest was held; or assure the Council that instructions will be forthwith issued to the proper authorities to make such inquiry as may, if possible, lead to the identification of the individual whose body was so found, and set at rest any doubts as to the manner in which he came by his death."

WE would draw the special attention of our readers to a paper in the current number of the *Journal of Mental Science*, by Dr. Herbert B. Major, entitled "Observations on the Brain of the Chacma Baboon." Having, in his Graduation Thesis before the University of Edinburgh, shown that in the smaller apes the

size of the nerve corpuscles of the cortex of the occipital lobes was less than in the human subject, the author has analysed, layer by layer, the cortical substance of the brain of the chacma and man, his observations as yet being entirely negative. The points investigated are the number and appearance of the layers; the character of the nerve-strata; also the vessels and the white medullary substance.

THE large female chimpanzee, Mafoka, at Dresden, which has recently attracted so much attention, died, we regret to say, a short time ago. Dr. Meyer promises us an account of the animal.

A PAPER by Prof. Reinhardt has recently been published at Copenhagen, on the Glyptodon remains of Brazil, together with the account of a new species, *Glyptodon (?) dubius*.

THE *lloge* of General Poncelet at the anniversary of the Paris Academy was the occasion of a pathetic scene. A tribune had been set apart for the use of Poncelet's widow, who was sitting with her lady companion. When M. Bertrand referred to the attentive care which had surrounded the last days of the departed geometer, and the real worship paid to his memory by the noble woman who had been his wife, Madame Poncelet could not restrain her weeping, and her emotion was communicated to the whole audience. The house was crowded by friends and pupils of Poncelet.

THE Meteorological Society of Paris has elected M. Janssen president for 1876. Mr. R. H. Scott, the director of the English Meteorological Service, has been nominated a member of the Council, and M. H. St. Clair-Deville one of the vice-presidents.

AT a recent meeting of the Vienna Geological Society, the Director, M. von Hauer, welcomed Dr. E. Tietze, who, after more than two years' sojourn in Persia, had safely returned to Vienna. He made extensive geological researches, especially in Mount Elburz, and eastward as far as Asterabad and Sharood. He visited, besides, the environs of Asabeidshan, Ispahan, Chamjar, and the province of Farsistan, as also the salt desert south-east of Teheran.

THE "Results for 1873 of the Meteorological and Magnetical Observations taken in Victoria, Australia," have been received. In addition to the usual averages, which appear to be carefully made, Prof. Ellery gives valuable summaries of electrical phenomena, hailstorms, frosts, snow, sleet, gales, and strong winds, together with a detailed statement of the "hot winds" which have occurred during the year in different parts of the colony, and which form so important a feature of the Australian climates. The publication is accompanied with a map, showing the positions of the meteorological stations and the telegraph and railway routes.

FROM Dr. King's recently-issued report on the cinchona plantations in British Sikhim, which we have previously noticed, we learnt for the first time that an efficient febrifuge was being made and sold at a cheap rate in India. On this subject Mr. Gammie, the resident manager of the Government plantation at Darjeeling, writing to Dr. Hooker, says: "We are now busy collecting cinchona bark, and propose to collect about ninety tons of dry bark this season, which we can easily do. We are manufacturing it on the spot into a cheap febrifuge, which is evidently quite as effectual as quinine. The medical department appears to be taking kindly to it, for within the last three months I have sent them over 600 lb. of it, and they are asking for more. We are now making from 40 lb. to 50 lb. a week, but are daily expecting orders to extend our factory, so as to make at least double that quantity. We have good hopes of being able to sell the febrifuge at one rupee an ounce and pay all expenses." Mr. Wood, the Government Quinologist, has, it appears, been appointed to officiate as Professor of Chemistry at Calcutta, and since his departure for the capital, the manufacture has fallen upon Mr. Gammie.

PROF. C. HOLTEN has sent us "Tables Météorologiques de Copenhague pour l'année 1874," prepared by him, and published under the auspices of the Royal Danish Academy of Sciences and Letters. A special feature of this publication is the long averages which appear with the monthly sheets of observations. As regards rain, the averages are for fifty-five years, and as regards temperature for ninety-two years. The temperature averages are particularly valuable, seeing that they are given for this long series of years for each day, each five-days period, and each month of the year.

THE contents of the Southport Aquarium have been studied with marked interest by a large number of persons during the Christmas holidays. Amongst recent additions is a very fine specimen of *Alligator lucius*, from New Orleans, more than 8½ feet in length, a very large number of young alligators, some only a few inches, a school of herrings of all sizes, two masses of living sponge containing large colonies of brittle star-fish, young skate hatched in the aquarium, in the octagonal table tanks, which also contain a magnificent collection of sea anemones, echini, living bivalve shells, zoophytes, annelids, and seaweeds. Amongst recent improvements noticeable in this aquarium is the placing of sheets of india-rubber between the plate-glass fronts of the wall tanks and the iron mullions, which has had the effect of entirely preventing the cracking of the glass from sudden changes of temperature. The quantity of water circulating in the tanks has been increased, fresh supplies being only received to compensate for evaporation. The company have a large number of iron tanks placed at the end of the pier to receive at once rare fish brought in by the deep-sea trawlers.

WE regret to hear of the death of Mr. James Hinton, well known as a writer in practical physiology and in philosophy.

M. GERMER BAILLIÈRE, the enterprising editor of the *Revue Scientifique* and *Revue Littéraire*, has started two new periodicals, an "Historical Review," quarterly, and a "Philosophical Review," monthly.

A TRIBUTE of respect was paid by the late French National Assembly to the learned Minister of Public Instruction, M. Wallon, who was elected a life-member of the Senate, representatives of every political party having voted for him, although he had declined to stand as a candidate.

THE Catholic University of Paris opened its course of scientific lectures on Dec. 27. The lecturer in higher mathematics is M. Serret (not the well-known member of the Institute). The lecturer in physics is M. Brauly, who was the *préparateur*, or general assistant of M. Desains, the Sorbonne lecturer. No lecturer has yet been found for botany.

THE establishment of a School of Mines at Lille is in contemplation.

AN Imperial ordinance, published on Jan. 1, directs that the thanks of the Russian Government be conveyed to Prof. Nordenskjöld, for his exploration of the Polar Sea up to the Yenisei River.

THE Government has ordered that the annual cost of the Ordnance Survey of the United Kingdom shall be reduced. During the past and present week a large number of civil assistants at the head-quarters at Southampton have received their discharge.

EXPERIMENTS will be tried in France within a very few days with a new system of taking up and depositing letter-bags from a railway-train running at a great velocity. The apparatus, which was invented by a chief telegraphist, is entirely self-working, and great expectations are raised by the French Administration. A waggon of the Lyons railway has been

entirely fitted up on the new principle, and a special post for collecting and delivering has been erected in the Varenne St. Maur Section.

A SPECIAL meteorological monthly paper has been published by M. H. St. Clair-Deville, who has just organised the Algerian Meteorological Service. The first number was issued a few days ago.

MOST interesting experiments are now being conducted at the Northern Railway Station, Paris, in the use of light generated by gramme magneto-electric machines. Success has been only partial, owing to the want of motive-power, but hopes are entertained of a speedy and successful result.

WE are glad to see from No. 2 of the *Iowa Weather Review*, that the scheme of meteorological observations for the State of Iowa has thus far proved a success. For the first decade of November, Dr. Hinrichs received eighty station reports from all parts of the State. A report of the results is at once prepared and forwarded to the newspapers for publication. The rest of the *Review* is taken up with minute directions as to the method of observing for the purpose of securing accuracy, uniformity, and fulness in the results of the observations embraced by the scheme.

MR. MURRAY has issued cheap editions of the narratives of Livingstone's first and second African expeditions. In the case of the former the cheap edition seems to be a reprint of that published during the author's lifetime, while the second is somewhat abridged. Both are neatly got up, contain most, if not all of the original illustrations, and will be welcomed by many who desire to possess the original narratives of the work which has made Livingstone immortal.

A REMARKABLY valuable discussion by M. Belgrand, of the inundations of the Garonne, viewed specially in connection with the heavy rains which fell over France from the 21st to the 24th of June last, has been appearing at intervals for the past fortnight in the *Bulletin International* of the Paris Observatory. It is pointed out, from the dates of their occurrence, that the inundations of the southern portion of the basin of the Garonne which slants from the Pyrénées, have nearly always occurred in spring or early summer, and at the same dates either no floods at all, or comparatively unimportant floods, were experienced in the northern portion of the basin which slopes down from the Cevennes and central plateaux of France. It is to be noted that it is just at this season that the rainfall of the southern portion of France attains its annual maximum, and the nearer to the Pyrénées the more decidedly is the May-June maximum marked, and that the melting of the snows which have accumulated on the Pyrénées during the winter months proceeds most rapidly. On the other hand, it is shown that the great inundations of the northern portion of the basin occur generally during the cold months of the year, and that at the time of their occurrence there have been no corresponding great floods at Toulouse, in the southern portion of the basin. It is during the cold season that the rainfall reaches its annual maximum on leaving the slopes of the Pyrénées and advancing northwards over the basins of the Tarn, Lot, and Dordogne. The disastrous inundation of June, 1875, was in accordance with the experience of previous floods in the south of France. As a great flood it was limited to the river courses sloping down from the Pyrénées; and the nearest approach to a great flood elsewhere was in the basin of the Argout, the most southern tributary of the Tarn, and it was the flood of this tributary which occasioned almost the whole of the flood of the Tarn. At such places as Auch, situated in a narrow valley, and where, consequently, the drainage area is small, the inundation was much less disastrous than at Toulouse and places similarly situated

near the confluence of large affluents draining a wide extent of country. The following official statement of the numbers of the persons drowned, classed according to the departments, will indicate the line of greatest devastation:—Ariège, 73; Gironde, 1; Haute Garonne, 330; Lot-et-Garonne, 20; Tarn-et-Garonne, 116; total, 540. The discussion of these inundations with reference to the season of the year in which they have occurred in different portions of the Garonne basin, and in their relations to the physical configuration and annual maximum rainfall of each district, indicates a line of inquiry which, if further prosecuted, cannot but lead to most important practical results.

THE additions to the Zoological Society's Gardens during the past week include three Moose or Elks (*Alces machlis*) from N. America, two Arabian Gazelles (*Gazella arabica*) from Arabia, deposited; a Pig-tailed Monkey (*Macacus nemestrinus*) from Java, presented by the Rev. W. Ewart; a Green Monkey (*Cercopithecus callitrichus*) from W. Africa, presented by the Rev. J. W. Ayre; an Earle's Weka Rail (*Ocydromus earlei*) from New Zealand, presented by Capt. H. Braddick.

### SCIENTIFIC SERIALS

*Bulletins de la Société d'Anthropologie de Paris*, fascicules 2, 3, 1875.—The former of these numbers gives the discussion which followed the reading of a paper by M. Pommerol, on the rock-excavations, basins, rocking-stones, and holes observable in many of the rocks of Puy-le-Dôme. Contrary to the view which he had advanced in regard to their connection with pre-historic or early historic races, and their formation by man for domestic or religious purposes, the society generally concurred in the opinions maintained by MM. Leguay, Hamy, and Mortillet, that such formations are for the most part the results of natural causes, and that flint implements would have been incapable of acting upon the hard granite of which they usually consist. They admitted, however, that some of the depressions and holes may in a few instances have been enlarged in process of time through human agency, after having become the scene or object of superstitious veneration.—M. Morice laid before the Society a report of the various races which now occupy Cochinchina, the most numerous and characteristic of which are the Annamites and Cambodians. Next in point of numbers stand the Chams and the Mois, or mountain-men, and beside these a hybrid race, half-castes between Annamites and the Chinese settlers, and known as Minuongs, is rapidly attaining consideration as a distinct class.—M. Hamy gave a brief summary of a memoir, which he will soon publish *in extenso*, on the craniological characters of the race that now occupies the Island of Timor, and which he considers to be not far removed from the Papuan Negritos. His examination of a number of Timorian skulls has led him to accept as proved the distinctive characteristics assigned to the race by Owen, Busk, and De Quatrefages.—M. Topinard's paper on Australian hybrids gave rise to a long discussion, but can scarcely be said to have contributed directly or indirectly to the elucidation of any of the difficulties involved in the subject.—M. Piette's communication of the result of his exploration of the Gourdan and L r el caverns is interesting from the fact that, in addition to the ordinary reindeer-lion, aurochs and other animal remains found in such caves, he discovered parts of two human jaws. One of these—the lower maxillary bone of an adult man, to which several much-worn teeth were still attached—was found at Gourdan in close proximity to bones referred by the author to *Cervus canadensis*, or a closely allied form. The other jaw, apparently that of a child of seven, who had died during dentition, was excavated from the floor of the Lortel cavern at a depth of 6 metres.—M. Condereau laid a paper before the Society, and explained the elaborate series of tables which he has constructed to illustrate his system of the classification of articulate sounds, and which he hopes to see accepted by anthropologists as the basis of some uniform phonetic-physiological alphabet, by which writers of different nationalities may be brought on a common ground for the comparison of the different articulate sounds of which the human voice is capable.—M. Broca brought under the notice of the Society a negro skull belonging to their museum, where it forms the fifteenth in the Gannal collection, in order to show how the normal parietal foramina may present such unusually large dimensions as to assume

after death the appearance of artificially produced parietal perforations. At a previous meeting of the Society, on March 18, M. Broca had exhibited a skull taken by M. de Palmas from an ancient cemetery in the Canary Islands, which presented a double parietal opening.—A very interesting and important paper was read by M. Broca on May 20, when he laid before the Society a *résumé* of the "Craniometrical Instructions" which they had commissioned him to draw up for the guidance of anthropologists. In accordance with the directions of the Commission these instructions are preceded by a description of the anatomy of the head, in which an entirely new anatomical nomenclature has been adopted, for which M. Broca craved the approval of his *confrères* on the ground of the obscure terminology hitherto in use in craniology. Among a number of novel terms we may instance such words as endocranium and exocranium; pteron and discus for the ascending and the horizontal parts of the greater ala; inion for the external protuberance of the occipital; and basion, opisthion, staphanion, pterion for distinctive portions of the occipital, frontal, and temporal fossa. M. Broca announces that this new system of cranial terminology will be soon published *in extenso* in the "Memoires" of the Society.—M. Collineau, in connection with the subject of arrest of development in the osseous and other parts of the brain, as shown by M. Broca in his paper on parietal perforations, drew attention to the extraordinary spread of religious mania in France, of which he gave numerous instances amongst the higher as well as lower classes, and appealed to medical and other scientific men to devote themselves to the elucidation of this important subject.

*Der Naturforscher*, November, 1875.—This number contains an account of some interesting researches by M. Exner, on the capability of perceiving a time-difference between two impressions of sense. Suppose a stimulus to act at moment *a*, and another at moment *b*, how near may *a* and *b* come together and the impressions continue distinct? M. Exner examines the various cases of two impressions on the same, and on different elements of an organ of sense, on similar elements of a pair of organs, and on elements of different sense organs.—From experiments on decomposition of albumen in animal bodies, M. Forster concludes that the blood of one animal introduced into the vascular system of another behaves like the blood already present; that albumen solutions brought into the blood are decomposed like albuminous substances received through the stomach and intestine; and that, of the albumen present in the body, that which is firmly held in organs and cells is but little decomposed, while that entering the intestine or blood-vessels in solution is mostly decomposed.—The physical properties of a freezing mixture of sulphuric acid and ice are investigated in a paper by M. Pfaundler, and M. de Coppet discusses superfusion and super-saturation according to the mechanical theory of heat. Most of the remaining papers hardly call for notice here.

### SOCIETIES AND ACADEMIES

#### LONDON

Royal Society, Dec. 16, 1875.—Note on the Placentation of Hyrax, by Prof. Wm. Turner, of Edinburgh. The author describes the result of his study of a spirit specimen, his object being to verify or refute the recent statements of MM. H. Milne-Edwards and George, which, contrary to the observations of Sir E. Home, Owen, Huxley, and others, are to the effect that the placenta of *Hyrax* is non-deciduate. He shows that the placenta of *Hyrax* is deciduate, like that in the cat, which it resembles in form; it has also a large allantoic sac.

Geological Society, Dec. 15, 1875.—Mr. John Evans, F.R.S., president, in the chair.—Francis James Bennett, Alfred Allinson Bourne, Charles Thomas Clough, John Law Cherry, William Herbert Dalton, Walter Saise, James Weeks Szlumper, and Lamont Henry Graeme Young, were elected Fellows; and Prof. August Quenstedt, of Tübingen, a Foreign Member of the Society.—"Notes on the Physical Geology of East Anglia during the Glacial Period," by Mr. W. H. Penning. The author wished it to be understood that his remarks were intended to form a sketch, rather than a detailed account of the subject to which they relate. He intended to explain the origin of the so-called "middle glacial" gravels and sands, to account for their occurrence in certain areas and their non-occurrence in others, where they might reasonably have been expected. Also to briefly describe a certain series of gravels of doubtful age and origin in the



Cambridge valley. A short description of the geology and physical features of the district was given, and an inference drawn from the varying faunas of the "Crag" that the land was sinking during that era and until after the deposition of the Cromer "Forest-bed." Then Arctic conditions began to prevail, and the great glacial subsidence commenced; the "lower glacial" beds were formed, and succeeded by a large series of false-bedded gravels and sands, with intercalated patches of unstratified clay. These deposits run up only to a certain level, about 300 feet, never quite reaching the top of the chalk escarpment, where the overlying boulder-clay is invariably found resting on the older rock, without any gravel or sand between. The author inferred from this circumstance that after the deposition of the "lower" beds, and as submergence went on, the waters of the North Sea were again united to those of the Atlantic. A strong current was thus set up, which swept down from the north, bringing with it the material of which the gravels are composed, and which is found to consist of pebbles, all derived from the northern and eastern coasts, mixed with flints from the chalk. The escarpment of this formation stood at the time above the water, but when once sufficiently submerged to admit the water over its lower portions, the conditions were altered, the current lost its force, and the deposition of gravel ceased. An occasional iceberg had dropped its load of unstratified clay, which became intercalated with the gravels, but the greater number of such bergs were quickly swept away to the south. Now the waters had access to a larger area, the formation of gravel was succeeded by that of boulder-clay, which in the author's opinion is entirely composed of masses of clay enclosing boulders, brought down and dropped by icebergs *in mass*, which accounts for its want of stratification. This boulder-clay rests evenly on and at the higher level overlaps the "middle glacial" sands; it then caps the chalk escarpment and plunges down into the Cambridge valley, even to the present level of the sea; but in no instance on or beyond the escarpment does any sand or gravel intervene between it and the older geological formations, although just over the scarp (on the south side) the gravels run up to an elevation of 300 feet. The gravel-forming currents were evidently confined to the seaward side of the chalk range, and excluded from the Cambridge valley, which is undoubtedly *pre-glacial*, and which formed at the time a large inlet, land-locked on every side but one, discharging its waters through the opening now occupied by the estuary of "The Wash." In the Cambridge valley there are sheets of river-gravel of recent date, some patches of doubtful age, but not traceable under the boulder-clay, and an elongated series of gravels at a level of 20 to 60 feet above the present level of the Cam. These are in some parts distant from the present course of the river, and present a striking resemblance to glacial gravels; but as they here and there contain recent shells, and taking into consideration their uniformity of level, the author concludes that they indicate an ancient course of the River Cam. The other conclusions arrived at, after mature consideration of all the evidence hitherto obtained, are— that a gradual passage will be found to exist from the base of the crag up to and through the drift-deposits to those of recent date; that in East Anglia we have evidence of but one, and that a gradual period of glacial submergence succeeded by a corresponding movement of re-elevation; and that there are no "middle glacial" deposits whatever within the area of the Cambridge valley.—"Denuding Agencies and Geological Deposition under the Flow of Ice and Water, with the Laws which regulate these actions, and the special bearing on river-action, of observations on the Mississippi and other great rivers, and their present and past Meteorological conditions, and similar remarks on Marine Deposits, illustrated by the Irish Sea and the Chesil Beach," by Mr. A. Tylor. The writer adduced evidence by measured sections and drawings to show that the Quaternary gravels were deposited rather in a wet or pluvial than in a snowy or Glacial period. He thought the denuding action of springs and the alternate action of rain and frost had been neglected. He considered Agassiz and other writers had overlooked the previous writings of Playfair, to whom he referred. The rainfall of Westmoreland, Switzerland, and the Mississippi valley were compared in summer and winter to prove that floods were not necessarily greater from land covered with snow than from land covered with trees and vegetation when height above the sea and local circumstances were taken into consideration. Mr. Dana's "Great Glacier," whose melting was to supply a Quaternary river, Mississippi, 50 miles wide, would require a supply equal to 625 times the present rainfall to fill it. The melting of snow was assumed to be of such pro-

portions by modern writers as to equal the débâcles of older geologists. The high Swiss mountains pointed to a greater diminution of snow on high ground in the Glacial period; and he believed the clouds then discharged near the sea-level, so that the mass of snow and ice was at low levels. It appears that in Greenland in the 80th parallel, according to Nordenskiöld, near the sea in summer there is no snow on the ground 1,000 or 1,500 feet above the sea. Open water at the poles must depend upon the abstraction of the vapour from the atmosphere at lower latitudes; and probably in the Glacial period the ice-cap was thickest at the 70th parallel of latitude. Mr. Tylor thought the theories of former depressions of the land, as in the Mississippi valley, should be tested by examination for flexures. He had found (in 1868) that flexures, and fractures, had very much affected the course of the Wealden denudation in the Quaternary period. The laws of river motion are very simple and precise; and as depressions and upheavals are always unequal, any great movements in the Quaternary period would affect the courses of rivers, and be traceable in their deposits. The author had measured the *remanis* valley gravels of Coalbrook Dale, which were associated with marine shells 200 feet above the sea, and compared their contour with ordinary valley gravels and with marine beaches, to ascertain under what probable conditions the sea had risen up the Severn valley without leaving any traces of cliffs or marine denudation except between Bridgnorth and Coalbrook Dale. The diamond gravel-deposits in Africa have a similar contour to those of Coalbrook Dale. The position of the Moel Tryfaen beds was first described by Trimmer in 1831. Trimmer, an excellent geologist, observed the scratches on the rocks covered by the gravel with marine remains, and noticed their ice-origin, but did not draw, unfortunately, the natural inference that there must have been a Glacial period in Wales. This great discovery or invention was left to Agassiz to propose in 1837. The glacier-eroded lakes, much lower than Moel Tryfaen, and close to it, are free from marine remains, therefore it seems difficult to suppose a depression of 1,300 feet and immersion in the sea of Tryfaen, and subsequent elevation, could have taken place without having left any marks on the land except at one spot. The measured section of the Chesil Beach shows its close approximation to a binomial curve, and the regularity of beaches and littoral zones along the Channel teach us what are the certain consequences of land being immersed under the sea. Mr. Tylor produced plans and sections showing how the tide actually affects the sea-bottom, and described the gorge below 50 fathoms in the Irish Sea. He treated the tide as caused by the alternate and opposite slow movement of the deep and great mass of the Atlantic, giving motion to the water at the coast almost simultaneously as if the whole water moved as one mass over an area of thousands of square miles. The velocity of the tide of one tenth of a mile per hour in a deep sea, produced by the composition of forces a tide of a velocity of three or four miles an hour on the coast. High and low water at different ports are the direct consequences of local currents in shallow water, set in motion by the greater mass of deep water. There are points in the English Channel where within a few miles there is a difference of six hours in high water. He objected to the theory of a tidal wave travelling in one direction, and moving faster in deep water than in shallow, because the tide really travels quicker in shallow water, as his plans show. In support of this he showed the chart of the Channel, and that the tide turned in the Irish Sea at all points, deep or shallow, almost simultaneously and synchronously with the slow tidal movement in the Atlantic. He found that in a large area of sea of 120,000 square miles, where the water averaged 67 fathoms off the Scilly Islands, the velocity of the tide was only one mile per hour, but in the shallows near the Channel Islands, where the depth was on an average 12 fathoms, by the composition of forces the velocity of the tide increased to 6 miles an hour. If the tide was the consequence of a tidal wave bringing high water, the tidal conditions of the Irish Sea would be very different from what they are described to be. He did not find any evidence of a plane of denudation on any sea coast, but, on the contrary, deep gorges and curved surfaces, depth varying with width, &c. The nearest approach to a plane surface was in the estuary of the La Plata; but that flatness appeared more the consequence of deposition than denudation. The great cuts or indentations out of coast lines where rivers discharge into the ocean, when compared with the absence of indentations in areas where there are no great rivers, but where the rocks are equally hard, showed that such denudation depended upon the alternate and opposite action of rivers and the tide. He referred to the removal of the bar

of the Danube, and to the great laws which regulate the flow of water, which he illustrated by diagrams. Hydraulics and meteorology must be studied in connection with the lines of denudation and deposition; and however difficult and inconvenient these subjects might be, no results would be reliable unless all the physical circumstances were taken into account.

Anthropological Institute, Dec. 28, 1875.—Col. A. Lane Fox, president, in the chair.—Major H. H. Godwin-Austin, E. Willett, Mrs. T. Cowie, and A. L. Lewis, were elected members.—Mr. John Evans, F.R.S., read a note on a proposed international code of symbols for use on archaeological maps, which had been prepared by the sub-committee appointed at the Stockholm meeting of the Congress of Prehistoric Archaeology.—Miss A. W. Buckland read a paper on divination by the rod and by the arrow. The author endeavoured to prove:—1. That from personal observation, rhabdomancy is still practised in England in certain localities, and that it is a survival of a very ancient superstition originating in the use of rods as symbols of power. 2. That the staff as a sceptre was probably a later form of the horn which was thus used in very early prehistoric times, and in that character adorned the heads of gods. 3. That from the use of rods or horns arose a veneration for them as possessing the inherent power of healing disease and even of restoring life. Hence their use by magicians in all ages and countries, the chief instruments employed by them being a ring or circle, and a staff and a bifurcated stick. 4. That these symbols conjoined are found in Egyptian, Assyrian, and Peruvian sculptures, and may be traced in some of the stone circles of Britain, and in the shape of Irish and African brooches and fibulæ. 5. That from the belief in the magical powers of rods perhaps arose tree-worship, or at least such veneration for trees as is observable of the oaks of Dordona and of the Druids, the ash of Scandinavia, and, for some unexplained reason, more particularly of the hazel. 6. That belomancy, or divination by marked arrows, said to be of Scythic origin, was practised in Babylon, Judæa, and Arabia, and that traces of it may still be found in the folk tales of Russia and Siberia. 7. That the mode of using these arrows had a strong resemblance to the very ancient custom of casting lots common to all peoples ancient and modern. 8. That the invention of lots and dice, as well as that of the divining rod, is ascribed to Hermes or Mercury identified with the Woden of Scandinavia, and by some writers also with the India Buddha. 9. That a strong resemblance exists between the implements of magic and the ancient alphabets, also the reputed invention of the same god or gods. 10. That many of the signs or letters forming the Archaic-Phœnician, and other alphabets, are found in the rock sculptures of Peru, thus adding one more to the many proofs of a communication existing between the hemispheres in prehistoric times. 11. That the arts of magic and divination were not of Aryan origin, but remnants of the Turanian or Pre-Aryan faith which once overspread the world. 12. That this is proved by their present existence among aboriginal non-Aryan races, and may, perhaps, even be used as a test of race, so that those who in Somerset and Cornwall are said to possess the power of divination by the rod may possibly have some remote affinity with the aboriginal inhabitants of Britain.

Victoria (Philosophical) Institute, Jan. 3.—Several new members were elected. The yearly statement showed the institute's sphere of action had been much extended of late. The Rev. R. Thornton, D.D., read a paper on "Scepticism," the concluding one of a series of four.

PARIS

Academy of Sciences, Dec. 20, 1875.—M. Frémy in the chair.—The following papers were read:—Theorems in which there are couples of segments having a constant relation, by M. Chasles.—Formula of the quantity of magnetism removed from a magnet by an iron contact, and of the portative force, by M. Jamin.—Critical remarks on the theories of formation of saccharoid matters in plants, and particularly in the beet, by M. Cl. Bernard.—Note on the order of Aug. 14, 1875, prohibiting the importation of fruit and other trees into Algeria, by M. Blanchard.—Expedition to Campbell Island; memoir on the chlorination of sea-water, by M. Bouquet de la Grye. The law enunciated by Gay Lussac and Humboldt for the saltiness of the Atlantic is also true for the Pacific. Having represented graphically the relation between dilatation, temperature, density, and chlorination, the author seeks to analyse some phenomena of equilibrium

of the sea.—Exposition of a new method for resolution of numerical equations of all degrees (second part), by M. Lalanne.—New researches on the interior magnetism of magnets, by MM. Trève and Durassier.—Researches on *Eucalyptus globulus*, by M. de Hartzen. The resin of *Eucalyptus* contains tannin and several fatty matters.—Action of mineral salts on the crystallisation of sugar, and determination of their coefficients, by M. Lagrange. Of the various salts contained in sugar, the chlorides are the least melassigenous; next come the sulphates and carbonates. The nitrates of potash and soda have the most prejudicial action to crystallisation.—Action of nitric acid on the phosphates and the arseniates of baryta and of lead, by M. Duvillier.—On the exchanges of ammonia between natural water and the atmosphere, by M. Schlœsing. With the same tension of ammonia in the air, the quantity of alkali dissolved in a natural water, up to equilibrium of tension, decreases rapidly as the temperature rises.—On the propagation of heat in rocks of schistous texture, by M. Jannettaz.—On aniline black; observations on a communication of M. Coquillion, by M. Rosenstiehl.—Note on the action of ozone on animal substances, by M. Boillot. Fifty grammes of beef enclosed in ozonised air were fresh and unaltered at the end of ten days.—On the myology of carnivora, by M. Alix.—On the pathology of deaf-mutism, improperly called congenital, by M. Tripiier. Only about a fifth of those said to be born deaf are so really. In the other four-fifths deafness comes suddenly about two or three years of age.—On a crystallised boride of manganese, and on the rôle of manganese in the metallurgy of iron, by MM. Troost and Hautefeuille.—On the oxyfluorides of niobium and of tantalum, by M. Joly.—Determination of alkaline metals in the silicates, and in matters unattainable by acids, by means of hydrate of baryta, by M. Terrell.—On a new mode of production of trichloroacetic acid, by M. Clermont.—On the classification and the synonymy of the stellarides, by M. Perrier. On T nerve-tubes, and their connection with the ganglionic cells, by M. Ranvier.—On the nerve-terminations in the electric plates of the torpedo, by M. Ranvier.—Remarks on a memoir of M. Tschermak, on the geology of meteorites, by M. Meunier.—M. Milne Edwards presented the first volume of "The Natural History of the Mammifers of Madagascar," by MM. Grandidier and Alph. Milne Edwards.

VIENNA

Imperial Academy of Sciences, Nov. 11, 1875.—MM. Toldt and Zuckerhandl communicated a paper on the changes of form and texture in the human liver during growth.

Nov. 18, 1875.—A paper was read by M. Liebermann, on the chlorophyll of the colouring matters of flowers and their relations to the colouring matter of blood. He thinks chlorophyll consists of two substances, chlorophyllic acid and phyllochromogen. The latter arises from chlorophyll through decomposition, and is probably what gives the various colouring matter of flowers by oxidation.

CONTENTS

	PAGE
LASLETT'S "TIMBER AND TIMBER TREES." By JOHN R. JACKSON . . . . .	181
RECENT FRENCH EXPERIMENTAL PHYSIOLOGY ( <i>With Illustrations</i> ) . . . . .	182
DAMMANN'S "RACE-PHOTOGRAPHS." By EDWARD B. TYLOR, F.R.S. . . . .	184
OUR BOOK SHELF:—	
Bax's "Eastern Seas" . . . . .	185
Markham's "Commodore Goodenough" . . . . .	185
LETTERS TO THE EDITOR:—	
Sir Thomas Millington and the Sexuality of Plants.—A. B. C. . . . .	185
Article "Birds" in the "Encyclopædia Britannica."—Prof. ALFRED NEWTON, F.R.S. . . . .	186
Fertilisation in the Basidiomycetes.—WORTHINGTON, G. SMITH . . . . .	186
The Late Eclipse.—RICHD. A. PROCTOR . . . . .	186
Blowpipe Analysis.—Major W. A. ROSS . . . . .	186
Meteor in the Daytime.—Rev. T. W. WEBB . . . . .	187
Protective Resemblance in the Sloths.—J. C. GALTON . . . . .	187
Coffee in Dominica.—EDMUND WATT . . . . .	187
The Law of Storms.—JOSEPH JOHN MURPHY . . . . .	187
The Glow-worm.—J. SNAW . . . . .	188
OUR ASTRONOMICAL COLUMN:—	
Encke's Comet . . . . .	188
Occultations of the Planet Saturn . . . . .	188
PROF. STOKES ON THE EARLY HISTORY OF SPECTRUM ANALYSIS . . . . .	188
SCIENCE IN THE ARGENTINE REPUBLIC . . . . .	189
SOME UNSOLVED PROBLEMS IN THE MANAGEMENT OF THE MARINE AQUARIUM. By A. W. WILLS . . . . .	189
THE NEW OBSERVATORY IN VIENNA ( <i>With Illustrations</i> ) . . . . .	198
THE ROYAL SOCIETY COMMITTEES . . . . .	193
THE FRENCH ACADEMY AWARD OF PRIZES . . . . .	195
NOTES . . . . .	196
SCIENTIFIC SERIALS . . . . .	198
SOCIETIES AND ACADEMIES . . . . .	198

THURSDAY, JANUARY 13, 1876

## OUR WATER SUPPLY

THE last Report of the Commissioners appointed to inquire into the Pollution of Rivers has excited a considerable amount of public attention, and the press, in addition to giving its own views on the matters reported on, has printed a considerable number of letters from private persons interested in the question. We have, of course, had the usual remarks about the conflicting statements of scientific witnesses, and a large quantity of ingenuity has been expended in attempts to prove that this conflicting evidence is an indication of the witnesses being so wedded to pet theories that they are unable or unwilling to see facts in their true light, and hence that the best way is to let matters take their course and trust that everything will come right in the end. To a very large portion of the world this conclusion is a most comfortable one to arrive at, as it spares the taxpayer and offers no offence to the dreaded "vested interest." On the other hand, there is a considerable section of the public which cannot hear that any part of our institutions is not absolutely perfect without being thrown into a state of nervousness and dread, a section well exemplified on the occasion of a former report by a paper which stated that—"We must face the dreadful fact that no amount of filtration can free our water from the nitrates and nitrites which are amongst the most deadly of poisons!"

No person of ordinary common sense can fail to perceive the folly of the alarmist school, but to the non-scientific public the fallacies of those whose cry is *stare super vias antiquas* are much more difficult to detect. Unfortunately the education through which most of the present generation have gone is not one which can enable them to arrive at any correct judgment as to the value of statements made by one scientific witness as compared with those made by another; the natural result of their education is in fact to cause them to attach a great value to the statements of a man who has a reputation for what is known as "popular science," and to regard the real worker or knower as an amiable enthusiast or eccentric theorist who is so carried away by his fancies that he is quite incompetent to pronounce upon practical matters. The same habit of mind induces them to value the statements of those whom they are pleased to call "practical men," who are generally men having an empiric or imperfect knowledge of certain processes. The result of this is that the opinion of one who has a mere smattering of chemistry, and therefore considers himself qualified to speak on all chemical questions, is pitted against that of one who has devoted his life to chemical and physical science, and the puzzled outsider sits down exclaiming, "Who is to decide when doctors disagree?" Again, this state of things is pretty well known to the people who are put on their trial by the allegations of those appointed to inquire into sanitary affairs, and they know well enough where to lay their hands on those who will make the best of a case entrusted to them; and we cannot help thinking that if it were possible to tabulate the names of the scientific witnesses called during the last ten years on the side of sanitary reform or on the side

of those who considered their interests endangered by it, some curious facts would be brought to light.

A letter from Sir Edmund Beckett, in the *Times* of January 10th, illustrates the state of the case remarkably well. The writer, speaking of letters by Mr. Denton and Lord Camperdown, says that if they had heard as much scientific evidence about water purity as he had, one would have been less puzzled and the other less alarmed; and he then goes on to say that—"They would then have known that the late Report is only what every person of experience in hearing such evidence could have predicted with certainty from the constitution of this commission." We may add to this, that any thoroughly competent commission of chemists working with a trustworthy process, could not have arrived at conclusions greatly different from those arrived at by the reporters. The writer then proceeds to say:—

"I have heard eminent scientific men assert on their oaths—and they always add that these things are 'not opinions, but facts'—that the water of a moderate-sized river receiving the unpurified sewage of half a million people was perfectly good, potable water for a town not many miles below the sewage-supplying places. That is a specimen of what we may call the impurist philosopher's view of water.

"On the other hand, there is a school which maintains, with equal positiveness, the theory that no length of run (within such distances as we are practically concerned with) purifies sewage by oxidation, but that a particle of sewage, or whatever other learned name they call it, sent into the Thames at Oxford arrives as a particle of sewage at Hampton, and may poison a man in London. It is true that they do not quite like the proposition reduced to those very bare terms, but they cannot deny, when they are pressed by a little cross-examination, that it is the logical consequence of their theory."

We very much regret that the names of the "eminent scientific men" who make the first assertion have not been given, as we should then have some means of ascertaining the value to be attached to their assertions. With regard to the latter statement we think that the writer to a great extent entirely misses the point. Very few scientific witnesses will maintain that Oxford sewage at present reaches Hampton as sewage; the question is, How long will the present state of affairs remain? With our rapidly-increasing population the volume of sewage yearly poured into a river at any one point must increase, as do the number of points at which sewage is poured in; and the questions really asked of the public are—How long do you suppose that this can go on before the river-bed is coated with sewer mud and becomes, as hundreds of streams which a few years back were clear and bright have become, an open sewer? And is it not better to take such measures as shall prevent such a state of things from coming about than to wait until the pollution becomes unbearable?

The writers of the report in question are perfectly well able to fight their own battles, so that we do not think it necessary to enter into any elaborate defence of their suggestions, but we must protest against their being treated as visionaries, and their statements being judged as of no more value than those of the "eminent scientific men" who say that a moderate-sized river can receive the sewage of half a million of people and yet be a "perfectly good, potable water not many miles below the sewage-supplying places."

We are in no danger of the theory of "*sanitas sanitatum omnia sanitas*" being pushed to excess by sanitary zealots ; and for the present, at any rate, the teaching of the Rivers Pollution Commissioners has been nothing more than "take care of the sewage, and the water supply will take care of itself."

#### LIEUT. CAMERON IN CENTRAL AFRICA

THE first detailed news of the latter half of Lieut. Cameron's trans-African expedition was read at the Geographical Society on Monday night, in the form of extracts from letters of the explorer, who intends to remain at Loando until he has a chance of finding a genial climate here. We do not yet possess details sufficient to authorise us in drawing final conclusions as to the results so far as the great problem of Central African drainage is concerned ; though we are quite justified in concluding that Lieut. Cameron has proved himself to be possessed of the qualifications of an explorer of the first rank, and that means ought to be found of making still further use of his valuable services. He has not been able to accomplish all he intended when he set out from Ujiji in March 1874, but he has certainly added very largely to our accurate knowledge of Central Africa. He was not able, owing to the hostility of the natives, and the want of pluck in his followers, to follow the course of the Lualaba in order to ascertain whether or not it joins the Congo. He has, however, obtained data which render it very improbable that the Lualaba and Tanganyika contribute to the Nile system ; the only known outlet of the lake, the Lukuga, he has ascertained, flows into the Lualaba. This latter river at Nyangwè is only 1,400 feet above the sea, or 500 feet below the Nile at Gondokoro, and lies in the centre of an enormously wide valley, "which receives the drainage of all this part of Africa, and is the continuation of the valleys of the Luapula and Lualaba." Cameron found that the river, contrary to Livingstone's report, really turns to the west below Nyangwè, and the Arabs report that further down it flows W.S.W. A river, the Lowa, said to be as large as the Lualaba, at Nyangwè, joins it from the northward a short way farther down, besides other important rivers from the same direction. Cameron failed to make his way to Sankorra, a lake into which the Lualaba falls, and to which "trowser-wearing traders are reported to come in large sailing-boats to buy palm-oil and dust (probably gold) packed in quills."

Lieut. Cameron traces with considerable minuteness the course of the Lualaba to some distance below Nyangwè. He shows that the true Lualaba in its upper course is the river to the west of Lake Bangweolo, crossed by the Pombeiros in their trading journeys to Cassembe's Town, and that Livingstone's Upper Lualaba is properly called the Luvwa. The river receives many tributaries during its course to Nyangwè, and passes through a number of lakes, so that by the time it reaches its final destination it must be a river surpassed in volume by few others.

All this seems to indicate that the Lualaba reaches the sea on the west coast, but that it does so by means of the Congo it would at present be unsafe absolutely to assert, though if it do not, what other Central West African river is of sufficient size to carry off the immense drainage which the Lualaba evidently represents ?

On account of the vexatious obstacles to his course along the Lualaba, Cameron turned southward, and during his journey south and then west to Benguela he made many valuable and accurate observations which will help greatly in filling up that portion of the map of Africa. Some distance south of Nyangwè he came upon a small lake Mohrya, fed by the rains, and apparently isolated from the rest of the water-system, but which is interesting as containing regular lake-villages. He is inclined to believe that the Albert Nyanza is much smaller than Sir Samuel Baker makes it, and he found that the Lomâmi has no connection with the Kassa bè, as shown in the map published by Keith Johnston. In the southward march Cameron passed the sources of the Lulua, which runs into the Zambesi, whose sources he places in 23° E. long. and 11° 15' S. lat.

Cameron gives the most glowing description of the productiveness of the country through which he has passed ; coal was found, gold, copper, iron, and silver are abundant, and he is confident that with a moderate expenditure of capital "one of the greatest systems of inland navigation in the world might be utilised." Multitudes of tropical products abound, and the region is well adapted for the cultivation of extra-tropical ones. A canal, he thinks, of twenty to thirty miles in length, would connect the Congo and Zambesi systems, and the resulting commercial advantages would be enormous. So the enthusiastic traveller believes, and whatever may be the results in this direction, the gains which have accrued to accurate geographical knowledge from his journey are such as must earn him the warmest thanks of the friends of science. He has taken 400 observations, "and consequently," as Sir Henry Rawlinson remarked, "has soundly established all the geographical landmarks of the country."

#### MORELL'S "EUCLID SIMPLIFIED"

*Euclid Simplified.* Compiled from the most important French works, approved by the University of Paris and the Minister of Public Instruction. By J. R. Morell, formerly H.M. Inspector of Schools. (London : Henry S. King and Co., 1875.)

EUCLID simplified ! "My friend M., with great painstaking, got me to think I understood the first proposition in Euclid, but he gave me over in despair at the second." Had Elia lived in these days of modern geometries perchance he had been a moderate geometer, but his wit might have been dulled. The book before us, however, is not the book we should recommend to a sucking geometer. We look upon it as one of those private ventures which we hope the Association for the Improvement of Geometrical Teaching will extinguish. There is hardly a page without its crop of faults. The title we consider to be a misnomer, for the method of Euclid (the geometer) is departed from altogether. We should look to find in a "Euclid Simplified" something far different from this. The treatise is based upon good geometrical authorities, as will be seen by a reference to the prefatory remarks ; it is to the form in which these authorities are presented that we object. Who is the interpreter ? A former "H.M. Inspector of Schools." We have been wont to look upon these gentlemen as masters of one or more tongues, and as having a fair acquaintance with the

"ologies." We have not formed a high opinion of the geometrical attainments of this compiler, nor do we consider him to be well versed in the French language, or even in elegant English composition. "Quis custodiet ipsos custodes?" It is "a work offered for the use of schools;" it is essential, then, that the writer should take all due precaution to be accurate. We think, further, that he should rather be disposed to retain terms with which boys are fairly acquainted, if they are correct, than to be constantly using terms and phrases which betray their Gallic descent. Thus pp. 23, 55: "angles are equal as opposed at the summit;" p. 40: "this corollary gives occasion to;" pp. 110, 112: "shows that to have point  $c$ ;" p. 141: "operating in the same measure" (? way); p. 166: "three points taken in equal number on the sides of a triangle and in unequal number on its sides produced;" p. 168: the centre of similitude is the meeting-place," &c.; we shall get to rendezvous in time. The words "passing by a point" (*par*) occur repeatedly; on p. 108 we have "by point  $D$  draw in like maner (*sic*);" pp. 41, 42, furnish "perpendicular to the centre," "perpendicular to the middle," and so on.\* It is hardly good English to say one point becomes confounded with another point, pp. 46, 97, 127; the boy-mind is apt to confound the different steps of the reasoning, and the boy often is tempted to exclaim, "Confound it altogether." "Cord" of a circle would not be difficult to make out by one who had read French mathematics, but at a "spelling-bee" we should prefer the candidate who spelled it "chord." But to return to the prefatory remarks. These have no signature, so we cannot be sure that it is Mr. Morell who writes "it is anticipated that it will prove more practically useful than most other school-books on the subject." We should expect, too, some recognition of the work accomplished by the association referred to above, the more so as Mr. Morell was at one time a member of the association. We should have been disposed to think that he has employed some one to make the compilation and translation, and has not carefully revised the work himself; but then against this we have the title-page. Were we to note and comment upon every passage we have marked, we should tire our readers. We shall content ourselves with culling a few elegant extracts. Many of the enunciations are loosely, if not always incorrectly, worded. Parallels are treated of in p. 21 before any definition of them has been given. On p. 24 we are told the term *transversal* is new to English schools: "it explains itself," and we are favoured with its derivation; in like manner, on p. 73 we are informed that *harmonics* have been "recently introduced in French geometry;" in the same note a specimen is given of "the new and interesting treatment of this question (*i.e.* harmonics) abroad;" on p. 72 we have a note on the word *capable*; "this term—used in French treatises—explains itself, if traced to its Latin root, *capax*, holding, a segment capable of an angle = a segment holding an angle." And on p. 104: "this circumference, by the well-known construction of the capable angle, will pass by point  $B$ ."

A parallelogram is defined to be a quadrilateral, of which the opposite sides are equal; in theorem xxxi. he

\* For pp. 11, 20, "two triangles are equal as having an equal angle," &c., we should prefer "because they have," &c.

subsequently proves this. The term *lozenge* is used in the text, and a note tells us that the figure is called "rhombus in the old-fashioned Euclid." A terrible mess is made of *circumference* on p. 36. "The circumference is a plane line, of which all the points are equally distant from one same point situated in the middle and named centre." This is not so bad as the common school-boy definition: "a circle is a plain figure bounded by one straight line, and is such that all straight lines drawn from a certain point in its centre to the circumference are equal;" but it is not what we should expect in a text-book for boys. Again, "a circumference is generally described in language by one of its radii." The italicised *the* is easily accounted for when we remember the source from whence the definition is taken; here, of course, it ought to be *a*, but on p. 51 we ought to have *the* for *a* ("A polygon is inscribed in a circle when its summits are situated on the circumference). Reciprocally (Mr. Morell's term for the usual conversely), *a* circle is said to be circumscribed round *a* polygon," that is, the circle and polygon previously mentioned, otherwise the definition is incomplete. No distinction is made of *major* and *minor* arcs. Thus, p. 39: "of two unequal arcs the greater is subtended by the greater chord;" this is, of course, only true of minor arcs. On p. 66 he bisects a given arc without having shown how to bisect a given line. On p. 70  $C, C'$  have been wrongly printed in three places. On p. 81 homologous is derived from *ὁμοίος* and *λόγος* (p. 9, isosceles from *ἴσος* is doubtless an oversight). On p. 85 occurs a passage we cannot understand; he has a quadrilateral  $ABCD$ , and then draws  $EF$  ( $E$  on  $AB, F$  on  $CD$ ) parallel to  $BC$ ; he says rightly the angles of the two figures are equal, but the sides not in the same proportion; then he proceeds to say "in like manner, without changing the four sides  $AB, BC, CD, (sic)$ , point  $B$  can be brought near or removed from  $D$ , without changing the angles." We cannot understand it, and so do not see it.

In the first note on p. 91, boys are informed that M. Charles is "Professor of Superior Geometry at the Collège de France, and one of the first geometers of the present age;" in the second, "homothetic" is derived from *ὁμοίος* and *θέσις*; in the third, "radiivectors or vectors are the straight lines drawn from the two foci of an ellipse to any one point of the circumference of an ellipse." On p. 122 we are told that the ratio of the equilateral triangle inscribed in a circle to the radius is  $\sqrt{3}$ , whereas it ought to be (as is proved in the text) the ratio of the side of the equilateral triangle, &c. On this page, and also elsewhere, we have  $R$  used for a right angle; this is, we think, likely to mislead boys: nor do we approve of the expression, "each of these angles will be worth  $\frac{2}{3} R$ ."  $R$  is usually employed to denote the radius of the circumscribing circle of a triangle. Pages 132, 133, bristle with blunders, due partly to the editor, but principally to the printer. On p. 134, for "pentagon" read "pentadecagon" (a purism for "quindecagon"). Page 136, on the calculation of the ratio of the circumference to the diameter, we read: "The complete solution of this problem belongs to superior mathematics. Therefore it is here less aimed at giving a method to calculate this ratio than to give a notion that it is possible to do so." This last sentence strikes us as not

being particularly elegant. On pp. 144, 145, in the proof of the important proposition that the ratio of any two rectangles  $R$  and  $R'$  is the same as that of the product of the height and base of the first, to the product of the height and base of the second, there are two, at any rate typographical, errors which would exceedingly trouble boys or the ordinary run of self-taught students. Also in a numerical example to this proposition the writer correctly gets  $\frac{R}{R'} = 4\frac{1}{2}$ , and then says the first rectangle is  $4\frac{1}{2}$  times greater than the second rectangle. On p. 148 the reasoning in theorem vi. is defective, and in the scholium there is a misprint; it is, however, not necessary to dwell fully on this Book V., which is especially faulty. We shall close our remarks on the text by quoting a sentence on p. 171, simply remarking that we could have extended our criticism to twice or thrice the dimensions of the present notice. The sentence is: "The further development of the Theory of Transversals is reserved for a special treatise on Modern Geometry, with a popular view of the recent improvements introduced by M. Chasles." May it be reserved to the Greek Calends! say we. Who and what is Mr. J. R. Morell, that he should venture to act as interpreter of M. Chasles' brilliant contributions to Geometry? Such a work brought out by a competent writer would be of great use. It was in 1871, that Mr. Morell published "The Essentials of Geometry, Plane and Solid, as taught in French and German Schools, with Shorter Demonstrations than in Euclid," &c. After the reception this little work met with one would have hoped that the author would have learnt wisdom, and before he sent forth another such work into the world would have submitted it to one or two candid and competent geometrical friends. The book might yet be made a very fair one, but as it is at present we must condemn it most strongly.

There is an appendix of 205 exercises, and we have marked upwards of forty as each containing something objectionable in language or in geometry. We must content ourselves with a selection:—30. Given a rectangle and a point situated in the interior of a quadrilateral; it should be "and a point within it" (or some such words; it is the billiard-table question which is given in many French text-books). 40. A triangle and any plane figure, in general movable in a plane, &c. 42. Which is the geometrical locus, &c. 103. A question of two concentric circles: in the great circle, in the little one. 116 is not neatly put; it is, "What is the geometrical locus of the centres of the circles which intersect orthogonally—that is, forming a right angle—two given circles?" 143, 193, he uses in the junction, where an ordinary geometer would write in terms of. In such wise and in (for "into") frequently occur. Before closing our article, we must point out that the work we have examined is not to be confounded with "The Elements of Geometry in Eight Books; or, First Step in Applied Logic," by L. J. V. Gerard, which forms a volume in Dr. J. D. Morell's Advanced Series for Colleges and Schools. This is the work of an able and judicious writer; we must at present content ourselves with merely commending it to the notice of any of our readers interested in the subject. A word of praise we can extend to the external aspect of "Euclid Simplified;" it has a neat and geometrical design on the cover.

### TISSANDIER'S PHOTOGRAPHY

*A History and Handbook of Photography.* Translated from the French of Gaston Tissandier. Edited by J. Thomson, F.R.G.S. (London: Sampson Low and Co., 1876.)

ALTHOUGH one may reasonably object to the statement made by an eminent French *savant* that "chemistry is a French science," there is no denying the fact that photography, so far as its early history is concerned, is eminently a French art. M. Tissandier, the author of the work now before us, of course does not fail to impress this fact repeatedly upon his readers by speaking of photography as the "art of Daguerre," and indeed throughout the book he places his own countrymen in positions which might in some cases be justly considered as somewhat too prominent. The addition of some few historical notes, however, by Mr. Thomson, the editor, renders the work, on the whole, as fair a history of the subject as we could wish to read.

Of the three parts into which the book is divided the first is entirely historical, commencing with a description of the camera obscura of Porta, and the discovery of "Luna Cornea" by Fabricius, and then proceeding to the early experiments of Prof. Charles, Wedgwood, Davy, and Watt. The connection of Daguerre with the first development of photography is of course known to all. The early life of Daguerre forms the subject of the second chapter, and the author here relates an incident which may be new to many of our readers.

It seems that in 1825 a poorly-dressed young man entered the shop of Charles Chevallier, which was at that time much frequented by amateurs, and demanded the price of one of the new cameras with converging meniscus lenses, which were then being made for the first time. The young man's manner showed that the price named was far above his means, and Chevallier then inquired for what purpose he required the camera. The stranger declared that he had succeeded in fixing the image of the camera on paper, but that the instrument he had employed was of rough construction, and he was anxious to continue his experiments with the improved apparatus. Chevallier being sceptical as to this statement, the young man placed on the counter before him a piece of paper, on which appeared a view of Paris, and on further questioning gave the optician a vial of blackish fluid, which he stated to be the liquid with which he operated. To continue, in the author's own words:—"The unknown explained to the optician how he should go to work; then he retired lamenting his hard fate, which would not permit him to possess that object of his dreams, a new camera! He promised to return, but disappeared for ever." It may be added that Chevallier could get no result with the liquid left with him. The incident was related to Daguerre, but the unknown inventor never appeared again, so that his name and fate remain a mystery. The succeeding chapters contain an account of the life and labours of Nicephore Niepce, and a history of the partnership entered into between this gentleman and M. Daguerre. Niepce's process, it will be remembered, depended upon the fact that "Bitumen of Judæa," when exposed to light, becomes insoluble in oil of lavender. Daguerre, continuing his researches under the



new act of partnership, at length discovered (accidentally, according to the present account) the action of light upon a film of silver iodide. "Photography was henceforth a fact"—unfortunately, however, at this time his partner died, and Daguerre was left to continue his work alone.

The history and progress of the new art of Daguerreotype is then traced, its purchase by the Government described, and the discovery of accelerating and fixing agents gone into. The editor at this stage reminds us that the use of sodium hyposulphite was first made known by Sir John Herschel, but Mr. Thomson erroneously terms this salt a "developing agent." We next arrive at that period of the history when the improvement in lenses effected by Chevallier enabled the time of exposure necessary for a Daguerreotype plate to be reduced, but even then the sitter had to remain motionless for four or five minutes in full sunshine! The torments of the unfortunate patient undergoing this ordeal are very graphically described. The name of Fox Talbot, who had succeeded in fixing the photographic image on paper

some years before Daguerre's discovery was made known, does not appear till rather late in this history,



FIG. 1.—Facsimile of a microscopic despatch used during the siege of Paris. and then in a position which we cannot but consider as too subordinate, to which effect the editor has added a note.

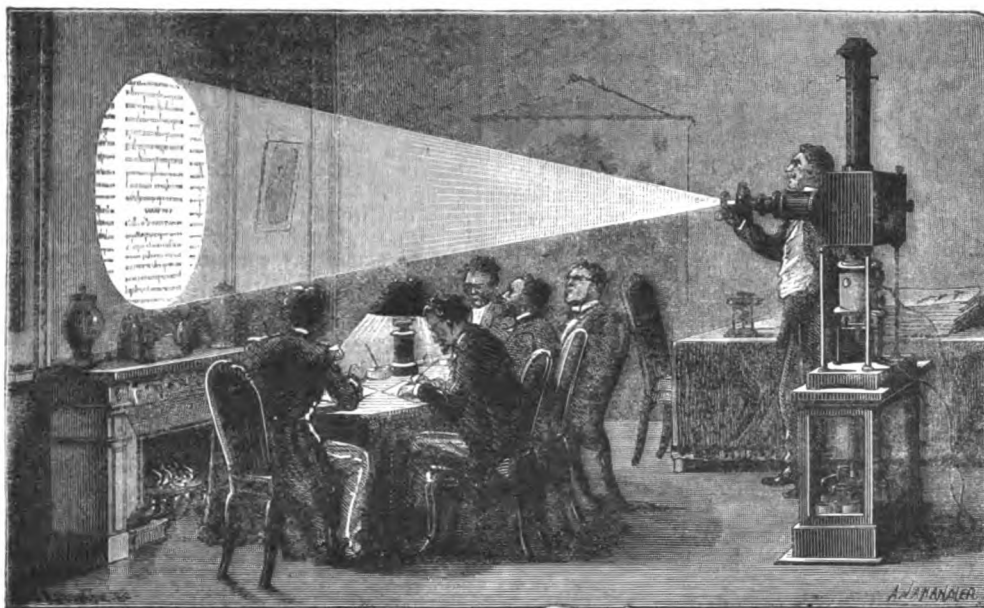

FIG. 2.—Enlarging microscopic despatches during the siege of Paris.

The next stage of photographic history brings us to the time of Niepce de Saint-Victor (nephew of the Niepce who was in partnership with Daguerre), who first discovered the albumen on glass process. The application of collodion to photography by Legray in France, and Scott Archer in England, brings the art down to its present state of development, and the author at this stage brings the historical portion of the subject to a conclusion.

In the second part of the work the operations and processes of photography are dealt with in seven chapters. The watchful vigilance which the editor has kept over the interests of British science has here for once failed. The whole credit of the bichromate of potash and gelatine process—the foundation of all the photographic permanent printing processes—is more than once in the course of the work assigned to Poitevin. "The various processes

or producing positive carbon prints," writes M. Tissandier on p. 162, "are based on the principle indicated by Alphonse Poitevin in 1855." We must remind our readers that a patent for the use of bichromate and gelatine in steel engraving was taken out in this country by Fox Talbot in 1852.

Of the carbon processes that of Swan is described by the author, and the editor adds a brief account of the most recent improvements in this branch of the art adopted by the Autotype company. The last chapter of this part relates to the problems yet awaiting solution, and is chiefly devoted to an account of the attempts which have been made to photograph in natural colours.

The third and last part of M. Tissandier's book treats of the applications of photography. In the first chapter we have a description of the various heliographic and

photo-lithographic processes which have from time to time been invented, including those of Donn , Fizeau, Niepce de Saint-Victor, Poitevin, Baldus, Garnier and Salmon, Albert, and Obernetter. The second chapter, under the title of "Photoglyphy," is devoted to a description of the Woodbury process, after which follow two chapters on photo-sculpture and photo-graphic enamels. Chapter V. treats of photo-micrography, and is illustrated by several excellent engravings of photographs of microscopic objects. The following chapter describes the application of photography to war. The method of sending microscopic despatches by carrier-pigeons adopted during the siege of Paris will be of interest to our readers. The despatch having been printed was reduced by photography on to a collodion film, which was then rolled up and enclosed in a quill, which was fastened to the tail of the pigeon. We here reproduce a facsimile of one of these microscopic despatches. To read the despatches sent in this way the collodion film was unrolled by immersion in weak ammonia water, dried, placed between two glass plates and a magnified image projected on to a screen by means of a photo-electric microscope (see Fig. 2).

Chapter VII. treats of astronomical photography, and touches upon the results achieved in this branch of the art by Warren De la Rue, Secchi, Rutherford, Grubb, &c. The author is not quite accurate when he states that for astronomical photography "it is indispensable to make use of a reflecting telescope having a speculum formed of glass silvered according to Foucault's process." The experiments of Rutherford show that lenses may be used with excellent results. Chapter VIII. describes photographic registering apparatus, barometric, thermometric, magnetic, electric, &c.; and Chapter IX. is devoted to stereoscopic photography.

Chapter X. treats of the applications of photography to art, while the last chapter discusses the future of photography. The author expresses a hope that among other developments which the art is destined to undergo, the time may come when it will be possible to photograph by telegraphic means.

The foregoing sketch of the book will be sufficient to enable our readers to form an estimate of its contents. The translation appears to have been carefully made, and the engravings, of which there are over seventy, are excellent. The frontispiece portrait, by B. J. Edwards and Co.'s photo-tint process, is a beautiful example of permanent photographic printing. In conclusion, we can heartily commend M. Tissandier's book as a popular *expos * of photography.

R. MELDOLA

#### OUR BOOK SHELF

*Morocco and the Moors: being an Account of Travels, with a General Description of the Country and its People.* By Arthur Leared, M.D. Oxon, F.R.C.P., &c. (London: Sampson Low and Co., 1876.)

MANY readers, we believe, know less about Morocco than they do about Lake Tanganyika, the Fiji Islands, or the Arctic regions. Not that there are no easily accessible works on the country; no one, we conceive, who might be anxious to "get up" Morocco would have much difficulty in collecting trustworthy authorities,

both in English and French. The modern general reader, however, has so much to do to keep up with a decent percentage of the literature of the day, that, unless for a special purpose, he is not likely to unshelve works of travel of a past generation; therefore, even for countries near at hand and whose names occur almost daily in Reuter's despatches, it is useful now and again to have the narrative of a recent visit. Morocco, though comparatively near us, yet in many respects is so isolated and so far behind the age, that a trustworthy account of its condition is welcome. Dr. Leared was only a few weeks in this country in the autumn of 1872. He landed at Tangier, visited the neighbourhood, sailed down the coast to Mogador, calling at one or two places on the way, and at a time of great internal disturbance visited the city of Morocco, where an attempt was made to poison him, happily without success. He managed to make a very good use of his time and his eyes and his introductions, and the reader will find many interesting observations on the people and the country. Dr. Leared has, however, not confined himself to his own observations, but has evidently diligently studied various authorities on the country, and taken trouble to acquire information from various quarters. The results he presents throughout the work as he goes along, and especially in a series of concluding chapters on the country and the people, government, law, education, superstitions, agriculture, natural history, &c. The appendix contains a variety of valuable material, including meteorological observations for Tangier and Mogador. Dr. Leared is strongly impressed with the value of Morocco as a resort for phthisical patients, the climate in some parts, he thinks, being in this respect superior to that of almost any other place. To anyone wishing to have a pretty full, and on the whole trustworthy account of the present condition of Morocco, we can honestly commend Dr. Leared's book, which, we should say, contains a small map and numerous illustrations.

*Tyrol and the Tyrolese: the People and the Land in their Social, Sporting, and Mountaineering Aspects.* By W. A. Baillie Grohman. With numerous illustrations. (London: Longmans, 1876.)

WHATEVER other qualities Mr. Grohman's book may possess, it is at least intensely interesting. The author is by birth half a Tyrolese, and he has spent several years in the country, evidently living frequently in all respects as a native, and thus having unusual opportunities of becoming thoroughly acquainted with the country and the people. What we have said in speaking of Dr. Leared's work on Morocco, might be applied with equal force to Tyrol, which, although the yearly resort of hundreds of tourists, is known to most only on the surface. Mr. Grohman's chapters give one a very satisfactory idea of the character and customs and general life of the people, and his sketches of the mountain scenery and of the habits of the chamois and black-cock are interesting, and in the latter case may furnish naturalists with a few additional facts. The people themselves are evidently made of splendid stuff, but at present rough and raw, and sorely in need of being polished. They are overridden with superstition, and in many of their customs, especially in the matter of social morality, have a strong resemblance to what the Scotch were generally a generation or two ago, and are still in some remote districts. The book is mostly occupied with Mr. Grohman's personal adventures, and one is sometimes inclined to suspect that these have been pieced together so as to tell effectively. This, however, simply adds to the interest, and does not detract from the value of the work. One of the most interesting chapters describes an ascent of the Gross Glockner in the dead of winter by the author and four guides. The illustrations are very beautiful, and the book, we should think, is likely to find many readers.

## LETTERS TO THE EDITOR

[The Editor does not hold himself responsible for opinions expressed by his correspondents. Neither can he undertake to return, or to correspond with the writers of, rejected manuscripts. No notice is taken of anonymous communications.]

## The Late Eclipse

AN answer to Mr. Proctor (vol. xiii. p. 186) is unnecessary to those who know all that has been written on the possibility of photographing the spectrum of the corona, but I take the liberty to give a few quotations out of the literature on the subject for the benefit of those who take an interest in the discussion, yet had no opportunity of following it in detail. Want of space prevents me from quoting all the letters in full, but I believe that I have not left out anything which might alter the sense of the quotations. The passages which seem to me to be important to the point at issue are printed in italics.

1. Letter to the Editor of the *Daily News*, signed Richard A. Proctor, January 26, 1875:—

"It is said that some enthusiastic students of science propose to try to get photographs, not of the corona as seen in a telescope, but of the exceedingly faint coronal image seen with a spectroscope. If they succeed they will have achieved a clever photographic feat, but the result, so far as the corona is concerned, can have little scientific value. *It is mathematically demonstrable that this is the case, for the quantity of light actually forming the coronal image can be shown to be far less in amount than is necessary for the formation of a satisfactory photograph.*"

2. Letter signed "A Fellow of the Royal Astronomical Society" (*English Mechanic*, May 21, p. 248):—

"But if Mr. Proctor should take upon him to answer the first of these questions in the affirmative, the second in the negative, then I could ask him *whether any body or any set of men possessing the slightest knowledge of the subject could or would have issued the preposterous instructions about photographing the spectra of bright lines in the corona, which emanated from the Royal Society?* The bright lines in the corona! Why, it has been recorded again and again by skilful observers that so faint is the light of the whole corona during the totality of a solar eclipse, that it casts no shadow whatever; and we know that the outer parts of the corona failed utterly to impress a collodion plate in five seconds, upon which a sharp and effective image of the partially eclipsed moon impressed itself in 0·1 second with a longer focussed telescope!"

(I should not have quoted in your columns any remarks of this anonymous writer had not Mr. Proctor's reference to them in the following letter rendered it necessary.)

3. Letter from Mr. Richard A. Proctor (*English Mechanic*, May 28, 1875, p. 272):—

"With respect to the eclipse observations last April, I have already said, as 'F.R.A.S.' does (let. 9,113, p. 248), that the failure of the Government expedition was rendered certain by the instructions of the Royal Society Committee. I pointed this out also before the expedition started. *I agree with 'F.R.A.S.' entirely in his interpretation of the matter.*"

Taking these letters in connection with what Mr. Proctor now writes, the following seems to be Mr. Proctor's opinion:—

It is mathematically demonstrable that "the quantity of light forming the coronal image is far less in amount than is necessary for the formation of a satisfactory photograph" (*Daily News*), yet "Dr. Schuster proves very readily that the spectrum of the corona can be photographed in one minute" (*NATURE*).

Mr. Proctor "is not aware that anyone has questioned the fact," but he "fully agrees with an anonymous writer that no set of men having the slightest knowledge of the subject could have issued the instructions which emanated from the Royal Society."

The failure of the Eclipse Expedition was rendered certain by the instructions of the Royal Society Committee to photograph in four minutes what Mr. Proctor admits to be capable of being photographed in one minute.

Anything which Mr. Proctor could have written on the subject besides what has been quoted, as, for instance, the passage in "Science Byeways," he alludes to in his letter, can only add to the hopeless confusion which must bewilder anyone trying to form a correct and fair estimate of his view on the matter.

Everybody will agree with Mr. Proctor that such a controversy is not likely to be of any service to science.

Upper Avenue Road, Jan. 1

ARTHUR SCHUSTER

## The Fossil Skeletons of Le Puy en Velay

AS there is to be a meeting of the Scientific Congress of France in Auvergne and Velay next summer, it may be useful to direct attention, through the columns of *NATURE*, to certain difficulties connected with the supposed antiquity of the fossil human bones preserved in the Museum of Le Puy.

With respect to the position of the bones, I visited the locality they were supposed to be found in last September, in company with some friends, and we were conducted, by the peasant who professes to have found them, to a well near the little auberge, where he now resides, and which is certainly a very different spot to that indicated by Mr. Poulett Scrope in his sketch at page 182 of the "Volcanos of Central France." The locality given by Mr. Scrope is much higher up the hill than is the well we were shown near the "Hermitage." Sir Charles Lyell also, according to the "Antiquity of Man," p. 229, was conducted to a spot "not far from the summit of the volcano." The well of the Hermitage is a long way from the summit of the hill.

It has long been observed that the rocky matrix in which the human bones have been enveloped is altogether different from the matrix of the rock where they are said to be found. This is certainly the case as regards the matrix of the rock in which the well is situated, which is a coarse volcanic breccia, while the bones lie in a volcanic sandy mass with a mixture of tuff and lime. I especially wish to direct attention to the position of one of the larger bones marked (I think) as an "iliac bone" in the Museum. The laminated mass between which it rests appears to me *stalagmitic*, as if these human remains had been washed into a fissure through which the water percolates downwards to the well of the Hermitage, and of which traces may be found higher up the hill.

I would also direct attention to certain stratified breccias near the western summit of the hill of Denise, which we thought looked more like the result of melting snow and the action of running water than of "volcanic alluviums," to which they have been generally attributed. These may be seen beyond the Croix de Paille on the road to Briowde high up on the flanks of the hill west of the volcanic outburst known as "The Chimney." The black and red scoriae shot out through this "chimney" cover the summit of the hill and overlie the stratified breccias. But these breccias are, if I read the geology of the district aright, the equivalents of those which, on the slopes of Denise, west of Polignac, have furnished the bones of the mammoth and tichorhine rhinoceros, and belong to glacial times.

The antiquity of the human skeletons must, I suggest, depend upon the correct determination of the spot where the bones were found. It is possible that they may belong to the age of the stratified breccias, and were washed into a crack or fissure during the Mammoth epoch, but they certainly do not look like it, if we may judge from the matrix in which they are enclosed. It is possible that they were enveloped in volcanic materials which were evolved during the last volcanic outburst, for I believe that at Le Puy en Velay and in the Ardèches there have been eruptions of scoriae and ashes through volcanic vents and chimneys since the glacial epoch, when deep snows covered the summit of Denise in the winter time and the mammoth pastured in the vales.

W. S. SYMONDS

## A Meteor in the Daytime

THE meteor referred to by the Rev. T. W. Webb was also seen at Dorking and at Southampton. The times given were "about 1.38 P.M." and "1h. 38m. 45s. P.M.," Dec. 22. Mr. H. J. Powell, writing to me from the former town, says: "Its course was from S.S.E. to N.N.W., and it shot down the sky so—

It had no well-defined outline like the moon, but was merely an irregular luminous ball. Its size as compared with the moon was about one-sixth. Its motion was not a very rapid one, but more like a cricket ball (after it has been thrown) falling. I did not hear any sound after its disappearance." Mr. Powell, writing to the *Times*, also mentioned that it "left a long trail of fire behind it," and that the nucleus "broke up and disappeared before it had reached the horizon."

In the *Times* of the same date (Dec. 23), "F. W." writes: "In the full blaze of the sun—a rare sight in itself nowadays—I observed a bright meteor traversing the sky from south-west to north-east, in form like a common rocket."

These accounts no doubt refer to the same meteor as that observed at Hardwick.  
 WILLIAM F. DENNING  
 Tyndale House, Ashley Down, Bristol, Jan. 8

**Blowpipe Analysis**

MAJOR ROSS (NATURE, vol. xiii. p. 186) does not appear to have thought of the impurities his soda might contain in his test for the presence of a sulphide. Had he done so he would probably have remembered that all soda (unless specially prepared from sodium) contains traces of iron. This iron, on fusing with the sulphide, forms ferrous sulphide, which, as is well known, is soluble in fused sodium sulphide; and on adding water to the fused mass a black residue of ferrous sulphide remains behind.

Again, he says "there can be no room to precipitate anything in a drop of water;" but surely this is erroneous. It is only a question of degree. Under the same circumstances a precipitate would be as certainly formed in a drop of water as in a gallon.

If Major Ross were to make allowances for the ordinary impurities of commercial reagents, a little more confidence might be placed in his tests.  
 T. S. HUMPIDGE

**Marine Aquaria**

WHILE reading Mr. Wills's very suggestive article on Marine Aquaria in your last issue, the following question suggested itself to me:—Does not the "larger proportion of carbonic acid in the lowest depths of the ocean" explain, at any rate partially, the formation of the "abyssal red clay," which Prof. Wyville Thomson has proved to occupy so large a portion of the bed of the Atlantic?

"Many of the insoluble carbonates, and in particular those of lime, magnesia, &c., may be dissolved to some extent by water, charged with carbonic acid, and are deposited in a crystalline form, as the gas slowly escapes from the fluid." (Miller's "Chemistry.")

That the presence of carbonic acid in the deep water is one cause of the decomposition of the shells of Mollusca, &c., I think that there can hardly be a doubt. Whether it is sufficient by itself to account for the whole phenomenon, I cannot presume to decide.  
 H. J. M'G.

Bournemouth, Jan. 10

**The Glow-worm in Scotland**

MR. J. SHAW'S interesting note on the Glow-worm leads me to remark that it is common about Loch Lomond, and recalls the pleasant surprise with which I met one there, shining brilliantly by the wayside, so late as twelve o'clock on a dark midsummer's night.  
 WM. McLAURIN

London, Jan. 10

**Bryant and May's Safety Matches**

THESE matches are highly electrical, and if they be rubbed against glass and ebonite they ignite, especially if the electrics be dry and warm. How far their ready ignition on amorphous phosphorus is due to chemism or to electricity remains to be proved. I am sorry I have not the opportunity just now to test this point.  
 W. H. PREECE

**OUR ASTRONOMICAL COLUMN**

THE MINOR PLANET, No. 153.—This planet, discovered by Palisa at Pola on Nov. 2, 1875, and which has been named *Hilda* by Prof. Oppöizer, is found to have a period of revolution considerably longer than any other member of the group. In No. 39 of Prof. Tietjen's "Berlin Circular" is an orbit calculated by Dr. Schmidt, which represents closely the observations to the end of the year. It is as follows:—

Epoch 1875, Nov. 22, at Berlin midnight.	
Mean anomaly ... ..	108° 30' 11"
Longitude of perihelion ... ..	284 41 50
Longitude of ascending node ... ..	228 20 43
Inclination to ecliptic ... ..	7 44 52
Angle of excentricity ... ..	8 33 3
Mean diurnal motion ... ..	452" 421

The major semi-axis is 3'9474, and if we calculate the

distance of the comet from the orbit of Jupiter at the aphelion passage, we find it 0'864, the earth's mean distance from the sun being taken for unity, which is a much closer approach to Jupiter's path than occurs with any other of the minors. Themis, for instance, the motion of which was investigated by Dr. Krueger, for determination of the mass of Jupiter, does not approach that planet within about 1'5. More than one of the small planets with the longer periods have large heliocentric latitude at the aphelion point, and do not on that account approach so near to the orbit of Jupiter as others with shorter periods and somewhat greater excentricities, and having the lines of nodes and apsides less divergent. Cybele in aphelion is 1'31 from the orbit of the great planet, Freia 1'24, and Camilla, according to the rather uncertain orbits yet available, 1'36. Hence, as suggested by Palisa, his planet Hilda is well situated for further investigation on the mass of Jupiter by the perturbations of the minor planets; it is well known, however, that this important element in the solar system is now reduced within narrow limits of uncertainty.

The above orbit of Hilda is confirmed by another computed by Herr Kühnert of Vienna from a similar extent of observations. The period of revolution is about 2,865 days, or approaching eight years, contrasting strikingly with the period of Flora, which is only 1,193 days, or a little over 3½ years.

SATELLITES OF URANUS.—The following positions of the brighter satellites of Uranus are derived as before from Newcomb's Tables in the Appendix to the Washington Observations for 1873; they are for 11h. 30m. P.M. Greenwich time:—

	TITANIA.		OBERON.	
	Angle.	Dist.	Angle.	Dist.
Jan. 15 ...	23° 2'	31' 1"	66° 5'	23' 8"
" 16 ...	3° 4'	34 6	34° 9'	35 0
" 17 ...	347° 7'	43° 1'	18° 5'	44° 0
" 18 ...	268° 7'	15° 8'	6° 1'	46° 1
" 19 ...	212° 5'	27° 2'	352° 6'	40° 5
" 20 ...	190° 1'	34° 6'	331° 2'	29° 5
" 21 ...	169° 1'	28° 9'	286° 7'	21° 1
" 22 ...	120° 1'	16° 5'	235° 4'	26° 5
" 23 ...	45° 4'	22° 4'	209° 7'	37° 9
" 24 ...	16° 9'	33° 4'	195° 0'	45° 3
" 25 ...	357° 5'	32° 1'	182° 7'	45° 3
" 26 ...	324° 2'	20° 2'	168° 0'	37° 8
" 27 ...	245° 2'	18° 0'	142° 2'	26° 5
" 28 ...	202° 6'	30° 5'	90° 8'	21° 1

THE GREAT COMETS OF 1874 AND 1680.—Now that the orbit of the fine comet of 1874 (Coggia, April 17), determined from the observations in the northern hemisphere to the middle of July, has been shown by the southern observations extending to October, to require but small corrections, we may examine with confidence the path of the comet about the passage of the descending node, when it approached near to the orbit of Venus.

Employing the elements calculated by Dr. Geelmuyden, of the Observatory, Christiania, we have the following results:—

Heliocentric Ecliptic Longitude.	Heliocentric South Latitude.	Distance of Comet from Orbit of Venus.
299° 45' ... ..	2° 17' 48"	0° 003655
299 48 ... ..	2 24 38	0° 003181
299 51 ... ..	2 31 29	0° 003323
300 0 ... ..	2 51 58	0° 006372

Therefore, assuming the solar parallax 8"875, with Clarke's semi-diameter of the earth's equator, the least distance of the comet from the orbit of Venus is found to have been 293,000 miles, or only about one-fourth greater than the distance of the moon from the earth.

A very celebrated comet, that of 1680, approached the earth's orbit within even less than this distance. From the definitive elements of Encke it would appear that in 92° 3'5 heliocentric longitude, just before traversing the plane of the ecliptic, towards the south, the comet's dis-

tañce from our track was 0'0031, or 286,000 miles, but the earth at the time was in another part of her orbit and far away from the comet, which indeed never approached our globe within 0'42 of the earth's mean distance from the sun. To have brought the two bodies into their closest possible proximity in 1680, it would have been necessary that the comet should have arrived at perihelion at midnight on the 18th of January, 1681, in which case they would have met on the night of December 22.

No comet is yet certainly known to have been situated nearer to the earth than 1,390,000 miles, which was the distance of Lexell's comet of 1770, on July 1, at 5 P.M. G.M.T.

### AN EXPLORING EXPEDITION TO THE INTERIOR OF SUMATRA

ONLY a short time ago the Geographical Society of Amsterdam took the first preliminary steps towards the realisation of a long-cherished idea,—the exploration of those parts of Sumatra which have hitherto been indicated by white patches on our maps of that island, even

though they form part of the colonial territory. These regions are bounded to the south by the residencies of Palembang and Bencoolen, to the east by the Straits of Banka and the Sea of Riouw, and to the west by the highlands of Padang and the chain of volcanic mountains which traverses the island in its whole length, running parallel to the coast. All the above-named districts are tolerably well known, the native kingdoms of Reteh, Indragiri, and Kwantan, situated farther north, perhaps excepted. It is this white patch, better known under the name of the Djambi territory, which the expedition will choose for the special object of its researches.

For more than one reason this and no other part of the interesting island has been chosen. In the north the war with Atchin is for the present an impediment to a peaceful party of explorers, although a better acquaintance with those tribes of the Malayan race known as the Battaks would be highly interesting from a linguistic and ethnological point of view. This having to be given up, the question of the navigability of the Djambi River, which might, moreover, prove of so much importance on commercial grounds, induced the Geo-

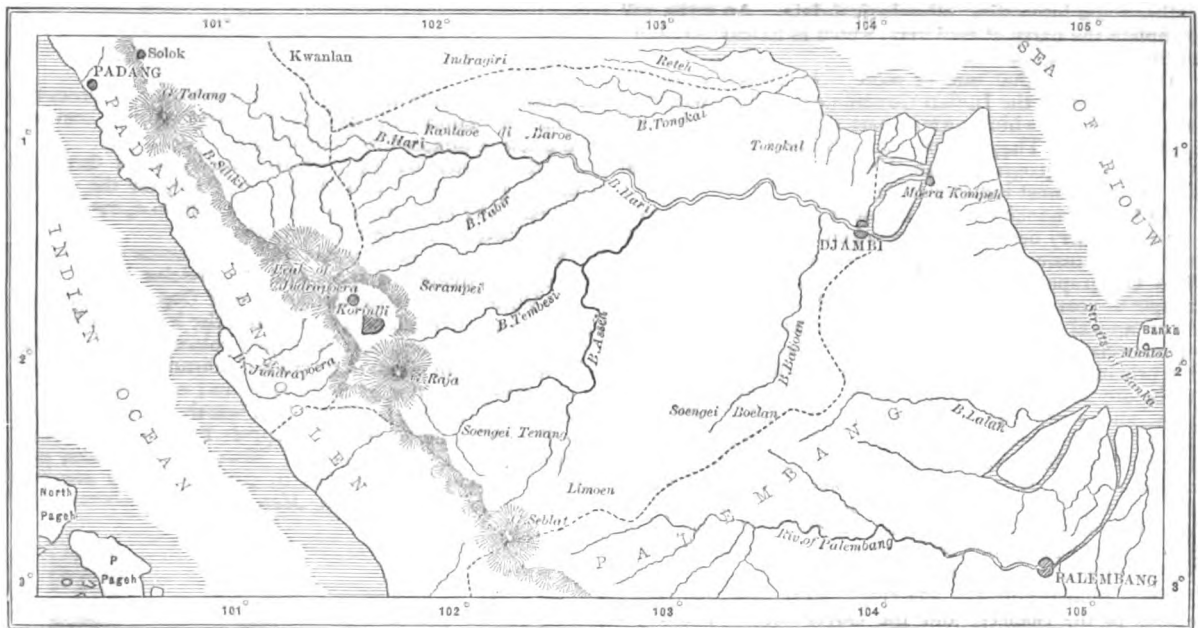

graphical Society definitely to fix its choice on the indicated parts, rather than on Indragiri, Reteh, or any of the above-named districts.

The only European who has ever visited the domains of the Sultan of Djambi, and has left any official documents about the state of things as he found them, was the Palembang resident van Ophuizen, who, in 1869, travelled a good way up the Djambi River, with the Government steamer *Boni*. Unfortunately, he was obliged to return sooner than he wished, for reasons dictated neither by the hostility of the population, nor by the barrenness of the country; on the contrary, he has reported very favourably on both these points. He had, moreover, occasion to notice the existence of several important tributary rivers, and as far as his survey extended he found the Djambi itself everywhere navigable. His reports to the Government at Batavia have formed a valuable basis upon which the Geographical Society has drawn up its projects for the present expedition.

The body of explorers will begin by separating into two parties, one of which will ascend the river in a steamer which it is expected Government will place at their disposal, the other party starting from Padang and passing the

mountain chain above-mentioned somewhere between the volcanoes of Talang and Indrapoora, will try to follow the course of one or more of the Djambi tributaries—more especially the Batang Hari—from its source up to the point where they will meet the steamer with the rest of the explorers, who will have in the meantime ascended the river as far as possible.

This junction having been effected, the next task will be the detailed survey of the different courses of the Sangit, the Teboo, the Tabir, and the Tembesi, the party all the while slowly advancing towards those mysterious valleys in the interior of Korintji, Assei, &c., which have afforded so much matter for speculation, and about the beauty and fertility of which most wonderful accounts have long been circulated. For the only reliable data we possess, we are indebted to natives who have travelled to the coast for commercial purposes, information which cannot but be very imperfect. Unacquainted with the disposition of the inhabitants towards European intruders, our travellers will have to feel their way, using the utmost circumspection not to rouse the distrust of the population, which would undoubtedly be the case if Government was directly associated with the expedition. The natives would not fail to

look upon this as a warlike demonstration, and their love of independence would then prevent the exploring party from accomplishing its task.

Not only from a geographical and ethnological point of view is this expedition expected to be a brilliant success, but also in the several departments of natural history the results are likely to be of high scientific value. A naturalist is to be appointed, who will accompany the explorers and enrich the zoological and geological departments of the national museum of Holland with interesting specimens from regions hitherto so superficially known.

There is some probability of a botanist being appointed by a committee of botanists and horticulturists, who will pay his expenses, and thus make the expedition profitable for this department of natural science as well.

The staff of the expedition will further consist of an able geographer, to whom the topographical department is to be confided, and of a linguist, who will study the languages of the tribes met with. It is a curious fact that in Sumatra the languages spoken by contiguous populations show very considerable differences. He will at the same time be able to serve as an interpreter, where this may prove necessary, and will no doubt have occasion to gather some interesting ethnological data. An artist will complete the party of explorers, which is to leave Holland in the beginning of next summer.

It is expected that one or more able naval officers will be appointed by the Indian Government to the command of the vessel in which a great part of the surveying work is to be done. They will of course bring a most welcome support to the geographer, to whom assistance of this kind may prove almost indispensable.

As to the financial side of the question, the expenses required to carry out the scheme when reduced to its most simple dimensions, have been evaluated at 2,000 guineas. The Geographical Society, having been founded only a couple of years ago, has no funds at all at its disposal, and so an appeal has been made to the public, scientific and commercial, with a view of obtaining the required money by private efforts only. Government will not be applied to before the subscriptions have surpassed the above sum, and when the possibility of realisation will thus have been assured. A Governmental subsidy will then not be a *conditio sine qua non* for the expedition, but only a means of giving it a wider extension, of bringing within its range a larger field than the original 2,000 guineas would admit of. As the national interest in the expedition is increasing every day, it is expected that this sum will be raised within a very short time.

The Colonial Office at the Hague strongly supports the efforts of the Society, and the Government at Batavia has promised its earnest co-operation. Another favourable circumstance is to be found in the willingness of the Sultan of Djambi, now on the best terms with the Dutch colonial authorities, first, to permit of this scientific invasion into his domains, and secondly, to lend his assistance wherever this might be of any use. As a palpable proof he has already put his son-in-law at the disposal of the exploring party, for the purpose of accompanying them on their tours. Policy seems to play a part in the unexpected magnanimity of this potentate.

Let us hope the best for the realisation of all those promising plans, and may I, ere long, have the opportunity of bringing under your notice some results of an expedition by which science in general cannot but profit.

A. A. W. HUBRECHT

FERTILISATION OF FLOWERS BY INSECTS\*

XII.—Further Observations on Alpine Flowers.

LAST year, after having spent my vacation in the observation of Alpine flowers and their fertilisation by insects, I published some articles in this journal, in

Continued from vol. xii. p. 191.

order to show that, in the Alpine region, Lepidoptera are far more frequent visitors of flowers than in the plain and in the lower mountainous region, while the frequency of Apidæ, not only absolutely but to a still greater extent relatively, greatly diminishes towards the snow line (see NATURE, vol. xi. pp. 32, 110, and 169). Further, in these articles I attempted to demonstrate that some Alpine species (*Daphne striata*, *Primula villosa*, *Rhinanthus alpinus*) are adapted to cross-fertilisation by butterflies, whilst the most nearly-allied species which inhabit the plain or lower mountain region (*Daphne Mezereum*, *Primula officinalis*, *Rhinanthus crista-galli*) are cross-

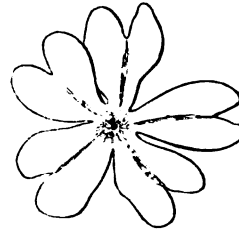

FIG. 71.

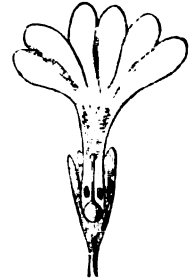

FIG. 72.

fertilised by bees; and that among the family of Orchids, by far the majority of species growing in Alpine regions are likewise adapted to Lepidoptera.

Last summer having revisited the Alps, in this and following articles I intend to show how far the results arrived at by my first excursion are confirmed, completed, or modified by my new observations.

Firstly, I will give some additional notes concerning the species treated of in my previous articles.

1. With regard to the fertilisation of *Daphne Mezereum* and *striata*, I concluded, solely from the length and width of the corolla-tubes, and from their colour and scent, that the former were adapted to cross-fertilisation by bees and some flies, the latter by Sphingidæ and moths; but direct observation of the fertilisers was wanting. Near spring, April 14th, in the valley of Poepfelsche, near Lippstadt, watching the flowers of *D. Mezereum* in calm and sunny weather, I succeeded in confirming my previous conclusions, so far as *D. Mezereum* is concerned, by

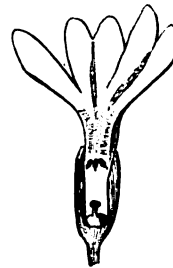

FIG. 73.



FIG. 74.

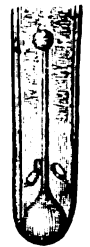

FIG. 75.

direct observation. Some humble-bees which escaped to my net, several specimens of the hive-bee, and single specimens of *Anthophora pilipes*, F., ♂, *Osmia fusca*, Chr., ♂, and *Osmia rufa*, L., ♂, were perseveringly occupied in inserting their proboscides into the base of the corolla, apparently sucking its honey, whilst many smaller bees (*Halictus linaricus*, F., ♀, *H. leucopus*, K., ♀, *H. nitidus*, Schenck, ♀, and *H. minutissimus*, K., ♀) were crawling with their whole bodies into the corollas, partly in order to suck the honey, partly collecting the pollen. Some Muscidæ also visited the flowers, touching stigma, anthers, and different other parts, with the flaps of their fleshy mouth, and sucking the honey. Besides these Apidæ and Diptera, only one butterfly



(*Vanessa Urtice*) was attracted by the bright colour of the flowers, and inserted its proboscis into several of them, possibly without touching stigma and anthers.

Of *Daphne striata* I had not yet the opportunity of observing the fertilisers; but completely white flowers of this species, which I found in the pass of Strela, near Davos, may be considered as confirming my supposition that *D. striata* is adapted to crepuscular and nocturnal Lepidoptera.

2. Regarding *Primula officinalis* and *villosa*, no additional remarks are to be made. I have, however, observed another Alpine species of *Primula* (*P. integrifolia*), which

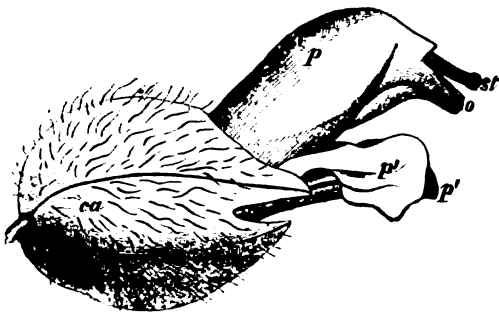

FIGS. 76-81. *Rhinanthus alectorolophus*.<sup>\*</sup> FIG. 76.—Lateral view of the flower.

is apparently adapted, like *P. villosa*, by the narrowness of the entrance of its corolla-tube, to butterflies. And with regard to some other species which inhabit higher Alpine localities (*P. longiflora*, and *P. minima*) I suppose that they are in the same condition, *Primula integrifolia*, which I found frequently on the summits surrounding the passes of Strela and Fluëla, is dimorphic, like most other species of this genus. Its sexual organs are quite included, the stigma of the long-styled and the anthers of the short-styled form occupying nearly the centre, the anthers of the long-styled and the stigma of the short-styled form occupying the lower part (1½ mm. above the ovary and 3 mm. above the ground) of the corolla-tubes. (Compare Figs. 72 and 73, 74 and 75.) Honey is secreted by the ovary in such quantity that it fills up the lowermost part of the corolla-tube so far as nearly to reach the stigma of the short-styled and the anthers of the long-styled form. The corolla-tube being 10-17 mm. long and about 2 mm. wide, its dimensions would allow

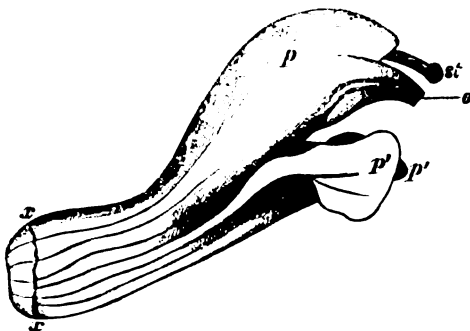

FIG. 77.—The corolla viewed laterally.

humble-bees also access to the honey; but the entrance to the corolla being contracted to 1 mm. (Fig. 71), no other insect but a lepidopterous one would be enabled

\* All the figures are 3½ times natural size. In all figures: *ca*, calyx; *p p*, upper petals, forming together the upper lip; *p' p'*, lower petals, forming the lower lip; *a'*, longer stamens; *a''*, shorter stamens; *n*, nectary; *ov*, ovary; *st*, stigma; *e*, usual entrance for the humble-bees; *o*, minute opening for the butterflies. The dotted line in Fig. 80 indicates the path of the proboscis of sucking humble-bees; the dotted line in Fig. 81 the path of the proboscis of butterflies.

to insert its proboscis into the base of the flower and reach the honey. On the other hand, the corolla is narrow enough to force also the thin proboscis of a butterfly to touch, when inserted, both the stigma and the anthers. I do not doubt, therefore, that *P. integrifolia* is also cross-fertilised by butterflies, although, from the unfavourable state of the weather, I have had no opportunity of observing its fertilisers.

3. *Rhinanthus alpinus* last year attracted my attention only during the last days of my stay in the Alps, when rainy weather prevented me from observing its fertilisers;

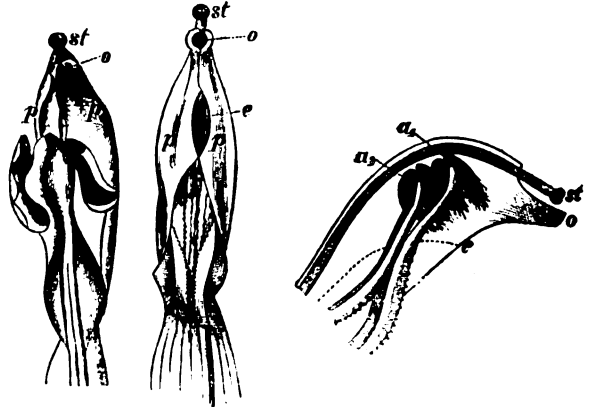

FIG. 78. FIG. 79. FIG. 80.

FIG. 78.—Front view of the upper part of the corolla. FIG. 79.—The same with the under lip removed. FIG. 80.—The upper part of the corolla, longitudinally dissected, but all four anthers reversed.

I concluded, solely from the structure of its flowers, that it was adapted to butterflies. This year it was an object of my continued attention; and in a region where Lepidoptera are predominant, but humble-bees are also very frequent, near Tschuggen (1,900 to 2,000 m. above the sea-level), Forno (1,800 m.), Valcava (1,500 m.), and St. Gertrud, Sulden (1,800 to 1,900 m.), I had large opportunities of directly observing its fertilisation by insects. But I was greatly struck by the fact that in these localities humble-bees visit its flowers far more frequently than butterflies. The number of visits which *Bombus alticola*, Kriechb. ♂, *mastrucatus*, Gerst., ♂ ♀, *terrestris*, L. ♂, *pratorum*, L. ♂, and *Proteus*, Gerst., ♂, in these localities make to the flowers of *Rh. alpinus*, is at least ten times greater than the number of visits by butterflies (*Argynnis*

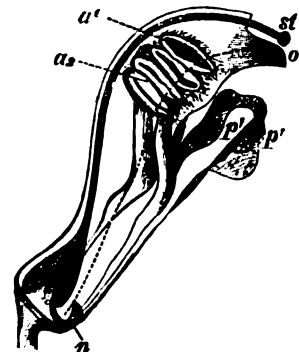

FIG. 81.—The whole corolla, dissected longitudinally.

*Aglais*, L., *A. ino*, Rott., *Lycaena alsus*, W. V., *L. semiargus*, Rott., *Larentia albulata*, W. V. (?), *Botys spec.*, *Psodos quadrisaria*, Sulz.), which, of course, solely search for honey. But the humble-bees treat the flowers in such a forcible manner, that by their very visits they prove that these flowers are by no means adapted to them. Alighting on the helm-shaped upper lip, the humble-bees are obliged to turn round in order to reach the face of the flower

then, the entrance between the margins of the upper lip being completely closed, they forcibly break it open with their fore-legs, grasping with them between the margins, and shaking the anthers in order to gain their pollen; thus a good deal of the smooth, powdery pollen grains, falling out of the shaken anthers, is received within the brushes and feathery hairs of their fore-legs, and thence carried to the pollen-collecting orifice of the posterior tibiae. This incommodious and wearisome labour, although performed by the humble-bees with admirable dexterity and perseverance, contrasts remarkably with the swift and light manner of their gathering pollen, and at the same time sucking honey in flowers adapted to them;\* and many peculiarities of the flowers of *Rh. alpinus* would be quite unintelligible under the supposition that pollen-collecting humble-bees were the true and original fertilisers of them. The honey, so copiously secreted in the base of these flowers, would be quite useless to the plant if pollen-collecting humble-bees were its true fertilisers; the minute opening between the two lateral flaps at the tip of the beaked prolongation of the upper lip would likewise be useless, and the closeness of the usual entrance between the margins of the upper lip would be a mere embarrassment to the fertilisers. Supposed, on the contrary, that Lepidoptera are the original fertilisers of *Rh. alpinus*, all these peculiarities are easily to be understood as very useful, nay, as indispensable to the plant; for honey is the only food eagerly searched for by butterflies, and the closeness of the usual entrance, as well as the existence of the minute opening in its very place, are required in order to induce visiting butterflies to insert their proboscis in the only manner which can effect cross-fertilisation. Hence, in spite of the frequent visits of pollen-collecting humble-bees, and in spite of their probably effecting many cross-fertilisations, the flowers of *Rh. alpinus* are without any doubt to be considered as adapted exclusively to butterflies.

But considering the original function of the under lip as a landing-place for bees, and considering that the most nearly-allied genera, *Euphrasia*, *Melampyrum*, *Pedicularis*, as well as *Rhinanthus crista-galli*, are all adapted to bees, we can hardly doubt that also the ancestors of *Rh. alpinus* have been adapted to cross-fertilisation by bees, and the question may be started, by what connecting forms these ancestors could be transformed into the present form of *Rh. alpinus*. We may confidently suppose that they retained the usual entrance for humble-bees, until the beaked prolongation of the upper lip, the minute opening at its tip, and the lateral flaps of this opening were so developed as to secure cross-fertilisation by butterflies.

In this respect *Rhinanthus alectorolophus* is of especial interest; for it represents really what by reflection we are induced to suppose once existed in the connecting forms between *Rh. alpinus* and its ancestors (compare Figs. 76-81). *Rh. alectorolophus* has indeed retained the usual entrance by which humble-bees may insert their proboscis in order to suck the honey (e, Figs. 79, 80), and may be regularly cross-fertilised by sucking humble-bees, whilst at the same time the minute opening (o, Figs. 76-81) and all those peculiarities which secure cross-fertilisation by sucking butterflies, are developed.

From the structure of its flowers, as shown by Figs. 78-81, we should expect that this species would be cross-fertilised as well by sucking humble-bees as by butterflies. My direct observation of the fertilisers, however, in the same localities with *Rh. alpinus*, shows no remarkable difference between *Rh. alectorolophus* and *Rh. alpinus*. Two species of butterflies—*Colias Phicomone* and *Pieris Napi*—repeatedly inserted their thin proboscis into the minute opening at the tip of the upper lip of *Rh. alectorolophus*, apparently sucking honey; numerous specimens

of *Bombus mastrucatus*, Gerst., ♂♀, *terrestris*, L. ♂, *Proctos*, Gerst., ♀, and *pratensis*, L. ♂, were occupied in collecting the pollen of *Rh. alectorolophus* in quite the same manner as in *Rh. alpinus*. Only twice I saw humble-bees (*B. mastrucatus*, Gerst., ♀) sucking the honey of *Rh. alectorolophus*, but not legitimately, by the entrance between the margins of the upper lip, but rapaciously; once by inserting their proboscis on the underside between calyx and corolla, and piercing the corollatube a little above its centre; another time by forcibly passing its proboscis through calyx and corolla.

Finally, it is to be noted that self-fertilisation of *Rh. alectorolophus* is apparently impossible, for the stigma always projects, just as in *Rh. major* and *alpinus*; and when the corolla drops off (in the line *xx*; Fig. 77), and brings its anthers in contact with the stigma, this is already withered.

HERMANN MÜLLER

### BEATS IN MUSIC\*

ONE of the subjects treated of in Helmholtz's great work on Acoustics is that of "Beats." It is one of much interest, both theoretically and practically: theoretically, because of the difficulty that attends the investigation of the phenomena, and of the discussions and misunderstandings that have taken place thereon among writers on scientific harmonics; practically, because beats might form an element of great utility in regard to certain practical operations, were it not that their nature and use are at present almost entirely unknown to practical musicians.

The history of the knowledge of beats is curious. They were mentioned as early as 1636 by Mersenne, and were afterwards noticed by Sauveur and others, but no sufficient explanation of their theory was given till the publication in 1749 of the learned work on Harmonics by the celebrated mathematician Dr. Robert Smith, Master of Trinity College, Cambridge. Dr. Young and Dr. Robison, both eminent writers on acoustics, quarrelled about Smith's work. Young said it added nothing to the knowledge of the subject, whereas Robison declared that it contained the greatest discoveries made since the days of Galileo; the fact, however, being probably that neither of them appreciated the main portions of the work at all. Chladni appears never to have studied the more difficult portion of the subject, and though he gives generally his references very freely, he does not mention Smith's name.

It was only in 1858 that Mr. De Morgan, in an able paper, published in the Cambridge Philosophical Transactions, pointed out the merit of Dr. Smith's investigation, and cleared up its learned obscurity.

Helmholtz treats the subject with his usual ability, but it is very singular that he, like Chladni, makes no allusion whatever to Smith's work, and as it is incredible that he should have passed over such a remarkable and profound theoretical investigation if he had been acquainted with it, I am inclined to believe that the book was unknown to him.

Considering the very few sources of information that exist in regard to beats, and the difficult shape in which this information is embodied, I have thought it might be useful, especially to practical musicians, to attempt to give some account of the subject in a more popular form; and in doing so I will endeavour to introduce the investigations of Smith, in combination with those of the later investigator.

There are three distinct kinds of beats, differing considerably from each other in the nature of their causes and in the circumstances that attend them, and the confusion between them has caused much error in their

\* Compare *Æsculus Hippocastanum* in "H. Müller, Die Befruchtung der Blumen durch Insecten," p. 155.

• By W. Pole, F.R.S., Mus. Doc. Oxon.

investigation. Hence a correct discrimination between them is very desirable.

The first and simplest kind of beat we will distinguish by the name of the *Union Beat*, it being produced by the concurrence of two sounds nearly, but not quite, in unison with each other. Let two organ-pipes, or any other sustained sounds, be tuned first exactly in unison; the combined effect will be equable and smooth, undistinguishable from a single sound. But now let one of the notes be put out of tune, at first very slightly; the result will be a peculiar effect of wavy pulsation or *beating*. The exact description varies according to the fancy of different hearers, but it is usually said to resemble an alternation of different vowel sounds, like *waw, waw, waw*, or *ya, ya, ya*. The beating, when the notes are but slightly out of tune, will be slow; if the error is made worse, the pulsations will increase in rapidity, till they become too quick to be counted.

This fact is very commonly known, and its experimental exhibition is exceedingly simple and easy. If organ-pipes and the means of tuning them cannot be had, the two sounds may be produced on any wind instrument, which can be easily put into the adjustment necessary. Or one of two unison reeds of a harmonium may be thrown out of tune by weighting it with a little bit of wax; indeed, in the drawing-room instruments one unison stop is usually made purposely out of tune with another, the composition giving a tremulous effect resembling the shaking of the voice, the stop being named "voix celeste" (in Italian organs a stop called the "vox humana" is formed of two pipes tuned in a similar way). These are real unison beats with so short a period as to produce the tremulous effect in question. Two unison tuning-forks may also be thrown out of tune by attaching wax to the arm of one of them, which will make it a little flatter.

The beats may also be well produced on a violin. Stop A with the fourth finger on the third string, and play it along with the second string open, when the adjustment of the former may be made with the greatest nicety, and if it be put out of tune the resulting beat will sometimes be so prominent as almost to shake the instrument under the chin. On a pianoforte the beats may also be observed when one wire of a note is a little sharp or flat of another, although this case is not so favourable for observation, from the sounds not being sustained.

Now, in seeking for the explanation of this phenomenon, a homely preliminary illustration will be useful. Suppose two coffin-makers live next door to each other, and suppose that on some particular day they both strike the blows on their nails at exactly the same rate, and begin exactly together; the effect on a passer-by will be that the sounds of the two will reach his ear simultaneously, smoothly, and regularly, and he will have difficulty in distinguishing the combined sound from what would be produced by one workman only. But now suppose that by some change in the fancy of one of the men, A, he begins to strike a little faster than his neighbour, making, we will say, eleven strokes to ten of the other, B. The effect on the passer-by will be changed, the sounds will reach his ear irregularly, and, which is the important thing, there will be regular periodical phases appreciable; for it is obvious that at every tenth blow of B, or every eleventh of A, the blows will coincide, after which they will diverge and become irregular till they coalesce again.

To apply this illustration to the case of the sounds, it must be borne in mind that a sound is transmitted to the ear by waves of the air, each of which consists of an alternate condensation and rarefaction. The coincidences of sound-waves give rise to peculiar effects of *interference* of various kinds, but it will suffice here to say that when two condensations coincide, the effect will be

different with the rarefaction of another. It will be easily seen that when the vibrations producing two sounds are a little unequal in time, as if, for example, one vibrates eleven times while the other is vibrating ten; there will be periodical coincidences corresponding to those of the blows just mentioned, and it is these periodical coincidences that produce the effect of what is called the *beat* on the ear.

Having thus established the nature of the beat, we may now go a little further, and see what we can find out about its time, or the length of the period which it involves, and this is a matter which requires careful attention.

We will go back to the illustration of the coffin-makers, and will now assume that the slower workman, B, makes 100 blows in a minute, whereas the quicker workman, A, makes 101. It will be evident that a coincidence will take place exactly at the end of every minute of time, so that, for these numbers, the periods of coincidence (corresponding to our beats) will be *one* per minute. Let now A increase his speed to 102 blows per minute, the other remaining the same; here there will be one coincidence every fiftieth blow of B, or every fifty-first of A, *i.e.* there will be two coincidences per minute.

It is easy to apply this to the sound-vibrations. Let one note make 100 double vibrations per second, and let the other note be sharpened to make 101. Here there will be one coincidence, or, what is the same thing, one beat per second. If the second note is sharpened a little more, so as to make 102 vibrations, there will be two coincidences, or two beats per second.

Hence the rule has been derived, that *the number of beats per second is equal to the difference of the number of vibrations per second of the two sounds.*

This is a simple rule, and it happens to be *practically* an accurate one; but hasty writers, who have deduced it from one or two simple examples, have omitted to see a curious *theoretical* difficulty that attends it. Let us go a step further, and suppose the higher note to make 103 vibrations per second, while the other makes 100: how many beats per second would this give? The rule says three, but if we examine very carefully the succession of sounds, we shall find there will *not* be three coincidences per second, there would be only *one*, and hence the rule will appear to fail. But if we try the experiment we shall hear that there *will* be three beats, and hence the theory and the fact do not correspond.

To explain the discrepancy, let us revert again to the illustration of the coffin-makers: supposing A to make 103, and B 100 strokes per minute, the interval between A's stroke is  $\frac{1}{103}$  of a minute, and between B's  $\frac{1}{100}$ . The 33rd stroke of B will take place after  $\frac{33}{100}$  of a minute, and the 34th of A after  $\frac{34}{103}$ , and as these fractions are not the same, it is clear that the blows will not coincide, neither will the 66th and 68th; in fact, there will be only one point in each minute when the blows will be heard exactly together.

Yet if the passer-by be asked to count with his watch how many coincidences per minute he hears, he will assuredly say *three*, and this discrepancy between theory and fact demands to be reconciled.

The explanation was cleverly hit upon by Dr. Young, who ("Experiments and Inquiries respecting Sound and Light," sec. xi.), treating of the subject, mentions "*coincidences, or near approaches to coincidences.*" He saw that, so far as the ear was practically concerned, a near approach would answer the purpose of an exact coincidence equally well; and this clears up all the difficulty. For although the 32nd and 34th blows do not come together with *theoretical exactness*, they come *practically* so nearly together that the difference between  $\frac{33}{100}$  and  $\frac{34}{103}$  is only  $\frac{1}{10300}$ , that is, the difference in time between the two blows is only  $\frac{1}{10300}$  of a minute, which no passer-by could appreciate, and he may therefore say they coincide.

Similarly, with the sounds. Although the 103 vibration-sound and the 100 vibration-sound only coincide with theoretical accuracy once in a second, yet there is, three times per second, a coincidence so nearly accurate (within  $\frac{1}{10300}$  of a second) that the practical effect in producing the beat is the same.

The rule, therefore, is practically right; but it should be qualified scientifically with the following addition:—*When the two vibration-numbers are prime to each other (i.e. when they are not both divisible by any whole number) the rule is not theoretically accurate, but if the times of vibration are very small (as they always are in practice) the error has no practical effect, and the rule consequently holds good.*

With the aid of this rule we can now tell the exact number of unison beats that will correspond to any amount by which the two notes are out of tune; and, *vice versa*, we can tell the exact quantity by which two notes intended for unisons are out of tune by simply counting the number of beats they give. For example, suppose the A open string on the violin is played along with the fourth finger note (first position) on the third string, and that the latter is a little sharp, so as to give four beats per second, we know that the upper note will have four vibrations per second more than the other; and as at this point of the scale about twenty vibrations go to a semitone, we can tell that the upper note is about one-fifth of a semitone sharper than the lower one. To effect this, the fourth finger must be moved about one-twelfth of an inch nearer the nut than the former position, and this can be measured if any player think it worth the trouble, as a check to the calculation.

We may next inquire what effect on the ear is produced by changes in the rapidity of the beats. At first, when they are slow, no very unpleasant sensation is perceived, but as they become faster they give a sensation of roughness which is disagreeable in a marked degree. With a further increase of rapidity the effect becomes again less unpleasant, until it arrives at the slight tremulousness already mentioned in the *voix celeste* and *vox humana* stops, and which, as it is purposely produced, may be supposed to be rather agreeable than otherwise.

If we carry the error farther, the beats become so fast that the ear ceases to be able to appreciate them, and the beating effect entirely disappears.

Helmholtz, who has paid much attention to this subject, and who has founded on this property of beats some important musical speculations, is of opinion that the disagreeable effect increases gradually until the beats arrive at about thirty per second, where the harshness is at a maximum; that then the unpleasantness lessens as they grow faster, until, at about 100, or something more, per second, the beating effect disappears. Hence he calls from 0 to this point *beating distance* for any two notes near each other.

For example, if starting from the treble C, 512 vibrations per second, we sharpen the note to D $\flat$ , 546 vibrations, and then sound this with the original C, we shall get  $546 - 512 = 34$  beats per second, which gives a very harsh effect. If we go on to D, 576 vibrations, we shall get, for the interval C to D,  $576 - 512 = 64$  beats per second, which is less harsh; and if we go on to C with E $\flat$ , we shall have  $614 - 512 = 102$  beats, which is hardly perceptible. For C to E, a major third, we have  $640 - 512 = 128$  beats, and no one can assert that this interval, when in tune, has anything harsh or disagreeable about it.

A curious question has existed as to what becomes of the beats when they thus vanish. Are they entirely annihilated? or do they in their more rapid shape produce any other sensible effect of any kind? To explain the answer that was, by early writers, given to this question, one must mention a new phenomenon which occurs in connection with double sounds, namely, what is called the

“grave harmonic.” When two notes are sounded together they give rise to a third tone, of a fainter strength, and generally lower than both. Examples of this are usually taken

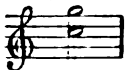
from concords: thus, if the following two notes 

are sounded on an organ, a violin, or any instrument of sustained sounds, and are perfectly in tune, the ear will, with attentive listening, hear a faint third sound resulting therefrom, which will be an octave below the lowest note

of the concord, thus . If, instead of the fifth,

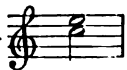
the major third  be sounded, in like manner

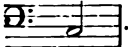
the “grave harmonic” will be an octave lower than before, namely, . This phenomenon was discovered

by Tartini, the eminent violinist, and is often on this account called the “Tartini harmonic.”

Now it happens that the number of vibrations of Tartini's harmonic, for any two given notes, is exactly the same as the number of the unison beats for the same notes, as hereinbefore described: and hence the idea arose that when the beats became so rapid as to lose their beating character, they gave rise to the grave harmonic; the explanation naturally presenting itself, that a beat recurring regularly with the proper rapidity would produce on the ear the effect of a musical sound. Dr. Young was the first to publish this explanation: he says (“Experiments and Inquiries respecting Sound and Light,” sec. xi.), “The greater the difference in the pitch of the two sounds, the more rapid the beats, till at last they communicate the idea of a continued sound, and this is the fundamental harmonic described by Tartini.”

Young's theory has been generally accepted until within the few last years, and in consequence the kind of beat we have been describing has been called “Tartini's beat.” Helmholtz has lately thrown doubt on the correctness of Young's explanation, but the analogy of the numbers may warrant us in retaining the name, as distinguishing this beat from others which we will now proceed to describe.

(To be continued.)

#### UNITED STATES NATIONAL ACADEMY OF SCIENCES.

THE half-yearly meeting of the National Academy of Sciences was held at Philadelphia, Nov. 2, 3, and 4, 1875. Prof. Joseph Henry has for several years been conducting the researches of the U.S. Lighthouse Board in respect to Fog Signals and the Transmission of Sound. While these experiments are not yet completed, the results up to the present time give the following indications:—The echo of sound passing over the ocean is more probably due to reflection from the surface of the waves than from the air; sound coming against the wind can certainly be heard at an elevation from a greater distance than at the sea level; with the velocity of the wind at about five miles an hour, sound was heard five times further with the wind than against it; sound is heard furthest with a moderate wind; with a strong wind it is not heard so far as in still air.

Prof. Joseph Le Conte, of California, contributed the results of his observations on mountain ranges of the Pacific coast. The author's theory is that the mountain chains in question were formed wholly by a yielding of the crust of the earth, along given lines, to horizontal pressure; not, however, resulting in a convex arch filled and sustained by liquid beneath, but by a mashing together of the whole crust, producing close folds and a swelling upwards of the squeezed mass. Prof. Le Conte went on foot through a cut made by the Central Pacific railroad from near St. Francisco Bay eastward, a distance of 30 miles through the Coast

range, which consists of two sub-ranges wholly of crumbled strata. The average angles of dip are from  $65^{\circ}$  to  $70^{\circ}$ . The following estimates are made:—The folded strata are of  $2\frac{1}{2}$  to 3 times the length of a horizontal line drawn beneath them; *i.e.* 15 to 18 miles of sea bottom have been crushed into 6 miles, the surplus swelling upward. Numerous flattened clay pellets, chiefly ellipsoids or disks, and similarly flattened nodules of sandstone, furnished means of estimating the horizontal and vertical pressures to which the mass has been subjected. The mathematical formula employed was detailed. It was found that  $2\frac{1}{2}$  to 3 parts had been crushed into one horizontally, and every foot of vertical thickness had been thereby swelled up  $2\frac{1}{2}$  or 3 feet.

Major J. W. Powell of Washington has spent many years in scientific exploration of the cañons of Colorado latterly under the auspices of the Smithsonian Institution. He regards the geology of the Colorado region as so different from any other, that a new system will have to be devised to meet it. Major Powell offered the outlines of a new system for the details of this region, proposing to retain as far as possible the names that mark the labours of previous explorers in the field; and to give in addition geographical names as a provision expedient till the full order of the strata should be determined. The plateau region drained by the Colorado River of the West was more particularly under review in the essay before the Academy. Springing from the plateaus are single mountains, short ranges, and volcanic cones disposed in groups; the affluents of the river have their source in high mountains on the edge of the drainage basin. The river and its chief tributaries differ from other great rivers in the absence of considerable valleys along their course, at least north of  $35^{\circ}$  latitude. The streams run in deep cañons, and these, with other topographic features, separate the plateaus. This is part of the whole region of the United States west of the 100th meridian, which is distinguished by being everywhere of great altitude, with the trifling exceptions of a strip on the Pacific coast and some valleys of the larger streams. The rivers descend so rapidly that they are of little service for navigation; the valleys are exceedingly narrow; the table-lands and mountains are treeless, arid, and almost desolate. Bare rocks rarely masked by any soil give character to the "Rocky Mountain" region. Here there is everywhere an open book to the geologist, as the formations can be clearly traced, and the sections given by cañons display in regular succession the strata of palæozoic, mesozoic, and Cainozoic eras, a total depth of 60,000 feet being thus revealed. The characteristics of the formations of this region were discussed at considerable length. As an instance of the irregularities of strata, the observations on lignite may be cited. It is frequently found through a horizon of 11,500 feet, in beds of varying thickness, distributed all the way from the lower Cretaceous up through three divisions of the Tertiary; but no particular bed of lignite is persistent over a large area. In one instance—the Rock Springs group—eleven beds of lignite were found, varying from 10 inches to 4 feet in thickness; but three miles away, careful observation showed all these beds represented by carbonaceous shales. In places separated by only a distance of a few miles, the succession of lignites is found to differ materially; they appear in general to have been formed in small irregular basins.

One of the most interesting papers read at the meeting was that of Prof. Raphael Pumpelly, of Newburgh, N.Y., on the Influence of Marine Life and Currents on the formation of Metalliferous Deposits. Beginning with the list of chemical elements which are found in the sea—now numbering 29 and likely to be largely increased—the author gave distinctive particulars as to the proportions of these substances, and the material in which they are found, whether sea-water, marine organisms, or structures that are products of marine life. All elements which compose the land are ultimately carried to the sea. The cycles through which different substances pass in their progress from land to sea, and thence again to the material of land, were traced in the cases of carbonic acid, lime, phosphoric acid, fluorine, and sulphur. As to the first of these, the sea is charged with nine per cent. of  $\text{CO}_2$ , the charge varying with the surface condition of the water and the immediate atmospheric conditions. The activity of the wave surface aids the escape of surplus carbonic acid into the air. Plant life in the sea as on land effects the decomposition of  $\text{CO}_2$ , using the carbon to build vegetable structure and freeing the oxygen to sustain marine vegetable life. But the carbon that is withdrawn to form coal, owing to its insoluble character, has been practically abstracted from this circulation. The ultimate result, the author thinks, would have been the decay of all life on the planet, for the want of the

carbon thus locked up. Hence the work of man in mining and burning coal restores the balance of this circulation, by bringing the carbon into a condition in which it can be dissolved by moisture and enter into plant life through the leaves.

In describing the cycle of lime, Mohr's theory was alluded to. Sulphate of lime, decomposed by plants, supplies sulphur towards forming albumen by combining with carbon and ammonia, the oxygen being set free; carbonate of lime may perform a simpler operation in the plant, leaving behind the carbon and lime while liberating oxygen. The hydro-carbons are afterwards oxidized in the respiration of animals that feed upon the plants, and secrete structures of limestone.

Phosphoric acid and fluorine have slight chemical affinity, yet they are continually found associated in mineral deposits. Phosphate of lime and fluoride of calcium offer nearly equal resistance to solution by atmospheric and aqueous agencies. The first is a constant constituent of marine plants; both are found in the lower marine animals, and by their means are presumably brought together again in rock formation. Land plants and animals take a frequent part in this circulation. Disintegrated rocks form soil-supporting vegetation afterwards eaten by animals, whose digestive processes bring the substances in question into the more soluble states, in which they are most readily carried to the ocean.

The sea contains much dead organic matter, and in decomposition the sulphur of the sulphates and of the albumen plays an important part. As to the sulphates, the direct process of their decomposition in decaying organisms may be stated thus:—The carbon of the organic substance takes the oxygen from sulphuric acid and its base, giving a sulphide of the base and free carbonic acid; water and carbonic acid decompose the sulphide again, giving sulphuretted hydrogen and a carbonate. Oxidation of the sulphuretted hydrogen gives sulphuric acid, which in time, uniting with lime, completes the circuit of sulphur. On land the processes are far more intricate. It is probable that in the circuit of sulphur in marine organisms it is to be found the key to their powers of eliminating from sea-water the heavier metals. The habitat of marine plants is determined by ocean currents, the growth and development being dependent upon freedom from such disturbance. Animal life follows vegetable. The accumulation of organic existence at certain localities in the ocean—as for instance the sargossa—determines there, in the process of its decay, the position of the material of rock formations, including the heavy metals which have been thus eliminated from their dispersion in sea-water. A thorough and minute chemical analysis of the earth brought up by the soundings of the *Challenger* and the *Tuscarora*, would be apt to throw light on some of the details of these problems.

The "Difference Engine," a calculating machine devised by Mr. George B. Grant, and now in course of construction for the University of Pennsylvania, was described by Prof. Fairman Rogers. The frame of the machine is 8 feet by 4 feet. To this frame are attached, though removable at will, 100 similar parts or elements, each of which is a small adding machine, representing a single decimal place during operation. When these elements are combined in groups, each group represents a certain difference of numbers, such as by consecutive additions to a starting number gives the required mathematical table or series. The difference thus added may be constant or variable. A table of squares is made by adding two differences, one constant, the other variable; cubes add three differences of which only one is constant. Logarithms are obtained similarly, though the operation is more complex. In this machine certain groups of elements are set to constant differences, and transfer their products in figures to other groups, which in turn transfer their variable values to groups above them. Babbage's machine was more costly, and Scheutz's more complicated than this; its chief advantages are: interchangeableness and ease of grouping of the elements, a constant introduced by simple apparatus in each element; an improved method by which the figure produced by any element is sent to the corresponding element in a higher group, and greatly improved arrangements for the operation of "carrying." The main figure-wheel of each element is moved forward by a carrier, which is released at the proper point by an inclined edge that takes it out of the way of the wheel. When a carriage is to be made, as for instance, if the wheel be at 8 and 3 be added, making 11, the next wheel standing at 0, which must be turned to 1, is so contrived that at the proper moment its inclined edge is slipped one tooth forward, and the carrier moves that wheel one step further than it otherwise would. This principle is so extended to successive carriages that if a long row

of nines is up, and unity be added on the wheel on the right, all the nines are at once replaced by zeros and one is added to the figure on their left. The machine presents a *click* of figures, the basis for a stereotype plate; it will calculate and print a table to ten decimal places at the rate of about forty turns per minute. A two-horse power engine will be required to drive it to its full capacity.

An arithmometer, or multiplying machine, devised by Mr. Grant, was also shown with, for comparison, those of Thomas de Colmar and Baldwin, it being adapted to the same purposes as those, but constructed on the principle of the difference engine.

Prof. R. E. Rogers gave some facts of interest respecting the silver mines known as the Comstock Lode. In the deeper drifts the temperature is much higher than can be explained by the usual hypothesis of interior heat; it frequently reaches 150° F. Water trickling from the roofs of these drifts is so hot as to be almost scalding; workmen have to be protected from it by iron screens. An application of ice-water to the head at intervals is found necessary to the support of life. The heat is due to chemical action, principally to the decomposition of sulphide of silver deposits which takes place when water containing chloride of sodium reaches them. There is some saline material in the ore. It is a singular fact that while there appears to be no trace of copper in the ore, the washing from the quicksilver mills, which runs into a pond and there evaporates, leaves a deposit which is only 300 fine instead of 700, all the rest being copper. To extract the silver, this deposit is put into a cap-like receptacle of felt, and hot quicksilver is turned upon it, which strains through, and carries with it the copper and gold, leaving the silver. The next process is to separate the gold from the copper in the drippings. To effect this the combined substance is heated to fusion and allowed to cool, when the two metals segregate, and the gold cracks off the copper. Before the discovery of this process the "tailings" of the mills had no value; now they prove of considerable worth.

Prof. J. Lawrence Smith has been studying a crystalline product obtained from the graphite of meteoric iron, that proves soluble in ether and crystallises in acicular form. Wöhler and Roscoe have announced the discovery of a similar substance in carbonaceous meteorites. Prof. Smith finds it in carbon nodules in the very centre of large masses of meteoric iron. Wöhler and Roscoe regard it as a hydro-carbon; Prof. Smith gives reasons for considering it a sulpho-hydro-carbon.

In another communication Prof. J. Lawrence Smith described a pendulum designed to meet the wants of a cheap and efficient compensating arrangement for common clocks. Prof. Smith has taken advantage of the great expansibility of vulcanite under changes of temperature. His experiments, in common with those of others, prove that its coefficient of expansion is about that of mercury, between 0° and 212°. In applying this simple form of compensating pendulum to clocks, he states that it need not add more than twenty or thirty cents to the cost of the pendulum ordinarily in use. He has constructed one with more perfect means of adjustment, yet very simple in character, which he thinks can be attached to regulators and astronomical clocks. Prof. Smith is now engaged in investigating any possible change in the materials used that may interfere with the permanency of this instrument; from the nature of the subject it will take some time to arrive at the necessary results. In these experiments he is assisted by a very competent associate.

The following were the papers presented at the session, in addition to those already mentioned:—Contributions to Meteorology, by Prof. Elias Loomis; Exposition of several peculiar Astronomical Phenomena, by Prof. Stephen Alexander; Confirmation of same author's Theory of the Zodiacal Light, by the same; Composition of Schorlomite, by Prof. George A. Koenig; Modern System of Chemical Terminology, by Prof. R. E. Rogers; Steam Geysers of California, by the same; the Annular Nebula in Lyra, by Prof. Edward S. Holden. Prof. C. E. Dutton's paper on certain Igneous Rocks of Southern Utah was read by title only.

### NOTES

PROF. HILDEBRAND HILDEBRANDSSON has published in the "Transactions" of the Royal Society of Sciences at Upsal, a clear and interesting account of a tornado which occurred near Hallsberg, in the province of Nerike, Sweden, on the 18th August, 1875. From the full details he gives it is evident that it

closely resembled the tornadoes which have been described by the American meteorologists and the well-known tornado of Chatenay of 18th June, 1839, described by Peltier. Upwards of 1,000 large trees (*Pinus abies*), covering a space 1,000 feet in length by 500 feet in breadth, were totally destroyed, the greater number being torn up by the roots, whilst those about the margins of the path of the tornado were snapped across. On emerging from the forest, where its course had been directed to N. N. E., it turned in the direction of N. E., uprooting trees, overturning solid buildings, and carrying the *débris* of the ruins, in some cases, many miles from the scene of destruction. From the positions of objects thrown down, which are shown on a map, Dr. Hildebrandsson points out that in this instance the destructive force was compounded of two forces, one being directed towards the centre of the tornado and the other in the line of its course. The true theory of these terrible phenomena can only be arrived at by such carefully observed and collated facts as Dr. Hildebrandsson here presents us with; and much light would be thrown on this difficult question if barometric and thermometric observations were made within and near the district swept by the tornado.

YESTERDAY'S *Standard* contains a letter from the *Challenger* correspondent of the paper, dated Valparaiso, Nov. 19. Honolulu was left on August 11 and a call made at Hilo (Hawaii), when the crater of Kilauea was visited. On the 19th the *Challenger* left and made for Tahiti, soundings and dredgings being carried on by the way, the average depth being 2,800 fathoms, with a bottom of red clay. Oxide of manganese was brought up in large quantities, and "many things of great interest to the naturalist." Several excursions were made on the Island of Tahiti, and every opportunity was made use of to get acquainted with the productions, soil, climate, and inhabitants. Sail was again made on Oct. 2, and Juan Fernandez reached on Nov. 13, the average depth of the section being 2,160 fathoms. Hiil and dale were tramped over by the naturalists and others during the two days' stay, and numerous specimens of birds and plants obtained. Valparaiso was reached on the 19th.

PART II. of the first volume of the new series of the "Transactions" of the Linnean Society, just published, contains a paper by Dr. J. D. Macdonald, on the external anatomy of *Tanus vittatrix*, occurring with *Limnoria* and *Chelura terobrans* in excavated pier-wood, and another by Dr. McIntosh, on *Valencinia armandi*, a new Nemertean. The first part contains Mr. Parker's memoir on the skull of the woodpeckers, one by the late Dr. R. v. Willemoes-Suhm on some Atlantic Crustacea from the *Challenger* Expedition, and one by Dr. Allman on the structure and systematic position of *Stephanosephus mirabilis*, the type of a new order of Hydrozoa.

SOME living specimens of the gigantic Tortoises of the Galapagos Islands, which were on their way to this country in H. M. S. *Repulse*, were lost, we regret to say, in a gale which did some damage to the ship and caused the death of two of the crew.

A NEW journal, *The Scientific Monthly*, devoted to the natural and kindred sciences, has been quite recently started at Toledo, Ohio, Mr. E. H. Fitch being the editor.

MESSRS. H. HOLT AND CO., New York, will publish during the month a work entitled "Life Histories of Animals, including Man," by Mr. A. S. Packard, jun. This work having appeared in parts in the *American Naturalist*, we can most certainly vouch for its excellence.

WE regret to have to announce the death of Mr. S. T. Davenport, well-known as an active and energetic officer of the Society of Arts. Mr. Davenport's connection with the Society had lasted for thirty-three years, and it was in great part to his unceasing and zealous efforts that the present prosperity of the



institution is due. All who take an active interest in the Society of Arts will feel his loss severely.

AN unfortunate difficulty at present prevents the Algerian Meteorological Service from sending telegrams daily to M. Leverrier for tabulation. It appears that the hour chosen at which to take the readings is seven in the morning instead of eight, the hour that has been adopted by all European nations. M. Leverrier could not by any means make use of the Algerian data in his daily weather maps. It is to be hoped that Algerian meteorologists will see the necessity of conforming to the rule universally adopted in European observatories. But some resistance is expected from those who have adopted the unusual hour for taking observations, as they contend that the readings taken then give a closer approximation to the mean state of weather. This assumption is hardly justifiable by facts: at any rate it cannot be considered as an objection to the taking of a reading at eight o'clock, and sending it by telegram to Europe.

AT Christ Church, Oxford, there will be an election on Saturday, March 11, to at least two junior studentships in Physical Science, of the annual value of either 100*l.* or 85*l.*, tenable for five years.

THE *Geographical Magazine* announces the discovery of a voluminous journal kept by Father Desideri, who resided and travelled in Thibet in the early part of last century.

THE Dutch Government have adopted a plan for draining the Zuyder Zee at an expense of nearly 10,000,000*l.* The area to be drained is estimated at 759 square miles.

THE Bureau of Agriculture of the United States Centennial Commission (not the United States Agricultural Department) has lately issued a circular, which announces that it is proposed to have an exhibition of living fish of many varieties, for which purpose plans have been prepared for the erection of twenty-five tanks of approved construction, ranging from two to twenty feet in length and from one to six feet in depth, the whole containing about six thousand cubic feet of water. The cost of these aquaria is estimated at \$6,000. The Bureau of Agriculture desire to render this enterprise in a measure self-supporting, and the circular invites those interested in the subject to purchase one or more ten-dollar shares of the Centennial stock, with the understanding that the proceeds, although going into the general fund, are to be considered as contributed to the fish exhibition.

MR. G. S. BOULGER, F.G.S., has been appointed Professor of Natural History in the Agricultural College, Cirencester.

THE North-German *Allgemeine Zeitung* of Jan. 7 publishes a long article on the Hamburg Naval Observatory. It appears that this establishment commences operations to-day, and professes to include the several branches of scientific seamanship. The establishment is said to have been fitted up according to the most improved method, regardless of cost.

TWO Parisian daily papers, the *Bien Public* and the *Opinion Nationale*, publish daily the weather maps designed by M. Leverrier for the international meteorological service.

THE list of the members of the French Bureau des Longitudes has been published. Besides the ordinary members appointed either by the Bureau or by the Academy of Sciences, the War Office, and the Marine Department, a number of correspondents have been appointed, including M. Stephan at Marseilles, M. Tisserand at Toulouse, M. Marie Davy at Montsouris (Paris), Admiral La Ronciere le Nourry, &c.

THE meteorological *Annuaire* of the Montsouris Physical Observatory has been published by M. Marie Davy. Excellent woodcuts show the details of the several anemometers and magnetometers used by the institution. The results of all the read-

ings taken in the preceding year have been carefully tabulated. The maximum registered velocity of the wind was 80 kilometres an hour, and the maximum pressure 47 kilogrammes per square metre.

M. LEVERRIER may come to London in order to be present at the distribution of medals by the Royal Astronomical Society. The printing of his tables for Saturn is progressing favourably. The verifications made have been satisfactory.

A VERY useful and complete summary of the geographical progress of 1875 will be found in *The Colonies* for January 8. The same well-conducted paper has commenced a series of "Ethnographical sketches of the various aboriginal or indigenous races inhabiting countries and islands that are becoming daily more known to us through the rapid development of trade and commerce," but whose inhabitants are disappearing or being greatly changed. The first sketch, under the head of Pacific Islands, is of the Hawaiians or Sandwich Islanders.

THE Italian Minister of Public Instruction has made a grant of 1,000*l.* for the scientific expedition to Central Africa (see *NATURE*, vol. xiii. p. 155).

A PITHY article in the *Hastings and St. Leonard's News* of the 7th inst. calls attention to the scientific destitution of that favourite watering-place. There seems at one time to have been an apology for a museum, but its dusty contents have long ago been scattered. So far as we know, Hastings has not even a local scientific society or field-club, although the district around, including the sea and its shore, would furnish a fertile field for such an association. Indeed, with the exception of a science and art class, Hastings seems to be quite destitute of any means of fostering a love of science or of scientific pursuits and recreations among its people. Surely there are a few men in the town who know the value of science; at all events, we hope the forcible remarks in the *News* will have the effect of rousing the people to bring their town abreast of its neighbours in the matter both of a well-furnished museum and a scientific society and field-club.

WE take the following from the *Geographical Magazine*:— Announcement was made at a recent meeting of the Society for the Encouragement of Commerce and Industry, in St. Petersburg, that a person who does not wish his name to be known has offered a sum of 25,000 rubles (3,125*l.*) towards a scientific expedition to explore a commercial route from Northern Russia to Behring's Straits. Prof. Nordenskiöld has agreed to accept the leadership of the expedition, which will start next summer. Subscriptions to the amount of 26,000 rubles (3,250*l.*) have also been received towards the cost of another expedition composed of two vessels, which shall last three years, and shall explore the Gulf of Obi as well as the sea-route between Archangel and the great rivers of Siberia. The command of this one will be entrusted to Capt. Wiggins, of Sunderland, who has, however, stipulated for full liberty of action in unforeseen circumstances, and who has remained in St. Petersburg, waiting for the replies of the Mayors of Irkutsk, Krasnoyarsk, Tobolsk, Tiumen, Tomsk, and Ekaterinburg, who have been invited by telegraph to co-operate in forwarding the enterprise. A reply has since been received from a proprietor of gold mines at Krasnoyarsk contributing 500*l.* to the expenses of the undertaking.

"FROM Vineyard to Decanter" (Stanford), the second edition of which has come to hand, is "a book about sherry." We would recommend it to all of our readers who love "a good glass" of that favourite British beverage. It gives a clear account of the processes through which the wine goes in all its stages, and the conclusion of the whole matter seems to be that if you wish to drink good sherry you must make up your mind to pay a good price for it.

THE *Revue Scientifique* announces the death of the naturalist M. Pictet.

THE *Cologne Gazette* states that Herr Heuglin, the African traveller, has declined the offer of the Khedive to take the command of the troops sent to Abyssinia, in place of the late Munzinger Pasha, but is organising an Abyssinian exploration for scientific purposes.

DR. VON RICHTHOFEN, the well-known traveller and geographer, has been appointed Professor of Geography at the University of Bonn. He is still occupied at Berlin with the editing of his great work on China.

THE additions to the Zoological Society's Gardens during the past week include a Le Vaillant's Cynictis (*Cynictis penicillata*) from South Africa, presented by the Viscount Maudeville; a Hooper Swan (*Cygnus ferus*), European, presented by Mr. Montague Kingsford; a Weeper Capuchin (*Cebus capucinus*) from Brazil, presented by Mr. August Kettner; a Macaque Monkey (*Macacus cynomolgus*) from India, presented by Mr. T. J. Dunn; two Darwin's Pucras (*Pucrasia Darwini*) from China, purchased.

### SCIENTIFIC SERIALS

*Zeitschrift der Oesterröichischen Gesellschaft für Meteorologie*, Nov. 15, 1875.—Dr. Billwiler, of Zürich, contributes an article on a local occurrence of the northerly "Föhn." It was formerly believed that the Föhn came from the Sabara Desert, whence it derived its warmth and dryness, but Hann showed a few years ago that, according to known physical laws, descending air becomes warmer and drier, that winds of the Föhn kind are not confined to the Alps but occur in other mountainous regions, and that the southern slopes of the Alps have a north wind, which is the exact counterpart of that called the Föhn. A mass of observations made in Switzerland have since proved the correctness of his theory. Herr Billwiler, from the data he has as yet examined, finds that isolated Föhn winds prevail only when a broad current flows over the whole Alps in the same direction, ascending on one side and descending on the other. But there are cases in which no perceptible upward movement can be traced on one side, and yet on the other the Föhn descends into the valleys from above. A difference of density, often great, is the cause of this. The lower strata being obstructed the outflow of air necessary to restore equilibrium comes from above. The merely local Föhn blows strongly down a valley, but on reaching the colder air of the plain mixes with it and quickly comes to rest. Tables are given showing meteorological conditions in particular cases.—The next article, written by Dr. Wild, and quoted here from the Annual Report of the Imperial Observatory at St. Petersburg, is a review of the work of the Meteorological Congresses of 1873 and 1874. Perhaps the most important result of these congresses will be the general use of more trustworthy instruments by official and private observers. The following advantages have already been gained: an international system of ciphers for telegraphic despatches throughout nearly the whole of Europe; an international form of publication in the following countries: Norway, Sweden, Denmark, Russia, Austria, Switzerland, Italy, and part of Germany; and lastly, the establishment in many States of central institutions. We shall thus obtain better, more uniform, and more accessible data as a consequence of the late congresses.

### SOCIETIES AND ACADEMIES

#### LONDON

Royal Society, Jan. 6.—On the refraction of sound by the atmosphere, by Prof. Osborne Reynolds, Owens College, Manchester. Communicated by Prof. Stokes, Sec. R.S.

This paper may be said to consist of two divisions. The first contains an account of some experiments and observations undertaken with a view to ascertain how far the refraction of sound caused by the upward variation of temperature may be the cause of the difference in the distances to which sounds of the same intensity may be heard at different times.

Some rockets, capable of rising 1,000 feet, and then exploding a cartridge containing 12 oz. of powder, having been procured,

an effort was made to compare the distance at which the rockets could be heard with that at which a gun, firing  $\frac{1}{2}$  lb. of powder and making a louder report than the rockets, could be heard under the same conditions of the atmosphere. In the first instance the rockets and the gun were fired from a spot in Suffolk, around which the country is tolerably flat, observers being stationed at different distances. Owing, however, to the effect of the wind and the time required for the observers to proceed to the distant stations, these experiments were not successful in establishing the comparative merits of the gun and the rockets. They were, however, important as showing that on hot calm days in July the reports of the rockets never failed to be distinctly audible at distances of four and five miles, although the sun at the time was shining with full force on the ground, and rendering the air near the surface so heterogeneous that distant objects seen through it appeared to wave about and twinkle.

The next attempt was made during a cruise on the east coast. After three weeks cold and windy weather, the 19th of August was a fine day, and some experiments were made in Lynn Deep, which revealed a very extraordinary state of the atmosphere as regards the transmission of sound. A party rowed away from the yacht in one of her boats, it having been arranged beforehand that either a rocket or a large pistol was to be fired from the yacht when signalled for; also that when those on the yacht heard those in the boat call they should answer. The boat proceeded to a distance of five miles, until those on the yacht had completely lost sight of it; but all the time the calls from the boat were distinctly heard by those on the yacht, although after they had lost sight of the boat they ceased to answer the calls. On the boat also not only were the reports of the pistol and rockets distinctly heard, but every answer from the yacht was heard plainly. The last came after an interval of thirty-five seconds, which gave the distance  $3\frac{1}{2}$  miles. Nor was this all; but guns, and on one occasion the barking of a dog, on the shore eight miles distant, were distinctly heard, as were also the paddles of a steamer fifteen miles distant.

The day was perfectly calm, there was no wind, the sky was quite clear, and the sun shining with great power—conditions which have been described as most favourable to the stoppage of the sound by the heterogeneity of the atmosphere, and which may also be described as most favourable for great upward refraction. On this day, however, it was observed that all the time distant objects loomed considerably, *i.e.*, appeared lifted. This showed that the air was colder near the surface of the sea than it was above. It is to this circumstance that the extraordinary distances to which sounds were heard on this day is supposed to be due. The diminution in the temperature of the air being downwards, the sound, instead of being lifted as it usually is, was brought down, and thus intensified at the surface of the water, which, being perfectly smooth, was thus converted into a sort of whispering-gallery.

The report of the pistol and the sounds of the voice were attended with echoes, but not so the reports of the rockets; and it is suggested that these so-called echoes may be found only to attend sounds having a greater intensity in one direction than in another.

The second part of the paper refers to a phenomenon noticed by Arago in his report of the celebrated experiments on the velocity of sound made on the nights of the 21st and 22nd of June, 1822.

It was then found that, although the guns fired at Montlhery could be distinctly heard at Villejuif (eleven miles distant), those fired at Villejuif could not be heard at Montlhery without great attention, and at times (particularly on the second night) they were not heard at all; although on both nights the wind was blowing from Villejuif to Montlhery, the speed of the wind, which was very light, being about 1 foot per second. No explanation of this phenomenon was offered by the observers, although it was much commented on. And on the second night the gun at Villejuif, which on the previous night had been pointed upward, was brought down in the hope that this might improve its audibility (this step was, however, found to render matters worse than before).

From this lowering of the gun at Villejuif it seemed as though there was probably some difference in the conditions under which the guns at the two stations were placed, as if that at Villejuif was fired from a level, while that at Montlhery might be fired over a parapet. An inspection of the district confirmed this view; for Villejuif is on a low, flat hill, while Montlhery is on the top of a steep cone; and not only is it 80 feet above Villejuif, but it is surmounted by the mound of an old castle, which

is supported by a vertical wall towards Villejuif and surrounded by a low rampart. Hence it is suggested that in all probability the advantage of the gun at Monthery was due to its being fired over this parapet, while that at Villejuif was fired from the level ground.

The fact that the wind blowing from Villejuif did not reverse this advantage, suggested the possibility that at night, when the diminution of temperature is downward, a light wind may not produce the same effect upon sound as when the diminution of temperature is upward, as it generally is during the day.

To ascertain if this is the case, some observations were made on some calm nights in May and June of the present year, from which it was found:—

(1) That the sky was cloudy and there was no dew. The sound of an electric bell 1 foot above the grass could always be heard further with the wind than against it; but

(2) That when the sky was clear and there was a heavy dew, the sound could invariably be heard as far against a light wind as with it, and in some cases much further. On one occasion, when the temperature at 1 foot above the grass was 38° and at 8 feet 47°, and the speed of the wind was 1 foot per second at 5 feet above the grass, the bell was heard 440 yards against the wind and only 270 with it.

Since, therefore, on the nights of the experiments at Villejuif and Monthery it is stated that the sky was clear, that there was dew, and the temperature recorded at the two stations shows the diminution to have been downwards, it is argued that the effect of the wind to render the sound less audible at Villejuif was completely balanced by the downward refraction of temperature.

Another phenomenon recorded by Arago is, that while the reports of the guns at Monthery as heard at that station were attended with prolonged echoes, this was not the case with those at Villejuif. It is thought that this difference is sufficiently accounted for by the fact that while Monthery is surrounded by high hills with precipitous or wooded sides, which must produce echoes, the country in front of Villejuif is very flat and has not a tree upon it for miles.

In concluding the paper reference is made to the Appendix to the last Report of the American Lighthouse Board, in which Dr. Henry, the Chairman, gives an account of his experiments, extending over thirty years, and the conclusions to which they have led him; both of which are in favour of the apparent stoppage of the sound being due to refraction.

Zoological Society, Jan. 4.—Prof. A. Newton, F.R.S., vice-president, in the chair.—An extract was read from a letter addressed to the Secretary by Mr. George Brown, dated Port Hunter, Duke of York Island, stating that he had shipped for the Society to the care of Dr. G. Bennett, of Sydney, two cassowaries and some other birds from New Britain and Duke of York Island.—A letter was read from Mr. R. Trimen, Curator of the South African Museum, Cape Town, containing some remarks on *Canis chama*.—Dr. Hector, F.R.S., exhibited and made remarks on three ancient feather-mats, made by the Maoris of New Zealand, which had been obtained by Dr. Buller, from a chief on the Upper Wanganui River.—Prof. W. H. Flower, F.R.S., gave a description of the skull of a fossil species of the genus *Xiphodon*, Cuvier, from a specimen belonging to the Museum of the Royal College of Surgeons, supposed to have been found near Woodbridge in Suffolk.—Prof. Huxley, F.R.S., read a paper on *Ceratodus*, in which he pointed out the special characters presented by this remarkable fish in the structure of its nasal apertures, brain, skull, and fore-limb. Prof. Huxley also called attention to the close connection shown by certain details of structure between *Ceratodus* and the Chimæroid fishes, especially as regards the skull.—A communication was read from Dr. Julius Von Haast, F.R.S., containing the description of a new Ziphioid whale from the coast of New Zealand.—Mr. Selater read a paper on some additional species of birds from St. Lucia, West Indies, which had been sent to him by the Rev. J. E. Semper of that island. The collection contained one very remarkable form which appeared to be referable to a new genus of *Mniotiltidae*, and was proposed to be called *Leucopeca semperi*.—A communication was read from Mr. W. H. Hudson containing some notes on the spoonbill of the Argentine Republic.—A paper was read by Messrs. Selater and Salvin, on Peruvian birds collected by Mr. Whitely, being the ninth of a series of communications on this subject.—A communication was read from Dr. Otto Finsch, containing notes on some Fijian birds, including description of a new genus and species proposed to be called *Drymoscherra badiceps*.—Mr. A. H. Garrod read a note on the *cacumini*

*coli* of the Capybara, as observed in a specimen recently deceased in the Society's menagerie.

Royal Microscopical Society, Jan. 5.—Mr. Chas. Brooke, F.R.S., vice-president, in the chair.—Messrs. W. A. Bevington and B. D. Jackson were elected auditors of the Society's accounts, and a list of gentlemen nominated for election as officers and council for the ensuing year was read by the Secretary.—Attention was called to a number of specimens sent to the Society a short time since by Mr. Hanks, of San Francisco, and which had since been mounted for the cabinet by Mr. Loy; also to some slides of *Aulacodiscus kittoni*, presented by Mr. Thos. Curties from material collected on the late Congo Expedition, by Mr. Martin, H.M.S. *Spiteful*.—Mr. C. Stewart then gave an interesting account of the structure and development of sponges, freely illustrating his remarks by drawings upon the black-board, and concluded by stating his reasons for believing that the well-known perforations in oyster-shell were really made by the sponge.—Mr. Hickie exhibited to the meeting some photographs from Germany of *Navicula crassinervis* and *Frustulia saxonica*, and read some letters from Dr. Rabenhirst and Herr Seibart in support of his opinion that the two were widely distinct.

Entomological Society, Jan. 5.—Sir Sidney Smith Saunders, C.M.G., president, in the chair.—Messrs. F. J. Horniman and D. G. Rutherford were elected ordinary members, and Prof. W. Dickson, of Glasgow University, and Mr. F. Enoch were elected subscribers.—The Rev. R. P. Murray exhibited a collection of Lepidoptera taken by himself on the Higher Alps, amongst which were some interesting mountain varieties.—Mr. S. Stevens exhibited a specimen of a dragonfly, rare in this country (*Æschnia mixta*), which he had picked up, nearly dead, in his garden at Upper Norwood, in the middle of November.—Mr. Champion exhibited some rare British Coleoptera.—Mr. H. W. Bates communicated a paper entitled "Additions to the list of Geodephagous Coleoptera of Japan, with synonymic and other remarks."—Mr. W. H. Miskin, of Queensland, communicated a description of a new and remarkable species of moth belonging to the genus *Attacus*, of which a male and a female specimen had been taken in the neighbourhood of Cape York. He had named the species *A. Hercules*. The expanse of the wings measured nine inches, and the hind wings were furnished with tails. The specimens had been deposited in the Queensland Museum.—Mr. C. O. Waterhouse forwarded a paper on various new genera and species of Coleoptera belonging to the *Geodephaga*, *Necrophaga*, *Lamellicornia*, and *Rhyncophora*.—Part IV. of the "Transactions" for 1875 was on the table.

#### MANCHESTER

Literary and Philosophical Society, Dec. 14, 1875.—Mr. Edward Schunck, F.R.S., &c., president, in the chair.—On graphic methods of solving practical problems, by Prof. Osborne Reynolds. In the first part of this paper it is pointed out that, when dealing with practical problems by the aid of the graphic method, it is not necessary to break off the operations of drawing, and find numerical values for the quantities represented, in order to perform on them the operations of multiplication and division. For by the aid of a parallel ruler the operations of multiplication and division may be performed graphically with great facility. The only geometrical proposition involved being that of finding a fourth proportional to three distances. When two distances have to be multiplied or divided the one by the other, a third distance is chosen equal to unity, and a fourth proportional found which represents the product or ratio of the first according as unity is the first or third of the given quantities. The method was illustrated as applied to the determination of areas, centres of gravity, and moments of inertia. In the second part of the paper a graphic method is described by which the velocity and acceleration of a moving point can be determined when the times at which it occupies certain positions are known, *i.e.* the curves representing the velocity and acceleration of the point may be drawn from the curve representing the positions of the point. Also a converse method by which the position of a point at any time may be found from the curve representing either its velocity or displacement.—On explosions of fire-damp. E. W. Binney, F.R.S., said that the fearful loss of life in our coal-mines deserved the careful attention of all societies like ours. It ought to be one of the objects of science to endeavour to find out the cause of these explosions, and to devise some means to prevent their occurrence or lessen their frequency. No doubt Government inspection had been of service, and the examination of managers would tend to improve the efficiency of

mining officers; but still, notwithstanding these improvements, the explosions of fire-damp are sadly too frequent. The lamentable events which have taken place within the last few weeks clearly show that they sometimes occur without any great change in the barometric pressure of the atmosphere, although undoubtedly sudden depressions in a barometer ought to caution miners against emission of gas from the seam of coal and coal-wastes, and put the men more on their guard at such times. It has been stated in this Society that certain conditions of the atmosphere quite irrespective of barometric pressure may have something to do with causing the "drag" in the currents of air circulating through a mine, as explosions have frequently occurred during an east wind and a muggy state of the atmosphere, and a vesicular condition of water in the air has been suggested as the probable cause of this lessening of the speed of the air passing through the galleries of mines. Now, careful observations with a good anemometer in the return air-course of a mine ought to determine whether or not such an effect is produced, and thus settle this point by direct experiment. Another source of accidents at this time of the year has to be taken into consideration. Before Christmas and in cold weather there is often a brisk demand for coal, and both managers and men are in a hurry to increase the output, and under such circumstances probably there may be sometimes not so much care and caution exercised as are necessary for them to use in the dangerous work in which they are engaged. In the management of a fiery mine, in my opinion—1. There ought not to be any unventilated wastes. 2. The mixed use of Davy lamps and naked lights should not be permitted where the former are commonly employed. 3. Blasting of coal by gunpowder should not be sanctioned where Davy lamps are in common use. 4. An anemometer under the care of a competent man should be in constant use, in order to see that a sufficient current of air is passing through the workings to insure perfect ventilation of the mine. 5. When there are marked indications of firedamp in a mine, shown by a cap on the flame of a lamp, the men engaged in hewing and drawing coal should be removed from the pit until by ventilation the place is cleared of gas and rendered safe for a working collier. The above precautions may probably cause an increased cost in the getting of coal, but they are necessary for the preservation of human life if such catastrophes as now frequently occur are to be prevented. It is now pretty generally admitted that all explosions of fire-damp are caused by there being too little pure air and too much of that gas in a mine.—Chemical notes, by M. M. Pattison Muir, F.R.S.E., Assistant Lecturer on Chemistry, Owens College.

## PARIS

Academy of Sciences, Jan. 3.—Vice-Admiral Paris in the chair.—M. Peligot was elected vice-president for 1876; and MM. Chasles and Decaisne were elected to the Central Administrative Commission. The following papers were read:—On the interior constitution of magnets, by M. Jamin.—New thermic researches on the formation of organic compounds; Acetylene, by M. Berthelot. The heat liberated by combustion of acetylene with free oxygen = + 321 cal. for  $C_2H_2 = 26$  grs.—Final reflections on the production of saccharoid matters in plants, by M. Duchartre.—Ephemerides of the planet (156) determined by M. Rayet, from observations at Marseilles, by M. Læwy.—On the way in which caloric vibrations may dilate bodies, and on the coefficient of dilatation, by M. de Saint-Venant.—Sixteenth note on the electric conductivity of moderately conducting substances, by M. Du Moncel. Minerals, when truly conductors, have but two kinds of conductivities, an electrolytic conductivity and one which is proper to them and approximates more or less to metallic conductivity. The electrotonic conductivity proper to dielectrics exists only in rocks known to be isolating and in crystals. But there are effects which imply a characteristic polarity of a moderately conducting medium.—New crystallised hydrate of chlorhydric acid, by MM. Pierre and Pachot. Mixing two parts of snow with one part of hydrochloric acid (cooled previously to  $-15^\circ$  or  $-16^\circ$ ), one may obtain a temperature of  $-35^\circ$  C.—On a new fundamental law of electro-dynamics, by M. Clausius.—On the study of thermic motors, and on some points of the theory of heat in general, by M. Hirn. This is an outline of Vol. II. of the author's work on Thermodynamics.—Osseous heads of fossil and actual human races; history of ethnic craniology; Negro race, by MM. Quatrefages and Hamy.—Report on M. de Magnac's method for representing the daily course of chronometers.—Determination, by the principle of analytical correspondence, of the order of a geometric

place defined by algebraic conditions, by M. Saltel.—On a point of infinitesimal geometry, by M. Serret.—On left cubics, by M. Appell.—Physiological conditions influencing the character of unipolar excitation of nerves, during and after the passage of a battery current, by M. Chauveau. He studies four cases: nervous system intact, spinal cord separated from brain, cord destroyed, and nerve cut above point of application of electrode.—On a commensal Amphipodan (*Urothoe marinus*) of the *Echinocardium cordatum*, by M. Giard.—Elliptic elements of the planet (157) Dejanire, and calculated ephemerides, by M. Stephan.—Researches on the law of transmission, by the earth's atmosphere, of calorific radiations from the sun, by M. Crova.—On the phenomena of induction, by M. Mouton. He studies the electric state of an induced bobbin with the ends unconnected, and too far apart for a spark to pass; a series of oscillations in potential is observed.—On the rôle of acids in dyeing with alizarine and its congeners, by M. Rosenstiehl.—On the phosphates of sesquioxide of iron and alumina, by M. Millot.—On a secondary hexylic alcohol, by M. Echsner de Coninck.—On the assimilability of fossil phosphates, and on the danger of exclusive use of azotised manures, by M. Roussille.—On the preparation of gaseous bromhydric acid, by M. Bertrand.—Researches on the functions of glands in the digestive apparatus of insects, by M. Jousset. He was able, in *Blatta orientalis*, to obtain the liquids in the gland itself before entrance into the alimentary canal.—On the floral glands of *Parnassia palustris*, new physiological functions, by M. Hæckel. These glands are a carnivorous organ.—Undulations of the clay in the north of France, by M. Hebert.

## VIENNA.

Geological Society, Dec. 7, 1875.—After welcoming Dr. E. Tietze on his return from Persia, M. von Hauer presented some papers sent in by Dr. K. Peters on the interesting limestone from the Sauerbrunngraben, near Stainz, in Styria, which encloses crystals of a plagioclastic felspar belonging to the species Albite.—Dr. A. Feistmantel, on the minerals of the peculiarly large-grained granite (Pegmatite) from the districts of Behar and Rangun, in Bengal. Among them large plates of mica are very remarkable, which the inhabitants make use of as ground for paintings, but they are also, like the Russian mica, brought to Europe for sale.—Dr. Kapf, of Stuttgart, on some very interesting remains of Saurians found in the so-called Stuben sandstone of Wurtemberg.—Dr. Mojsisovics presented the second volume of his work on the Mountains of Hallstadt, and gave a short account of its contents. In this volume the genera *Arcestes* (with 112 species), *Didymites* (with 6 species), and *Lobites* (with 26 species) are described, and illustrated in thirty-eight lithographic plates.—Dr. Dölter reported on the composition of the Melaphyres from the Southern Tyrol. Among the essential constituents of them, he recognised in some cases Amphibole, in others Augite.—R. Hömes exhibited some remains of *Anthracotheerium magnum*, from the coal-mines of Trifail, in Styria, and expressed the opinion that the carboniferous strata of Trifail and Sotzka are not identical with those of Eibiswald and Wies, but belong to an older stage of the tertiary period.

## CONTENTS

	PAGE
OUR WATER SUPPLY . . . . .	201
LIEUT. CAMERON IN CENTRAL AFRICA . . . . .	202
MORRELL'S "EUCLID SIMPLIFIED" . . . . .	202
TISSANDIER'S PHOTOGRAPHY. By R. MELDOLA ( <i>With Illustrations</i> ) . . . . .	204
OUR BOOK SHELF:—	
Leared's "Morocco and the Moors" . . . . .	206
Grohman's "Tyrol and the Tyrolese" . . . . .	206
LETTERS TO THE EDITOR:—	
The Late Eclipse.—Dr. ARTHUR SCHUSTER . . . . .	207
The Fossil Skeletons of Le Puy en Velay.—Rev. W. S. SYMONDS . . . . .	207
A Meteor in the Daytime.—WILLIAM F. DENNING . . . . .	208
Blowpipe Analysis.—T. S. HUMPHIDGE . . . . .	208
Marine Aquaria.—H. J. M'G. . . . .	208
The Glow-worm in Scotland.—Dr. WM. McLAURIN . . . . .	208
Bryant and May's Safety Matches.—W. H. PREBCE . . . . .	208
OUR ASTRONOMICAL COLUMN:—	
The Minor Planet, No. 153 . . . . .	208
Satellites of Uranus . . . . .	208
The Great Comets of 1874 and 1680 . . . . .	208
AN EXPLORING EXPEDITION TO THE INTERIOR OF SUMATRA. By Dr. A. A. W. HUBERCHT ( <i>With Illustrations</i> ) . . . . .	209
FERTILISATION OF FLOWERS BY INSECTS, XII. By Dr. HERMANN MULLER ( <i>With Illustrations</i> ) . . . . .	210
BEATS IN MUSIC. By W. POLE, F.R.S., Mus. Doc. Oxon . . . . .	212
UNITED STATES NATIONAL ACADEMY OF SCIENCES . . . . .	214
NOTES . . . . .	216
SCIENTIFIC SERIALS . . . . .	218
SOCIETIES AND ACADEMIES . . . . .	218

THURSDAY, JANUARY 20, 1876

## THE "ENCYCLOPÆDIA BRITANNICA"

*Encyclopædia Britannica*. Vol. III. (Edinburgh: Adam and Charles Black.)

## FIRST NOTICE.

THERE are several important scientific articles in this third volume which we shall briefly notice, the articles generally being quite up to the standard of the preceding volumes. In this first notice we shall refer especially to the articles "Birds" and "Biology." The former article is the joint production of two authors, Professors W. K. Parker and Alfred Newton.

Prof. Parker has undertaken the anatomical portion of the subject. Allowing himself to be led away in the direction of his favourite line of research, the author has persuaded himself that in the space allotted to him for his article "there is merely room for justice to be done to one category of organs; and as the skeleton and especially the skull is of most direct importance to the zoologist and palæontologist, and as its form determines, as it were, all other organs . . . it seems to be that on which election should fall for the fuller treatment." From this opinion we disagree *in toto*. If the space allotted for the subject is insufficient, it must be a fault of the general management of the "Encyclopædia." If the skull "determines, as it were," all other organs, then the study of anatomy is on a very different footing from that on which it seems to stand. By a glance at the earlier volumes of the work, in which, as in the case of the article "Anatomy," by Prof. Turner, apparently unlimited space is allowed to the author, we come to the conclusion that there is no fault in the editorial department, in this direction at least. As to the "determining" influence of the skull the true relationship of three groups of birds—the woodpeckers, toucans, and barbets—which will be found explained below, is quite sufficient to demonstrate how unwarranted is the assumption.

In 1867 Prof. Huxley propounded a classification of birds, not entirely, but mainly based on the nature of a portion of the palatal region of the skull. This valuable addition to ornithological and zoological literature has given a great stimulus to more minute investigation of avian structure. It brought to light many new facts, and placed prominently forward others previously too much neglected. The classification was, however, only an artificial one, for, according to that author's own words in the article "Biology" before us, "in an artificial classification some prominent and easily observed feature is taken as the mark of resemblance or dissemblance." The features employed in this case were two—the fusion or non-fusion of the maxillo-palatine plates of the maxillary bones, and the shape of the vomer. In a hobby-run-wild manner, Prof. Parker, in his article "Birds," has further elaborated this artificial arrangement to a degree which, more than anything else, demonstrates its untenability. He begins by dividing the "Carinata" into two sections, firstly, the Dromæognathæ (*Tinamous*), and secondly, all the others; because in the *Tinamous* the vomer is broad behind and interposes between the pterygoids, the palatines, and the basi-sphenoidal rostrum (which, however, is

also the arrangement in some of the penguins at least.) Among the other carinate birds, Prof. Huxley's divisions are retained, except that the woodpeckers are removed from the *Ægithognathæ* to form an independent group of equal importance with them, the Saurognathæ! The Desmognathæ (Huxley), we are told, do not form a well-collected group, and Prof. Parker does good service by indicating the different ways in which desmognathism may be produced.

According to this classification, there are some so great anomalies, when it is looked at from the aspect based on the totality of the morphological resemblances in the bird-class, that it is certain that the palate, *per se*, is in reality of secondary importance in the determination of the relationships of many birds.

For instance, according to Prof. Parker, the Woodpeckers (*Picidæ*) form a main division (Saurognathæ) of the non-desmognathous carinate birds, at the same time that the Toucans (*Ramphastidæ*), together with the Barbets (*Capitonidæ*) form part of a minor section (Coccygomorphæ) of the desmognathous birds. In other words, they would be made to have as little to do with one another as they well can. Now the structure of the rest of the body, other than the head, tells quite a different tale. From the form of the feathers and the pterylosis, there being no after-shaft, a tufted oil-gland and quite a characteristic distribution of the peculiarly narrow feather-tracts; from their osteology, the sternum and other bones being almost identical in all of them; from the anatomy of the alimentary canal, in which the colic cæca are absent; from the arrangement of the toes in the scansorial foot; from their myology, in which they are identical when dissected, muscle by muscle, and different in points from all other birds, it is certain that the three groups, viz., the Woodpeckers, Barbets, and Toucans, are most intimately related, and have not, in reality, a family difference between them; their dissimilarities—the Toucans and Barbets merging into one another—leading to their being arranged in two sub-families.

As another example of the different teaching of the artificial and the natural classifications, the Swifts (*Cypselidæ*), and the Humming Birds (*Trochilidæ*) may be referred to. These two groups, from the details of their internal structure when examined one by one, are most certainly related as intimately as are the Woodpeckers with the Toucans. There is, in fact, not a family difference between them, and yet, from their palates, Professors Huxley and Parker place them in quite different divisions, because the vomer is truncated in the one and pointed in the other.

We think that we have said enough to show that the structure of the skull does not alone suffice to determine the mutual affinities of birds, the head in them being subject to rapidly developing peculiarities which are associated with their habits of life.

With the exception of the skeleton, the rest of which is described in fair detail, Prof. Parker devotes but few columns of his article to the organs, muscles, vessels, and nerves; he in most cases quoting verbatim from Prof. Huxley's "Anatomy of Vertebrated Animals."

Prof. Newton's portion of the article "Birds" forms a valuable memoir on the topics he discusses. The elegance of the style, and the careful manner in which the

relative importance of the facts which are introduced is weighed, adds a charm to the subject equal to that which it already possesses. "Fossil Birds," "Sub-fossil Birds," "Birds recently extirpated," "Birds partially exterminated," "The Geographical Distribution of Birds," "Migration," "Song," "Nidification," "Eggs," and "Moult," are the headings of the various sections of his subject; the whole occupying about fifty pages of the "Encyclopædia;" that on Distribution being of considerably the greatest length, as it is fairly exhaustive in its account of the avifauna of the different regions. Speaking of the general principles of zoogeography, first laid down by Mr. Sclater in 1857, Prof. Newton remarks that "without infringing upon what must be deemed the generalities of biological distribution, it is proper to observe that Mr. Sclater's success is to be attributed to the method in which his investigations were carried on—a method in which he had but few predecessors. Instead of looking at the earth's surface from the point of view which the geographer would take of it (a point of view which had hitherto been adopted by most writers), mapping out the world according to degrees of latitude and longitude, determining its respective portions of land and water entirely regardless of the products of either element, or adhering to its political divisions—time-honoured as they were—he endeavoured to solve the question simply as a zoologist should, by taking up the branch of the subject with which he was best acquainted, and by pointing out and defining the several regions of the globe in conformity with the various aspects of ornithic life which they present. But herein there was at once a grave difficulty to be encountered. Birds being of all mammals most particularly adapted for extended and rapid locomotion, it became necessary for him to eliminate from his consideration those groups, be they large or small, which are of more or less universal occurrence, and to ground his results on what was at that time commonly known as the order *Incessores*, or *Passeres*, comprehending the orders now generally differentiated as *Passeres (veræ)*, *Picaria*, and *Psittaci*. On this basis, then, Dr. Sclater was enabled to set forth "that the surface of the globe exhibited six great regions," an account of each of which is given in detail, with the light thrown upon them by more modern research.

As might be imagined, the section on "Birds recently extirpated" is a more complete and accurate *résumé* of their history than any other extant, the Starling of Réunion (*Fregilupus varius*), the Solitaire of Rodriguez (*Pezophaps solitarius*), and the Crested Parrot of Mauritius (*Lophopsittacus mauritianus*), being figured as well as described.

The article "Biology" is by Prof. Huxley and Mr W. T. Dyer. The subject is treated generally by the former author in his well-known style, whilst Mr. Dyer gives the principles of classification of the vegetable kingdom as they are now understood by the most advanced botanists.

Prof. Huxley classifies the phenomena of life under four headings:—1. Morphology; 2. Distribution; 3. Physiology; and 4. Etiology. The last of these, from its theoretical nature, presents features of more especial interest. With reference to the doctrine of spontaneous generation we read: "It has been pointed out at the

commencement of this article that the range of high temperatures between the lowest, at which some living things are certainly killed, and the highest, at which others certainly live, is rather more than 100° Fahr. It makes no sort of difference to the argument how living beings have come to be able to bear such a temperature as the last mentioned; the fact that they do so is sufficient to prove that, under certain conditions, such a temperature is not sufficient to destroy life. . . . Thus it appears that there is no ground for the assumption that all living matter is killed at some given temperature between 104° and 208° Fahr." Again, "it is argued that a belief in abiogenesis is a necessary corollary from the doctrine of evolution. . . . In the eyes of a consistent evolutionist any further independent formation of protoplasm would be sheer waste."

Prof. Huxley gives his powerful and entire sanction to the doctrine of Ontogeny, explaining the facts that in many forms there are gaps and irregularities in the order of production of the organs, by assuming that the series of developmental stages of the individual organism never present more than an abbreviated and condensed summary of ancestral conditions.

Mr. Dyer devotes himself to the "Limits and Classification of the Vegetable Kingdom," and concludes his article with a synoptic view of the relations of plants, which shows how much attention has recently been paid to the lower forms. Schwendener's hypothesis is assumed, and "Lichens must now be regarded as composite structures, partly consisting of an alga, partly of a fungus." The Thallophyta are classified according to the method of Sachs, and the Cryptogams according to Cohn. The stepping-stones between these last and the Phanerogams are excellently sketched.

We think we have said enough to show the great importance of the two articles which we have been attempting to criticise.

A. H. GARROD

#### FOSSIL BUTTERFLIES

*Fossil Butterflies.* By Samuel H. Scudder. (Published by the American Association for the Advancement of Science, Salem, 1875.)

THE memoir now before us will be a boon, not only to geologists, but to entomologists, inasmuch as it reproduces in a small compass, as Mr. Scudder says, "all that has been published of this group of fossils, whether of text or illustration."

After giving a complete list of all the works treating of the subject, the author proceeds to characterise the genera and species, beginning with *Neorinopsis sepulta*, from Aix in Provence, a fossil more discussed than any other ancient Lepidopteron. He confirms Mr. Butler's determination of its affinities, but adds that, from a careful study of the original, he has been enabled to correct an error as regards the actual condition of the fossil, which he thus describes:—

"The thorax, hind legs, and both pair of wings of the left side are preserved, almost completely; all the rest is lost. The thorax is viewed from above, and somewhat on the left side; the hind coxæ seem to be almost torn away from their immediate connection with the trunk. The two hind legs are stretched out, bent at the femoro-tibial articulation; the left leg lies above both the wings,



and is apparently attached throughout, although its base is covered a little by the crushed body; the right leg lies below both the wings, and is apparently partially detached, though but slightly, from the coxæ; the tibio-tarsal articulation can be distinguished, but not the tarsal joints. The wings are bent over downward in a position the reverse of that of repose. The fore-wing covers the hind-wing, as in nature, but to such an extent as to conceal the greater part of it; the guttered portion of the inner margin of the hind-wings is almost fully expanded, but apparently has a fold next the submedian nervure. The fringe of the fore-wing seems to be gone, but that of the hind-wing is preserved nearly throughout. Head, fore and middle legs, wings of the right side, and abdomen are wholly wanting.

"The upper surface of the wing is, therefore, the part which attracts most attention."

The above description throws an entirely new light upon this fossil, and is exceedingly interesting.

*Lethites reynesii*, another Eocene species, is placed next to the genus *Lethe*; the latter comes close to *Melanitis* in Westwood and Hewitson's "Genera of Diurnal Lepidoptera," a fact which Mr. Scudder considers of some interest; the two groups, however, are widely separated in some recent classifications, in which the structural relations of the genera of *Satyrina* have received special attention.

The Tertiaries of Radoboj afford another remarkable fossil (*Mylothrites pluto*) which Mr. Scudder, differing widely from all previous writers, refers, on we think insufficient grounds, to the sub-family *Picrina*, inasmuch as the spots on the wings are not of the same simple character as those of *Hebomoia* and allies, but are true ocelli, the zones of which are clearly visible even in the drawing on Plate II. (compare Figs. 14 and 17). The portion of a hind wing (Fig. 15) has been also somewhat rashly referred to *Mylothrites*, its venation being markedly different, and agreeing more nearly with the Eastern genus *Terinos* than with any other group known to us.

Mr. Scudder seems to have indicated the correct position of *Coliates proserpina* and *Pontia Freyeri*. In the case of the former, his task, owing to the obscure character of the original, must, as he says, have been a difficult one.

Spots on the wings, such as are represented on Plate II., Fig. 5, are rarely to be met with among the *Picrina*, but do occur in some males of the genus *Appias*.

It is probable that Mr. Scudder is again correct with regard to the position of *Thaites ruminiana*, although the general pattern, form of the wings, and large abdomen are all far more like *Dynastor* or *Castnia*.

*Thanaites vetula* and *Pamphilites abdita* have manifestly the proper places assigned to them, and great credit is due to the author for the labour which he has expended in their determination.

Mr. Scudder's conjectures respecting the "food-plants of Tertiary Caterpillars" are exceedingly interesting, as also his remarks on "the present distribution of Butterflies most nearly allied to fossil species." Asiatic forms having the facies of *Pamphilites abdita* are not, however, as he supposes, unknown; the *Urbicolæ* of East India are perhaps not as yet largely represented in American collections.

In his "Notice of Insects which have been erroneously referred in recent times [to Butterflies," Mr. Scudder

dwells upon the discussion between himself and Mr. Butler respecting *Palæontina ooliica*, and gives facsimiles of that author's illustrations, with an additional sketch representing his own view of the characters of the species. From a comparison of the five illustrations it is difficult to conclude that Mr. Scudder has proved his case. The venation, as given by him, not only does not agree with that of any genus of *Lepidoptera*, but is entirely at variance with what is found in any insect. To associate it with the *Cicadina* is impossible, seeing that these insects have irregular neurulation, whereas Scudder's figure furnishes us with a Lepidopteroid type having anomalous cross-veins and an incomprehensible discoidal cell.

The assertion that "none of the median nor any of the inferior subcostal nervules are ever branched certainly requires modification; the genus *Amathusia* has a well-marked spur on the third median branch, which conveys the impression of a fourth median nervule, whilst the genus *Moschoneura* emits its upper discoidal from the inferior margin of the subcostal.\*

Mr. Scudder, in America, is surely a little too hard upon his entomological brethren on this side of the Atlantic, when he speaks of the new Linnæan room at Burlington House in which they held their meeting as "a poorly lighted hall." See p. 95.

We cannot conclude without expressing our admiration of the beautifully executed plates which accompany the letterpress.

#### BURCHETT'S "PRACTICAL PLANE GEOMETRY"

*Practical Plane Geometry.* By E. S. Burchett. (London and Glasgow: W. Collins, Sons, and Co., 1876.)

THIS is a carefully got-up and good work on the subject of which it treats. After the usual preliminary matter on definitions and the use of instruments are given 333 problems. This may appear to be too large a number for school teaching, but the work is principally intended for students in Art schools. For school purposes, and we have more than once recently pointed out that the subject is taught as affording a good initiation to the study of pure geometry, we should recommend the master to make a selection such as he thinks adapted to the attainments of his pupils or fitted to the end he has in view in taking up the study. Plates LII. to LXIII. are devoted to Applied Geometry (such as curves of mouldings, Gothic tracery, construction of scales, &c.). An Appendix (Plates LXIV. to LXXI.) treats of the Elements of Orthographic Projection. This last portion we are told is given expressly to meet the requirements of the more extended range of the Second Grade Examination of the present day. We have verified most of the constructions, which are clearly given, and in the main admit of demonstration on pure geometric principles. Some relating to the construction of polygons, three on the contact of circles, and some few relating to the areas of circles, are founded on approximative methods. The arrangement of the text and of the plates appears to us to be a good one. The book must be used in a position at right angles to the usual one, and then the text is on

\* See Westwood's "Oriental Entomology," p. 40, and compare "Trans. Ent. Soc.," 1870, p. 486; also "Cistula Entomologica," i. p. 54.

the left-hand page, and so above the plates, which are immediately under the pupil's eyes. The printing and the plates (the only figure that does not please us is the oval on Plate II.) leave nothing to be desired.

We proceed to point out a few matters which we think admit of improvement. Plate II. in the definition of a circle *invariant* is used; why not "constant?" The construction of Fig. 6 (Plate IV.) is hardly satisfactory to our view, though it is one very frequently given; the tangent to the two arcs is not obtained by a legitimate method. We cannot make out the definition of an harmonic mean given on Plate VII., but the means are correctly constructed. In Fig. 31 (text), for GH:HA, read *vice versa*. We may remark that it is a curious fact that the approximative construction given in Fig. 87 is true in the cases of regular figures of three, four, and six sides. In Fig. 99 (text) read "through F and E." In Fig. 112 (text) arcs "cutting in C," not G. Constructions to Figs. 123, 125 give particular ellipses; so in the case of the parabolas in Figs. 138, 139, we note that certain figures are stated to be co-centric and certain curves have asymptotes. In Fig. 271 (text) read to cut in "I and H." We object, on pure geometric grounds, to the constructions in Figs. 278, &c., where a line is found equal to the semi-circumference of a circle, &c.; also the inscribed circle of a square and the inscribed triangle are stated as being in the ratio, triangle:circle:square, as 2:3:4. In Fig. 279 (text) the two last A's should be D. The construction to Fig. 297 (to draw a line to bisect any triangle from a given point within it) is new to us, and on a cursory examination of it we have not satisfied ourselves of its correctness. In Fig. 314, for XY, read ZY. In Fig. 316, "the square on," or some such words have been omitted. In Fig. 323 the limitations have not been laid down. In Fig. 329, "join point x," &c.; in 331, for "rectangle" read "parallelogram." These trivial oversights will serve to show how correctly the text has been printed.

### OUR BOOK SHELF

*Observaciones Magneticas y Meteorologicas del Colegio de Belen de la Compania de Jesus en la Habana, 1873 y 1874. (Habana, 1874 and 1875.)*

THE observations made at the College of the Society of Jesus, Havana, are peculiarly valuable for the fulness and care with which they are made, and for the completeness with which the observations themselves and the monthly means and extremes are given in each monthly table and its accompanying diagram. The diagrams, which have been published in their present improved form since June 1873, and which exhibit on one sheet the two-hourly observations as made daily from 4 A.M. to 10 P.M. of all the meteorological and magnetical elements, will very much facilitate the study of those inquiries which deal with the inter-relations of these elements. To these observations are added the daily amounts of the rainfall and evaporation—the latter being of great interest as contributing to our knowledge of the evaporation in inter-tropical regions, of which so little is known. Whilst only the daily amounts of the rainfall is given, each hour during which rain falls is noted, together with the hour of occurrence of thunder and other irregularly recurring phenomena. As regards the diurnal variations of the wind it changes from about S.E. in the early morning, through E. and N.E. to N.N.E. its most northerly point, which is usually reached about 2 P.M., and thence in the

reverse direction through N.E. and E. to E.S.E., which is reached about 10 P.M. The diurnal velocity is at the minimum at 4 A.M., rises to the maximum at 2 P.M., and thence falls steadily to the minimum. The N. and N.E. winds are decidedly the strongest, and the S.E. the weakest, the ratio being as two to one; in other words, the sea-breeze blows with double the velocity of the land-breeze at this station.

### LETTERS TO THE EDITOR

[The Editor does not hold himself responsible for opinions expressed by his correspondents. Neither can he undertake to return, or to correspond with the writers of, rejected manuscripts. No notice is taken of anonymous communications.]

#### Blowpipe Analysis

MR. HUMPIDGE (vol. xiii. p. 208), on the entirely gratuitous assumption that I use "commercial reagents"—whatever that term may mean—says that there is probably iron in my soda.

To this I only reply that I will undertake to show pyrologically the presence of 0.01 per cent. of iron oxide in a fragment of a salt the size of a pin's head; and that, when Mr. Humpidge can do as much without using the dangerous test potassium ferrocyanide (which itself contains iron), I will admit his right to assume that he knows his tools better than other workmen.

No one has ever doubted the proportional relativity in precipitating power between a drop and a gallon of water, but if Mr. Humpidge will only do me the justice not to mutilate my statements in the reproduction, he will repeat that a precipitate could not be shown in a drop of water "on a fused mass upon an aluminium plate."

W. A. ROSS

Shepherd's Bush, W., Jan. 14

#### The D-line Spectrum

WILL Prof. Stokes give us the reason of his now holding that his first—to all appearance, extremely rational—conclusion, that, in consequence of "the powerful affinities of sodium, it could not exist in a free state in the flame of a spirit-lamp," is "erroneous"?

Shepherd's Bush, W., Jan. 8

W. A. ROSS

**The Difference of Thermal Energy transmitted to the Earth by Radiation from different parts of the Solar Surface.**

THE tenor of certain letters received from scientific persons on the above subject induces me to lay the following statement before the readers of NATURE:—

1. Previous to undertaking a systematic investigation of the mechanical properties of solar heat, I examined thoroughly the merits of Laplace's famous demonstration relating to the absorptive power of the sun's atmosphere, proving that only one-twelfth of the energy developed by the sun is transmitted to the earth. The demonstration being based on the assumption that the sun's rays emit energy of equal intensity in all directions, my initiary step was that of testing practically the truth of that proposition. It has been asserted that Laplace did not propound the singular doctrine involved in such a proposition, I therefore feel called upon, before proving its unsoundness, to quote the words employed by the celebrated mathematician. (See "Mécanique Céleste," tome iv. page 284.) Having called attention to the fact that any portion of the solar disc as it approaches the limb ought to appear *more brilliant* because it is viewed under a *less angle*, Laplace adds:—"Car il est naturel de penser que chaque point de la surface du soleil renvoie une lumière égale dans tous les sens." Let  $abcd$ , in the annexed diagram, Fig. 1, represent part of the border of the sun, and  $ba, cd$ , small equal arcs;  $ad, bb', cc', dd'$ , being parallel rays projected towards the earth. Laplace's theory asserts that owing to the concentration of the rays the radiation emanating from the portion  $dc$  transmits *greater* intensity towards the earth than  $ba$ , in the proportion of  $cd$  to  $bc$ . The proposition is thus stated in "Mécanique Céleste": "Call  $\theta$  the arc of a great circle of the sun's surface, included between the luminous point and the centre of the sun's disc, the sun's radius being taken for unity; a very small portion  $a$  of the surface being removed to the distance  $\theta$

from the centre of the disc, will appear to be reduced to the space  $a \cos \theta$ ; the intensity of its light must therefore be increased in the ratio of unity to  $\cos \theta$ ."

2. In order to disprove the correctness of the stated demonstration, I have measured the relative thermal energy of rays projected in different directions from an incandescent metallic disc, by the following method:—Fig. 2 represents section of a conical vessel covered by a movable semi-spherical top, the vessel being surrounded by a jacket through which water may be circulated. A revolving circular disc,  $aa$ , composed of cast iron, the back being semi-spherical and protected by fire-clay, is suspended across the top of the conical vessel supported by horizontal journals attached at opposite sides. The angular position of the disc is regulated by a radial handle,  $b$ , connected to one of the journals; the exact inclination to the vertical line being ascertained by means of a graduated quadrant,  $d$ . An instrument,  $c$ , capable of indicating the intensity of the radiant heat transmitted by the incandescent disc, is applied at the bottom of the conical vessel. The mode of conducting the experiment is extremely simple. The movable cover and its lining of fire-clay having been removed, the cast-iron disc is heated in an air-furnace to a temperature of 1,800° F. It is then removed by appropriate tongs, and suspended over the conical vessel, the lining and cover being quickly replaced. The temperature, shown by the instrument at the bottom of the conical vessel, resulting from the action of the radiant heat of the disc, is then recorded for every tenth degree of inclination. The investigation, it may be briefly stated, shows that the temperatures imparted by radiation to the recording instrument is exactly as the sines of the angles of inclination of the disc. Hence, at an inclination of 10° to the vertical line, the temperature imparted to the thermometer is scarcely one-sixth of that imparted when the disc

temperature of 27°·49 F. to the thermometer  $g$ , while the radiation from the zone A, Fig. 6, imparted only 6°·19 F. to the thermometer  $k$ . Let us bear in mind that the radiating surface  $lm$  of the zone A is equal to the radiating surface  $pq$  of the zone c. The stated great difference of temperature produced by the radiation from zones of equal area furnishes additional proof that Laplace based his remarkable analysis on false premises. "The sun's disc ought to appear more brilliant towards the border, because viewed under a less angle," we are told by the great analyst. The instituted practical tests, however, prove positively that the energy of the rays projected from the border of an incandescent sphere is greatly diminished because viewed under a less angle from the point occupied by the recording thermometer.

FIG. 2.

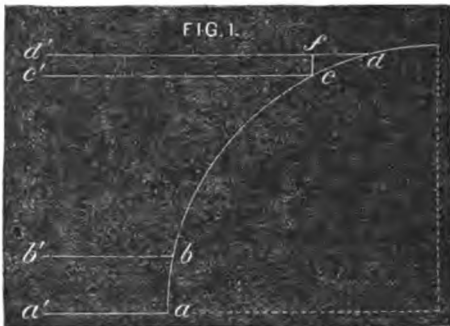
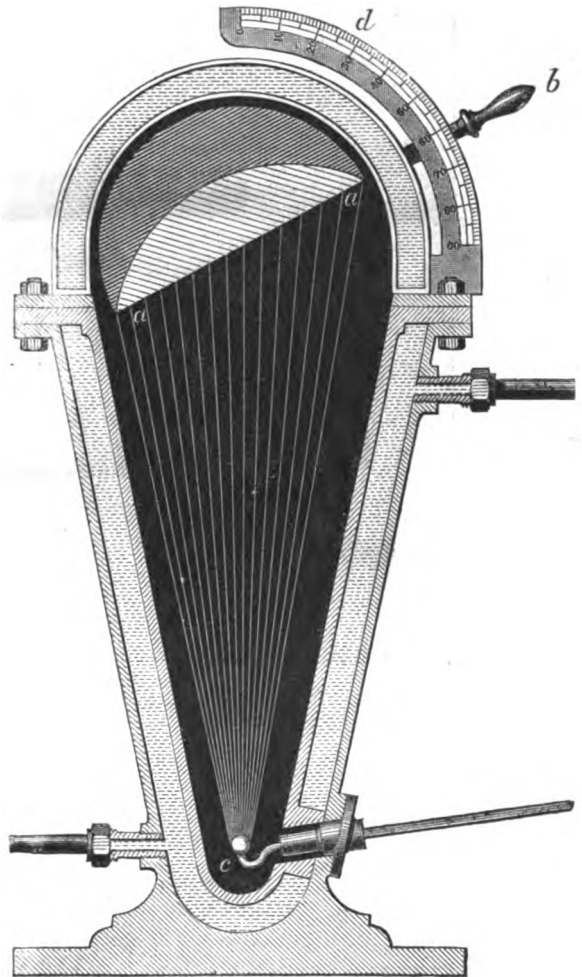

faces the thermometer at right angles; yet in both cases an equal amount of surface of an equal degree of incandescence is radiating towards the instrument! Laplace and his followers have evidently overlooked this important and somewhat anomalous fact, proving that radiation emanating from heated bodies is incapable of exerting full energy in more than one direction. Our practical experiments with the revolving incandescent disc have thus fully demonstrated the truth of the proposition intended to be established, namely, that the rays emanating from incandescent planes do not transmit heat of equal energy in all directions, the energy transmitted being as stated, proportionate to the sines of their angle of inclination to the radiating surface.

3. The next step in the investigation of solar heat, before adverted to, was that of measuring the radiant energy transmitted in a given direction by an incandescent solid metallic sphere. For this purpose I employed a double conical vessel similar to the one represented in Fig. 2, the incandescent sphere being suspended over the conical vessel in the same manner as the revolving disc. The nature of the arrangement will be readily understood by inspecting the annexed diagram, which represents four spheres, Figs. 3, 4, 5, and 6, each sphere being divided into four zones, A, B, C, and D, occupying unequal arcs, but containing equal convex areas. Semi-spherical screens composed of non-conducting substances were applied below each sphere, provided with annular openings, arranged as shown in the diagram. Through these annular openings the radiant heat from the incandescent zones, D, C, B, and A, was transmitted to the thermometers,  $f$ ,  $g$ ,  $h$ , and  $k$ , respectively. Père Secchi, and other followers of Laplace, will be surprised to learn that when the suspended sphere was maintained at a temperature of 1,800° F., the radiation from the zone c, Fig. 4, imparted a

4. The result of our experiment with the revolving incandescent disc shows that if the small arc  $ba$ , in Fig. 1, be reduced until the field represented by  $ba$  becomes equal to the field represented by  $c'd'$ , the radiant energy transmitted through each of those fields will be alike; the reason being that the number of rays of diminished intensity passing through  $c'd'$  will be as much greater than the number of rays of maximum intensity passing through  $ba$ , as  $cd$  is greater than the reduced  $ba = fc$ . It should be observed that  $cd$  is so small that we may without appreciable error regard it as a straight base, and  $fc$  as the sine of the angle  $cdf$ . It follows from this demonstration that if the solar atmosphere exerted no retarding influence, the radiant heat transmitted towards the earth would be alike for equal areas of the solar disc—more correctly, for areas subtending equal angles, since the receding part of the solar surface is at a greater distance from the earth than the central part.

Encouraged by the practical result of the instituted investiga-

tion, I devised the method described in NATURE (vol. xii. p. 517), showing that the polar and equatorial regions of the solar disc transmit radiant heat of equal intensity to the earth, and that the sun emits heat of equal energy in all directions. Adopting Secchi's doctrine relating to the retardation suffered by calorific rays in passing through atmospheres, viz., that the diminution of energy is as the depth penetrated by the rays, it may also be shown by an easy calculation based on the result of our investigations, that the absorption by the solar atmosphere cannot

exceed one-seventh of the radiant energy emanating from the photosphere.

5. Concerning the plan resorted to by the Director of the Roman Observatory, and others, of investigating the sun's image instead of adopting the method of *direct* observations, I will merely observe that the information contained in the several works of the Roman astronomer furnishes the best possible guide in judging of the efficacy of *image investigation*. Let us select his account of the investigations conducted between the

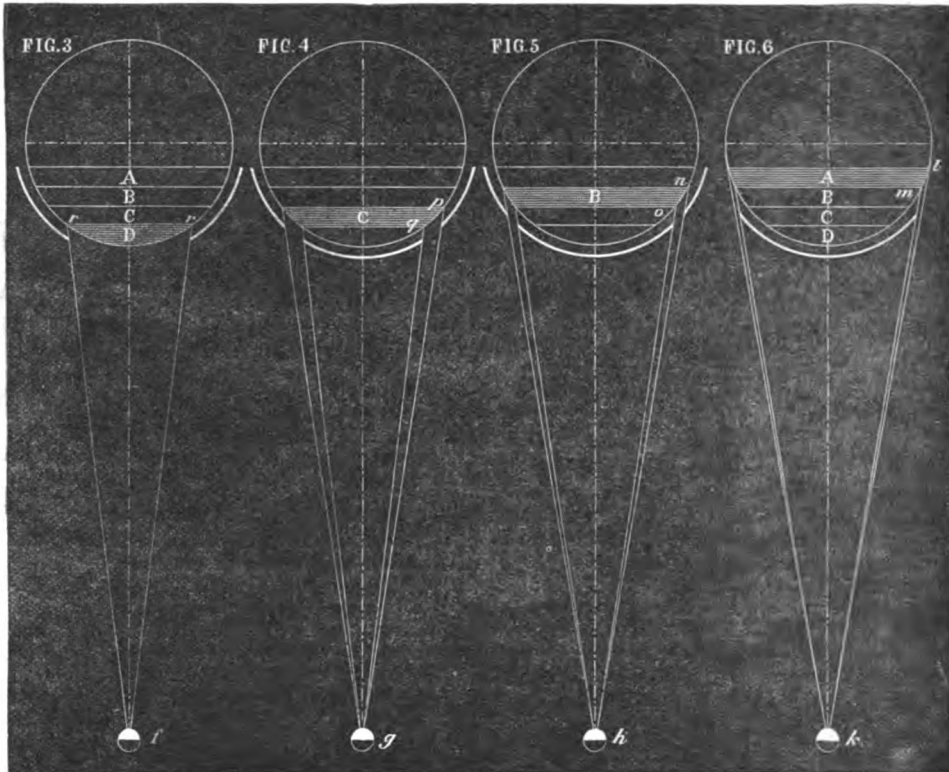

19th and 23rd of March, 1852. Having pointed out that in these experiments it was impossible to approach within a minute of the edge of the sun, and that during a later observation—date not mentioned—he had approached within a minute, the investigator observes: “But at this extreme limit, even making use of the most accurate means of observation, we find difficulties which it is impossible to overcome completely.” In addition to this emphatic expression regarding the difficulties encountered, the author adds: “Moreover, it is impossible to study the edge alone, for the unavoidable motions of the image do not admit of its being retained at exactly the same point of the pile; we have therefore been unable to push the exactness as far as we hoped; and we have discontinued the pursuit of these researches, although the results obtained are quite interesting.” (See revised edition of

“Le Soleil,” vol. i. p. 205.) It is needless to institute a comparison between a system of which its founder speaks so despondingly, and one which enables us to push our investigations to the extreme limit of the solar disc, admitting of entire zones being viewed at once, instead of only small isolated spots.

J. ERICSSON

#### The Glow-worm in Scotland

THE Glow-worm is not uncommon on the Island of Cumbrae, Buteshire. I have seen it there occasionally for the last thirty years (see vol. xiii. pp. 188, 208). DAVID ROBERTSON  
Millport, Island of Cumbrae, Jan. 18

#### OUR ASTRONOMICAL COLUMN

STAR WITH SUSPECTED LARGE PROPER MOTION.—It would appear by a communication from Prof. Winnecke, Director of the Imperial Observatory at Strasburg, that the large proper motion exhibited by a comparison of Argelander's positions of the ninth magnitude star, No. 11237-8 of Oeltzen's catalogue (southern zones) with Taylor's observations at Madras in 1838 or 1839, to which reference was lately made in this column, does not really exist, there being evidently an error in Taylor's mean place for 1840 given at p. clxiii. of vol. v. of the Madras Observations. Prof. Winnecke finds that the differences of right ascension and declination between this star and Oeltzen 11226, are sensibly the same as at the time of Argelander's observations (1851), and the latter star is known to have but very small, if any, proper

motion. Taylor's star must therefore be struck off the list of cases of great proper motion lately given.

ATLAS—27 f PLEIADUM.—A very interesting observation was made at Strasburg on the occasion of the occultation of this star—a Struve's *difficillima*—on the 7th of the present month. As we recently stated, this star does not appear to have been seen double since the last Dorpat observation in 1830. On the 7th inst., however, Herr Hartwig observing at Strasburg with an excellent Fraunhofer, of 42 lines aperture, power 159, remarked that the star did not disappear instantaneously; after the principal mass of light had vanished there remained a luminous point for about six-tenths of a second, a circumstance which favours the duplicity of the object, notwithstanding the failure of recent efforts to divide it. It brings to our recollection Burg's observation of the

occultation of Antares 1819, April 13, when at emersion the star appeared to suddenly increase from one of the sixth or seventh magnitude to one of the first, a phenomenon no doubt attributable to the existence of the small companion on the parallel, preceding the principal star (NATURE, vol. xii. p. 308).—The next occultation of Atlas-Pleiadum, on February 3, will not be visible in this country, but may be well observed in the United States. The American Ephemeris gives the time of immersion for Washington; at the Observatory of Hamilton College, Clinton, N.Y., so actively conducted by Prof. Peters, the immersion takes place at 11h. 13m., and the emersion at 12h. 4m., Clinton M.T.

VARIABLE STARS.—In No. 2071 Dr. Julius Schmidt, of the Observatory, Athens, continues his elaborate researches on the three short-period variables U, W, and X Sagittarii, the periods of which are now given thus:—

	d.	h.	m.	s.
U Sagittarii ... ..	6	17	53	1.4
W = γ Sagittarii ... ..	7	14	15	34.1
X = 3 Flam. ... ..	7	0	17	42.5

So assiduously have these stars been watched by their discoverer, Dr. Schmidt, in the fine skies of his locality (little success could be expected to attend their observation in England), that he believes he has detected perturbations of the light curve or period in each instance, though not quite ten years' observations are yet upon record.

The following are Greenwich times of geocentric minima of Algol, according to Prof. Schönfeld's elements:—

1876. Feb. 2	h. m.	1876. Feb. 25	h. m.
5	18 37	25	17 11
8	15 26	28	14 0
11	12 15	March 2	10 49
14	9 4	5	7 39
17	5 54		

Similar times of geocentric minima of S Cancri, according to Prof. Schönfeld, are:—

1876. Jan. 29	h. m.	1876. April 14	h. m.
Feb. 17	13 46	May 3	10 54
March 7	13 2	22	10 12
26	12 19		9 31
	11 36		

RECENTLY-DISCOVERED MINOR PLANETS.—No. 152, discovered at Paris by M. Paul Henry on Nov. 2, has been named *Atala*, and for No. 157, the small planet, detected by M. Borrelly at Marseilles on Dec. 1, the name of *Dejanira* is proposed; elements of this planet have been calculated by M. Stephan. The following are first approximations to the positions of the ascending node, inclination, and periods of the newer minors, with dates of discovery:—

No.	Ascending Node.	Inclination.	Period in years.	Date of discovery, 1875.
150 ... ..	207 55	2 2	5.16	Oct. 18
151 ... ..	40 2	7 52	4.15	Nov. 1
152 ( <i>Atala</i> ) ... ..	41 29	12 10	5.54	Nov. 2
153 ( <i>Hilda</i> ) ... ..	228 20	7 45	7.84	Nov. 2
154 ... ..	37 35	20 49	5.78	Nov. 4
155 ... ..	40 16	8 52	{ Circular elements	Nov. 8
156 ... ..	246 11	7 29	5.29	Nov. 22
157 ( <i>Dejanira</i> )	62 25	11 50	4.16	Dec. 1

[Since the above was in type No. 158 is announced in the *Berlin Circular* and Leverrier's *Bulletin International*, as having been discovered at the Observatory of Berlin, by Herr V. Knorre, on the morning of the 5th inst., in R.A. 7h. 19m. 58s., and N.P.D. 67° 58'. Magnitude 11-12.]

THE NEW MUSEUM OF THE GEOLOGICAL SOCIETY

WHEN it was first announced to the Council of the Geological Society that the Government proposed to offer a suite of rooms in Burlington House in lieu of

the apartments the Society occupied in Somerset House, it was at once seen that the most formidable work the change involved would be the removal of the collections of minerals and fossils. The transference of the library, though an extensive one, would be a comparatively easy matter, but there is always the danger in the mere handling of fossils that they may be damaged. Besides this, the collection had gradually grown to such a size that it was evident the cost of the removal would be considerable. So far as the preparation of the rooms at Burlington House was concerned, the Government showed every desire to conform as far as possible to the wishes of the Council.

Some of the Fellows counselled that the whole collection should be offered to the British Museum or to the School of Mines Museum in Jermyn Street, on the ground that though in the early days of the Society it was of high value when it was the only museum that existed, it was now so far surpassed in magnitude by the national collections that it was practically of small value. Fortunately wiser counsels prevailed. There were in the museum, it was urged, many typical collections formed by the early leaders of geological science, which were bequeathed in illustration of papers they had read and work they had done. These collections, obtained by their own personal labour in the field, arranged and named in their own handwriting, were of historical value and had a European reputation, and ought to be religiously preserved by the Society. It was true that the integrity of some of the collections had been destroyed in the endeavour at one time to make one general collection illustrating the whole of England, and arranged in stratigraphical order; but in most cases the original labels and references to catalogues were preserved, and it was hoped it might be possible in the new buildings to regroup the specimens much as they were at first. It was therefore determined that the museum should be maintained, not as a general geological collection, but mainly as a repository of specimens referred to in papers, and that before the removal commenced it should be carefully weeded, so that in all cases where, through the accidental removal of a label or other causes, the history of any specimen had been lost, it should be discarded, but not until every effort had been made to try to ascertain any possible clue. This work has been carried out by Prof. Rupert Jones, aided by Mr. Woodward, the assistant curator. The accumulation of specimens had caused much crowding in the museum, and in such a case a certain amount of damage and loss of labels was almost inevitable. As a consequence of this weeding, many specimens have been omitted in the new arrangement, and the result has been to leave greater space for those that have a real historic value.

Like many other institutions of gradual growth, the history of this museum has never been written, and very few people, few even of the Fellows of the Society, know what it contains, for there never has been a printed catalogue. As the collections are the private property of the Society and are not open to the public, this perhaps has not been thought requisite.

Among the principal collections preserved which have now historic value, first in point of general interest should perhaps be mentioned the extensive series of fossils presented by Sir Roderick Murchison, from which were drawn the figures in his world-renowned "Siluria." The fossils figured in the papers by Murchison and Sedgwick in describing the structure of Wales and the Lake district are also there, so are the fossils that illustrated Murchison's description of Brora. The fossils connected with Webster's well-known paper of 1814, the first paper on the Tertiaries of Hampshire; most of those illustrating Fitton's celebrated paper on the "Strata below the Chalk" (1827); those belonging to Buckland and Conybeare's comprehensive paper "On the South-west of England" (1824) are all there. Large additions to the general col-

lection were also made by Dr. Mantell, Dr. Macculloch, and Mr. Leonard Horner.

It will be recollected that the Society was originated in 1807, at a time when mineralogy was a fashionable study, or at least when collections of minerals formed part of the "furniture" of the apartments of the Queen and many of the nobility. Collections of shells and of fossils were also fashionable, but they were valued only for their beauty or their rarity, and not for any knowledge of nature they afforded. For some time the young society seems to have followed fashion. Indeed, the value of fossil organic remains as giving a clue to the consecutive sequence and relative order of strata was then but just beginning to be understood. It was not till the end of 1799 that the first MS. table of the sequence from the Carboniferous beds upwards was constructed, and no map of the strata of England was published till 1815. The earliest MS. catalogue of specimens belonging to the Society, begun in 1808 or 1809, is labelled "General Catalogue of Minerals," and some of the early entries of organic fossils refer rather to the rock in which the fossil is imbedded; the presence of the fossil being but casually noticed, such as "limestone containing shells." These early collections of fossils illustrating the labours of the first geologists in using organic remains to trace the chronological sequence of beds, and to compile some chapters of the earth's history, have a profound interest, laying as they did the foundations of a science which has placed at rest many wild theories of the origin of the earth, and has, too, proved to be of such practical value. The first donation recorded is Feb. 5th, 1808, of specimens from St. Anthon's Colliery, Newcastle-upon-Tyne, by the Right Hon. Sir J. Banks. It would occupy too much space to mention all the collections that the Society has preserved, but among the donors are the well-known names of Sir Henry de la Beche, Sir Charles Lyell, Greenough, Warburton, and Sir Woodbine Parish. McEnery's collection that first brought Kent's Cavern into notice is there, and so is a splendid series of Daniel Sharpe's "Brachiopoda." The old red sandstone fishes presented by Lady Gordon Cumming are remarkable for their beauty as well as for the extent of the collection.

Many distinguished living geologists have private collections of their own; for example, the Earl of Enniskillen, Sir Philip Egerton, Prof. Prestwich, Mr. Searles Wood, Dr. Bowerbank, &c., which fully explains why their contributions are not so numerous as might be expected from the valuable work they have done. Prof. Phillips, though so energetic a worker, is not largely represented in the museum, for firstly York, and afterwards Oxford, had stronger claims on him. The same remark applies somewhat to the claims of the Woodwardian Museum on Prof. Sedgwick. As illustrating the geology of England generally, the Jermyn Street Museum and the British Museum are more useful, but as a record of early geological work the museum of the Society is unique.

The rearrangement of the foreign collections has not yet been completed, though it is in progress. Suites of specimens are to be seen there from all parts of the known world from which it has been possible for travellers to send them. These foreign collections are, to some extent, the result of contributions by officers in Her Majesty's services. Central Africa is not represented, but there are several collections from both coasts. For the future it is intended to add to the British collection only those specimens that are sent in illustration of papers read to the Society, but foreign specimens will be received as before.

Among the treasures of the museum, besides the rocks and fossils, there are the original drawings of Agassiz's "Poissons Fossiles," presented by the Earl of Enniskillen, the first manuscript geological map of England (1799), and the first table of strata, by W. Smith (1799).

The previous changes in the locality of the museum have

been as follows:—In No. 4, Garden Court, Temple, the first fixed habitation of the Society (June 1809), the collection was commenced. In June 1810 it was removed to 3, Lincoln's Inn Fields; in June 1816 to 20, Bedford Street; in the autumn of 1828, to Somerset House; at Somerset House it has remained till this last move to Burlington House.

#### CONDENSED AIR TRAMWAYS

FOR some weeks the North Paris Tramways Company has been trying on the line from Courbevoie to the Arc de l'Etoile a new system of locomotion, in which the motive power is compressed air. Some details of M. Mékarski's (the inventor) system are given in the *Revue Scientifique*. It is capable of considerable developments and of varied applications, since it has solved in a very satisfactory manner the double problem of the industrial production of air condensed to very high pressures, and of the storage of the air in reservoirs intended to discharge into a cylinder placed in any apparatus whatever, at any distance from the condensing pump.

The "Voiture Automatique" of M. Mékarski is characterised by the absence of an imperial and by a platform in front and another behind. This car carries the reservoirs of condensed air, the apparatus for distribution, and the cylinders. M. Mékarski places under the truck of the car the sheet-iron cylinders, which contain the condensed air; on the front platform is placed the distributing apparatus which the engine-man works; the two cylinders are placed, as in certain locomotives, outside the framework, horizontally, and act directly, by means of a crank, on the front wheels of the car. No doubt this arrangement might be advantageously modified; but the important point is the possibility of manufacturing compressed air in sufficient quantities to be of use as a motive power.

The condensing apparatus used by M. Mékarski consists of two pump-barrels of cast-iron, placed vertically, communicating respectively with two horizontal pump-barrels, in which move two pistons worked by a steam-engine. This is, in reality, a double condensing pump, the former bringing the air to the pressure of from ten to twelve atmospheres, and the second raising the pressure to twenty-five atmospheres. The pistons act upon a mass of water which compresses the air directly and absorbs by degrees the heat disengaged by compression. By an ingenious contrivance the supply of water is continually renewed, and the temperature thus kept down. But this arrangement does not absorb a sufficient amount of the heat disengaged, a difficulty which M. Mékarski has met as follows. The external air drawn into the pump raises a valve constantly covered by a layer of water of several centimetres; besides, a large cast-iron tube, constantly traversed by the air already condensed and the excess of water, communicates with the two vertical pump-barrels; finally, the second pump is fitted with a tap by which the heated water escapes.

In M. Mékarski's automatic car the compressed air is stored, under the truck, in sheet-iron reservoirs or cylinders. The total capacity is about 2,000 litres; 1,500 litres serve as an ordinary supply; 300 litres constituting a reserve; the remaining 200 litres are intended to serve as a brake. The air is compressed in the cylinders to the pressure of twenty-five atmospheres. On the line from Courbevoie to the Arc de Triomphe, 7,500 metres going and returning, the resistance is unusually great. In one experiment the ordinary feeding cylinders contained 1,500 litres of twenty-five atmospheres at departure, and the pressure, on arrival, was not more than four and a quarter atmospheres. The expenditure had thus been about 1,250 litres at twenty-five atmospheres for a run of 7,500 metres, or 166 litres per kilometre.

But unless it is possible to heat the air gradually



during its detention, and before it reaches the cylinder, unless, in fact, the heat abstracted in condensation be restored to it, the loss of power is very great. This has hitherto been the stumbling-block of compressed air engines, and M. Mékarski seems to have completely met the difficulty. He adopts as a re-heater a cylinder holding about 100 litres of water, taken from the boiler of an engine, at five atmospheres, and to obtain the maximum of effect possible, the condensed air is delivered from the reservoirs to the cylinder only after traversing the entire mass of water.

By a clever contrivance M. Mékarski regulates at pleasure the action of the compressed air upon the piston. Two hermetically-closed boxes are placed vertically upon the re-heater; their common face is formed by a caoutchouc diaphragm, in direct connection with an obturator, which opens or shuts more or less the opening which communicates between the lower box and the chamber containing a mixture of compressed air and vapour in the upper part of the hot-water cylinder. It will be seen that this orifice will be more or less uncovered according as the pressure in the lower box will be above, or not, the pressure in the lower box. This second box is itself filled with air, and constitutes a small pump-barrel, in which a large plunger piston works. The rod of the piston is a screw, and is fitted outside with a small regulator, on which the driver works. This may rapidly be made to vary the presence of the air in the upper box, and consequently the pressure be increased or diminished of the air which is delivered from the lower box to the motory cylinder.

#### THE GREAT TELESCOPE OF THE PARIS OBSERVATORY

WE have from time to time noted the progress of the great telescope which for years has been in course of construction for the Paris Observatory, and now that it is completed and in its place we are glad to be able to present a view of the instrument, for which, and for the details which follow, we are indebted to *La Nature*.

In 1855 M. Le Verrier purchased in England two large discs, the one of flint and the other of crown glass, intended to form the material for an object-glass. The late Léon Foucault, the eminent physicist of the Observatory, was charged with the investigation of the processes which should be employed to cut these large glasses, whose dimensions were much greater than those to which opticians had been accustomed. It is known how Foucault was led, by his series of investigations, to make mirrors of silvered glass. Successive attempts enabled him to present French observatories with reflectors of 40, of 50, and finally of 80 centimetres in diameter, having a tube in length only six times the diameter of the mirror. The largest of the telescopes constructed by Foucault himself, of 80 centimetres aperture, is at Marseilles, under the care of M. Stephan; by means of it this astronomer has seen all that Herschel saw with his enormous metallic reflector of 1'45 m. diameter, all that Lord Rosse has been able to see with his leviathan of 1'70 m., and he has added hundreds of new nebulae to the list given by his illustrious predecessors.

To crown his labours, L. Foucault wished to construct the largest mirror which it would be possible to make by his admirable method. This superior limit is 1'20 m. diameter. M. Le Verrier caused to be cast at St. Gobain a block of glass weighing 700 kilogrammes, which was rough-ground and shaped in the workshops of MM. Sauter and Lemonnier. But to construct this telescope, with its tube of 16 metres in length, required special funds, the ordinary budget of the Observatory not being sufficient. M. Le Verrier sought to obtain them from the Corps Législatif, which, in 1865, voted a sum of 400,000 francs.

By the beginning of 1868, Foucault, notwithstanding

his researches on regulators and the fatigue caused by the active part he took in the Exposition of 1867, had prepared the plans for the large reflector, when death snatched him from his work, and deprived France of one of the most original and finest geniuses she has possessed. This fatality, and the troubles which soon after and for long disturbed the Observatory, seemed to have lost to the country the work of years, and to have rendered useless the liberality of Government. Happily, the Minister of Public Instruction, M. Duruy, was willing to lend an attentive ear to the suggestions of men of science, and place at their service an intelligence eager for progress. At the request of the friends of Foucault he ordered the work which had been begun to be continued, and the authorities of the Observatory eagerly complied with his orders. An eminent mechanic, M. Eichens, indicated to M. Le Verrier by the Grand Prize in Mechanics which he obtained at the Exposition of 1867, and by his construction of large instruments for the Observatory, received the order for the construction of the telescope. M. Adolphe Martin, whom Foucault had instructed in his methods and associated with himself in his optical undertakings, was charged with the polishing of the mirror. Finally, M. Le Verrier entrusted to one of the astronomers of the Observatory, M. Wolf, the general superintendence of the work.

The construction ought to have been completed in three years. The war and the changes in the Observatory caused the work to languish, and it was not resumed with vigour until the return of M. Le Verrier as Director in 1873. At the commencement of 1875 the mirror was completed and tried upon terrestrial objects; M. Wolf had got a shelter constructed for the telescope and the staircase for the observer; finally, in the month of October, M. Eichens sent in the instrument complete in all its main details.

The total cost of the instrument and of the observatory amounts to 190,000 francs.

The illustration which we give represents the telescope in a position for observation. The wheeled hut under which it usually stands, a sort of wagon seven metres high by nine long and five broad, is pushed back towards the north along double rails. The observing staircase has been fitted to a second system of rails, which permit it to circulate all round the foot of the telescope, at the same time that it can turn upon itself, for the purpose of placing the observer, standing either on the steps or on the upper balcony, within reach of the eye-piece. This eye-piece itself may be turned round the end of the telescope into whatever position is most easily accessible to the observer.

The tube of the telescope, 7'30 metres in length, consists of a central cylinder, to the extremities of which are fastened two tubes of 3 metres long, consisting of four rings of forged iron bound together by twelve longitudinal bars also of iron. The whole is lined with small sheets of steel plate. The total weight is about 2,400 kilogrammes. At the lower extremity is fixed the barrel which holds the mirror; at the other end a circle, movable on the open mouth of the telescope, carries at its centre a plane mirror, which throws to the side the cone of rays reflected by the great mirror. The telescope is thus on the Newtonian system. That of Melbourne, so admirably constructed in England, is a Cassegrain telescope; the metallic mirror is pierced at its centre by an aperture which receives the eye-piece, a system so far advantageous that the observer always remains at the lower part of his instrument, and has to raise himself only a very short distance above ground, but less calculated perhaps to produce a perfect image than the Newtonian system adopted by Foucault.

The weight of the mirror in its barrel is about 800 kilogrammes; the eye-piece and its accessories have the same weight. Such is the load under which the tube of

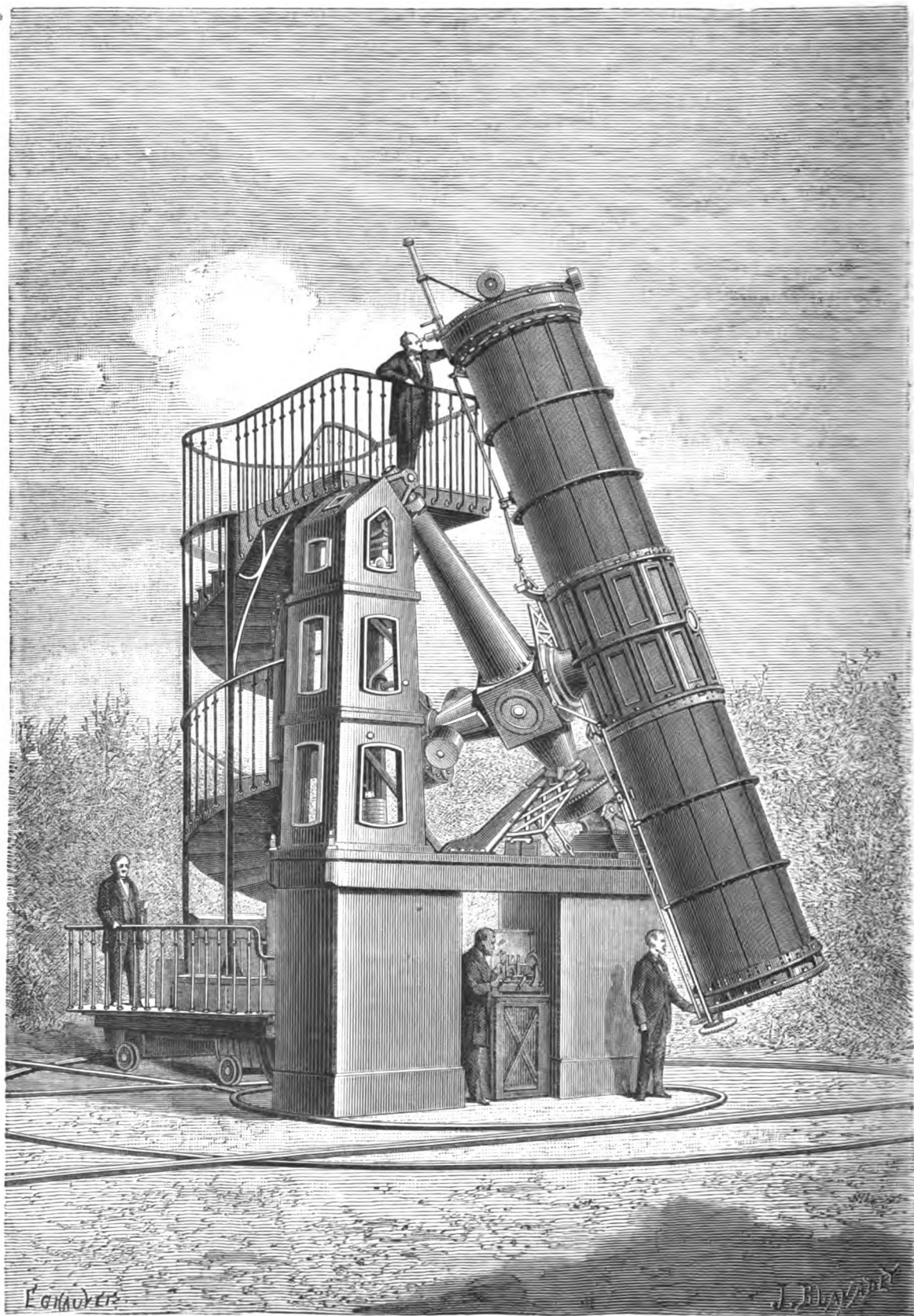

THE NEW TELESCOPE OF THE PARIS OBSERVATORY. (From a Photograph.)

the telescope, suspended by its centre, must not bend more than a millimetre in the most unfavourable positions, according to the calculations by which M. Wolf determines its dimensions. Experience has verified his calculations; the two mirrors remain exactly centred upon each other in all positions of the telescope.

It is necessary, however, to be able to direct the tube toward any point of the sky, and it is necessary, moreover, that when the star is once in the field of the instrument, that should be able to follow it, by a simple movement, in its apparent course through the heavens. This is accomplished by what is called the *equatorial* mounting of the telescope. This revolves on an axis, cast of iron and steel, whose direction is parallel to the axis of the celestial sphere. Then it may be inclined more or less on this axis, by turning round in a second axis of steel, which crosses the former at a right angle, and partakes in its movement of rotation. The whole of the arrangement of double axes, a veritable wonder of mechanism, from the precision and ease of the movement, weighs with the telescope 10,000 kilogrammes. Such is the mass which, like the hand of a gigantic chronometer, must follow with precision the march of the stars in the vault of heaven, obedient to the action of clockwork, controlled by a Foucault regulator.

To realise this wonder, M. Eichens had to put together the most delicate apparatus of the mechanics of precision, and, preserving their delicacy intact, give them the strength necessary to support great weights. We cannot explain in detail the series of these wonders, tell how friction is almost annihilated throughout, how all the parts are in equilibrium, whatever be the position of the telescope: how, in fine, at the same time that the instrument follows the movement of the sky, the observer may at his pleasure move it with perfect ease in all directions by means of contrivances placed at his hand.

The perfection of mechanism would be nothing if it did not serve the purpose of observing the stars with an optical apparatus of equal perfection. Let us at once say that the first attempts which have been made with the instrument have completely satisfied the astronomers. Not only has the mirror acquired, under the hand of M. Martin, the rigorously parabolic form which gives it the property of collecting in a single point the rays of a star, but the very complex eye-piece, by means of which the luminous point is observed, is itself without a single defect. It now only remains to silver the surface of the mirror, an operation at present easy, by the processes of M. Ad. Martin, and which will be accomplished in a large dish 1.30 metres in diameter. Meantime, the surface of the polished glass reflects sufficient light to make it possible to observe the most feeble stars; directed towards the moon, the telescope concentrates in the eye a light almost intolerable. It may be judged from this what will be the brilliancy of celestial images when the silvered mirror will throw upon the eye, not merely scarcely one-half, but more than nine-tenths of the light which it receives.

The comparison which we made above between the Marseilles telescope of 0.80 metre aperture and the most powerful instruments elsewhere, allows us to predict the results which science has a right to expect from a telescope whose mirror is greater by half, and whose mechanism has reached the latest limits of perfection. M. Wolf, to whom the use of the telescope has been entrusted, proposes to employ it in observing the planets and their satellites. At the same time the new telescope will be fitted with all the apparatus necessary for photography and the spectroscopic observation of the stars. It should be remembered, however, that the use of such a gigantic instrument requires a long apprenticeship; the Melbourne instrument had two observers before it came into the hands of an astronomer who knew how to make good use of it.

In a few weeks will be completed the first of the great instruments promised to France by M. Le Verrier and Foucault. The construction of the telescope has been undertaken first, that it may serve as a study for the construction, much more delicate, of the great refractor of 16 metres in length, with an object-glass of .75 metre aperture. The success of the reflector is a guarantee that M. Le Verrier, with his eminent colleagues, will accomplish satisfactorily the second part of his great and patriotic enterprise.

#### THE LOAN EXHIBITION OF SCIENTIFIC APPARATUS AT SOUTH KENSINGTON

ON the 3rd inst., as we have already intimated, Her Imperial Highness the Crown Princess of Germany invited to her palace forty of the representatives of science of Berlin, to lay before them the plan of the London Exhibition of Scientific Apparatus, and to ask their co-operation for this purpose. Amongst those honoured by invitations were the Ministers of Education and of Commerce, the Postmaster-General, and the following professors of the University:—M. Braun (botanist), Dove, Helmholtz, and Kirchhoff (physicists), Du Bois-Reymond (physiologist), Kiepert (geographer), Förster (astronomer), Peters (zoologist), Kronecker (mathematician), Websky (mineralogist), Hofmann, Oppenheim, and Sell (chemists), Wichelhaus (technologist), Orta (agriculturist); the following professors of the Polytechnic School:—M. Reulaux (mechanician), Liebermann (chemist), Vogel (photographer), and Scheibler (agricultural chemist); the director of the South Kensington Museum, Mr. Cunliffe-Owen, the directors of the German Industrial Museum, M. Gruner and Lessing, the manufacturers, Dr. Werner Siemens (member of the Academy), and Dr. Martius. The illustrious hostess, as well as His Imperial Highness the Crown Prince, pleaded warmly for the worthy representation of Germany in the London Exhibition. Although the short time left for preparation, and the coincidence of the exhibition with that of Philadelphia, were generally felt as serious drawbacks, some of the men of science present taking the lead assembled the following day, when a general committee was formed under the presidency of Dr. A. W. Hofmann; with the view of forming special committees for the different branches of the exhibition, and of inviting one member of every German University and Polytechnic School to co-operate with them. An invitation to the men of science and the manufacturers of scientific apparatus has already been issued.

"Science," the invitation says, "being the common property of all nations, the exhibition of the appliances by which it is promoted partakes of an international character. The objects pursued by the English Commission in organising the Exhibition have in Germany also been recognised as worthy of attainment, and, in order to give an impulse in our Fatherland to German participation in the Exhibition, a Committee has been formed, at the special instance of the Crown Prince and Princess of Germany, which has been intrusted by the English Commission with the collection and selection of objects worthy of being exhibited."

The invitation then proceeds to detail the conditions of exhibition settled by the Science and Art Department, and concludes as follows:—

"The Exhibition of Scientific Apparatus in London essentially differs from the former Exhibitions, as it pays less regard to merely commercial interests, but keeps in view the higher aim of disseminating as widely as possible the knowledge of the different methods of science. In order to render full justice to this task, the British Government (Science and Art Department) will bear all the costs of packing, sending, and returning any objects that may be confided to its care."

The Minister of the Admiralty has promised to send every instrument which should appear suitable for the purpose. The Committee of the German Chemical Society have elected superintendents to procure a worthy representation of chemical apparatus and specimens of chemical compounds of scientific interest. It has been decided to address an invitation to the members of the society to send such specimens to Berlin, in order to form a systematical and uniform collection of rare and interesting chemicals.

We may state generally that the Governments of Belgium, France, Germany, Italy, the Netherlands, and Switzerland, have now appointed committees to act in concert with the general committee in London. The Government of the United States has, through Mr. Fish, intimated that it is in communication with the various Departments and Scientific Institutions, with the object of forwarding the Exhibition.

### BEATS IN MUSIC\*

#### II.

THE second kind of beat differs from the first in that it arises from the imperfection, not of unisons, but of wide-apart consonances, such as the third, fourth, fifth, sixth, and octave.

This beat is well known practically to organ tuners, and may be soon rendered appreciable to any musical ear. Taking the fifth as an example, let the two notes

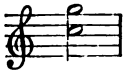

be sounded on an organ, or any instrument

of sustained tones. If they are perfectly in tune, the united sound will be smooth and even; but if one of them be sharpened or flattened a little, a beat will be heard just as in the case of the imperfect unison; and which, like it, will increase in rapidity as the note is made more and more out of tune. That this is not the same beat as Tartini's is obvious from the failure of the rule for the latter when applied to the former; for example, when the concord is in tune the upper note vibrates 768, and the lower one 512 vibrations per second, therefore there ought to be 256 beats per second; but in reality there are no beats at all, they only begin when the notes are put out of tune; hence the Tartini-beat rule is useless and inapplicable in this case.

This beat may be called the *consonance* beat, and it has also been termed "Smith's beat," from its having been first investigated by him.

The theory of Smith's beat, as given by Smith himself, is complicated and difficult to describe; but we will endeavour to give some idea of its nature and cause.

We must return to the illustration of the coffin-makers. Suppose one of them to have sold his business to another man in the trade, who was so much more active and energetic that he could drive his nails half as fast again as ordinary workmen. Call him A, and suppose that when he began to work it was found that he struck exactly three blows to two of his neighbour B. As B struck 100 per minute, A will now strike 150. And assume that on a certain day they both begin exactly together. The passer-by will hear that every third blow of A exactly coincides with every second of B; so that he will notice fifty coincidences in a minute; or to describe them more correctly, he will notice per minute fifty *phases of compound effects*, in each of which there is a coincidence. This phase constitutes *Tartini's beat*, but now very much augmented in rapidity from what it was before: then there were only one or two coincidences per minute, now there are fifty.

Now suppose that A, from some slight exhilarating

cause, begins to strike a little faster; *i.e.* that he makes 151 blows in a minute instead of 150. Let us endeavour to find out what will be the result on the listener. Still supposing the two strokes to begin with a coincidence, the third blow of A will still coincide *very nearly indeed* with the second of B; it will only differ from it by  $\frac{1}{1500}$  of a minute, a quantity inappreciable to the ear. Hence the Tartini phase will at this time be practically unharmed. But after a few repetitions the divergence of the blows will be so great as to become appreciable, and the listener will begin to notice a series of *changes of form* of the Tartini phase, in which there is now *no coincidence* of the blows, but only a variation of their arrangement, which, moreover, is itself constantly varying. After a time, however, these changes will exhaust their possible varieties, the listener will notice that two of the blows begin to approach again, and at last will *coincide*, as they did before. He thus notices a *long cycle* of the Tartini beats, and this long cycle is the *Smith's beat*. It is, in fact, a beat of what mathematicians would call the second order; the first, or Tartini's beat, is a cycle of differing periods; the second, or Smith's beat, is a cycle of differing cycles.

Let us next attempt a numerical estimation of the length of this second cycle in the case of the coffin-makers. To effect this we must inquire when the coincidences of two blows will recur. It is plain that they will recur at the *end of the minute*, *i.e.* if the first blow of A coincided with the first of B, then the 151st of A will coincide with the 100th of B. This will give one long cycle, or one Smith's beat, per minute. A careful comparison of the times of the respective blows will show, moreover, that (since 100 and 151 are prime to each other) there will be *no other* exact coincidence during the minute; and a hasty reasoner may conclude that one beat per minute will be the proper number. But if the listener be asked to describe what he hears, he will dissent from this and say confidently that there are *two* places in the minute where he hears a coincidence. To test his assertion, let us apply Young's principle mentioned before, and inquire whether in the course of the minute there is any other place where the blows *so nearly* coincide that the ear may mistake them for real coincidences. The 74th blow of A will occur at  $\frac{74}{151}$  of a minute after starting, whereas the 49th blow of B will occur at  $\frac{49}{100}$  of a minute. The difference between these is only  $\frac{1}{15100}$  of a minute, which is quite inappreciable. Hence, practically, there will be two parts of the minute where the blows coincide, and there will be consequently two Smith's beats in the same time.\* If we were to suppose A to make 152 blows per minute (or 148, for a deficiency would produce the same result as an excess) to B's 100, we should, calculating on the above plan, find *four* cycles or beats per minute. Or we may alter the proportion: suppose for example, A, intending to make five blows to B's four, makes really 126 per minute instead of 125 as he ought to do; it will be found by calculation that there will be *four* places of coincidence in the minute, or four Smith's beats; if he strikes 127 blows, there will be eight Smith's beats—and so on.

We hope the foregoing homely illustration will help to render clear the nature of the Smith's beat as applied to sounds. Although the Tartini beat may not be really converted, as Young supposed, into the Tartini harmonic, but, according to Helmholtz, remains as a beat, inappreciable by reason of its great rapidity, it certainly has a physical and mathematical existence; and it as certainly changes its phases by reason of the small divergence of the times of vibration from those due to the true concord, and it is the recurrence of similar phases in a long cycle

\* Mr. De Morgan, in his admirable paper elucidating Smith's profound investigation, unfortunately omits to notice this important element of the *approximate* coincidences. The consequence is that his explanation is not easy to follow, and indeed would *appear* wrong, although his results are perfectly correct.

\* By W. Pole, F.R.S., Mus. Doc. Oxon. Continued from p. 214.

which gives rise to the phenomenon in question. Smith contrived, with profound ability, to account for and calculate the beat independently of the Tartini beat, or whatever it may be called, but the introduction of this by De Morgan has wonderfully simplified the comprehension of the thing.

The accurate rule for finding how many beats per second will result from the concord being any given quantity out of tune; or for finding how much out of tune any concord is when it makes a certain number of beats per second, is remarkably simple.

Let  $n$  represent the denominator of the fraction, expressing, in the lowest terms, the true ratio of the concord (e.g. for the fifth  $\frac{3}{2}$ ,  $n = 2$ ; for the minor sixth  $\frac{8}{5}$ ,  $n = 5$ , and so on); then let  $q$  = the number of vibrations per second either in excess or deficiency of the number which would make the interval perfectly in tune; also let  $\beta$  = the number of Smith's beats per second:

$$\begin{aligned} \text{then } \beta &= nq, \\ \text{or } q &= \frac{\beta}{n}. \end{aligned}$$

A few examples will show the easy application of these

formulæ. Take the concord of the fifth, 

When this is true the upper note should make 768 vibrations per second to 512 of the lower one; but if it is tuned by equal temperament the upper note will be slightly flat, making 767.15. Hence  $q = 0.85$ ; and as  $n = 2$ , we shall get  $\beta = 1.7$ , i.e. there will be 102 Smith's beats per minute.

Again, suppose we find the concord of the major third

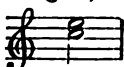
 give 120 beats per minute (= 2 per second),

how much is it out of tune? As in this case  $n = 4$ , we have

$$q = \frac{\beta}{n} = \frac{1}{2};$$

i.e. the upper note vibrates half a vibration per second either more or less than it ought to do.

The number of beats per second due to imperfections in the various consonances will be as follows,  $q$  being always the number of vibrations by which the upper note is untrue:—

*Tartini's Beat.*

For the unison ... ..  $\beta = q$ .

*Smith's Beats.*

For the unison or octave	...	...	...	...	$\beta = q$ .
"	"	fifth	...	...	$\beta = 2q$ .
"	"	fourth	...	...	$\beta = 3q$ .
"	"	major third	...	...	$\beta = 4q$ .
"	"	minor third	...	...	$\beta = 5q$ .
"	"	major sixth	...	...	$\beta = 3q$ .
"	"	minor sixth	...	...	$\beta = 5q$ .

In the case of the *unison*, the Tartini beat and the Smith beat are synonymous, and this identity is the reason why so many writers on beats have gone wrong; they have so often taken unison sounds as the easiest and simplest for popular illustration, and have either assumed, without further investigation, that the same principles would apply for other consonances also, or have omitted notice of the other consonances altogether.

It will now be easy to understand why beats are capable of such great utility in a practical point of view—namely, as giving a means of measuring, with great ease and positive certainty, the most delicate shades of adjustment in the tuning of concordant intervals. To get, for example, an octave, a fifth, or a third perfectly in tune, the tuner has only to watch when the beats vanish, which he can observe with the greatest ease, and which will give him far more accuracy than he could possibly get by the ear alone. Whereas if he desires to adopt any fixed

temperament, he has only to calculate the velocity of beats corresponding to the minute error which should be given to each concord, and the required note may be tuned to its proper pitch with a precision and facility which would be impossible by the unaided ear.

The delicacy of this method of tuning would hardly be believed, if it did not rest on proof beyond question. To recur to our example, the difference between 95 and 100 beats per minute would be appreciable by anyone with a seconds watch in his hand; and yet this would correspond to a difference of only  $\frac{1}{24}$  of a vibration per second, or in pitch less than  $\frac{1}{1000}$  of a semitone!

This use of beats has been long practised by organ-tuners to some extent, but its capabilities, as amplified by the aid of calculation, are certainly not appreciated or used as they ought to be.

The third kind of beat is what we may call the *overtone* beat, and was brought into prominent notice in 1862 by Helmholtz, who uses it for important purposes in regard to his musical theories.

It is known that nearly all musical sounds are compound; they consist of a fundamental note, which is usually the strongest (and by which the pitch of the note is identified), but which is accompanied with several fainter and higher *harmonic* notes, or, as Helmholtz calls them, *overtones*. The first of these is an octave above the fundamental, the second a twelfth above, the third a fifteenth, the fourth and fifth seventeenth and nineteenth respectively, and there are others still higher which we need not mention here. The number and strength of the overtones vary for different kinds of sounds, but the five lowest ones are very commonly present and distinguishable. Now, suppose we sound two notes, having such a relation to each other that any of the overtones of one will come within beating distance either of the other fundamental, or of any of its overtones, then a beat will be set up, which is the kind of beat now in question.

A few examples will make this clear. The bass fundamental C shown by a minim in the following example,

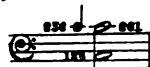
has its overtone  an octave above, as

shown by the crotchet. Now if another fundamental C be sounded an octave above the former one, as the second minim, and if it be a little out of tune, there will be a unison beat between it and the overtone of the first note. This is one of Helmholtz's beats, and the simplest of them.

Again, take an interval of a fifth; the fundamental notes being shown in minims in the following illustration, and their respective overtones in crotchets:—



Here, if the G is not a perfect concord with the C, the two G's in the treble staff will be also out of tune with each other, and a unison beat will ensue. This is another Helmholtz beat, and a little more complex than the last, as both the beating notes are overtones.

Again, take an interval of a major third, expressing the notes and such of their respective overtones as we require in the same way as before, thus:—

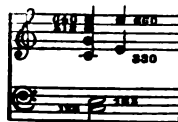

Here, if we suppose the fundamental E to vibrate 165



instead of 160, *i.e.* five vibrations too sharp, the two upper E's in the treble staff will clash, and a beat will result.

In all these three cases Smith's beats also will naturally be present, and it is curious that in each case when we come to determine the rapidity of the beats, we find it come out the same, whether we calculate it by Smith's formula or by the unison beats of Helmholtz's overtones. We have added the vibration-numbers to the notes, to facilitate the calculation, and we find the number of beats per second to be—

For the imperfect octave	...	...	...	=	5
For the imperfect fifth	...	...	...	=	10
For the imperfect major third	...	...	...	=	20

each arising from a sharpness of five vibrations in the upper note of the concord.

Hence we may lay it down as a principle that in consonances slightly out of tune, the beat given by the two fundamentals on Smith's plan, and those given by the first corresponding overtones on Helmholtz's principle, are synchronous, and may be considered identical.

The two kinds of beats, however, must not be confounded, as their cause is so distinct. The Helmholtz beats arise from the overtones only, whereas Smith's explanation applies to the fundamental notes, independently of the overtones altogether.

Helmholtz notices (Ellis's translation, pages 302-3) that beats of consonances will occur when sounded by simple tones, but accounts for them in another and very ingenious way, namely, by calling in the aid of the *grave harmonics*, or, as he calls them, the *combination tones*.

Taking our first example of the octave consonance given above, when the two notes of 128 and 261 vibrations are sounded together, they will give rise to a combination tone of 123 vibrations, and this, clashing with the 128 note, will give beats at the rate of five per second.

For the next example, the consonance of the fifth, this explanation will not suffice, and Helmholtz has to resort to a cause of the second order, namely, the beat of a grave harmonic, not with an imperfect unison, but with an imperfect octave. Taking our former example, an out-of-tune fifth C and G, of 128 and 197 vibrations respectively; these two notes will give a combination or difference tone of 69 vibrations, or an octave below the C, but out of tune. Then Helmholtz says this lower C will beat with its imperfect octave, on account of a new or *second order of difference-tones* formed from them, as in the former case.

In a similar but still more remote way, Helmholtz accounts for the beats of other consonances, the fourth, third, &c.

Without questioning the sufficiency of these explanations, I must say they seem to me somewhat far-fetched, and less satisfactory than Smith's, which account for the beats by a more positive and direct method, without calling in the aid of any sounds but the simple fundamental ones. There is at any rate the satisfaction that whichever explanation be adopted, the numerical value of the number of beats per second comes out the same and agrees with the fact; so that in a practical point of view it is immaterial which explanation be adopted.

I have alluded above to one important practical use of beats, namely, in tuning; but there is another use of them, also very interesting, *i.e.* that they furnish a means of ascertaining the positive number of vibrations per second corresponding to any musical note. This may be done either by the unison or by Smith's beat, and I will give both methods.

For the unison beat:—Take two notes in unison on an organ, a harmonium, or other instrument of sustained sounds, and put one of them a little out of tune, so as to produce beats when they are sounded together. Let  $V$  and  $v$  represent the vibration numbers of the upper and lower notes respectively. Then by means of a mono-

chord it will be easy to determine the ratio  $\frac{V}{v}$ , which call  $m$ . Count the number of beats per second, which call  $\beta$ . Then, since  $\beta = V - v$ , we obtain the simple equation,

$$v = \frac{\beta}{m - 1}$$

which gives the actual number of vibrations per second of the lower note of the two.

The method of deducing the vibration-number from the Smith's beat was pointed out by Smith himself; but as this method, so far as I know, is not to be found anywhere, except buried under the mass of ponderous learning contained in his work; I give it here in a simple algebraical form. If  $\frac{m}{n}$  represents the true ratio of the interval,  $N$  the actual number of vibrations per second of the lower note, and  $M$  the same number for the upper one, the formula for Smith's beats becomes

$$\beta = \left(m - n \frac{M}{N}\right) N; \quad \text{or } N = \frac{\beta}{m - n \frac{M}{N}}$$

Now, as  $m$  and  $n$  are both known for any given concord, if we can tell by any independent means the actual ratio of the notes  $\frac{M}{N}$ , we may, by simply counting the beats, calculate the actual number of vibrations  $N$  of the lower note. If the interval is too flat,  $\beta$  must be +; if too sharp, it must be -.

The following example will show how this may be done. Let it be required to determine how many vibrations per

second are given by the note  on an organ.

Tune three perfect fifths upwards, and then a perfect major

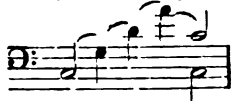
sixth downwards, thus— , which

will give the C an octave above the original note. But, by the laws of harmony, we know that this octave will not be in tune; the upper C will be too sharp, the ratio being  $\frac{81}{64}$ , instead of  $\frac{2}{1}$ , as it ought to be. Hence  $\frac{M}{N} = \frac{81}{64}$ ,

and  $\frac{m}{n} = \frac{7}{4}$ . Count the beats made by this imperfect octave, and suppose them = 192 per minute, or 3.2 per second; then, as the interval is sharp,

$$N = \frac{-3.2}{2 - \frac{81}{64}} = 128;$$

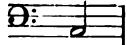
*i.e.* the note  is making 128 double vibrations

per second.

This method has the advantage of dispensing with the use of the monochord, which was necessary in the former case.

NOTES

A METEOROLOGICAL Commission, appointed by the Ministers of Public Instruction, Agriculture and Commerce, Marine, and Public Works, to inquire into the possibility and practicability of a more intimate co-operation being effected among the various meteorological systems of Italy, have just issued their report. The Commission consisted of fourteen members, including most of the well-known meteorologists of Italy, with Prof. Cantoni as president, and Prof. Pittel as secretary, and met daily at Palermo from Aug. 30 to Sept. 6, 1875. The more important of the conclusions arrived at are these:—That all methods of observing at the stations of the various systems connected with the State be



brought into accordance with those adopted by the Minister of Agriculture and Commerce; that harmonious action be based on the number, quality, and hours of the observations, a preference being given to those stations which from their position will best meet the requirements of local and international meteorology; that the instruments and modes of observing be strictly uniform; that inspection of stations be made at least once every two years, and that the reduction and publication of meteorological results be remitted to a directive council composed of meteorologists elected from the directors of the principal observatories and meteorological institutes, whose decisions will be carried out by a secretary and suitable staff.

At the meeting of the Paris Academy of Jan. 10, General de Nansouty submitted a report on the project of a physical observatory on the top of the Pic du Midi de Bigorre, Pyrenees. As our readers know, a small hotel on the Col de Secours has been provisionally used for observations since 1873, but amid great difficulty, from avalanches, cold, &c. The Pic is 2,877 metres high, and only 527 short of the highest, but is easily accessible.

THE Observatory on the Puy de Dôme is being rapidly completed, and will be opened this year. A semaphoric system of telegraphy will be used to keep the Observatory in constant communication with Clermont, the chief town of the district, at the foot of the mountain.

THE fourth part of the second series of Mr. William H. Edwards' work on the Butterflies of North America has just been published by Hurd and Houghton, and contains five quarto plates of butterflies, drawn with the utmost excellence by Miss Peart. The forms illustrated are species of *Argynnis*, *Grapta*, *Melitæa*, and *Papilio*, most of them new species recently described by Mr. Edwards himself.

AN addition to the list of American scientific journals has been made in the form of a *Botanical Bulletin*, edited by Mr. John M. Coulter, of Hanover, Indiana. At present it is a sheet of four pages, appearing monthly, with the promise of increase in size with increase in subscribers. It is in form and general scope much like the Bulletin of the Torrey Botanical Club.

DR. HOFMANN of Berlin has been elected a foreign associate of the Italian Society of Science in room of the late Sir Charles Wheatstone. This Society was founded in 1782; the Italian members are limited to forty, and at present the Society has only twelve foreign associates, among whom are Sir George Airy, Prof. Cayley, and Sir Edward Sabine. Its rules are numerous, and somewhat stringent.

THE Paris Academy of Sciences at Monday's sitting nominated Prof. Nordenskjöld a Correspondant in the section of Geography and Navigation.

THE Central Section, or governing body of the Geographical Society of Paris, has appointed as its president for 1876 M. Malte-Brun, the son of the celebrated Danish geographer.

THE Geological Society of Paris has elected as its president for 1876 M. Pellat, an amateur geologist, holding a high position in the finance department of Government.

THE warlike habits of the Papuans and their implements of warfare are described in a private letter recently addressed to Dr. Hooker. The writer says that no man leaves his dwelling for his bit of cultivation even without his powerful bamboo bow and a few deadly poisoned arrows. These poisoned arrows are only a few amongst a great number not poisoned, the former being distinguished by elaborate carving and painting, probably to prevent accident amongst themselves. They are each pointed and barbed with human bone brought to almost needle-like sharpness, most carefully and neatly finished; they are poisoned by

plunging in a human corpse for several days. Poor Commodore Goodenough and his men suffered from arrows so poisoned. It is a sort of blood-poisoning that, like other kinds of inoculation, does not develop itself for several days, the slightest scratch being sufficient to render almost inevitable a horrible death. The symptoms are accompanied by violent spasms like tetanus, with consciousness until the last.

CAPTAIN MORESBY'S work on New Guinea and Polynesia will be published shortly by Mr. John Murray. It will include discoveries and surveys in New Guinea and the D'Entrecasteaux Islands, a cruise in Polynesia, and visits to the pearl-shelling stations in Torres Strait of H.M.S. *Basilisk*, and will be illustrated by a map and wood-cuts. It will be interesting to compare this book of Captain Moresby's with Captain Lawson's "New Guinea," noticed in NATURE some time back.

M. E. QUETELET has called attention to the cold experienced in Brussels in December, 1875, when the temperature fell to freezing every night from 25th Nov. to 6th Dec., falling on the 2nd to 18°·5, which is lower than has occurred any time up to the 4th December, during the last forty-two years. In thirteen out of the forty-two years the temperature observations present a relation somewhat analogous to those of 1875. It is remarkable that with this low temperature and a persistent E.N.E. wind, the barometer has continued low and the air humid and constantly cloudy. On the 7th December the temperature fell to 5°·9.

PROF. F. W. PUTNAM, Dr. Packard's late colleague, the *Nation* announces, has been appointed Civilian Assistant on the U.S. Surveys west of the 100th meridian conducted by Lieut. G. W. Wheeler, and is already occupied in preparing a report on the abundant and very valuable archaeological and ethnological material collected by the exploration in Arizona, New Mexico, and California. The report will be profusely illustrated, and the *Nation* ventures to predict, will be the beginning of our scientific knowledge of the prehistoric civilisation of the above-named regions.

A CONVOCATION of the University of London was held on Tuesday, at which, after a long discussion, a resolution was passed affirming the desirability of obtaining a new charter, and declaring that no such charter would be acceptable to convocation which did not enable the University to grant degrees to women.

THE Ladies' Classes at University College, London, began on Monday last the second term of their eighth session. There was a slight decline in the number of students for the session 1874-75, but the first term of the session 1875-76 showed a considerable advance beyond the highest success hitherto attained. In the Michaelmas term, 1874-75, the whole number of individual students was 199; in the Michaelmas term, 1875-76, just elapsed, the number of individual students was 265. The whole number of tickets taken in Michaelmas term, 1874-75, was 257; in the same term of 1875-76 it was 367.

IN a paper on the Chalk in the Channel district read at the Paris Academy on Monday, Prof. Hebert stated that he expected great obstacles to be met with in the attempt to bore a Channel tunnel.

IT is announced that all communications and notifications in connection with the next International Congress of Medical Sciences, to be held at Geneva on Sept. 9, 1877, be sent to the Committee before June 1, 1876, the time when the Committee will definitely settle the regulations and programme, and appoint reporters. The present president is Prof. C. Vogt, and the secretary Dr. T. L. Prevost.

M. ADOLPHE PICTET, who died at Geneva on Dec. 20 last, at the age of 76 years, was one of the most eminent writers on

ethnology and comparative philology of the present century. In 1839, the French Institute awarded him the Volney Prize for his work on the affinity of the Celtic Languages with Sanscrit. In 1863, this same prize was awarded him a second time for the publication of his great work, "Les Origines Indo-Européennes, ou les Aryas primitifs." M. Pictet was also an eminent man of letters. He was a corresponding member of the Royal Society of Edinburgh.

AN ingenious toy, apparently of Japanese origin, has recently been introduced into London. It consists of a small picture, on paper, of an individual pointing a firearm at an object—bird, target, or second person. By the application of the hot end of a match, just blown out, to the end of the gun, the paper commences to smoulder towards the object aimed at, and in no other direction. When it is reached a report is heard from the explosion of a small quantity of fulminating material. The toys are sold in London by Mesdames Jinks and Ashton, of Glasshouse Street.

ABOUT midnight on the 22nd of December, 1875, two earthquake shocks were felt at Washington, Richmond, Weldon, North Carolina, U.S., and other places in that section. There were two distinct shocks at Richmond, the first continuing about ten seconds, while the other was briefer and not so severe, and was accompanied by a concussion in the air.

THREE distinct shocks of an earthquake are stated to have been felt at Comrie, near Crieff, Perthshire, on Sunday—two at about three in the morning and the third in the afternoon.

THE *Gazette d'Augsbourg* states that a commission which has been visiting the Russian Universities has laid its report before the Czar. The chief recommendations are to increase the salaries of some of the professors, and to create a few new chairs.

THERE are several important papers in this month's part of Petermann's *Mittheilungen*. The editor himself takes occasion, on the conclusion of the new edition of Stieler's fine Hand-Atlas, to give a brief history of that work, and to point out the great advances in geography since the last edition was published. The first part of a paper appears, giving some account of Przewalsky's travels in Mongolia and the land of the Tanguts during 1870-73. We believe the author's narrative of this important expedition is being translated into English; a map accompanies the article in the *Mittheilungen*. A translation from the Russian gives an interesting description of the ruins of Mestorjan, in the Turkoman steppes. Some account of the Paris Geographical Congress is given by the delegates from Perth's establishment. A valuable paper by Dr. G. Hartlaub describes the great amount of work done by that indefatigable traveller in China, the Abbé Armand David. Along with a brief summary of discovery in the interior of Australia there is a fine map, showing the routes of Warburton, Forrest, and Giles.

SUPPLEMENT No. 44 of Petermann's *Mittheilungen* contains the first part of a narrative of the expedition which, under the engineer Josef Cernik, in 1872-73, explored the region of the Euphrates and Tigris, for the purpose of estimating its industrial capacities, and to mark out a route for a railway. The narrative will be found to contain much valuable information on the various aspects of the region visited. We need hardly say the narrative is accompanied by admirable maps.

THE Japanese Government is said to have adopted a singular method for extending a knowledge of the Arabic numerals with their English names; these are printed on cloth, which is sold at a low price to the peasantry.

THE *Annuaire* of the Bureau des Longitudes for 1876 was published a few days ago with an unusual number of useful tables and a map showing the magnetic declination for all French towns.

M. WALLON, the French Minister of Public Instruction, has abolished the fees of the several examiners in the degree examinations in Law, Medicine, Science, Literature, and Theology. The salaries of the professors and fellows have been raised on a scale varying from 6,000 francs to 18,000 francs, the professors of theology excepted. It is believed that these reforms are preparatory to the gratuitous conferment of degrees, which will be instituted by the new assembly.

WE have received the "Transactions" of the Clifton College Scientific Society, vol. ii. part 1, including the period from Dec. 1872 to June 1875. There are a number of very fair papers, though it seems to us that the members generally need to be wakened up and urged to attempt to rival similar societies in some of our other public schools. The "Transaction," however, contain one paper which alone reflects great credit on the Society, and especially upon its author, R. A. Montgomery. The paper is on the Isle of Unst, in Shetland, and describes, from personal observation, its geology, natural history, antiquities, and scenery, in a manner which would entitle it to a place in the "Transactions" of a more ambitious society. The paper is illustrated by maps and section.

AN important publication has lately been commenced in the form of a Bulletin of the U.S. National Museum, consisting of a series of memoirs illustrating the collections of the museum. It is printed, by direction of the Secretary of the Interior, at the Government printing-office, from materials prepared by the Smithsonian Institution, which, as is known to our readers, has charge of the museum referred to. The first number of the *Bulletin* consists of a check list of the North American batrachia and reptilia, with a systematic list of the higher groups, and an essay on geographical distribution, as based on the specimens in the National Museum, and as prepared by Prof. Edward D. Cope, the well-known herpetologist and naturalist. The list of species is the first systematic enumeration of American reptiles since the time of Dr. Holbrook, and embraces 101 species of frogs, toads, salamanders, &c., 132 of serpents, 82 of lizards, 41 of turtles and tortoises, and 2 of crocodiles. Each species is accompanied by a reference to some work where it is described or figured. The list of the higher groups embraces those of the whole world, and will form a convenient basis for the arrangement of such collections in public museums.

THE scientific expedition, commanded by M. Mouchez for the survey of the coast of Algeria, will last ten months. During the latter part of the expedition M. Mouchez will resume the exploration of coral reefs, and will be accompanied by M. Lacaze-Duthiez.

MR. J. CLIFTON WARD has reprinted from the *Quarterly Journal* of the Geological Society his paper "On the Granitic, Granitoid, and Associated Metamorphic Rocks of the Lake District."

THE tenth edition of the Prospectus of Sir Joseph Whitworth's Schools for Mechanical Science has been issued, containing the papers set at the examinations in May 1875.

ON the 26th of November last, in the French island La Réunion, near Mauritius, a part of a mountain slipped down, seventy-two persons having been crushed by the falling rocks.

THE additions to the Zoological Society's Gardens during the past week include an Emu (*Dromæus nova-hollandiæ*) from Australia, presented by Mr. E. J. Dawes; a Palm Squirrel (*Sciurus palmarum*), a Manyar Weaver Bird (*Ploceus manyar*), two Nutmeg Birds (*Munia undulata*), two Amaduvade Finches (*Estrella amadava*) from India, presented by Mr. W. D. Baker; a Cinereous Sea-Eagle (*Haliæetus albicilla*), European, deposited.

## SCIENTIFIC SERIALS

THE current number of the *Journal of Anatomy and Physiology*—the second under the new system—commences with a paper by Dr. G. Thier and Mr. J. C. Ewart, entitled "A Contribution to the Anatomy of the Lens." The fibres of that organ are stated to be composed of a number of flattened bands, termed primary fibres, and to be covered with elongated flat cells resting on a structureless membrane.—Dr. McIntosh describes the central nervous system, the cephalic sacs, and other points in the anatomy of the *Lineidæ*, demonstrating that in the *Nemertean* the nervous system is highly developed, and that the cephalic sacs are special organs of sense, their internal surface being in direct communication with the surrounding water by the ciliated duct, whilst the fibrous peduncle places their cells in continuity with the central nervous system. The paper is profusely illustrated.—Prof. Rutherford, who has been assisted by M. Vignal, records his experiments on the biliary secretion of the dog. In almost every case the animal had fasted about eighteen hours. Under the influence of curare a tube was tied into the bile duct. The amount of bile which flowed in each quarter of an hour was measured. The cholagogue action of croton oil is shown to be *nil*; that of podophylline considerable; that of aloes powerful; that of rhubarb well marked; that of senna feeble; that of colchicum considerable, by making the bile watery; that of taraxacum very feeble; that of scammony feeble; that of calomel probably *nil*; that of gamboge *nil*; that of castor-oil *nil*. The memoir, with its valuable diagrams, deserves special attention.—Dr. Galabin contributes an article on the pulse-wave in the different arteries of the body. The author, we are glad to see, has modified his previous statement as to the modification of a double wave the result of a single impulse, in the explanation of the predicrotic undulation in the sphygmograph trace. He gives an explanation of this as well as of the predicrotic wave. Some of his arguments are, we think, based on too few facts, whilst others are complicated by their pathological nature.—Mr. D. J. Cunningham has some notes on the broncho-oesophageal and pleuro-oesophageal muscles of man, first described by Hyrtl.—Dr. Stirling contributes a memoir on the summation of electrical stimuli applied to the skin, in which, from an excellent series of experiments on the frog, he demonstrates, according to the view of W. Baxt, that reflex movements can only be liberated by repeated impulses communicated to the nervous centres.—Mr. F. M. Balfour commences a series of papers to ultimately constitute a monograph on the development of Elasmobranch Fishes. Commencing with the ripe ovarian ovum, its description is followed by that of the segmentation, in the volume before us. This monograph will be an invaluable adjunct to that on the hen's egg, by Dr. M. Foster and the same author, and is a most promising production of the Biological school of the University of Cambridge.—Prof. Huxley writes on the nature of the craniofacial apparatus of *Petromyzon*, a specially favoured region of that author. The plates are unfortunately delayed for three months.—Mr. S. M. Bradley has a note on the secondary arches of the foot.—Prof. Turner, lastly, gives a note on the placental area in the uterus of the cat after delivery, in which he shows that in delivery not all the mucosa of the placental area comes away, its deeper structures being partly left.—Prof. Turner and Mr. Cunningham's report on the progress of anatomy concludes the part.

*Archives des Sciences Physiques et Naturelles*, Oct. 15, 1875.—In this number is concluded an important paper by Prof. Lemström, of Helsingfors, on the theory of Aurora Borealis, *à propos* of some phenomena of Geissler tubes. The phenomenon from which he set out was that a Geissler tube is illuminated when near the pole of an electric machine, without the tube touching the poles. Air, at a pressure of 5 to 10 mm., acquires its maximum electric conductivity, and Prof. Lemström conceives the air in the upper regions of the atmosphere, rarefied to about 5 mm., as forming a great conductor concentric with the earth; its height some 3,000 kilometres less at the poles than at the equator, and the electric density (on both conductors) 9 per cent. greater, while the force with which the electricity of the atmospheric conductor is attracted to the earth is 42 per cent. greater (at poles than at equator). Thus there is accumulation of atmospheric electricity at the poles, and the auroras are produced on its combination with that of the earth. The theory regards aurora as a phenomenon entirely of our globe; but the possibility is not excluded of an action of the sun, causing a periodical variation of auroras, through meteorological phenomena, such as evaporation on the

earth's surface.—Prof. Schnetzler contributes some observations on Bacteria.—M. Cellerier investigates mathematically the simultaneous movement of a pendulum and its supports; and a *résumé* is given of the proceedings at the extraordinary session of the Geological Society of France, held in the end of August at Geneva and Chamounix.—In the "Bulletin Scientifique" there is a description of a curious phenomenon observed by M. Gumelius in Sweden, viz., intercrossing rainbows.

*Journal de Physique*, November, 1875.—This number contains the second part of M. de Romilly's paper on the conveyance of air by a jet of air or of vapour. He investigates the effects of the jet when driven against the lateral wall of the receiver, the orifices of the discharge-pipe and the receiver forming, if projected on a plane parallel to them, two circles exteriorly tangent. The form and separation of the two instruments are varied.—M. Angot, in another continued paper, gives a good account of Thomson's quadrant electrometer.—There are also short mathematical notes on the verification of the law of Huyghens, by M. Abrin; and elementary demonstration of the formula of La Place, by M. Lippmann, together with the usual amount of matter abstracted from other serials.

## SOCIETIES AND ACADEMIES

## LONDON

Royal Society, Jan. 6.—On the Expansion of Sea-water by Heat. By T. E. Thorpe, Ph.D., and A. W. Rucker, M.A. (Fellow of Brasenose College, Oxford), Professors of Chemistry and Physics in the Yorkshire College of Science.

The extensive contributions which have recently been made to the physical history of the ocean have shown the desirability of exact knowledge of the relations of sea-water to heat. The authors have accordingly made observations in order to determine the law of the thermal expansion of sea-water.

The only attempt hitherto made to solve this problem which can lay any real claim to consideration is due to the late Prof. Hubbard, of the United States National Observatory. The results of his investigation are contained in Maury's "Sailing Directions," 1858, vol. i. p. 237.

Muncke, nearly fifty years ago, determined the expansion of an artificial sea-water at various temperatures between 0° and 100° C.; but our confidence in the results as applicable to natural sea-water is affected by the circumstance that the solution was prepared from data furnished by the imperfect analyses of Vogel and Bouillon La-Grange.

The observations of Despretz were confined to temperatures below 13° 27', as the main object of his inquiry was the determination of the point of maximum density of sea-water. The subsequent investigations of Neumann and Rossetti were equally limited, as they were undertaken with the same view.

The water used in the authors' observations was collected from the Atlantic, in lat. 50° 48' N. and long. 31° 14' W.; and its specific gravity at 0° C., compared with distilled water at the same temperature, was found by the bottle to be 1.02867.

The method of experiment was precisely the same as that already employed by one of the authors in determining the expansion of the liquid chlorides of phosphorus. It was essentially that already used by Kopp and Pierre; *i.e.* the expansion was observed in thermometer-shaped vessels (so-called dilatometers), graduated and accurately calibrated.

Three of these instruments and two sets of thermometers were employed. The latter were made by Casella; the length of a degree in different instruments varied between 9 and 13 millims.; they had been compared (the one set directly, the other indirectly) with Kew standards.

Three perfectly independent sets of observations were made with the water in the state in which it was collected; but as Mr. Buchanan, of H.M.S. *Challenger*, has found that the specific gravities of different sea-waters lie between the extreme values 1.0278 and 1.0240, and since, in order to be of value in the investigation of the physical condition of the ocean, the observations on their value and the formulæ of reduction ought to be correct to the fourth decimal place, quantities of the sea-water were diluted with distilled water, so as to have specimens of approximately the specific gravities of 1.020 and 1.025; and a third quantity was concentrated by evaporation until its specific gravity was increased to 1.033; two series of independent observations were made on the expansion of each solution.

Empirical formulæ were calculated to express the results of

each series of observations; and in the original paper full details of the observations are given, together with tables, showing the agreement between the calculated and observed results, and also (after the necessary corrections and reductions have been made) between the volumes calculated from the formulae from different series of observations in the same solutions.

Finally, a general formula of the form

$$v = \phi(t) + \psi(t)f(s)$$

was found, giving the relation between the volume ( $v$ ), temperature ( $t$ ), and specific gravity at  $0^\circ$  C. ( $s$ ) of any solution of the same composition of sea-water the specific gravity of which at  $0^\circ$  C. lies between 1.020 and 1.033, the volume at the same temperature being taken as unity; in which expression

$$\phi(t) = 1 + .00008097t + .0000049036t^2 - .00000012289t^3,$$

$$\psi(t) = -10^{-4}(.5509t - .020198t^2 - .00033276t^3),$$

and

$$f(s) = 11.95 - 940(s - 1.02).$$

In the original paper it is shown that if  $\sigma$  be the specific gravity at any temperature  $t$  and of a solution the specific gravity of which at  $0^\circ$  C. is  $s$ ,  $\frac{d\sigma}{ds}$  may without sensible error be assumed to be constant; whence, by means of the above formula, the authors are able to give in a table all the data necessary for calculating the specific gravity of sea-water of any degree of salinity at any temperature between  $0^\circ$  and  $36^\circ$ .

The authors conclude by discussing the discrepancies which occur between their results and those of Prof. Hubbard; and they point out various circumstances in the methods employed in making and reducing the latter observations which appear to them to explain in a great measure the divergences which exist.

On the Action of Light on Tellurium and Selenium. By Prof. W. G. Adams, F.R.S.

A small bar of tellurium, an inch long, whose resistance was half an ohm, forming part of one of the resistances in a Wheatstone's Bridge, was exposed to the light of a paraffin lamp at a distance of half a metre from it. At first, on exposure, the heat from the lamp increased the resistance of the tellurium.

When a rectangular vessel of water was placed between the lamp and the tellurium there was found, on exposing as before, to be no perceptible change in the resistance. On removing the rectangular vessel and putting a cylindrical beaker of water in its place, so as to focus the light on the tellurium, the resistance of the tellurium was found to be diminished.

When it had been kept in the dark for several days the tellurium was much more sensitive to light. When exposed to the paraffin lamp the resistance of the tellurium was now found to be as much diminished without using the beaker of water as it had previously been when the beaker was used. On introducing the beaker of water between the tellurium and the lamp, the resistance of the tellurium was still further diminished, the change produced in the resistance by the exposure being  $\frac{1}{10}$ th part of the whole.

When the selenium bar was exposed to the same lamp at the distance of 1 metre, the change in the resistance was  $\frac{1}{4}$ th of the whole.

On exposing the selenium to a constant source of light at different distances, the change in the resistance of the selenium is *inversely as the distance, i.e.*, directly as the square root of the illuminating power.

The following results were obtained with one candle and an argand lamp, whose illuminating power is equal to sixteen candles:—

	At $\frac{1}{2}$ metre.	At $\frac{1}{3}$ metre.	At 1 metre.	At 2 metres.
With argand lamp	...	170	...	83
With 1 candle	...	41	...	18
With 1 candle	82	...	39	...
			18	8

These and other similar experiments clearly show that the change in the resistance of the selenium is *directly as the square root of the illuminating power.*

Mathematical Society, Jan. 13.—Lord Rayleigh, F.R.S., vice-president, in the chair.—Major J. R. Campbell, Mr. R. F. Scott, and Prof. H. W. Lloyd Tanner were admitted into the Society.—The following communications were made:—Mr. J. W. L. Glaisher, F.R.S., on an elliptic-function identity.—Prof. H. W. Lloyd Tanner on the solution of partial differential equations of the second order with any number of variables when there is a complete first integral.—Prof. Clifford, F.R.S., on free motion of a rigid system in an  $n$ -fold homoloid;

expression of the velocities by Abelian functions.—The following abstract of Prof. Clifford's paper will give some idea of the mode of treatment employed:—Equations corresponding to Euler's are obtained for the  $\frac{1}{2}n(n-1)$  rotations  $\mathcal{P}_{hk}$ ; these are  $\lambda_{hk}d_i\mathcal{P}_{hk} = \sum \mathcal{P}_{hi}\mathcal{P}_{ki}$  where the  $\lambda$  are expressed in terms of the  $n$  constants  $a$ , namely,  $\lambda_{hk}(a_h - a_k) = a_h + a_k$ ; it is understood that  $\mathcal{P}_{hk} = -\mathcal{P}_{kh}$ . It is then shown that similar equations are satisfied by quotients of  $\theta$ -functions of  $n-2$  arguments, one argument being  $a + e$ . The solution of the problem for the rotational velocities in  $n$  variables carries with it the determination of the position in the case of  $n-1$  variables; the co-ordinates of the principal points are thus expressed in terms of the combinations of  $\theta$ -functions which Rosenbain used for the inversion of integrals of the third class.—Lord Rayleigh, F.R.S., on the approximate solution of certain potential problems.

Royal Astronomical Society, Jan. 14.—Prof. Adams, president, in the chair.—A paper by the Astronomer Royal was read on the present state of his calculations for his new lunar theory.—Capt. Orde Browne read a paper on the times of the phenomena of the Transit of Venus. He compared the times given by the observers at the different Egyptian stations, and showed that the observations might be divided into three classes, in the first of which it seemed probable that the observers had noted as the time of internal contact the moment at which a *shadowy* ligament was first formed between the limbs of the planet and the sun. In the second class it appeared that the observers had noted as the time of internal contact the moment at which a *black* ligament, as dark or nearly as dark as the planet's disc, was first seen between the limbs of the planet and the sun; observers of the third class had waited for what he termed geometrical contact, or the moment when the discs of the planet and the sun appeared to have a common tangent. Mr. Burton said that the chief difficulty which he had experienced in noting the exact moment of internal contact at ingress arose from the bright line which was seen surrounding the dark limb of the planet before it entered upon the sun's disc, this prevented him from determining the moment when the solar cusps actually met around the disc of the planet.—Mr. Christie described a new form of solar eye-piece which he had devised. It consisted of a series of glass prisms placed between the eye-piece and the eye of the observer in such a manner that the light was reflected nearly at the polarising angle, and when the prisms were turned round relatively to one another, the intensity of the ray entering the eye could be adjusted with great nicety. The chief advantages of this plan were that by placing the prisms between the eye-piece and the eye the reflecting surfaces could be kept small and the eye-piece could be used as a photometer for comparing the intensity of very bright lights, as it was evident that the intensity of the reflected and emergent rays could be easily calculated directly the positions of the prisms were known.

Geological Society, Jan. 5.—Mr. John Evans, F.R.S., president, in the chair.—John Kenworthy Blakey, Frederick Hovenden, and Thomas Lovell, M. Inst. C.E., were elected Fellows of the Society.—The following communications were read:—Historical and personal evidences of subsidence beneath the sea, mainly if not entirely in the fourteenth and fifteenth centuries, of several tracts of land which formerly constituted parts of the Isle of Jersey, by Mr. R. A. Peacock, C.E.—In this paper the author brings forward a great number of details, derived in part from personal observations and in part from ancient documents, to prove that a considerable submergence of land has taken place round the island of Jersey within comparatively recent times. He referred principally to the existence of a submerged forest in the Bay of St. Ouen, evidenced by the existence of stumps of trees in the sea-bottom there, and by the traditional fact that up to quite a late period fees were paid for privileges connected with the forest of St. Ouen, although the forest itself had long previously disappeared beneath the sea. From the evidence it would appear that the submergence took place at the end of the fourteenth or the beginning of the fifteenth century. The author also noticed the occurrence of peat and submarine trees in the little bay of Grève de Lecq on the north side of Jersey, and especially referred to the evidence afforded by the Ecrehous rocks and Maitre Isle, there having been in the latter a priory or chapel, supported by rents derived from the parish of Ecrehous, which is now represented only by a small islet, with the ruins of an ecclesiastical building upon it, and a range of rocks protruding but little above the sea.—The physical conditions under which the Upper Silurian and succeeding Paleozoic Rocks were probably

deposited over the Northern Hemisphere, by Mr. Henry Hicks. In this paper the author, after pointing out the lines of depression explained in his former paper to the Society, now further elaborated the views then propounded by him by carrying his examination into the higher Palæozoic series and into more extensive areas. Beginning at the top of the Lower Silurian, where he first recognises any evidence of a break in the Palæozoic rocks, he proceeded to show that this break was restricted to very limited areas, and almost entirely confined to the parts which had been first submerged, and where the greatest thickness of sediment had accumulated on both sides of the Atlantic, and hence where the pre-Cambrian crust had become thinnest. On the European side this break occurred where volcanic action had taken place, and has doubtless to be attributed to the combined action of upheaval of portions of the crust and the heaping up of volcanic material, the latter in some cases forming volcanic islets of considerable extent. He strongly objected to look upon these breaks, even in the British area, where they are most marked, as evidence of a want of continuity over other and far greater areas; or to admit that even where there was conformity in the rocks at this point, "great intervals of time are indicated, unrepresented by stratified formations." The conformity found in extensive and widely separated areas is proof also that a gradual contraction took place of an enormous portion of the crust in the northern hemisphere in Palæozoic times; and the breaks at the close of the Lower Silurian and in the Devonian are not indications of an arrest in the general subsidence. After indicating the changes which must have taken place in the climate from this gradual spreading of the water and the evidence to be derived from the consideration of the deposits and the faunas, the author drew the following general conclusions:—1. That the condition of the northern hemisphere at the beginning of Palæozoic time was that of immense continents in the higher latitudes, traversed by mountainous ranges of great height, but with a general inclination of the surface, on the one side (European) to the south-west and south, and on the other side (American) to the south-east and south. 2. That these continents were probably covered, at least in their higher parts, with ice and snow; and that much loose material had consequently accumulated over the plains and deeper parts, ready to be denuded off as each part became submerged. This would account for the enormous thickness of conglomerates, with boulders, grits, and sandstones, found in the early Cambrian rocks, and also to a certain extent for their barrenness in organic remains. 3. That the depression over the European and American areas was general from at least the latitude of 30° northwards; that the parts bordering the Atlantic were the first to become submerged; the lower latitudes, also, before the higher. 4. That the depression could not have been less altogether, for the whole of the Palæozoic, than 50,000 feet; and that conformable sediments to that extent are found over those parts of the areas first submerged, and which remained undisturbed. That volcanic action was chiefly confined to parts of the regions which became first submerged; that the immediate cause of these outbursts was the weakness of the pre-Cambrian crust at those parts, from the great depression that had taken place, it being too thin there to resist the pressure from within, and to bear the weight of the superincumbent mass of soft sediment. 5. That the seat of volcanic action at this time was at a depth of probably not less than twenty-five miles, as sediments which were depressed to a depth of from nine to ten miles do not indicate that they had been subjected to the effect of any great amount of heat, and are free from metamorphism. 6. That the climate at the early part of Palæozoic time was one of very considerable, if not extreme cold, and that it became gradually milder after each period of depression. That towards the close of the Palæozoic, in consequence of the elevation of very large areas, and to a great height, the climate became again more rigorous in character. 7. That the various changes which took place over the northern latitudes during Laurentian and Palæozoic times allowed marine and land life to develop and progress in those areas at interrupted periods only; consequently most of the progressive changes in the life had to take place in more equatorial areas, where the sea-bottom was less disturbed, and where the temperature was more equable. Any imperfection, therefore, in the Palæontological record belonging to these early times should be attributed to these and like circumstances; for wherever an approach to a complete record of any part of the chain is preserved to us, the evidence points unmistakably to an order of development, through a process of evolution from lower to higher grades of life.

Anthropological Institute, Jan. 11.—Mr. A. W. Franks, F.R.S., vice-president, in the chair.—Messrs. H. A. Husband, E. Croghan, J. B. Lyons, and W. R. Cornish were elected members.—Mr. W. S. W. Vaux, F.R.S., read a paper on the Maori race of New Zealand. There were three sources from which some information as to the origin of the Maoris might be gained. Firstly, from traditions, among which a very general and remarkable uniformity prevails, pointing to the conclusion that the ancestors of the Maoris came from the north and north-east in small numbers and a few at a time, the names of some of the canoes in which they arrived having been preserved. The author thought that the evidence in favour of those traditions was conclusive. Secondly, from their ethnology and customs. With regard to the former, appearances were at first sight in favour of a mixed origin, the diversities in physiognomy and colour being considerable; but to that view the author thought the linguistic evidence furnished an unanswerable objection. As to the customs of the Maoris, they did not differ much from those found in other groups of Polynesian Islands, indicating a former intimate connection between them all. Thirdly, from language. The general conclusion of the author from that argument was that there was one Polynesian language which had been broken up into many dialects, the Maori being one. That opened out the larger question as to who the Polynesians were, and it was in that direction that inquirers must search for the origin of the Maoris. Evidence finally pointed to Asia for the solution of the problem.—Dr. Hector, F.R.S., exhibited and described at length the collection of stone and other implements he had recently brought from New Zealand, and went minutely into the circumstances of their discovery, their varieties, and uses. He also entered into a discussion on the traditions of the Maoris, their population in the two islands, their manners and customs, their language and physique, drew a comparison between them and the Moriories, and treated of many other topics relating to the past history and present condition of the people.

Physical Society, Jan. 15.—Prof. Gladstone, F.R.S., president, in the chair.—The following candidates were elected members of the society:—Sir David Lionel Salomons, Bart., Arthur R. Granville, and Capt. Abney, R.E.—Prof. Woodward, of the Midland Institute, Birmingham, exhibited and described a novel form of apparatus for showing either the longitudinal motion of sound-waves or the transverse vibrations of those of light. It consists essentially of a series of balls suspended in a horizontal line by strings. These balls rest against a series of transverse equidistant partitions in a wedge-shaped horizontal trough, which can be raised and depressed parallel to itself. If, while a ball is placed against each partition, the frame be drawn aside in the plane in which the balls hang, and then slowly depressed horizontally, the balls will be successively liberated, the order in which this takes place being regulated by the heights of the partitions. As these gradually increase from one end to the other, the appearance presented is that of a series of condensations and rarefactions, as in the ordinary acoustic wave. If the frame be drawn aside parallel to itself prior to depressing it, the balls will rest against one side of the trough and can be liberated in succession, causing them to oscillate in planes parallel to themselves. By this means a vibration of the particles is set up resembling that of polarised light.—Prof. Guthrie suggested that Mr. Woodward should devise a similar apparatus for exhibiting stationary waves.—Prof. Woodward said he would remember the suggestion, and stated that he had endeavoured to adapt the apparatus to circular and elliptic wave-motion, but experienced considerable difficulty.—Mr. Lockyer then made a communication on some recent methods of spectroscopy. At the outset he mentioned that he brought these processes forward in the hope that others present might be induced to take up some branch of the work. The first subject of which he treated was the photographing of the solar and metallic spectra. Mr. Rutherford, of New York, who has produced some of the finest photographs of spectra extant, has shown that to obtain clear photographs the smallest possible portion of the surface of the prism should be employed. An excellent method for ensuring this is to bring the light on the slit by means of a common opera-glass (as large as possible), which should reduce the beam of parallel rays incident on the prism to not more than a quarter of an inch in diameter. Mr. Lockyer exhibited the four-prism spectroscope employed by himself, to which a camera about four feet long is adapted. By this apparatus a large series of comparisons has been obtained between the sun and metals, the slit employed being provided with five slides, so that the spectra can be

accurately arranged side by side. It is advisable always to observe the image of the electric arc when comparing the spectra of metals with that of the sun, rather than direct light. It is also found very advantageous to place the poles of the lamp at right angles to the slit, as by this means the long and short lines in the spectra are more sharply defined than when observed in the ordinary manner. In the photograph comparing the spectra of aluminium and calcium it is noticeable that certain lines are common to the two, but those which are thick in the aluminium spectrum are thin in that of calcium, and *vice versa*. This depends on the quantities of impurity present. It has thus been shown that there are no proper coincident lines in the spectra of any two simple substances, and that there is no substance spectroscopically pure. The relation between the lengths of the lines and the amounts of metals employed to produce the spectrum convinced Mr. Lockyer that it would be possible to employ the spectroscope for quantitative analysis. The earlier experiments in this direction were then referred to, as well as those on which Mr. Lockyer has recently been engaged in conjunction with Mr. W. Chandler Roberts, of the Royal Mint, with a view to ascertain how far it is possible to detect small differences of composition in gold-copper alloys such as that used for the coinage. The method employed was then described. It consists in measuring, by means of a micrometer in the eye-piece of a four-prism spectroscope, the relative lengths of certain gold and copper lines when the image of an induction coil spark passing from the alloy under examination is focussed on the slit. Although the results obtained have not been uniformly comparable, and therefore reliable, it is nevertheless certain that a difference of composition as minute as the  $\frac{1}{10000}$ th part is recognisable by this means. Another method of spectroscopic research which Mr. Lockyer next described was the study of the absorption spectra of metals when they are not subjected to so violent an action as that of the electric arc. Observations of this nature have been made at low temperatures by Roscoe and Schuster, and by Mr. Lockyer, and at the highest temperatures produced by the oxyhydrogen blow-pipe by the latter in conjunction with Mr. Roberts. These experiments, which have been fully described in the Proceedings of the Royal Society, show that the absorption spectra of metals may be divided into five classes, which, for any particular metals, depend on the amount of heat applied. They suggest that in passing from the liquid to the most perfect gaseous state, vapours are composed of molecules of different orders of complexity; and that this complexity is diminished by the dissociating action of heat, each molecular simplification being marked by a distinctive spectrum.—The President inquired whether the iridium line to which Mr. Lockyer had referred, and by means of which the metal was originally discovered, was absolutely identical with a hydrogen line.—Prof. McLeod asked if Mr. Lockyer had found that the incandescence of the air made any difference in the character of the spectra, and drew attention to the advantage of a small lens placed in front of the slit.—Mr. Woodward inquired whether any mechanical means were adopted for ensuring that the lamp gave a constant light while in the horizontal position.—Dr. Guthrie referred to the spectrum observed when light traverses the vapours resulting from the action of copper on nitric acid. He wished to know whether the number of bands observed stands in any relation to the number of possible oxides of nitrogen at a given temperature; or must one oxide of nitrogen be considered as being capable at that temperature of giving bright and dark bands according to the way in which the light acts on it?—Mr. Lockyer, in reply to the president's question, said that, so far, no difference has been observed between the refrangibility of the hydrogen line and that of iridium. He is anxious to ascertain whether any occluded hydrogen exists in the metal. Little or nothing is known as to the subject referred to in Dr. Guthrie's question. The use of the electric lamp eliminates all difficulty with reference to air lines, as its "atom-shaking" power is not sufficient to break up to the line stage the molecules of nitrogen and oxygen. It was found necessary to make the adjustments referred to by Mr. Woodward entirely by hand.

Victoria (Philosophical) Institute, Jan. 17.—On the Scientific Conclusions and Theological Inferences, in a recent work entitled "The Unseen Universe," was read by the Rev. Prebendary Irons, D.D., the Bampton Lecturer for 1870.

## PARIS

Academy of Sciences, Jan. 10.—Vice-Admiral Paris in the chair.—The following papers were read:—Experimental critique

on the formation of saccharine matter in animals, by M. Cl. Bernard; an *aperçu* of his researches on the subject.—Researches on aldehyde, by M. Berthelot. He measures the heat liberated in transformation of aldehyde into acetic acid, and into oxalic acid, the heat of vaporisation, &c.—Union of carburets of hydrogen with hydracids and halogenic substances, by M. Berthelot.—Micrometric measurements taken during the transit of Venus, by M. Mouchez.—On the causes of failure in searching for minimal quantities of iodine, by M. Chatin.—New considerations on the regulation of slide valves, by M. Leduc.—M. Mouchez presented some new maps of the coast of Africa.—Report on the project of a physical observatory on the top of the Pic du Midi de Bigorre, submitted to the Academy by General de Nansouty, in name of the Société Ramond. This peak (in the Pyrenees) is 2,877 metres in height, and only 527 short of the highest. It is somewhat isolated, and receives the direct shock of the great Atlantic air-currents; and it is easily accessible. A small hotel on the Col de Sencours (511 m. lower) has been provisionally used for observations since 1873, but amid great difficulty, from avalanches, &c.—Report on a memoir entitled "Problème inverse des brachistochrones," by M. Haton de la Goupillière.—Influence of tempering on magnetisation, by M. Gauguain. The bars hardened most are those which take the greatest magnetism, when one uses the most powerful means of magnetisation; but annealed bars are magnetised most powerfully where less energetic means are employed.—On the recent falling in on Bourbon Island, by M. Velain. The disaster was due to disaggregation of certain volcanic rocks under atmospheric agencies.—On a subterranean commotion in the centre of the isle of Réunion; disappearance of a hamlet of sixty-two persons, by M. Vinson.—On a pocket telemeter with double reflection, by M. Gaumet.—On the winter egg of *Phylloxera*, by M. Boiteau.—M. Carvalho presented a model of an ozonogenic apparatus, for rendering apartments wholesome in hot and unhealthy climates. It is a kind of condenser of the electric effluve. M. Thénard gave a warning on the poisonous action of ozone.—Generalisation of the theory of an osculating radius of a surface, by M. Lipschitz.—Note on a particular class of left decagons, inscribable by an ellipsoid, by M. Serret.—Note on the application of recurrent series to investigation of the law of distribution of primary numbers, by M. Lucas.—On the spectrum of gallium, by M. Lecoq de Boisbaudran. With chloride of gallium he gets two narrow lines,  $\alpha$  4170 and  $\beta$  4037.—On the decrease of sugar in beets during the second period of their vegetation, by M. Cosenwinder.—On the installation of the Meteorological Observatory of the Puy de Dôme, by M. Alluard. Observations (every three hours) were commenced on Dec. 20, 1875. A station on the plain, at Clermont, 9 kil. distant, and 1,100 m. under the summit, is supplied with the same instruments, and the two stations are connected telegraphically.—On the periodic movements of leaves in *Abies nordmanniana*, by M. Chatin.

## CONTENTS

	PAGE
THE "ENCYCLOPEDIA BRITANNICA." By Prof. A. GARROD . . . . .	221
FOSSIL BUTTERFLIES . . . . .	222
BURCHETT'S "PRACTICAL PLANE GEOMETRY" . . . . .	224
OUR BOOK SHELF:—	
Meteorology in Havana . . . . .	224
LETTERS TO THE EDITOR:—	
Blowpipe Analysis.—Major W. A. ROSS. . . . .	224
The D-line Spectrum.—Major W. A. ROSS . . . . .	224
The Difference of Thermal Energy Transmitted to the Earth by Radiation from different parts of the Solar Surface.—Capt. J. ERICSON. (With Illustrations) . . . . .	224
The Glow-worm in Scotland.—DAVID ROBERTSON . . . . .	225
OUR ASTRONOMICAL COLUMN:—	
Star with Suspected Large Proper Motion . . . . .	226
Atlas — 27 / Pleiadum . . . . .	226
Variable Stars . . . . .	227
Recently-discovered Minor Planets . . . . .	227
THE NEW MUSEUM OF THE GEOLOGICAL SOCIETY . . . . .	227
CONDENSED AIR TRAMWAYS . . . . .	228
THE GREAT TELESCOPE OF THE PARIS OBSERVATORY. (With Illustration) . . . . .	229
THE LOAN EXHIBITION OF SCIENTIFIC APPARATUS AT SOUTH KENSINGTON . . . . .	231
BEATS IN MUSIC, II. By W. POLE, F.R.S., Mus. Doc. Oxon. . . . .	232
NOTES . . . . .	234
SCIENTIFIC SERIALS . . . . .	237
SOCIETIES AND ACADEMIES . . . . .	237



THURSDAY, JANUARY 27, 1876

## GEORGE POULETT SCROPE, F.R.S.

YET another of the old lights of Geology gone from us!—one that shone out brightly more than half a century ago, and has kept its place and done its work even up to the last. At the ripe age of almost fourscore years, and with his faculties and sympathies still fresh and active, Mr. Scrope has passed away. Living his last years in the quiet retirement of his pretty country-house, he may be said to have taken some time ago his farewell of the scenes of his early scientific friendships. But that he kept up his interest in all his old pursuits was shown by his occasional letters on geological matters, which continued to appear until only a few weeks ago. The friends with whom he corresponded and who saw him from time to time in his retreat will not soon forget the eagerness with which he listened to every new fact in his favourite studies, and the friendly and large-hearted liberality with which he stimulated and assisted younger labourers in his own domain.

As far back as the winter of 1817-18 Mr. Scrope's attention was drawn to geological pursuits by the accident of his residence at that time in Italy when Vesuvius was in a state of constant eruption. Having leisure to indulge his taste, he gave himself up to the task of watching the progress of the Neapolitan volcano. He was led to extend his observations to the relics of older volcanic vents in the same neighbourhood, and in the following year spent some time among the Lipari Islands and in Sicily. Having now learnt a great deal both of existing and extinct volcanoes, he explored the old volcanic tracts lying to the north of Naples and west of the Apennines, and returned to England with a far larger experience of volcanic phenomena than any of his contemporaries possessed.

In this way he came to recognise how important a part has been taken by volcanic action in the past, as well as in the present, history of the earth. He was therefore naturally surprised to find views of a totally opposite kind not only in vogue, but advocated with a force and persistence which refused to consider volcanoes as anything more than modern and abnormal interferences with the settled order of nature, and as of no more real significance than subterranean coal-seams somehow set on fire. These dogmas of the Wernerian school had gained such an ascendancy that many staunch adherents of that school—men like G. B. Greenough, the founder of the Geological Society—seemed to regard volcanoes with a kind of personal dislike, and violently opposed any attempt to elevate them into important geological agents. Mr. Scrope, on his return to England, spent some time at Cambridge; and finding his views supported and encouraged there, among others by Sedgwick, he determined to give himself up to the study of a district of extinct volcanoes, where the phenomena to be observed bore close relation to those of the basalts and similar rocks of Britain and Germany, and where, nevertheless, manifest relics of true volcanic cones and craters existed. He selected for this purpose the marvellously interesting tract of Auvergne in Central France, and established himself there in the summer of 1821. A campaign of six months

made him thoroughly familiar with the volcanic geology of that region, and enabled him to bring home such a series of pictorial sketches and diagrams as could not, he felt, but carry conviction home to even the sturdiest Wernerian, that the basalt plateaux of Auvergne, instead of being portions of the universal precipitate of a primeval ocean, were in truth only fragments of lava-flows erupted at different times and at different levels in the gradual erosion of the valleys. He prepared a narrative of his researches, and an atlas of most admirable views and sections. But expensive geological works had not yet readily found either publishers or purchasers. He had, therefore, to keep his manuscript beside him for several years.

Meanwhile, however, the eagerness of his volcanic quest had by no means abated. Passing from his labours in France once more into Italy, his enthusiasm for volcanoes blazed out with renewed ardour in the autumn of 1822, when he had the good fortune to be an eye-witness of the great eruption of Vesuvius, which took place in the October of that year. His views of the general principles of volcanic geology had gradually broadened under the influence of the ample experience which he had now gained. He felt himself not only at liberty, but even called upon to put these views clearly before the world as a contribution to sound knowledge and a step towards the demolition of the pernicious errors still prevalent on the subject. Accordingly, after his return to this country in 1823, he prepared, and in 1825 published, a small volume, "Considerations on Volcanoes." It shared the fate of most books which are far in advance of their time; that is, it was regarded as crude, extravagant, and theoretical, and gradually suffered to pass out of mind. And yet, turning back to that early volume, and contrasting its earnest and observant pages with other writings of the same date on similar subjects, it is impossible not to admire the keen powers of observation and the happy faculty of generalisation which its author manifests. Even though some of the speculations are confessedly immature, others have stood well the test of time, and form now part of the familiar knowledge of every geologist. Above all, it must never be forgotten that in this volume, published before Lyell had written one of his works, the broad principle is laid down that the method of explaining the past geological history of the earth by reference to supposed violent and extraordinary catastrophes or general revolutions stops all true inquiry, and effectually bars the advance of science by involving it in obscurity and confusion. Mr. Scrope boldly maintained that instead of such vague guesses as to the possible causes and nature of the ancient changes of the earth, "the only legitimate path of geological inquiry" lay in "examining the laws of nature which are actually in force," and that until existing operations, with all possible variations and every conceivable allowance of time, have been proved to be wholly inadequate to explain the past, "it would be the height of absurdity to have recourse to any gratuitous and unexampled hypothesis." How truly does this passage express the philosophical stand-point of modern geology; and yet how rash and "theoretical" it must have appeared to the first readers of the "Considerations on Volcanoes." Mr. Scrope used not unnaturally to think that his earlier writings had not been without their influence in giving

tone to the "Principles" of his friend and fellow-labourer Lyell.

Two years after the "Considerations" appeared, Mr. Scrope published his great monograph on the volcanic districts of Central France—a work which placed him in a high rank as an accurate and philosophical observer, and one which did more, perhaps, than any other of its day, to destroy the Wernerian prejudice against volcanoes, and to establish the true volcanic origin of basalt rocks of every age. In another respect it marked an epoch in geological literature, inasmuch as it brought forward clear and detailed proofs of the gradual excavation of valleys by the action of the rivers still flowing in them—a doctrine taught indeed by Hutton, but for which there were still needed those very proofs which Mr. Scrope's memoir so admirably supplied.

After this early promise of an active and brilliant scientific career, Mr. Scrope's energies passed over into another and wholly different mode of life. He entered Parliament, and continued an active member for some thirty-four years. So thoroughly did he give himself up to political questions, that for fully a quarter of a century he seems to have retired from science altogether. About twenty years ago (1856), finding that the old notion of Humboldt and Von Buch about volcanic craters being merely big tumours or blisters pushed out by the expansion of the subterranean vapours, was still sufficiently in vogue to call forth an active opposition from Lyell, Mr. Scrope, who had long before exposed the untenability of this dogma, returned to his first love, and produced a paper upon "Craters and the Nature and Liquidity of Lavas." Other papers of a similar kind followed. In 1858 he brought out a second and revised edition of his memoir on the Auvergne volcanic region, and in 1862 he published a second—much altered and improved—edition of his general work on volcanoes. Since then he has communicated from time to time numerous brief letters and notices on his favourite subjects, showing how fully he retained his firm grasp of all that related to volcanic geology, and how young and fresh he could keep his powers.

This brief notice of his labours may fitly end with a tribute to that courtesy and kindness which ever marked his relations with other men. A more leal-hearted friend could not be. How gladly would he say a kind word when a kind word would be of service! How ready, too, to help with more than words!

The founders of English geology have been truly a noble band—generous, helpful, and enthusiastic; but few of them will be more sincerely mourned than George Poulett Scrope.

A. G.

#### SOMERSET HOUSE AND THE PUBLIC ANALYSTS

EVER since the proposal was first made that disputed cases under the Sale of Food and Drugs Act should be referred to the analysts of the Board of Inland Revenue as adjudicators, there has been a strong feeling in the minds of most persons competent to form an opinion on the subject, that should such a course be ultimately adopted, the probable results would be great dissatisfaction on all sides. It was foreseen that the gentlemen

most meritoriously engaged at Somerset House in testing the strength of alcoholic liquors, in examining the genuineness or otherwise of tobacco, tea, and excisable articles generally, and such like pursuits, would have great cause for complaint if work out of their ordinary department were thrust upon them, in the performance of which, even if no discredit should accrue to them by mistakes almost unavoidable in inexperienced hands, a considerable amount of professional odium would be probably incurred. It was clearly evident that the Public Analysts would be unjustly dealt with by the establishment of a system whereby the reports of men, frequently well known in the scientific world, and of great skill and experience in the special work requisite, would be liable to be superseded by those furnished by Government *employés* of far less professional and scientific standing, and specially qualified to a much lower extent. Finally, it was anticipated that a considerable injury to the public at large would be imminent, from the high probability that such an arrangement would lead to results not at all in harmony with the object of the Act. The checks on adulteration, it was feared, would be greatly diminished, partly through the bringing into more or less discredit the analysts appointed under the Act, and thus rendering their existence a far less effectual moral deterrent; and partly through the probable resignation of the higher class of analysts, and hence through the deprivation of the public of the special skill and experience acquired by these gentlemen.

That these dismal forebodings were not wholly groundless is shown by a recent case in the Southwark Police Court, the first, it may be mentioned, in which the Inland Revenue analysts have been appealed to under the new Act. On the 14th of last month, a large cheesemonger in the Borough appeared to answer a summons charging him with selling as butter a substance alleged to contain no butter, but to be a mixture of foreign fats not injurious to health. The proof of the purchase of the substance, and of the delivery of a sample to Dr. Muter, Public Analyst for the district, and the certificate of Dr. Muter to the above effect, were then given. The defendant demurring to the certificate, the case was adjourned in order that the third portion of the sample might be forwarded to Somerset House for examination by the Inland Revenue officers. On the 18th inst. the case came on for further hearing, and a certificate from Mr. Bell, of the Inland Revenue, was put in, stating that in his opinion the substance in question was genuine butter. This certificate was objected to by the presiding magistrate (Mr. Partridge) as being "extremely vague and unsatisfactory," inasmuch as it did not indicate that any analysis at all had been made, but only a cursory inspection. Mr. Bell thereupon gave an explanation of his certificate, stating that he had found the sample to contain water, 9.83; salt, 3.70; casein, 0.93; and fat, 85.54 per cent; that the fat yielded over 88 per cent. of fatty acids, and possessed the same specific gravity as butter fat, whence he concluded that there was no evidence of adulteration. In answer to questions, however, Mr. Bell admitted that although he had previously examined sundry specimens of genuine butter, and had seen some samples of "Bosh," he had never tested any specimen of the various artificial butters sold under the

name of "Butterine." He also stated that his method of analysis was one unknown outside the Inland Revenue laboratory, and that the only test on which he placed much reliance was the specific gravity of the fatty matter, whilst he had been unable from the few experiments he had made to corroborate the statement of Messrs. Hehner and Angell, that genuine butter fat never yields more than about 86 per cent. of fatty acids on saponification.

Although the case could not be reopened, the evidence of several Public Analysts who had examined the sample was taken, and in most respects distinctly showed that the secret method of examination adopted by Mr. Bell was utterly unreliable. Dr. Dupré, F.R.S., Mr. Wigner, and Mr. de Konigh each found that the butter-fat contained close upon 94 per cent. of fatty acids, genuine butter not yielding more than 86, and ordinary fats giving about 95 per cent. On microscopic examination a crystalline structure (evidence of fusion) was noticeable; the melting point was 4° C. lower than genuine butter; the matter mistaken by Mr. Bell for caseine was no such substance, but only fragments of woody tissue and similar vegetable organised matter; the physical structure of the substance was different from that of genuine butter, as it possessed on the tongue the peculiar granular feeling of "butterine," and also tasted like the latter. The same results were also arrived at by other analysts, six having examined the sample, and all agreeing with Dr. Muter that the substance contained either no butter at all or very little.

On the other hand, Mr. Harkness and Mr. Lewes (assistant to Mr. Bell) stated that they could see no crystals under the microscope, but admitted that woody fibre and other vegetable matter was present.

Finally, the case was dismissed, the Vestry being ordered to pay the costs of the Somerset House analysis; the magistrates, however, consented to grant a case for appeal if the Vestry desired to adopt that course.

Comment on the above would seem almost superfluous; but the question naturally arises, of what use is it in Government taking up valuable time in passing Acts, and in counties, districts, and parishes going to the expense of appointing analysts in accordance with these Acts, if the operations of these gentlemen are to be rendered nugatory by being liable to be overthrown by appeal to an authority which, however competent in reference to its own particular department, is nevertheless by its own showing scarcely possessed of sufficient experience, and is certainly not of sufficient standing and position to be admissible as a final adjudicator on such matters? The position of Public Analysts was surely bad enough without this indignity and injustice; most of the offices are grossly underpaid; the appointments are often in the hands of persons utterly incompetent to judge of the respective merits of candidates, and who not infrequently elect, not the applicant of highest scientific and professional standing, but the one who sinks his self-respect lowest by canvassing and flattering the electors. As a consequence many of the best known chemists refuse to have anything to do with such appointments, and the public loses the chance of valuable services. Further, when mistakes and blunders are made by persons who never ought to have been elected at all, there is a general cry against "the incompetence of Public Analysts," and discredit is brought on the whole class, worthy and

unworthy alike. The inevitable results of insisting upon the analysts of Somerset House or any other set of men (unless specially trained and adapted for such a position) being made referees whose decisions shall override the results of careful and conscientious chemists, will be that the best and most accurate work of the Public Analysts will be wasted, that they themselves will be brought into contempt, that many of the best of them will be forced to resign their appointments, and finally, that the Act will become to a great extent a dead letter.

#### HARTLEY'S "AIR AND ITS RELATION TO LIFE"

*Air and its Relation to Life.* By Walter Noel Hartley, F.C.S., Demonstrator of Chemistry, and Lecturer on Chemistry in the Evening Class Department, King's College, London. (London: Longmans, Green, and Co., 1875.)

OF all the so-called improvements which have been effected from time to time in the means by which we make ourselves comfortable and render ourselves independent of the limitations which nature would impose upon us—perhaps the introduction of gas was hailed and has been looked upon as among the greatest. It wants but little experience, however, of the manner in which people live in towns, to convince us that the reverse of this is the case, and that the pain and misery which it has been the means of inflicting must far outweigh its advantages. If anyone doubts this let him examine his sensations in a morning, after having spent the previous evening in a close room blazing with gas, and compare them with what he feels after having spent the corresponding hours in the open air, or in a fresh room moderately lighted with oil or candles. There are but few people to whom such experience would not show that the effect of the gas was a feeling of lassitude and depression, if not a downright headache; and if they were to repeat the experiment, who would not suffer a general loss of tone. Yet wherever gas is to be procured this is precisely the misery to which people subject themselves. In nine out of ten houses in the neighbourhood of towns, if one goes from the fresh air into a room in which the people are sitting on a winter evening, the first breath is enough to suffocate one, and yet the people within the room are entirely unconscious; they may be more or less restless and depressed, but as this is their normal state they do not recognise the cause. In this way, to say nothing of what takes place in theatres and places of amusement, the evils which gas is answerable for are incalculable, though if they could be estimated they must far outweigh the blessings which accrue from the abundance and cheapness of its light.

The fact is that the money cost of the fuel forms only one part of the expense of light; there is the consumption of oxygen, and in this gas is very extravagant; so that although we now obtain tenfold the light in our rooms which we had before the introduction of gas without any increase of expense in money, we have to pay for it by a tenfold vitiation of the air. Three or four gas flames consume as much air as a moderate fire, yet who would live in a room with a fire or even a pan of charcoal without a chimney. Yet it is a common thing to go into

a room in which three, four, or five gas flames have been burning for hours without either door or window having been open ; that the people who live in these rooms escape the evil effects is not to be supposed. The only thing is that they have not sense or courage enough to trace the effects to their cause. Rather than give up their warmth and light they wilfully close their eyes to what follows. When people inflict these miseries on their friends, whether consciously or not, they become a positive nuisance, and are fit subjects to be dealt with by the sanitary inspector. To have to dine with them is a punishment : a headache is sure to follow, however abstemious one may be.

Many of these people are doubtless innocent, but there are those who know the evil, yet who do not make any attempt to remove the cause. They have only to turn down the gas. But no ; they clamour for what they cannot get—good ventilation with the gas—and numberless are the quack remedies which one sees applied. But whether impossible or not, it is certain that at present there is no proved means which will supply sufficient air, free from draughts, to keep a room blazing with gas decently fresh. It may be that in time, when the clamour of quacks has sufficiently subsided to allow the voice of reason to be heard, some method of constructing houses with chimneys for gas may be introduced which will allow of all the desired warmth and light, and at the same time ensure a sufficient supply of fresh air. But in the meantime, the obvious remedy is to forego some of the luxuries, to be content with moderate light and warmth, and to set off against the evils (mostly fancy), which arise from occasionally opening a window, the certain and disgusting effects of sitting in a closed room.

The effect of gas is not the only evil to be remedied by improved ventilation. Modern science has brought to light things concerning the origin of disease of which our fathers never dreamed, and which must render people dissatisfied with the state in which they live. But to do this they must be known. Ignorance, if it is not the sole cause of the evils which people inflict on themselves, is at least their excuse. As a rule people have much more faith in what is told them with authority than in that which they themselves dimly perceive, and hence it does not follow that because the evidence of their noses has been disregarded that the voice of a prophet will not be listened to. Unfortunately, the subject of practical ventilation is one which by reason of its complexity has offered little attraction to scientific men, and consequently has been much neglected. It was therefore with great pleasure that we received the work before us. Written in ordinary language, and in a very clear style, this little book contains an account of all that has been done in the way of scientific research on the relation of air to life. It is written from a scientific point of view, but no pains have been spared to trace the possible applications of the science and the practical lessons which may be learnt from it. It is just the book for those who, without any particular chemical or physical training, have undertaken the control of sanitary matters.

In the first two chapters the author gives a very interesting historical sketch of the discovery of the constituents of the atmosphere, in which the experiments which have led to the various discoveries are not only

described, but illustrated by very perfect drawings, and thus the reader is conducted by easy steps to a very complete view of the subject, including the most recent discoveries. A very full account is given of the amounts (and the means of determining them) of ozone, carbonic acid, and the organic impurities in the air at different times and in different places. The degree of accuracy to which this class of research has been carried is very striking. Dr. Angus Smith has examined the air under almost all conceivable circumstances, and his methods will compare in delicacy with the sense of smell. Thus in place of our impressions, we have now definite chemical proof as to the degree of impurity in the air which produces evil effects.

Having given tables of the amounts of carbonic acid to be met with in closed places, the author proceeds :—

“ Here it is easily seen that the air in the theatres is very bad ; but after the doors had been open for a short time between the acts it rapidly improved ; indeed, in Covent Garden, in the second case, near an open door, the people exclaimed, by force of contrast, how delightful the fresh air was ; nevertheless, this *fresh air* contained 14.8 parts of carbonic acid in 10,000, or from 2½ to three times as much as it should have had. Drury Lane was the first place experimented on ; and having entered at the commencement of the performance, the bad effect of the air as it became vitiated was only gradually experienced, but it produced a listlessness and headache. All the audience around were evidently affected in the same manner, and appeared to be constantly sighing and gaping, or, in other words, gasping for breath.”

“ The bad effect of carbonic acid in the air alone, without taking into account organic matter, has been shown by Dr. Angus Smith, who ascertained that one part of the gas in 1,000 of air produced in fifteen minutes an increase in the number of respirations from eighteen to nineteen per minute, which increase remained the same up to forty-five minutes ; the pulse was lowered in twenty-five minutes from seventy-three to seventy-one beats ; while at forty-five minutes it was seventy-two per minute. With 2½ volumes of carbonic acid in 1,000 of air the pulse at first seventy, increased to seventy-three at the end of ten minutes, and at the end of half-an-hour was lowered to sixty-nine, while the respirations increased from seven-teen to twenty-one per minute. With five volumes of carbonic acid the pulse at first seventy-six and the inspirations seventeen, at the end of forty minutes were represented by the numbers seventy-one and twenty-four.”

The results of this research, therefore, fully bear out the conclusions of experience as to the evils of our present system of lighting our dwellings, and it is to be hoped that, supported by this authority, people will no longer snub their noses and disregard their evidence.

The author then goes on to discuss the laws relating to the motion of gases, and to detail what little is known as to the best means of getting the air into and out of our rooms. He calls attention to the very striking result of some experiments (Pettenkofer's) as regards the quantity of air which passes through the solid walls of a room ; and he finishes the chapter by pointing out how in our badly-constructed houses we are drawing poisonous air into them from the ground on which they are built, and the drains beneath them.

The latter part of the book is devoted to setting forth the results of the researches of Dr. Angus Smith, Pasteur, and others, on the power of the air to suspend and

transport living germs, and the many important lessons with which the subject is fraught. This subject has already been so much discussed in the columns of NATURE, that it is not necessary to enlarge upon its importance in this review. Suffice it to say, that a knowledge of it is essential to the comprehension of the full importance of having pure air within our houses.

In conclusion, we strongly recommend the book, which, while it contains all the information to be obtained, sets forth nothing but what is based on sound principles, advocates no hypothesis, and in no way attempts to disguise the difficulties and imperfect state of our knowledge of the subject.

OSBORNE REYNOLDS

### THE RECENT ORIGIN OF MAN

*The Recent Origin of Man, as illustrated by Geology and the Modern Science of Prehistoric Archaeology.* By J. C. Southall. 8vo. Pp. 606. (Philadelphia: J. B. Lippincott and Co.; London: Trübner and Co., 1875.)

THE work published under this title is a laborious compilation of heterogeneous materials derived from history, archaeology, and geology, in which the writer attempts to prove "that primeval man commenced his career six or eight thousand years ago in a civilised condition in the temperate regions of the East." In it the irresponsible dicta of anonymous journalists, and the records of local societies in America, Britain, and France, unchecked by criticism, are taken to be of equal value with those facts which have run the gauntlet of the criticism of the civilised world, and not been found wanting. A work written in this manner must necessarily be a huge pile of wheat and chaff, in which the former can only be got at by a process of careful winnowing. In this particular case we fail to discover any wheat which has not been taken out of somebody else's barn.

Mr. Southall tells us, in his preface, that he is the champion of the Bible against the speculations of "Science," and that as such he is very much hurt "that many literary and scientific men should avoid mention of the Hebrew Scriptures." "I do not recollect," he writes, "that 'The Antiquity of Man' even recognises that the Book of Genesis is in existence; and yet every one is perfectly conscious that the author has it in mind and is writing *at* it all the time." This quotation illustrates the spirit of the book and the one-sidedness of the writer. Why should Sir Charles Lyell include Genesis among his geological evidences as to the antiquity of man, and enter into the barren discussion which has been before the world for the last half century? Mr. Southall does not recognise the fact that even if he proves scientific men to be wrong he does not add to the authenticity of the Scriptures, or that even if man be but six or eight thousand years old, that fact again is a point of small importance, except as relates to Archbishop Usher's chronology. We for our part protest against the assumption in this work that there is any real antagonism between religion and science, and we believe that its writer has contributed perhaps the most elaborately untrustworthy contribution to a dead controversy which has yet been made; for in it are involved, as in a great whirlpool, facts relevant and irrelevant—every waif and stray, in fact, that has come within its reach. And these are carried round

so swiftly that it is almost impossible for the reader to see clearly whither the argument is tending. Of course Mr. Darwin and the doctrine of evolution are drawn in, which the author takes to imply "that Napoleon Buonaparte was evolved from a Corsican crab," and which we respectfully decline to discuss in this connection.

In the attempted proof of man's recent origin, Mr. Southall first of all appeals to history. The records of Phœnicia, Babylon, and Egypt go back some three thousand years, more or less, before Christ, and civilisation then was as complete and elaborate as it was at any subsequent time. He argues that there is no graduated process from the savage state in any of these cases, and "that there is not a particle of evidence that man in his earliest seats in the East was a savage." He then asks (it may be jocularly), "Did the pyramids and the Chaldæan astronomy emerge from the Danish Kjøkkenmøddings abruptly and instantaneously?" It is certainly true that we have not yet discovered any proof of the gradual development of the arts and of civilisation in those comparatively inaccessible regions, not necessarily because they do not exist, but because the exploration has been imperfect. In them there may be, and probably are, treasures to be revealed by the pickaxe and spade quite as rich as those of Hisarlik, and showing as complete a sequence. The statement that no traces of a rude and imperfect civilisation have been met with in the East is refuted by the discovery of enormous quantities of flint implements in Egypt and of Neolithic axes in Asia Minor and in India. In the river gravels of both these regions Palæolithic *haches* have been found of the same type as those of Amiens and Abbeville. In the face of testimony of this kind he assumes that there are no traces of savagery, and accounts for the ancient civilisations by the supposition that they were inherited from the antediluvian world through Noah and his sons, and that the long-lived patriarchs were, by virtue of their experience, "very remarkable men." We would hand over this argument as it stands to Mr. Galton, for use in his next edition.

Having fixed the age of the most ancient peoples known, including the Chinese, by an appeal to history, the author assumes that the ancient inhabitants of Western Europe, whom he admits to have been savages, were descended from the same stock as the Babylonians, Egyptians, and Chinese, and that the date of the former is identical with that of the latter—a statement which is equivalent to the saying that children of the same father are always of the same age. Before we leave this part of the work behind, we would remark that Mr. Southall gravely tells us, that Central America had been visited by the Chinese, Japanese, Irish, and Welsh before the voyage of Columbus, as if these were well-authenticated facts. He evidently believes in the Irish legends, and in the story of Prince Madoc.

If, however, history fares badly at the hands of Mr. Southall, archaeology fares worse. He devotes one chapter to the "premature announcements of Science with regard to the antiquity of man," in which such statements as the existence of a race of pigmies in Tennessee, proved from the small graves, the presence of man in the Pleiocene age, based on the perforated sharks' teeth in the crag of Norfolk, the asserted discovery of a fossil man in

palæozoic schist in Quebec, are included among the beliefs which have been accepted and then given up by scientific men. Having thus discredited their judgment, he proceeds to contradict himself as to the conclusions of Evans, Lubbock, and Lyell with regard to the division of time past, before the dawn of history, into the stages of rude stone, polished stone, bronze, and iron. A large portion of the book, the entire argument, so far as we can make it out, is devoted to proving that these stages were simultaneous, and not older than the six or eight thousand years of history and tradition. In p. 400 he allows that they are consecutive almost as distinctly as Mr. Evans.

In proving that "the ages" are simultaneous he adopts the same kind of reasoning as that by which Mr. Ferguson arrives at the post-Roman age of the Megalithic monuments, and Mr. Wright concludes that the Britons during the time of the Roman invasion used bronze swords. It is a very simple process. You find a certain set of things in a cave, in a cairn, or a tumulus, or in diggings near a Roman station, and you at once conclude that they were used at the same time by the same people. In every one of the cases cited there is no proof that the deposit in which the articles occur has not been disturbed. Before any association of the kind quoted is of the least value we must be certain that there has been no subsequent disturbance; such proof, for example, as we get in some of the pile-dwellings of Switzerland; such proof as we do not get at Solutré, where a Merovingian cemetery happened to be planted on an old "station" of the Palæolithic age, as the writer of this review was informed by Dr. Broca at the French Association at Lyons in 1873. In this case, which is made the basis of the attack on the high antiquity of Palæolithic man, the human skulls are comparatively modern, and the refuse heap of an untold age.

We have followed Mr. Southall into a labyrinth, and we have been unable to find a single shred of proof of the recent origin of man. We lay down his book with regret that he should have expended so much labour, with the practical result of leading the unwary reader into errors as to facts—for example, that Busk stated the Cave-bear to be identical with the Grizzly, or that Brandt believes that the Irish Elk lived in Central Europe down to the fourteenth century, two cases which occur to us. We trust that few Americans will take the views ascribed to the leading archæologists of Europe, in this handsome and well-printed book, without verification by an appeal to their writings.

W. B. D.

#### OUR BOOK SHELF

*The Indian Alps, and how we crossed them; being a Narrative of Two Years' Residence in the Eastern Himalayas and Two Months' Tour into the Interior.* By a Lady Pioneer. Illustrated by herself. (London: Longmans and Co., 1876.)

THE plucky authoress of this handsome work makes no pretensions to give any scientific account of that portion of the Himalayas into which she penetrated; this, however, is the less to be regretted as, from a scientific point of view, much of the ground over which she passed has been rendered classic by Dr. Hooker. Her starting-point was Darjeeling, and the first portion of the work describes a pleasant preliminary trip which she and her husband made to the east as far as Dumsong. On returning from

this outing, she, her husband F., and a friend C., accompanied by a small army of attendants, set out to penetrate, and if possible cross, the Eastern Himalayas. Their route was westwards by Mount Tongloo, and then almost directly northwards by Mount Singaleelah, the Dumdongla Pass, and onwards as far as the base of Mount Junnoo. The party took a large quantity of provisions with them, but depended upon a chief in the interior to supplement this supply about half-way. The chief failed them, and a guide whom they picked up on their route, after leading them all astray into a most inhospitable region, decamped, leaving them in a most perilous position. Happily, after much murmuring and danger of mutiny on the part of their attendants, they managed to extricate themselves without any loss or serious damage to anyone. Returning by the same route as far as Mount Singaleelah, the venturesome tourists turned eastwards and then southwards, along the Great Rungeet River, and so back again to Darjeeling, after a journey which, notwithstanding a few hardships, all seem to have enjoyed immensely. Although there is no formal attempt to describe either the fauna, flora, or geology of the region passed through, the authoress's descriptions are so minute, and her references to the characteristic animal and plant life of the various stages so frequent, that the reader will have a fair notion of the general features of the line of march. The Lady Pioneer's artistic attainments are of a high order, and her sympathy with nature from this point of view intense; her descriptions are, moreover, so clear and intelligible, and the illustrations are so numerous and well executed, that the book from beginning to end is a delight. A marked feature of the work is the chromolithographs, creditable alike to the artist and printer, affording better than any verbal description an idea of the character of the unequalled Himalayan scenery. The invariable sweetness of the author's style, and we may say of her temper under all circumstances, and her strong sense of humour, add to the charm of her narrative. The reader may learn a great deal from her book about the country passed through and about the various classes and tribes of people she met and mixed freely with, for she is a shrewd observer of men and manners. One cannot help thinking, we may venture to say, that F., whom she dutifully brings to the front on almost every page, is a lucky fellow. As might be expected, there is a good deal of moralising under the awful influences of the "Abode of Snow;" perhaps too much of it, though this natural failing will be overlooked, considering the genuine attractions which the work possesses.

Quite recently we reviewed Mr. Wilson's delightful work the "Abode of Snow," describing a journey which he made through the Western Himalayas; that, along with the present work, is very suggestive of the development of English ideas at least with regard to that class of scenery to which the term "grand" is usually applied.

It is well known that the tourist fever is of quite modern origin. It is only within the present century that an appreciation of wild and mountainous scenery has become anything like general. It would be difficult to find much in the way of admiration for such scenery in any poet who wrote before Wordsworth and Scott; an intelligent and well-educated officer of Engineers who lived in the midst of some of the now most admired Highland scenery in the early part of last century, wrote of it with something like horror; he could see "no beauty in it that it should be desired." While in this country the two poets above mentioned have no doubt had a principal share in originating the modern taste, there are other causes, connected with the general advance in intelligence and elevation of taste, which it would be instructive to trace. We are inclined to believe that the very modern science of geology has something to do with it; and certainly he who has a fair knowledge of the facts and principles of that science, not to mention the other natural



sciences, will be able to read infinitely grander legends in wild and mountainous scenery than he who looks upon it alone through the glamour thrown over it by mythology or genius. At all events, we welcome the spreading love of travel as one of many signs of a great intellectual awakening, although doubtless at present it has a good deal about it which lays it open to the sneer of the cynic, as have all new movements. There is a considerable, and we think ill-natured outcry in certain quarters, that all the accessible tourist grounds will become more and more crowded by the followers of the beneficent Cook. But there will always be some spot to which he who does not wish to be counted one of the common herd of tourists can retreat until he has gained vigour and nerve enough to feel in a mood to mix again with "the kindly race of men." Such a retreat is, and will for long be afforded by the "Abode of Snow" which Mr. Wilson and this Lady Pioneer have so attractively described; by and by, no doubt, it will be made more accessible by roads either from our own or from the other (is it premature to say the Russian?) side.

### LETTERS TO THE EDITOR

[The Editor does not hold himself responsible for opinions expressed by his correspondents. Neither can he undertake to return, or to correspond with the writers of, rejected manuscripts. No notice is taken of anonymous communications.]

#### The Article "Birds" in "Encyclopædia Britannica"

MR. GARROD's article on the new edition of the "Encyclopædia Britannica" in last week's NATURE contains the following passage:—

"As another example of the different teaching of the artificial and the natural classifications, the Swifts (*Cypselidae*) and the Humming Birds (*Trochilidae*) may be referred to. These two groups, from the details of their internal structure when examined one by one, are most certainly related as intimately as are the Woodpeckers with the Toucans. There is, in fact, not a family difference between them, and yet, from their palates, Professors Huxley and Parker place them in quite different divisions, because the vomer is truncated in the one and pointed in the other."

In a previous part of the article Mr. Garrod refers to my paper on the Classification of Birds, published in the Proceedings of the Zoological Society in 1867, which he criticises as if he had studied it with a care proportioned to the labour it cost. Nevertheless, I can but think that his acquaintance with its contents must be somewhat superficial, inasmuch as any careful reader will find at p. 459, the following passage under the head of *Cypselomorpha*, or Swift-like birds:—

"This group contains three very distinct families—the *Trochilidae*, the *Cypselidae*, and the *Caprimulgidae*. The first two families have a length of the manus and a brevity of the humerus which is peculiar to themselves."

Thus, so far from placing the Swifts and the Humming Birds in "quite different divisions," I placed them in the same division, and took pains to point out their close affinity; and in asserting the intimate relations of the *Cypselidae* and *Trochilidae*, Mr. Garrod is reiterating a view which, unless I mistake, was first definitely put forward by myself, and not, as the readers of his article would be led to imagine, controverting my opinions.

Mr. Garrod takes pains to show that "the structure of the skull does not alone suffice to determine the mutual affinities of birds." The implication appears to be that Mr. Parker and I assert the contrary. I have no right to speak for Mr. Parker, but I may remark that my knowledge of his works would not have led me to Mr. Garrod's conclusion, while it would have compelled me to treat any opinion of his, however much I might be disposed to differ from it, in a manner different from that adopted by Mr. Garrod. As to the facts, so far as I am concerned, those who will take the trouble to read my paper on the Classification of Birds, and an article by the editor of the *Ibis*, with a letter addressed to him by me, published in the *Ibis* for 1868, will see that the classification in question is not based upon cranial structure alone, and that, seven years ago, we went a little deeper into the question of the principles to

be followed in taxonomy than the point at present attained by Mr. Garrod.

Jan. 23

T. H. HUXLEY

### D-Line Spectra

IN reply to a question propounded to you by a correspondent (vol. xiii. p. 224) as to my reasons for believing that sodium is free in the flame of a spirit-lamp with salted wick, I have to state as follows:—

1. We now know that the flame exercises a specific absorption, and is capable of producing dark D. If this were due to vapour of chloride of sodium, we should expect, in accordance with what observation shows in other cases, that solution of chloride of sodium, or at least the solid chloride, would more or less absorb the orange or yellow part of the spectrum, though not in the same definite way, and we find it does not.

2. We know, by direct experiment, that vapour of sodium does exert the very peculiar absorption indicated by dark D. Different salts of the same metallic oxide agree in the mode in which their solutions absorb light, or at least there is a strong family likeness; but when we pass from one oxide to another of the same metal, there is a complete change. Much more should we expect a complete change when there is such a profound difference of chemical character as there is between sodium itself and chloride of sodium.

3. Lastly, Mr. A. Mitcherlich has proved, by direct experiment, that vapour of chloride of sodium within a tube heated to bright redness neither emits bright D nor produces dark D by absorption (*Poggendorff's Annalen*, vol. 116, pp. 504, 505).

It need not surprise us that sodium should be temporarily free in an ordinary flame, since the metal is prepared by heating carbonate of soda with charcoal, and in the flame we have hydrocarbons at a high temperature. Perhaps the heat alone would suffice to set it free by dissociation.

G. G. STOKES  
Cambridge

### The True Nature of Lichens

THE editorial note on this subject in NATURE, vol. xiii. p. 168, was thoroughly disappointing to those who, like myself, may have had hopes that the confident allusion by the reviewer of Haeckel to the "clearing up" of the "true nature of Lichens" had reference to some demonstration—of which we had not heard—of the part played by *Spermogonia* and *Pycnidia* in *Lichen-Reproduction*. Having long had in contemplation the publication of a volume of "Outlines of Lichenology," it has been my business for years to note carefully all publications of any importance on the Natural History of Lichens. Those of Prof. Schwendener of Bâle and his disciples could scarcely have escaped me; so that I find the papers mentioned in the editorial note aforesaid, as well as others, duly recorded, with abstracts and relative criticisms, in my Lichenological memorandum book.

My opinion of the speculations of Schwendener and his followers has all along been, and still is, that so far from "clearing up" the "true nature of Lichens," they introduce elements of very decided confusion; and that they are to be regarded merely as illustrations of German transcendentalism, comparable to the fanciful notions of his countryman Bayrhammer, in 1851, concerning Lichen-Reproduction.\* The dogmatic assertions of anonymous critics concerning the "clearing up" of the "true nature of Lichens," by mere speculations notwithstanding—I hold what I have always held—that the Lichens as an Order are quite as natural, important, and distinct as any other Order of the Cryptogamia. And in so saying I do not forget the fact that they overlap both the *Algae* and the *Fungi*. On the contrary, I have over and over again pointed out, in my own publications on the Natural History of Lichens, the affinities, or points of affinity, between Lichens, and *Algae* on the one hand, *Fungi* on the other. In order that sight might not be lost of organisms of doubtful character, possessing elements of structure usually regarded as both algal and lichenoid, or fungoid and lichenoid, or either the one or the other, I long since proposed the establishment of *intermediate and provisional groups of Algo-lichenes and Fungo-lichenes*. Such groups would have the advantage of attracting attention to those *passage-forms*, which appear to me to be of the highest interest to the philosophical botanist.

I have not myself had an opportunity of perusing Haeckel's

\* "Einiges über Lichenen und deren Befruchtung," von J. D. W. Bayrhammer, Bern, 1851; an illustrated 4to.

"History of Creation." But, according to a recent reviewer\* of the said work, this is what he says of the "true nature of Lichens":—"Every Lichen is really composed of two distinct plants: of a low form of *Fungus* (Ascomycetes), which lives as a parasite upon the former (?), and upon the nutritive substance prepared by it. The green cells, containing chlorophyll (Gonidia), which are found in every Lichen (?), belong to the *alga*. But the colourless threads (Hyphæ), which, densely interwoven, form the principal mass of the body of the Lichens, belong to the *parasitic fungus*." (Vol. ii. p. 95.) Now, says the reviewer in question, "This doctrine, so dogmatically put forth . . . is adopted but by a few outside of the extremely Hypothetical school of German botanists; and by the best Cryptogamists of this country and of the Continent is considered a pure Delusion: "a verdict much nearer the truth, it must be confessed, than the assertion that Prof. Schwendener has "cleared up" the "true nature of Lichens." Among "the best cryptogamists of this country" who have expressed themselves as unconvinced by, or opposed to, the dogmata of Schwendener and his admirers, regarding the "true nature of Lichens," are Berkeley, Thwaites, and Cooke—than whom we have certainly no botanists better qualified or entitled to form or to offer opinions on such a subject. The views of Berkeley and Thwaites are referred to in NATURE (vol. x. p. 541) as having been expounded before the Royal Horticultural Society; while those of Cooke are set forth vigorously in his recent "International Scientific Series" volume on "Fungi." See also what the sagacious President of the Linnean Society (Bentham) says on this subject—*ex cathedra*, and therefore summing up judicially—in his anniversary address for 1873 (Proceedings of the Society for May 1873, p. 28):—"There is one part of Sachs' book † (says he) which is an illustration of a very common readiness to take at once as proved any *paradox* or theory opposed to general belief, when a new discovery appears to afford some plausible argument in its favour. In the article *Lichens* . . . he adopts, as an established fact, Schwendener's view that Lichens are Fungi parasitical upon Algæ . . . a series of conclusions founded on a very small number of facts . . . They require much observation and study before the conclusions derived from them can be taught as an established Theory. And whatever be the result, the Group of Lichens is so distinct in its vegetative characters, and at the same time so extensive and varied a one, that it seems more methodical to treat it, as heretofore, as a *distinct class*, ‡ than to absorb it in that of Fungi, notwithstanding the close affinity shown by its reproductive organs."

But other German botanists themselves, not inferior in status or experience to Prof. Schwendener, regard, as Bentham does, the Hypothesis that Lichens are the product of a union of Parasitic Ascomycetes with Algæ as far from being proved. For instance, Prof. De Bary, of Halle, and Dr. Stitzenberger, of Constance, point this out in the *Botanische Zeitung* for 1870 (pp. 42 and 53). If, by artificial cultivation, such a Union could be made to produce a Lichen, the Theory might be held as proven. But this has not yet been effected, and I venture to think and say it never will be.

There are several difficulties in the natural history of Lichens with which the Schwendenerians have to deal, and which they have not yet, so far as I know, explained away. For instance, the case of Athalline Lichens that have neither Hyphæ nor Gonidia—neither fungoid nor algoid elements—assuming Hyphæ to be necessarily fungoid and Gonidia to be algoid; Lichens that are represented only by Apothecia, which are avowedly lichenoid: though they too may be claimed for the Algæ, inasmuch as Archer has a recent paper "On Apothecia occurring in some Scytonematous and Sorisophonaceous Algæ in addition to those previously known." §

In short, the mantle of Bayrholder appears to have fallen on Schwendener; and his Parasitic Theory is merely the most recent instance of German transcendentalism applied to the Lichens!

W. LAUDER LINDSAY

#### OUR ASTRONOMICAL COLUMN

THE BINARY STAR  $\gamma$  CORONÆ AUSTRALIS.—Professor Schiaparelli has measured this star during the past year with the 8-inch Merz-equatorial of the Observatory of Brera, Milan, where its meridian altitude is less than 8°;

\* In the *Scotsman* (Edinburgh) for December 3, 1875.

† "Lehrbuch der Botanik," of which a well-known English translation has now been published.

‡ The italics are mine.

§ "Quart. Journal of Microscopical Science," January 1875.

an interval of twelve years had elapsed since the last published measures by Powell. The first micrometrical measures were made in 1834 by Sir John Herschel, and from 1847 to 1858 Jacob had given much attention to observations of this star. From the forty-two years' observations thus available, Professor Schiaparelli has calculated an orbit which agrees unusually well with observation, and may be written as follows:—

Peri-astron passage, 1882.774; node, 49° 9'; node to peri-astron on orbit reckoned in the direction of motion, 255° 24'; inclination, 68° 38'; excentricity, 0.6989; semi-axis major, 2".40; period of revolution, 55.582 years; mean annual motion, -6".477.

At the calculated peri-astron passage in the autumn of 1882, the distance of the components which was 1".45 last summer will have diminished, according to the above orbit, to 0".3. Professor Schiaparelli states that observations are already difficult in his latitude, and will soon become impracticable; the star must therefore be left to the southern observatories, whence measures may be looked for during the interesting period in its revolution now at hand.

It will be seen that  $\gamma$  Coronæ Australis has the shortest revolution of any southern binary, and is fourth on our list in respect of rapid motion.

THE SOLAR ECLIPSE OF 1876, MARCH 25.—It is quite possible that this eclipse, which is given as an annular one in the Ephemerides, may be total for an instant on the North Pacific Ocean in longitude 140° 16' west of Greenwich, and latitude 35° 39' north, or near this position it may prove one of those rare phenomena, characterised in our text-books as "total without continuance." The central line traverses the southern and largest island of the Sandwich group, where the eclipse will be annular for a few seconds. At a point in longitude 155° 56' W., latitude 19° 28' N., the eclipse commences at 9h. 30m. A.M. local mean time, at 130° from the sun's north point towards the west (direct), and the annulus is formed according to the *Nautical Almanac* elements at 10h. 49m. 10s., and continues ten seconds. This point is a little south of Kaavara, by the Admiralty Chart, and close to the spot where the monument to Capt. Cook was erected; the central eclipse leaves this island, Hawaii, near Manienie, also marked on the Admiralty Chart of this group. The eclipse will be central and annular also in Vancouver Island and British Columbia. The central line appears to enter Vancouver at Refuge Cove, Sydney Inlet, leaving it at Orange Point, Duncan Bay, whence its course is to George Point, British Columbia. In Vancouver Island the annulus may continue seven or eight seconds, being formed about 0h. 27m. P.M. local mean time. At New Westminster, British Columbia, calculation gives a large partial eclipse commencing at 11h. 22m. A.M., and ending at 2h. 3m. P.M. local times, magnitude 0.95; here the first impression of the moon upon the sun's disc is made at 127° from his north point towards the west. For further information on the track of the central line over these parts the large Admiralty Chart of Vancouver Island and vicinity should be consulted; the above names of points traversed by the central eclipse are taken from it.

On the central line this eclipse must prove one of very considerable and unusual interest.

BESSEL'S TREATISES.—The first volume of the collective edition of the more important astronomical and other memoirs by the illustrious Königsberg astronomer has been issued under the editorship of Dr. Rudolf Engelmann, of Leipsic. It is a handsomely printed volume in quarto, of nearly 400 pages, and doubtless will find its way into the library of every earnest student of the science.

Amongst the contents of this first volume may be mentioned Bessel's early work, undertaken at the instigation of Olbers, the reduction of Harriot's and Torporley's

observations of the comet of Halley at its appearance in 1607; his "Development of a general method for calculating the perturbations of comets" from his classical work on the great comet of 1807, published at Königsberg in 1810, and somewhat difficult to meet with now, in its original form; the well-known memoir on the physical condition of Halley's comet with the plates, taken from Vol. 13 of the *Astronomische Nachrichten*; the memoir presented to the Berlin Academy in 1824, entitled "Untersuchung der Theils der planetarischen Störungen, welcher aus der Bewegung der Sonne entsteht;" researches on the Saturnian system, the position of the plane of the rings and their dimensions, the figure and dimensions of the planet, the motions of the Huyghenian satellite and determination of the mass of Saturn therefrom, and the memoir on the theory of this system from Vol. 28 of the *Astronomische Nachrichten*; the Prize Essay "Untersuchung der Grösse und der Einflusses des Vorrücken der Nachtgleichen," to which was attached the motto, "Non frustra signorum obitus speculamur et ortus;" various papers on precession, aberration, &c., which appeared in the *Tabula Regiomontana*, and elsewhere, and the essay on the "Scheinbare figur eines unvollständig erleuchteten Planeten scheinbe."

The portrait of Bessel after Mandel is prefixed, with reminiscences of his early life, from the correspondence with Olbers, and additional notes by the editor.

The work is entitled "Abhandlungen von Friedrich Wilhelm Bessel herausgegeben von Rudolf Engelmann, —Erster Band, Leipzig, 1875."

#### THE FLOWERING OF SPRING PLANTS \*

**D**URING the past twenty years the Scottish Meteorological Society has been collecting data relative to the budding, leafing, flowering, and defoliation of trees and plants, and to the migrations of birds in connection with the periodical return of the seasons, and it was proposed some time ago to discuss the material which has been accumulated. As preliminary, however, to this very difficult line of inquiry, it was resolved to discuss in the first place the observations which have been made by Mr. McNab on the flowering of spring plants in the open air in the Edinburgh Royal Botanic Garden during the past twenty-six years, and which have been published in the Transactions of the Botanical Society of Edinburgh. These observations have been made by the same observer on the same plants, growing in the same situations, during the whole of the twenty-six years.

The average day of flowering of thirty-two spring flowers has been determined, of which the following are examples:—*Galanthus nivalis*, Jan. 25; *Eranthis hysmalis*, Jan. 30; *Hepatica triloba*, Jan. 31; *Corylus Avellana*, Feb. 2; *Rhododendron atrovirens*, Feb. 3; *Crocus susianus*, Feb. 4; *Leucojum vernum*, Feb. 10; *Daphne Mezereum*, Feb. 22; *Narcissus pumilus*, March 10; *Orobis vernus*, March 11; *Muscari botryoides*, March 18; *Ribes sanguineum*, March 22; *Narcissus pseudo-Narcissus*, March 31; and *Fritillaria imperialis*, April 1.

The lateness or earliness of the different springs, as determined from the times of flowering of the thirty-two plants in each year, is considerable. The latest spring was 1855, which was thirty days later than the average, and the earliest 1874, which was twenty-three days earlier, thus giving a difference of fifty-three days between the latest and earliest springs during the past twenty-six years. As regards particular flowers, the deviations are much greater. The largest deviations from the average dates of flowering occur before the time of the equinox, when deviations of from five to seven weeks either way are of repeated occurrence; but after the equinox the

deviations are markedly less, seldom reaching three weeks.

The springs of 1855, 1856, 1857, 1865, and 1870 were late throughout; and on the other hand, the springs of 1851, 1862, 1863, 1868, 1869, 1872, and 1874 were early throughout. Great variations have occurred in other springs, such as 1864, which, being preceded by a very mild December, many spring plants came into flower in the end of 1863. But in January the temperature was 2°0 under the average, and in February, 5°2, and vegetation was consequently arrested. March was also under the average, and the weather did not improve till April 3, the mean temperature of this month being 1°7 above the average. The disturbing influence of this abnormal weather on the dates of flowering was in some cases very great. Thus, *Sisyrinchium grandiflorum* flowers on the average eleven days earlier than *Daphne Mezereum*, but in 1864 *Daphne Mezereum* did not come into flower till eighty-six days after *Sisyrinchium grandiflorum* had flowered. It is the occurrence of these disturbances which renders a long series of years necessary in order to arrive at a sufficiently close approximation to the true mean dates of flowering.

As regards Edinburgh, Jan. 11 may be considered as the turning point in the winter temperature, since previous to this date the temperature is, on the whole, falling, and after this date it continues steadily to rise.\* Further, after this date the rainfall becomes less, clear weather is of more frequent occurrence, and the increase in the temperature is very largely due to an increase of sunshine. The extremely slow rate at which, up to the end of February, the mean temperature rises, and the small differences among the temperatures up to this date, and the large number of plants—fourteen in all out of thirty-two—which come successively into flower during the interval, suggest that it is not so much absolute temperature that calls for consideration as the accumulated amounts of the preceding daily temperatures, in the extent to which these rise above freezing. The accumulated temperatures, thus calculated, are, for *Galanthus nivalis*, 72°7, and *G. plicatus*, 146°4; for *Crocus susianus*, 125°2, and *C. vernus*, 179°1; for *Rhododendron atrovirens*, 120°3, and *R. Nobleanum*, 249°3; and for *Narcissus pumilus*, 347°0, and *N. pseudo-Narcissus*, 540°1. Similar data prepared for other places, in this and other countries, would be very instructive in showing how far the order of dates of flowering in Edinburgh is observed in other places, and what is the relation of the dates of flowering at each place to the accumulated temperatures at that place, and what modifications are brought about by purely climatic differences, particularly as these occasion different results as respects the heating and actinic rays of the sun.

The thirty-two plants, whose dates of flowering have been determined, include three varieties of one species, viz., the blue, white, and red varieties of *Scilla bifolia*. Of these three varieties the blue flowers first, viz., on March 7; next comes the white variety, on March 17; and lastly, the red variety, on March 21, the red being thus a fortnight later than the blue variety.

An interesting question may in this connection be raised with reference to the relation which the colours of flowers have to the dates of flowering. With this view, our British wild plants have been grouped according to the different colours of their flowers and the months in which the flowers usually first expand, the data being taken from Dr. Hooker's "Students' Flora of the British Islands." In classifying the plants, red includes pink, crimson, and scarlet; and green, all greenish-white, yellowish-green, and greenish-purple flowers. Grasses, carices, and other groups, characterised by inconspicuous floral envelopes, are excluded. The list examined includes 909 species, of which there are 257 with

\* Abstract of a paper read before the Edinburgh Botanical Society on the 13th inst. The paper itself is in type for the Journal of the Scottish Meteorological Society.

\* See Prof. Forbes's paper on the climate of Edinburgh, in Trans. Roy. Soc., Edin., vol. xxii. pp. 348-349.

white flowers, 238 with yellow flowers, these two being nearly a half of the whole number; then follow red, 144; purple, 94; blue, 87; green, 51; and miscellaneous, 38. Taking each colour by itself, and calculating the percentages of that colour which has come into flower by each month from April to July, we obtain the following results for the first five classes:—

	April.	May.	June.	July.
Blue ..	16	43	71	93
White ..	14	36	70	97
Purple ..	4	28	61	92
Yellow ..	9	24	61	93
Red ...	9	25	62	94

Thus of these colours, the *blues* are, on the average, considerably the earliest in flowering; then follow in order the *whites* and the *purples*, and lastly the *yellows* and *reds*. It follows that the plants included in the British flora clearly tend to arrange themselves, as regards the dates of flowering, in the order of the colours of the spectrum, the average earliest being those which are nearest the part of the spectrum where the actinic rays are at the maximum. It will be observed that the differently-coloured varieties of *Scilla bifolia* are in the same order of flowering of the plants of the same colours in the British flora. Accurate observations, continued from year to year, of the exact dates of flowering of different plants, and particularly of differently-coloured varieties of the same species, could not fail to contribute valuable data to the inquiry referring to the influence of the solar rays, in the development of the more important of the vital functions of plants in different seasons. Whilst it is quite true, as has been pointed out by Mr. R. A. Pryor in NATURE (vol. xiii. p. 150), that flowers of all colours bloom in any of the spring or summer months, it is plain that it is only the method of inquiry by averages that can guide us in the search for the law or laws which regulate the seasonal distribution of colour among flowers. It is scarcely necessary to refer to the importance of this question in its possible applications in the rearing of early and late varieties of flowers and fruits.

ALEXANDER BUCHAN

#### THE WORK OF THE "CHALLENGER" AND THE "VALOROUS"

THE Admiralty have just issued Reports on the Soundings and Temperatures taken by the *Challenger* in the Pacific, and by the *Valorous* during her voyage out with the Arctic Expedition and home again.

Captain Thomson's Report is dated from Honolulu, August 8, 1875, and refers to operations in the Inland Sea and to the section from Yokohama to Honolulu. After some days' cruising in the Inland Sea in May, Captain Thomson returned to Yokohama, nothing of interest to the scientific branch having been obtained. The deepest water found in the longitudinal section during the voyage to Honolulu was 3,980 fathoms, whilst that from the turning-point at 156° west longitude down to Honolulu was 3,025 fathoms. The bottom of this section of the North Pacific showed on nearly every occasion red clay, with manganese and pumice-stone in great quantities; the latter greatly increased as the approach to the Sandwich Islands was made.

Staff-Commander Tizzard makes his preliminary Report on the Temperatures of the North Pacific. From Samboangan nineteen soundings and serial temperatures were obtained in the western part of the North Pacific, from which two sections have been constructed, one from the Meangis Islands to the Admiralty Islands, and the other from the latter to Japan. It was found that when the depth exceeded 1,500 fathoms, the thermometer which regulated the bottom temperatures gave the same results as they did at 1,400 fathoms, viz. 34°·4 (corrected). At a little to the southward of Tongatabu, the bottom

temperature was 32°·9, and as the U.S. officers appear to have obtained colder temperatures at the bottom than any yet obtained by the *Challenger* in the North Pacific, Commander Tizzard thinks it probable that the bed of the Pacific is divided into at least three deep basins by ridges of a not greater depth than 1,400 fathoms from the surface. In the southern part of the western portion of the North Pacific the surface-temperature varied from 80° to 84°, and that in February and March, considerably higher than any yet registered by the *Challenger* in the open ocean.

The Report contains a table of the soundings in the above sections, and four beautifully-constructed sectional charts. The two first show the soundings and isothermal lines from the Meangis to the Admiralty Islands, and between the latter and Japan. The third is intended to illustrate Staff-Commander Tizzard's remarks on the surface temperature of the section referred to above; and the fourth shows the soundings and isothermal lines between Nosema Head, Japan, and the 180th meridian. One of the most notable features of these charts is the occasional sudden increase in depth; between Japan and the Admiralty Islands, for example, the bottom sinks at one place all at once from about 2,000 fathoms, on both sides, to a depth of 4,500 fathoms.

The *Valorous* on her outward voyage took nineteen soundings in Davis' Straits between 63° 45' and 68° 57' N. lat., the depth being found to vary from 58 to 300 fathoms. The bottom was mostly fine grey sand, mixed with shells, gravel, and stones. On returning south, lower soundings were obtained along the Greenland coast, with much the same results as to bottom. On getting clear of Cape Farewell the course was shaped to cross the Atlantic Ocean between the parallels of 59° and 55°, and to join the soundings westward of Ireland obtained in the *Porcupine* in 1862. The greatest depth obtained was 1,860 fathoms in lat. 57° 50' N., and 44° 52' W. long., with a bottom of Globigerina ooze, and a bottom temperature of 33°·4. In 56° 11' N. lat. and 37° 41' W. long. a depth of 1,450 fathoms was obtained, the bottom Globigerina ooze, and next day in lat. 56° 1' N., long. 34° 42' W., a submarine ridge of 690 fathoms was sounded on with the same description of bottom. On the day following this, in lat. 55° 58', long. 31° 41' W., the depth increased to 1,230 fathoms, mud; the deep sounding of this day and that of the second day previous being equidistant (103 miles) from the intervening shoaler ridge of 690 fathoms. On reaching the 26th meridian of W. long., a westerly gale commenced, which prevented further proceedings. Globigerina ooze, with occasional fine sand and mud, are the main characteristics of this section. Two sectional charts exhibit graphically the data obtained.

#### SCIENCE IN GERMANY

(From a German Correspondent.)

M. PULUJ, of Fiume, has recently published a description of a school-apparatus for determining the mechanical equivalent of heat. The apparatus is of very simple construction, and consists of a calorimetric and a dynamometrical part, which is connected with a rotating arrangement, such as may be found in any physical laboratory.

The calorimetric part of the apparatus is formed of two truncated hollow cones of cast iron, fitting the one into the other. The inner one, *a*, does not quite reach to the bottom of the outer, *b*, and it projects a little above it. The outer cone, *b*, can be fixed, coaxially, into the spool of the driving machine. The inner cone contains mercury. If, now, the driving machine be set a-going and the inner cone held fast, heat is produced through friction of the touching surfaces of the cones.

For measurement of the work transformed into heat, the arrangement is as follows:—To the wooden lid, *c*, of

the inner cone, is screwed a light wooden beam, *f*, horizontally. Through the beam and lid passes a perforation for receiving the thermometer. At a little distance from the beam, *f*, and at the same height, there is a fixed pulley, *g*, over which is passed a cord with a scale at its pendant extremity, while the other end is attached to the end of one arm of the beam (the second arm of the beam acts as counter weight). When the driving machine is

put in action, the cones rub together, and the outer cone tends to carry the inner one and its beam round with it in the direction of rotation. With a certain weight in the scale, the horizontal part of the cord will form with the axis of the beam a right angle. From the length of the beam-arm, the amount of weighting, and the number of rotations, may be deduced the work that is transformed into heat; and from the water value of the calorimeter,

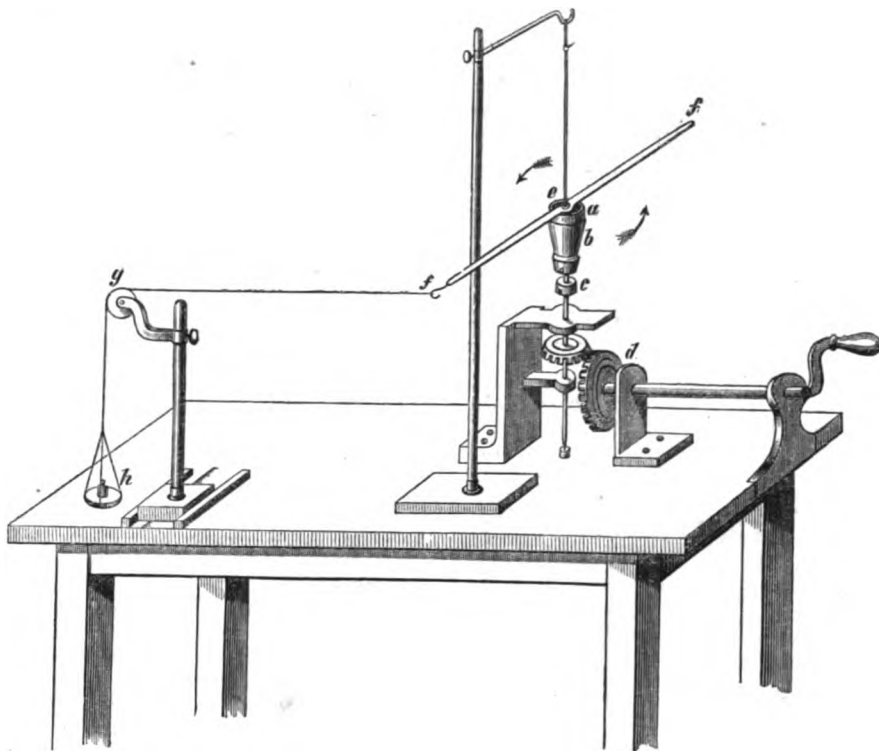

and the increase of its temperature, can be reckoned the quantity of heat produced.

From twenty-eight experiments (in which the amount of heat radiated from the calorimeter was taken into account), the average value obtained for the mechanical equivalent of heat was 425.2, with a mean error  $\pm 5.4$ . A second series of experiments was made, with the arm of the beam in any position with reference to the cord. A simple arrangement—wooden triangle with arc-division—served for measuring the angle which the axis of the

beam-arm formed with its normal position (in which it forms a right angle with the cord). From the observed values of this angle, and from the quantities already referred to, the number obtained for the mechanical equivalent of heat was 426.7, with a mean error  $\pm 5.9$ .

The apparatus is especially to be recommended for lecture-experiments, because the method of experimenting is extremely simple, and the carrying out of the experiment takes very little time. A single experiment occupies 30-60". S. W.

#### THE PHYSICAL OBSERVATORY ON THE PIC DU MIDI

AT a recent sitting of the Paris Academy of Sciences M. Ch. Sainte-Claire Deville made a communication, with reference to the proposed Physical Observatory on the Pic du Midi, in the Pyrenees. He referred to the increasing importance of meteorology, and to its manifold extensions and development in recent years, and to the growing necessity of establishing numerous fixed stations at as high an altitude as is practicable. This has already been done to a considerable extent in India, in America, and in some parts of Europe; in France, as we have already intimated, the Puy de Dôme Observatory is nearly completed. M. Deville then referred to the importance of having a station on the Pyrenees, and to the difficulty of choosing a suitable site. The Pic du Midi de Bigorre, however, unites in itself all the most favourable circumstances. Situated towards the middle of the chain

of the Pyrenees which receive directly the shock of the Atlantic storms, the Pic du Midi stands out from the general crest, and rises to a height of 2,877 metres, only 527 metres below the highest summit of the chain. It commands a magnificent and extensive panoramic view, and is easily accessible from various points. From the sixteenth century downwards it has attracted the attention of men of science, and during the last and thirteenth century a considerable number of notable observers have resorted to the Pic for the purpose of carrying out observations. Darcet, in 1786, obtained from Philippe d'Orleans the promise of 80,000 francs to found an observatory on the mountain, but the political events which rapidly succeeded prevented the scheme from being carried out. Even then a small hut existed on the spot where the Commission, charged by the Ramond Society with carrying out the present scheme, have built another; the former had been built by Vidal and Reboul, who in 1786-7 surveyed the Pic. Ramond, in the early part of

the present century, made about thirty-six ascents of the peak, for the purpose of making barometric observations.

In 1854 a society at Bagnères founded on the Col de Sencours, 511 feet below the Pic, on a hill immediately above the Lake Oncet, a hotel for tourists. It is this hotel which the Ramond Society has used as a temporary observatory, until the Government provide the means of erecting a proper building on the summit of the Pic. On August 1, 1873, the Commission appointed by the Society provided a tolerably complete set of meteorological apparatus on the Col de Sencours. Regular observations were carried on till October 10, when want of funds cut them short. On June 1 of the following year an observer, along with the President of the Commission, General de Nansouty, installed themselves and remained till December 25, when, as we recorded at the time, the severity of the winter, for which they were insufficiently provided, compelled them to beat a precipitate retreat. On June 1 last year, General de Nansouty and M. Baylac again established themselves in the temporary observatory, and it is to be hoped they will be able to remain throughout the whole of the winter. An avalanche did considerable damage to the meteorological hut, and injured several of the instruments; fortunately, however, the observers managed to repair most of the damage done. The instruments which have been provided are of the best kind, and already observations of great value have been made, some of which have been published by the Ramond Society.

This Society determined to accomplish the erection of a proper observatory on the Pic du Midi itself, and has appealed to every quarter from which funds are likely to be obtained. The work of construction has already been begun. The building will be composed of three parts. The dwelling-house, situated seven metres below the summit, is in part subterranean, and will open only on the south side. It communicates by a tunnel with a circular vaulted erection, which will contain the barometer, the magnetic apparatus, &c. At a little distance will be solidly built the Montsouris hut, intended to cover the instruments which must be subjected to the direct influence of the atmosphere.

The work is thus in progress, and there is every reason to believe that it will soon be successfully completed, and the station become one of the most important physical observatories, not only in France, but on the globe.

#### PROF. TYNDALL ON GERMS\*

THE author refers in an introduction to an inquiry on the decomposition of vapours and the formation of actinic clouds by light, whereby he was led to experiment on the floating matter of the air. He refers to the experiments of Schwann, Schröder and Dusch, Schröder himself, to those of the illustrious French chemist Pasteur, to the reasoning of Lister and its experimental verification, regarding the filtering power of the lungs; from all of which he concluded, six years ago, that the power of developing life by the air, and its power of scattering light, would be found to go hand in hand. He thought the simple expedient of examining by means of a beam of light, while the eye was kept sensitive by darkness, the character of the medium in which their experiments were conducted, could not fail to be useful to workers in this field. But the method has not been much turned to account, and this year he thought it worth while to devote some time to the more complete demonstration of its utility.

He also wished to free his mind, and if possible the minds of others, from the uncertainty and confusion which now beset the doctrine of "spontaneous generation." Pasteur has pronounced it "a chimera," and expressed

\* On the Optical Department of the Atmosphere in reference to the Phenomena of Putrefaction and Infection. Abstract of a paper read before the Royal Society, January 13th, by Prof. Tyndall, F.R.S. (Communicated by the author.)

the undoubting conviction that this being so it is possible to remove parasitic diseases from the earth. To the medical profession, therefore, and through them to humanity at large, this question is one of the last importance. But the state of medical opinion regarding it is not satisfactory. In a recent number of the *British Medical Journal*, and in answer to the question, "In what way is contagium generated and communicated?" Messrs. Braidwood and Vacher reply that notwithstanding "an almost incalculable amount of patient labour, the actual results obtained, especially as regards the manner of generation of contagium, have been most disappointing. Observers are even yet at variance whether these minute particles, whose discovery we have just noticed, and other disease germs, are always produced from like bodies previously existing, or whether they do not, under certain favourable conditions, spring into existence *de novo*."

With a view to the possible diminution of the uncertainty thus described, the author submits without further preface to the Royal Society, and especially to those who study the etiology of disease, a description of the mode of procedure followed in this inquiry, and the results to which it has led.

A number of chambers, or cases, were constructed, each with a glass front, its top, bottom, back and sides being of wood. At the back is a little door which opens and closes on hinges, while into the sides are inserted two panes of glass, facing each other. The top is perforated in the middle by a hole 2 inches in diameter, closed air-tight by a sheet of india-rubber. This sheet is pierced in the middle by a pin, and through the pin-hole is passed the shank of a long pipette ending above in a small funnel. A circular tin collar 2 inches in diameter and  $1\frac{1}{2}$  inch high, surrounds the pipette, the space between both being packed with cotton-wool moistened by glycerine. Thus the pipette, in moving up and down, is not only firmly clasped by the india-rubber, but it also passes through a stuffing box of sticky cotton-wool. The width of the aperture closed by the india-rubber secures the free lateral play of the lower end of the pipette. Into two other smaller apertures in the top of the case are inserted, air-tight, the open ends of two narrow tubes, intended to connect the interior space with the atmosphere. The tubes are bent several times up and down, so as to intercept and retain the particles carried by such feeble currents as changes of temperature might cause to set in between the outer and the inner air.

The bottom of the box is pierced with two rows, sometimes with a single row of apertures, in which are fixed air-tight, large test-tubes, intended to contain the liquid to be exposed to the action of the moteless air.

On Sept. 10 the first case of this kind was closed. The passage of a concentrated beam across it through its two side windows then showed the air within it to be laden with floating matter. On the 13th it was again examined. Before the beam entered, and after it quitted the case, its track was vivid in the air, but within the case it vanished. Three days of quiet sufficed to cause all the floating matter to be deposited on the sides and bottom, where it was retained by a coating of glycerine, with which the interior surface of the case had been purposely varnished. The test-tubes were then filled through the pipette, boiled for five minutes in a bath of brine or oil, and abandoned to the action of the moteless air. During ebullition aqueous vapour rose from the liquid into the chamber, where it was for the most part condensed, the uncondensed portion escaping, at a low temperature, through the bent tubes at the top. Before the brine was removed little stoppers of cotton-wool were inserted in the bent tubes, lest the entrance of the air into the cooling chamber should at first be forcible enough to carry motes along with it. As soon, however, as the ambient temperature was assumed by the air within the case, the cotton-wool stoppers were removed.



We have here the oxygen, nitrogen, carbonic acid, ammonia, aqueous vapour, and all the other gaseous matters which mingle more or less with the air of a great city. We have them, moreover, "untortured" by calcination and unchanged even by filtration or manipulation of any kind. The question now before us, can air thus retaining all its gaseous mixtures, but self-cleansed from mechanically suspended matter, produce putrefaction? To this question both the animal and vegetable worlds return a decided negative.

Among vegetables experiments have been made with hay, turnips, tea, coffee, hops, repeated in various ways with both acid and alkaline infusions. Among animal substances are to be mentioned many experiments with urine; while beef, mutton, hare, rabbit, kidney, liver, fowl, pheasant, grouse, haddock, sole, salmon, cod, turbot, mullet, herring, whiting, eel, oyster have been all subjected to experiment.

The result is that infusions of these substances exposed to the common air of the Royal Institution laboratory, maintained at a temperature of from 60° to 70° Fahr., all fell into putrefaction in the course of from two to four days. No matter where the infusions were placed, they were infallibly smitten. The number of the tubes containing the infusions was multiplied till it reached six hundred, but not one of them escaped infection.

In no single instance, on the other hand, did the air, which had been proved moteless by the searching beam, show itself to possess the least power of producing Bacterial life or the associated phenomena of putrefaction. The power of developing such life in atmospheric air, and the power of scattering light, are thus proved to be indissolubly united.

The sole condition necessary to cause these long-dormant infusions to swarm with active life is the access of the floating matter of the air. After having remained for four months as pellucid as distilled water, the opening of the back-door of the protecting case, and the consequent admission of the mote-laden air, suffice in three days to render the infusions putrid and full of life.

That such life arises from mechanically suspended particles is thus reduced to ocular demonstration. Let us inquire a little more closely into the character of the particles which produce the life. Pour Eau de Cologne into water, a white precipitate renders the liquid milky. Or, imitating Brücke, dissolve clean gum mastic in alcohol, and drop it into water, the mastic is precipitated, and milkiness produced. If the solution be very strong the mastic separates in curds; but by gradually diluting the alcoholic solution we finally reach a point where the milkiness disappears, the liquid assuming, by reflected light, a bright cerulean hue. It is, in point of fact, the colour of the sky, and is due to a similar cause, namely, the scattering of light by particles, small in comparison to the size of the waves of light.

When this liquid is examined by the highest microscopic power it seems as uniform as distilled water. The mastic particles, though innumerable, entirely elude the microscope. At right angles to a luminous beam passing among the particles they discharge perfectly polarised light. The optical deportment of the floating matter of the air proves it to be composed, in part, of particles of this excessively minute character. When the track of a parallel beam in dusty air is looked at horizontally through a Nicol's prism, in a direction perpendicular to the beam, the longer diagonal of the prism being vertical, a considerable portion of the light from the finer matter is extinguished. The coarser motes, on the other hand, flash out with greater force, because of the increased darkness of the space around them. It is among the finest ultra-microscopic particles that the author shows the matter potential as regards the development of Bacterial life is to be sought.

But though they are beyond the reach of the micro-

scope, the existence of these particles, foreign to the atmosphere but floating in it, is as certain as if they could be felt between the fingers, or seen by the naked eye. Supposing them to augment in magnitude until they come, not only within range of the microscope, but within range of the unaided senses. Let it be assumed that our knowledge of them under these circumstances remains as defective as it is now—that we do not know whether they are germs, particles of dead organic dust, or particles of mineral matter. Suppose a vessel (say a flower-pot) to be at hand filled with nutritious earth, with which we mix our unknown particles; and that in forty-eight hours subsequently buds and blades of well-defined cresses and grasses appear above the soil. Suppose the experiment when repeated over and over again to yield the same unvarying result. What would be our conclusion? Should we regard those living plants as the products of dead dust or mineral particles; or should we regard them as the offspring of living seeds? The reply is unavoidable. We should undoubtedly consider the experiment with the flower-pot as clearing up our pre-existing ignorance; we should regard the fact of their producing cresses and grasses as proof positive that the particles sown in the earth of the pot were the seeds of the plants which have grown from them. It would be simply monstrous to conclude that they had been "spontaneously generated."

This reasoning applies word for word to the development of *Bacteria* from that floating matter which the electric beam reveals in the air, and in the absence of which no Bacterial life has been generated. There seems no flaw in this reasoning; and it is so simple as to render it unlikely that the notion of Bacterial life developed from dead dust can ever gain currency among the members of a great scientific profession.

A novel mode of experiment has been here pursued, and it may be urged that the conditions laid down by other investigators in this field, which have led to different results, have not been strictly attended to. To secure accuracy in relation to these alleged results, the latest words of a writer on this question, who has influenced medical thought both in this country and in America, are quoted. "We know," he says, "that boiled turnip or hay-infusions exposed to ordinary air, exposed to filtered air, to calcined air, or shut off altogether from contact with air, are more or less prone to swarm with *Bacteria* and vibrios in the course of from two to six days." Who the "we" are who possess this knowledge is not stated. The author is certainly not among the number, though he has sought anxiously for knowledge of the kind. He thus tests the statements in succession.

And first, with regard to the filtered air. A group of twelve large test-tubes were caused to pass air-tight through a slab of wood. The wood was coated with cement, in which, while hot, a heated "propagating glass" resembling a large bell-jar was imbedded. The air within the jar was pumped out several times, air filtered through a plug of cotton-wool being permitted to supply its place. The test-tubes contained infusions of hay, turnip, beef, and mutton—three of each—twelve in all. They are as clear and cloudless at the present moment as they were upon the day of their introduction; while twelve similar tubes, prepared at the same time in precisely the same way and exposed to the ordinary air, are clogged with mycelium, mould, and *Bacteria*.

With regard to the calcined air, a similar propagating glass was caused to cover twelve other tubes filled with the same infusions. The "glass" was exhausted and carefully filled with air which had passed through a red-hot platinum tube, containing a roll of red-hot platinum gauze. Tested by the searching beam, the calcined air was found quite free from floating matter. Not a speck has invaded the limpidity of the infusions exposed to it, while twelve similar tubes placed outside have fallen into rottenness.

The experiments with calcined air took another form. Six years ago it was found that to render the laboratory air free from floating matter, it was only necessary to permit a platinum wire heated to whiteness to act upon it for a sufficient time. Shades, containing pear juice, damson juice, hay- and turnip-juice, and water of yeast, were freed from their floating matter in this way. The infusions were subsequently boiled and permitted to remain in contact with the calcined air. They are quite unchanged to the present hour, while the same infusions exposed to common air became mouldy and rotten along ago.

It has been affirmed that turnip- and hay-infusions rendered slightly alkaline are particularly prone to exhibit the phenomena of spontaneous generation. This was not found to be the case in the present investigation. Many such infusions have been prepared, and they have continued for months without sensible alteration.

Finally, with regard to infusions wholly withdrawn from air, a group of test-tubes, containing different infusions, was boiled under a bell-jar filled with filtered air, and from which the air was subsequently removed as far as possible by a good air-pump. They are now as pellucid as they were at the time of their preparation, more than two months ago, while a group of corresponding tubes exposed to the laboratory air have all fallen into rottenness.

There is still another form of experiment on which great weight has been laid—that of hermetically sealed tubes. On April 6 last, a discussion on the "Germ Theory of Disease" was opened before the Pathological Society of London. The meeting was attended by many distinguished medical men, some of whom were profoundly influenced by the arguments, and none of whom disputed the facts brought forward against the theory on that occasion. The following important summary of these was then given:—"With the view of settling these questions, therefore, we may carefully prepare an infusion from some animal tissue, be it muscle, kidney, or liver; we may place it in a flask whose neck is drawn out and narrowed in the blowpipe-flame, we may boil the fluid, seal the vessel during ebullition, and keeping it in a warm place, may await the result, as I have often done. After a variable time the previously heated fluid within the hermetically sealed flask swarms more or less plentifully with *Bacteria* and allied organisms."

Previous to reading this statement the author had operated upon tubes of hay- and turnip-infusions, and upon 21 tubes of beef, mackerel, eel, oyster, oatmeal, malt, and potato, hermetically sealed while boiling, not by the blowpipe, but by the far more handy spirit-lamp flame. In no case was any appearance whatever of *Bacteria* or allied organisms observed. The perusal of the discussion just referred to caused the author to turn again to muscle, liver, and kidney, with a view of varying and multiplying the evidence. Fowl, pheasant, snipe, partridge, plover, wild duck, beef, mutton, heart, tongue, lungs, brains, sweetbread, tripe, the crystalline lens, and vitreous humour of an ox, herring, haddock, mullet, codfish, sole, were all embraced in the experiments. There was neither mistake nor ambiguity about the result. One hundred and thirty-nine of the flasks operated on were exhibited, and not one of this cloud of witnesses offers the least countenance to the assertion that liquids within flasks, boiled and hermetically sealed, swarm, subsequently, more or less plentifully with *Bacteria* and allied organisms.

The evidence furnished by this mass of experiments, that errors either of preparation or observation have been committed, is, it is submitted, very strong. But to err is human; and in an inquiry so difficult and fraught with such momentous issues, it is not error, but the persistence in error by any of us, for dialectic ends, that is to be deprecated. The author

shows by illustrations the risks of error run by himself. On Oct. 21 he opened the back-door of a case containing six test-tubes filled with an infusion of turnip which had remained perfectly clear for three weeks, while three days sufficed to crowd six similar tubes exposed to mote-laden air with *Bacteria*. With a small pipette he took specimens from the pellucid tubes, and placed them under the microscope. One of them yielded a field of Bacterial life, monstrous in its copiousness. For a long time he tried vainly to detect any source of error, and was perfectly prepared to abandon the unvarying inference from all the other experiments, and to accept the result as a clear exception to what had previously appeared to be a general law. The cause of his perplexity was finally traced to the tiniest speck of an infusion containing *Bacteria*, which had clung by capillary attraction to the point of one of his pipettes.

Again, three tubes containing infusions of turnip, hay, and mutton, were boiled on Nov. 2 under a bell-jar containing air so carefully filtered that the most searching examination by a concentrated beam failed to reveal a particle of floating matter. At the present time every one of the tubes is thick with mycelium and covered with mould. Here surely we have a case of spontaneous generation. Let us look to its history.

After the air has been expelled from a boiling liquid it is difficult to continue the ebullition without "bumping." The liquid remains still for intervals, and then rises with sudden energy. It did so in the case now under consideration, and one of the tubes boiled over, the liquid over-spreading the resinous surface in which the bell-jar was imbedded, and on which, doubtless, germs had fallen. For three weeks the infusions had remained perfectly clear. At the end of this time, with a view of renewing the air of the jar, it was exhausted, and refilled with fresh air which had passed through a plug of cotton-wool. As the air entered, attention was attracted by two small spots of penicillium resting on the liquid which had boiled over. It was at once remarked that the experiment was a dangerous one, as the entering air would probably detach some of the spores of the penicillium and diffuse them in the bell-jar. This was, therefore, filled very slowly, so as to render the disturbance a minimum. Next day, however, a tuft of mycelium was observed at the bottom of one of the three tubes, namely that containing the hay-infusion. It has by this time grown so as to fill a large portion of the tube. For nearly a month longer the two tubes containing the turnip- and mutton-infusions maintained their transparency unimpaired. Late in December the mutton-infusion, which was in dangerous proximity to the outer mould, showed a tuft upon its surface. The beef-infusion continued bright and clear for nearly a fortnight longer. The recent cold weather caused me to add a third gas-stove to the two which had previously warmed the room in which the experiments are conducted. The warmth of this stove played upon one side of the bell-jar; and on the day after the lighting of the stove, the beef-infusion gave birth to a tuft of mycelium. In this case the small spots of penicillium might have readily escaped attention; and had they done so we should have had three cases of "spontaneous generation" far more striking than many that have been adduced.

(To be continued.)

#### NOTES

M. E. QUETELET has issued a Notice giving a brief account of the recent progress of the Brussels Observatory, which has been established only in the face of great difficulties. In 1833 meteorological observations were commenced to be made, and a few years after astronomical observations were added by the elder Quetelet. The work which is at present being carried on has for its object a general revision of the variable stars. Seventy

thousand positions have already been collected—forty thousand for right ascensions and thirty thousand for declinations. Two-thirds of these observations are published, the rest is calculated, and will be printed as soon as the resources of the Observatory permit. For fifty years a series of observations have been carried on in reference to the variations of the magnetic needle at Brussels, the results of which M. Quetelet hopes to be able by and by to publish. He, however, feels that if Brussels is to keep up with the science of the day, much remains to be done. A Commission appointed in 1874 to report on the Observatory gave in their report at the end of that year, and their principal conclusions are as follows:—To complete the magnetic system of the Observatory by the acquisition of self-registering instruments, to organise the International Meteorological Service, to obtain an equatorial of large dimensions with the accessories necessary to the spectroscopic investigation of the heavens, and to increase the number and improve the position of the observer. The Ministry have, unfortunately, not yet come to a decision on these conclusions, though we hope they may do so soon, and enable the valuable work of the Observatory to be carried on with complete efficiency, and the results be regularly given to the scientific world. Meanwhile, the work of the Observatory is being regularly carried on on the old lines.

THE new Aquarium at Westminster was opened on Saturday last by the Duke of Edinburgh; but though the building is sufficiently complete for concerts to be held, it will be many weeks before the tanks are in a proper condition to receive water. The arrangements connected with the aquarium proper have been under the direction of Mr. W. A. Lloyd, who planned the Crystal Palace and other aquaria. There are in this latest development of aquarium construction two or three new points worthy of attention. The water in flowing from one tank to another will overflow from one and pass down a tube, so that it enters the next at the bottom, by which means a more thorough mixture than has hitherto been attained will be ensured of the water that has been exposed to the surface aëration. The reservoir which occupies the space under the large hall is divided into nine compartments, so that in case of an accident to any part, it can be cleared of the water and repaired while the other sections remain in operation. The total capacity of the reservoir is 600,000 gallons, and the total amount of water in reservoir and tanks together will be 750,000 gallons. For the circulation eight rotary vulcanite pumps are erected, and they are capable of sending 56,000 gallons an hour through the tanks if needed, to meet any emergency, though it is calculated that 15,000 to 20,000 gallons will be about the average amount. The plan of forcing downwards small jets of water into each tank, as at the Crystal Palace, is adopted. In the anemone tanks the water will be periodically emptied, representing, to some extent, tidal action. The salmon will have a fifty-foot run, and so will the wrasse. All the pipes, culverts, &c., are of vulcanite, but the glass fronts of the tanks are fitted in cork, with the exception of some of the limestone rock-work, which may probably be too soluble; everything that forethought could arrange in accordance with our present knowledge seems to have been attended to. It is to be hoped that the scientific results obtained will not be out of proportion to the cost of the undertaking. The official guide-book published on Saturday contains a useful article on aquarium management by Mr. Lloyd, and the *Gardeners' Magazine* of last week has also a contribution from his pen on the rise and progress of aquaria in England; the *Morning Post* of Saturday last contained an interesting article. The cover of the official guide-book is ornamented with a woodcut by Tenniel, which is quite equal to his happiest efforts in *Punch*.

THE Committee of Science of the Irish Academy will meet on Feb. 28 to take into consideration applications for assist-

ance out of the parliamentary grant for the preparation of scientific reports; and it is requested that all such applications be forwarded to the secretary on or before that date.

THE Montsouris Observatory has been supplied with a number of recording apparatuses for barometric pressures constructed on new principles, and instruments for recording thermometric variations have been made on aneroid and bi-metallic principles. A steel needle guided by these dilatations traces a curve on a rotating cylinder. The anemometer records by a magnetic contrivance devised by M. Mangon. M. Marie Davy has also established an apparatus for recording the pressure exerted by the wind. A specially devised mirror has been arranged to indicate the direction of the clouds, which it is rather difficult to discover from direct inspection of the clouds themselves.

DR. SAMUEL BIRCH has been appointed to the Rede Lectureship in the University of Cambridge. He will deliver his lecture about Easter.

AT the January meeting of the Photographic Society, the hon. secretary read a note on the action of eosin on the photographic spectrum, by Captain J. Waterhouse, B.S.C., assistant surveyor-general of India. Tetrabromfluorescin, or eosin as it is termed commercially, is a dye remarkable for its intense fluorescence and beautiful pink colour. Its absorption spectrum is characterised by a very strong band between E and F, which fades off on either side and terminates half way between D and E, and half way between F and G. At the part of the spectrum indicated, photographic action was increased to a marked degree when the collodion was stained with the dye. Captain Waterhouse naturally inferred that greens, e.g. foliage, would exhibit more detail if photographed on eosin-stained plates, but this was not the case, the only effect was to make the whole action of the light slower. Vogel's observations have thus been confirmed so far as the spectrum effects are concerned; the want of action when coloured surfaces are photographed is however at variance with his results obtained, we believe, by photographing coloured papers. By the kindness of Mr. John Spiller, to whom Captain Waterhouse's letter was addressed, we have been enabled to see some of his spectrum photographs, and they certainly surpass any results of the kind we have yet seen.

The *Journal d'Hygiène*, No. 8, of Dr. Prosper de Pietra Santa, contains several articles of interest. The *Climat de Pau* gives a brief *résumé* of the meteorological characteristics of this place, in which special prominence is given to the chief feature of its climate, viz. the remarkable calmness of its atmosphere, which, combined with a light porous soil draining away the rains as they fall, and the great beauty of its environs, have made the reputation of Pau as a desirable winter and spring sanatorium. In *L'Emigration dans le Midi de la France* attention is directed to the varied climates of France in their therapeutic relations, which are classed, according to their characteristics in these respects, into sea-climates, such as Cannes, Menton, Ajaccio, and parts of Nice, Hyères, and Alger; hill climates, such as Pau, Orthez, Le Cannet, and parts of Nice, Hyères, and Alger; and mixed or intermediate climates, such as Arcachon, Vernet, and Amélie-les-Bains. The determination landward of sea climates which are considered as consisting in an atmosphere containing a minimum of miasmatic matters, a maximum of oxygen, the air impregnated with fine particles of chloride of sodium, and with a peculiar odour derived from marine plants charged with bromine and iodine, is a point of considerable importance.

THE *Bulletin International* of the Paris Observatory of the 18th inst. is the first number of a new issue, executed by the printing establishment of MM. Yves and Barrel, by the process of photo-engraving, of which a brief account is given. The

whole process occupies only from two and a half to three hours. The greatest care will continue to be taken to make the *Bulletin* a medium of the most recent information relating to astronomy and meteorology, particularly the meteorology of each of the regional districts, so as to secure that unity of action among French meteorologists without which nothing of real importance can be done.

In the *Bulletin International* of the Observatory of Paris for the 13th inst. is given a table showing the depth of the water of the Seine at Paris on each day during 1875 by two gauges, one placed on the Pont de la Tournelle, and the other on the Pont Royale. The gauge on the Pont de la Tournelle is graduated from the point to which the water of the Seine fell during 1719. The mean height of the Seine during 1875 was  $2\frac{1}{2}$  feet, the maximum height  $10\frac{1}{2}$  feet on Jan. 28, and the minimum  $\frac{1}{2}$  foot below the zero of the scale. The greatest flood hitherto recorded was 27 feet in 1658, and the greatest drought  $3\frac{1}{2}$  feet below zero on Sept. 29, 1865.

It is announced that the *Atlas Météorologique* for the years 1872-73-74 will appear in a few days, and it is hoped that the *Atlas* for 1875 will be ready for issue in the end of July next.

A MICROSCOPICAL club has been founded at Honolulu, which promises to be very successful. The visit of the *Challenger* to the Sandwich Islands seems to have been the immediate occasion of this laudable step being taken, as the late Dr. Von Willemoes-Suhm is mentioned in connection with it. Already there are forty members, who have subscribed 800 dollars to purchase a large microscope from Beck and Smith of London. The club will find plenty of work in the investigation of the natural history of these interesting islands, and we hope the members will not confine their investigations merely to microscopical subjects.

OUR readers no doubt know that we have a younger French sister who appears under the name of *La Nature*. We have just received from Germany a specimen of another of the family, rejoicing in the name of *Die Natur*. This seems, however, to be a new series of an old-established journal, but whether it has always appeared under its present name we cannot make out. It is conducted by Dr. Otto Ule and Dr. Karl Müller, of Halle, is mainly devoted to natural history, and the number sent us contains several interesting articles; among these is one on the African Steppes, by Dr. Ule.

At the Royal Geographical Society, on Monday night, Sir H. C. Rawlinson intimated that Lieut. Cameron was still at Loando, and would remain there until he saw his men safely embarked for their homes in East Africa. He will stay two months in Madeira to recruit his health before returning to England, where he is expected soon after Easter. Sir Henry stated that the map of Cameron's route would probably be ready by the time of the next meeting of the Society, as also the extremely valuable register of his observations. Major-General Sir F. M. Goldsmid then read a paper on the recent journey of Capt. G. Napier on the Turcoman frontier of Persia.

SUCCESSFUL experiments have been carried on by the French Great Northern Railway at Paris with electric lighting. With a steam-engine of three-horse power, a light equal to 100 ordinary lamps, each consuming 150 litres of gas per hour, has been obtained regularly for almost any length of time. It is contemplated by the engineers of the company to place four electric lamps in the large nave, which is 200 metres long and 60 metres high. The lighting of the company's workshops at La Chapelle will also be attempted with ten lamps. The buildings cover forty acres, and are now lighted by 700 gas lamps. It is stated that the Lyons Company will try to make use of Gramme's magneto-electric machines to light up the way.

THERE will be an examination at Gonville and Caius College, Cambridge, on the 4th of April, for two Shuttleworth Scholarships, each of the value of 60*l.* per annum, and tenable for three years. The subjects of examination are Botany and Comparative Anatomy in its most general sense (including Zootomy and Comparative Physiology). Candidates must be registered medical students of the University of Cambridge who shall have kept not less than eight terms, have passed the additional examination required for candidates for honours, and produce satisfactory testimonials of good conduct. For farther information apply to the Rev. N. M. Ferrers, Tutor of the College.

THE trustees of the Johnson Memorial Prize, Oxford, propose the following subject for an essay:—“The History of the successive stages of our knowledge of Nebulæ, Nebulous Stars, and Star-clusters from the time of Sir William Herschel.” The Prize is open to all members of the University of Oxford. Candidates are to send their Essays to the Registrar of the University under a sealed cover marked “Johnson Memorial Prize Essay,” on or before the 31st day of March, 1879.

PROF. DEWAR commences his lectures as Jacksonian Professor at Cambridge on Tuesday next; the subject is Organic and Animal Chemistry.

WE have received a very significant publication from the Chief Inspector of Mines of Victoria, Australia, in the form of a large sheet printed in Chinese, and containing the provisions of the Regulation of Mines Statute for the colony. There are, we believe, 11,294 Chinese miners in Victoria, many of whom know nothing of the English language. In some of the districts they are employed in quartz and in alluvial mines of great depth, and the Victorian Government have acted wisely in taking this method to make them acquainted with the mining regulations.

THE Report of the Kew Committee for the year ending Oct. 31, 1875, shows that the usual work at the Kew Observatory has been diligently carried on during the past year.

WE have received from their respective publishers “The Year-Book of Photography” (Piper and Carter, Gough Square, E.C.) and the “British Journal Photographic Almanac” (H. Greenwood, York Street, Covent Garden). Both contain many admirable articles on photographic subjects, but it is to be regretted that, failing a more scientific treatment of the art and the development of new methods of manipulation, these annuals, instead of recording progress, serve up the same weary course of glass-cleaning, bath treatment, posing, lighting, and printing, year after year. The frontispiece to the “British Journal Photographic Almanac” is a charming child study by Faulkner, entitled “Simplicity,” but is by no means an admirable example of photo-mechanical printing.

A FURTHER attempt is being made to introduce salmon into the Antipodes this year under perfectly new conditions. The New Zealand Government and Sir Samuel Wilson, of the Victoria Acclimatisation Society, had simultaneously asked Mr. Buckland to undertake the task of sending ova to Otago and Melbourne respectively. Mr. Buckland, in conjunction with Mr. J. A. Youl, arranged to make both shipments at once, and the eggs, collected in the Severn, Dart, Ribble, and other rivers, have accordingly been sent out, packed in moss and ice, by steamer, to Melbourne. The passage is estimated to occupy about fifty days. One portion of the eggs will be landed at Melbourne, and the others, if they are in good condition, will be at once repacked and transhipped for Otago, where they are estimated to arrive about a fortnight or three weeks after leaving Melbourne. The eggs were all in proper condition when they left London on board the *Durham*, and there is every prospect of their reaching Melbourne, at least, in safety.

By a curious coincidence, intelligence has just reached us of the safe arrival in Auckland, New Zealand, of 40,000 salmon eggs from the Columbia River, North-west America. These eggs were sent from San Francisco by steamer, consigned to the Napier Acclimatisation Society; but on arrival at Auckland they were found to be so far advanced that it was determined not to risk sending them all to Napier, but to distribute them immediately in suitable localities in the neighbourhood. One half was thus treated, and the remaining 20,000 were sent on to their original destination, Napier. There is every probability that an actual colony of salmon has now been planted in New Zealand, for the fry were in a very healthy condition, and great care was taken by Mr. Firth to protect those placed in the rivers from all possible enemies.

THE last issued number of the Transactions of the Institute of Engineers and Shipbuilders of Scotland contains a paper, by Prof. James Thomson, on "Comparison of Similar Structures as to Elasticity, Strength, and Stability."

In a report published by General Chanzy, Governor-General of Algeria, it appears that the organisation of a sanitary service has been completed all over a country which is larger than Great Britain. In every district has been established a *médecin de colonisation*, who is appointed after having passed a special examination, is paid by Government, and is not allowed to take fees.

A PAPER on the *Batrachia* and *Reptilia* of Costa Rica, with notes on the reptiles of Nicaragua and Peru, by Prof. Cope, has recently appeared in the quarto journal of the Philadelphia Academy of Natural Sciences. Most of the Costa Rican materials were obtained from the researches of Dr. William M. Gabb, who was engaged for several years in exploring that country in behalf of the Costa Rican Government, by which he has added very largely to our knowledge of the geography, geology, general natural history, and ethnology of the region. He has already published many papers in all these departments, and it is to him we owe our only reliable information in regard to the Costa Rican aborigines. The first series of the collections made by Dr. Gabb have all been presented by him to the National Museum, in Washington, and they constitute a highly valued portion of the extensive collections of the establishment. Other collections employed in this memoir are those of Dr. Van Patten and Mr. C. N. Riotti, these covering the region extending from the Atlantic to the Pacific. Eighty-nine species were furnished by Prof. Gabb, of which thirty-seven were new to science. The total number of species known from all investigators in Costa Rica is 132, and it is probable that a large number yet remain to be discovered, showing that the region is rich in terrestrial cold-blooded vertebrates.

THE additions to the Zoological Society's Gardens during the past week include a Leopard (*Felis pardus*) from Africa, presented by Mr. F. Elton; a Black Lemur (*Lemur macaco*) from Madagascar, presented by Mr. Dugald Gilchrist; a Common Marmoset (*Haple jacchus*) from Brazil, presented by Master F. F. Goodliffe; two Gannets (*Sula bassana*), European, presented by Lieutenant-Colonel Dugmore; a Rose Hill Parrakeet (*Platycercus eximius*) from New South Wales, presented by Mr. J. Smith; a Roseate Cockatoo (*Cacatua roseicapilla*) from Australia, presented by Dr. Bree; three Brazilian Caracaras (*Polyborus brasiliensis*) from South America, deposited; a Coypu Rat (*Myopotamus coypus*), a Spotted Cavy (*Calogenys paca*), a Central American Agouti (*Dasyprocta punctata*) from South America, a White-spotted Crake (*Porzana notata*) captured at sea off Cape Santa Maria, three Geoffroy's Terrapins (*Platemys geoffroyana*) from the Argentine Republic, a Maximilian's Terrapin (*Hydro-medusa maximiliani*) from Brazil, purchased.

## SCIENTIFIC SERIALS

THE current number of the *Quarterly Journal of Microscopical Science* commences with a memoir, by Dr. G. Thin, on the structure of hyaline cartilage as found by immersing it in a solution of caustic potash at 107° F., and otherwise. A successful potash preparation shows flattened polygonal cells adhering to each other exactly like an epithelium. Much manipulatory experience is necessary for the demonstration of these, and it must be mentioned that the author has "a strong conviction of the uniformity of plan in the general structure of the tissues."—Mr. Hugh Price writes on a polystomatous condition of the hydranths of *Cordylophora lacustris*, and figures his specimens. His observations tend to show that the polystomatous condition may be due to injury of the parent hydranth.—Prof. E. R. Lankester, F.R.S., contributes two papers; the first, including further observations on a peach, or red-coloured Bacterium (*Bacterium rubescens*), in which a further account of that organism is given. The second is a valuable account of Prof. Haeckel's recent additions to the Gastræa-theory, illustrated by four important plates exemplifying the letterpress. The following terms are fully explained: Palingeny and Cenogeny, the tendency to recapitulation and to suppress the details of ontogenetic development; Heterochrony and Heterotopy, the perturbations in ontogeny as regards time and space. The conceptions with which these terms are associated must be fully mastered by all who study evolution from its developmental aspect. The four chief types of egg-cleavage and of Gastrula-formation are then explained, and the stages which each undergo, the monerula-, cytula-, morula-, blastula-, and gastrula-stages are recounted, the prefixes archi-, amph-, disco-, and peri- being applied to the four respectively. The nomenclature, though at first apparently formidable, much simplifies this otherwise complex subject.—Mr. C. S. Tomes, in writing on the development of teeth, gives a summary of the many and important results at which he has arrived in his valuable researches, together with the investigations of others which bear on the subject. Goodsir's primary open dental groove is shown to have no existence. In reality an ingrowth is shown to develop from the deep layer of the epithelium, consisting of a double layer of cells burrowing down into the submucous tissue, and looking in transverse section like a tubular gland. The next stage consists of an active growth of cells in the deepest end of the epithelial inflection, the immediately subjacent tissue at almost the same time becoming elevated at corresponding points where teeth are to be developed; the subjacent tissue forming a conical papilla, the enamel organ appearing with or even before the papilla. Many important points in the tooth-development of the lizard and fish are also discussed.—Dr. Percival Wright has a note on *Stenogramma interrupta*, in which the author proves that the tetrasporic fruit of that rare and beautiful Alga was described by Dr. W. H. Harvey, contrary to the assertion of Mr. E. M. Homes.—Mr. W. Bevan Lewis describes the best methods of making preparations of sections of cerebral and cerebellar cortex for microscopical examination.—Mr. H. C. Sorby, F.R.S., has a paper on the evolution of Hæmoglobin, based mainly on the fact that the centres of the hæmoglobin bands from the red blood of *Planorbis* lie two and a half or three millionths of a millimetre nearer the blue end of the spectrum than do those of vertebrate blood.—Reviews of Dr. Klein's "Anatomy of the Lymphatic System," Part II., and of the English translation of Frey's "Histology and Histochemistry of Man," are also given, followed by notes, proceedings of societies, &c.

THE number for July 1875 of Siebold and Kölliker's *Zeitschrift für Wissenschaftliche Zoologie* opens with a valuable contribution by Dr. Claus, to our knowledge of the parasitic Copepoda, under the following headings:—The genus *Hersilia*; the classificatory value of the oral apparatus; the Ergasilidæ; the Nereidicolidæ; the Ascidicolidæ; the Siphonostoma, and the genus *Lamproglana*. Several excellent plates illustrate the paper. Dr. Claus concludes that a natural classification is at present impossible, because of the gaps in our knowledge of many points in the organisation and development of these remarkable parasites.—Dr. Ludwig Stieda gives a detailed description of the general and microscopic structure of the brain and spinal cord in the Chelonia, derived from the examination of *Testudo Græca* and *Emys Europæa*—a much-needed acquisition.—Dr. Ludwig Graff describes several new species of Turbellaria.—O. Bütschli, in a controversial article on the Infusoria, contests the received interpretations of the phenomena following their conjugation, and endeavours to show that Hæckel and Claus have made no real

advance in the morphology of Infusoria by their recent researches.—Prof. Selenka contributes a concise but very interesting account of the development of *Phascalosoma elongatum* from impregnation to the fourth day, beyond which his specimens did not develop. The changes in the first few hours after impregnation are carefully figured at brief intervals; the formation of the alimentary canal by invagination was very clearly made out. Prof. Selenka contemplates publishing a monograph on the Gephyreans.—Prof. H. Nitsche gives a preliminary account of his researches on the structure and budding of *Loxosoma Kefersteinii*; the most important result he claims to have demonstrated is the exclusive origin of the bud from the ectoderm of the parent, so that there is a direct conversion of ectodermal elements of the parent into entoderm elements of the offspring.—Dr. Anton Dohrn gives a full account of the regulations and management of his zoological station at Naples.

The September number of the same journal opens with some very interesting observations made in the aquarium at the Naples Zoological Station by Prof. Kollmann, chiefly relating to the Cephalopods. The most notable paper is one by Dr. Malbranc on the lateral lines and their sense-organs in Amphibia. The positions in which these organs occur are described and figured for a number of species in each main division of Amphibia, the nerves which supply the lateral-organ system are traced, especially the distribution of branches of the vagus, and the microscopic structure of the organs is described and figured. He shows their intimate correspondence in structure with the taste-goblets of the Tadpole, the similarity of the characteristic cells being remarkable. The discovery of taste-goblets in many species of Amphibia is also recorded, and is to form the subject of another paper.—Prof. Kollmann contributes a paper describing his investigations on the circulation in Aplysiaz, Lamellibranchs, and Cephalopods. Among the most important of his conclusions are that Aplysiaz and Lamellibranchs have arterial hearts, and that there is not really any lacunar system in Cephalopods. He has also made very careful investigations as to the admission of water into the blood in many Mollusca.—O. Bütschli gives a brief contribution on the development of *Cucullanus elegans*, showing the formation of its embryo by a process of involution. It is connected in several important characters with the embryo of Sagitta.—Dr. Dohrn has a paper of fragmentary notices on Insect Development, devoted principally to points in the development of the Silkworm and the Mole-cricket.—One of Dr. von Willemoes-Suhm's letters from the *Challenger* concludes the number.

*Reichert and Du Bois Reymond's Archiv*, Nov. 1875.—This number includes a continuation of Robert Hartmann's contributions to the knowledge of the anthropomorphic primates, dealing with the osteology of a number of specimens of chimpanzee collected by Dr. Schweinfurth; the conclusion of Paul Mayer's elaborate account of the anatomy of *Pyrrhocoris apterus*; and an article by L. Dittmer on the theory of double monsters.

## SOCIETIES AND ACADEMIES

LONDON

Chemical Society, Jan. 20.—Prof. Odling, F.R.S., vice-president, in the chair.—Dr. Armstrong exhibited a specimen of pure crystallised glycerin from Messrs. Dunn and Co., of Stratford.—Mr. E. Neison then communicated a note on sebate of cobalt.—After which Dr. C. R. A. Wright gave an abstract of Part IV. of the researches by himself and Mr. G. H. Beckett on narcotine, cotarine, and hydrocotarine; on oxynarcotine, a new opium educt, and its relationship to narcotine and narceine.—The last paper was on a method for estimating bismuth volumetrically, by Mr. M. M. P. Muir.

Zoological Society, Jan. 18.—Mr. Robert Hudson, F.R.S., vice-president, in the chair.—Prof. A. H. Garrod read a paper on a peculiarity in the carotid arteries and on other points in the anatomy of the Ground Hornbill (*Bucorvus abyssinicus*).—Mr. Edward R. Alston read a paper on the classification of the order Glires. Lilljeborg's sub-orders *Glires simplicidentati* and *duplicidentati* were recognised, the former being divided into sections equivalent to Brandt's sub-orders *Sciuromorphi*, *Myomorphi*, and *Hystricomorphi*. A third sub-order was proposed for the reception of the fossil form *Tyotherium*.—A communication was read from Mr. E. A. Liardet, containing notes on the Land Shells of Taviuni, one of the Fiji Islands, with descriptions of several new species.—Mr. E. A. Schäfer read a paper prepared by himself

and Mr. D. J. Williams on the structure of the mucous membrane of the stomach in the kangaroos, in which he gave a minute description of the histological characters of the different portions of this organ.—A communication was read from Mr. W. H. Hudson, containing notes on the habits of the Rails of the Argentine Republic.—The Hon. W. H. Drummond read a paper on African Rhinoceroses, in which he gave reasons for believing in the existence of five species in Africa, including *R. oswelli*, which, however, might probably be merely a variety of *R. simus*.—A communication was read from Mr. E. Pierson Ramsay, containing a continuation of his remarks on the birds met with in North-eastern Queensland, chiefly at Rockingham Bay.—A communication was read from M. L. Taczanowski, containing the description of a spotted deer found in Southern Ussuri, district of Amoorland, for which he proposed the name *Cervus dybowskii*.—Mr. A. G. Butler communicated a revision of the Lepidopterous genus *Teracolus*, with descriptions of the new species.

Geologists' Association, Jan. 7.—Mr. Henry Woodward, F.R.S., vice-president, in the chair.—On the geology of New Zealand, with special reference to the drift of that country, by Dr. Hector, C.M.G., F.R.S. The author first drew attention to the geographical position of the islands, indicating on the South Polar chart their situation relative to known lands of the Antarctic area. Great ice-packs encumber the intervening ocean, circulating around the pole; travelling in a spiral, and thus increasing their distance from the centre. On the meridian of South Shetland, as low as 40° S. latitude, the seas are at all seasons crowded with icebergs, but there is an indentation of the ice-pack opposite Australia and New Zealand, though erratic masses escape sometimes. There are, however, five degrees of latitude off the extreme south of New Zealand, clear of the limit where icebergs are ever found. As regards latitude the islands occupy a position equivalent, in the Northern Hemisphere, to a line between Paris and Algiers. They lie parallel to Australia, 1,200 miles E. by S., and repose on a sub-marine plateau, which, along the west shores of the islands, is submerged to a depth of from 1,200 to 1,300 feet, but further westward terminates in water 6,600 feet deep. The edge of this plateau comes close in shore on the S.W. extremity of the Southern (middle) island. Thus New Zealand is a remnant of a once far more extensive land, whose eastern boundaries are not as yet clearly defined, but the author was disposed to include the Chatham Islands as a portion of it. *North Island*.—The eastern shore is the boldest; foul weather, and consequently denudation, coming from the N.E. The west side is more shelving; but the great volcanic boss of Mount Egmont, which rises at a gentle angle to a conical summit, protrudes its protecting buttresses of lava far into the western sea, and has thus been the means of preserving a great tract of Miocene tertiaries behind it; these constitute some of the best land in the country. *South Island*.—The denudation comes from the west: its western shores also approach nearer to the edge of the plateau, and the mountains of the south-west angle rise from a profound abyss to a height of from 4,000 to 5,000 feet. In the North Island a belt of hard rocks, consisting of the Upper Palæozoics, and the older Mesozoics, constitutes a sort of back-bone, occupying the east-central portions, against which the softer beds of more recent age recline. In the South Island this belt of Upper Palæozoic rocks, constituting the high mountain chain known as the Southern Alps, sweeps down through the centre with an incline towards the west, and then curves round towards the east again quite to the sea on that side. Against these also the Upper Mesozoics and Tertiaries recline. On the west and south of this easterly bend of the belt of the newer Palæozoics a great mass of foliated rocks occur in the province of Otago, constituting the well-known gold-field. In the far south-west we have only crystalline rocks, and these belong to a series which seems to reappear in much of the detached lands of the Southern Ocean, such as Kerguelen's Land, Auckland Islands, &c., where Miocene volcanic rocks also occur. The meteorology of the country, as having an important bearing on the denudation of the surface, was next considered. Referring principally to the Southern Island, we have here the mixing point of the N.E. and S.W. currents. On the west side, at Okitika, the annual range of temperature is 50°; on the east side, at Christchurch, 65°; moisture, west side, 90°, east side, 75°; rainfall, west side, 120 inches; east side, 25 inches; number of rainy days, west side, 202; east side, 91. Much of this enormous precipitation is deposited as snow in the Southern Alps, which



comb out the moisture from the westerly winds; hence the extensive glaciers of the mountain region and the comparative dryness of the Canterbury Plains. Mount Cook has an elevation of 14,000 feet; this is the principal snow area of the Southern Alps, and here the island is narrowest. In shape this snowfield is less compact than that of the Bernese Oberland and of the Mount Blanc region; their respective areas are: snowfield of Mount Cook, 160 square miles; Bernese Oberland, 140 square miles; Mount Blanc, 75 square miles. The crystalline mountains of the south-west do not contain nearly so much snow. The Tasman glacier is 18 miles long, and 2 miles wide at its terminal face; the terminal face of the Godley glacier is 3 miles across. The author then gave a description of the leading features of the glacier scenery, illustrated by very effective pictures; one of Milford Haven, with the half-snowed peaks of Mount Pembroke and its neighbours rising to a height of more than 5,000 feet, was very striking; he also demonstrated the erosive action of glaciers in cutting back cols—an action more energetic formerly, some of the cols having been worn down as low as 1,800 feet. The author pointed out on a map, specially constructed for the purpose, the immense extent of the snow area in former times as contrasted with that now existing. This is proved by the abundance of moraine matter. At present the glaciers on the west side of the Southern Alps are remarkably clean (as was well shown by a splendid series of sketches in colour by the Hon. Mr. Fox and lent for exhibition to the meeting), whilst those on the east side are largely charged with detritus. Following a given section in this direction away from the central ridges we find generally a rock basin, and still lower immense moraines extending to the Canterbury Plains, till they pass under the deposits of these plains, which are referred to Pliocene and Post-tertiary age. In further illustration of the former extent of the snow-fields, the author indicated old centres of glaciers in the north of the island. The reason for this contraction of the ice area is the great question for determination. Was it due to difference of climate the result of a great glacial period? The remains of the past fauna afford no evidence of this. We may, indeed, suppose that the whole fauna migrated to the north, but we must in that case invent the land and bring into play oscillations more extensive than those required for another alternative, viz., the alteration of level within the area itself. We might suppose a general alteration of level, even to the extent of 4,000 feet higher than at present, but the evidence afforded by the shore line is unfavourable to this view. There remains then the theory of unequal elevation, which, combined with a most enormous destruction of surface, the result of ages of glacier action, best explains the phenomenon. There can be no doubt that at present the south-west portion of the island, where the crystalline rocks prevail, is very much depressed in comparison with its position at some former period; the extraordinary depth of the sub-marine valleys proves this. The author was inclined to believe in a period of irregular elevation, the south-west portion having been elevated first, though possibly the Nelson region at a still earlier date. In conclusion, the author stated his belief that there had been no general change of climate, but many changes of relative level, resulting in a great destruction of surface, which had taken place in groups of peaks at different times; the areas of the crystalline rocks have been least affected in their relative changes of level, the oscillation having been greater in the other masses, which have been crumpled up against these.

## MANCHESTER

Literary and Philosophical Society, Dec. 28, 1875.—Edward Schunck, F.R.S., president, in the chair.—The following communication from Dr. Joule, F.R.S., was read:—Unsuccessful attempts have recently been made for the purpose of utilising a modification of the common kite as a means of obtaining a view of the surrounding country. The machine in each instance rose only to fall violently to the ground after remaining in the air a very short time. These trials have brought to my recollection some experiments I made more than six years ago, but of which I did not publish the results, imagining that all such matters must have been thoroughly elucidated by the Chinese, if not by our own more juvenile kite flyers. The usual method of making the skeleton of a kite is to affix a rather slender bow to the top of a standard, tying the extremities of the bow to twine fastened to the bottom of the standard. The steadiness of the kite in the air depends on the fact that the wings yield with the wind. If the bow is too stiff and the surface nearly a plane, instability results. A kite ought to have a convex spherical surface for the wind to

impinge upon. Such a surface I readily made by fixing two bows crosswise. The string was attached to a point a little above the centre of the upright bow, and a very light tail was fastened to the lower end. The kite stood in the air with almost absolute steadiness. I found that by pulling strings fastened to the right and left sides of the horizontal bow, the kite could be made to fly 30° or more from the direction of the wind, and hence that it would be possible to use it in bringing a vessel to windward. One great advantage of such a mode of propulsion over ordinary sails would be that the force, however great, could be applied low down, so as to produce no more careening than that desired by the seaman.—E. W. Binney, F.R.S., said that in the Isle of Man there had been a prevalence of easterly winds throughout the months of October and November, such as he had never experienced during a residence of ten years. This appears to have influenced the migration of swallows. In the beginning of September the chimney swallows and the house martins assembled in great numbers on his buildings on Douglas Head, as they were accustomed to do prior to their annual departure, and disappeared. On Nov. 5, between 10 and 12 A.M., he observed a dozen house martins (*Hirundo urbica*) in front of his house and between it and the sea, busily employed in pursuing their prey. During the summer months the swift and sand martin are frequently seen in the same locality, but seldom the swallow or house martin, and he was inclined to believe that the presence of the latter was due to their having been driven out of their course by the easterly gales.

Jan. 11, Edward Schunck, F.R.S., president, in the chair.—Note on a method of comparing the tints of coloured solutions, by J. Bottomley, D.Sc.—On explosions of fire-damp, by Mr. Robert Rawson.

## CALCUTTA

Asiatic Society of Bengal, Dec. 1.—Mr. Wood-Mason exhibited an interesting collection of crustaceans, including the materials for his monograph of *Paratelphus*, an Indo-Malayan genus of freshwater crabs, all the Italian species of which occur in localities the fauna of which is largely leavened with Malay forms. The three papers read were all by Mr. W. T. Blanford. The first contained a description of some lizards from Western Sind, comprising new species of *Ptyodactylus*, *Stenodactylus*, and *Trapelus*. The species described are *Hemidactylus coctei*; *H. Macullatus*; *H. Persicus*; *Ptyodactylus homolepis*, sp. nov.; *Gymnodactylus*; *Stenodactylus orientalis*, sp. nov.; *Agama agilis*; *Trapelus rubrigularis*, sp. nov.; *Stellio nuptus*; *S. Melanura*; *Mesakina pardalis*; *Acanthodactylus Cantoris*; *Ophiops Jerdoni*. Five are new to the fauna of India, and three of these have not, so far as Mr. Blanford could ascertain, been previously described. Two of the three represent genera of *Gekkotida* not hitherto detected so far to the eastward, and it is doubtful whether either has before been found in Asia. In the second paper, a note on a large hare inhabiting high elevations in Western Thibet, the author shows that the hare previously identified with doubt as *L. pallipes* proves, on comparison with specimens of the latter received from Mr. Mandelli at Darjiling, to be distinct, and is described as new under the name of *Lepus hypsilinus*, from its inhabiting very elevated regions. The description is taken from a specimen collected by Dr. Stoliczka, at an elevation of 15,500 feet, in the Changchenmo valley, Ladak. In the third paper Mr. Blanford states that a snake from Purneah with a local pit has been recognised as *Elachistodon*, a remarkable genus with angular teeth. *Platyceps semifasciatus* is identified with *Zamenis ventrimaculatus*, and *Ablepharus pusillus* is recognised as distinct from *A. agilis* (*Blepharosteres Agilis*, Stol.).

## BERLIN

German Chemical Society, Jan. 10.—A. W. Hofmann, president, in the chair.—The President announced the formation of a German Committee to further the objects of the Loan Exhibition of Scientific Apparatus at South Kensington, and the decision of the committees of the German Chemical Societies to co-operate with this Committee.—R. Blindow described an improved method of burning diamonds for lecture purposes. He puts the diamond on a piece of magnesium foil, and the latter on a piece of porcelain, into a combustion-tube filled with oxygen. Ignition of the magnesium is produced by a Bunsen burner, and is easily communicated to the diamond.—G. Braylants described a lecture experiment to show the combination of oxide of nitrogen with oxygen.—Th. Zincke has added the following observations to his studies on the action

of zinc on benzol,  $C_6H_6$ , and chloride of benzyle,  $C_6H_5 \cdot CH_2Cl$ . Besides diphenyl-methan,  $C_6H_5-CH_2-C_6H_5$ , two isomeric hydrocarbons are formed of the formula:—

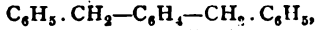

which by oxidation yield corresponding ketones:—

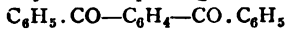

(dibenzoylbenzol), and two isomeric acids, viz., benzoylbenzoic acid (1 : 4), and benzoylbenzoic acid (1 : 2):—



—W. Leppert has succeeded in oxidising dibenzyl:—

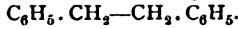

It yields benzoic acid. Two isomeric dinitrodibenzyls yield both paranitrobenzoic acids. Assuming the position of  $CH_2=1$  the position of the two nitro groups appears as 4 : 4 and 4 : 2 in the two isomeric dinitrodibenzyls.—H. Salkowsky proved the existence of a double salt of paranitrobenzoate and benzoate of barium, and thinks that Fittica's pretended fifth isomeride of nitrobenzoic acid may be a mixture of nitrobenzoic and benzoic acids precipitated from double salts like the above.—H. Abelganz has studied the action of potassium on benzol. It appears to yield two compounds,  $C_6H_5K$  and  $C_6H_4K_2$ . With water (as well as with bromide of ethyl) it yields diphenylbenzol,  $C_6H_4(C_6H_5)_2$ , and a small quantity of diphenyl; also an oil boiling at  $222^\circ$  of the composition  $(C_6H_5)_2$ .—E. Demole has tried the action of brominated ethylene,  $C_2H_2Br$ , on hypobromous acid,  $HBrO$ . The chief product appears to be  $CHBr-CH_2OH$ .—A. Hilger has studied hesperidine, to which he gives the improbable formula,  $C_{18}H_{21}O_9$ , and which he considers as a glucoside of an acid,  $C_{12}H_{11}O_4$  (?).—A. Bannow showed a large specimen of solid formic acid in beautiful crystals of more than 5 cm. in length, obtained during the cold weather of the last days in Berlin. The fusing-point is  $+2^\circ$ .—E. Baumann has found in the urine of horses considerable quantities of phenol-sulphate of potassium.—Al. Saytzeff has produced the following interesting synthetical reactions: by the action of iodide of allyl and zinc on oxalic ether; diallyl-oxalic ether,  $C(C_2H_5)_2OH-COOC_2H_5$ , a liquid boiling at  $210^\circ$ ; by the action of iodide of allyl and zinc on acetone; the tertiary alcohol,

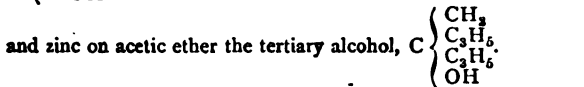
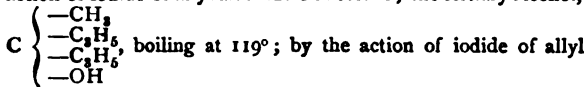

VIENNA

Imperial Academy of Sciences, Dec. 9, 1875.—The following (among other) papers were read:—On the different excitability of functionally different nerve-muscle apparatus, by M. Rollett. This contains myographic studies on antagonistic muscles, and replies to Fick's objections to former experiments.—Attempts to meet objections lately raised against an increase of temperature with depth in the earth, in connection with the low temperature at great depths in the ocean and in some bore holes, by M. Boué. The cold water must flow under the warmer, and the earth's crust under the sea-bottom must be equal to that in continents. As to the Speremberg hole, infiltration of cold water must be considered; also the fact that many chemical combinations produce cold, and such are very likely to occur in salt and gypsum regions with mineral springs.—On the growth and decrease of crystals in their own solution and in the solution of isomorphous salts, by M. Pfaundler. He discusses objections by Lecoq de Boisbaudran to his theory.—On nitroglycerine and the most important preparations from it, by M. Beckerlin. He determines the specific heat of nitroglycerine and of *Kieselguhr*. Another paper of his gives a determination of the efficiency of blasting agents in a theoretical way.—On the formation of a rational space-curve of the fourth order on a cone-section, by M. Weyr.—On the utilisation of solar heat for heat effects, by a new plane mirror reflector, by M. Giintner.—Discovery of a disorder in the bones analogous to hæmorrhagic infarction of other organs, by M. Chiari. The changes in the bones coincided with disorders in the lungs and the right kidney.—On the laws of nervous excitation, by M. Fleischl.—(1) For chemical stimuli nerves are at all parts of their course alike sensitive. (2) For electric stimuli they are more sensitive at higher points than at lower, if the electric currents pass downwards; the case

is reversed if they pass upwards. (3) The doctrine of an increase (*Anschuellem*) of stimulus in the nerves is untenable.—On phylometric values as means for characterisation of plant leaves, by M. Pokovy.

PARIS

Academy of Sciences, Jan. 17.—Vice-Admiral Paris in the chair.—The following papers were read:—Experimental critique on the formation of saccharine matter in animals (continued), by M. Cl. Bernard.—On the *trombe* of Hallsberg (with general conclusions), by M. Faye. The author controverts M. Hildebrandsson's views on the subject.—Action of fuming sulphuric acid on the carburets of hydrogen, by M. Berthelot.—History of attempts at formation of an observatory on the summit of the Pic du Midi de Bigorre, by M. Sainte-Claire Deville. The first to conceive the idea was Plantade, who died on the mountain in 1741.—New considerations on the regulation of slide-valves (concluded), by M. Leduc.—M. Nordenskjöld was elected correspondent for the section of Geography and Navigation in room of Mr. Livingstone.—Report on the work of M. Revy, English engineer, on hydraulics of great rivers, Parana, Uruguay, and the valley of La Plata.—Mission to Campbell Island, geological constitution of the island, by M. Fülhol. During the Upper Jurassic and Lower and Middle Eocene, the land formed part of a large continent; in the Upper Eocene and Lower Miocene it was submerged; in the Middle Miocene it rose again (under volcanic influence), and has since been an island.—On the transit of Venus of December 1874, by M. André.—On a new analogy to the theorems of Pascal and of Brianchon, by M. Serret.—Transformation of cane-sugar in raw sugars and in sugar-cane, by M. Müntz. The reducing sugar in these bodies is generally formed by an inactive glucose, to which are often added variable proportions of normal glucose and of levulose.—On the optical inactivity of the reducing sugar contained in commercial products, by MM. Aimé Gerard and Laborde.—Observations on results already obtained in the magnetism of steels, by MM. Treve and Durassier.—Generalisation of the theory of an osculating radius of a surface, by M. Lipschitz.—On *trombes*, by M. Planté. In one experiment made, salt water is passed through a funnel into a shallow dish over the pole of an electromagnet; and the poles of a battery of 400 secondary couples are connected, one (+) with the water in the funnel, the other (–) with that in the dish. A luminous thread appears in the liquid vein; sparks pass at the bottom, and the water in the dish is put in rotation. This and other experiments described are thought to illustrate the action of *trombes*.—On the spectrum of nitrogen and that of alkaline metals in Geissler tubes, by M. Salet. We shall notice this at length next week.—On new derivatives of anethol, by M. Landolph.—On the synthesis of aniline black, by M. Coquillion (second note).—Crossing of nerve fibres which connect the brain with the spinal cord, by MM. Sappey and Duval.—On the embryogeny of the *Salmacina Dysteri*, Huxley, by M. Giard.—Undulations of the chalk in the north of France, second part; origin and general disposition of these undulations, by M. Hebert.

CONTENTS

	PAGE
GEORGE POULETT SCROPE, F.R.S. By A. G. . . . .	241
SOMERSET HOUSE AND THE PUBLIC ANALYSTS . . . . .	242
HARTLEY'S "AIR AND ITS RELATION TO LIFE." By Prof. OSBORNE REYNOLDS . . . . .	243
THE RECENT ORIGIN OF MAN. By W. B. D. . . . .	245
OUR BOOK SHELF:—	
"The Indian Alps" . . . . .	246
LETTERS TO THE EDITOR:—	
The Article "Birds" in "Encyclopædia Britannica."—Prof. T. H. HUXLEY, F.R.S. . . . .	247
D-line Spectra.—Prof. G. G. STOKES, F.R.S. . . . .	247
The True Nature of Lichens.—Dr. W. LAUDER LINDSAY . . . . .	247
OUR ASTRONOMICAL COLUMN:—	
The Binary Star $\gamma$ Coronæ Australis . . . . .	248
The Solar Eclipse of 1876, March 25 . . . . .	248
Bessel's Treatises . . . . .	248
THE FLOWERING OF SPRING PLANTS. By ALEXANDER BUCHAN . . . . .	249
THE WORK OF THE <i>Challenger</i> AND THE <i>Valorous</i> . . . . .	250
SCIENCE IN GERMANY. By S. W. ( <i>With Illustration</i> ) . . . . .	250
THE PHYSICAL OBSERVATORY ON THE PIC DU MIDI . . . . .	251
PROF. TYNDALL ON GERMS . . . . .	251
NOTES . . . . .	254
SCIENTIFIC SERIALS . . . . .	257
SOCIETIES AND ACADEMIES . . . . .	258

THURSDAY, FEBRUARY 3, 1876

THE UNIVERSITY OF LONDON AND  
SCHOOL EXAMINATIONS

EXAMINATIONS, like fire and many other useful things within their proper limits, are good servants, but very tyrannous masters. It is excellent that knowledge should be tested; that men—and shall we say women—shall be found out for their souls' good if they innocently deceive themselves as to their acquirements, for the sake of the community if they assume knowledge they really do not possess. Unfortunately, what was once a means bids fair to become an end; and it is quite certain that a great deal of knowledge is acquired nowadays which finds its only use within the walls of the examination room. It is perhaps a law of human nature that those who have bitterly endured the harrow—not to suggest metaphorically another implement—are ever afterwards eager that all mankind should endure the same process with no feature of its asperity mitigated. In the Report of the Sub-committee of the Annual Committee of the Convocation of the University of London on the Examination and Inspection of Schools, this feeling makes itself curiously apparent:—

“The Universities of Oxford and Cambridge having for many years held local examinations, and having recently initiated a joint scheme, in accordance with which they have examined a progressively increasing number of schools, your Sub-committee fear, that unless this University is prepared to undertake a share in this great work, many schools, which have hitherto acted as feeders to this University, will grow into organic relation with the older Universities, and that, consequently, the number of candidates for the London examinations will sensibly decrease.”

The two ancient Universities having, it will be seen, started a system which has affected, most beneficially, the middle-class education of the country, and this system having worked successfully for many years, are now practically extending it to the higher grade schools. The Annual Committee have not a word to say as to the efficiency of the work, although, as we have frequently said in these columns, much is to be objected as to the position given to science in it. It might, then, be conceived, that there was no need for the modern University to do more than to wish the older ones God-speed. But no; there is no salvation in Oxford and little in Cambridge, and that students should from their youth upwards lean to these *almae matres* and turn away from the *sicca nutrix* of the metropolis—the examining board with all its sternest features unmitigated by the prestige of a professoriate, or the ameliorations of a traditional culture—was a thing not to be endured. The University must be at least true to its principles. When on the eve of the elections of the present Parliament, people were dimly suspecting the beginning of the end of the Liberal administration, Mr. Lowe, addressing his constituents in Convocation, devoted all his powers to the task of portraying the terrible things that must happen if the Conservatives ever came to power. He passed lightly over the disappearance of a surplus—that was too normal a phenomenon with Tories. But he touched a chord on which he knew the response would

not be doubtful, when he hinted that possibly the Conservatives might tamper with the principle of competitive examinations; with almost painful earnestness he pleaded hard for mercy as regards that cherished institution. He knew his audience well, and felt that they at least would never neglect the sacred charge, or forget that the true destiny of the human animal, from its youth upwards, is the examination room.

It will perhaps be thought that in this matter we have spoken with undue irony, even it may be thought with undue levity. But is it easy to speak with reasonable seriousness of an attitude like that which the Annual Committee has adopted? Surely if the school-examinations were ill-conducted by Oxford and Cambridge the nation would owe the University of London a debt of gratitude if it undertook in good faith to do them better. But there is no evidence that they are ill-done; indeed, there has not been sufficient time to express any comprehensive opinion about them. A good deal is no doubt to be said as to the inadequate place which science holds in these examinations. But for the present the more dignified course for the University of London to adopt—and one which its actual rulers, the Senate, will, it is to be hoped, take into consideration—is to defer any action in this matter till the Oxford and Cambridge system has at least been tried. It is not by entangling schoolboys in its meshes, but by the high standing which is maintained for its superior degrees, that the prestige of Burlington Gardens will be sustained; and in the interests of learning, rather than of examinations, it is to be hoped that grounds of action so cynical will not be again put forward.

GUTHRIE'S "MAGNETISM AND ELEC-  
TRICITY"

*Magnetism and Electricity.* By F. Guthrie, Professor of Physics at the Royal School of Mines. (London and Glasgow: W. Collins, Sons, and Co., 1876.)

DR. GUTHRIE has evidently devoted considerable time and care to the preparation of this text-book. It has undoubtedly a freshness and originality of treatment which, though apt to shock electricians in parts, yet places this treatise in striking contrast to some science class-books of mushroom growth, that bear the mark of scissors and paste on every page. In such books the text too often seems written to illustrate the threadbare woodcuts; here, however, the illustrations are original, and usefully aid the author's meaning. It is true in some cases the cuts are rough and poorly engraved, e.g. Figs. 90, 105, 107, 112, 123, 183, and 274, and it is to be regretted that, in the case of instruments at any rate, the illustrations are not drawn to scale but often greatly out of proportion, the reason for which, the author states, is better to show principles; but this hardly applies to apparatus which the student or instrument maker may have to construct from the figures. We like, however, the quaintness seen in many of the terms employed; such as the use of "tandem" to describe cells grouped in simple circuit by "joining the family of zincs to the family of carbons" (p. 183), and the term "abreast," employed to indicate the compound circuit; a source of voltaic electricity is called an "electrogen," and the transport of the products of electrolysis is termed "migration

of the ions," &c. Some of the illustrative analogies given by the author are also very happy, as, for example, the ease with which the molecular transfer is effected in electrolysis is compared to the ease with which a chain hanging over a pulley is moved: "When the two sides are equal each link on one side may be conceived as keeping in equilibrium the opposite link on the other side. A slight force pulling one side down will bring each link opposite to a different one" (p. 137). Incidentally, one or two of the new things strike us as open to question: for instance, the habitual use of the word isolate instead of insulate; the former has a French aspect, and certainly is less familiar to English readers than the latter term. Again,

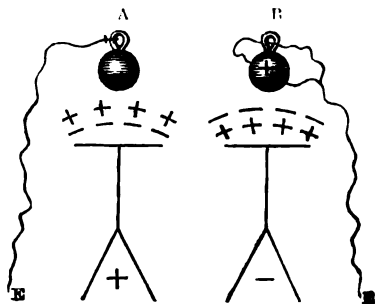

FIG. 1.

the omission of all names of discoverers, because, the author states in the preface, "the book is not a history of discovery;" nevertheless, is it not well that students should be able to associate with Faraday's name, for instance, the famous discoveries he gave to the world? and with all the author's care one or two less important names have crept in, that thus have an undue prominence given to them. On the other hand the unostentatious tone of the book and the entire omission of any reference to the writer, even in the description of the instruments he has devised or the facts he has discovered, are excellent traits, and quite characteristic of the author.

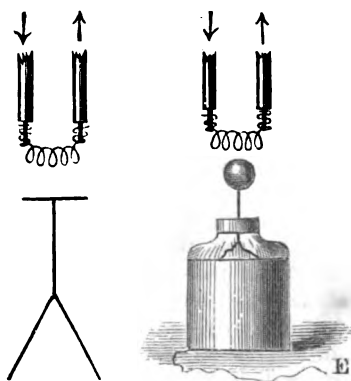

FIG. 2.

The following extracts will illustrate the remarks we have made, and afford our readers an idea of the experimental portion of this treatise. Here is an experiment of the author's which is of considerable interest, whatever explanation may be accepted:—

"When at a bright white heat, an iron ball refuses to receive, or at least to retain, even for a moment, a charge of either + or - electricity. On cooling down, but while still of a red heat, it acquires the power of receiving a - but not a + charge; and this distinction is maintained

through a considerable range of temperature. At a lower temperature yet, but still at a dull red heat, the ball begins to be able to receive + electricity, and shortly after, as it cools, it accepts both kinds with nearly equal readiness. . . . Again, if we take two equally-charged gold-leaf electroscopes (Fig. 1), one charged with + and the other with - electricity, and if we bring earth-connected white-hot iron balls a few inches above the caps of each, they will be discharged with nearly the same facility. On repeating the experiment continually, as the balls cool, it is found that A, or the +ly charged electroscop, ceases to be discharged, though the ball is of a red heat, while B, or the - electroscop, continues to be immediately discharged. although the ball has lost all incandescence."

The explanation of this phenomenon Dr. Guthrie takes to be as follows:—"If we conceive the air-bathed and electrically air-straining masses of iron, A and B, to be respectively +ly and -ly electrified, and then to be gra-

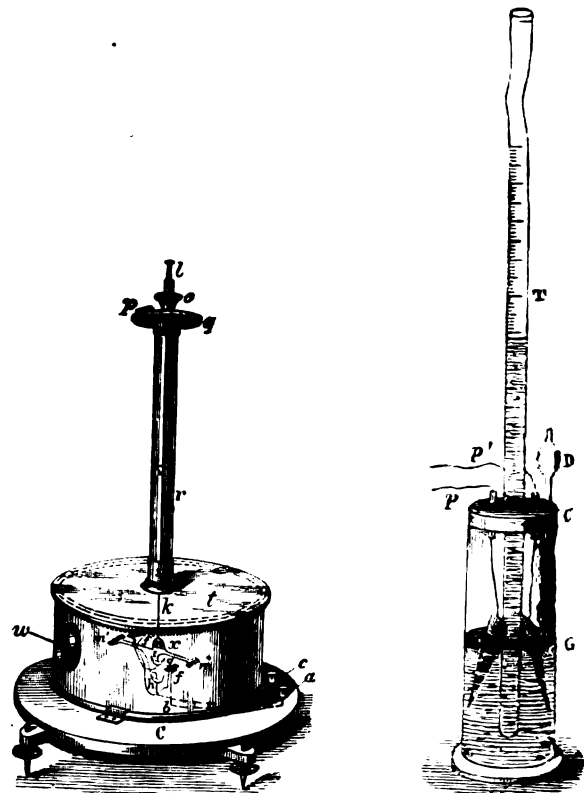

FIG. 3.

FIG. 4.

dually heated, the air which we have already partly seen to have a greater attachment to + than to - electricity will, supposing the attachment between the metal and both kinds to be equally diminished, succeed first, in the molecular turmoil at the heated surface, in carrying away the + " (p. 81). Hence the apparently opposite effect seen in Fig. 1 is due to the inductive action of the charged electroscop upon the earth-connected ball over-head, so that the ball in A is negatively electrified and retains its charge, whereas in B the ball becomes positively electrified and dissipates its charge as fast as it is renewed, and hence in this case the electroscop is discharged as if by a point. The same power of discharge can be shown by replacing a hot ball with a platinum wire made white hot by a current. Fig. 2 shows an electroscop and a Leyden jar being discharged in this manner.

Fig. 3 shows an ingenious torsion galvanometer, devised, we believe, by the author, and which is stated to be free from many sources of error.

An ingenious contrivance, due to the author, is shown in Fig. 4. This is a so-called voltastat, an arrangement whereby the current interposes "by its own greater or less action a greater or less resistance in its own circuit," and thus the voltastat or automatic rheostat behaves like the governor of a steam-engine. There are of course several obvious disadvantages in the use of such an instrument, but we cannot recall any other continuous self-acting "voltastat." Helmholtz, in order to keep the disc of his siren rotating at a constant rate, employed an electro-magnetic arrangement with attached governor, but here the current was interrupted when it exceeded a certain strength.

In the electro-chemical portion of this treatise students will find much information concerning the reactions within various forms of batteries and in the electrolysis of salts, and some interesting facts on electric osmose. The explanation Dr. Guthrie gives of the prevention of "local action" by amalgamation of the zinc is new to us. The chief cause of local action—which the author describes as "a coasting trade"—is attributed to difference of hardness rather than metallic impurities on the surface of the zinc; mercury, it is asserted, removes this inequality of hardness due to irregular cooling, "for as the mercury penetrates, the mass softens and molecular strains are relieved, and uniformity results" (p. 141).

And here we would note one or two minor experimental statements in the book which we think it would be an advantage to modify, as readers might unintentionally be misled. In speaking of the electrolysis of water the author states that in the first portions of the gas collected the hydrogen is less than its theoretical proportion. "This is due to the 'occlusion' of hydrogen by platinum under these circumstances. The hydrogen is absorbed by the platinum. Very soon, however, the metal becomes saturated, and the exact combining ratio is observed" (p. 157). This effect, we imagine, must very promptly be masked by a contrary action—to which Dr. Guthrie does not allude—for, except under special circumstances, the amount of oxygen is perceptibly deficient in electrolysis, and, as is well known, is due to the formation of ozone. And is not the following electro-chemical statement also open to comment?—"Hydrogen, when freshly liberated, has, as is well known, an exceedingly powerful reducing action. Use is made of this circumstance to protect the copper sheathing of ships, . . . the evolution of hydrogen on the copper surface deoxidises any oxidised portion" (p. 128). A student might from this be led to infer that the electro-negative metal in a cell would not be protected unless hydrogen were evolved on its surface. Again, in describing the evolution of electricity by an ordinary electric machine, it is merely stated that "the + electricity enters the prime conductor, and - leaves it; the prime conductor thus becomes +" (p. 52). A reference to the inductive action exerted on the prime conductor, the high tension at the points, and therefrom the discharge of the induced opposite electricity on to the machine, seems needed here.

We must now devote a few words to one feature

wherein the present text-book differs from most of the ordinary manuals on electricity. Dr. Guthrie has sought to give the reader some acquaintance with terms and methods of measurement which in general are better understood by the practical electrician than the science teacher. Whilst every such effort cannot fail to be more or less useful, the present is, we regret to notice, open to criticism in several directions. But as we have neither the space nor the inclination to notice all the points we have marked, one illustration will suffice. On pp. 225 and 226 we have the unit of resistance set forth as follows: "Taking 1 second as unit of time, 1 metre as unit of length,\* and 1 gramme as unit of weight, an 'absolute' unit of resistance is obtained by employing the above equations [viz.,  $Q$  (or current strength) =  $\frac{fd^2}{lm}$  and

$W$  (or current work) =  $Q^2 r t$ ], and this multiplied by one hundred million is the Ohm or B.A. unit." Here, irrespective of other considerations, there is the fundamental error of using the term *weight* instead of *mass*, and moreover, the student must fail to grasp the idea that electric resistance can be expressed as a velocity, and has nothing to do with either weight or mass. There is no hint of these considerations in the manual before us; the electrostatic system of units is not even referred to, nor is the student made aware of the precise nature of the units described.

This text-book is open to criticism also in some other portions which deal with more familiar questions. Notably, take for example a proof connected with Ohm's law, given on p. 185; or the paragraphs on linear resistance, § 243—247, which certainly will bewilder the reader unnecessarily, when a more general result can be deduced more easily and obviously in as many lines as pages are here devoted to the subject. Nor is it necessary for the particular proof, even if it were true, that the potential at the zinc end of the battery is = 0, as stated on p. 221.

In § 257, referring to the effect of heat on the resistance of liquid conductors, the fact is lost sight of that mercury (quoted as militating against a theory that is given) is not an electrolyte, and so has nothing in common with the generality of liquid conductors. On p. 224 the author shows how the diameter of fine wires may be deduced from their length and weight, and then adds: "The relative diameter of two wires can be deduced from their weights, lengths, and resistances," here weight, no doubt, was meant to be omitted. There is also an earlier paragraph needing great amendment, viz. § 214, where electrical resistance is compared with the resistance experienced by water in flowing through pipes; but as any analogy there might be is destroyed by the definition adopted of water-resistance, it is, we think, a mistake to have introduced the elaborate and withal erroneous comparison that is given. And surely two woodcuts of the same tube on p. 179 were hardly necessary, as if turning the tube one way or the other could make any difference in the reasoning. In fact, the evident care everywhere taken by the author to make his meaning clear, has perhaps led him occasionally to the opposite extreme of unnecessarily laboured explanations, so that some really

\* After the strong reasons which exist in favour of the C.G.S. system of units, it is to be hoped that the centimetre will become more generally used as the unit of length.

simple matters become invested with an air of great difficulty. Thus, to take one other example, we should have thought it needless to devote so much space to the difference between a right and left-handed spiral, as is given on p. 242, *et seq.*

There are also several clerical errors and misprints throughout the book, which we regret we have not space to point out, as they ought to be corrected in a new edition; some of the woodcuts, moreover, need alteration.

In conclusion, we must remark that, although a careful perusal of this work has led us to notice several things which ought to have been different, yet we are not insensible to the good features of this unpretending textbook, and we hope, therefore, that Dr. Guthrie will have a speedy opportunity of removing the blemishes which seriously mar the usefulness of his book. In the strictures we have ventured to offer we trust nothing offensive to the author has appeared, for whom we entertain, and are glad to be able to express, our sincere respect.

#### TWO AMATEUR EXPLORERS

*"The Great Divide."* Travels in the Upper Yellowstone in the Summer of 1874. By the Earl of Dunraven. With Illustrations by V. W. Bromley. (London: Chatto and Windus, 1876.)

*Yachting in the Arctic Seas; or, Notes of Five Voyages of Sport and Discovery in the neighbourhood of Spitzbergen and Novaya Zemlya.* By James Lamont, F.G.S., F.R.G.S. Edited and Illustrated by W. Livesay, M.D. (Same publishers.)

THE number of works of travel published within the last few months is probably unprecedented. Scarcely a week has passed during that time in which we have not had occasion to notice one or more in these columns. One noteworthy feature about these narratives of travel is that few of them are by what may be called professional explorers, men who have led expeditions into unknown or little known lands and seas for the sole purpose of extending our knowledge of them. They are mostly written by men who, solely from a love of adventure and sport, have left all the comforts and luxuries which wealth and a high social position can bring to undergo many of the hardships and privations which fall to the lot of those who have adopted discovery as their work in life. No doubt improvements in modes of travel, and especially in steam navigation, have something to do with this, as has also the tedium which occasionally comes upon every intelligent man who has to plod the weary round of the duties, and especially the pleasures, of civilised life. But, as we said last week, we are inclined to attribute this growing love of travel, of amateur exploration, in some degree to the general advance of intelligence urging those who can afford it to gratify their craving for knowledge by stronger stimulants than can be obtained from books. Possibly also some may think this growing love of travel in wild regions, mingled as it often is with intense delight in dangerous sport, is to some extent a breaking out of remote ancestral habit, of a habit which still clings to us from a time when our ancestors, like existing savages, were explorers and hunters of the wildest animals for dear life—a habit which only requires a favourable oppor-

tunity to be re-developed, though with a different aim. Whatever may be the causes, there can be no doubt about the fact of the rapidly-growing love of adventure and discovery, involving dangers and hardships of a very real kind. No better examples could be found than those of the authors of the two works before us.

The scene of the Earl of Dunraven's wanderings is in and around that wonderful and interesting region of North America, on the borders of Montana and Wyoming, known as the Yellowstone Park, which the U.S. Government have had the wisdom to set aside as a "gigantic pleasuring ground." Anyone looking at a good map of the United States will perceive the appropriateness of the term "The Great Divide" as applied to the mountainous region in the neighbourhood of the Upper Yellowstone. It is indeed the geographical centre of North America; here the principal rivers of the United States take their rise and flow in all directions—north, south, east, and west. We have already (vol. vi., pp. 397, 437) given considerable details and several illustrations of this remarkable region of gigantic geysers, and boiling mud and sulphur springs, and not much has since been done to add to our knowledge of it. The Earl of Dunraven, during the few weeks he spent in the district with a few boon companions, made a pretty careful examination of some of the most remarkable phenomena, and the record of this, supplemented by copious extracts from the accounts of the U.S. exploring expeditions, will give the general reader a very fair idea of the characteristics of this strange region. The Earl reached the Upper Yellowstone region by travelling northwards from Corinne on the Great Salt Lake; and both on his journey northwards, during his hunting of the mountain-sheep or bighorn (*Caprovís Canadensis*), the wapiti, and other wild animals, and his exploration of the geyser and boiling spring region, he and his party occasionally endured considerable hardship, which, however, they all seemed thoroughly to enjoy as an essential part of the programme of the expedition. Considerable details are given as to the character and condition of the various tribes of Indians to be met with in the neighbourhood of the region traversed, and the Earl has much to say on the Indian question. We do not think, however, that our ignorance of the Indian, his habits and traditions, is so great as the Earl would make out to be the case. There really exists a vast amount of information concerning the aborigines of North America at least, and Mr. Bancroft is doing good service in collecting into one magnificent work all that is known of the natives of the Pacific States. Still there can be no doubt that the American Indians are rapidly dying out, and in the interests of science it would be well to use all diligence in supplementing the doubtless by no means complete information we at present possess. As to civilisation and conversion, the Earl of Dunraven has as bad an opinion of the Indian as Mr. Monteiro and Capt. Burton have of the nature of an African.

On the whole we may say that the Earl of Dunraven's work is a jolly rollicking narrative of adventure and sport, mixed up with a great deal of useful information concerning one of the most interesting regions in the American continent. The illustrations are interesting, and some of them help out considerably the descriptions in the text,



A good map of the territories around the Yellowstone region, and a large scale-map of the Upper and Lower Geyser Basins, enable the reader to follow the author in his wanderings and descriptions.

From a scientific point of view Mr. Lamont's book is more valuable than the one we have been speaking about. So long ago as 1858-59, Mr. Lamont made voyages, mainly for sport, to the Spitzbergen Arctic region; and in 1869-70-71 he made other three voyages. In the volume before us he has brought together some of the most valuable results of his observations during these voyages, and while devoting considerable space to his sporting adventures with the walrus, the seal, and the bear, he gives much information of scientific value. His sporting skill stood him in good stead, as from his large takes of walruses, seals, and bears, not to mention reindeer and smaller game, he must have been, in 1869 at least, considerably recouped for the expenses of his voyage.

Mr. Lamont, very naturally judging from his own success, is inclined to place more value on private Arctic enterprises than on elaborately equipped Government exploring expeditions. He refers to the expedition in the *Polaris*, commanded by a civilian, and which got further north than any ship had previously done. But we think that any one who reads the narrative of that unfortunate expedition unprejudicedly, must conclude that had the expedition been under strict naval discipline it would have reached a point still further north, would have accomplished more in the way of scientific observation than it did, and would not have ended with the disaster that befell it. The last Payer-Weyprecht expedition, though not a Government one, was practically under naval discipline, and the English Government expeditions referred to by Mr. Lamont, did not fail in their endeavours to push northwards because they were such. But Mr. Lamont speaks as if the main object of Arctic exploration were to get as far north as possible, whereas, in the eyes of scientific men, this is a point of minor importance; and they maintain rightly, we think, and their opinion is supported by past experience, that no Arctic expedition can be adequately equipped to collect all the scientific data which can be so abundantly obtained in these regions, unless it be sent out by Government and be conducted with all the method and strictness which naval discipline alone can enforce. Private enterprises like those of Mr. Lamont and the whale fishers, can do much to add to our knowledge of the Arctic regions, but if we had had to depend entirely on such means, what would have been the amount and value of our knowledge at the present day?

Mr. Lamont gives a minute description of the construction of his admirably built steam yacht the *Diana*, which came unscathed through many dangers. In 1869 he sailed as far as the Kara Straits, which he did not enter. Next year, however, he passed through Pet or Jugor Straits, and penetrated a short distance into the Kara Sea, coming out by the Kara Straits. He sailed up the west side of Novaya Zemlya as far as Admiralty Peninsula, and after several trials succeeded in passing through the Matoschkin Schar. He landed on several points of the island, and gives some valuable notes on the fauna and flora which he observed. In 1869

he sailed along the edge of the ice-pack a little north of the 75th degree of latitude, to Spitzbergen, the coasts and gulfs and islands of which in his various voyages he has examined with great minuteness, and contributes several notes on the physical geography and natural history, which will be found of value as supplementary to those of other observers. Regular temperature soundings were taken and the surface-temperature observed, the condition and movements of the ice noted, especially in the Kara Sea, as well as any evidences of currents; and Mr. Lamont's observations on these points, and especially on the movements of the ice in the Kara Sea, we would recommend to the notice of all interested in Arctic physics and Arctic geography. Mr. Lamont has a right to be considered an experienced Arctic observer, and his opinions should be received with respect. Years ago he conjectured that land should be found to the north between Spitzbergen and Novaya Zemlya; the Payer-Weyprecht Expedition has confirmed this conjecture. He tried hard to get at least a sight of Wiche's Land, but failed, though the Norwegian captains succeeded in reaching it in 1872; for there is no doubt that Petermann's King Karl Land is that discovered by Edge 250 years ago. Mr. Lamont thinks it possible that it may be connected with the recently-discovered Franz Josef Land.

Mr. Lamont records not only his own observations, but being well up in the literature of the exploration of the region he visited, gives many valuable notes of the work done by previous explorers, as well as by some who have been there since his last voyage. We would recommend to naturalists his observations on the differences between the reindeer of Spitzbergen and that of Novaya Zemlya; the former he thinks identical with the wild and tame deer of Norway and Lapland, whereas the Novaya Zemlya type appears to him more allied to the reindeer of the American Continent. His theory as to the migration of the Spitzbergen type is very remarkable.

There are many illustrations throughout the work, some of them not well drawn, but all of them helping the reader to realise what is to be seen in the regions to which they refer. Various maps and outlines of coasts add to the value of the work, which we assure our readers they will find full of entertainment and information.

---

#### OUR BOOK SHELF

*Die Neuere Schöpfungsgeschichte nach dem gegenwärtigen Stande der Naturwissenschaften.* By Arnold Dodel, Privat-docent at Zürich. (Leipzig: Brockhaus, 1875.)

ANOTHER work on Evolution, equalling the "Origin of Species" in size. The author of these twelve lectures has carefully studied every important work on the subject, and endeavours to give a plain and intelligible account of Evolution in relation to the whole field of biology. The style of the work is vigorous and combative, and considerable success in exposition is attained. But many definite conclusions are announced where the most far-seeing evolutionists would only put forward tentative hypotheses. We think it will be far more advantageous for German or other students who have any real knowledge of biology to study for themselves Mr. Darwin's works than to take a less efficient, though an honest and accomplished guide in Dr. Dodel. The book is well illustrated with engravings of interesting structures in plants and animals bearing on Evolution; it also contains a

number of hypothetical scenes illustrating the fauna and flora of the past, as well as several phylogenetic trees.

*Le Valhalla des Sciences Pures et Appliquées, galerie commémorative et succursale du conservatoire des Arts et Métiers de Paris, à créer dans le Palais Neuf de Mansart, au Château de Blois.* Par le C<sup>o</sup>. Léopold Hugo. (Paris, 1875.)

THE four names of Watt, Fulton, Stephenson, and Denis Papin, inscribed on the roof of the railway station at Blois, suggest a train of thought to the author in connection with the triumphs of steam and its applications. Having previously described the Château de Blois, the writer puts forward a proposal (sometimes he calls it a dream) to turn the now abandoned château into a noble valhalla of science. A principal feature is a statue of Papin (born at Blois about 1650); there should be also statues of other scientific writers of all time and climes, appropriate inscriptions, portraits on the walls, and representations of interesting scenes in the history of science, chambers for the exhibition of models and instruments, a scientific library, and other matters. So his dream is to make this a Versailles of science. A classification of the sciences and a plan close this part of the pamphlet. We do not, however, concern ourselves here with this proposal or dream or whatnot, but pass on to a brief glance at the three appendices. The first is "Definition de la double-tendance Philosophique de la Science." Noting the objects the "immortal" Bacon had in view in his New Atlantis, he applies himself to the consideration of what is the classification that we can make of the sciences, and combats Auguste Comte's arrangement according to the increasing complexity which appears inherent in them. In our author's eyes all sciences have the same complex character (caractère de complication) either virtually or actually. Comte begins with mathematics, Hugo exalts them to a high place: "L'intérêt philosophique des sciences mathématiques est de marcher à la rencontre des sciences naturelles. Il n'y a rien là qui ressemble à une subordination des certaines sciences." The second is "Examen géométrique sommaire des orbites planétaires (ovhélites)." The writer remarks that recent discoveries in Astronomy have pointed to a new movement of the solar system in space, hence the orbit or trajectory of our planets is not a plane curve. This orbit is a helicoidal curve with an elliptical or oval projection. Hence ov-hél-ite. In the geometrical description of such a curve we must indicate whether the trace is *dextrorsum* or *sinistrorsum*. The ovhélites of the planets and of the earth are geometrically traced *sinistrorsum*. In this paper, which was originally communicated to the Mathematical Society of Paris, the author states the theorem "Les ovhélites planétaires sont tracées sur les cylindres à section droite elliptique (sauf perturbation) ou du moins ovalaire. Une des lignes focales des susdites ovhélites est commune; cette ligne est la trajectoire solaire." The third appendix is "Base scientifique de la numération décimale." We will again let the Count speak for himself, "Je propose aujourd'hui d'utiliser une des plus anciennes et des plus curieuses théories de la géométrie, restée jusqu'à ce jour sans emploi, pour établir un lien entre la géométrie et l'arithmétique, en donnant comme base à cette dernière science un nombre absolu et éternel." The five regular solids were treated of by Pythagoras. Cauchy and Poinot have added to these four stellated polyhedra. "En y joignant à mon tour la sphère (qui est le régulier infiniotique) j'arrive à constituer géométriquement le nombre infranchissable de DIX." Thus we see there is a resemblance between the nine digits and zero on the one hand and the nine regular polyhedra and the sphere on the other. Further, there is a curious feature, there are five primes among these, and there are five regular convex solids. Such then is "la conception philosophique et vraiment scientifique du nombre fondamental DIX." After two thousand years we have arrived at an application of the theory of the regular

figures, there is hope also of establishing a rival to Euclid. A commission was appointed in March of last year to pronounce upon the Hugodecimal theory. "De la propriété régulière essentielle de l'espace, de l'absolu régulier, avoir fait jaillir le nombre DIX!" These are the principal points of interest in the pamphlet.

#### LETTERS TO THE EDITOR

[The Editor does not hold himself responsible for opinions expressed by his correspondents. Neither can he undertake to return, or to correspond with the writers of, rejected manuscripts. No notice is taken of anonymous communications.]

#### The Article "Birds" in "Encyclopædia Britannica"

IN reply to Prof. Huxley's letter of last week with reference to my review of the article "Birds" in the "Encyclopædia Britannica," I may mention that it is to the illustrious Nitzsch, as far as I am aware, that we owe the combination of the Swifts and the Humming Birds into a single family. Harmeister's edition of Nitzsch's "Pterylography" was published in 1840, and in Mr. Selater's translation of that invaluable work (p. 86) we read, under the heading MACROCHIRES, "In the family I place the two genera, *Cypselus* and *Trochilus*, which indeed present but little external similarity, but are very nearly allied in the structure of their wings."

In 1867, the year in which Prof. Huxley promulgated his Classification of Birds, the palatal structure of the Humming Birds was imperfectly known, as may be gathered from the following passage in his memoir<sup>†</sup> with reference to the *Cypselomorphæ*:—"The vomer is truncated at the anterior end, and the maxillo-palatines are slender and disposed nearly as in the typical *Coracomorphæ* (? *Trochilus*)." I believe that, at that time, no accurate account of it had been given by anyone.

When, in 1873, after I thought that I had fairly mastered Prof. Huxley's classification, Mr. Parker kindly informed me verbally that from his investigations on the subject he had discovered that the vomer of the Trochilidæ is sharp-pointed instead of being truncated. Upon re-reading Prof. Huxley's data for his division of *Carinate* birds in the *Schizognathæ* and the *Lasmognathæ*, in both which groups the vomer is *pointed* (or not ossified), and the *Aegithognathæ*, in which the vomer is *truncated*, I naturally was led to see, as Mr. Parker has since stated in print,<sup>‡</sup> that the Trochilidæ are not *Aegithognathous*, but *Schizognathous*; and I further inferred, justly I believe, that if Prof. Huxley had, in 1867, known that the vomer of the Humming Birds is sharp-pointed instead of being truncated, he would never have placed the Trochilidæ among the *Aegithognathæ*, for in so doing he would have been compelled to have given up the only common character of any importance which links together that group. When, therefore, I say in my review that "Professors Huxley and Parker place them [the Swifts and the Humming Birds] in quite different divisions," there can be no objection to my including Prof. Huxley's name with that of Mr. Parker in a *general* remark which is so fully borne out by the spirit of the classification introduced by the first and adopted by the second of these illustrious biologists.

That Prof. Huxley did, in 1867, adopt Nitzsch's combination of the Swifts with the Humming Birds, I would not attempt to deny, but *then* the palatal structure of the latter sub-family was not correctly known.

10, Harley Street

A. H. GARROD

#### The Difficulties of the Public Analysts

HAVING for some time past watched with painful interest the prosecutions under the new Adulteration Act, and seeing very clearly that whatever may be its success or failure in reference to its intended object, this Act of Parliament is becoming eminently successful in bringing chemical science into contempt, I am glad to see that you have taken up the subject in the columns of NATURE. I hope that it will be freely discussed. It may be safely affirmed that in the majority of cases where the vendor has made an effort to defend himself he has been able to flatly and positively contradict the certificate of the public analyst by counter-certificates of other analysts of equal or superior eminence. The bitter case you have quoted is no exception, but may be taken as about a typical or average sample of such prosecutions. If this deplorable state of things is to continue,

\* Proc. Zool. Soc. 1867, p. 468.

† Trans. Zool. Soc. vol. ix. p. 292.

the general public will be perfectly logical in concluding that either the public analysts are generally incompetent, or that chemical analysis is self-contradictory, and therefore worthless. The subject is one that seriously affects the dignity and general interests of science.

Much of the blundering that has unquestionably occurred is doubtless due to the peculiar position of public analysts and the impossibilities they are called upon to perform. The political economist tells us that "demand for commodities induces a corresponding supply," and the Adulteration Act was evidently framed upon the assumption that analytical skill is a "commodity" subject to this law, as it demanded the immediate creation of a whole army of chemists endowed with a peculiar kind of knowledge and skill, which was not to be acquired in any college, school, university, or other educational institution, public or private, in Great Britain. Laboratories existed wherein the analyses of acids, bases, and salts, organic and inorganic, were carefully taught, and others where special attention was devoted to pharmaceutical preparations; but where (before the passing of this Act) could a student find a laboratory in which he might learn how to analyse the multitude of articles that pass over a grocer's counter, and acquire the *commercial* knowledge which is as necessary to the public analyst as analytical skill? I use the past tense here, knowing that since the passing of the Act many public analysts have industriously and meritoriously availed themselves of the opportunities afforded at one laboratory that has been specially devoted to the useful purpose of affording them the special analytical skill they should have possessed before obtaining their appointments. There do not, however, appear to be any sufficient means provided for the commercial and technological education of public analysts.

As an example of the necessity of commercial or technical knowledge, I need only refer to the discoveries of "iron filings" in tea which were so common until lately, the absurdity of which I have already demonstrated by simply calculating the number of tons of iron filings that would be annually required for the alleged adulteration, and showing the practical impossibility of obtaining such a supply, either here or in China. Iron was found in the tea unquestionably,—the chemistry was not at fault,—but the theory which confounded accidental impurity with wilful adulteration arose from lack of technical knowledge, the possession of which would have shown that leaves carelessly gathered and thrown upon the dusty ground of a highly ferruginous soil, and then roasted, must of necessity be mingled with more or less of magnetic oxide of iron, besides the iron naturally contained in the ashes of this particular plant.

The series of butter cases, of which the one you quote is only a recent and ordinary example, illustrate the same want of trade knowledge on the part of nearly all concerned. I have been surprised at the repeated and uncontradicted assumption that butter must be adulterated because it is cheap, which has run through all these cases. We all know that good butter at this season is not obtainable at less than 11s. 8d. per lb., and much is sold at 2s., and therefore it is inferred that if butter is offered for sale at 10d. or 1s. it must be adulterated. This is a very plausible inference, but nevertheless a great mistake, which public analysts and sitting magistrates have evidently shared with the general public. But for irritating old sores, I might quote from early prosecutions, and show how an inspector and public analyst have evidently been so biased and deceived by the simple fact that butter was offered for sale at 8d. per lb., and that the analyst interpreted equivocal analytical results according to such preconceptions. Had he known that parcels of *genuine* butter, sometimes amounting to several tons, are occasionally offered as low as 7d. per lb. in wholesale markets, this erroneous preconception would not have been formed. I have eaten butter made in some of the primitive peasant-dairies of the North of Europe, which if imported to this country would not sell at so good a price as "P. Y. C." (Petersburgh yellow candle) tallow. It was perfectly genuine and detestably nauseous, but nevertheless was highly relished by the people who made it, and to whom it forms a staple article of food, especially in winter. Such butter is occasionally shipped to England from Kiel and other Northern ports; also from Canada and Australia, and sells at ruinous prices; the merchants who send it being unacquainted with the fastidiousness of English palates, and supposing that what is eaten in their own country will be eaten here.

It is the choice brands of "fresh" butter that are the most adulterated, and those delicately-constituted people who cannot eat salt butter, but insist upon having fresh grass butter in the midst of winter when no grass is growing, are abundantly regaled

with refined mutton suet, P. Y. C. tallow, candle ends, and kitchen stuff which, when skillfully prepared, churned up with a little milk and sugar and prettily rolled, moulded or packed in rustic-looking baskets, sells at 2s. per lb. in the west-end, and progressively down to 1s. 8d. or 1s. 6d., proceeding further eastward.

Knowing that this class of butter is systematically adulterated at this season with refined fats, you may judge of my respect for the skill of the public analysts when I find that it has escaped the prosecutions that have fallen so heavily upon the cheap butters. Taking the facts as they have come out in these prosecutions, it appears that *at present* chemical analysis fails to distinguish between the fat which is excreted from the udder of the cow, and that which is deposited in the tissues of the same animal or of the sheep, provided both are mechanically prepared in a similar manner and flavoured with a little sugar and caseine. I may possibly be wrong in this conclusion, and therefore propose a test which may be used to decide this question. Let samples be made and certified by first churning pure milk, then mixing such churnings with varying proportions of foreign fats prepared as those manufacturers can, who have converted their soap-boiling into butter-frying plant, and let such samples be sent to Mr. Muter, or any other expert who believes himself able to certify to the purity or impurity of butter. If he can determine the *percentage* of foreign fat in such varied mixtures his future certificates will have considerable value and authority.

W. MATTIEU WILLIAMS

#### Science in Hastings

I HAVE just seen your comments (vol. xiii. p. 217) on a letter that appeared a few weeks ago in the Hastings and St. Leonards *News*, and at once write to vindicate the honour of Hastings. We have a Philosophical and Historical Society, a Literary and Scientific Institution, and a Mechanics' Institution, besides two or three others of a more private character. A museum we certainly do not possess, and if it should prove like most *local*? museums, a collection of "et cetera," trying to rival the British Museum in the extent of its field of research, and an overturned workbox as to arrangement, the longer we are without it the better. Far be it from me to say that the people of Hastings and St. Leonards display as much interest as they ought in the pursuit of science, but still they are not so bad as you make out. The Philosophical Society, in which I am chiefly interested, and of which I enclose last year's report, has done much good work in bygone days, but owing to a variety of circumstances it is not at present quite so flourishing as we could wish. However, I am glad to say that at the last Council meeting it was decided to publish a pamphlet containing a list of the specimens in the various branches of Natural History to be found about the neighbourhood, both on the land and in the sea. This will be but a commencement, and will be distributed among the inhabitants and visitors with a request that a notice of any alterations or additions should be sent to the Society for future publication. Thus it is hoped that fresh interest will be awakened.

My own idea is that our failure arises from a multiplicity, not a paucity of institutions, and that their aims are too high. I believe one good institution would be far better than all the separate ones. Thus we have the Literary Institution, subscription twenty-five shillings a year. This is in the old part of the town, and formerly possessed the museum and a good set of meteorological instruments. The only privileged members have are the reading room and a good standard library, which, however, has hardly been added to for some years. Next we come to the Philosophical Society, subscription 10s. 6d. a year. This certainly tries to do something, for there are papers read on various subjects, and each session concludes with a conversation. But in my opinion its weak point is that the majority of papers read have no local bearing. I acknowledge that many display great ability, but the chief aim of such a Society should be the collection and description of subjects connected with *local* natural history, botany, climate, archaeology, geology, &c., and wider researches should be left for other more suitable societies, or for special occasions now and then. The Mechanics' Institution I believe is getting on pretty well. There is a reading room, with a library, and lectures are delivered on all imaginable subjects.

If these three institutions could unite, instead of being to a certain extent antagonistic to each other, great advantage, I am sure, would accrue to the members and science generally, although none but those who have gone into the question can imagine the difficulties that would have to be overcome before a harmonious union could be effected.

The Science and Art class to which you refer has recently been organised, and is said to be answering very well.

There is, however, a possibility that this state of things will be soon partly altered, for rumours are afloat that our excellent member, Mr. Brassey, has offered to provide a suitable building in which all the local societies will have apartments, but no particulars are yet known.

Hastings, Jan. 28

ALEX. E. MURRAY

P.S.—Since writing the above I remember that I have omitted the Athenæum, but as this is mainly a debating society it has little to do with the advance of science.

OUR ASTRONOMICAL COLUMN

THE TOTAL SOLAR ECLIPSE OF 1876, SEPT. 17-18.—The track of totality in this eclipse is wholly upon the Pacific Ocean, and in such course that only two or three small islands or reefs appear to be situate near the central line. Using the *Nautical Almanac* elements, which are almost identical with those of the American Ephemeris, wherein the moon's place is derived from Peirce's Tables, St. Matthias Island, west of Admiralty Islands off the north-east coast of New Guinea, is traversed by the central track of the shadow, with the sun at an altitude of 5° at 6h. 16m. A.M. on the 18th local time. Thence skirting Elllice Islands it passes between the Fiji's and the Samoan or Navigator group to Savage Island, in 170° west of Greenwich, latitude 19° south, which is apparently the only spot where totality may be witnessed under anything like favourable conditions, and even here the duration of totality is less than one minute. The after course of the central line does not encounter any land.

In the northern of the two large islands of the Fiji group (Vanua Levu) 179° east, a partial eclipse will occur commencing at 7h. 47m. A.M. local time 44° from the sun's north point towards the west for direct image, and ending at 10h. 16m., magnitude 0.86. In the larger island of the Navigator group, Savaii, of the Admiralty Chart, there will also be a partial eclipse, though nearly approaching totality; eclipse begins 8h. 23m. A.M. at 53° from the sun's north point towards the west, and ends at 11h. 2m., magnitude 0.97.

Assuming the north point of Savage Island to be in 169° 48' W., with 18° 55' south latitude, a direct calculation gives a total eclipse commencing at 10h. 8m. 6s. A.M. local mean time, and continuing 57 seconds with the sun at an altitude of 58°; the first contact of the moon with the sun's limb at 8h. 48m. A.M., 49° from his north point towards west for direct image, and the end of the eclipse at 11h. 29m.

In New Zealand the eclipse attains a magnitude of about 0.5 at Auckland, greatest phase at 9h. 18m. A.M.; towards the extremity of the southern island about Otago, one-third of the sun's diameter will be obscured about 9h. 12m. local time. A partial eclipse between similar limits will be visible on the east coast of Australia and in Van Diemen's Land.

MINOR PLANETS.—The long period of revolution assigned to No. 153, *Hilda*, by the early calculations has been confirmed by a new determination of the elements by Herr Kühnert, of Vienna, upon more than eight weeks' observations. The orbit is as follows:—

Mean Longitude, 1875, Dec. 19, at Berlin	}	34° 58' 7
noon ... ..		
Longitude of perihelion ... ..	285° 1' 6	
" " ascending node ... ..	228° 20' 5	
Inclination to ecliptic ... ..	7° 50' 9	
Excentricity ... ..	0.16311	
Mean diurnal motion ... ..	451".91	
Semi-axis major ... ..	3.9504	

Hence the period of sidereal revolution is 2,868 days, or 7.85 years.—For No. 158 detected at Berlin on Jan. 4, Dr. Maywald, who has been so long occupied in computations connected with the minor planets, has proposed the name "Koronis."—No. 155, discovered by Palisa at Pola

on Nov. 8, has so far been observed only on four nights, and these observations being at intervals which render them unavailable for calculation of elliptical elements, it appears not unlikely that it will be lost, as are already several minor planets similarly circumstanced, unless an effort be made to recover it with the aid of circular elements in the next period of absence of moonlight, and with some one of the larger telescopes; it was not brighter than a star of the twelfth magnitude at discovery, and must now be considerably fainter.—The period of revolution of No. 150 by seven weeks' observations is 4,879½ days.

M. Paul Henry, of the Observatory of Paris, announces his discovery of No. 159 on Jan. 26.

THE SECOND COMET OF 1702.—A complete reduction and discussion of the observations of this comet, taken at Rome by Bianchini and Maraldi, does not afford indications of elliptical motion, as might be surmised to exist from the small inclination of the orbit to the ecliptic and the direct movement. In fact, these observations appear to be by no means precise, and the differences from calculation *inter se* are too irregular to afford any hope of sensibly improving upon the orbit given by Burckhardt. Considering that the differences of right ascension between the comet and comparison stars were taken by means of clocks, and the differences of declination measured by a micrometer scale, the arc value of which was determined by observation of the sun's diameter, rather better places might have been looked for. The following are the errors given by Burckhardt's orbit, as compared with the newly reduced positions in which aberration and parallax have been taken into account:—

1702, April 20	$\Delta \lambda. \cos. \beta$ ...	+ 7'.2	$\Delta \beta$ ...	- 1'.2
" " 21	" "	- 1'.6	" "	- 6'.1
" " 26	" "	- 1'.4	" "	- 1'.8
" " 27	" "	- 3'.5	" "	+ 2'.4
" May 2	" "	+ 9'.1	" "	- 3'.1
" " 4	" "	- 7'.6	" "	- 3'.6

The comet was at its least distance from the earth on the night of April 19, when it approached our globe within 0.0438 of the earth's mean distance from the sun.

PROF. TYNDALL ON GERMS\*

IN further illustration of the dangers incurred in this field of inquiry the author refers to the excellent paper of Dr. Roberts on Biogenesis, in the "Philosophical Transactions" for 1874. Dr. Roberts fills the bulb of an ordinary pipette to about two-thirds of its capacity with the infusion to be examined. In the neck of the pipette he places a plug of dry cotton-wool. He then hermetically seals the neck and dips the bulb into boiling water or hot oil, where he permits it to remain for the requisite time. Here we have no disturbance from ebullition, and no loss by evaporation. The bulb is removed from the hot water and permitted to cool. The sealed end of the neck is then filed off, the cotton-wool alone interposing between the infusion and the atmosphere.

The arrangement is beautiful, but it has one weak point. Cotton-wool free from germs is not to be found, and the plug employed by Dr. Roberts infallibly contained them. In the gentle movement of the air to and fro as the temperature changed, or by any shock, jar, or motion to which the pipette might be subjected, we have certainly a cause sufficient to detach a germ now and then from the cotton-wool which would fall into the infusion and produce its effect. Probably, also, condensation occurred at times in the neck of the pipette; the water of condensation carrying back from the cotton-wool the seeds of life. The fact of fertilisation being so rare as Dr. Roberts found it to be is a proof of the care with which

\* On the Optical Department of the Atmosphere in reference to the Phenomena of Putrefaction and Infection. Abstract of a paper read before the Royal Society, January 13th, by Prof. Tyndall, F.R.S. (Communicated by the author.) Continued from p. 254.

his experiments were conducted. But he did find cases of fertilisation after prolonged exposure to the boiling temperature; and this caused him to come to the conclusion that under certain rare conditions spontaneous generation may occur. He also found that an alkalisied hay-infusion was so difficult to sterilise that it was capable of withstanding the boiling temperature for hours without losing its power of generating life. The most careful experiments have been made with this infusion. Dr. Roberts is certainly correct in assigning to it superior nutritive power. But in the present inquiry five minutes boiling sufficed to completely sterilise the infusion.

Summing up this portion of his inquiry, the author remarks that he will hardly be charged with any desire to limit the power and potency of matter. But holding the notions he does upon this point, it is all the more incumbent on him to affirm that as far as inquiry has hitherto penetrated, life has never been proved to appear independently of antecedent life.

Though the author had no reason to doubt the general diffusion of germs in the atmosphere, he thought it desirable to place the point beyond question. At Down, Mr. Darwin, Mr. Francis Darwin; at High Elms, Sir John Lubbock; at Sherwood, near Tunbridge Wells, Mr. Siemens; at Pembroke Lodge, Richmond Park, Mr. Rollo Russell; at Heathfield Park, Messrs. Hamilton; at Greenwich Hospital, Mr. Hirst; at Kew, Dr. Hooker; and at the Crystal Palace, Mr. Price, kindly took charge of infusions, every one of which became charged with organisms. To obtain more definite insight regarding the diffusion of atmospheric germs, a square wooden tray was pierced with 100 holes, into each of which was dropped a short test-tube. On Oct. 23, thirty of these tubes were filled with an infusion of hay, thirty-five with an infusion of turnip, and thirty-five with an infusion of beef. The tubes, with their infusions, had been previously boiled, ten at a time, in an oil-bath. One hundred circles were marked on paper so as to form a map of the tray, and every day the state of each tube was registered upon the corresponding circle. In the following description the term "cloudy" is used to denote the first stage of turbidity; distinct but not strong. The term "muddy" is used to denote thick turbidity.

One tube of the 100 was first singled out and rendered muddy. It belonged to the beef group, and it was a whole day in advance of all the other tubes. The progress of putrefaction was first registered on Oct. 26; the "map" then taken may be thus described:—

*Hay.*—Of the thirty specimens exposed one had become "muddy"—the seventh in the middle row reckoning from the side of the tray nearest the stove. Six tubes remained perfectly clear between this muddy one and the stove, proving that differences of warmth may be overridden by other causes. Every one of the other tubes containing the hay infusion showed spots of mould upon the clear liquid.

*Turnip.*—Four of the thirty-five tubes were very muddy, two of them being in the row next the stove, one four rows distant, and the remaining one seven rows away. Besides these six tubes had become clouded. There was no mould on any of the tubes.

*Beef.*—One tube of the thirty-five was quite muddy, in the seventh row from the stove. There were three cloudy tubes, while seven of them bore spots of mould.

As a general rule organic infusions exposed to the air during the autumn remained for two days or more perfectly clear. Doubtless from the first germs fell into them, but they required time to be hatched. This period of clearness may be called the "period of latency," and indeed it exactly corresponds with what is understood by this term in medicine. Towards the end of the period of latency, the fall into a state of disease is comparatively sudden; the infusion passing from perfect clearness to cloudiness more or less dense in a few hours.

Thus the tube placed in Mr. Darwin's possession was clear at 8.30 A.M. on Oct. 19, and cloudy at 4.30 P.M. Seven hours, moreover, after the first record of our tray of tubes, a marked change had occurred. It may be thus described:—Instead of one, eight of the tubes containing hay-infusion had fallen into uniform muddiness. Twenty of these had produced Bacterial slime, which had fallen to the bottom, every tube containing the slime being covered by mould. Three tubes only remained clear, but with mould upon their surfaces. The muddy turnip-tubes had increased from four to ten; seven tubes were clouded, while eighteen of them remained clear, with here and there a speck of mould on the surface. Of the beef, six were cloudy and one thickly muddy, while spots of mould had formed on the majority of the remaining tubes. Fifteen hours subsequent to this observation, viz. on the morning of Oct. 27, all the tubes containing hay-infusion were smitten, though in different degrees, some of them being much more turbid than others. Of the turnip-tubes, three only remained unsmitten, and two of these had mould upon their surfaces. Only one of the thirty-five beef-infusions remained intact. A change of occupancy, moreover, had occurred in the tube which first gave way. Its muddiness remained grey for a day and a half, then it changed to bright yellow green, and it maintained this colour to the end. On the 27th every tube of the hundred was smitten, the majority with uniform turbidity; some, however, with mould above and slime below, the intermediate liquid being tolerably clear. The whole process bore a striking resemblance to the propagation of a plague among a population, the attacks being successive and of different degrees of virulence.

From the irregular manner in which the tubes are attacked, we may infer that, as regards *quantity*, the distribution of the germs in the air is not uniform. The singling out, moreover, of one tube of the hundred by the particular *Bacteria* that develop a green pigment, shows that, as regards *quality*, the distribution is not uniform. The same absence of uniformity was manifested in the struggle for existence between the *Bacteria* and the penicillium. In some tubes the former were triumphant; in other tubes of the same infusion the latter was triumphant. It would seem also as if a want of uniformity as regards *vital vigour* prevailed. With the self-same infusion the motions of the *Bacteria* in some tubes were exceedingly languid, while in other tubes the motions resembled a rain of projectiles, being so rapid and violent as to be followed with difficulty by the eye. Reflecting on the whole of this, the author concludes that the germs float through the atmosphere in groups or clouds, with spaces more sparsely filled between them. The touching of a nutritive fluid by a Bacterial cloud would naturally have a different effect from the touching of it by the interspace between two clouds. But as in the case of a mottled sky, the various portions of the landscape are successively visited by shade, so, in the long run, are the various tubes of our tray touched by the Bacterial clouds, the final fertilisation or infection of them all being the consequence. The author connects these results with the experiments of Pasteur on the non-continuity of the cause of so-called spontaneous generation, and with other experiments of his own.\*

On the 9th of November a second tray containing one hundred tubes filled with an infusion of mutton was exposed to the air. On the morning of the 11th six of the

\* In hospital practice the opening of a wound during the passage of a Bacterial cloud would have an effect very different from the opening of it in the interspace between two clouds. Certain caprices in the behaviour of dressed wounds may possibly be accounted for in this way. Under the heading "Nothing new under the Sun," Prof. Huxley has just sent me the following remarkable extract:—"Uebrigens Kann man sich die in der Atmosphäre schwimmenden Thierchen wie Wolken denken, mit denen ganz leere Luftmassen, ja ganze Tage völlig reinen Luftverhältnisse wechseln." (Ehrenberg, "Infusions Thierchen," 1838, p. 525.) The coincidence of phraseology is surprising, for I knew nothing of Ehrenberg's conception. My "clouds," however, are but small miniatures of his.

ten nearest the stove had given way to putrefaction. Three of the rows most distant from the stove had yielded, while here and there over the tray particular tubes were singled out and smitten by the infection. Of the whole tray of one hundred tubes, twenty-seven were either muddy or cloudy on the 11th. Thus, doubtless, in a contagious atmosphere, are individuals successively struck down. On the 12th all the tubes had given way, but the differences in their contents were extraordinary. All of them contained *Bacteria*, some few, others in swarms. In some tubes they were slow and sickly in their motions, in some apparently dead, while in others they darted about with rampant vigour. These differences are to be referred to changes in the germinal matter, for the same infusion was presented everywhere to the air. Here also we have a picture of what occurs during an epidemic, the difference in number and energy of the Bacterial swarms resembling the varying intensity of the disease. It becomes obvious from these experiments that of two individuals of the same population, exposed to a contagious atmosphere, the one may be severely, the other lightly attacked, though the two individuals may be as identical as regards susceptibility as two samples of one and the same mutton infusion.

The author traces still further the parallelism of these actions with the progress of infectious disease. The *Times* of January 17 contained a remarkable letter on Typhoid Fever signed "M.D.," in which occurs the following remarkable statement:—"In one part of it (Edinburgh), congregated together and inhabited by the lowest of the population, there are, according to the Corporation return for 1874, no less than 14,319 houses or dwellings—many under one roof, on the 'flat' system—in which there are no house connections whatever with the street sewers, and, consequently, no water-closets. To this day, therefore, all the excrementitious and other refuse of the inhabitants is collected in pails or pans, and remains in their midst, generally in a partitioned-off corner of the living room, until the next day, when it is taken down to the streets and emptied into the Corporation carts. Drunken and vicious though the population be, herded together like sheep, and with the filth collected and kept for twenty-four hours in their very midst, it is a remarkable fact that typhoid fever and diphtheria are simply unknown in these wretched hovels."

This case has its analogue in the following experiment, which is representative of a class. On Nov. 30 a quantity of animal refuse, embracing beef, fish, rabbit, hare, was placed in two large test-tubes opening into a protecting chamber containing six tubes. On Dec. 13, when the refuse was in a state of noisome putrefaction, infusions of whiting, turnip, beef, and mutton were placed in the other four tubes. They were boiled and abandoned to the action of the foul "sewer gas" emitted by their two putrid companions. On Christmas-day the four infusions were limpid. The end of the pipette was then dipped into one of the putrid tubes, and a quantity of matter comparable in smallness to the pock-lymph held on the point of a lancet was transferred to the turnip. Its clearness was not sensibly affected at the time; but on the 26th it was turbid throughout. On the 27th a speck from the infected turnip was transferred to the whiting; on the 28th disease had taken entire possession of the whiting. To the present hour the beef and mutton tubes remain as limpid as distilled water. Just as in the case of the living men and women in Edinburgh, no amount of fetid gas had the power of propagating the plague, as long as the organisms which constitute the true contagium did not gain access to the infusions.

The universal prevalence of the germinal matter of *Bacteria* in water has been demonstrated with the utmost evidence by the experiments of Dr. Burdon Sanderson. But the germs in water are in a very different condition, as regards readiness for development, from those in air. In

water they are thoroughly wetted, and ready, under the proper conditions, to pass rapidly into the finished organism. In air they are more or less desiccated, and require a period of preparation more or less long to bring them up to the starting-point of the water-germs. The rapidity of development in an infusion infected by either a speck of liquid containing *Bacteria* or a drop of water is extraordinary. On Jan. 4 a thread of glass almost as fine as a hair was dipped into a cloudy turnip infusion, and the tip only of the glass fibre was introduced into a large test-tube containing an infusion of red mullet. Twelve hours subsequently the perfectly pellucid liquid was cloudy throughout. A second test-tube containing the same infusion was infected with a single drop of the distilled water furnished by Messrs. Hopkin and Williams; twelve hours also sufficed to cloud the infusion thus treated. Precisely the same experiments were made with herring with the same result. At this season of the year several days' exposure to the air are needed to produce so great an effect. On Dec. 31 a strong turnip-infusion was prepared by digesting thin slices in distilled water at a temperature of 120° F. The infusion was divided between four large test-tubes, in one of which it was left unboiled, in another boiled for five minutes, in the two remaining ones boiled, and after cooling infected with one drop of beef-infusion containing *Bacteria*. In twenty-four hours the unboiled tube and the two infected ones were cloudy, the unboiled tube being the most turbid of the three. The infusion here was peculiarly limpid after digestion; for turnip it was quite exceptional, and no amount of searching with the microscope could reveal in it at first the trace of a living Bacterium; still germs were there which, suitably nourished, passed in a single day into Bacterial swarms without number. Five days have not sufficed to produce an effect approximately equal to this in the boiled tube, which was uninfected but exposed to the common laboratory air.

There cannot, moreover, be a doubt that the germs in the air differ widely among themselves as regards *preparedness* for development. Some are fresh, others old; some are dry, others moist. Infected by such germs the same infusion would require different lengths of time to develop Bacterial life. This remark applies to and explains the different degrees of rapidity with which epidemic disease acts upon different people. In some the hatching-period, if it may be called such, is long, in some short, the differences depending upon the different degrees of preparedness of the contagium.

The author refers with particular satisfaction to the untiring patience, the admirable mechanical skill, the veracity in thought, word, and deed displayed throughout this first section of a large and complicated inquiry by his assistant, Mr. John Cottrell, who was zealously aided by his junior colleague, Mr. Frank Valter.

NOTE. Jan. 31.—The notion that the author limited himself to temperatures of 60° and 70° Fahr. is an entire misconception. But more of this anon.

#### THE OCCURRENCE AND MANUFACTURE OF FLINT SKIN-SCRAPERS FROM NEW JERSEY, U.S.A.

A REMARKABLE feature of the common Indian relics found in Central New Jersey is the very great abundance of "skin-scrapers," as one form of stone implements is everywhere known; and the great care that has evidently been bestowed upon them in the making equally attracts the attention when a series of these implements is examined. That a flint implement used in the preparation of skins for clothing and tent-covering should require as much care in its manufacture as an arrow-point, does not seem probable, and one would naturally expect to find in a scraper simply a comparatively



dull rubbing edge given to a conveniently sized pebble. Such, however, is seldom or never the case, and the class of implements, to which is given the above name, are as marked in their several peculiarities as is any form of stone implement with which we are familiar.

Having remarked the great abundance of these relics, I desire here more particularly to notice several specimens which are of more than ordinary interest. The illustrations 1, 2, 3, and 4, are figures of the very smallest scrapers that I have seen; and what is more remarkable than their small size is the beauty of their finish and their symmetry. They are made of differently coloured jasper, were not found together or in the same neighbourhood, showing that they had different origins, and are not ex-



FIG. 1.

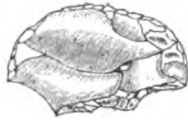

FIG. 2.

amples of the fancy of some eccentric chipper of flint implements, such as sometimes occur in masses of broken specimens and flakes that indicate the former site of an arrow-maker's labours.

Not one of these four small scrapers appears to be simply a flake, originally of this shape and subsequently chipped at the scraping edge; but the entire surfaces have undoubtedly been carefully wrought, and show that a small mass of the mineral has been worked to the shape and finish of the specimens, as now found. A quite common form of scraper is the base of an arrow or spear point which has been utilised by subsequently chipping the fractured end, so as to give it a bevelled edge; but the specimens here figured cannot be classed with these, inasmuch as there is nothing suggestive of the arrow-point in their present shape, and unlike them, these four specimens have the under side smooth and slightly concave, a feature not found in the "made over" arrow-heads.

Having seen that so much care was expended on these small scrapers, it is quite certain that these implements were put to some important use, but exactly what, it is difficult to determine. Certainly, in the dressing of the skins of our larger mammals they could be of no use, and of but little even when the skins of the smallest, such as squirrels, were used, which was probably seldom the case, as the larger quadrupeds were as easily obtained. The



FIG. 3.



FIG. 4.

skins of birds, if used as ornaments, would not need scraping to make them pliable; and I can only suggest that from the fact of having found traces of bone beads, in graves, made from sections of the long bones of wading birds, I have thought it probable that these small scrapers were used in rounding off the ends of such bone beads; and they might also have been used in the shaping and sharpening of the beautiful bone fish-hooks our aborigines were accustomed to make. Such uses would, of course, make the name "skin-scraper" inappropriate, as I am quite disposed to think it is.

Fig. 5 represents a very perfect specimen of the spoon-shaped scrapers, such as are common in Europe, and by no means rare in the United States. Those found here, as a rule, are not so symmetrical as the specimen figured, and do not have the "bowl" or concave portion of the

spoon so decidedly marked. Our New Jersey specimens have this under-surface generally plain, or but slightly concave; and uniform with the stem or handle of the implement. In the specimen figured this is not the case, and the spoon-shape is so pronounced as to suggest that it is a veritable spoon.

Fig. 5 has been chipped from a very pretty agate pebble, such as occur in the gravelly bed of the upper waters of the Delaware River; and it is an interesting

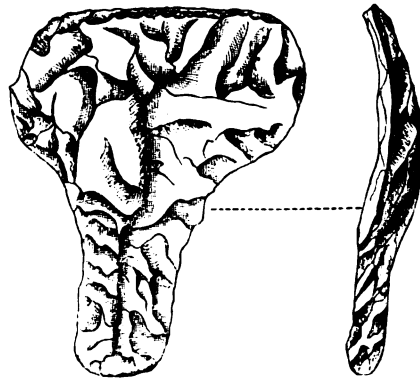

FIG. 5.

fact connected with this class of relics, that the majority are made of jasper, agate, and quartz, minerals the most difficult to shape, and certainly no better adapted to the ordinary uses of these implements—that of scraping the fat from skins.

One word in conclusion. Mr. C. C. Jones, jun., in his work on the "Antiquities of the Southern Indians," writes, under the head of "Scrapers," that "the spoon-shaped scraper of France and Switzerland is more pronounced in form and purpose than any implement of like character it has been my good fortune to find among the relics of the southern tribes."

It is curious that so much variation in the forms of their stone implements should exist in tribes nearly related, and but a few hundred miles apart. Judging from the specimens figured by the author quoted, scrapers were quite simple in their shape and finish; which, as we have seen, is the opposite of what we find in New Jersey, where as great a variety in shapes and sizes occur as exist in the various patterns of arrow-points. \*

CHARLES C. ABBOTT

Trenton, New Jersey

THE RECENT BUTTER CASE

AS the case in connection with the Adulteration Act which we discussed in a leading article last week is of considerable importance, both from a scientific and a public point of view, we think it well to put the facts before our readers.

The following summary of the analytical results detailed in Court by the different chemists has been supplied us from a verbatim report of the proceedings before the magistrate at Southwark Police Court.

These results were given after the magistrate's decision had been delivered. They were entirely informal, and took the shape of a discussion, in which everyone appeared to act as his own counsel, and no attempt was made to establish or trace the identity of the samples.

\* As authority for applying the term "scraper" to implements similar to Fig. 5, permit me to quote the late Prof. Jeffries Wyman ("Fifth Annual Report of Peabody Museum," 1872, p. 27). He writes, "The term scraper is applied to some of the implements just referred to (a collection from the author), because of their close resemblance to such as bear the same name from the Danish collections belonging to the Museum. They are characterised by having a circular or semi-circular flattened head, with a short projection which might serve as a handle, or for the purpose of attaching one. They differ from the Danish implements chiefly in their much smaller size."

## Dr. Muter's analysis—

Water	=	15.00	per cent.
Salt	=	3.96	" "
Curd	=	2.14	" "
Foreign fat	=	55.2	" "
Butter fat	=	23.7	" "

The fat was thus made up of 30 per cent. of butter fat and 70 per cent. foreign fats. The fat had a melting point below that of butter, and yielded 93.3 per cent. of fatty acids. When examined by the microscope the butter was found to contain fat in a crystalline state, and the so-called curd consisted of vegetable matter, which was described as parenchyma. Finally, the butter was stated to be but slightly rancid.

Dr. Muter said that his standard for genuine butter was 88 per cent. of fatty acids.

Dr. Muter, who appears to have had sufficient of his sample to supply several of his friends, was supported in Court by his assistant Mr. De Konigh, Dr. Dupré, Mr. Wigner, and a microscopist.

*Dr. Dupré and Mr. Wigner's Results.*—Dr. Dupré found in the fat 94.05 per cent. and Mr. Wigner 94.20 per cent. fixed fatty acids, and the melting-point of the fat 4° C. below that of genuine butter. On a microscopic examination of the butter, both found crystals of fat, which indicated that it had been fused. They also stated that the butter was practically free from rancidity.

Dr. Dupré was of opinion, from the results of his analysis, that there was a doubt whether the sample contained any butter at all; and Mr. Wigner considered that if it contained any butter-fat the quantity must be small, but indeed he thought it was foreign fat simply flavoured with caproic acid. He further stated that his standard for pure butter was 87.5 per cent. fatty acids.

*Somerset House Results.*—The portion of the sample retained by the inspector, and referred by the magistrate to Somerset House for analysis, weighed about 45 grammes, and it was stated that the experiments performed were not only of an exhaustive character, but were repeated in most instances.

The chemists there found as follows:—

Water	=	9.83	per cent.
Salt	=	3.70	" "
Curd	=	0.93	" "
Fat	=	85.54	" "

The fat gave a melting point of 33.3° C., a density of .9053 at 100° Fahr., and yielded 88.7 per cent. fatty acids, the latter being seven-tenths above Dr. Muter's standard.

The butter was found to be very rancid, and this rancidity would account for the slight excess of fixed fatty acids, it having been found by actual experiment that butter depreciates by exposure, and that there is a corresponding increase of the fixed fatty acids found in the fat.

On a microscopic examination the butter was found to be free from crystals of fat, and the only foreign substances present were a few particles of impurities consisting of hard wood and cotton thread.

The following are the results of the analysis of the fat of an article corresponding to "butterine," which was referred to in Court as having been examined in exactly a similar way as the sample in dispute:—

Fatty acids, 93.32 per cent., melting-point, 25° C., and density of fat at 100° F. = .90108.

The processes followed by the different chemists for the analysis of the samples differed but little, but the chemists at Somerset House adopted an additional safeguard against error in saponifying the fats, by taking the density of the fat in the sample at a temperature of 100° F.

The melting-point, the density of the fat, and the quantity of fixed fatty acids were clearly shown to be in complete accord, and these three results are certainly most important in their direct bearing on the accuracy of the analysis.

## NATURAL HISTORY OF ST. HELENA

THE following extracts from a letter addressed to Dr. Hooker by Mr. Wollaston, who has been residing for some months in St. Helena for the purpose of investigating the insect fauna, can hardly fail to be interesting to students of geographical distribution:—

"Plantation House, St. Helena, Nov. 22, 1875

"At this season of the year it is extremely difficult to obtain seeds, for the genuine native plants which are still not extinct, in addition to being extremely few in number, nearly all grow in places very difficult of access at a time when the upper ridges are nearly always covered with cloud, and only a certain proportion of them are showing any signs of active life (in the shape of flowers and seeds); but I have been able to collect three out of the four species of cabbage-trees, a *Lobelia*, two or three *Wahlenbergias*, and (best of all) the extremely rare *Aster* (or *Commidendron*) *Burchellii*. This last is, I think, as nearly extinct as anything still living can be. Mr. Melliss says there is only one plant of it in the island; but in that he is wrong, for we counted two or three, in full blossom, in the same grove of the *Aster gummiferus*, in which he records the existence of his single individual. We have, however, seen it nowhere else, and it is decidedly on its last legs. Even the *A. gummiferus* is excessively rare, and I shall hope to get you seeds of it before we leave the island; as well as of the *Commidendron robustum* (the true 'gum-wood'). . . . The *A. Burchellii* is so rare that I have been drying you a few specimens, feeling that (as it may soon be gone altogether if we cannot persuade the islanders to spare it from their donkey-loads of firewood) you might, perhaps, like some fresh ones. . . .

"The insect flora, although so extremely limited that I have not in nearly even three months collected more in Coleoptera than 150 species, still continues to keep up its character for eccentricity—ringing the changes on some half a dozen types (chiefly Rhyncophorous) to a marvellous extent. We seem indeed never to exhaust them, turning up new species almost every time that we can secure a hard day's work on the *Composita* ridge. Having ultimately to work them out, I take scores of specimens, and must have mounted carefully some six or seven thousand already." T. D.

## NOTES

THE following are the proposed movements of H.M.S. *Chalenger*:—She was to leave Valparaiso on Dec. 10, and arrive at the Falkland Isles on Jan. 10; leave on Feb. 6, arrive at Monte Video Feb. 18; leave Feb. 28, arrive at Tristan d'Acuhna March 20; leave March 21, arrive at Ascension April 7; leave April 14, arrive at St. Vincent May 5; leave May 12, and arrive in England June 12.

THE Senior Wrangler in this year's Cambridge Mathematical Tripos is Mr. Joseph Timmis Ward, of St. John's, son of the late Mr. Henry Ward, of Banbury. He was educated at Rochester Cathedral Grammar School, under the Rev. R. Whiston. Mr. William L. Mollison, of Clare, the Second Wrangler, is a native of Aberdeen, and is the son of Mr. W. Mollison, of that town. He was educated at the Grammar School and University of Aberdeen.

WE would call attention to the advertisement in to-day's NATURE by the Kew Committee, offering to the public greater facilities for the verification of instruments than have hitherto existed at Kew.

WE understand that the eminent ornithologist, Dr. G. Hartlaub, of Bremen, has in preparation a new work on the Birds of Madagascar. This will be a considerable undertaking, as since

the publication of Dr. Hartlaub's last work on this subject ("Ornithologischer Beitrag zur Fauna Madagascars," Bremen, 1861), great additions have been made to our knowledge of the ornithology of this wonderful island by the investigations of Pollen, Van Dam, Grandidier, Crossley, and other naturalists.

DR. O. FINSCH, of Bremen, and Alfred Brehm—both well-known German naturalists—will accompany the scientific expedition to the Obi (Northern Siberia), which is to start in March next.

THE Museum of Bremen, founded by a private society of merchants, and well known to ornithologists of all countries from the rarity of many of the specimens and the excellent manner in which they are mounted, will shortly become the property of the City of Bremen. It is said that Dr. O. Finsch is likely to be appointed its first director under the new régime. We may add that no more eligible selection could be made.

NEW ZEALAND papers just to hand report an interesting discovery of moa bones in that colony farther north than any have previously been found. No remains of the extinct bird having been discovered north of the town of Auckland; the moa region was supposed to have lain altogether to the south of that place. The advices now received, however, state that numerous bones, representing the skeletons of fifteen moas, have been found along the beach for many miles north of Whangarei Heads, sixty miles to the north of Auckland. The discoverers were Mr. George Thorne, and Mr. Kirk, the Secretary of the Auckland Institute. With the moa bones were discovered several human skulls and a complete human skeleton in a sitting posture (the position in which it was usual to bury Maoris); also many large pebbles, such as the moa was in the habit of swallowing with its food, a rude stone hatchet, and some chips of obsidian. The spot where the remains were discovered was at one time covered with vegetation, but this having been burned by bush fires the ground had been covered by drifting sand, the disturbance of which by the wind has exposed the bones. The natives in the district had no knowledge whatever of the existence of any of the remains discovered, whose antiquity is believed to be considerable. Further researches in the same locality may possibly be productive of interesting results.

A LETTER from M. Alluard, the director of the Puy de Dôme Observatory, has been published in the *International Bulletin* of Jan. 29, intimating that the establishment is now in full operation. M. Alluard has ascended the mountain for the purpose of taking instruments to the observers on the top. The elevation is about 6,000 feet above the level of the sea. It was on the top of the Puy de Dôme that, in 1647, Perier, the brother-in-law of Pascal, verified the fact, discovered at Paris, that pressure diminishes with the altitude. The first experiments were made by Pascal himself on the top of St. Jacques la Boucherie, whose height is about ninety feet. A statue of Pascal was placed on the basement of the tower about 1862, when occurred the second centenary of his death. The top of the Puy de Dôme is to be connected by a telegraphic wire with the Clermont Academy of Sciences, so that observations may be recorded daily and sent by telegram to every station in correspondence with the International Service.

AT the Court of Common Council last week Sir Charles Reed presented a resolution of the Committee for managing the Gresham College Trusts, of which Committee Sir Charles is a member, and Lord Selborne Chairman. Sir Charles gave a brief history of the institution, which, as our readers may surmise, was a record of decay and misappropriation. Sir Charles's motion, which was agreed to, was that the Gresham Committee (City side) be authorised to put themselves in communication with the Charity Commissioners, with the view of effecting the objects

contemplated. In 1867 the Gresham Committee was advised by counsel that the only satisfactory solution of the difficulty would be found in the agreement of the Corporation and the Mercers Company to propound a scheme for the sanction of Parliament. That agreement has now happily been arrived at. We hope that Sir Charles's prediction will be realised, and that the result of the deliberations will be a scheme which will cause the College once more to represent the wishes of the founder in making it, what he originally designed it to be, a college for the furtherance and advancement of learning in London.

INTELLIGENCE received at Lisbon last week announced that Lieut. Cameron was almost completely restored to health. Baron Barth, the well-known German geographer, had arrived at Lisbon *en route* for Angola.

A REPORT by Drs. W. Elgar Buck and G. C. Franklin, on the Epidemic Diarrhoea of 1875 in Leicester, has been presented to the Sanitary Committee of that borough and printed. After a careful analysis of the whole facts, the authors show that Leicester is not an unhealthy town as regards the adult population; that the excessive rate of its infantile mortality, which really regulates the total mortality, is due to a "specific diarrhoea," eminently fatal, which prevails in July, August, and September; that such conditions, as are often assigned as causes of this destroyer of infant life, viz., early age or debility of parents, maternal neglect and debility, non-suckling, and opium-poisoning of infants exist in Leicester, as in other manufacturing towns, but have no appreciable effect in the main question at issue; and that the houses in which the fatal cases occur are not in themselves insanitary as regards size and number of rooms, water supply, ventilation and space, house drainage, and closet accommodation. The disease is not diffused equally among all classes of the community, the wealthy classes being wholly exempt from it as regards fatal results; and it is not the most densely-peopled districts, nor the poorest sections of the community in which the mortality is greatest; but the disease is most prevalent where the soil is water-logged, where sewers are liable to be blocked up, and where the houses have been built on undrained ground made up of refuse from all parts. In those districts of the town where these conditions exist in a less degree, the disease is less prevalent, and where they do not exist, the disease is almost wholly unknown. Drs. Buck and Franklin recommend, for the mitigation of the disease, that the subsoil be efficiently drained of its superfluous water, that a free outfall be found for the sewers, and that clay-pits or other excavations should not be filled up with filthy ash-bin refuse and then built upon. We hope that the authors of this suggestive Report will resume the inquiry next summer with the view of modifying or confirming the results they have arrived at, and of throwing further light on the history of this terrible epidemic, which every year almost assumes the magnitude of a pestilence among the infants of Leicester.

M. DE TOUCHIMBERT reports that in the district round Poitiers, the sowing of the winter cereals has been remarkably and very seriously interfered with, first by the drought which prevailed up to the close of October, and then by continuous rains for the first fortnight in November, followed by severe frosts during the rest of the month. Heavy storms of wind followed each other in succession on Nov. 9, 10, and 11, doing great damage to houses, and uprooting and otherwise destroying trees. Pneumonia and bronchitis have been peculiarly prevalent, owing probably to these violent alternations of drought, great humidity, and low temperature.

M. ALBERT LE BLEU, chief engineer of mines at Rodez, has visited the Paris Observatory to consult regarding the organisation of the Departmental Meteorological Commission, of which

he is president. The Commission proposes to apply the grant received from the Council-general to a thorough examination of the rainfall, the thunderstorms, and particularly the storms of hail in the different valleys of Aveyron. An anemometer is to be erected at the top of the cathedral. In developing the extremely difficult question of the issue of weather forecasts calculated to be practically useful to agriculturists, it is recognised that the essential conditions of success as regards the observers are sound sense, intimate knowledge of the physical features of the district, and shrewdness in interpreting weather signs, such as long residence in the locality alone, can give, and that it is also essential to success to carry out a minute and extensive observation of the rainfall, thunderstorms, and storms of hail within and immediately surrounding the district to which the weather-warnings are sent.

MR. JAMES PATON, who for many years has been connected with the Museum of Science and Art, Edinburgh, has been appointed Curator of the Industrial Museum, Glasgow.

THE first general meeting of the Mineralogical Society of Great Britain and Ireland is held to-day at the Scientific Club, Saville Row, at 12 o'clock (noon), when the chair will be taken by Mr. H. C. Sorby, F.R.S. The first ordinary meeting will be held at the same place and time to-morrow, when a paper will be read on the Scottish Rhombohedral Carbonates, by Prof. M. Forster Heddle, M.D.

IT is proposed to establish a Technical College for Glasgow. In so far as the teaching of the textile department is concerned, the accomplishment of the scheme is all but assured.

As the Algerian Government have refused to take observations at eight o'clock in the morning, as in Europe, a Constantine newspaper, *Progrès de l'Est*, proposes to open a public subscription in order to send to France and England daily telegrams making known the state of weather in the colony. These weather telegrams are to be posted in the several hotels of Paris, London, Lyons, Marseilles, and other large cities, where intending tourists are likely to see them.

A SLIGHT earthquake was felt in Constantine, Algeria, at nine o'clock on the morning of Jan. 20. No damage was experienced. The duration was two seconds, and the shock vertical.

THE town of Abancay, in Peru, is reported to have been destroyed by an earthquake between 4 P.M. on the 4th and 9 A.M. on the 5th December. Thirty-seven shocks occurred, several very severe, with loss of life, the extent of which was not known.

BY decree of the French Government, a Chair of Physical Astronomy has been established in the Faculty of Science, Bourdeaux, to be filled by M. Rayet, and at Lyons a Chair of Industrial and Agricultural Chemistry, to be filled by M. Raulin.

TWO academies of medicine have been established by a decree of the President of the French Republic at Nantes and Marseilles.

PROF. TARGIONI has been appointed by the Italian Minister of Agriculture and Commerce Director of an Agrarian Entomological Station at Florence.

In the *Brighton Observer*, which made its first appearance in its new form on Friday last, is a London letter on the scientific doings of the week. It appears to be the first of a series, in which it is intended to give, in a popular form, an account of the lectures and papers read before the societies which are likely to be of general interest. The idea is, we believe, a novel one, and we hope it will find favour with readers.

THE rockwork in the tanks at the new Westminster Aquarium contains a considerable amount of Portland oolite. We understand that it was purchased from the debris of the Colosseum, Regent's Park, as a sandstone, and it appears to have been introduced into salt and fresh tanks alike without investigation as to how far it is suitable. It perhaps may do no harm, but it would be well if anyone who has experience of what its effect will be would communicate his knowledge before any animals are placed in the tanks. There is, in addition, a good supply of Carboniferous limestone used, and in considering the conditions, it must be remembered that the water circulates constantly from tank to tank, so that the carbonate of lime will be just as present to all the inhabitants of the aquarium as to the Lamellibranchs and others it might benefit.

THE last-issued number of the publication of the Eastbourne Natural History Society contains a paper by Mr. Jenner on the Macro-Lepidoptera of East Sussex.

THE additions to the Zoological Society's Gardens during the past week include a Rhesus Monkey (*Macacus erythraeus*) from India, presented by Mr. T. O. Davis; a Black-faced Spider Monkey (*Ateles ater*) from Central America, two Green Turtles (*Chelone viridis*) from the West Indies, presented by Captain King; a Grey Ichneumon (*Herpestes griseus*) from India, presented by Mr. H. Churchill; a Common Curlew (*Numenius arquatus*), a Herring Gull (*Larus argentatus*), a Common Gull (*Larus canus*), two Black-headed Gulls (*Larus ridibundus*), European, presented by Mr. Charles Clifton.

#### THE LOAN EXHIBITION OF SCIENTIFIC APPARATUS

THE following is a list of the members of the Foreign Committees, the appointment of whom has been already notified to the Department of Science and Art:—

**BELGIUM.**—M. le Général Brialmont, M. Dewalque, M. le Général Liagre, M. Maus, M. Plateau, M. Schwann, M. Stas, M. Van Beneden.

**FRANCE.**—M. Alexre. Edmond Becquerel, M. Henri Marie Bouley, M. Gabriel Auguste Daubrée, M. Jean Louis Armand de Quatrefages De Breau, M. Jean Baotiste Dumas, M. Herré Auguste Etienne Albans Faye, M. Edmond Fremy, M. Jules Célestin Jamin, M. Urbain Jean Joseph Le Verrier, Le Général Arthur Jules Morin, M. Eugène Melchior Peligot, M. Henri Edouard Tresca.

**GERMANY.**—I. *Berlin Committee.*—Dr. A. W. Hofmann, Dr. Beyrich, Dr. du Bois-Reymond, Dr. Dove, Dr. Förster, Dr. Hagen, T. G. Halks, Dr. Hauchecorne, Dr. Helmholtz, Dr. Kiepert, Dr. G. Kirchhoff, Dr. Kronecker, Dr. C. D. Martius, Von Morozowicz, Dr. Neumayer, Dr. Reuleaux, Dr. Schellbach, Dr. W. Siemens, Dr. Virchow, Dr. C. H. Vogel, Dr. Websky.—II. *Committee representing other Cities and Towns of Germany.*—Dr. Von Babo, Dr. Beetz, Dr. Buff, Dr. Clausius, His Excellency Dr. Von Dechen, Dr. Von Fehling, Dr. Von Feilitzsch, Dr. Graebe, Dr. Von Groddeck, Dr. Heeren, Dr. Hittorf, Dr. Karsten, Kiel; Dr. Karsten, Rostoch; Dr. Knapp, Dr. Knoblauch, Dr. Kölliker, Dr. Kundt, Dr. Launhardt, Dr. Möhl, Dr. Poleck, Dr. Preyer, Dr. Von Quintus-Icilius, Dr. Reusch, Dr. Romberg, Dr. Rosenthal, Dr. Serlo, Dr. C. Von Siemens, His Excellency Dr. Von Steinbeis, Dr. W. Weber, Dr. Wiedemann, Dr. Winkle, Dr. Wöhler, Dr. Willner, Dr. Zeuner, Dr. Zetzsche.

**ITALY.**—Prof. Blaserna, Prof. Cantoni, Prof. Respighi.

**THE NETHERLANDS.**—Prof. Dr. P. D. Ryke, Prof. Dr. H. G. de Sande Bakhuizen, Prof. C. H. D. Buys Ballot, Prof. J. Bosscha, Prof. Dr. F. C. Donders, F.R.S., Prof. J. W. Gunning, Prof. Dr. R. A. Mees, Prof. V. S. Van der Willigen, Dr. D. de Loos (Secretary).

**SWITZERLAND.**—Prof. E. Wartmann (President), Prof. J. Amsler Laffon, Prof. D. Colladon-Ador, Prof. Dr. F. A. Forel, Prof. Dr. E. Hagenbach-Bischoff, Prof. Ad. Hirsch, Prof. Albert Mousson, M. E. Sarasin-Diodati, Prof. L. Soret Colonel Gautier (Secretary).

### PROF. NORDENSKJÖLD ON THE JENISEI

IN a letter from Prof. Nordenskjöld, of Stockholm, to Mr. Oscar Dickson, Prof. Nordenskjöld gives the following further details of his expedition.

In my preceding letters I narrated the progress of the *Novaya Zemlya* Jenisei Expedition up to the time when we, after a boat voyage of fifty to sixty Swedish miles, at Saostrowskoj on Aug. 31, fell in with the steamer *Alexander*, in which we afterwards journeyed 150 Swedish miles further up the Jenisei during a whole month to the town of Jeniseisk.

I proceed now to finish the account of my journey, with a short sketch of this steam voyage.

The *Alexander* was neither a passenger nor a cargo steamer, but formed a moveable warehouse propelled by steam, which was commanded not by seamen but by a friendly and affable merchant, who clearly did not much concern himself with the navigation of the vessel, but rather with trade and goods, and was seldom by the crew called "captain" but generally "hosain" (master). The arrangement of the vessel itself corresponded to this state of things. The whole of the fore-saloon was fitted up as a shop with shelves for goods along the walls, the usual desk, &c. The after-saloon was employed as a counting-house, writing and sleeping apartment for the master, and was besides filled to overflowing with wares of various kinds for sale, spirit casks, &c. There was thus no room for passengers, and at the first when we lay-to with the Swedish flag hoisted, our "hosain," Herr Ivan Michailovitch Jarmenief's reception of us was by no means specially friendly. He was even indisposed in the beginning to take us along with him. But no sooner had I, with the help of our pilot Teodor and a Swedish-Russian lexicon, succeeded in explaining to him what sort of people we were and what journey we had made, than all was completely changed, and from that moment we had in our "hosain" the most agreeable and obliging host we could desire. In order to make room for us on board, a cabin before the wheel-house, which had been filled with goods, was emptied and arranged for passengers. Its size was by no means great. During the night, for instance, we could only with difficulty lie alongside each other on a bedstead formed of boards, which took up nearly the whole cabin. Our men at first got places wherever they could, in the engine-room, where they were kindly entertained by the engineer. Afterwards we obtained another more roomy cabin, and our men got that which we had in the beginning.

The navigation of the vessel was managed by two mates, of a stately and original appearance, who, clothed in long caftans, each during his watch sat on a chair at the wheel, generally without steering, for the most part smoking a "papiross," and with the most unconcerned expression in the world exchanging jokes with those who were walking below. A man stood constantly in the fore part of the vessel, unceasingly trying the depth of the water with a long pole. In order to avoid the strong current of the deep central stream the course was taken not in the deepest part of the river, but as near the bank as possible, often so near that we could almost jump to land, and that our Nordland boat, which was towed alongside the steamer, was often drawn over land. The *Alexander* besides had in tow first one, afterwards two vessels (lodjor), nearly of the same size as the steamer itself, intended to receive the fish bought during the voyage, which was generally salted and prepared on board. The whole way between Jeniseisk and the sea there is not a single jetty, and on this account both the steamer and the two lodjor towed in addition a number of larger or smaller barges and boats intended for communication with the land. Siberia,\* and especially the river territory of Jenisei, possesses rich coal beds, which probably extend under a great part of the Siberian plain, but as yet are not worked, and attract little attention. Like all the other steamers on the Siberian rivers, accordingly the *Alexander* was fired not with coal but with wood of which 180 fathoms, if I remember rightly, went to the voyage up the river. The steamer could carry only a small portion of this quantity, on which account frequent delays were necessary, not only for trading with the inhabitants, but also for taking fuel on board. The feeble engine, besides, notwithstanding that the safety valves were in case of need overloaded with lead weights,

was often enough unable to make head with all it had in tow against the current, which at some places was very powerful, and in the attempt to find stream-free water near the banks, the vessel often went too near land and ran aground, notwithstanding the continual "ladno" cry of the pilot with the pole posted in the forepart of the steamer. We went, therefore, so slowly, that it was only after the lapse of a whole month that we reached the destination of the steamer, the town Jeniseisk, situated about 150 Swedish miles from Dudino.

In such circumstances most passengers by a steamer would be impatient and in bad humour. To us, on the contrary, the delay was welcome; inasmuch as we had thus an opportunity of extending our examination of the flora and fauna of the territory of the Jenisei even beyond the 60th degree of latitude. It is easy to see that a portion of these researches will also have a practical interest; for instance, the examination which Dr. Lundström has made of the flora of North Jenisei.

Our knowledge of it has heretofore been grounded chiefly on observations made by men of science (Middendorff, Schmitt, &c.) who have visited these regions for other purposes, and only in passing have had opportunities of turning attention to the flora. Dr. Lundström's main object, on the contrary, was exclusively botanical (he had before made himself well acquainted with the Arctic plant world by botanical journeys in Lapland and his native Nordland), and as he came during the voyage up the river from the northerly regions, poor in species, to the southerly, richer in species, it was easier for him than for one who travelled in an opposite direction to give the northern limit of a number of species of general occurrence common to Siberia and Scandinavia. Abundance of botanical and climatological material has been collected in this way, which naturally is not yet worked up, but it is easy to see what new light a comparison of the spreading of plants towards the north in our long-cultivated land and the desolate plains of Siberia will shed on the possibility of cultivating the latter country. Already I may be permitted here to mention that in opposition to what would have appeared probable beforehand the northern limit of many plants in Siberia is situated farther towards the north than in Sweden. To a certain extent this may perhaps depend on the seed being carried by the great river from more southerly southerly regions, but it also appears that the severe winter of Siberia has by no means any specially injurious influence on the vegetation of the summer.

Immediately after we came on board the steamer weighed anchor and steamed to the church village, Dudino, situated some miles up the river, where its tributary, the Dudinka, falls into it. The village consists of some few houses inhabited by an influential merchant, Sotnikoff, two priests, a "smotritel" (magistrate), a pair of exiles, and some workmen and natives. Sotnikoff carries on an extensive and profitable trade with the natives in the whole of the surrounding district, exchanging grain, cloth, tea, sugar, iron wares, gunpowder, lead, brandy, &c., for furs, fish, mammoth-teeth, &c., which last he sends with the steamer, first up the Jenisei, and afterwards by different methods of communication on to China, Moscow, Petersburg, &c. In his account of his well-known expedition for disinterring a mammoth found near the mouth of the Jenisei, the Petersburg academician Schmitt praises Sotnikoff much for the unselfish and energetic way in which the expedition was assisted by him. To us too was this plain unpretentious merchant specially hospitable and friendly, and it is incumbent on me to mention that we also met with the same reception from all the other notabilities of the place. The friendly clergyman, who was much interested in our journey, even performed a short thanksgiving service for the successful issue of the expedition on board the steamer and declined to accept any special honorarium on this account.

As in the more northerly situated "simovies," the houses in all the villages situated on the Jenisei were built of logs in much the same style as those of the well-to-do peasants in Russia, pretty close together, with richly decorated gables to the street or road of the village. The interior of the houses was, if we except the innumerable cockroaches found everywhere, very clean, and the walls were adorned with numerous, if not very artistically finished photographs and engravings for the most part of the Russian imperial family, remarkable Russi in notabilities, generally in general's uniform, scenes from Russian history, &c. Richly ornamented consecrated pictures were always placed in a corner, and before these were always suspended some oil lamps or small wax lights, which were lighted on holidays. Sometimes the floor, at least in the principal room, was besides covered with

\* As an instance, may be mentioned some exceedingly rich coal seams, which crop out on the eastern bank of the Jenisei, a little to the south of the town Krasnojarsk, just in the neighbourhood of the place where the "Pacific Railway" of Siberia will probably some day go forward. When I visited the place one of the coal seams was on fire. Nearer the mouth of the Jenisei, too, coal seams of considerable extent occur, for instance, at the bank of a tributary of the Jenisei, not far from Dudino.

mats of furs. The bed consisted of a couch near the roof, so extensive that it occupied a third or a half of the room, and so far from the floor that a man could go under it upright. Food was prepared in large baking ovens, which were daily fired for this purpose, and warmed the hut at the same time. New bread was to be had every day; and even for the poor a large brass tea urn was a necessary household article. We were always sure of meeting with a hearty and friendly reception wherever we stepped over the threshold, and if we stayed a short time we had generally to drink a glass of tea with our hosts whatever time of the day it might be. The dress everywhere somewhat resembled the common Russian; for the better classes for instance wide velvet trousers stuck into the boots, a shirt grandly embroidered with silver, and a wide caftan often trimmed with fur; for the poor, in case he was not too ragged, the same cut, but inferior, dirty, and torn material. During the winter, however, the Samoyede fur dress is worn out of doors both by high and low, by Russian and native, by settled and nomad.

For the present there were in these regions only very few persons who had been banished hither for political reasons, but on the contrary many exiled criminals, and among them also some few Finns, and even a Swede, or at least one who according to his own statement in broken Swedish had formerly served in the King's body-guard in Stockholm. Security for person and property was in all cases complete, and it was remarkable that there was no true difference of caste that could be observed between the Russian-Siberian natives and those who had been banished to those regions for crimes. Little interest even appeared to be taken in knowing the crimes which had caused the banishment. An inquiry on this point was generally met by the sufficiently elastic reply "for bad conduct."

I mentioned above that mammoth teeth here form an important article of commerce. They are also believed to occur in large quantity on the tundra, though the difficulty of communication often renders their removal impossible. Although this is the mammoth region proper, the larger parts of the skeleton are believed to be very rare, and still more mammoth with flesh, hide and hair still remaining. It was, for instance, on the peninsula between Obi and Jenisei, that the great mammoth find by Trofimoff occurred, and in the neighbourhood of the same place was found the mammoth which gave occasion to Schmitt's expedition. It is probable, besides, that the nomad native has the same indisposition to acquaint an official with a large mammoth find as the peasants at home had in former times, and in certain regions still have to give information about a supposed vein of ore.

On Sept. 4 the *Alexander* weighed anchor, and steamed southwards during splendid weather.

The landscape now began by degrees to change its character completely. In fact, on most maps the limit of wood is drawn along the considerable bend which the river Jenisei makes immediately west or north-west of Dudino, and indeed here for the first time numerous pine trees are met with, but seldom more than 20 feet high. These cover the heights with a sparse and by no means attractive vegetation, completely destitute of the beautiful effect which distinguishes the willow and alder bushes farther north. Already some few miles south of Dudino, however, the pine forest became tall, though here we are still north of the Arctic circle. It is here that the forest proper commences—the largest forest of the globe—stretching with little interruption across the whole of Siberia, in one direction, from Ural to the Sea of Ochotsk, and in the other, south of the 58th or 59th degree of latitude, and north of the Arctic circle, at some places, for instance at the rivers Chatanga and Lena, beyond it on to the neighbourhood of 72° N. lat., that is to say, to the mouths of Chatanga and Lena, ten Swedish miles north of North Cape.

During our boat and steam voyage up the Jenisei we had heretofore only landed either upon the eastern bank of the river, which was always high, or on some of the numerous islands which at some places occur in the river, which widens out nearly to a lake. On Sept. 7 we had, for the first time, an opportunity of landing on the western bank of the river, which, like the western bank of most of the rivers flowing from the south to the north, consists of low tracts of land which are inundated in spring. This meadow land was now covered partly with an extraordinarily luxuriant carpet of grass, which of course was untouched by the scythe, partly with an exceedingly peculiar bush vegetation of equal height, in which we found a number of herbs known among us in Sweden, but here six to eight feet high. Compact thickets of a beautiful straight-stemmed willow frequently alternated with even grass turf of a lively green with

small streams, tributaries of the Jenisei, in a way which gave the impression of the most beautiful park, carefully kept and watered, and kept clear of withered branches and grass. On the eastern side, on the contrary, the ancient forest proper commenced close to the river bank. Here nature had quite a different stamp of grandeur and gloom. The forest consisted principally of pines, which, even north of the Arctic Circle, were often of the most colossal dimensions, but in such cases many times grey and shortened to half their height by age. Between these the ground was so covered with fallen stems, with branches nearly fresh, half decayed or converted into a mass of wood-mould, which was kept together merely by the bark, that one could force his way only with difficulty and with danger of breaking his legs in the thicket. The fallen stems were besides completely covered, many times even concealed by an uncommonly luxuriant moss vegetation; the tree lichens, on the contrary, occur here only sparingly, in consequence of which the spruce firs were devoid of the shaggy clothing common with us, and the bark on the birches which glauced out here and there among the spruce firs was distinguished by an uncommonly blinding whiteness. When one made his way into this monotonous wood a little distance from the river, it was necessary to be well acquainted with the points of the compass; a mistake in this respect had carried us in a direction in which at a distance of a hundred, perhaps two hundred (Swedish) miles, there was no probability of meeting with an inhabited place. In speaking of the vegetation in these regions it may be mentioned that in the northern forest along the river bank there was abundance of wild red and black currants exceedingly well tasted, and of dimensions surpassing even the largest varieties of cultivated currants I have had an opportunity of seeing.

Since we left Jewremow-Kamen, near the mouth of the Jenisei, we had not seen any solid rock at the river banks, but on the 8th we saw solid rocks on the eastern bank. We made here, as at a number of the other places at which we landed, a rich collection of land molluscs. By means of these collections, which have been already handed over to our skillful molluscologist, Dr. C. A. Westerlund, at Ronneby, to be examined, the known mollusc-fauna of North Siberia will be greatly increased, and many erroneous views hitherto prevalent regarding the geographical distribution of this interesting group of animals will be rectified. This holds good also of various land and freshwater invertebrates, of which considerable collections were made, which have already been distributed to specialists for examination.

After having remained for a longer or shorter time at about ten different "simovie" or fishing-stations, we came on Sept. 12 to a "simovie," Silivauskoi, exclusively inhabited by Skoptists. The orthodox Russian Church is, as is well known, tolerant towards men of foreign faiths, Lutherans, Catholics, Jews, Mohammedans, Buddhists, &c., but, on the contrary, in full accordance with what took place in former times within the Protestant world, visits sectaries within its own bosom with temporal punishments in this world and threatens them with eternal in another. Especially in former times have a number of sectaries been sent to Siberia, and there are accordingly peculiar colonies in a very prosperous state to be met with occasionally, exclusively inhabited by a certain sect. Such is the Skopt colony at Silivauskoi, of which it may be remarked that the nature of the religious delusion here excuses the stringency of the law or the administration. For, on the ground of a text in the Gospel of Matthew, interpreted in a peculiar way, all Skoptists subject themselves to a self-mutilation, in consequence of which the sect can exist only through new proselytes, and remarkably enough, these madmen, in fact, notwithstanding, or perhaps just on account of, all persecution, still find successors. A number of Skoptists are Ingrians (Finns from Ingermanland), on which account I could converse with them without difficulty. They related that they had "for righteousness' sake" been torn from their homes, imprisoned, flogged, and sent to Siberia. Here they had by industry and perseverance succeeded in attaining for themselves a certain competence, were hospitable and friendly, and bore with resignation their hard lot, assured that in another life they would reap a rich reward for their self-denial, suffering, and misfortunes here below. They did not kill any warm-blooded animal, "for it was a sin to kill what the Lord had created," which did not prevent them from catching and eating fish, nor from selling to us, who in any case were doomed to perdition, for 18 roubles a beautiful and fat ox, on condition that our own people should slaughter it. Their indisposition to use some animal foods had besides had the good result that their



attention was turned to the cultivation of the soil. Round the huts, accordingly, were patches of land in potatoes, turnips, and cabbage, which at least this year yielded abundant crops, though the colony is situated in the latitude of Avaxaxa, that is to say, under the Arctic circle.

Later in the day we came to the Monastery of Troit, in former times renowned and rich, now inhabited only by a single monk, viz., the prior himself. He was a worthy old man, who gave us a hospitable and friendly reception. The apartment for the reception of guests was adorned with a number of portraits of Siberian bishops. There was besides a portrait of a Russian Czar in powdered hair and military uniform, with blue great cross riband. It was a portrait of Czar Paul, but through some exchange the Skoptists had taken it into their heads that the portrait represented their holy prophet, Czar Peter III., whose history they had completely altered in accordance with their idealised conception of the world. An educated man, who belonged to this sect, and on this account had been banished to North Jenisei, informed me accordingly in all seriousness that Czar Peter III. was not murdered, but was knouted and sent to Siberia, &c., all on account of his holiness—as so it happens now that in consequence of all this the portrait of Czar Paul in the Troit Monastery is a sacred picture to which worship is offered.

A. E. NORDENSKJÖLD

(To be continued.)

### SCIENTIFIC SERIALS

THE *Journal of the Chemical Society* for December 1875 contains the following papers communicated to the Society:—On the agricultural chemistry of the tea-plantations of India, by J. Campbell-Brown, D.Sc. This lengthy paper contains analyses of the young and old leaves of good plants and of stunted and blighted plants of different varieties, analyses of the wood of good and stunted tea-plants of different varieties, analyses of tea-seed, of the soils of tea-plantations, and of tea from manured and unmanured plants. The author discusses also the analytical results.—On certain new reactions of tungsten, by Prof. J. W. Mallett, of the University of Virginia. The author has found, contrary to the statements in text-books, that the precipitate produced by hydrochloric acid in a solution of an alkaline tungstate is soluble in an excess of the concentrated acid. By adding fragments of metallic zinc to the above-named acid solution, various colours are produced, the most noteworthy being a brilliant magenta. Potassium sulphocyanate and metallic zinc added to the acid solution produce a rich green colour, but when the sulphocyanate is added first to the alkaline tungstate solution, then a considerable quantity of water, then hydrochloric acid, and finally zinc, a fine amethyst colour is produced. The blue colour well known as characteristic of one of the lower oxides of tungsten may be best brought out by the use of hyposulphurous acid ( $H_2SO_3$ ) as the reducing agent.—The remainder of the journal contains the usual collection of abstracts.

*American Journal of Science and Arts*, Dec. 1875.—This number commences with a paper of careful observations by Prof. Dana on five of the river valleys of Southern New England, with a view to ascertaining the depression of that region during the melting of the glacier. This he estimates at about 15 feet. He considers that the terraces in the Housatonic, Connecticut, and Thames, which are now so high above the river's surface, were not wholly, or mostly formed when the land was at a much lower level than now, but they were formed when the rivers were at a greatly higher level than now, owing chiefly to the glacial flood. Thus we may have high and numerous terraces along valleys, and yet none be due to an elevation of the land. The height of the streams during the flood above high tide level is estimated in one case at as much as 237 feet (from which the 15 feet depression would be deducted). The amount of depression increased from the south northwards at about one foot and a half per mile, since Dawson has shown that the height of the beaches at Montreal indicate a depression there of 500 feet. The waters from the melting glacier must have brought down the streams in vast volume to have piled to so great heights before outlets so wide and deep.—Prof. Storer, of Harvard, gives some observations which show (after Schönbein) that ammonia is a constant contaminant of sulphuric acid, and further, that it is a more frequent impurity in chemical substances (prepared with aid of sulphuric acid) than has been supposed.—An abstract is given of a memoir by Prof. Suess of Vienna on the origin of the

Alps.—Mr. Andrews describes some new and interesting coal-plants from Perry County, Ohio, and Dr. Becker calls attention to a new feature in the "Comstock Lode" in Nevada.—In a letter from Dr. Gould, of Cordoba Observatory, the writer states that his zone observations, begun in 1872, are now completed; and the entire region from  $23^{\circ}$  to  $80^{\circ}$  of south declination has been carefully scrutinised. The  $10^{\circ}$  round the pole have been examined by Gillis at Santiago and Stone at Cape of Good Hope, and Gould's northern limit overlaps Argeländer's southern zone by eight degrees (as Argeländer had requested).

Supplementary December Number.—Mr. Langley here contributes a paper on the solar atmosphere, being introductory to an account of researches made at the Alleghany Observatory. The estimates of the absorptive power of this atmosphere, based on photometric comparison of the centre and edge of the sun, have been widely discrepant; thus Arago thought the light of the centre must be diminished 2.4 per cent. to equal that of the edge; Liass's estimate is 10 and Secchi's 78 per cent. Mr. Langley here describes a new method of measurement free from some of the objections to previous ones; and he thinks the estimates of Secchi (who used La Place's formula) are certainly in excess of the truth. Not much more or less than one half (he considers) of the whole so-called "luminous heat rays" are absorbed, turned back, or converted into work, in the sun's atmosphere. The total thermal absorption is somewhat less. The method is also applicable to sun-spots, &c., and Mr. Langley finds the absolute light of the "nuclei" in spots at least *five thousand times* that of the full moon.—In a supplemental paper on Southern New England during the melting of the great glacier, Prof. Dana discusses the overflows of the flooded Connecticut, which he concludes was at that time a great stream 150 feet deep and fifteen miles wide.

### SOCIETIES AND ACADEMIES

LONDON

Royal Society, Jan 6.—On the length of the Spark from a Battery of 600, 1,200, 1,800, and 2400 rod-Chloride of Silver, and some Phenomena attending the Discharge of 5,640 Cells. By Warren De La Rue, D.C.L., F.R.S., and Hugo W. Muller, F.R.S.

On the 24th February, 1875,\* we had the honour of communicating to the Society, in conjunction with our friend Mr. Spottiswoode, an account of some experiments to ascertain the cause of stratification in electrical discharges *in vacuo*. These experiments were made with a battery of 1,080 cells of powder-chloride of silver, which was described; we have now in action 3,240 such cells, and have recently completed 2,400 rod-chloride of silver cells,† making our total force 5,640 cells in action. To these will be shortly added another unit of 1,080 cells powder-chloride, and two other units of 1,200 rod-chloride, making a total of 9,120 cells.

We have more recently made a verbal communication to the Society of Telegraph Engineers, and also in October last a written one to the Académie des Sciences of Paris‡, wherein we have stated that the length of the spark in air appears to be in the direct ratio of the square of the number of cells.

Having completed the 2,400 cells, and charged them up in a single day, they were exactly in the same condition as to electro-motive force and internal resistance, consequently they afforded the means of testing the truth of the law of the length of spark in a manner more efficacious than had hitherto obtained, the more especially as by the use of paraffin corks and other precautions we had obtained an excellent insulation.

Our assistant, Mr. Fram, has constructed a discharger which permits of the accurate measurement of the distance of the terminals to read to  $\frac{1}{1000}$  of an inch, and by estimation to the tenth of that quantity. The nut, through which the screw ( $\frac{1}{8}$  of an inch), carrying one of the terminals, works, is divided into two parts, which are separated by a spiral pressure-spring, so as to prevent shake. In making measurements the terminals are separated to a greater quantity than the anticipated striking-distance, and gradually approached until the spark passes; the discharger is then detached from the battery, and after reading the scale, connected up with a separate battery of 10 cells, with a detector-galvanometer in circuit. The terminals are again approached until the motion of the galvanometer indicates contact between

\* Proc. Roy. Soc., No. 160, 1875.

† Proc. Roy. Soc., No. 160, 1875, p. 357.

‡ "Comptes Rendus," No. 16, p. 686; No. 17, p. 746, 1875.

them; the scale is again read, and the length of spark obtained by the difference between the first and second reading.

Rod-chloride, 600 cells had a striking-distance of	0'0033 in.
" 1200 "	" 0'0130
" 1800 "	" 0'0345
" 2400 "	" 0'0535

Taking as the unit 600 cells, the spark of which was 0'0033, the length of spark of 1,200, 1,800, 2,400 would, according to theory, be that number multiplied by the square of 2, 3, 4 respectively.

600 cells, striking-distance.....	0'0033 in.
1200 "	0'0033 × 4... 0'0132
1800 "	0'0033 × 9... 0'0297
2400 "	0'0033 × 16... 0'0528

which numbers agree nearly with those obtained by experiment.

The length of the spark is much influenced by the shape of the terminals, those which we frequently employ consist of a point as one terminal and a plane for the other; hitherto we have used copper terminals, making the point and the plane alternately positive and negative by means of a double-key discharger, or by a rapidly-revolving commutator reversing up to 352 times in a second. One terminal in the above determinations consisted of a point of 30°, and the other of a slightly convex surface 0'46 inch in diameter.

While making these measurements, we noticed in a nearly dark room that when the point was negative a glow, in form like a paraboloid, was seen surrounding it long before the spark passed, and its appearance afforded by its increasing brilliancy useful information to guide us as to the more cautious approach of the terminals; gradually the sugar-loaf-like glow extended to the positive terminal. With 1,800 cells the glow was seen when the terminals were 0'0545 inch apart, the spark passing at 0'0345 inch; with 2,400 cells the glow began at a distance of 0'0865 inch, the spark passing at 0'0535 inch. Moreover, it was noticed that the disc (positive) became covered all over with a peach-like bloom, which became stronger in the centre as the terminals were made to approach each other, giving rise to Newton's iridescent rings.

In order to study more readily the phenomena accompanying the glow preceding the spark, the whole series of 5,640 cells was used, the terminals being a point as before of 30°, and sometimes a flat disc 1'1 inch in diameter, or a slightly convex one of 0'8 inch in diameter for the other. In all cases a peach-like bloom deposited on the disc, which was connected with the silver (positive) terminal; and when the flat disc was used the deposit was notably greater at the periphery and the centre than in other portions of it. With this number of cells, with the flat disc the glow occurred at 1'073 in., the spark at 0'139 in. With the slightly convex disc occurred at 1'124 in., the spark at 0'140 in.\*

To ascertain whether a current really passed when the glow appeared, various vacuum-tubes were interposed in circuit between the battery and one of the terminals; in all cases they were illuminated even before a glow was perceptible on the negative pole; their interposition, as was to be expected, shortened the spark and diminished the distance at which the glow was perceptible. For example, with a hydrogen tube, having a capillary portion between two larger tubes, such as is used for spectrum experiments, and offering a resistance of 190,000 ohms, the glow occurred at 0'939 inch, the spark at 0'092 inch.

A tube of 31 inches between the terminals, and offering a resistance of 350,000 ohms, was brilliantly illuminated when interposed between one terminal and the battery; when the terminals were separated the extreme range of the discharge was 1'2 inch, and before any glow was visible at the negative electrode. How much further between the electrodes it will be possible to obtain a current has yet to be determined with a larger discharger now in course of construction.†

I have alluded to the resistance offered by vacuum-tubes. At first I experienced considerable difficulty in measuring it. For example, when in a Wheatstone's bridge the resistance of the tube was balanced by inserted resistances, the galvanometer could only for a short time be brought to rest, and it was then found that the cause of this was that the tubes rapidly increased in resistance as the current passed. After a time, however, they

recovered their original resistance, sometimes rapidly, sometimes only after the lapse of days. The resistances were found not to be dependent on the length of tube, but to a great extent on their bore, capillary tubes offering a considerable resistance. Ultimately it was found that it was better to discard the indications of the galvanometer, and to rely solely on the appearance of a luminosity in the tubes placed on one side of Wheatstone's bridge as soon as the insertion of a balancing resistance was made in the other.

Later on we hope to have the honour of sending to the Society a more detailed statement of our experiments in support of those now quoted, and in confirmation of our former paper on the cause of stratification in electric discharges *in vacuo*.

In conclusion we venture to draw attention to the following consequences of the law of the length of spark being dependent on the ratio of the square of the number of cells of a voltaic battery, in the event of its being confirmed by experiment. Taking as a basis the spark with 600 cells of the rod-chloride of silver battery = 0'0033 inch, a unit of 1000 such cells would give a spark of  $\frac{0'0033 \times 1000^2}{600^2} = 0'009166$  inch,

one hundred units (100,000) a spark of 91'66 inches,  
a thousand units (1,000,000) " 91'66 " = 764 feet nearly,

whereas a single cell would have a striking-distance of  $\frac{0'0033 \times 1000^2}{600^2}$  of an inch only. As far as our own experiments have gone the law has been confirmed; and although a million cells will probably never be made, a hundred thousand come within the range of experimental possibility.

Geological Society, Jan. 19.—John Evans, president, in the chair.—James Buckingham Bevington, William P. Blake, James Gordon Brickenden, Edward George Dyke, Henry Hamilton Gunn, William Jerome Harrison, and R. G. Warton, were elected Fellows of the Society.—On some unicellular algae parasitic within Silurian and Tertiary corals, with a notice of their presence in *Calceola sandalina* and other fossils, by Prof. P. Martin Duncan, F.R.S. After noticing the works of Quekett, Rose, Wedl, and Kölliker, which refer to the existence of minute parasitic borings in recent corals, recent shells, and a few fossil mollusca, the author describes the appearance presented by a great system of branching canals of about 0'003 millim. in diameter, in a Thamnastrea from the Lower Cretaceous of Tasmania. He then proceeds to examine the corresponding tubes in *Goniophyllum pyramidale* from the Upper Silurian formation. In sections of that coral one set of tubes runs far into the hard structure; these are straight, cylindrical, and contain the remains of vegetable matter. Neither these tubes, nor any others of the same parasite, have a proper wall: they are simply excavations, the filiform alga replacing the organic and calcareous matter abstracted. In some places the dark carbonaceous matter is absent, and the lumen of the tube is distinguishable by the ready passage of transmitted light. Other tubes run parallel to the wall, and enter by openings not larger than their common calibre. But there are others which have a larger diameter, and in which the cytoplasm appears to have collected in masses resembling conidia; and where fossilisation has destroyed much of the continuity of a tube a series of dark and more or less spherical bodies may be seen. In some places, especially in the spaces between the minute curved dissepiments and tabulae, hosts of globular spores, with or without tubes emanating from them, may be seen. In *Calceola sandalina* corresponding structures exist sometimes, and the method of entry of the parasite can be examined. The author gave two instances, one of which was seen in section. A decided flask-shaped cavity existed in the wall of the shell, opening outwards and rounded and closed inwards. It was crowded with globular spores (oospores), and these, where near the sides, had penetrated the hard shell, and thus gave a rugged and hairy appearance to the outline of the flask-shaped cavity. After noticing minute structures in a brachiopod included in a Silurian coral, and in a Lower Silurian foraminifer, the author asserted, from the results of his late researches upon the algae parasitic in corals out of his own aquarium, that the fossil and recent forms are analogous in shape, size, and distribution. He considers that the old parasite resembles *Saprolignia ferox* in its habit; and as he considers that *Empusina*, *Saprolignia*, and *Achlya*—members of the Protista—are the same organisms, living under different physical conditions, he names the old form *Palaachlya penetrans*; and he believes that it entered the wall by the spores fixing on to the organic matter, and growing by its assimilation, and that car-

\* Postscript, Jan. 7.—At the suggestion of Prof. Stokes, who saw the experiment repeated, the point was made positive, when a longer spark was obtained, namely, 0'154 inch and 0'164 inch.

† Postscript, Jan. 8th.—A current was obtained with the negative point distant 5'1 inches from a positive plate 6 inches in diameter.

bonic anhydride was evolved. He considers that this acid, assisted by the force of growth and the movement of the cytoplasm, are sufficient to account for the presence of the tubes. Finally, the author draws attention to the probable similarity of external conditions in the Silurian and present times, and to the wonderful persistence of form of this low member of the Protista.—How Anglesey became an Island, by Prof. A. C. Ramsay, F.R.S. The author described and illustrated by sections drawn to scale the contours of the island of Anglesey and the adjacent parts of Carnarvonshire, and noticed that the whole island may be regarded as a gritty undulating plain, the higher parts of which attain an average elevation of from 200 to 300 feet above the sea-level. Similar conditions are presented by the country for some miles on the other side of the straits, and in both the general trend of the valleys is north-east and south-west. The rock surfaces, when bare, show glacial striae running generally in a direction  $30^{\circ}$  to  $40^{\circ}$  west of south. The author indicated that the great upheavals of the crust of the earth forming mountains took place long before the commencement of the Glacial epoch, and that ordinary agents of denudation had ample time for the formation in mountain regions of deep valleys, down which, during the Glacial epoch, glaciers would take their course. He noticed the evidence of this local glaciation furnished by the striation of the Welsh mountains, from which he inferred that these mountains as a whole were not overridden by a great ice-sheet coming from the north, and he described the course of the glaciers flowing from the north-west slopes of Snowdonia as being in the directions west, north-west, and north. These glaciers, however, did not reach the region now occupied by the Menai Straits, but spread out in broad fans on the north-western slopes of the hills now overlooking the Straits, a fact indicated by the directions of the glacial striae in these parts. Anglesey, therefore, was not glaciated by ice-masses coming from Snowdonia; and as the striations on that island point directly towards the mountains of Cumberland, the author inferred that these markings were produced by a great ice-flow coming from that region, reinforced probably by ice-streams from the north of Scotland, and which were large and powerful enough to prevent the glaciers of Llanberis and Nantffrancon from encroaching on the territory of Anglesey. The author described the rocks bordering the Straits as consisting of nearly horizontal Carboniferous strata, which, from appearances, must once have filled the whole of the region now occupied by the Straits. He considered that the softer shaly, sandy, and marly beds, remains of some of which are still to be seen on the coast, were swept away by the action of the great glacier coming from the north-east, forming a valley now occupied by the sea; and in support of this view he cited the valley of Malldraeth Marsh, running across Anglesey, parallel to that of the Menai Straits, about four miles to the north-west, which a very slight change in conditions would convert into a fjord, differing from the Straits only in being closed at the north-east end.

**Meteorological Society, Jan. 19.**—Dr. Mann, president, in the chair.—The report of the Council showed that a large amount of work had been done, and that the number of Fellows had greatly increased. The first-class observing stations, which were organised in 1874, have been in regular working order during the past year, their number has been increased, and several have been reinspected. A very interesting account of all that has been done in organising the stations, with the conditions to be fulfilled by the observers in respect to instruments and exposure, the mode of inspecting, and a concise description of each station, with a ground plan on an uniform scale, has been prepared by Mr. Symons. An arrangement has been entered into with the Meteorological Office by which the Society has agreed to furnish, for a consideration, copies of observations from a definite number of stations. Various instructions for observers, prepared by the Station Committee and the Assistant-Secretary, are also given. The joint Committee of Delegates from this and other Societies, appointed to draft complete instructions for the observation and registration of natural periodical phenomena, have finished their labours and sent in their report. A code of rules entitled "Instructions for the Observation of Phenological Phenomena" has been prepared and published. The Rev. T. A. Preston has discussed the first year's observations, and his report is given in full. The Council have taken up the solar radiation observations commenced by the Rev. F. W. Stow, but they intend to compare the readings of the black bulb thermometer *in vacuo* with a bright bulb thermometer also *in vacuo*, both mounted alike, instead of the maximum thermometer in

the shade. The Council have also appointed a Permanent Lightning Rod Committee to investigate and record accidents from lightning, to inquire into the principles involved in the protection of buildings, to diffuse exact information regarding the best form and arrangement for lightning conductors, and to consider all phenomena of atmospheric electricity. The balance-sheets show that the Society is in a very satisfactory condition.—The President then delivered his address. In alluding to the establishment of a carefully planned series of observing stations by the Society he illustrated at some length the absolute necessity of following out the inductive method of research in meteorology, and supported his argument by a reference to the history of all the leading branches of physical investigation, in which the prophetic insight of inspired minds had invariably had to be elaborated and perfected by the patient labour of subsequent observation and experiment. He compared the meteorological doctrine of high and low pressure areas of the atmosphere, and of the movement of currents of the air, under the influence of the barometric gradient, to the Newtonian doctrine of gravitation in astronomical physics, to the Daltonian hypothesis of atomic proportions in chemistry, to the dynamic theory of the tides, and to Avogadro's law of the uniformity of the atomic constitution of gases under like conditions of pressure and temperature, and maintained that the perfection and practical application of this law must be worked out by organised and carefully thought-out plans of observation such as are now being used by the Society, and also under circumstances of higher opportunity and greater facility by the Meteorological Office of the Government. The President incidentally remarked that he believed the recent researches into the vertical circulation of the water of the ocean under the influence of the different specific gravities of its distant parts was virtually tending to the establishment of the same great influence, as being the moving spring of the physical dynamics of both the ocean and the atmosphere. The President also in allusion to the recent establishment of a Permanent Lightning Rod Committee by the Society, gave a very interesting account of a visit he had recently made to Prof. Meisens, of Brussels, and described the experiments upon which the Professor is engaged in investigating the molecular changes brought about in conducting bodies by the passage through them of powerful discharges of high tension electricity. He also gave an elaborate account of the admirable system of defence against lightning, which has been adopted at the Hotel de Ville of Brussels. Some curious and notable instances of the molecular effects of lightning discharge were exhibited during the delivery of the latter portion of the address.—The following gentlemen were elected Officers and Council for the ensuing year:—President, Henry Storks Eaton, M.A. Vice-Presidents: Charles O. F. Cator, M.A., Rogers Field, Assoc. Inst. C.E., John Knox Laughton, F.R.A.S., Capt. Henry Toynebee, F.R.A.S. Treasurer, Henry Perigal, F.R.A.S. Trustees: Sir Antonio Brady, F.G.S., Stephen William Silver, F.R.G.S. Secretaries: George James Symons, John W. Tripe, M.D. Foreign Secretary, Robert H. Scott, F.R.S. Council: Percy Bicknell, Arthur Brewin, F.R.A.S., Charles Brooke, F.R.S., Cornelius Benjamin Fox, M.D., Frederic Gaster, James Park Harrison, M.A., Robert James Mann, M.D., F.R.A.S., William Carpenter Nash, Rev. Thomas Arthur Preston, M.A., William Sowerby, F.L.S., Charles Vincent Walker, F.R.S., George Mathus Whipple, F.R.A.S.

**Anthropological Institute, Jan. 25.**—Col. A. Lane Fox, president, in the chair.—Annual Meeting.—The Report of Council for 1875 was read.—The following were elected to serve as Officers and Council for 1876:—President, Col. A. Lane Fox, F.S.A. Vice-presidents: Prof. Geo. Busk, F.R.S., John Evans, F.R.S., A. W. Franks, F.R.S., Francis Galton, F.R.S., Geo. Harris, F.S.A., E. Burnet Tylor, F.R.S. Directors: E. W. Brabrook, F.S.A., Capt. Harold Dillon. Treasurer, J. Park Harrison. Council: J. Beddoe, F.R.S., W. Blackmore, Sir Geo. Campbell, K.C.S.I., Hyde Clarke, J. Bernard Davis, F.R.S., W. Boyd Dawkins, F.R.S., Robert Dunn, F.R.C.S., David Forbes, F.R.S., Chas. Harrison, F.R.S.L., H. H. Howorth, Prof. T. McK. Hughes, F.G.S., Prof. Huxley, F.R.S., A. L. Lewis, Sir John Lubbock, Bart., F.R.S., F. G. H. Price, F.R.G.S., J. E. Price, F.S.A., Prof. Rolleston, F.R.S., C. R. Des Ruffieres, F.R.S.L., Lord Arthur Russell, M.P., M. J. Walhouse.

**Institution of Civil Engineers, Jan. 18.**—Mr. G. R. Stephenson, president, in the chair.—The following paper was read:—On the ventilation and working of railway tunnels, by Mr. Gabriel James Morrison.

## GENEVA

Physical and Natural History Society, Jan. 6.—M. Ernest Favre took up the discussion which has existed for ten years among geologists and palæontologists on the limit of the Jurassic and Cretaceous beds in the Alps, where the beds are not separated, as in the Anglo-Parisian basin, by freshwater deposits. Opperl, in 1865, gave the name of Tithonic stage to the beds containing Cephalopodous and Coralline fauna, and which are found in the upper part of the Jurassic system. Geologists, mostly French, of whom M. Hébert is the best known representative, assigning a part of these deposits to the Cretaceous formation and regarding the zone of *Ammonites tenuilobatus* as Oxfordian because it is covered by Coraliferous beds, admit that there is in the Alps a great gap between the Oxfordian and the Cretaceous formations. German and Swiss geologists, on the contrary, find in the Alps the complete series of the Upper Jurassic system of the Jura. They have shown that Coraliferous is developed in nearly all the horizons of these beds, and not only in that to which D'Orbigny has given the name of Coralline stage, a name which ought to be suppressed; that the highly developed zone of *Ammonites tenuilobatus* in the Alps is Kimmeridgian, and that the Tithonic beds belong to the Jurassic formation. M. Favre has found in the Western Alps of Switzerland the complete series of these strata; he has described it in a memoir on the Upper Jurassic formation Voiron. This series has the following four divisions from below upwards:—1. The Oxford formation, properly so called. 2. The zone of *Ammonites bimammatus*, which contains many species of the zone of *Amm. transversarius*. 3. The zone of *Ammonites Acanthicus* and *A. tenuilobatus* (Astartian). 4. Tithonic beds, which are the equivalent of the Solenhofen beds. The Voiron formation includes Nos. 2 and 3. The passage from the Jurassic to the Cretaceous systems has been worked in a part of the Alps, without any interruption in the four divisions; and if we cannot find all the equivalents of the fossiliferous beds of the Jurassic basin, it should be remembered that the deposits have been placed in the former region in conditions different from those which have reigned in the second.

## PARIS

Academy of Sciences, Jan. 24.—Vice-Admiral Paris in the chair.—The following papers were read:—On the decomposition of water by platinum, by MM. Sainte-Claire Deville and Debray. When a mixture of cyanide of potassium with spongy platinum is heated in a glass vessel raised to 500° or 600° near a dish of tepid water, *in vacuo*, large quantities of hydrogen are produced, and a double cyanide of platinum and potassium. A concentrated solution of cyanide of potassium attacks platinum at the boiling temperature.—Action of monohydrated sulphuric acid on alcohols, by M. Berthelot. He measures the heat liberated in such reactions.—New case of aphasia or loss of speech, arising from loss of the co-ordinated movements necessary for the act of pronunciation of words, without any lesion of the intellectual faculties, by M. Bouillaud.—On the falling in of the Cirque de Salazie, in the Isle of Réunion, by M. Sainte-Claire Deville.—On the star  $\gamma$  Ophiuchus, by M. Tisserand. He seeks to determine the orbit from 213 observations, comprising an entire revolution.—Report on the numbers of the *Revue d'Artillerie* submitted to examination of the Academy by the Minister of War.—Application of the mechanical theory of heat to the study of volatile liquids; simple relations between the latent heats, atomic weights, and tensions of vapours, by M. Pictet. *Inter alia*, latent heat multiplied by atomic weight (temperature and pressure being the same) gives a constant product. The difference of latent heats at any two temperatures multiplied by atomic weight is a constant number. The latent heats of all liquids are multiples of the specific heats.—Action of ammonia on rosaniline, by M. Jacquemin.—Researches on the constitution of collagenous matters, by MM. Schützenberger and Bourgeois.—Map of the globe in gnomonic projection on the horizon of the North Pole, by M. Thoulet.—On the action of cold on milk, and the products obtainable from it, by M. Tisserand. The rising of cream is quicker, and the volume of it greater, the nearer the temperature has been brought to zero; also the yield of butter is greater, and the milk creamed, butter and cheese are of better quality, the lower the temperature. The common practice might be greatly improved in this respect.—On the covariants of binary forms, by M. Jordan.—On a particular class of left inscribable polygons, by M. Serret.—Magnetic actions on the rarefied gases in Geissler tubes (fourth note), by M. Chauvart. The gaseous matter probably undergoes attraction or

repulsion under action of the magnet, resulting in compression against the side of the tube and change in the physical state of the luminous stream. The alteration of the spectrum by magnetism is more marked, the greater the diameter of the tube (from  $\frac{1}{8}$  mm. to 1 cm. in these experiments). With fluoride of silicium Geissler tubes, the author appears to find some indication of a new chemical reaction under magnetic influence.—On the spectrum of nitrogen and that of alkaline metals in Geissler tubes (continued), by M. Salet. He suggests that the lines described by Mr. Schuster in 1872 may have been those of sodium vapour.—On the action of heat in magnetisation, by M. Favre. Three phenomena observed:—1. Conservation of magnetism at any temperature, when the latter was maintained constant. 2. Diminution of the magnetism in cooling, at first slow, becoming very rapid after a time variable with the temperature of magnetisation. 3. Increase of the quantity of magnetism that remains after cooling, when the magnet is heated anew.—Note on a new system of electric lamp, with independent regulator, by M. Girouard.—On a new method of recording the movements of blood-vessels in man, by M. Mosso. We shall notice this separately.—Note on the development of the *Salmacina Dysteri*, Hux., by M. Giard. Several characters bring the embryo of *Salmacina* near that of Mollusca. The divergence between Molluscs and Annelids commences only after the Trochosphæra stage, and even after this there are many agreements. The parentage of Molluscs and Annelids is certainly nearer than that of the latter with Arthropods. The origin of the three groups must be sought among the Rotifers.—New fossil mammals from the deposits of phosphate of lime at Quercy, by M. Filhol.—Influence of various elements of manures on the development of the beet, and its saccharine richness, by M. Joulie.

French Physical Society, December 17, 1875.—M. Jamin communicated the formulæ which he has established to represent the distribution of magnetism in magnets furnished with contact armature. If the armature is indefinite, the magnetic intensity in the soft iron is represented by an exponent of a single term, as in the case of magnets of very great length; if the armature is shorter the intensity is given by the sum of the two exponents. The diminution of intensity in each point of the magnet follows the same law, and the constants of the formulæ may be determined by noting on the one hand that the total loss of magnetism on the magnet is equal to the gain in the armature, and on the other hand, that the intensity at the point of contact is the same in the armature and in the magnet.

## VIENNA

Imperial Academy of Sciences, Dec. 16, 1875.—On differential air thermometers, by M. Pfandler. Berthelot's air thermometer with capillary manometer has the drawback, that its data depend on the existing barometric state. M. Pfandler seeks to obviate this by his differential air thermometers. He gives various constructions of these.—On new fish species from the collections of the Imperial Zoological Museum, by M. Steindachner. Mostly species of siluroids from the Bay of Panama, &c.—On the flow of stratified clay under bodies pressed into it, by M. Obermayer.

## CONTENTS

	PAGE
THE UNIVERSITY OF LONDON AND SCHOOL EXAMINATIONS . . . . .	261
GUTHRIE'S "MAGNETISM AND ELECTRICITY" ( <i>With Illustrations</i> ) . . . . .	261
TWO AMATEUR EXPLORERS . . . . .	264
OUR BOOK SHELF . . . . .	265
LETTERS TO THE EDITOR:—	
The Article "Birds" in "Encyclopædia Britannica."—Prof A. H. GARROD . . . . .	266
The Difficulties of the Public Analysts.—W. MATTIEU WILLIAMS . . . . .	266
Science in Hastings.—ALEX. E. MURRAY . . . . .	267
OUR ASTRONOMICAL COLUMN:—	
The Total Solar Eclipse of 1876, Sept. 17-18 . . . . .	268
Minor Planets . . . . .	268
The Second Comet of 1702 . . . . .	268
PROF. LYNDALE ON GERMS . . . . .	268
THE OCCURRENCE AND MANUFACTURE OF FLINT SKIN-SCRAPERS FROM NEW JERSEY, U.S.A. By Dr. CHARLES C. ABBOTT. ( <i>With Illustrations</i> ) . . . . .	270
THE RECENT BUTTER CASE . . . . .	271
NATURAL HISTORY OF ST. HELENA. By T. D. . . . .	272
NOTES . . . . .	272
THE LOAN EXHIBITION OF SCIENTIFIC APPARATUS . . . . .	274
PROF. NORDENSKIÖLD ON THE JENISEI . . . . .	275
SCIENTIFIC SERIALS . . . . .	277
SOCIETIES AND ACADEMIES . . . . .	277

THURSDAY, FEBRUARY 10, 1876

## OLD AND NEW WORLD SPIDERS

*Descriptions of Several European and North-African Spiders.* By T. Thorell. Kongl. Svenska Vetenskaps. Akademiens Handlingar, Bandet 13, n. o. 5, pp. 1—203. (Stockholm : Norstedt and Söner, 1875.)

*A Collection of the Arachnological Writings of Nicolas Marcellus Hentz, M.D.* Edited by Edward Burgess. With Notes and Descriptions by James H. Emerton. Forming No. II. of Occasional Papers of the Boston Society of Natural History, pp. 1—171, Pl. 1—21. (Boston : U.S.A., 1875.)

IT is a somewhat singular coincidence that the two works at the head of this article should have been published just about the same time. We shall endeavour briefly to show the value and bearing of each.

It is probably undeniable that an illustrated book on any branch of natural history is more acceptable to the public—certainly more attractive—than one wholly devoid of pictorial illustrations; and not without good reason, for it is well known what great assistance even the advanced student obtains from a single glance at an illustration, when traced by a hand well cognisant of the point sought to be illustrated, even though the hand may be entirely wanting in artistic power. The want, however, of drawings to assist the comprehension of the dry details of natural objects may be reduced to a minimum by the presence of good diagnoses. Pleasant are those pages where both these helps exist; dreary and uninviting indeed (though sometimes inevitable) are long and dry details of form, structure, and colour, when unenlivened either by drawings or diagnoses. From such dreariness Dr. Thorell's two hundred quarto pages of descriptions of spiders (under the title given at the head of this notice) are saved by the excellent diagnosis with which each description is preceded. It not unfrequently happens that a diagnosis is a mere formal abstract of the longer description that succeeds it; this is, however, not the case in the present instance, where each diagnosis puts before us just such distinctive points of special form, structure, and colour as the describer, were he at all able with his pencil, would endeavour to delineate by means of rapid sketches and dissectional drawings.

In respect to this point Dr. Thorell remarks (p. 4), that he has "prefaced his descriptions with *diagnoses*, although this is not done by the generality of modern arachnologists," it is, he says, "my firm conviction that tolerably good diagnoses very greatly facilitate the determination of unknown species, even though they be not real [by the term *real* Dr. Thorell appears to mean *full*] definitions." This places a diagnosis, in relation to the full description, exactly on a par with the part delineation and dissectional drawing when compared with a full artistic illustration; neither the diagnosis nor the dissectional drawing, however characteristic, precludes the necessity for a full description, nor for a full artistic illustration where it can be had; in fact, were it not a serious question of space and cost, amounting often to a positive bar, no natural object could be said to be well and properly described and illustrated without a *diagnosis*, such as that mentioned

above, a *full description* embracing an almost photographic accuracy of every part, and (where closely allied forms exist) a *differential description* as well, besides full, and dissectional drawings. Of course the full description would be broken up into ordinal, family, generic, and specific characters, each in their proper place; the three first only requiring repetition where, in the individual examples, they happened to depart from the strict type.

The introductory pages of the work before us are in English, while the descriptions are in Latin; and the materials from which Dr. Thorell has drawn them up have been gathered from various collectors and widely distant parts of Europe, including the northern shores of Africa; which last, under the term "Mediterranean Basin," Dr. Thorell rightly joins to Europe as a single zoological province. 202 species, belonging to 51 genera, distributed among 12 families, are described, 24 of the species being given as new to science; a large proportion of the remainder, together with four new genera, having been published as new but a short time before, under the title "*Diagnoses Aranearum Europæarum aliquot Novarum Scripsit.*" T. Thorell, in *Tijds. voor Entom.* Deel. xviii., 1875.

Dr. Thorell states (p. 1) that he follows here, with some slight modifications, the classification proposed in his former work "*On European Spiders*;" this mention gives rise to a long foot-note, of two closely-printed pages, in which he examines and criticises M. Eugène Simon's strictures of his system (published in "*Aran. Nouv. ou peu Connus du Midi de l'Europe*," 2<sup>e</sup> Mém.; "*Mém. Soc. Roy. de Sciences de Liège*," 2<sup>e</sup> ser. t. v., 1873). It is not necessary to enter here into the merits of this little passage of arms, but we come to the conclusion, on perusing it, that Dr. Thorell is probably right in saying that he "has not been so fortunate as to make himself understood" by M. Simon. At page 7, the latter author's theory respecting the eyes of spiders is discussed in another long foot-note. This theory has already been noticed in these columns (vol. xi., p. 224). Dr. Thorell, while entering fully into the question of the real nature and structure of the eyes of spiders, says, with regard to this theory, that "it is to be wished that M. Simon would somewhat more accurately describe the researches on which his views are founded; his theory is, in fact, so much the more remarkable, as no previous naturalist who has investigated the finer structure of the eyes of spiders, appears to have been aware of the existence of any distinction between day-eyes and night-eyes." Independently, however, of M. Simon's theory, the question as to the nature of spiders' eyes is a very interesting one; and very valuable would be those researches which should reveal to us the actual anatomical condition of such eyes as, for instance, the apparently atrophied, and probably useless, ones of the hind-central pair in the genus *Oecobius*, Luc.

A footnote of considerable length is appended to pages 66 and 67 on the venom of various species of the genus *Lathroedectus*, comparing it with the reputed venom of *Galeodes araneoides*, and questioning the correctness of M. Simon's conclusions (*Mém. Soc. Roy., Liège*, 2 ser. t. v.), that the bite of *Lathroedectus 13-guttatus* is not poisonous. Another point, also of great interest, is noted at p. 65, where Dr. Thorell speaks of traces of segmenta-

tion (somewhat like that of the abdomen of the *Phalangidea*) in the shape of an encircling furrow towards the hinder extremity of the abdomen of some species of *Lathroedectus*: and he refers to the known fact of the segmentation of the abdomen in the *embryo* of spiders (Claparède, "Recherches sur l'Evolution des Araignées"). Still plainer evidences of obsolete segments have been previously noted in *Erigone corrugis*, Cambr. (Proc. Zool. Soc., March 1875, p. 214, Pl. XXIX. Fig. 21), as well as in some other species of the same genus.

Were it not for points thus incidentally raised, and some of which have been above noticed, Dr. Thorell's present work would be of little interest except to the arachnological specialist; by such, however, it will be hailed as an important and valuable addition to the literature upon European spiders; while a more general interest is imparted to it by the topics here commented upon.

It is one of the disadvantages attending the publication of papers on natural history in periodical journals that such papers are more or less inaccessible to those who either do not possess the journal, or who live at a distance from a library containing it; and this disadvantage is heightened when a series of papers, extending, perhaps, over many years, is thus issued, on any one subject. Araneologists are therefore greatly indebted to the editor of Prof. Hentz's writings, for clearing away a disadvantage of this kind, and one which has been much felt for a considerable period.

Prof. Nicolas Marcellus Hentz, a Frenchman by birth, but obliged to fly his native country at the downfall of the first Napoleon, devoted much time and labour in the United States, the land of his adoption, to the study and collecting of spiders. After having published some few short papers upon them, at length, in 1841, he brought together the whole of his notes and drawings, publishing them in a series of papers in the Journal of the Boston Society of Natural History, at intervals from that year to the year 1850. These papers, eight in number, and contained in three vols.—iv., v., and vi.—of the Boston Journal, together with two or three other papers previously published, and an unpublished<sup>1</sup> supplement, have now been collected and given to the public in the present volume.

Considerable difficulties attended the attainment of this result, especially in regard to the plates; the stones from which the lithographic plates were taken having been destroyed and several of the copper plates lost. The science of photography, in the shape of the Albert-type process, has, however, enabled the editor very successfully to overcome this difficulty, and the facsimile plates produced by it are only second to those of the original papers. In order to enable araneologists to refer to and quote the exact page and plate of the original papers, care has been taken to preserve the old pagination by numbers (within brackets) inserted in the text, and to retain the original numbering of the plates alongside of the numbers referring to the present volume. The matter of the supplement has been worked into the different descriptions, wherever it happened to belong, though still kept separate by means of brackets. With this exception, and the

addition of some short notes (referring chiefly to the dimensions and the occurrence of the species) by Mr. J. H. Emerton, Hentz's papers are thus now reproduced just as they were originally written and published by himself.

With regard to the subject matter of this volume, the author appears to have relied more upon the accuracy of his drawings (which were fully coloured, and said to be artistic and of great beauty) than to his descriptions for making known the spiders he discovered; his descriptions consequently are very meagre and unsatisfactory, while the engraved plates cannot be considered to do much justice to the original drawings, if the latter were, as above mentioned, artistic and beautiful; the figures in the plates, though neat, being for the most part very flat and inartistic. It is not meant by this that their utility in the determination of the spiders delineated is much, if at all, impaired; on the contrary, it will probably be found for the most part sufficiently easy for collectors to determine their captures by reference to the figures given. Every description is followed by some observations on the habits and economy of the spider, showing that the author's great pleasure was not merely in the collecting and depicting, but also in observing, the objects of his pursuit.

The system of classification adopted by Prof. Hentz is now a matter of quite secondary importance; though some (probably most) of the genera which he characterised as new, will stand; and so perhaps will the greater number of his species. The total number—254—of spiders described and figured must be considered small compared with the wide area over which they were collected; the larger number, however, appear to have been found in North Carolina and Alabama, with some few from Massachusetts and Georgia. A little vigorous collecting in those localities will doubtless soon lead to the identification of most, if not of all, of the spiders contained in Prof. Hentz's papers, and, with even less doubt, will greatly add to their number.

In thus speaking of Hentz's labours as an araneologist in the United States, it must not be forgotten that the late Dr. Abbott left behind him, many years ago, an extensive series of beautiful drawings of Georgian and other North American spiders; all of these were named and shortly described by Baron Walckenaer in vols. i. and ii. of his "Insectes Aptères" (Paris, 1837). The British Museum possesses a set of these drawings, but whether this is the original set from which Walckenaer's descriptions were derived, or whether (as we have understood) his descriptions were made from another set given to him by Dr. Abbott, and now existing in one of the public institutions of Paris, appears to be uncertain. At any rate the set of drawings in the British Museum Library bears every appearance of being an original, even if a duplicate, set; and it would perhaps be feasible, as well as worth while, now to publish these drawings as a whole, with the names and descriptions given by Walckenaer. Such a volume, in conjunction with that formed by Hentz's papers, would represent very nearly all that has been done in the past to North American Araneology, and would form a secure foundation and starting-point for the efforts of the future.

It must not be omitted to mention that the two last

<sup>1</sup> This supplement was published, however, latterly, under the editorial care of Mr. S. H. Scudder, in Proc. Bost. Soc. Nat. Hist., xi., pp. 203—212, Pl. 1, 2, 1867.



plates in the present volume are original ones from the skilful pencil of Mr. J. H. Emerton; these suffer in some measure (as do also some of the others) from their production by the Albert-type process; but in point of accurate detail and artistic finish their figures are immeasurably in advance of those engraved from Hentz's drawings. It is to Mr. Emerton, who appears to have resolutely entered upon the field of araneology, and to his great powers of delineation, that the arachnologists of the Old World now look for the thorough working out and illustration of the Spiders of North America.

O. P. C.

### DYEING AND CALICO PRINTING

*Dyeing and Calico Printing, including an Account of the Most Recent Improvements in the Manufacture and Use of Aniline Colours.* By the late Dr. F. Crace-Calvert, F.R.S., F.C.S. Edited by John Stenhouse, LL.D., F.R.S., &c., and Charles Edward Groves, F.C.S. (Manchester: Palmer and Howe; London: Simpkin, Marshall, and Co., 1876)

THE subjects treated of in the volume now before us possess a twofold interest—first as involving questions of pure science in the domain of organic chemistry; and secondly, as being of immense industrial importance to the country. It does not enter into our province to notice the work in its industrial aspect, but we have no hesitation in stating that author and editors have performed their task in a highly creditable manner. From every point of view the work will be found useful, and we can recommend it to the scientific chemist as well as to dyers and calico printers.

The author, who died in 1873, had been occupied up to the time of his death in preparing a treatise on colouring matters other than aniline. The present work has been edited from the author's MSS. with the addition of five chapters, forming a considerable portion of the book, on the coal-tar colours, by the editors.

The mode of treatment pursued is nearly the same for each dye. The natural history and source of the material from which the colour is obtained are first given, then the chemical composition and mode of preparation or manufacture, and finally the method of application to the various fabrics described. The whole subject is profusely illustrated by specimens of dyed and printed fabrics pasted into the book.

The work is appropriately prefaced by an obituary notice of the author. The first chapter treats of colour in general and the action of different forces, chemical agents, &c., on the various colouring matters. We must object to the definition of colour given in this chapter. It is defined as "the impression that the light reflected from a surface makes upon the eye," thus excluding all cases in which colour is caused by *absorption*.

Chapters II. and III. are entirely devoted to madder dyes, and contain, among much valuable chemical information, a description of Prof. Stokes's optical tests for alizarin and purpurin. The method of dyeing in Turkey red and the action of different mordants in madder and garancin printing is clearly explained, and the manufacture of artificial alizarin described. Chapter IV. treats of the

red dyewoods—logwood, sapan, Lima, peach, and Brazil woods; also of safflower and alkanet. Chapters V. and VI. are devoted to indigo—this portion of the subject being described in considerable detail. Chapter VII. contains accounts of cochineal, kermes, gumlac, lac dye, lac lake, and murexide, while Chapter VIII. treats of orchil, cudbear, and litmus. In Chapter IX. some of the important yellow colouring matters are treated of, such as quercitron, fustic, Persian berries, weld, aloes, turmeric, annatto, &c.; while tannin matters form the subject of Chapter X., the most important of these being sumach and catechu. Chapter XI. contains descriptions of the methods employed for testing and determining the commercial value of particular samples of the various dyestuffs. In this chapter will be found described some of the different forms of "colorimeters" which have been devised for estimating the colouring power of dyes.

The portion of the work devoted to the coal-tar colours commencing with Chapter XII. begins with an account of the various bodies which have been found in coal-tar. A list of thirty-eight distinct compounds is given, and many more doubtless exist. The most important substance produced in the dry distillation of coal, so far as the dye manufacturer is concerned, is benzene. The conversion of this substance into aniline is explained, and the manufacture of magenta described, the chapter concluding with an account of safranin and some other aniline reds. Chapter XIII. treats of aniline violets, and blues such as mauve, the Hofmann and methyl-aniline violets, diphenylamine, and Nicholson's blues, &c. In Chapter XIV. we have a description of the greens, aldehyde, iodine, and methyl-aniline and the aniline yellows, phosphine, zinaline, &c. Chapter XV. treats of aniline black and brown, and the concluding chapter is devoted to the phenol, cresol, and naphthalene colours, including picric acid, corallin, aurin, and others. Not the least useful portion of the book will be found the tables at the end, which consist, first of a list of the madder-colouring matters, their formulæ, and reactions, and then a series of tables, which will enable the analyst to distinguish the different colours when fixed on fabrics.

The above imperfect sketch of the present volume will enable our readers to form an idea of the immense number of distinct compounds used in dyeing and calico printing, and the apparently heterogeneous nature of the products, both natural and artificial, called upon to furnish materials for these arts. It must not be forgotten that the enormous development of these industrial arts within the last few years is entirely due to researches undertaken in the first instance without special regard to the commercial aspects of the questions involved—witness the accidental discovery of mauve, the first of the aniline dyes, in the course of an investigation for obtaining quinine by artificial means.

The manufacture of alizarin, the colouring principle of madder, is another triumph of organic chemistry, of which the present generation may justly be proud. It is perhaps not going too far to look for a similar achievement with regard to indigo—in point of fact we may remind our readers that the colour-giving principle of this substance has already been synthesised by the following series of reactions.

A mixture of dried calcium, acetate, and benzoate is

submitted to distillation in order to obtain the ketone known as acetophenone:—

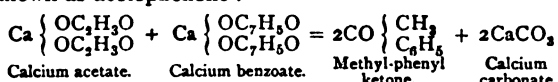

Methyl-phenyl ketone when treated with fuming nitric acid yields two isomeric nitro-derivatives,  $\text{C}_8\text{H}_7(\text{NO}_2)\text{O}$ , one of which when heated with a reducing mixture composed of zinc dust and soda lime is converted into indigo blue:—

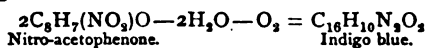

The process above given is at present only valuable from a scientific point of view, since the yield of indigotin is but small. It yet remains to convert this laboratory reaction into a practicable process, in order to do for indigotin what has already been accomplished for alizarin, and thus completely revolutionise another large branch of the colour-producing industry.

R. MELDOLA

### OUR BOOK SHELF

*Scientific Culture.* By Josiah P. Cooke, Jun., Professor of Chemistry and Mineralogy in Harvard College (U.S.). (London: H. S. King and Co., 1876.)

THIS is altogether an admirable address, characterised by real eloquence and by clearness and decision of view as to the place which science ought to occupy in any system of education. Most of Prof. Cooke's audience were teachers by profession, attending Harvard University mainly to become acquainted with the experimental methods of teaching physical science. We commend the address not only to scientific students and teachers of science, but to all who take an interest in education, and to all students who desire a clear statement as to what, in the not distant future, will be regarded as the only liberal education, an education in which science will be allotted a place of at least equal importance with that of literature. What Mr. Cooke's views are on certain matters which have for long been discussed in this journal, may be learned from the following extracts. On the place which Science ought to occupy in education, he says:—

"I must declare my conviction that no educated man can expect to realise his best possibilities of usefulness without a practical knowledge of the methods of experimental science. If he is to be a physician, his whole success will depend on the skill with which he can use these great tools of modern civilisation. If he is to be a lawyer, his advancement will in no small measure be determined by the acuteness with which he can criticise the manner in which the same tools have been used by his own or his opponent's clients. If he is to be a clergyman, he must take sides in the great conflict between theology and science, which is now raging in the world, and unless he wishes to play the part of the doughty knight, Don Quixote, and think he is winning great victories by knocking down the imaginary adversaries which his ignorance has set up, he must try the steel of his adversary's blade. . . ."

"I feel that any system of education is radically defective which does not comprise a sufficient training in the methods of experimental science to make the mass of our educated men familiar with this tool of modern civilisation; so that when, hereafter, new conquests over matter are announced, and great discoveries are proclaimed, they may be able not only to understand but also to criticise the methods by which the assumed results have been reached, and thus be in a position to distinguish between the true and the false. Whether we will

or not, we must live under the direction of this great power of modern society, and the only question is whether we will be its ignorant slave or its intelligent servant."

On the uses to which Universities should be put, Mr. Cooke's opinions are decided:—

"The time has passed when we can afford to limit the work of our higher institutions of learning to teaching knowledge already acquired. Henceforth the investigation of unsolved problems, and the discovery of new truth, should be one of the main objects at our universities, and no cost should be grudged which is required to maintain at them the most active minds in every branch of knowledge which the country can be stimulated to produce.

"I could urge this on the self-interest of the nation as an obvious dictate of political economy. I could say, and say truly, that the culture of science will help us to develop those latent resources of which we are so proud; will enable us to grow two blades of grass where one grew before; to extract a larger per cent. of metal from our ores; to economise our coal, and in general to direct our waiting energies so that they may produce a more abundant pecuniary reward. . . . This is all true, and may be urged properly if higher considerations will not prevail. It is an argument I have used in other places, but I will not use it here; although I gladly acknowledge the Providence which brings at last even material fruits to reward conscientious labour for the advancement of knowledge and the intellectual elevation of mankind. I would rather point to that far greater multitude who have worked in faith for the love of knowledge, and who have ennobled themselves and ennobled their nation, not because they have added to its material prosperity, but because they have made themselves and made their fellows more noble men."

These are but small samples of the many good things contained in Prof. Cooke's address, which we should like to see in the hands of all students. The latter portion of the address students of mineralogy will find of special value.

### LETTERS TO THE EDITOR

[The Editor does not hold himself responsible for opinions expressed by his correspondents. Neither can he undertake to return, or to correspond with the writers of, rejected manuscripts. No notice is taken of anonymous communications.]

On the most Northerly Latitude at which Land and Freshwater Molluscs have hitherto been found

I AM very sorry that I have involuntarily made a mistake in a letter to Mr. Oscar Dickson (*NATURE*, vol. xiii. p. 96), in which it is stated that Dr. Stuxberg had found a *Physa* on the most northerly locality from which land and freshwater molluscs have hitherto been obtained. When I made this statement I had not Middendorff's "Sibirische Reise" with me, and I did not then remember that this celebrated naturalist had found a species of the same genus on the Taimur peninsula north of the seventy-third degree N.L.

A. E. NORDENSKJÖLD

Stockholm, Jan. 29

### Prof. Tyndall on Germs

HAVING commented elsewhere (*Lancet and Brit. Med. Journ.* Feb. 5) upon Prof. Tyndall's recent attempt to establish the truth of the Germ Theory of Disease, my remarks in your columns may be very brief.

Prof. Tyndall tells the public he has uniformly failed to obtain evidences of putrefaction in previously boiled organic infusions protected from contamination by atmospheric particles.

The following investigators have, however, with one or other fluid, been able to obtain such results:—

1. Schwann, *Isis*, 1837; Poggendorff's *Annalen*, 1837.
2. Mantegazza, *Giorn. dell. R. Ist. Lombard.*, t. iii., 1851.
3. Schroeder and Dusch, *Annal. de Chimie*, tome xli., 1854.
4. Schroeder, *Liebig's Annalen*, cix., 1859, and *Chem. News*, vol. v., 1862.

5. Pouchet, *Hétérogénie*, 1859, and *Nouvelles Expériences*, &c., 1864.
6. Pasteur, *Ann. de Chimie*, 1862 (see pp. 60-62).
7. Joly and Musset, *Compt. Rend.*, 1861 and 1862.
8. Jeffries Wyman, *American Journal of Science*, vol. xxxiv., 1862, and vol. xlv., 1867.
9. Victor Meunier, *Compt. Rend.*, tome xli., 1865.
10. Child, *Proceed. of Roy. Soc.*, June 1864, and April 1865.
11. Hughes Bennett, *Ed. Med. Journ.*, 1868.
12. Cantoni, *Gaz. Med. Ital. Lombard.*, tome i., 1868.
13. Bastian, *NATURE*, 1870; *Modes of Origin*, &c., 1871; *The Beginnings of Life*, 1872.
14. Burdon Sanderson, *NATURE*, Jan. 8 and June 1873; *Med. Times and Gaz.*, Oct. 22, 1873.
15. Huizinga, *NATURE*, March 20, 1873, and Pflüger's *Archiv*, vols. vii. and viii.
16. Lankester and Pöde, *Proceed. of Roy. Soc.*, vol. xxi., 1873.
17. Roberts, *Phil. Trans.*, vol. clxiv., 1874.
18. Samuelson, Pflüger's *Archiv*, vol. vii., 1874.
19. Gscheidlen, quoted by Dr. Sanderson in *Academy*, July 10, 1875.

I have set down the names in order of time, and included my own amongst them because those mentioned after me have all confirmed my results with regard to the putrefaction of some fluids in hermetically sealed vessels, from which the air has been expelled by boiling; the very experiments, in fact, which Prof. Tyndall now endeavours to impeach by his own one hundred and thirty-nine failures.

Dr. Burdon Sanderson's well-known corroboration of the accuracy of my results may be here reproduced. He says (*NATURE*, January 8, 1873):—"The accuracy of Dr. Bastian's statement of fact with reference to the particular experiments now under consideration has been publicly questioned. I myself doubted it, and expressed my doubts, if not publicly, at least in conversation. I am content to have established—at all events, to my own satisfaction—that, by following Dr. Bastian's directions, infusions can be prepared which are not deprived by an ebullition of from five to ten minutes of the faculty of undergoing those chemical changes which are characterised by the presence of swarms of Bacteria, and that the development of these organisms can proceed with the greatest activity in hermetically sealed glass vessels, from which almost the whole of the air had been expelled by boiling."

And, if Prof. Tyndall and others wish to know how far these results have since been generally recognised as correct, reference may be made to a review of my work, "Evolution and the Origin of Life," by Dr. Burdon Sanderson, in the *Academy* of July 10, 1875. There, in reference to the confirmation which these experiments had received, and in relation to other work in connection with the question generally by Samuelson and Gscheidlen, Dr. Sanderson writes:—"As regards the trustworthy character of the experiments themselves, it will probably be a sufficient guarantee to most readers that they have been conducted under the immediate supervision of men like Pflüger and Hoppe-Seyler, who occupy the foremost rank as vital physicists. Those who are more especially interested in the subject will best satisfy themselves of the exactitude and completeness with which all the investigations have been carried out by reading for themselves the original papers."

Although Dr. Sanderson thus thoroughly recognises the fact (and knows that others do the same) that many boiled fluids will putrefy in closed vessels from which air has been expelled by boiling, it is well known that he is not willing to regard such facts as the proof of the occurrence of "spontaneous generation." He admits, indeed (*British Medical Journal*, February 13, 1875, p. 201), that I and others have shown that Bacteria in their "ordinary state" are killed by a temperature of about 140° F.; but, instead of accepting "spontaneous generation" as an explanation of the occurrence of living organisms in the vessels above referred to, he pleads in favour of the only other possible explanation, viz., a "latent vitality" in some Bacteria-germs not extinguishable by exposure for ten minutes or so to the influence of boiling water. I felt it my duty to refer to this hypothesis in my address at the Pathological Society last year (*British Medical Journal*, April 10, 1875, p. 473); but, whatever its worth may be, Dr. Sanderson, whose learning and knowledge of the whole question few will dispute, knows that this, or some such hypothesis, alone stands in the way of the acceptance of "spontaneous generation" as a proved reality.

Prof. Tyndall, however, seems to regard this hypothesis as undeserving of notice. He makes no sort of reference to it, and

agrees with me in thinking that Bacteria and their germs are decidedly killed by five minutes' boiling in organic infusions. He still further supports the view held by me, in opposition to that of M. Pasteur, that such a result follows both with alkaline and with acid infusions.

This may seem to many of my readers a rather remarkable finale when compared with Prof. Tyndall's own anticipations; but I feel thoroughly assured that those who understand the subject will see that, in the present stage of the controversy, no other conclusions of value are deducible from his recent experiments. He appears to have completely misapprehended the present state of knowledge on the question; he has uniformly failed to obtain results which are now firmly established; and, as regards the only question which is at present in dispute, he unhesitatingly coincides with me.

Feb. 7

H. CHARLTON BASTIAN

I HAVE read with great interest and pleasure Prof. Tyndall's paper on Germs. But I am troubled on one point. I am sure Prof. Tyndall will not think my difficulties unworthy of attention and removal, though I confess that I am only one of that unpretending class to whose enjoyment and instruction he has devoted so large a share of his valuable time. I am an outsider in scientific research; I delight to follow every investigation which tends to the development of science; but I have not the time, and, if time were available, perhaps I should find that I had not the skill to conduct experiments for myself. I have to trust—and I have seldom found myself misled by trusting—to the recorded experiments of men whose reputation has been established by prolonged and valuable work. I cannot willingly give up this trust, and yet there is one passage in Prof. Tyndall's paper which almost forces me to do so. He tells us that in 139 instances he boiled organic solutions in flasks which were then hermetically sealed, and that in no one case did putrefaction accompanied by Bacteria occur. The inference he draws from this "cloud of witnesses" is that Bacteria cannot be developed in flasks so treated.

Precisely the opposite conclusion appears to have been arrived at by Prof. Burdon Sanderson (*NATURE*, vol. vii. p. 180). He also tested organic fluids in flasks boiled and hermetically sealed, and he found that putrefaction, with swarms of Bacteria, frequently followed. He considered it established that the development of Bacteria could proceed with the greatest activity in hermetically sealed glass vessels previously subjected to boiling heat.

I observe that Prof. Tyndall suggests that such contradictory results may be explained by "errors of preparation or observation." No doubt they may, but it would be a great shock to my scientific faith to be driven to this theory to explain apparent discrepancies between such observers as Professors Tyndall and Sanderson. I cannot help, not only hoping, but believing that there must be some way of reconciling the experiments of two such eminent inquirers, and I should be much perplexed if I were compelled to form an opinion whether the supposed error, if it does exist, ought to be attributed to the one or the other.

Can Prof. Tyndall relieve me from the necessity of believing that either went astray in his work? May there not have been some variations in the conditions which would allow us to accept both sets of experiments as sound? On carefully comparing the two I find that Prof. Tyndall's experiments are far more numerous than those tried by Prof. Sanderson. On the other hand, I find that Prof. Sanderson describes with admirable precision all the details of his work. Perhaps it scarcely fell within the scope of Prof. Tyndall's discourse to descend to such minutiae, but it may very well be that a more particular description, such as that which Prof. Sanderson published, of his treatment of the hermetically-closed flasks—as to the preparation of the solutions, and their specific gravity, the mode and duration of the heating, the method and temperature of the developing treatment, and the like—would supply the means of reconciling his results with the apparently contradictory results arrived at by his brother professor.

When we are considering the conclusions of men of science of the highest calibre I do not think that over much weight should be attached to their preconceived expectations. Still, so far as they go, the avowed opinions of Prof. Sanderson before trying his experiments do tend to reinforce their value. He obtained results which he did not anticipate, and that after taking very careful precautions to exclude the possibility of errors of observation. The errors may have crept in notwithstanding, but it is especially uncomfortable to us outsiders to think

this possible, and I for one cannot believe it until I know whether the conflict between the two professors may not be explained by differences in the conditions under which they worked.

We all know how fully Professor Tyndall's time is occupied, but I hope it is not too much to ask him, in the interests of science and for our instruction, to add to the scientific value of his experiments on hermetically sealed flasks by publishing the details, so as to enable us to compare them with the careful account which Prof. Sanderson gives of his, and to judge whether we ought to trust the one or the other or—what would be the more agreeable, and I cannot help thinking the more likely, consequence—to trust them both in this as we have done in so many previous investigations.

INQUIRER

### The University of London and School Examinations

HAVING given some assistance to the preparation of the Report referred to in your leader of the 3rd inst., I shall be glad if you will allow me to correct the somewhat erroneous impression which I fear your article is likely to produce.

It was with some surprise that I found the Report of the Sub-committee of the Convocation of the University of London forming the subject of an editorial notice, seeing that, as yet, it is private matter printed only for circulation among the members of the University. At the recent meeting of Convocation I endeavoured to explain the position which the Annual Committee occupied with respect to this Report; and from the absence of all reference to the subject in the notices of the meeting which appeared in the daily papers, I had reason to think that I had succeeded in showing why the matter was not yet ripe for publication. In answer therefore to your query: "But is it easy to speak with reasonable seriousness of an attitude like that which the Annual Committee has adopted?" I need now only state, with respect to the Report, that it is not yet adopted by Convocation nor by the Annual Committee.

But I am inclined to think that you have lacked the opportunity of carefully studying the proposals of the Sub-Committee, or you would not have found it necessary to speak of them in terms of "irony" or "levity."

Your article suggests that the University of London has been asked to adopt a scheme for the examination of schools with no higher motive than that of "entangling schoolboys in its meshes," and of withdrawing them from the influence of the other Universities; and to establish this position you quote a passage from one of the paragraphs of the Report, in which, *inter alia*, it is stated that unless the University of London is prepared to take some part in the examination of schools "*the number of candidates for the London examinations will sensibly decrease*," which last words you have printed in italics, although in the Report itself no such prominence is given to them. It is quite true that the graduates of Burlington Gardens consider that the influence which their examinations exert on education is, on the whole, beneficial. They are consequently desirous that that influence should if possible be extended, and would view with regret, as the Report suggests, any cause that might tend to dissociate from the University of London those schools which hitherto had acted as feeders to it. But is it quite fair to characterise this honest endeavour to improve school-teaching as an attempt to *entangle schoolboys within the meshes of the University?*

Your article further states that the Annual Committee have not a word to say as to the efficiency of the work in which the ancient Universities have for many years been successfully engaged. Indeed they have; but it is not likely to be found in the Report of the Sub-committee. The several weighty reasons which have induced Convocation to request the Senate to undertake the examination and inspection of schools have been repeatedly and fully discussed by Convocation and its Committee; and the result of these discussions has been the appointment of a Sub-committee for the purpose of suggesting what might seem to them the best and most comprehensive system of examination. Nothing would be easier, in reply to your article, than to show how the proposals embodied in the Report of the Sub-committee, if ultimately adopted by the Senate, would tend to the improvement of secondary education, and would entitle the University of London to receive that "debt of gratitude" which you say "the nation would owe it," if it undertook in good faith to offer to schools a better system of examination than they at present possess. But I am not at liberty to publish the contents of a Report which is at present nothing more than a

series of recommendations which the Annual Committee have accepted as the basis of conference between Convocation and the Senate. I may, however, be permitted to refer to one important feature in that Report which I might have expected would have gained for it the support of a scientific journal such as NATURE—that in the examinations for certificates the same weight is given to Science as to Languages and Mathematics. If the University of London should determine to undertake the new duties to which the Report refers, many schools would be enabled to choose between two systems of examination differing in many essential particulars from each other; but what is more important is the fact that the scheme of the University of London would cover a far wider range of schools than is included within that of the Joint-Board of Oxford and Cambridge; and that those schools which stand most in need of careful inspection would, for the first time, have the opportunity of being affiliated to a University.

In conclusion, permit me to add, that so far from desiring to compete with the older Universities, the Senate of the University of London expressed a strong desire to co-operate with Oxford and Cambridge in their great educational work; and it was not till after the Joint-Board had given reasons why they were unable to act in conjunction with London, that independent action was even suggested.

PHILIP MAGNUS

Feb. 5

WILL you spare me a few lines of space to reply to your first article of Thursday last? A portion of that article was directed against examinations in general, and would apply to the Oxford and Cambridge scheme, as well as to that put forward by our Sub-committee; far more so, in fact, as an important part of our scheme relates to inspection of methods of teaching, school-books, &c., which is not included in the conjoint scheme of the older Universities. Our object is to improve the education given in schools other than primary; and if the author of your article will suggest any method besides examination and inspection by which this may be effected, we will gladly give it our earnest consideration.

Our Report was drawn up for the Annual Committee of Convocation, and not for the outside world. It was not necessary for us to inform Convocation that the University of London has a tradition and principles of its own, principles distinct from, and sometimes antagonistic to those of Oxford and Cambridge. Among these traditional principles are, firstly, that all education ought to be *many-sided*, and not solely either mathematical or classical, and secondly, that Science ought to hold a place co-ordinate with Language and Mathematics. It was not necessary for us to point out to Convocation that if the number of candidates for the London examination were sensibly to decrease, these two principles would have a diminished influence upon the education of the country, for there is in Convocation a strong attachment to these principles, and a vivid appreciation of the *raison d'être* of the University. Neither was it necessary for us to state what we thought the deficiencies of the Oxford and Cambridge Local Examinations. It was upon the ground that these examinations tended to become too much "an end instead of a means" that we were commissioned by Convocation to draw up a scheme, under which we should rather inquire whether the schools have done well what they profess to have done than dictate to them what course of studies they should pursue. A careful comparison of our scheme with that of the Conjoint Board will make the divergence of aim apparent.

And now we are advised to admit that we have no independent mission as a University, and to stand by to see whether or not the older Universities will do our work, on the ground that it would be a "more dignified course." Dignity and usefulness often appear to stand in inverse relation one to the other. The University does not exist for the sake of being dignified, but of doing work; and the scheme we have elaborated will, if carried out, do work not even proposed by the Conjoint Board. That Board is intended to deal only with such schools for boys as have a governing body, whereas our scheme includes "private adventure" schools both for boys and for girls.

Finally, I may be allowed to express my surprise that NATURE should desire the one University which gives Science its true position to stand aside, and should characterise our wish to assert and to spread its distinctive principles as "cynical."

Hampstead, Feb. 5

H. A. NESBITT

[THE Convocation of the University of London is a very large body, and its proceedings, are reported in the daily papers. A

document which was communicated to every member of that body, and the consideration of which formed part of its proceedings, can only by a legal fiction be described as confidential. But the plea that the document was confidential practically abandons the defence of it. A really statesmanlike paper on a matter which affects all the higher grade schools of the country would gain rather than lose by publicity.

The course which Convocation has under consideration has no doubt, as our correspondents point out, much to be said in its favour. But the reason actually put forward in the preamble of the Report as a ground for taking action, is from the point of view of public policy simply indefensible. It would be appropriate enough if the Report had been addressed by a Board of Directors to the shareholders of a Limited Liability Company, because in the fashion characteristic of such documents it treated the matter in hand from the strictly business point of view of the "concern." It is this attitude which we described as cynical. And we must repeat that it is not in our opinion decorous that a matter gravely affecting the higher education of the country should be treated simply as a question of the falling off of examiners at one particular centre of examination. If it is not the duty of a University to be dignified, it is at least the duty of its advisers to be statesmanlike; and if we may have done injustice to the real desires of the framers of the Report, they have only their own inadequate expression of them to blame.—[Ed.]

Public Analysts

In your last week's issue your correspondent, Mr. M. Williams, writes in such terms as would lead your readers to suppose that much less has been done in the matter of butter analysis than is really the case.

I have not the letter before me at this moment, and therefore speak from memory, but I believe that your readers are led to understand that no analyses of pure butter and of pure butter mixed with known quantities of foreign fats have been published. In this he is mistaken, for in a little work published in 1874, the details of eleven experiments upon butters known to be pure are given. The samples were purchased from outlying country farms in the Isle of Wight, and the results of the analyses fairly prove the constancy of the fixed fatty acids in butter.

It is also shown that all foreign fats likely to be used as adulterants are constant in their composition, and that they yield a much larger percentage of fixed acids than does butter; the range of difference being wide enough to offer a practical basis upon which to found accurate estimations of foreign fats in factitious butters. Many admixtures were made, and the published results of the analyses prove the practicability of the method employed. Your correspondent hints that no one dares to undertake the analysis of mixtures of known constitution. I venture to state that if the necessary provisions could be made against concoctions chemically prepared, and so as to admit of commercial admixtures only, such as would be likely to be made use of by fraudulent butter factors, there would be no difficulty in getting half-a-dozen or more analysts ready to take up the gauntlet.

ARTHUR ANGELL

Southampton, Feb. 7

Large Meteors

A LARGE fireball was seen here this evening at about 7.35 P.M. It rolled slowly across the southern sky, and its path was slightly descending from left to right. The observed part of its course was from  $\gamma$  Orionis to a few degrees below  $\alpha$  Ceti. There was no train, but the moon was shining brightly at the time, and may have overpowered any faint appendage of this sort. It was many times brighter than Venus (then near setting), and estimated to equal one-fifth the moon's apparent diameter. The globular form of the nucleus was very evident.

A meteor with very slow motion and a short course was observed on Feb. 2, 8.31 P.M., traversing a space between  $\delta$  Leonis and Cor Caroli, or just above Coma Berenicia. It was as bright as Mars. Radiant point probably near  $\gamma$  Leonis, and very possibly a member of the same system as the fireball described above, which also appears to have been directed from Leo.

A bright meteor was also seen here on Jan. 31, 9.13 P.M. It fell almost vertically in S.S.W. from the Hyades, and must have been quite equal to Venus. I saw it in a region of the sky covered with thin clouds sufficiently dense to obscure the stars. Radiant point probably just north of  $\alpha$  Tauri.

WILLIAM F. DENNING

The Flame of Common Salt

I SEE that it is sometimes permitted to ask questions in NATURE for information. If I might be allowed to do so, I would ask why common salt gives a blue light when cast into a fire of coal, and a yellow light when burned on the wick of a spirit lamp? The books I have consulted do not give the reason of this.

E. G.

OUR ASTRONOMICAL COLUMN

THE BINARY STAR  $\eta$  CASSIOPEÆ.—Dr. Doberck, of Col. Cooper's Observatory, Markree Castle, has communicated to the Royal Irish Academy the results of a complete discussion of the elements of this binary from the measures to 1875. Though he does not consider the exactness of the orbit to be great, partly owing to the observations being rather unfavourably placed, and partly to uncertainty in the observed distances, the agreement with observation is pretty close, and it appears likely that preference may be given to his elements, over those lately given by Dr. Duner, if the latter are correctly printed. Dr. Doberck's orbit is as follows, being the result of a sixth approximation:—

Peri-astron passage ... ..	1909 <sup>o</sup> 24
Node ... ..	39 <sup>o</sup> 57'
Peri-astron from node ... ..	223 <sup>o</sup> 20'
Inclination ... ..	53 <sup>o</sup> 50'
Excentricity ... ..	0.5763
Semi-axis major ... ..	9 <sup>o</sup> 83
Period of revolution ... ..	222 <sup>o</sup> 435 years.

Combining these values for the semi-axis and length of revolution, with Mr. Otto Struve's parallax ( $0''\cdot154$ ), we have the following figures:—

Semi-axis major ... ..	63.83 earth mean distances.
Mass of system ... ..	5.25 sun-masses.

The parallax corresponds to a distance of 1,340,000 times the mean distance of the earth from the sun. The uncertainty attending the measures of distance of the components and the amount of probable error of Mr. O. Struve's value of the parallax, of course allows only of the above figures being regarded as first rough approximations. The semi-axis of the orbit of  $\eta$  Cassiopeæ, it will be seen, results more than twice as great as that of the orbit of Neptune.

The star will doubtless be frequently measured in the present approach to the peri-astron, and every additional five years' observations must be of service in the improvement of the elements.

Dr. Doberck promises an investigation of the orbit of the close binary  $\omega$  Leonis, no one of the orbits of which star, so far published, represents recent measures. Notwithstanding the case is a troublesome one for calculation, a very fair approximation to the elements should now be practicable.

THE RUGBY (TEMPLE OBSERVATORY) CATALOGUE OF DOUBLE STARS.—Following the excellent plan pursued by Mr. J. Gurney Barclay in the speedy publication of the Leyton measures of double-stars, made by Mr. Talmage with the fine ten-inch refractor of that observatory, Mr. J. M. Wilson and Mr. G. M. Seabroke have given to astronomers (Memoirs, R.A.S., vol. xlii.) a catalogue of micrometrical measures of these objects made at the Temple Observatory of Rugby School during the years 1871-74, with the 8½-inch Alvan Clark refractor, constructed for the late Rev. W. R. Dawes, used by him in his later measures, and now the principal instrument of the Rugby establishment. Working in this interesting branch of astronomy, in co-operation with Mr. E. Crossley's Observatory near Halifax, Rugby has occupied itself upon the even-numbered stars of Struve's Catalogue below 50° N. declination, Mr. Crossley, with Mr. Gledhill, having employed his 9½-inch refractor upon other stars.

The Dawes-refractor is well spoken of by the Rugby

observers in connection with the work in question, and the measures now published not only confirm this favourable opinion of the instrument, but bear inherent testimony to the care and patience expended on the observations, and will doubtless be received as an important and valuable contribution to double-star astronomy, and especially by those who are occupied with similar observations, or the investigation of the orbits of the binary systems. Amongst the more interesting of the revolving stars, the Catalogue has measures of  $\eta$  Cassiopeæ,  $\beta$  Andromedæ,  $\alpha$  Geminorum,  $\zeta$  Cancri,  $\omega$  Leonis (which difficult object was just divided at the end of March 1873),  $\xi$  Ursæ Majoris,  $\gamma$  Virginis,  $\xi$  Bootis,  $\eta$  Coronæ,  $\Sigma$  1938,  $\zeta$  Herculis,  $\gamma$  Ophiuchi,  $\Sigma$  3062, &c. The interesting, though difficult binary  $\Sigma$  518 (Eridani), is probably within the power of such an instrument, but does not appear in the Catalogue; it may be suggested that it is not too late to examine this object in the present season, the actual angle may probably be found very considerably in advance of that obtained by Prof. Winnecke in 1864, and a first approximation to the form of the orbit may soon be practicable.

**JUPITER'S SATELLITES.**—If we take a mean of the measures of the diameters of the satellites by Struve at Dorpat, and by Engelmann at Leipsic, we shall have for apparent diameters at the mean distance of the primary :—

I. ... 1''·048 II. ... 0''·911 ... III. 1''·513 ... IV. 1''·278  
and with a solar parallax of 8''·875, the true diameters in English miles will be :—

I. ... 2,435 ... II. ... 2,115 ... III. 3,515 ... IV. 2,970

The angular diameters at the centre of Jupiter, are :—

I. ... 31'·4 II. ... 17'·1 III. ... 17'·8 IV. ... 8'·6

and the mean distances from the centre of Jupiter :—

I. ...	266,700 miles
II. ...	424,300 "
III. ...	676,800 "
IV. ...	1,190,400 "

The diameter of the planet's equator is assumed to be 88,200 miles, as lately given in this column.

#### THE DRAINAGE OF THE ZUYDER ZEE.

THE Dutch are a people who in many respects command the respect of the world. Their little country possesses comparatively few natural resources, and yet they have made so much of it, and they have been compelled to cultivate the virtues of frugality and industry to such an extent, that the people as a whole are probably better off than those of any other country in the world. Small as the country is, it is only by the exercise of great skill and constant watchfulness that they are able to prevent its being overwhelmed by the German Ocean. In this unfortunately they have not always been successful. Over and over again has the sea burst in upon them, laying waste their dearly-loved country, and sweeping away thousands of the inhabitants. It has only been after many severe lessons that they have learned how to keep the invader back. And within recent years they themselves have taken the offensive, and determined to drive out old Neptune from lands which he has possessed for centuries. Even in the seventeenth and eighteenth centuries they succeeded in draining many small areas of land, and during the present century many marshes and lakes have been brought under cultivation, including Lake Haarlem, upwards of 40,000 acres in extent. In this way about 350 square miles of land, mostly devoted to pasture, have been reclaimed, and that entirely by means of windmills.

Now, however, that the applications of steam-power have reached such perfection, this enterprising people have determined upon an enterprise much more gigantic than

any they have hitherto attempted,—nothing less than the drainage of the Zuyder Zee. Until the end of the thirteenth century the area now occupied by that arm of the ocean seems to have been mostly dry land, with a lake in the centre, which by means of a river drained into the German Ocean. At the time mentioned, however, in 1282 according to some authorities, the sea broke through what is now the Strait of Helder, and converted the dry land into a gulf.

For many years the drainage of the Zuyder Zee has occupied the attention of the Dutch Government and of engineers, but it is only since the improvements in the application of steam that the idea has been seriously entertained. At last a scheme has been adopted, after many years' careful research and consideration, for the details of which we are indebted to the French journal *L'Explorateur*.

As early as 1865 a Dutch Credit Foncier Association took up the scheme at the suggestion of Mr. Rochussen, an eminent statesman, and employed two engineers, M. Beijerinck, who drained the Haarlem Lake, and M. Stieltjes. These reported on the practicability of draining the southern, the shallowest and most fertile, half of the inland sea. Soundings were made, and numerous specimens of the bottom brought up, and in short a thorough investigation made from a geological and agronomic point of view. The result of these investigations was most favourable, and the specimens submitted to the analysis of a distinguished agricultural chemist, M. van Bemmelen, having been found to consist of alluvial clay or loam of the first quality and of great depth, over an extent of four-fifths of the bottom of the sea, the Society entered into negotiations with the Government. A Government Commission was appointed to consider the whole question from an economic and scientific point of view, and after an investigation lasting about two years, gave in their report in April, 1868. This report was in favour of granting a concession to the Credit Foncier, whenever that company could present a definite plan that would obviate all existing objections. The Society, after further consideration, requested the Government to delegate a commission of specialists to report further on the scheme, taking into consideration all the interests concerned, and to decide upon the plan best adapted to carry the scheme into execution. After three years thorough consideration the Commission gave in a voluminous report in April 1873, which declared that the project from an engineering point of view was practicable; that the clearing of the new lands would be a difficult and very expensive enterprise, but that the experience acquired and the progress of science would furnish the means of overcoming these difficulties, and of making the enterprise a benefit to the country.

The drainage will be effected in that part of the gulf lying between the provinces of Guelderland, Utrecht, and North Holland, over an extent of 195,300 hectares (about 740 square miles, nearly equal to the area of Surrey, and about 100 miles larger than the Dutch province of Zeeland), by means of a principal dike or embankment, of 40 kilometres in length, 50 metres broad at the base, and raised 5 metres above the ordinary tides, to be constructed from the left bank of the mouth of the Yssel to the island of Urk, and from hence to the town of Enkhuizen in the province of North Holland. The inclosed area will be divided into squares, and numerous pumping steam-engines will then be set to work, having a collective force of 9,400-horse power. The Commission estimates that the work will be entirely accomplished in sixteen years, and that it will cost a sum of 10,000,000*l.* not including the interest of the capital employed; or 1,600,000*l.* for preparatory works, provisional circular canals, &c., about 2,760,000*l.* for the construction of the dike, and the rest for the purchase of engines, the drainage proper, and the construction of reservoirs, internal canals, roads, railway



lines, and works preparatory to bringing the new lands under culture.

The interest on the above sum will raise it to 13,400,000*l.*, but one-fourth of this will be granted as a subsidy by government, which will be amply compensated by the comparatively enormous addition to its small territory.

Of the 473,000 acres to be drained, four-fifths, as we have said, are of great value, composed as they are of a bed of more than a metre thick of the most fertile mud deposited for centuries by the Yssel and other rivers of which the Zuyder Zee is the receptacle. Only one-fifth consists of land of less value and of sands which will be useful in constructing the base of the dike, or to establish large reservoirs, indispensable in all drainage work, for the reception of the waters until they can be conveyed to the sea. Deduction being made for the land absorbed by these works, by canals, dikes, roads, &c. &c., there will remain upwards of 400,000 acres suitable for culture, and the selling value of which ought considerably to exceed the expenses of the enterprise. Every one must wish that this bold and really beneficent scheme may be carried out with complete success.

#### THE BIRDS OF NORTH-EASTERN AFRICA<sup>1</sup>

BARON THEODOR VON HEUGLIN is well known as one of the most active and successful of the travellers and naturalists of Germany—one who may fairly rank with the Wallaces and Bates of our own country—as regards the extent of his researches. No man living has devoted more time and toil to the investigation of the Fauna of North-eastern Africa, and as regards the classes of birds and mammals, no man living has a better acquaintance with them. Twelve years passed on the coasts and islands of the Red Sea, in the marshes and jungles of the White Nile, and in the Highlands of Abyssinia, during which time constant attention was devoted to the observation and collection of animals have given Herr von Heuglin unrivalled opportunities for amassing this knowledge, to which his skill as an artist has contributed additional facilities. Soon after returning from his last journey in 1865, Herr von Heuglin planned a general work on the Ornithology of North-eastern Africa to embrace all the notes and observations collected during his different excursions, together with the information acquired by the study of specimens from these countries already existing in the continental museums. In 1869, the first part of the present work was issued, but its large extent hindered its progress, and the author was called away to join the German Expeditions to Nova Zembla and the extreme north, to which he was attached as naturalist. It was not, therefore, until the close of last year, or, we believe we may say until the beginning of the present year, that the concluding part of the Ornithology of North-eastern Africa was issued from the press. Completed, it now forms four volumes, illustrated by fifty-one coloured plates and a map of the region of which it treats, and is by far the most perfect work on the subject hitherto published. Prior to the completion of the present work Rüppell's Atlas, and other publications were, so far as regards Nubia and Abyssinia, the only works of reference, whilst of the district of the White Nile so fully explored by Von Heuglin, very little was known except from fragmentary notices. In the present extended work the ornithology of the whole of these countries, together with that of Egypt, the Red Sea, and Northern Somali-land, are treated of together. The sum of species of birds is thus raised to a high figure, no less than 948, of which upwards of 200 are entirely confined to North-eastern Africa. European species are likewise numerous in these countries,

<sup>1</sup> "Ornithologie Nordost-Afrika's, der Nilquellen und Küsten-Gebiete, des Rothen Meeres und des nördlichen Somal-Landes," von M. Th. von Heuglin. In vier Theilen. (Cassel: Fischer, 1869-1874.)

Northern Africa being, as is well known, the favoured haunt of our summer migrants during the winter season. Upwards of 300 European birds thus come to be included in Herr von Heuglin's list. The plan of our author's work is good, though it seems to be rather adapted for the home student than for the field-naturalist, neither family nor generic characters being included. But we observe with pleasure that specific diagnoses are given in Latin to all except the best known species, which, after the contumely that certain imperfectly educated naturalists have recently thought fit to bestow upon that classical tongue, is worthy of all praise. The references to former authors are also numerous, and, so far as we have been able to test them, more accurate than is too often, unfortunately, the case in works of this kind. But the great feature of the book are the observations on the habits and localities extracted from the note-books of the unwearied author. These are much more numerous, and better put together than in almost any other work on foreign ornithology with which we are acquainted. Errors and omissions there are no doubt, and must be, in a work of this magnitude, as indeed is sufficiently evident by the many pages of additions and corrections annexed to the fourth volume, but Herr von Heuglin has spared no trouble to bring his Ornithology of North-eastern Africa up to date, and his volumes will long remain a standard work of reference upon the birds of these districts, which are now attracting so much attention in civilised Europe. P. L. S.

#### FERTILISATION OF FLOWERS BY INSECTS<sup>1</sup> XIII.

*Additional Alpine Flowers adapted to Cross-fertilisation by Lepidoptera.*

THE same relation which I have shown to exist between *Daphne Mezereum* and *striata*, *Primula officinalis* and *villosa*, *Rhinanthus crista-galli* and *alpinus* (NATURE, vol. xi. p. 110), exists also between *Viola tricolor*<sup>2</sup> and *calcarata*, the former inhabiting the plain and the lower mountainous localities, and being adapted to cross-fertilisation by bees; the latter, on the contrary, inhabiting the higher Alpine regions, and being adapted to fertilisation by butterflies.

*Viola calcarata* is found in the Strela pass towards Davos (2,300 metres above the sea-level), and in the rocky slopes of Piz Umbrail towards Quarta Cantoniera (2,600-2,700 m.) in such plenty as to appear from some distance like a blue carpet of flowers. In the latter locality, July 15, 1875, I saw these flowers assiduously visited by different butterflies, of which I caught two specimens of *Colias phicomona*, and three *Erebia laprona* E. (manto, W. V.) The modifications of structure by which the flowers of *V. calcarata* (Fig. 82-85) differ from those of *V. tricolor* (Fig. 15-22, NATURE, vol. ix., p. 46), besides their eminent conspicuousness, so frequently found in Alpine flowers, are such as prevent Diptera and probably also Apidæ from sucking the honey, whereas butterflies, for which alone the honey is reserved, cannot suck it without effecting cross-fertilisation. For the spur, which generally is only 3-4 mm. long in *V. tricolor*, exceeds in this species 10 mm. in length, its width being only 1 mm. in the vertical, and scarcely half a millimetre in the horizontal direction; and the stigmatic knob, provided with a labiated appendage, as in the large-flowered form of *V. tricolor*, lies so closely pressed against the under lip, that no proboscis of any butterfly can enter the spur without grazing the stigmatic lip. The pollen-grains, when they fall out of the anthers, collect in the hairs which clothe the furrow of the under lip (see Fig. 85), and no proboscis of a butterfly can be inserted into the spur without being smeared with pollen-grains, which, in the flower next

<sup>1</sup> Continued from vol. xiii., p. 212.

<sup>2</sup> See H. Müller, "Die Befruchtung der Blumen durch Insecten" Leipzig, 1873, p. 145, and NATURE, vol. ix. p. 44.

visited, will be partly rubbed off on to the lip of the stigmatic cavity (Fig. 85). All the other contrivances of the flower are nearly the same as in the large-flowered form of *V. tricolor*, described in detail in a previous article (NATURE, vol. ix. p. 47).

It may be worth mentioning that in the lower Alpine localities (for instance, near Valcava, 1,500 m., and near St. Gertrud, Sulden, 1,800 to 1,900 m. above the sea-level) I found a variety of *V. tricolor*, which, as well in the conspicuousness of its flowers as with regard to its fertilisers, is intermediate between the large flowered form of *V. tricolor* (NATURE, vol. ix. p. 46, Fig. 15) and *V. calcarata* (Fig. 82). The flowers of this variety, which is called *alpestris*, are 25-30 mm. long, and 18-22 mm. broad; the three lower petals are yellow near their base, as in our *tricolor* and *calcarata*, marked with black streaks converging towards the entrance of the flower; the two upper petals are very variable in colour, white, or bluish, or yellow, with a large bluish margin. The spur is also

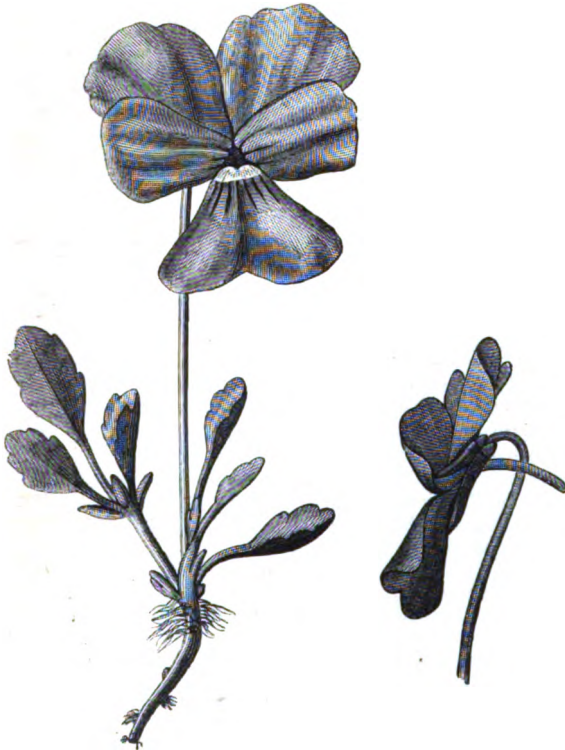

FIG. 82.

FIG. 83.

FIG. 82-85.—*Viola calcarata*.<sup>1</sup> FIG. 82.—Whole plant, showing a flower in front, natural size.  
FIG. 83.—The same flower, laterally viewed, showing the long slender spur.

variable in length, but on an average remarkably longer than in our *V. tricolor*. I found the flowers of this variety frequently visited by butterflies (*Polyommatus virgaurea*, L., *P. hippothoe*, L., var. *eurybia*, Ochs., ♂, *Lycæna semiargus*, Rott., *Argynnis pales*, *Hesperia serratula*, Ramb.), but only once by a humble bee (*Bombus terrestris*, L., ♀, sucking), whilst our *V. tricolor* is generally

<sup>1</sup> a anthers; a<sup>1</sup>, upper anther; a<sup>2</sup>, insertion of the removed lateral stamen; a<sup>3</sup>, lower anther; ap<sup>1</sup>, appendage of the upper sepal; b, beard, i.e., tuft of hairs; cb, the lateral surface of the stigmatic knob; c<sup>1</sup>, c<sup>2</sup>, orange-coloured appendages of the connectives; f<sup>1</sup>, f<sup>2</sup>, filaments; k, knob of the stigma; l, lip, labiate appendage of the stigmatic opening; n, nectary, i.e., honey-secreting appendage of the lower filaments; ov, ovary; p, petals; p<sup>1</sup>, lower, p<sup>2</sup>, lateral, p<sup>3</sup>, upper petal; po, pollen-collecting hairs; pr, protective hairs (Sprenkel's "Saftdecke"); s, sepals; s<sup>1</sup>, upper sepal (with the appendage ap<sup>2</sup>); s<sup>2</sup>, lateral sepal; sp, the uppermost part of the spur, containing the honey; st, stigmatic cavity; str, streaks converging towards the entrance of the flower (Sprenkel's "Saftmal"); sty, style; y, yellow part of the lower petal. (The rest of the corolla is blue.)

visited by *Apida*, more rarely by butterflies, and *V. calcarata* exclusively by butterflies. Thus *Viola tricolor*, var. *alpestris* shows us one of the steps by which the common form of this species may have been gradually modified into *V. calcarata*.

Another Alpine flower, remarkable from its conspicuousness and adapted to Lepidoptera, is *Lilium bulbiferum* (Fig. 86-88), which I found on stony slopes of the Schanfick valley, near Chur, in the Spoel Valley, near Zernetz, and, somewhat more frequently, in shelving meadows of the valley of Sulden, beneath the Ortler (1,700-1,800 m. above the sea-level). Although in most points of its structure agreeing with *Lilium Martagon*, described in my article X. (NATURE, vol. xii. p. 50), this flower may be of some interest, because it shows by what slight modifications a sphingophilous species may be adapted to diurnal Lepidoptera, or *vice versa*. The number and arrangement of the parts of the flower and the structure of the nectary (Figs. 87, 88) are, indeed, the same in *L. bulbiferum* as in *L. Martagon*. That, nevertheless, the latter is cross-fertilised by Sphingidæ, the former by diurnal Lepidoptera, is proved by the following differences:—

1. The flowers of *L. Martagon*, being dark reddish brown, and in the daytime but faintly scented, are only slightly attractive to day-fliers, whilst during the evening

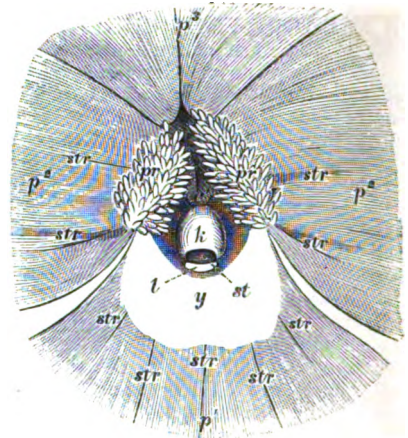

FIG. 84.—Entrance to the flower: seven times natural size.

they emit a very attractive sweet odour. *L. bulbiferum*, on the contrary, by the unusual size of its flowers, with a diameter exceeding 100 mm., and by their colour appearing very splendidly red in the sunshine, is most conspicuous in the daytime, even from a great distance; but being but slightly scented, is incapable of efficaciously attracting night-fliers either by its odour or its colour.

2. The flowers of *L. Martagon* are generally bent downwards, and its sepals and petals reflexed so far as to place the entrances to its nectaries in a nearly horizontal direction, its stamens and pistils projecting downwards, with only their ends slightly bent upwards (Fig. 63, NATURE, vol. xii. p. 50). Thus it affords no landing-place, and offers its honey exclusively to such insects as are capable of inserting a long slender proboscis into the flowers, while they hover in the air by very rapid movements of their wings. *L. bulbiferum*, on the other hand, having its flowers obliquely upright, and offering to their visitors a commodious standing-place on the lowermost petals or sepals, the honey of the lowermost nectaries is accessible to every insect the proboscis of which is long and slender enough to be inserted into the honey-secreting channel.

3. Cross-fertilisation by visiting Sphingidæ is effected in *Lilium Martagon* by the pistil overlapping the anthers, and therefore being first touched by the legs and underside of the visitors, and thus smeared with the pollen of flowers previously visited. In *L. bulbiferum* cross-ferti-

lisation would be prevented if the sepals and petals were as much reflexed as they are in *L. Martagon*; for butterflies would sit down on them and suck the honey out of the channels at their base, without touching the stigma or anthers. But in this species only the ends of the sepals

and petals are spread apart, whilst, as far as the sexual organs extend, the leaves of the perianth diverge but so slightly that a butterfly, when inserting its proboscis into the nectary, can scarcely avoid touching the stigma and anthers; and, the pistil being situated nearest to the

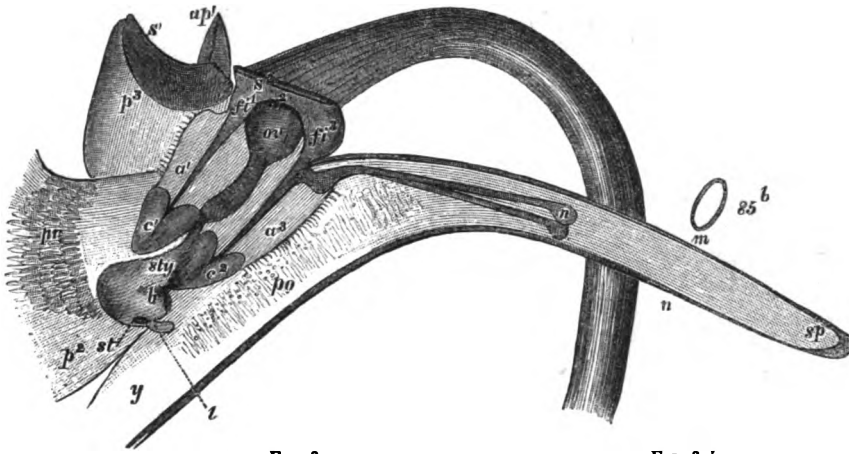

FIG. 85.

FIG. 85b.

FIG. 85.—Lateral view of the flower after the half of its sepals and petals and one of the two lateral anthers have been removed and the underlip somewhat depressed: seven times natural size. FIG. 85b.—Transverse section of the spur, behind the line *m n*, Fig. 85.

lowermost petals and sepals on which the butterflies alight and suck, the stigma here also will be commonly first touched and thus fertilised by pollen-grains of flowers previously visited.

Although, by the contrivances now described *Lilium bulbiferum*, from its very conspicuous flowers, is very likely to be cross-fertilised by butterflies in sunny weather, still in rainy periods many flowers may wither without having received any visit from a butterfly. Hence the possibility of self-fertilisation appears to be indispensable both to *L. bulbiferum* and to *L. Martagon*. In both the anthers

and stigma are simultaneously developed to maturity, and are often found in contact with each other; and self-fertilisation may thus be effected in case cross-fertilisation by visiting Lepidoptera is wanting.

4. Direct observation of the visitors proves that *L. Martagon* is really fertilised by Sphingidæ, for instance by *Macroglossa stellatarum*, as observed by myself (see NATURE, vol. xii. p. 50), and by *Sphinx euphorbia*, as observed by Federico Delpino; and that *L. bulbiferum* is really fertilised by butterflies, for instance by *Polyommatus virgaurea*, L., *P. hippothoe*, L., var. *eurybia*, Ochs.,

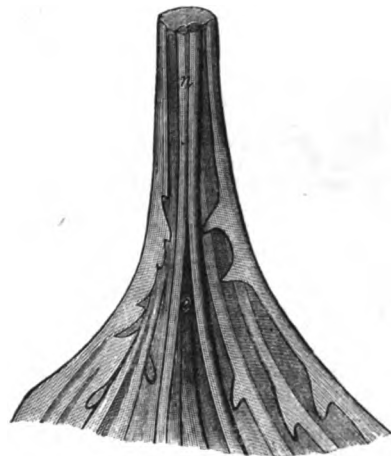
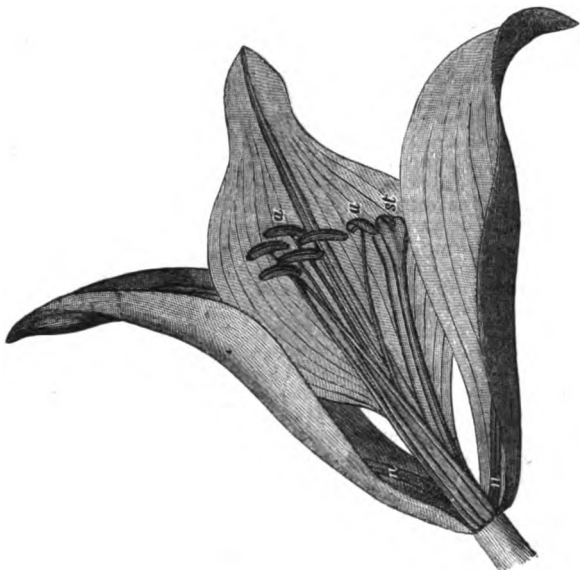

FIG. 86-88—*Lilium bulbiferum*. FIG. 86.—Lateral view of the flower after the half of the perianth has been removed; natural size. *a*, anthers; *st*, stigma; *n*, nectary.

FIG. 87.—Basal portion of one of the leaves of the perianth. *a*, entrance into the nectary; *n*, nectary: magnified twice.

and *Argynnis aglaia*, L., all of which (July 20, 1875) I found repeatedly in the flowers, not only sucking the honey, but also resting, displaying their wings in the sunshine, and sometimes a male of *Polyommatus virgaurea*, L., sitting by the side of a female of the same species.

It is a striking fact that all these species of butterflies are of nearly the same splendidly red colour as the flowers they visit. I do not know whether this fondness has been effected by natural selection, agreement of colour

† Written to me in a letter of May 1875.

with the flower they sit upon making the butterflies invisible to their pursuers, or if merely the same predilection for a certain colour which has ruled the sexual selection of these butterflies, and by this influenced the colour of their wings, impels them also preferably to visit flowers of their favourite colour; but, from many analogous observations to be published on another occasion, I am strongly inclined to believe that the agreement of colour between the flowers of *L. bulbiferum* and their visitors is not a merely fortuitous one.

Most of the differences between the flowers of *L. Martagon* and *bulbiferum* may be intelligible from the pre-



FIG. 68.—Transverse section through the base of one of the leaves of the perianth; seven times natural size. *h*, honey filling up the furrow from which it is secreted; *m*, margins covering the furrow; *ha*, hairs closing the slit between these margins.

ceding explanation;—still the question remains: What intermediate contrivances are imaginable by which the transformation of a sphingophilous species of *Lilium* into another one adapted to butterflies could be effected? In this respect it is remarkable that the flowers of *L. Martagon* are not always bent downwards, but sometimes have their axis in a horizontal or somewhat upright position, and that such flowers are now and then also fertilised by day-fliers. Thus, July 19, 1874, near Franzenshöb, I saw a specimen of *Zygana transalpina*, Esp., visiting the flowers of *L. Martagon*, and inserting its proboscis into the honey-secreting channels; and likewise, July 20, 1875, near St. Gertrud, in the valley of Sulden, a specimen of *Polyommatus hippothoë*, var. *eurybia*, Ochs., behaving in the same manner.  
HERMANN MULLER

#### SCHOLARSHIPS AND EXAMINATIONS FOR NATURAL SCIENCE AT CAMBRIDGE, 1876.

THE following is a list of the Scholarships and Exhibitions for proficiency in Natural Science to be offered at the several Colleges and for Non-Collegiate Students in Cambridge during the present year:—

**Trinity College.**—One or more Foundation Scholarships of 100*l.* and one Exhibition of 50*l.* The examination for these will commence on April 18. The Scholarships are open to undergraduates of Trinity College, and persons under twenty who are not yet resident members of the University. The Exhibition is open to persons under twenty, who have not yet commenced residence at the University.

**St. John's College.**—One of the value of 50*l.* per annum. The examination (in Chemistry, Physics, and Physiology, with Geology, Comparative Anatomy, or Botany) will commence on April 22, and will be open to all persons who have not commenced residence at the University, as well as to all who have entered and have not completed one term of residence. No candidate will be examined in more than three of the above subjects. There is a separate examination in Natural Science at the time of the annual College examination at the end of the academical year, in May; and Exhibitions and Foundation Scholarships will be awarded to students who show an amount of knowledge equivalent to that which in Classics or Mathematics usually gains an Exhibition or Scholarship in the College. In short, Natural Science is on the same footing with Classics and Mathematics, both as regards teaching and rewards.

**Christ's College.**—One or more in value from 30*l.* to 70*l.*, according to the number and merits of the candidates, tenable for three and a half years, and for three years longer by those who reside during that period at the College. The examination will be on April 4, and will be open to anyone, whether a member of the College or not—provided his name is not on the boards of any other College in the University—who is not of sufficient

standing to be admitted *ad titulum Baccalauri in Artibus*. The candidates may select their own subjects for examination. There are other Exhibitions which are distributed annually among the most deserving students of the College.

**Gonville and Caius College.**—One of the value of 60*l.* per annum. The examination will be on April 4, in Chemistry and Physics, and Zoology with Comparative Anatomy and Physiology; it will be open to students who intend to commence residence in October, and are under twenty. Further information may be obtained from the Tutors.—Scholarships of the value of 20*l.* each or more are offered annually for Anatomy and Physiology to members of the College.

There will be an examination on the 4th of April, 1876, in Botany and Comparative Anatomy in its most general sense (including Zootomy and Comparative Physiology), for two *Shuttleworth Scholarships*, each of the value of 60*l.* per annum, and tenable for three years. The candidates must be registered medical students of the University who have kept eight terms, have passed the Additional Examination required for Candidates for Honour, and produce satisfactory testimonials of good conduct. A successful candidate, if not a member of Gonville and Caius College, must become a member of the same. They are tenable with any other Scholarship at the College.

Gentlemen elected to the *Tancred Medical Studentships* are required to enter at this College; these Studentships are five in number, and the annual value of each is 100*l.* Information respecting these may be obtained from B. J. L. Frere, Esq., 28, Lincoln's Inn Fields, London.

**Clare College.**—One of the value of 60*l.* per annum, tenable for two years at least. The examination (in Chemistry, Chemical Physics, Zoology with Comparative Anatomy and Physiology, Botany with Vegetable Anatomy and Physiology, and Geology) will be on March 28th, and will be open to students intending to begin residence in October.

**Downing College.**—One or more of the value of 60*l.* per annum. The examination (in Chemistry, Comparative Anatomy and Physiology) will be on, or about, April 25, and will be open to all students not members of the University, as well as to all undergraduates in their first term.

**Sidney College.**—One of the value of 60*l.* The examination will be on April 4, and will be open to all students who intend to commence residence in October.

**Emmanuel College.**—One of the value of 70*l.* The examination on April 4, in Botany, Chemistry, Chemical Physics, Geology and Mineralogy, Zoology, Comparative Anatomy and Physiology, will be open to students who have not commenced residence.

**Non-Collegiate Students.**—An Exhibition each year is given by the Clothworkers Company, value 50*l.* per annum, tenable for three years. Examination about Christmas, open to non-collegiate students who have commenced residence in the October term, and to any who have not commenced residence. Information to be obtained from the Rev. R. B. Somerset, Cambridge.

Although several subjects for examination are in each instance given, this is rather to afford the option of one or more to the candidates than to induce them to present a superficial knowledge of several.

Candidates, especially those who are not members of the University, will, in most instances, be required to show a fair knowledge of Classics and Mathematics, such, for example, as would enable them to pass the previous examination.

There is no restriction on the ground of religious denominations in the case of these or any of the Scholarships or Exhibitions in the Colleges or in the University.

Further information may be obtained from the Tutors of the respective Colleges, and the names, with certificates of character, date of birth, &c., must be sent to the Tutor of the College, in each case, several days before the examination.

Some of the Colleges do not restrict themselves to the number of Scholarships here mentioned, but will give additional Scholarships if candidates of superior merit present themselves; and other Colleges than those here mentioned, though they do not offer Scholarships, are in the habit of rewarding deserving students of Natural Science.

It may be added that Trinity College will give a Fellowship for Natural Science, once, at least, in three years; and that most of the colleges are understood to be willing to award Fellowships for merit in Natural Science equivalent to that for which they are in the habit of giving them for Classics and Mathematics.



THE INDUSTRIAL APPLICATIONS OF  
OXYGEN<sup>1</sup>

LAVOISIER, who was the first to recognise in its widest range the importance of oxygen, was also the first who succeeded in making a practical use of it. "It is evident," he writes,<sup>2</sup> "that atmospheric air is not the best calculated means to increase the effect of fire; for, when a volume of air is conveyed through the bellows to red-hot coals, three (?) parts of noxious or at least useless gas are conveyed with every one part of the useful kind of air; consequently, if the latter could be employed for combustion in its pure state, the action of the fire would be greatly increased. Doubtless this idea has occurred to many others before me; indeed, I hear that M. Achard<sup>3</sup> has already tried the experiment, but as yet a cheap and convenient apparatus is wanting." Lavoisier first used the bladders of animals, which were provided with cocks and tubes. "Then," continued he, "I made a hole with a knife from three to four lines deep in a large piece of charcoal and placed in it six grs. of platinum. I then ignited the charcoal through the blowpipe communicating with the enamel lamp, uncocked my apparatus, and blew the pure vital air into the cavity. The coal burnt very rapidly with detonation (such as is produced by fusing saltpetre) and with dazzling brightness; in a few moments the platinum was fused to grains, which soon united into a drop. The fusion was effected equally well when using commercial platinum as when using that, which had been deprived of its magnetic parts by the magnet. Hitherto, it is well known, platinum had been considered infusible." In the course of the same year Lavoisier<sup>4</sup> improved his apparatus with the assistance of Meusnier, and soon became possessed of a gasometer consisting of two boxes greatly resembling, on a small scale, the well-known reservoirs used in gasworks for holding coal-gas. About the same time Saron had constructed two blow-pipes (*chalumcaux*), one to furnish oxygen, and the other hydrogen gas.

By their help Lavoisier did not succeed in melting platinum.<sup>5</sup> However, at that time he and Saron had conceived the idea of constructing an improved blow-pipe, in which the oxygen should surround the hydrogen, and this led to the contrivance of the oxyhydrogen blow-pipe, which has ever since been of such substantial service in the working of platinum and the soldering of lead.

No further attempts were made to fuse platinum by means of oxygen until Deville and Debray<sup>6</sup> in 1857-1859 and the years following, published their excellent researches "On the platinum metals," and brought the fusion of platinum into practice. The soldering of platinum with platinum, and the manufacturing of cast bars, were carried on on a large scale, first by Messrs. Johnson, Matthey, and Co., in London, and afterwards, though on a smaller scale, by Heræus in Hanau. The experiments of Debray and Deville were attended with one especial result, the discovery of a fire-proof material for making furnaces and crucibles. This is quick-lime, which had the further advantage of retaining the heat as completely as possible. Besides, the temperature was increased by conducting the flame from above, directly, to the surface of the metal, and regulating the quantity of oxygen and hydrogen as theory and practice suggested it. To melt 2 kilograms of platinum, theory demands 55 litres oxygen and 110 litres hydrogen, while in reality more than one kilogram is fused by these quantities, so that not 50 per cent. of the generated heat is lost (a very satisfactory result). Their experiments were of still greater importance for the history of oxygen industry, inasmuch

<sup>1</sup> Translated, by permission of the editor, from the Report on the Development of Chemical Industry, in conjunction with friends and fellow-workers, by A. W. Hofmann.

<sup>2</sup> "Mémoire sur un moyen d'augmenter considérablement l'action du feu et de la chaleur dans les opérations chimiques" (1782). Œuvres de Lavoisier, ii., 425.

<sup>3</sup> The above-mentioned work of Achard is to be found in the Memoirs of the Berlin Academy of 1779, under the title, "Sur un nouveau moyen de produire avec une très-petite quantité de charbons une chaleur égale à celle qu'on peut produire par des verres et des miroirs ardents d'une grandeur considérable." Achard decomposed saltpetre by heat in an earthenware retort, and introduced the "dephlogisticated air" thus obtained into a pair of bellows, from whence it was conveyed into a charcoal furnace, where some iron nails in a hessian crucible were rapidly reduced to fusion. He was also of opinion that the introduction into badly ventilated rooms of gas procured in this way would cause the air in the same to be "dephlogisticated."

<sup>4</sup> Lavoisier, Œuvres ii., 432.

<sup>5</sup> Lavoisier, Œuvres ii., 430.

<sup>6</sup> Deville and Debray, 1859, Ann. Chim. Phys. [3] lvi. 385; Dingl. pol. J. cliv., 130, 109, 287, 383; in abstract Ann. Chem. Pharm. cxiv. 78, and Debray, "Sur la production des températures élevées et sur la fusion du platine," in the "Leçons de Chimie professées en 1861." Paris, Hachette, 1862.

as they gave occasion for comparing the prices of different modes of preparing it, and stimulated inquiry after cheaper processes. These we may divide into chemical and mechanical, subdividing the former again into continuous and intermittent processes. Up to this time the following modes of preparation were in use, or had been proposed. To begin with the oldest method of Priestley, heating oxide of mercury, unquestionably the most costly and the least adapted for practical purposes; then Scheele's method, treating peroxide of manganese with sulphuric acid, which produces sulphate of manganese and oxygen. Through Berthier's researches in 1822, this process has been superseded for manufacturing purposes by heating peroxide of manganese; and, lastly, we have to mention Bertholet's method, the heating of chlorate of potassium. Notwithstanding its cost, the latter is constantly used in the laboratory, because it is easy and requires little heat, although it not unfrequently happens that a too rapid fusion causes explosions. To obviate this inconvenience, the suggestion has repeatedly been made of mixing peroxide of manganese with the chlorate of potassium.

More recent accidents, especially a fearful explosion which took place in a pharmaceutical laboratory in Paris, induced Debray and Bourgoin<sup>1</sup> to publish the precautions taken in Deville's laboratory: peroxide of manganese, or what is easier to obtain in a pure state, red oxide,  $Mn_2O_4$ , is added to the chlorate of potassium in equal quantities, and the iron vessel containing it exposed to heat in a charcoal furnace, so that the fire is lighted from above. Schwartz<sup>2</sup> also gives an account of some accidents occasioned by using peroxide of manganese adulterated with lampblack, and by inadvertence, even with sulphuret of antimony; and for that reason he recommends that all mixtures for the production of oxygen be first tried by heating them on a sheet of platinum. Munck<sup>3</sup> proposed adding oxide of iron, which is more easily recognised, instead of peroxide of manganese. Scheele's method of using peroxide of manganese and sulphuric acid had this disadvantage: the glass vessels employed were very liable to burst, through the solidifying of the sulphate of manganese. To prevent this, R. Wagner<sup>4</sup> proposed to substitute bisulphate of sodium for sulphuric acid, thus forming an easily fusible double salt, which would afford no danger of breaking the retort when cooling. Pure peroxide of manganese yields 18 per cent. by this treatment, while heating it to red heat, which resolves it into sesquioxide, yields only 12 per cent. of oxygen; nevertheless, the last method is the cheapest. Deville and Debray<sup>5</sup> calculates its expense in proportion to the prices of peroxide of manganese, which are as follows:—

	Per 100 kilogs.	Per 1 cb.m.
Romanèche ... ..	10 francs	4'86 francs
Spain ... ..	16 "	3'45 "
Pyrenees ... ..	18 "	3'85 "
Giessen ... ..	29 "	4'87 "
Italy ... ..	40 "	5'98 "

The trifling value of the remaining sesquioxide, which (containing iron) is of no use in the manufacture of glass, is not here considered.

The calculation dates from the time when the regeneration of peroxide of manganese was an unsolved problem. Allowing therefore the price of oxygen obtained from peroxide of manganese to vary between 3'45 and 5'98 fr., it is more than twice as cheap as that which is procured from chlorate of potassium, for which, according to Dupré,<sup>6</sup> the average price is 10 fr.

As a much cheaper source, Deville and Debray now had recourse to sulphuric acid, which at a high temperature is decomposed into water, sulphurous anhydride, and oxygen.<sup>7</sup> Retorts of hard glass of a capacity of 5 litres are filled partly with thin layers of platinum-foil or bits of tile and heated to a red heat, whilst a thin stream of sulphuric acid is introduced.

The escaping gases pass through a cooling contrivance to condense the sulphuric acid, and afterwards through water to remove the sulphurous acid gas. Thus, out of 2'435 kilogs. of sulphuric acid of spec. grav. 1'827, 240 litres of oxygen were obtained, and the price was calculated at 1 fr. per cb.m. By

<sup>1</sup> Debray and Bourgoin, Ber. Chem. Ges., 1870; 240.

<sup>2</sup> Schwartz, "Breslauer Gewerbeblatt," 1865, No. 7: Polzt Centrbl., 1865, 12.

<sup>3</sup> Munck, Pohl's Lehrb. d. Technol., Wien, 1865; 186.

<sup>4</sup> Wagner, Jahresber., 1866; 198.

<sup>5</sup> Deville and Debray, Compt. Rend., li. 822; Dingl. pol. J., cliv., 50.

<sup>6</sup> Dupré, Compt. Rend. lv. 736.

<sup>7</sup> Deville and Debray, Compt. Rend. li. 822; Dingl. pol. J. cliv., 50, in Ausz. Ann. Chem. Pharm. cxvii. 295.

this process the cost of melting 1 kilog. of platinum was reduced to 20 or 30 centimes. According to a notice of Moigno,<sup>1</sup> the firm of José de Susini and Co., in Paris, in the year 1867 prepared oxygen in this way at the low price of 0.85 fr. per cb. m., retransforming sulphurous into sulphuric acid. Instead of the acid itself, Deville and Debray also proposed employing sulphate of zinc: 100 kg. of anhydrous salt yielded them 6.8 cb. m. of oxygen (far more therefore than the best peroxide of manganese), 22 kilogs. of sulphurous acid gas, and 51 kilogs. of oxide of zinc.

Wagner's statement<sup>2</sup> is worthy of remark, that in the year 1867 neither of these methods was in use in Deville's own laboratory; perhaps because the sulphurous acid evolved complicated the working.

We must not pass over Archereau's attempt<sup>3</sup> to employ sulphuric acid in its cheapest combination as gypsum. He asserted that heating pulverised gypsum with sand would produce silicate of calcium, setting sulphurous acid free, which he partly condensed (as did also Susini) under a pressure of three atmospheres, and partly removed by means of a thin paste of lime. A manufactory established on these principles in Paris did not work long.<sup>4</sup> Obviously the very high temperature required is an obstacle. The production of this gas from one of the oldest of all oxidising agents, saltpetre, was not employed on account of two drawbacks. In the first place, a quantity of nitrogen is mixed with it; and secondly, the temperature necessary for its decomposition greatly increases the cost. This last inconvenience was remedied by Webster's<sup>5</sup> adding oxide of zinc to saltpetre: 20 lbs. of nitrate of soda and 4 lbs. of crude oxide of zinc furnished 94.676 cubic feet of a mixture of 59 p. c. of oxygen and 41 p. c. of nitrogen, while chiefly oxide of zinc and caustic soda remained. The price of the oxygen contained in this mixture, so useful for many purposes, without taking into consideration the value of the solid residue, amounts<sup>6</sup> to 2.32; and allowing for the value of the remains, the price is reduced to 0.78 fr.

In no one of these methods appears one of the leading ideas of modern industry, viz., the regeneration of the residues.

The following plans were happier in this respect, and thereby, in part, more successful.

To combine chemically the oxygen of the air with a carrier of oxygen that would easily give off the gas, and would be always ready to take up and again to give off fresh quantities of oxygen, just as mercury does when we transform it into its oxide and retransform the oxide into the metallic state—that is the problem of which the last few years have given an economical solution. As early as 1829 Dingler jun.<sup>7</sup> discovered that oxide of copper as well as peroxide of cobalt and nickel, treated with an excess of chloride of lime, generate oxygen gas, thereby transforming it into chloride of calcium. In the year 1845 Mitscherlich<sup>8</sup> observed that many other metallic oxides, viz. peroxide of manganese, hydrate of ferric oxide, cupric oxide, &c., when added to a solution of chloride of lime, caused a development of pure oxygen. In 1865, Th. Fleitman<sup>9</sup> renewed these observations with reference to freshly prepared sesquioxide of cobalt, the smallest trace of which was sufficient completely to reduce a concentrated solution of chloride of lime into chloride of calcium and oxygen. For practical purposes he recommended to heat to 70° or 80° a highly concentrated solution of chloride of lime (which to avoid frothing over should be previously cleared by filtration) with 0.1 to 0.5 per cent. of sesquioxide of cobalt. By applying chloride of lime containing 35 per cent. of pure hypochlorite, he obtained from twenty to thirty volumes of oxygen in a regular stream; and other observers, notably F. Varrentrapp,<sup>10</sup> confirmed these results, and commended their industrial application. The sesquioxide of cobalt need not be added ready formed; any cobalt salt answers the same purpose, and the sesquioxide employed with or formed by it soon settles at the bottom and can be used again and again.

For that very reason a cheaper oxide—cupric oxide, for instance, as Böttger<sup>11</sup> proposed—would be of trifling advantage, because its use demands<sup>12</sup> a much higher temperature for decom-

position. The tedious work of preparing a clear solution of chloride of lime may be avoided by adding<sup>1</sup> small morsels of paraffin, a thin layer of oil on the surface preventing an overflow. There was still one evil to be grappled with. Chloride of lime requires considerable quantities of water for its solution, and consequently large vessels were necessary for the production of even a moderate quantity of oxygen. For that reason a Winkler<sup>2</sup> rejected chloride of lime, preferring to pass chlorine through a thin paste of lime mixed with a little nitrate of cobalt. By this modification a greater quantity of oxygen can be produced in the same vessel, and there is no danger of the liquid frothing over. The part which the metallic oxide plays in these methods is easy to understand. It acts as a carrier of oxygen, passing by turns into a higher and very unstable oxide, and being reproduced in its original state. The hypochlorous acid transforms sesquioxide of cobalt into cobaltic acid, which instantly separates again into oxygen and sesquioxide of cobalt.

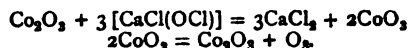

Thus, part of our problem is solved. By the production of oxygen the carrier of oxygen is reproduced. The oxygen, however, thus obtained is not taken from the atmosphere, but from lime. The solution of chloride of calcium resulting from its preparation must be removed and replaced by fresh lime water. The process is therefore an interrupted one, and in this respect capable of economical improvements. These also have been accomplished by methods which carry us back from the wet to the dry way.

Since 1851<sup>3</sup> Boussingault proposed baryta as a carrier of oxygen, which, heated to redness in a porcelain tube and treated with moist air previously freed from carbonic acid, became transformed into peroxide of barium. A current of steam passing over it reproduces hydrate of barium and liberates the oxygen; while an admixture of lime or magnesia prevents the fusing together of the mass, and thus 75 gr. of baryta yield 4 to 5 lit. of oxygen at every operation.

In 1868 Gondolo<sup>4</sup> improved on this method by employing iron tubes protected by an outside covering of asbestos and by an inside layer of magnesia, and placed in suitable furnaces, the temperature of which could be easily regulated. He further added to the baryta a little manganate of potassium as well as lime and magnesia. In this manner 122 alternate oxidations and reductions were carried on in the same tube. Whether it be the high temperature or other obstacles which have prevented this method from being generally adopted, it has certainly made no way as yet into practice, although it has paved the way to final success.<sup>5</sup> Looking for carriers of oxygen of a more useful sort than baryta, the chlorides of copper were the first to strike the attention of chemists. The facility with which they pass into oxychlorides of various compositions when exposed to the air, is the base of the manufacture of a well-known painter's colour, Brunswick green. In 1855 Vogel proposed the action of muriatic acid on cupric oxychlorides as a means of obtaining chlorine.<sup>6</sup> Mallet<sup>7</sup> studied these substances more closely, and founded on them a process of obtaining both chlorine and oxygen. He discovered that cupric chloride, treated with a current of steam, changes at 100° to 200° into several oxychlorides, which, by means of muriatic acid, are not only at once retransformed into the chloride and free chlorine gas, but give off all oxygen at a temperature of only 400°, 1 kilog. of cupric chloride yielding from 28 to 30 lit. of oxygen. Experiments on a large scale produced from 1 to 3½ cb. m. of oxygen, or from 6 to 7 cb. m. of chlorine, from 100 kilogs. of chloride of copper in one operation. As four or five operations can be performed in one day, from 200 kilogs. of cupric oxychloride 15 to 18 cb. m. of oxygen are producible daily.

The apparatus employed consists of revolving retorts of cast-iron lined with clay, and containing the cupric chloride mixed with ¼ of sand or kaolin to render the mass less fusible. This

<sup>1</sup> Stolba, J. pr. Chem., xcvi., 309.

<sup>2</sup> A. Winkler, J. pr. Chem., xcvi., 340.

<sup>3</sup> Boussingault, Compt. Rend. xxxii. 261 et 821; J. pr. Chem. lii. 480 u. liii. 313; Dingl. pol. J. cxv. 120 u. 416; Ann. Chim. Phys. [3] xxxv. 5.

<sup>4</sup> Gondolo, Compt. Rend., lxxi., 488.

<sup>5</sup> Robbin (Pogg. Ann., cxvii., 256) employed peroxide of barium in another form for laboratory use. He recommends a mixture of chromate of potassium (1 mol.) and peroxide of barium (3 mol.) with dilute sulphuric acid, to obtain a very regular and abundant supply of oxygen:—

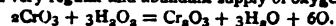

<sup>6</sup> Vogel, Wagn. Jahrb., 1861, 177.

<sup>7</sup> Mallet, Compt. Rend. lxxv. 286, u. lxxvi. 349.

<sup>1</sup> Moigno, Mondes 1867; p. 494.

<sup>2</sup> Wagner, Jahresber., 1867, 216.

<sup>3</sup> Archereau, Dingl. pol. J. clxxviii. 57.

<sup>4</sup> Wagner, Jahresber., 1867; 215.

<sup>5</sup> Pepper, "Chemical News," 1862; 218.

<sup>6</sup> Dupré, Compt. Rend. lv. 736.

<sup>7</sup> Dingl. pol. J. xxvi. 231.

<sup>8</sup> Mitscherlich, Pogg. Ann. lviii. 471.

<sup>9</sup> Fleitman, Ann. Chem. Pharm. cxxix. 64.

<sup>10</sup> Varrentrapp, "Mittheilungen f. d. Gewerbe verein der Herzogthuman," Braunschweig, 1865, 1866; 72.

<sup>11</sup> Böttger, J. pr. Chem., xcvi., 375.

<sup>12</sup> Reinsch, N. Jahrb. Pharm., xxiv., 94; Zeitschr. Chem., 1866, 31.



method was employed at Cologne in 1871.<sup>1</sup> A company formed in Paris for its employment had but a very brief existence,<sup>2</sup> probably owing to a similar discovery which soon supplanted the one described above.

This method, originated and perfected since 1867,<sup>3</sup> by the inventive powers of M. Tessié du Motay, employs peroxide of manganese as the carrier of oxygen, and takes its stand upon the following reactions. Sodid hydrate exposed to dark red heat with manganese and air, yields, as Mitscherlich discovered, manganate of sodium and water,  $4\text{NaOH} + 2\text{MnO}_2 + 2\text{O} = 2\text{Na}_2\text{MnO}_4 + 2\text{H}_2\text{O}$ ; and manganate of sodium, under the influence of a dry current of overheated steam, disengages at the same temperature sodid hydrate, manganic sesquioxide, and free oxygen,  $2\text{Na}_2\text{MnO}_4 + 2\text{H}_2\text{O} = 4\text{NaOH} + \text{Mn}_2\text{O}_3 + 3\text{O}$ . By previously depriving the overheated air of its carbonic acid, one may preserve the mixture in a perpetually active state. This method has been thoroughly tested and approved, and has since been employed on a large scale in Comines, near Lille; in Pantin, near Paris; in New York, in Brussels, and in Vienna. Bothe<sup>4</sup> informs us that a mixture of sixty parts of dry carbonate of sodium with forty parts of 95 per cent. peroxide of manganese, when fused, contains 74.62 parts of manganate of sodium, and that 40 kilogs. of this mixture, which, according to calculation, should give 2,036 cb.m. of oxygen gas, produced in reality 1,800 cb.m., or 90 per cent. of the theoretical yield. He recommends the proceeding as a very practical one. M. Pourcel<sup>5</sup> has given us the most detailed description. According to him, M. Tessié du Motay employs cast-iron ellipsoidal retorts, which lie horizontally one beside the other, and are divided by a grating parallel to their axes, into two unequal parts. Over the grating 350 kilogs. of manganate of sodium, or of the reduced mixture of manganese and soda, are so spread out that its height amounts to 0.60 m., and the empty space above and below the mass is as inconsiderable as possible. In Comines, where five of these retorts are used, the amount of oxygen produced daily is 140 cb.m. at the cost of 450 kilogs. of coals for heating the retorts, and of 150 kilogs. used for the steam-engine. The air is passed through a thin iron vessel with quick-lime by means of the bellows, under a pressure of fr m 3 to 4 cm. of mercury, and enters the retort from above. The temperature of the latter can be observed through a hole provided with an iron stopper. In this way the air gives off only about half of its oxygen, so that to produce 1 vol. of oxygen 10 vol. of air must be passed through, the remainder escaping into the atmosphere. Five minutes suffice for oxidising the reduced mass. The current of air is then interrupted by means of a three-way stopcock and superheated steam passed through the retorts for five minutes, while the gas, passing out below the grating, enters condensers. Here a fine rain of cold water frees the oxygen from the steam, and the gas enters the gasometer under the pressure of a column of water of from 8 to 10 cm. in height. Thus reduction and oxidation alternate at intervals of five minutes. After a lapse of six hours only, it is necessary, for a perfect regeneration of the fused mass, to admit atmospheric air for about an hour, because the quantity of oxygen obtained becomes lowered after five or six hours, down to half or even a third part of the original quantity. In Vienna the cocks are worked by an automatic apparatus. The longer the steam is forced in and the retorts freed from air before the communication with the gasometer is opened, the purer will be the oxygen; half a minute is enough to leave only 15 per cent. of nitrogen mixed with it, provided the injurious space in the retort be kept as small as possible. If the nitrogen be lowered to 4 per cent., which is easily effected, the sacrifice of oxygen will be so much the greater. To make certain that the quantity of nitrogen remains within the limits of 15 and 10 per cent., which are proved to be the most practicable, gas is taken from the gasometer or the condenser in graduated tubes, and the oxygen is absorbed by means of pyrogallate of potassium, a reaction attended by quick and sure results, even in unpractised hands.

As every cooling down of the retort below dark red heat lessens the yield, care is necessary to raise the temperature of the air, as well as of the steam, to about 300° C. In Pantin, where several groups of ten retorts are set up, two of them are filled with pumice-stone to warm the air and the steam. The composition of the fused mass corresponds to 2 mol. NaOH, 1 mol.  $\text{MnO}_2$ , and the fifth part of a mol. of cupric oxide, which serves

only to disintegrate the mass and make it more accessible to the influence of the air and steam. In Comines peroxide of manganese is reproduced from the residues of chlorine by the known methods, almost in a pure state. Its market-price, for which the Pantin works buy it, amounts to 2 fr. per kilog. The high price of this basis of the manufacture of oxygen is indifferent, as it can be used continuously, and the longer, the more carefully the air is kept free from carbonic acid. If, through some unavoidable interruption of the manufactory, the mass should have attracted carbonic acid from the atmosphere, it suffices to bring it to a red heat, and pass steam over it until the steam, on leaving the retorts, produces no precipitates in lime-water: then hot air passed over it will restore the mass to its original efficiency. On an average, a retort is said to last about a year.

M. Tessié du Motay's method produces a cubic metre of 90 per cent. of oxygen for 15 to 30 centimes,<sup>1</sup> or, according to the results of Herr Kuppelwieser's experiments,<sup>2</sup> 1,000 cubic feet at 3 fr., a price in accordance with the last-mentioned sum, and scarcely exceeding that of coal-gas. We may regard this method as a final and successful solution of the problem of discovering economical and rational chemical means for obtaining oxygen.

(To be continued.)

## NOTES

THE Wollaston Medal of the Geological Society has been awarded to Prof. Huxley, and will be presented at the Anniversary of the Society on the 18th inst. Prof. Huxley has also been elected a Corresponding Member of the Danish Academy of Sciences.

The *Times* of yesterday contains a summary account of what has been done so far in this and foreign countries towards organising the Loan Collection of Scientific Instruments to be opened at South Kensington in April. The invitation from the Science and Art Department has met with a hearty response both in this country and from foreign Governments. We last week gave a list of the Foreign Committees, and the *Times* publishes the list of those on the English Committees in the various departments of Mechanics, Physics, Chemistry, Geology, and Biology; and as the *Times* remarks: "By going over them not only does one get an idea of the disinterested way in which men—for the most part busy men—have come forward to help the Department, but there can be no better guarantee of the success of the Exhibition than that afforded by the list of those who are labouring to make it successful." It would indeed be difficult to mention any man of scientific eminence in this country whose name is not included in the list. Out of England, as our readers would see from last week's list, the most numerous committee is the German one. On this the *Times* says:—"The German list gives us much food for thought. It is known, for instance, that the thirty-four local committees, representing her many Universities, Polytechnic Schools, and other scientific centres, were all organised in a week, and that her Universities will, in all probability, be the richest contributors, whereas when we have mentioned Edinburgh, Glasgow, Manchester, Birmingham, Leeds, and Liverpool, and perhaps Newcastle, we have almost exhausted the localities where committees would be useful." The teaching side of the collection will be complete beyond all anticipation. The Physical Cabinet, it is stated, will be such as the world has never seen, towards the formation of which not only will British, French, German, Italian, and Austrian instrument makers lend their aid, but the collections of the Royal Institution, Glasgow University, Edinburgh University, King's College, the Conservatoire des Arts et Métiers, the College de France, the Universities of Berlin, Bonn, Heidelberg, Leipsic, Vienna, Rome, and Leyden, and the Tayler Institution at Haarlem, and the like, will be ransacked. The Chemical and Historical Collections will be of scarcely less magnitude. With regard to the last it is still doubtful whether Italy will part with Galileo's telescope and magnet, even for a month, though it is

<sup>1</sup> Philipps, "Der Sauerstoff," Berlin, 1871, 22.

<sup>2</sup> Wagn. Jahresber., 1867, 215.

<sup>3</sup> Tessié du Motay, Institut, 1868, 48.

<sup>4</sup> Bothe, Zeitchr. d. Vereins deutsch. Ing., 1867, 334.

<sup>5</sup> Pourcel, "Mémoires de la Société des Ingénieurs Civils." Paris, 1873.

<sup>1</sup> Philipps, "Der Sauerstoff," 18.

<sup>2</sup> Kuppelwieser, Berg-u. Hütten. Zeitung, 1873, 354.

hoped that some of the numerous instruments left behind by Torricelli, Volta, and Galvani, may yet be obtained. Besides instruments which are sacred as having belonged to the pioneers of science, others with which the greatest investigators of modern times have made their famous discoveries will have their place in the Exhibition. The *Times* article concludes:—"The scientific position of England has been distinctly raised by this step on the part of our Government, and the Lord President is to be congratulated on a step which not only adds reputation to his Department, but promises to aid so greatly the cause of scientific instruction throughout the land."

UNDER the direction of Prof. Todaro, the biological department in the University of Rome has recently been exhibiting great activity. Prof. Todaro himself has published during the last two or three years a number of important papers, including a monograph upon the development of *Salpa*. There has also appeared a volume entitled "*Recherche nel Laboratorio de Anatomia della Università de Roma*," which contains a number of valuable contributions both by Prof. Todaro and his pupils. Considering the vigour which is being displayed by the anatomists at Rome, it is much to be regretted that the University of the capital of Italy supplies, for biological purposes, accommodation of the most meagre kind.

MR. HERBERT SPENCER has been elected a Corresponding Fellow of the Royal Academy of Rome.

THE first and second Cambridge Smith's Mathematical Prizes have been awarded respectively to Mr. J. T. Ward and Mr. W. L. Mollison, the Senior and Second Wrangler.

AT the last sitting of the Lisbon Royal Academy of Science, the members passed a resolution expressing their appreciation of Lieut. Cameron's labours in traversing the African continent from east to west. A copy of this resolution will be transmitted to Lieut. Cameron. At the same sitting Mr. Bowdler Sharp and Father Secchi were elected Corresponding Associates of the Academy.

ON Monday next, Feb. 14, Prof. Flower will commence an important course of nine Hunterian Lectures at the Royal College of Surgeons, Lincoln's Inn, to be given on Mondays, Wednesdays, and Fridays, upon "The Relation of Extinct to Existing Mammalia, with special reference to the Derivative Hypothesis." This course is a continuation of that of 1873, which we were enabled to report shortly at the time. The discoveries since that year among the *Monotremata*, *Edentata*, and *Ungulata* will be described, as well as the American extinct Perissodactylates and Arteodactylates. Among the most interesting features of the course will be the account of the extinct aberrant Ungulate, *Uintatherium*, and the quasi-proboscideans of North America, also of *Toxodon* and *Nesodon*. The fossil Sirenia, including *Halitherium*; the Cetacea, Pinniped Carnivora, Fissiped Carnivora; Tillodontia, Insectivora and Cheiroptera, Rodentia and Primates will also be included. The lectures will be fully illustrated by specimens from the Museum, and by diagrams. We shall have the opportunity of giving fairly full abstracts of these lectures, one each week—the first in our next issue.

M. CAZIN sends an interesting note to the last number of the *Bulletin International*. It seems that M. G. Loppé, the glacier painter, well known to all Alpine tourists, and Mr. James Eccles, of London, attempted on January 20 last the ascent of Mont Blanc. They were only able to reach the Grand Plateau; the wind raised thick clouds of snow dust, which threatened to bury the party. Thermometric observations were made, and they show that the temperature varies little in the high Alpine regions. The lowest temperature ( $-13^{\circ}$ ) observed on the Grand Plateau (3,932 metres) is no lower than the temperatures

observed in the same place during summer. The provisions—meat, bread, wine, tea—were frozen, and the wind made the cold insupportable. The following are the temperatures observed during the ascent and at Chamounix:—

ON THE MOUNTAIN.

Jan. 19.	Junction of the glaciers, 2,600 metres,	4.30 P.M.	- 5°·5
" "	Grand Mulets ...	3,050 "	8.30 "
" 20	" " " " " "	" "	2 A.M. - 7
" "	Small Plateau ...	3,635 "	8.30 "
" "	Grand Plateau ...	3,932 "	9.30 "
" "	Grand Mulets ...	3,050 "	1 P.M. - 8°·5

At Chamounix the temperature on Jan. 20 at 7 A.M. was  $-11^{\circ}$ , at 8 A.M.  $-10^{\circ}$ , at 10 A.M.  $-9^{\circ}$ , at 11 A.M.  $-8^{\circ}$ . The sun began to appear at 11.30.

AT a meeting of the Edinburgh Medico-Chirurgical Society, held on Monday, Jan. 31, Dr. Matthews Duncan read a paper on the alleged epidemic character of erysipelas and puerperal fever. From an elaborate set of diagrams showing the weekly and yearly deaths registered in London from 1848 to 1875, it was pointed out that during the whole of this time erysipelas and puerperal fever have on no occasion exhibited any approach in their death-rate to such diseases as cholera, small-pox, and scarlet-fever, allowed by all to be epidemic in their character, but that the weekly and annual fluctuations in their death-rate are practically identical with those of rheumatism. It was therefore concluded that erysipelas and puerperal fever should be classed not as epidemic but as endemic diseases.

PROF. E. QUETELET has published the climatological elements of Brussels in a series of eighteen tables, with descriptive letter-press, for the ten years ending 1873, as part of a public statistical document of Brussels relative to this ten-year period, and which has been printed with the title "*Statistique générale de la Ville de Bruxelles*."

IN a circular letter addressed to the Presidents of the Departmental Meteorological Commissions, dated January 29, M. Leverrier points out that, in developing the system of weather-forecasts for agriculturists, attention must be paid not only to the quantity of rain which falls, but also to the way in which the fall is propagated from canton to canton and from department to department. The manner of propagation of the rainfall it is proposed to represent by means of curves, and the Commission are requested to assist in the work so as to render it possible to construct such charts for the whole of France, and in consideration of the immense labour of the undertaking, skilled meteorologists are invited to lend their assistance in the preparation of these novel but highly-important charts. Still greater precision in stating the local circumstances connected with remarkable hail-storms is insisted on, particularly when it is considered that though everyone knows hail to fall in very different quantities in districts immediately contiguous to each other, and individual cantons and communes to be notorious for their destructive hail-storms, yet the influence of woods, forests, river-courses, and hills is a question still unsolved. This conception of Leverrier's with reference to the vitally important bearing on the meteorology of a country of a comprehensive observation of the rainfall, hail, and thunderstorms, by numerous observers possessing sound local information, is not merely eminently just in science, but augurs well for a satisfactory solution of the peculiarly important but difficult problem he has taken in hand.

THE "*Annuaire météorologique et agricole de l'Observatoire de Montsouris pour l'An 1876*" (pp. 442) has just appeared, containing a good many matters not included in previous issues, of which the most interesting are a chart showing the lines of equal magnetic declination for France and parts of the countries adjoining, a table showing the successive values of the declination from 1550 to 1875, a chapter on atmospheric electricity, a

table giving the mean temperature of Paris for each day of the year, calculated from sixty years' observations, a comparison of the mean hourly observations from March to September, between the thermometer in shade and Becquerel's electric thermometer, fixed at a height of sixty-five feet above the ground; and a variety of tables, partly chemical and partly meteorological, bearing on agriculture.

DR. E. PERCEVAL WRIGHT, M.A., F.L.S., was, on the 5th inst., re-elected Professor of Botany and Keeper of the Herbarium in the University of Dublin.

THE Royal Irish Academy has lately shown a large amount of literary life. Its publications consist, like those of most of our chartered societies, of Transactions and Proceedings. Of the Academy Transactions during the last twelve months twelve parts have been published; it is noteworthy that these parts, each containing a single memoir, have been published within a few weeks after they have been read. Among them we notice Mr. Jellet's memoir on Chemical Optics, Mr. Stoney's report on Riveted Joints, Dr. Macalister's report on the Anatomy of Insectivorous Edentates, Mr. Baker's report on the Seychelles Fern Flora, Dr. Doberck's four memoirs on various Binary Stars, and on the first Comet of 1845, Dr. Hart's memoir on the Nine-point Contact of Cubic Curves, Mr. Mackintosh on Echini Spines, and Prof. King on Jointing. The Scientific Proceedings during the same period have been published quarterly, and the four parts contain thirty-seven memoirs, not of sufficient importance for the Transactions, which are illustrated by thirty-four plates and many woodcuts. One long report by Rev. E. O'Meara on Irish Diatomaceæ will be of interest to all microscopists, while many of the papers by Dr. Macalister, Mr. Archer, Mr. Mackintosh, Mr. Burton, Dr. McNab, Dr. Leith Adams, are of very considerable importance. Speedy publication is the very life of science, and we trust the Irish Academy will indulge, in this respect, in a generous rivalry with the cognate London societies. The separate publication of the memoirs is a boon to the working student, who cannot always afford to buy a large volume of some 600 pages for the sake of perhaps one small memoir.

THE Royal Commissioners on Vivisection have signed their report, which will forthwith be despatched to her Majesty.

M. BERTHELOT, the celebrated chemist, is a candidate in the moderate Republican interest for the representation in the French Chamber of Deputies, of the district in which the Institute is situated.

WITH this month's number of Petermann's *Mittheilungen* is a map of the African west coast from 3° to 6° S. lat., showing the results obtained by the German African Expedition. A short paper by Dr. Güssfeldt states briefly the bases on which the map is constructed. Its special value lies in the fact that it is almost wholly constructed from materials obtained by the personal observation of Dr. Güssfeldt. The same number contains the continuation of the account of the recent Paris Geographical Exhibition. Dr. A. Schreiber, who lived six years in Sumatra, contributes an important paper on the Southern Batta Lands of that island; the paper is accompanied by an excellent and full map of that portion of the island between the equator and 2½° N. lat., and westward of the 100th degree of E. long. The number contains what may be regarded as a complete geographical necrology for 1875. It comprises thirty-six names, and how wide Dr. Petermann's interpretation of the word geography is may be learned from the fact that among these names are those of Sir Charles Lyell, Sir W. E. Logan, and Dr. von Willemoes-Suhm. The number concludes with the continuation of Dr. Conto de Magalhaes' account of his travels in Uruguay.

THE *Geographical Magazine* for February contains a brief but clear account of the work accomplished by Cameron. Major

Wood's paper on former physical aspects of the Caspian is continued, and Prof. Giglioli contributes translations of letters from Dr. Beccari, the Italian explorer of New Guinea; a map accompanies these letters.

THE December number of the *Bulletin* of the French Geographical Society contains the abstract of the diary of a Rabbi who recently journeyed from Mogador in Morocco to the Djebel Tabayoudt. The Abbé Durand's valuable paper on the basin of the Madeira, S. America, is concluded, and M. Fournier contributes some recent information on Mozambique and the production of the basin of the Zambesi. M. V. A. Malte-Brun reports on Dr. Van Raemdonck's work on the terrestrial and celestial spheres of Mercator. In connection with the proposed erection of a Central Meteorological Observatory on Mont Pie, Abbé Perrier gives some account of that mountain. It is in the middle of the Graian Alps, 3,593 metres above the sea, nine kilometres from the town of Aosta.

AMONG the notices of motion in the House of Commons on the opening day of Parliament, were one by Sir John Lubbock to introduce his National Monuments' Bill, and another by Mr. Mundella of a Bill for the establishment of Free Libraries, Museums, and Institutions for the Teaching of Science and Art.

THE French Association for the Advancement of Science opens its next Congress at Clermont-Ferrand on August 17 next.

VOL. V. Part II. of the *Natural History Transactions of Northumberland and Durham* contains the Presidential Addresses for 1874 and 1875. The most important contribution to the part is an interesting Memoir of the Life of the late Albany Hancock, by Dr. Embleton, which ought to prove acceptable to all naturalists. A beautifully-executed steel portrait accompanies the memoir, and appended is a list of seventy-three works, mostly contributions to various journals, written either wholly by Mr. Hancock, or in conjunction with some one else. Dr. Embleton also contributes a paper on the Vendace (*Coregonus Willoughbii*, Yarrell, *C. Maranula*, Jardine and Jenyns), and Mr. G. C. Atkinson a second instalment of a Catalogue of the more remarkable Trees of Northumberland and Durham.

ANOTHER catastrophe has befallen the Island of Réunion. On Dec. 22, 1875, a terrific cyclone, accompanied by a thunder-storm, deluged St. Denis, the chief town. The whole island, fifty miles long, by thirty miles broad, was more or less damaged; but the loss of life has been smaller than when the landslide occurred a month previously.

WE have received a copy of the first number of *The American Journal of Microscopy*, a new monthly paper published at New York, which has commenced in an unpretentious manner, the object of the editor evidently being to increase it if he finds that the plan of its construction suits it to the wants of a sufficiently large circle of contributors.

AT the last meeting of the Eastbourne Natural History Society, Dr. Ogier Ward read a paper on the Hill-Forts of Sussex.

THE additions to the Zoological Society's Gardens during the past week include a Panda (*Aelurus fulgens*) from Nepal, deposited; a Hobby (*Hypotriorchis subbuteo*), and a Common Kestrel (*Tinnunulus alaudarius*), captured in the Red Sea, presented by Mr. S. Baton; a Bonnet Monkey (*Macacus radiatus*) from India, presented by Mr. E. Darwell; two Snowy Egrets (*Ardea candidissima*) from America, purchased; and a Red-crested Cardinal (*Paroaria cucullata*) from S. America; two Amaduvade Finches (*Estrela amadava*) from India, presented by Mr. Peter W. Barlow, jun.; a Swainson's Lorikeet (*Trichoglossus swainsoni*) from Australia, presented by Mrs. G. F. Angus.

## SOCIETIES AND ACADEMIES

LONDON

Royal Society, Jan. 20.—Certain cases of electromotive force sustained by the action of electrolytes on electrolytes, by J. Hopkinson. Communicated by Sir W. Thomson.

On reversed photographs of the solar spectrum beyond the red, obtained on a collodion plate, in a letter to Prof. Stokes, by Capt. J. Waterhouse, Assistant Surveyor-General of India. Communicated by Prof. Stokes.

Jan. 27.—Contributions to the minute anatomy of the thyroid gland of the dog, by E. Cresswell Barer, M.D., Lond. Communicated by Dr. Klein, F.R.S.

Results of the monthly observations of magnetic dip, horizontal force, and declination made at the Kew Observatory, from April 1869 to March 1875 inclusive, by the Kew Committee.

Researches on the minute anatomy of the alimentary canal, by Herbert Watney, M.A., Demonstrator of Microscopical Anatomy at St. George's Hospital. Communicated by Dr. Klein, F.R.S., Assistant Professor in the Brown Institution.

Linnean Society, Jan. 20.—Prof. G. J. Allman, F.R.S., president, in the chair.—Prof. Oliver communicated a short paper, by Prof. H. G. Reichenbach, being the twenty-ninth contribution to the botany of the *Challenger*, viz., On some Orchidaceæ collected by Mr. Moseley of the *Challenger* expedition, in the Admiralty Islands, Ternate, and Cape York—one of which forms the type of a new section of the genus *Dendrobium*.—The Fungi of Brazil, by the Rev. M. J. Berkeley and Dr. M. C. Cooke. The authors include the collection made by Mr. J. H. Trail in 1874, and state that all the Brazilian fungi yet known amount to but 437 species. Among these there are of Hymenomyces, 356; Gasteromyces, 13; Hyphomyces, 7; Coniomycetes, 5; Ascomycetes, 55; incomplete, 1—total, 437. About 300 of these are confined to Brazil, the remainder found in other parts of the world. The great Brazilian region, therefore, with but 437 representatives, contrasts with 886 enumerated for Cuba, and 1,190 for Ceylon. This paucity of species in the first-mentioned area, the authors suggest, may be due to incompleteness of collection, or presumably as yet deficient knowledge of microscopical forms.—On a new species of oak from the Sikkim Himalaya, by Dr. George King, F.L.S., Supt., Roy. Bot. Gard., Calcutta. This, the *Quercus Andersoni*, or "Katoos" of the Nepalese, is one of the finest forest trees, and largely used by the European residents of Darjeeling. It occurs at higher altitudes than *Q. spicata*, and in other respects differs.—On Steere's sponge, a new genus of the Hexactinellid order of the Spongidae, by Dr. James Murie. Obtained in deep water between the islands of Negros and Zebu, the present adds one more rarity to the already remarkable sponge fauna of the Philippines. The siliceous skeleton of *Dendrospongia steerei* bears resemblance to a branching coral or shrub, and is nearly three feet high. A peculiar rosette-like series of tufts form a continuous whorl, winding spirally up the branches. Microscopical examination shows the spicules to belong to the sex-radiate type: the character of these, with the presence of a veil and other structural points, indicate its being an intermediate type between such forms as *Dactylocalyx*, *Aphrocallistes*, *Holtenia*, and *Meyerina*. The homology of the so-called root, body, and beard spicules of several of the siliceous sponges being noted, those of *Dendrospongia* are compared; the spiral tufts of the latter agreeing in many respects with the spicular fringes of *Euplectella*, &c.

Chemical Society, Feb. 3.—Prof. Abel, F.R.S., president, in the chair.—Mr. W. Ackroyd read a paper on metachromism, or colour change. Metachromism, from the Greek *μετά*, change, and *χρῶμα*, colour, is the term applied to the phenomenon investigated, viz., the change in colour observed in bodies when heated at comparatively low temperatures. For convenience sake colour-changing bodies were called metachromes. No mention is made of the subject in text-books, and only here and there in scattered memoirs. The views of Stahl, Delaval, Brewster, Schenbein, Gladstone, and Houston and Thomson were spoken of and discussed. *Colour change takes place in the order of the spectrum colours: when a metachrome is expanding, in the violet to red order; when contracting, red to violet order.* Such colour change it was pointed out might be taken as an indication of expansion or contraction, the anomalously behaving body AgI fully bearing out the author's conclusions. Metachromes were divided into two classes: (1) the zinc oxide class; and (2) the borate of copper class. From a study of the two

classes the following metachromatic scale was arrived at: white, colourless, violet, indigo, blue, green, yellow, orange, red, brown, black—metallic appearance. The colours of the more refrangible end may be replaced by a metallic appearance. Metachromism has an important bearing on allotropy. A body expanding through the influence of heat being really a continuous series of allotropes. In support of this the relation of colour and density was discussed. It was shown that metachromism is due to the storage of potential energy, the author holding that molecular vibrations or kinetic energy have nothing to do with this phenomenon of selective absorption. Contracting metachromes changing from less to more refrangible colours, where would this change cease providing a long enough temperature could be had? Presumably at the absolute zero of temperature, and at this point all metachromes would be white or metallic-looking, judging from their behaviour at attainable temperatures. Following expanding metachromes from this *absolute zero of colour*, the change in each would vary with the coefficient of expansion, giving us at the normal temperature all that diversity of hue which characterises the inorganic world. Including certain cases of decomposition (given in table) colour change may denote (1) If to more refrangible, a contraction or  $\beta$  decomposition; (2) If to less refrangible, an expansion or  $\beta$  combination. The observations relate to anhydrous and for the most part binary compounds.—Mr. W. H. Perkin, F.R.S., made a communication on the formation of anthra-purpurin, which it appears is the product of the action of caustic alkali on anthraquinone-disulphoric acid. The supposition that alizarin is formed under these circumstances being incorrect.—There were also papers on mottose, by Mr. C. O. Sullivan; on a simple form of gas regulator, by Mr. J. Fletcher; and on high melting points, with special reference to those of metallic salts, by Mr. T. Carnelley, B.Sc.

Zoological Society, Feb. 1.—Mr. G. R. Waterhouse, vice-president, in the chair.—The Secretary read some extracts from a report of a recent visit made by H.M.S. *Porpoise* to the Galapagos Islands, communicated by the First Lord of the Admiralty, and referring to the tortoises met with in the different islands of the group.—Mr. Sclater exhibited and made remarks on an antler of a Rusa Deer, living in the Gardens of the Acclimatization Society of Melbourne, which had been sent to him for identification.—Mr. Frederick Selous, jun., exhibited and made remarks on a series of horns of African Rhinoceroses procured by himself in South-eastern Africa.—Prof. T. H. Huxley, F.R.S., read a paper on the position of the anterior nasal aperture in Lepidosiren, which he showed to be strictly homologous with the position of these organs in other vertebrates.—Mr. A. H. Garrod read a paper on the anatomy of *Chauna derbiana*, and on the systematic position of the Screamers (*Palamedidae*), in which he controverted Prof. Parker's collocation of this form with the Anseres, and showed that it should occupy an independent position with relations to the Struthioncs, Gallinae, and Rallidae.—A communication was read from Mr. F. Jeffrey Bell, containing notes on the myology of the limbs of *Mochlus moschiferus*.—A communication was read from Dr. T. Spencer Cobbold on Entozoa, forming the third of a series of papers on this subject brought by him before the Society.—Mr. Herbert Druce read a list of butterflies collected in Peru, with descriptions of new species. To these were added some notes on some of the species, by Mr. Edward Bartlett.—Mr. A. G. Butler read some notes on a small collection of butterflies received from the New Hebrides.—A paper by Mr. P. L. Sclater and Mr. O. Salvin was read, in which they gave descriptions of some new birds obtained by Mr. C. Buckley, in Bolivia.

Physical Society, Jan. 29.—The president, Prof. Gladstone, F.R.S., in the chair.—The following candidates were elected members of the Society:—Sir John Conroy, Bart., and H. S. Burls.—The Secretary then read a communication from Mr. J. A. Fleming on the polarisation of electrodes in water free from air. The experiments described were undertaken in order to meet objections which had been raised by Prof. Rowland to a previous paper by the author, in which he endeavoured to show that when an electrolyte flows in a very strong magnetic field the electromotive force generated by its motion effects the electrolysis of the liquid, a fact which he holds to be proved by the subsequent polarisation of the electrodes. Prof. Rowland considered that the effect observed was due to the presence of dissolved air, and conversely, that in air-free water, at any rate with the same electromotive force, similar effects would not be observed. These doubts raise the two questions (1) in air-free water can platinum electrodes be polarised by a very small electromotive

force to the same degree and with the same facility as in aerated water, and (2) is this very feeble polarisation really a decomposition of the electrolyte? To test the first point experiments were made with a voltmeter containing dilute sulphuric acid which had been previously boiled, the voltmeter being connected with a Sprengel pump. The platinum plates were acted on by a very small external electromotive force for one minute, and the effect of the polarisation current due to this action noticed on an extremely delicate galvanometer, the effect of the direct current employed being also noted. After a series of observations had been made, using different amounts of electromotive force, the dilute acid was removed, and, after being thoroughly aerated, replaced in the voltmeter. On repeating the experiments with this one change in the conditions, the results obtained were almost identical, from which fact the author concludes that the first question may be answered in the affirmative. With regard to the second, Mr. Fleming believes that the assertion that polarisation is decomposition of the electrolyte has never been called in question, and in proof of it, describes an experiment showing that when acidulated water flows rapidly past slightly polarised plates, the current which they give is very much diminished, while by causing the water to flow slowly but slight change is produced. This seems to indicate that there is something on the plates which can be wiped off mechanically, and it can only be a product of electrolysis.—Prof. Foster, while admitting the accuracy of Mr. Fleming's experiments, doubted whether he was justified in definitely ascribing polarisation to chemical action. He thinks that, even though the effect be proved not to be due to dissolved air, we must look for some cause other than chemical action. For it has long been acknowledged that the decomposition of water requires an electromotive force considerably in excess of that employed in these experiments.—Prof. Gladstone then made a brief communication on the photography of fluorescent substances. He exhibited several photographs taken of white paper on which devices had been previously drawn, with solutions of sulphate of quinine, cæsculine, &c., and one was taken in the room. He remarked that the leaves of trees come out dark in a negative, as they contain the fluorescent substance chlorophyll, and suggested that the irregularities of colour observed in photographs of oil paintings are probably due to the intermixture of fluorescent substances in the paints used.—Mr. Meldola referred to Prof. Vogel's experiments on the effect produced on the resulting photograph by the addition of a fluorescent substance to the collodion, thereby increasing the sensitiveness of the plate to particular rays.—Mr. S. P. Thompson, B.A., B.Sc., then gave a summary of the recent experiments made in America by Mr. T. E. Edison, Dr. Beard, Prof. Houston, and others upon the new phase of electric manifestation, the so-called etheric force. This force is characterised by a faint spark, the only evidence, in fact, yet known of its existence. It may be obtained from the iron core of any electromagnet, or from a metallic bar slipped into the coil in place of the core, but only when the battery circuit is being interrupted, as may be done by introducing into the circuit an automatic contact breaker. The sparks so produced are apparently without polarity, devoid of chemical or physiological effect, affect neither electrosopes nor galvanometers, and are stated to be retroactive, being exhibited when one end of a wire through which they are passing is brought round to touch the wire. A detailed description was then given of experiments on this force conducted in the Physical Laboratory at South Kensington, some of which were confirmatory of the published researches of the discoverers, while others were at variance with them. Great pains had been taken to avoid leakage and to distinguish the effects from those of ordinary induced currents. The batteries and coils employed were insulated from the earth as well as from the other portions of the apparatus. A bar of zinc placed above the poles of a powerful electro-magnet, or within its coils, was found to give better results than one of cadmium, which is recommended by the discoverers. The sparks, which resembled those of dynamic electricity, were of inappreciable length and far too faint to ignite gun-cotton or illuminate a delicate Geissler's tube. It was also found that when a bar of zinc was placed within the coil of an electro-magnet in the place of its core and joined by a wire to the gas fittings of the building, faint but distinct sparks could be drawn from any portion of this wire by a second wire proceeding from another part of the gas pipes. Another peculiar effect was observed when the wire attached to one end of the zinc bar, and armed at its extremity with a thin iron wire, was rubbed lightly against the other end of the zinc bar—sparks being thus obtained, apparently

passing from one pole of the zinc bar, through the wire, to the other.—Dr. Stone believed he had detected a distinct galvanic taste on applying to the tongue the wire through which the "force" was passing.—Prof. Foster suggested the use of an electro-dynamometer to ascertain the electromotive force of the current exhibiting these sparks, as its indications would be independent of direction of current.

Royal Microscopical Society, Feb. 2.—Anniversary Meeting.—H. C. Sorby, president, in the chair.—The Report of the Council and the Treasurer's Annual Statement of Accounts were submitted to the Fellows, and showed that the Society was, at the present time, in a satisfactory and prosperous condition. Votes of thanks to the President and Council for their services during the past year were proposed by Mr. J. Glaisher and carried unanimously. The President then delivered the address, the subject of which was the probable limit of the powers of the microscope with reference to the ultimate size of the molecules of matter, and the general bearing of the conclusions arrived at upon the various germ theories. The following gentlemen were elected as Officers and Council for the ensuing year:—President, Henry Clifton Sorby, F.R.S. Vice-presidents: Charles Brooke, F.R.S., William B. Carpenter, F.R.S., Rev. W. H. Dallinger, Hugh Powell. Treasurer, John Ware Stephenson, F.R.A.S. Secretaries: Henry J. Slack, F.G.S., Charles Stewart, F.L.S. Council: Robert Braithwaite, F.L.S., Frank Crisp, LL.B., John E. Ingpen, Emanuel Wilkins Jones, F.R.A.S., William T. Loy, Henry Lawson, M.D., John Millar, F.L.S., John Ridgen Mummery, F.L.S., John Matthews, M.D., Frederic H. Ward, M.R.C.S., Francis H. Wenham, C.E., Charles F. White. Assistant Secretary, Walter W. Reeves.

Institution of Civil Engineers, Feb. 1.—Mr. Geo. Rob. Stephenson, president, in the chair.—The paper read was on the "Holyhead New Harbour," by Mr. Harrison Hayter, M. Inst., C.E.

Victoria (Philosophical) Institute, Feb. 7, Mr. C. Brooke, F.R.S., in the chair.—After the election of new members it was stated that during the past year thirty-three town, sixty-four country, and eighteen foreign and colonial members had joined. A paper on "Heathen Cosmogonies compared with the Hebrew" was read by the Rev. B. W. Savile.

#### PHILADELPHIA

Academy of Natural Sciences.—During 1875 a large number of interesting papers and communications were read.—Prof. Cope, in describing some vertebrate fossils from the Saskatchewan district, said that they gave indications of the future discovery of a complete transition from Cretaceous to Eocene life. The collection was chiefly remarkable for the great number and variety of Dinosaurian remains. In another paper Prof. Cope attempted to trace the evolution of the sectorial tooth of Carnivora from the simple quadri-tuberculate molar. He regards the process as having consisted first in an addition of an anterior cusp, and subsequently in the loss of internal and posterior cusps. There had been a progressive extinction of genera with numerous sectorial teeth, with an increasing specialisation of the sectorial tooth in the surviving genera. Parallel with this change was another, in the character of the tibio-astragalar articulation, which he believed to indicate that the American Eocene Carnivora were plantigrade. In describing a new Mastodon from Santa Fé, Prof. Cope divided the North American Mastodons into two groups, the first having teeth with continuous cross-crests divided by a fissure only, the other having transverse series of two or more deeply-separated tubercles. Comparatively recently Prof. Cope announced the discovery of vertebræ and other remains from Illinois, which appear to give the first definite indication of the existence of Rhynchocephalous lizards in the western hemisphere.—Prof. Leidy's contributions have referred chiefly to Rhizopods and Vermes, and to Vertebrate Palæontology. He described a remarkable Rhizopod, which he compared to the reticular pseudopods of a Gromia separated from the body. At one time it appeared as an extremely thin disc with a multitude of minutely ramified and anastomosing pseudopods proceeding from its edge. At other times it divided up into branches from a trunk like a tree. Again it would assume the form of a cord, and the jelly accumulating at some portion of it would run along it like a drop of water on a piece of twine. A granular circulation was observable as in Gromia.—Mr. T. G. Gentry presented an important paper on the phylogeny of the Lepidoptera, suggested by an anomalous development of certain larvæ of *Acronycta oblianta*, without the slightest attempt at cocoon-making.

Other instances among insects were adduced to show the important influence of the surroundings of a species in producing functional changes in its economy, and it was sought to be established that defective nutrition has been a principal cause of cocoons being dispensed with by certain Bombycidae. From these preliminary considerations the author proceeds to consider the evolution of the various families of Lepidoptera. He believes that the butterflies have as a whole been developed from the Bombycidae, though that development has probably been accomplished through several roads. He claims the support of palaeontological evidence for his views. The earliest moths yet recorded are the Tineids, the lowest family of Lepidoptera; these may be regarded as constituting a persistent type like that of Terebratulas. The Sphingae are supposed to have descended from a Phryganea with Bombycid characters, and many ingenious suggestions and considerations are advanced in support of this view. A hypothetical genealogical tree is given at the close of the paper.—A monographic account of *Nisus (Accipiter) cooperi* and *N. gunndachi*, by Mr. R. Ridgway, gives the results of careful examination of many specimens. With regard to the former it is found impossible to establish the existence of two geographical races. The distinctness of the latter species is strongly maintained. Mr. Ridgway's account of the Buteonine sub-genus, *Craxidex*, which is peculiar to America, gives a synopsis of the species. The very variable *Buteo swainsoni* is particularly fully described.—A very interesting paper is contributed by Dr. Elliott Coues, devoted to a vindication of William Bartram as a scientific ornithologist. Dr. Coues seeks to prove that, according to the admitted rules of nomenclature and the rules of the British Association, Bartram has not received his due. He maintains that Bartram's Catalogue of United States Birds is not a mere valueless list, but all the more valuable in consequence of the terseness and simplicity of his descriptions, many of which are unmistakable.—One of the most important papers of the year is by Dr. Lautenbach, on the physiological action of hemlock and its alkaloid. His conclusions, from careful experiments, are as follows:—1. Conia, instead of being poisonous to plants, really acts as a preservative; the alcoholic extract of hemlock, however, acts poisonously on plants. 2. When locally applied, conia produces a progressive loss of functional power in every highly organised tissue with which it comes into contact. 3. In inducing complete repose of the muscular system, conia powerfully predisposes to sleep, but it is not a hypnotic in the sense that opium is. 4. The convulsions produced by a poisonous dose of hemlock are cerebral, and not spinal, as has heretofore been imagined. 5. Conia produces a double effect on the motor-nervous system, a paralyzing effect on the periphery of the efferent or motor nerves, and a depression of the motor tracts of the spinal cord. 6. The increase in the number of heart-beats which occurs early in conia poisoning is due to paresis of the pneumogastrics. 7. The primary acceleration in the respiratory movements is also due to pneumogastric paresis. 8. The salivary secretion is the only secretion markedly increased by a poisonous dose of conia. 9. The voluntary muscles escape unscathed in conia-poisoning. 10. Contraction of the pupil only occurs when the drug is directly applied to the eyeball. 11. Conia causes a decided increase in temperature. 12. Conia is absorbed and is eliminated unchanged by the kidneys.

PARIS

Academy of Sciences, Jan. 31.—Vice-Admiral Paris in the chair.—The following papers were read:—Thermal researches on the formation of alcohols and on etherification, by M. Berthelot.—Account of experiments made to determine the work expended by Gramme's magneto-electric machines, used for producing light in the works of M.M. Santer and Lemonnier, by M. Tresca. A direct-illumination photometer was used for comparing an electric lamp with a Carcel lamp, and when equality was had in the two contiguous zones, a dynamometer trace was taken, and the number of turns ascertained. The author gives data of machines, the light from which was equal to 1,830 and 300 Carcel burners respectively. The cost of fuel for the former was only about a hundredth of that of the oil and a fiftieth that of the coal gas.—M. Du Moncel presented the fourth volume of his "Exposé des Applications de l'Electricité" (3rd edition), relating to electric clockwork, electric registers, and applications of electricity to safety appliances in railway service.—Researches on magnetic rotatory polarisation (2nd part), by M. Becquerel. The rotation in diamagnetic bodies increases with the index of refraction. In solutions of a diamagnetic salt of varying concentration, the ratio of the rotation

to the weight of the anhydrous salt is a number nearly constant. With salts of iron the magnetic rotation increases much more quickly than the number of active molecules.—Calorific vibrations of a homogeneous solid of uniform temperature, by M. Lucas.—On the formation of hail (second note), by M. Planté. The electrodes of the secondary couples are introduced into salt water, the positive being covered with moistened blotting-paper. A multitude of ovoid globules are scattered out and up from this latter in all directions. M. Planté thinks the electricity in clouds may sometimes act thus, and the globules, rising to a region of lower temperature, become hailstones. Electricity may produce hail through mechanical, calorific, or magneto-dynamic effects.—Letter to the President of the Commission on Phylloxera, by M. Mouillefert.—On the boring operations in the tunnel of Saint Gothard, by M. Colladon. Notwithstanding much greater hardness of rock, &c., than in the boring of Fréjus. M. Favre has, in the third year, realised an advance of 48½ per cent. above the maximum obtained in Fréjus during the thirteen years.—Discovery of the planet (159), by M. Paul Henry.—Note on left curves of the fourth order, by M. Serret.—On the principle of correspondence, and the means it affords of removing some difficulties in analytical solutions, by M. Sallé.—On topographic maps, by M. Hermite.—On the congelation of mercury by use of a mixture of snow and hydrochloric acid, by M. Witz. A mixture, in equal parts, of snow and hydrochloric acid having a temperature of -1°, will give a temperature of -37°·5 C.—On electrolytic aniline black, by M. Goppelsroeder.—On the ferment of urea, by M. Musculus. It has none of the properties of organic ferments, but is rather like soluble ferments, as diastase, saliva, and pancreatic juice.—On the elements of inverted sugar, and their presence in commercial sugar, by M. Maumené.—On digestion in insects; remarks *à propos* of a recent work of M. Jousset, by M. Plateau. M. Plateau claims priority of observation.—Note on the method to be employed for testing the conductivity of lightning conductors, by M. Michel.—Observations relative to the undulations and fractures of the Cretaceous system, *à propos* of the project of making a tunnel under the Channel, by M. Robert.—On spontaneous periodic movements in the stems of *Saxifraga sarmentosa*, *umbrosa*, *Gerum*, *Acanthifolia*, and in *Parnassia palustris*; relations of this phenomenon with the disposition of the foliar cycle, by M. Heckel.

BOOKS RECEIVED

BRITISH.—Three Months in the Mediterranean: Walter Coote (Stanford).—Lardner's Handbook of Astronomy. 4th edition. Edited by E. Dunkin, F.R.A.S. (Lockwood).—British Manufacturing Industries. Edited by F. Phillips Bevan, F.G.S. 3 vols. (Staoford).—The Races of Mankind. Vol. III: Dr. Robert Brown (Cassell).—Morocco and the Moors: Dr. Arthur Leared (Sampson Low and Co.).—Memoir of Commodore Goodenough: C. R. Markham (G. Griffin and Co.).—Animal Parasites and Mesozoa: P. J. Van Beneden (H. S. King and Co.).—First Book of Zoology: E. S. Morse, Ph.D. (H. S. King and Co.).—Livingstone's First and Second Expeditions to Africa. 5 vols. (John Murray).—Reboisement in France: J. Croumbie Brown, LL.D. (H. S. King and Co.).—Telegraphy: W. H. Preece, C.E., and J. Sivewright, M.A. (Longmans).—Tyrol and the Tyrolese: W. A. Bailie Grohman (Longmans).—Fcod; its Adulterations and the Methods for their Detection: Dr. A. Hill Hassall (Longmans).—Physical Geography: W. D. Cooley (Dulau and Co.).—Short History of Natural Science: A. B. Buckley (John Murray).

CONTENTS

	PAGE
OLD AND NEW WORLD SPIDERS. By O. P. C. . . . .	281
DYEING AND CALICO PRINTING. By R. MELDOLA . . . . .	283
OUR BOOK SHELF:—	
Scientific Culture . . . . .	284
LETTERS TO THE EDITOR:—	
On the most Northerly Latitude at which Land and Freshwater	
Molluscs have hitherto been found.—Prof. A. E. NORDENSKIÖLD	284
Prof. Tyndall on Germs.—Dr. H. CHARLTON BASTIAN; INQUIRER	284
The University of London and School Examinations.—PHILIP	
MAGNUS; H. A. NESSITT . . . . .	286
Public Analysts.—ARTHUR ANGELL . . . . .	287
Large Meteors.—WILLIAM F. DENNING . . . . .	287
The Flame of Common Salt.—E. G. . . . .	287
OUR ASTRONOMICAL COLUMN:—	
The Binary Star $\alpha$ Cassiopee . . . . .	287
The Rugby (Temple Observatory) Catalogue of Double Stars . . . . .	287
Jupiter's Satellites . . . . .	288
THE DRAINAGE OF THE ZUYDER ZEE . . . . .	288
THE BIRDS OF NORTH-EASTERN AFRICA. By P. L. S. . . . .	289
FERTILIZATION OF FLOWERS BY INSECTS, XIII. By Dr. HERMANN	
MULLER (With Illustrations) . . . . .	289
SCHOLARSHIPS AND EXHIBITIONS FOR NATURAL SCIENCE AT CAM-	
BRIDGE, 1876 . . . . .	292
THE INDUSTRIAL APPLICATIONS OF OXYGEN. By Dr. A. W. HOV-	
MANN . . . . .	293
NOTES . . . . .	295
SOCIETIES AND ACADEMIES . . . . .	298
BOOKS RECEIVED . . . . .	298



THURSDAY, FEBRUARY 17, 1876

*THE LISBON MAGNETIC OBSERVATIONS**Annaes do Observatorio do Infante D. Luiz. Magnetismo Terrestre.* Lisbon Imprensa Nacional. (1870, 1874.)

THAT in 1858 Portugal entered into "the Magnetic Union of Nations, founded by Gauss and by Humboldt in 1832," was due to the enlightened solicitude of the King Luiz I. for the progress of science. The observatory founded by him at Lisbon, and placed under the care of the late Mr. de Silveira, has during the last years been directed by Mr. de Brito Capello, who had previously the oversight of the magnetic department, and to whom we believe the results in the two parts of *Annals* before us are chiefly due.

The value of the Lisbon observations and of these results is so much the greater that the neighbouring country, Spain, has done nothing for terrestrial magnetism, and even France, which stands so high in science, has given us no such series of observations since Arago originated them by the devotion of years to the movement of the magnetic needle.

The first part of the *Annals* before us (1870) treats of the results for the magnetic declination derived from direct observations made at 8 A.M. and 2 P.M. (1858-1868), and for the diurnal variations (1864-1868) from a photographic registering apparatus similar to that at Kew. The secular variation is first investigated. This mysterious movement, which we can attribute to no known cause, as it has no known period, is shown at Lisbon by a mean approach of the north end of the needle to the north at the rate of 5'·9 a year during ten years, but varying from a minimum of 4'·8 in 1858-9, to 8'·2 in 1866-7. An annual law has also been found consisting of an oscillation of 1'·5, the needle being nearest the north in June, and farthest from it in December and January.

The diurnal variation at Lisbon resembles to a considerable extent that obtained at more northern stations in Europe. The periodic variation of the mean range of this oscillation, first discovered by Dr. Lamont, which occupies from ten to twelve years, has also been found at Lisbon. This investigation has its importance increased by the fact that the greatest and least mean oscillations happen at the same times as the maximum and minimum frequency of solar spots. The coincidence first indicated by Sir E. Sabine, with reference to magnetic disturbances, was remarked independently by Dr. Rudolph Wolf, of Zurich, who has made it the subject of an extensive and valuable series of investigations. Dr. Lamont, commencing with Cassini's observations, has found the mean duration of the magnetic period to be 10·43 years, while Dr. Wolf obtains 11'11 years from a longer, though perhaps less certain, series of solar spot observations. Since there can be no doubt that the yearly variation of sunspots and of the amplitude of the diurnal oscillation of the magnetic needle follow the same law and depend on the same cause, every new determination of the epochs of maxima and minima is of value, fixing points which will determine the mean duration and variable length of the period, and thus probably lead us to a knowledge of the

common cause. The Lisbon observations give 1859·9 and 1867·0 as epochs of maximum and minimum, agreeing very nearly with those derived from the Munich and Trevandrum observations. In the determination of the mean duration, everything depends on where we commence. If we begin with Arago's magnetic observations, the mean duration is about 10·7 years; if we take the most accurate results for the sunspot area from Messrs. De la Rue, Stewart, and Lœwy, we find 11·2 years, nearly that deduced by Dr. Wolf. Evidently a much longer series of accurate observations is required to determine the length of a period which has varied between 8 and 12·3 years within the last half century; though we believe Dr. Lamont's result to be nearly true.

As the Observatory establishment was not sufficient for the long calculations required for the investigations connected with the lunar diurnal variation, the latter was sought approximately from the effects of the lunar action in diminishing or increasing the solar diurnal oscillation at different days of the moon's age. It was thus found that the diurnal oscillation from 8 A.M. to 2 P.M. was greatest when the moon was three and eighteen days old, while it was least when she was ten and twenty-four days old. This indicates a semi-diurnal oscillation due to the moon's action, with an amplitude of 1' nearly, having the maximum westerly positions when the moon is near the upper and lower meridians.

It is remarked by Mr. Capello, with reference to disturbances, that in many cases the observations taken as disturbed (those differing from the normal position by 2'·26 or more) were, properly speaking, not disturbed observations, but belonged to very regular curves, in which the morning minimum was more marked or the afternoon maximum was less so than usual. Whereas disturbances are shown by serrated curves. This remark is quite exact, and the fact becomes even more marked in lower latitudes. The investigation for the lunar variation just noticed will show one cause for this variation of the amplitude of the diurnal oscillation which is greater the greater the lunar action.

The second part of the *Annals* before us (1874) contains the discussions for the other magnetic elements. Mr. Capello finds, from nine years' observations, that the horizontal force of the earth's magnetism was greatest in July, least in September, with a secondary maximum in November, and minimum in February. This result depends on few observations, but approaches considerably to that obtained first at Makerstoun. The very marked minimum found for the month of September induced Mr. Capello to examine whether this might not be due to the action of disturbances, which in general diminish the earth's magnetic force; it results from this discussion that though the disturbances have a considerable effect in increasing the amplitude of the annual oscillation, yet the maximum in December is best marked in years of least disturbance. This result he confirms by an examination of the Kew observations, and it agrees with that deduced from each of a series of years' observations of the bifilar at Makerstoun. Mr. Capello also finds that the Munich observations show the most marked minimum in September and October, in years of least disturbance. It is an important fact, confirmed by the results from many observatories, that the horizontal force of the

earth's magnetism is a maximum near the solstices, and a minimum near the equinoxes.

The diurnal variations of horizontal force, deduced from the photographic registration of the bifilar magnetometer, follow laws similar to those at Munich, and not differing greatly from those at Makerstoun, 17° further north; the minimum, however, shifting from near 9 A.M. in summer to about 2 P.M. in winter.

The balance magnetometer seems to be the least certain of the variation instruments at Lisbon. The temperature coefficient (obtained by heating the air with gas jets) has been found with an opposite sign to that due to variations of the needle's magnetism, a result which is always unsatisfactory even when the variations of temperature are small as they are at Lisbon. The diurnal variation of the vertical magnetic force differs considerably from that obtained at more northern observatories, the minimum occurring in each month of the year near noon, and the maximum near 5 P.M.

Mr. Capello has evidently bestowed much pains on the determination of his instrumental constants, and this publication of results contains a valuable contribution to our knowledge of the magnetic laws for an important station, near the most southerly and westerly point in Europe. Lisbon, like nearly every other magnetic observatory, has been obliged to be satisfied with single instruments of each kind. When so many observatories were founded between thirty and forty years ago, there was perhaps an over confidence in the excellence of the instruments employed, and in the certitude of being able to correct the observations to be obtained from them for every possible error. There was also the economical consideration connected with the expense of a double series of instruments, as well as the additional labour incurred in observing two instruments for the same purpose. The consequence has been, to take a single illustration, that no two observatories have given exactly the same law for the annual variation of the mean position of the magnetic needle. One observatory has contradicted another, the results from a good instrument have been balanced by those from a bad one, and in other cases it has not been possible to determine whether the differences found at two stations were really due to difference of locality only, or to instrumental causes.

When we remember the vast labour (to omit every other consideration) expended in obtaining the laws of magnetic variations, it cannot be too much regretted that every observatory was not furnished with a double series of instruments, which would have shown by their agreement or disagreement the accuracy or error of the results obtained from them. In the case of disagreement the director of the observatory would have been warned that some error existed whose cause should be sought out. No preliminary trials can ensure that an instrument will remain with exactly the same errors. If we could suppose that the captain of a ship would set sail on a lengthy and costly voyage with a single chronometer, without any means of verifying the accuracy of its going except the meeting with another ship in a like predicament, and should then find that, according to their chronometers, they were on opposite sides of the globe, we should have a parallel to a not uncommon case in the work of many magnetic observatories.

It is to be hoped for the future that such differences will not be allowed to exist, that each observatory will have the means of proving that, for its locality at least, the laws obtained are true, and that in publishing the observations, the differences of the indications of two instruments of each kind will be given with the most complete exposure of their errors and corrections.

JOHN ALLAN BROWN

*MARSDEN'S "NUMISMATA ORIENTALIA"*  
*Marsden's International Numismata Orientalia. Part II.*  
Coins of the Ursuki Turkomans. By Stanley Lane Poole, Corpus Christi College, Oxford. (London: Trübner and Co., 1876.)

THIS is the second part of the series of separate publications on the Early Coins of the East, of which the first part on Ancient Indian Weights was reviewed in NATURE, vol. xii. p. 24. The whole work is intended to be a new edition of Marsden's "Numismata Orientalia," but in consequence of the new form of the work and its enlarged character, the editor has changed its title into that of the "International Numismata Orientalia."

Part II. has been undertaken by Mr. Stanley Lane Poole, and treats of the Coins of the Ursuki dynasty. Ursuk was one of the petty chiefs of Syria during the wars of the Crusades, in which he distinguished himself, and was made Governor of Jerusalem, A.D. 1086. His descendants, the Ursuki princes, were amongst the most powerful chiefs in Syria and Mesopotamia, until the dynasty was brought to a close by the Tartar invaders, A.D. 1242. An historical sketch of the Ursuki family is given by Mr. Poole as an introduction to the account of their coins.

The series of Ursuki coins described in the work, the greater part of which are now in the British Museum, are mostly copper coins, a few only being of silver. Several plates with clear lithographic and photographic representations of the coins form part of the work. The coins all bear Arabic inscriptions, some of considerable length, and they appear to be of much historical value. In the description of the several coins in the text of the work the old Arabic inscriptions on each coin are given in the more modern Arabic character, according to the system of transliteration adopted in the book. These inscriptions are, however, intelligible only to Arabic scholars, as no English translation is given, which would have added considerably to the interest of the work for general readers.

At the commencement of the Ursuki dynasty the Mahometan moneys were of three classes—gold, silver, and copper, the respective units being the *dinar*, *dirhem*, and *fels*. But the Ursuki coins, both copper and silver, appear to be *dirhems*, this word appearing in the inscription of many of the coins, and showing that they were intended to pass as *dirhems*. Some of the copper coins have a thin coating of silver, and one has been gilded.

The Ursuki princes were amongst the few Mahometan dynasties that introduced images on their coins. But they rarely, if ever, engraved their own heads or those of their suzerains on their coins, choosing instead the types of the gold coins either of the Byzantine Emperors or of the Greek Kings of Syria.

The few silver coins of the series weigh about 44 grains, or 2.9 grammes each. The copper coins vary in weight from 43 to 163 grains, or 2.8 to 17.0 grammes.

The Arab systems of money and of weight are treated at great length in Queipo's "Systèmes Métriques et Monétaires des Anciens Peuples." The earlier gold unit was the *dinar*, and the later gold unit the *michtal*. The *dinar* was the monetary unit, from the Roman *denarius*. The *michtal*, which signifies weight, was the unit of monetary weight. Queipo gives a list of 263 gold dinars of the ancient Eastern caliphs which are now in various numismatic cabinets, with their weights. No coins were struck by Mahomet and his successors, who used the existing coinage of the countries, until the 78th year of the Hegira, when both gold and silver coins were struck by Abdelmelik, Caliph of Bagdad. The mean or normal weight of the gold *dinar* was 66 grains, or 4.25 grammes. This was the weight of the Attic drachma, from which it was evidently derived. There were also gold coins of  $\frac{1}{2}$ ,  $\frac{1}{3}$ ,  $\frac{1}{4}$ , and  $\frac{1}{5}$  *dinar*.

The relation of the weight of the Arab silver *dirhem* to the gold *dinar* was as 7 to 10, or nearly as 2 to 3. Queipo gives a list of 592 Arab silver *dirhem* coins of Arabian caliphs from A.D. 699 to 1195, with the weight of each coin. This varied from about 2.5 grammes in the earlier part of this period up to a maximum weight of 3.1 grammes in later times, the mean weight of the *dirhem* being 2.84 grammes, or 44 grains. He mentions also silver coins of  $\frac{1}{2}$ ,  $\frac{1}{3}$ , and  $\frac{1}{4}$  *dirhem*. The half *dirhem* was thus nearly equivalent to our Saxon penny, the  $\frac{1}{20}$ th of a pound of silver, and weighing 22 $\frac{1}{2}$  troy grains.

Queipo makes but little mention of the Arab ancient copper moneys, except to throw a doubt on the existence of the *fels* as a copper coin, and to assume that it was only money of account, and also that the number of *fels* in a *dirhem* expressed merely the number of units corresponding with the value of copper in relation to silver. He shows that in the first centuries of the Hegira, the value of silver to gold was as 1 to 13, and of copper to silver as 1 to 120. If, therefore, a gold *dinar* weighed 4.25 grammes, its equivalent in copper would weigh 6,630 grammes; and as the number of *fels* in a *dinar* could not have exceeded 98, that this would give the improbable weight of 67.65 grammes to each copper *fels*. This was the weight of the Attic drachma, from which it was evidently derived. There were also gold coins of  $\frac{1}{2}$ ,  $\frac{1}{3}$ ,  $\frac{1}{4}$ , and  $\frac{1}{5}$  *dinar*.

The relation of the weight of the Arab silver *dirhem* to the gold *dinar* was as 7 to 10, or nearly as 2 to 3. Queipo gives a list of 592 Arab silver *dirhem* coins of Arabian caliphs from A.D. 699 to 1195, with the weight of each coin. This varied from about 2.5 grammes in the earlier part of the period up to a maximum of 3.1 grammes in later times, the mean weight being 2.84 grammes, or 44 grains. He mentions also silver coins of  $\frac{1}{2}$ ,  $\frac{1}{3}$ , and  $\frac{1}{4}$  *dirhem*. The  $\frac{1}{2}$  *dirhem* was therefore nearly equivalent with our Saxon penny,  $\frac{1}{20}$ th of the pound of silver, and weighing 22 $\frac{1}{2}$  troy grains. Queipo makes but little mention of the Arab copper money, except to throw a doubt on the existence of the *fels* as a copper coin, and to assume that it was only money of account, the number of *fels* in a *dinar* expressing merely the number of units corresponding with the relative value of silver and copper. He

shows that in the first centuries of the Hegira the value of silver to gold was as 1 to 13, and of copper to silver as 1 to 120. If a gold *dinar* weighed 4.25 grammes, its equivalent in copper would be 6,630 grammes, and as the number of *fels* in a *dinar* could not be more than 98, this would give the improbable weight of 67.65 grammes to each copper *fels*.

#### VAN BENEDEN'S "ANIMAL PARASITES"

*Animal Parasites and Messmates.* By P. J. Van Beneden, Professor at the University of Louvain, &c. (London: Henry S. King and Co., 1876.)

THIS work forms the twentieth volume of the International Scientific Series. We believe there was some doubt on the part of the publishers as to the propriety of bringing out a popular treatise on so uninviting a subject. To have omitted all account of this important series of creatures considered in relation to the welfare of man would, however, have been a serious blunder. It is high time that popular prejudices should be ignored, especially when the welfare of the people themselves is involved in the question at issue. Fully alive to the prejudices referred to, a writer in *Notes and Queries* (who was probably anxious to make the subject palatable) says of this little book: "There is as much amusement to be derived from Prof. Van Beneden's pages as there is instruction." We cannot take this optimistic view of the matter; on the contrary, we fail to find anything amusing in the book, although, as might be expected from the author's known position as a man of science, there is much to be learnt from an attentive study of the text. Prof. Van Beneden's strength lies in a clear exposition of the phenomena of commensalism. We owe to his remarkable zoological acumen the correct interpretation of those singular phases of parasitic life which he has so happily classed under the rôle of Messmates and Mutualists, respectively. On this head he has strung together such a multitude of facts that his work cannot fail to be useful to working naturalists. Whether the general reader will find anything "amusing" in these pages is very doubtful. He may, indeed, if his mind be still dominated by the teachings of a certain school, find comfort in the assurance which M. Van Beneden affords that the welfare of all the most repulsive forms of insect life is most carefully looked after. What a comfort it must be for the poor Cayenne convict when tortured by insect parasites to know that the ever-helping "Hand" superintends the "preservation" of the larvæ of *Lucilia homini-vora* with the same care that it does "the young brood of the most brilliant bird." Surely the Mexican soldier who "had his glottis destroyed, and the sides and the roof of his mouth rendered ragged and torn, as if a cutting punch had been driven into those organs," could hardly be brought to realise the need-be for such a process of development on the score of benevolence towards this frightful parasite! The case of *Lucilia* is by no means exceptional, since there are scores of parasites, both external and internal, that are capable of inflicting the most terrible sufferings alike upon man and beast. Push our author's Bridgewater-treatise-like views to their logical outcome, and it necessarily follows that every pang endured by countless

suffering hosts was expressly designed in order that man might appreciate the benevolence of the "Creator." Such a conception is too horrible to be entertained by reasonable creatures; nevertheless, it is in perfect harmony with certain other grossly anthropomorphic conceptions of Deity that are too commonly taught amongst us.

The general reader will not be able to follow M. Van Beneden very closely, unless he possesses a considerable amount of zoological knowledge; and he will find the book overlaid with scientific terms. The naturalist, on the other hand, will be disappointed by the paucity of literary references. Whilst our author shows himself to possess a profound knowledge of the facts of commensalism, his volume is very deficient in the treatment of the subject of parasitism, properly so called, more especially when he deals with those forms that are known as Entozoa. He has omitted all mention of some of the most important helminthological contributions and discoveries of recent times. Thus, there is no allusion to Lewis's "find" respecting nematoid hæmatozoa, and almost nothing is said of the ravages produced amongst domesticated animals by a variety of well-known internal parasites. In some places our author misleads, as in the case of the history of the discovery of *Trichina*, where Sir J. Paget's name is altogether omitted; and also, in the case of *Bothriocephalus*, where Knoch's views on the possibility of infection without the necessity of an intermediary bearer appear to be countenanced.

Some of the illustrations are very poor, and the misspelling of authors' names and of technical words is exceedingly frequent. The author appears to be but little informed respecting the writings of German and English helminthologists. Notwithstanding these defects, M. Van Beneden's book ought to be purchased by every intelligent naturalist.

T. S. COBBOLD

### OUR BOOK SHELF

*The Scholar's Algebra: an Introductory Work on Algebra.* By Lewis Hensley, M.A. (Oxford: Clarendon Press; London: Macmillan and Co., 1875.)

THIS is one of the Clarendon Press Series, hence we are saved all necessity of remarking upon the get-up of the volume. We had hardly expected that Mr. Hensley could have imparted any freshness to his treatment of so hackneyed a subject as an Elementary Algebra, but he has done so, and we have read his work with much interest. It does not follow the usual course observed in similar treatises either in its contents or in their arrangement. Our author himself expressly states that the work professes to be an introductory one on algebra. He takes up the scholar who has been well-grounded in arithmetic and endeavours to explain from the outset what algebra is, what its aims, and what the chief forms of its utility. In this attempt he has succeeded, and the work is likely to be of use to students who are reviving an acquaintance with the subject acquired at school, but especially is it suited to self-taught students. For these latter it is, we think, one of the best text-books hitherto brought out. The first seventy pages are devoted to the symbols, signs, and elementary rules; in this section we have a good chapter on Ratio and Proportion, including a glance at incommensurables. Though treated at this length, the scholar is hardly likely to grow weary in his work, and he is laying at the same time a safe and solid foundation for future use.

In Part II. we have Algebraical formulæ (Interest, the Progressions), then Equations (Simple and Quadratic), next Investigation of Methods (Involution and Evolution), closing with a supplement on unknown quantities, Inequalities, Indices (fractional and negative). The third Part opens up to the student under Algebraical formulæ, Permutations, Binomial Theorem, Notation, Harmonic Progression, and simple series, then Equations (more advanced than the previous ones), Surds, Indeterminate Equations and applications of Horner's method. We have then a chapter on Continued Fractions<sup>1</sup> and another on Logarithms. Some idea of the character of the work will be got from the order and nature of the subjects above mentioned, and it will be seen that a prominent feature is the importance attached to methods of calculation. Indeed, Mr. Hensley says he has remarked in the Universities a growing disposition to compel the student of the higher mathematics to interpret his results numerically. To this he gives the weight of his experience: "There can be no better guarantee that he understands what he is about." We may mention that the extension of meaning of the negative sign and of symbols generally, though but slightly glanced at, is yet introduced to the reader's notice. No place is given to properties of numbers, multinomial theorems, convergency of series, higher series, or probabilities. The curriculum is much that laid down by the London University for candidates for the first B.A. (Pass), and we can recommend the book before us as one well suited for such candidates, as containing all they require, and but little beyond what they need take up for the examination.

We shall touch lightly here upon the errata. They are not very serious, and though somewhat numerous, do not by any means come up to the usual standard in this respect of first editions. On p. 98, line 5, for youngest read eldest; p. 127, last three lines, statements should be *vice versa*; p. 205, line 5 up, read  $7 \times 52$ .

### LETTERS TO THE EDITOR

[The Editor does not hold himself responsible for opinions expressed by his correspondents. Neither can he undertake to return, or to correspond with the writers of, rejected manuscripts. No notice is taken of anonymous communications.]

Fritz Müller on Brazil Kitchen Middens, Habits of Ants, &c.

[MR. CHARLES DARWIN has kindly sent us for publication the following letter, addressed to him by Herr Fritz Müller, the well-known naturalist, brother of our contributor, Dr. Hermann Müller, and who has for so long been devoting himself to natural history researches in Brazil.]

My dear Sir,—In Desterro I met with two young men (M. Charles Wiener, of Paris, and M. Carl Schreiner, from the National Museum of Rio) who, by order of the Brazilian Government, were examining the "Sambaquis" of our province. I accompanied them in some of their excursions. These "Sambaquis," or "Casqueiros," are hillocks of shells accumulated by the former inhabitants of our coast; they exist in great number, and some of them are now to be found at a distance of several miles from the sea-shore, though originally they were, of course, built near the spot where the shells lived. Some are of considerable size; we were told that a Sambaqui on a little island near San Francisco had a height of about 100 metres; but the largest I have seen myself did not exceed 10 or 12 metres. As to the shells of which they are composed, the Sambaquis may be divided into three classes, viz.: (1) Sambaquis, consisting of many different species of bivalve and univalve shells (*Venus*, *Cardium*,

<sup>1</sup> We observe that our author says that these were first used by Lord Brounker; it has been shown that Cataldi has a prior claim to this distinction.

Lucina, Arca, Ostrea, Purpura, Tritonium, Trochus, &c.), all of which are at present living in the neighbouring sea. (2) Sambaquis, consisting almost exclusively of a small bivalve shell, the "Birbigás" of the Brazilians (*Venus flexuosa*?), exceedingly common in shallow bays or salt-water lagoons, the bottom of which is of mixed mud and sand. (3) Sambaquis, consisting exclusively of a species of *Corbula*, which I have not yet seen in a living state; all the Brazilians also, whom I asked, and who are perfectly acquainted with any edible animal of their marine fauna, are unanimous in affirming that this shell does not live now on our coast. From one of these *Corbula*-Sambaquis I obtained a specimen of a small *Melampus*, which I have found living near the mouth of some rivulets, where fresh and salt water are mingling in ever-varying proportions. When the lowlands of the Lower Itajahy and some of its tributaries were as yet beneath the level of the sea, they would have formed a large estuary, and here probably the *Corbulæ* lived. The fragments of human skulls which we found in one of these *Corbula*-Sambaquis were of truly astonishing thickness, whereas those I have seen from other Sambaquis are hardly thicker than our own. Among the tools which are to be found in the Sambaquis, stone-axes are by far the most frequent. But as M. Wiener will probably soon publish a full account of his researches, I will now no longer dwell on this subject.

Some time ago I sent to Germany for publication a note on the relation between our *Imbauba* trees (*Cecropia*) and the ants which inhabit their hollow stem. As there may be some delay in publishing, I will give you a short abstract. Mr. Belt has already stated that the ants farm scale-insects in the cells of the *Imbauba* stem, and he believes that their presence must be beneficial. This is no doubt the case; for they protect the young leaves against the leaf-cutting ants (*Oecodoma*). Now there is a wonderful contrivance by which, as in the case of the "bull's-horn acacia," the attendance of the ants at the right time and place is secured. At the base of each petiole there is a large flat cushion, consisting of most densely-crowded hairs, and within this cushion a large number of small white pear-like or club-shaped bodies (specimens inclosed) are successively developed, which, when ripe, emerge at the surface of the cushion, like asparagus on a bed, and are then greedily gathered by the ants and carried away to the nest. The object of the dense hair-cushion appears to be (1) to secure to the young club-shaped bodies the moisture necessary for their development; and (2) to prevent the ants from gathering the unripe bodies. In most cases it is by honey-secreting glands that the protecting ants are attracted; now Mr. Belt observed ("Nicaragua," p. 225) that the honey-glands on the calyx and young leaves of a *Passion-flower* were less attractive to the ants than were the scale-insects living on the stems; this would most likely be the case with the *Imbauba*, and it is probable that the use of the little pear-shaped bodies is to form an attraction stronger than that of the scale-insects, and thus to secure the attendance of the protective ants on the young leaves. As far as I could make out, the club-shaped bodies consist mainly of an albuminous substance. The ant colonies are founded by fertilised females, which may be found frequently in the cells of young *Imbauba* plants. Each internode has on the outside, near its upper end, a small pit where the wall of the cell is much thinner than anywhere else, and where the female makes a hole by which she enters. Soon after this the hole is completely shut again by a luxuriant excrescence from its margins, and so it remains until about a dozen workers have developed from the eggs of the female, when the hole is opened anew from within by these workers. It would appear that the female ants, living in cells closed all around, must be protected against any enemy; but notwithstanding a rather large number of them are devoured by the grub of a parasitic wasp belonging to the *Chalcididæ*; Mr. Westwood has observed that the pupæ of the *Chalcididæ* exhibit a much nearer

approach to the obtected pupæ of the *Lepidoptera* than is made by any other *Hymenoptera*" ("Intro. to the Modern Classif. of Insects," Part XI., p. 162). Now the pupa of the parasite of the *Imbauba* ant is suspended on the wall of the cell by its posterior extremity just like the chrysalis of a butterfly.

I hope you will have received a paper on *Æglea*, a curious Decapod-inhabiting the mountain rivulets of our Serra do Mar. Lately I obtained a large number of specimens of this *Æglea*, and among them a female with eggs in an advanced state of development. Thus I was enabled to satisfy myself that, like so many fresh-water and terrestrial animals, the marine allies of which undergo a transformation, our *Æglea* does not experience any metamorphosis.

FRITZ MÜLLER

Itajahy, St. Catharina, Brazil, Dec. 25, 1875

## Prof. Tyndall on Germs

YOUR able correspondent "Inquirer" would hardly blame Horatius for taking his enemies one at a time. May I not, then, claim his indulgence for following, in an extremely humble way, the example of the gallant Roman? He may accept my assurance that during the last five months I have found Dr. Bastian quite enough for me.

Moreover, I do not think it likely that Dr. Sanderson and myself will ever cross swords upon this question. Our relation, I am happy to think, will be one of co-operation, not of antagonism. The experiments on pure infusions, not those on mixtures of solids and liquids, to which "Inquirer" directs my attention (*NATURE*, vol. vii., p. 180), are, in my opinion, too scanty, and too little in harmony with each other, to bear an inference of any weight. To Dr. Sanderson I prefer leaving the repetition of them, with the full confidence that the ability and candour for which he is so distinguished will lead him to a right result.

In repeating these experiments, it would, I think, be well to bear in mind the remarks of Dr. Roberts (*NATURE*, vol. vii., p. 302), however unimportant they may seem to Dr. Bastian. I would also suggest the substitution, in boiling, of an oil-bath for the Bunsen burner, and, in sealing, the abandonment of the blow-pipe and the use of the simple spirit-lamp flame.

Experiments on milk and pounded cheese are, it may be observed, at present beside the mark. They shall be subjected in due time to the scrutiny already bestowed upon really liquid infusions. It ought not to be forgotten that the jungle we have entered has been growing umbriferously for the last six years, and it is only bit by bit that the sunlight can be let in upon it.

"Inquirer" may count on my sympathetic readiness to minister, however humbly, to the delight he takes in following "every investigation which tends to the development of science." If he cares to see my infusions, it will give me great pleasure to show them to him. Condensed abstracts only of my investigation have been laid before the Royal Society and the Royal Institution; a fuller account of it will follow by and by. Meanwhile, I hope "Inquirer" will accept the assurance that I have been strict—I might say abject—in my adherence to the conditions prescribed by Dr. Bastian in his books.

JOHN TYNDALL

Heathfield, Feb. 13

[The following letter has been sent us for publication by Prof. Tyndall.—ED.]

PERMETTEZ-MOI de vous dire combien je suis charmé que vous apportiez dans la question de la génération spontanée la grande autorité de votre esprit philosophique et de votre rigueur expérimentale. C'est tout à la fois un honneur pour mes recherches et une vive satisfaction personnelle que les conclusions auxquelles vous êtes arrivé s'accordent si bien avec celles de mes propres travaux, malgré la différence des méthodes que nous avons suivies. Le tour piquant que vous avez su donner à vos expériences les fera pénétrer plus avant que les miennes dans l'esprit de tout lecteur que n'égarant pas les idées *à priori*.

Dans le numéro du 5 février courant du *British Medical Journal* le docteur Bastian accepte sans réserve l'exactitude de toutes les expériences de mon mémoire de 1862 (*Annales de Physique et de Chimie*).

Il accepte également, sans nul doute, les résultats de celles que j'ai publiés en 1863 et en 1872 sur le sang, sur l'urine, sur le jus intérieur des grains de raisin, exposés, dans l'état même où la vie a formé ces liquides complexes, au contact de l'air pur,

privé de ses poussières flottantes. Dès lors je dois appliquer au docteur Bastian ces paroles de mon mémoire de 1862, pages 70 et 71 : "En présence de ces résultats (résultats que je viens de rappeler et qu'accepte le docteur Bastian), un partisan de la génération spontanée veut-il continuer à soutenir ses opinions ? Il le peut encore ; mais alors son raisonnement sera forcément celui-ci : 'Il y a dans l'air, dira-t-il, des particules solides, telles que carbonate de chaux, silice, suie, brins de laine, de coton, fécule . . . et à côté, des corpuscules organisés d'une parfaite ressemblance avec les spores des mucidinées ou avec les kystes des infusoires. Eh bien, je préfère placer l'origine des mucidinées et des infusoires dans les premiers de ces corpuscules, ceux qui sont amorphes, plutôt que dans les seconds.'" L'inconséquence d'un pareil raisonnement ressort d'elle-même et le progrès de mes recherches consiste à y avoir acculé les partisans de l'hétérogénéité. Lisez attentivement l'article précité du docteur Bastian et vous verrez qu'il se résume en effet, dans le raisonnement que je viens de reproduire. Le docteur Bastian me permettra de placer dans sa bouche ces paroles :—"C'est bien vrai, les expériences de M. Pasteur et celles de M. Tyndall m'ont acculé, moi Docteur Bastian, partisan de la génération spontanée, dans cette déclaration. Oui, je préfère recourir sans motif sérieux, à la croyance à une force résidant dans la partie amorphe des poussières en suspension dans l'air" plutôt que de la placer cette force dans la partie organisée formée de corpuscules identiques d'aspect à ceux des germes des organismes des infusions." Parler ainsi n'est-ce pas avouer sa défaite ?

Quelles sont donc ces particules amorphes dont vous invoquez si gratuitement l'influence et de quel droit leur attribuez-vous le *primum movens* de la vie ? Pourquoi, si vous aviez raison, ne le trouverait-on pas ce *primum movens* dans les particules amorphes ou organisées qui existent à l'état naturel dans le sang frais, dans l'urine fraîche, dans le jus du raisin, quand on expose ces liquides dans l'air pur ? Voulez-vous que vos particules amorphes, douées du *primum movens* de la vie des infusions, sortent de matières déjà altérées, putrides, etc. . . . mais, pourquoi seraient-elles charriées par l'air sans être accompagnées des germes et des êtres vivants de ces infusions et, s'il en est ainsi, comment ne pas placer le *primum movens* de la vie dans ce qui est vivant, plutôt que dans ce qui n'a rien des caractères apparents de la vie ?

Elle est inattaquable, cette conclusion que j'ai déjà formulée : dans l'état actuel de la science, l'hypothèse de la génération spontanée est une chimère. Votre bien dévoué,

Paris le 8 Février, 1876

L. PASTEUR

#### Mr. Sorby on the Evolution of Hæmoglobin

IN the short notice in NATURE (vol. xiii. p. 257) of my paper on the Evolution of Hæmoglobin, in the *Quarterly Microscopical Journal*, it is said that my conclusions are mainly based on a small difference in the wave-length of the absorption-bands of the spectrum of the red blood of *Planorbis*. This is, however, a very small part of the question. The principal results are that hæmatin is first met with in the bile of many pulmoniferous molluscs in an abnormal state, quite unfit to serve the purposes of respiration, but easily changed into the normal, which could, and probably does in some cases, perform that function. Then in the blood of *Planorbis* we have a solution of a hæmoglobin, in which the hæmatin is combined with an albuminous constituent coagulating at the low temperature of 45° C., and finally we come to the normal hæmoglobin existing as red corpuscles, containing an entirely different albuminous constituent, coagulated at about 65° C. In all these changes in the condition of the same fundamental radical, the oxygen carrier becomes of more and more unstable character, and more fitted for the purposes of respiration, as we advance from lower to higher types, as though advantage had been taken of every improvement due to modified chemical or physical constitution. H. C. SORBY

#### The Flame of Common Salt

IN answer to a question put by one of your correspondents (p. 287), allow me to state that the origin of the blue flame in question is still involved in mystery. Your correspondent will find everything that is known on the subject in a letter addressed to the editor of the *Philosophical Magazine*, by Prof. J. H. Gladstone (*Phil. Mag.* 1862, vol. xxiv. p. 417).

Prof. Schorlemmer and I are at present engaged in a joint investigation, which we hope will throw some light on the origin

of the flame. We have already obtained interesting results, & observed the flame under circumstances in which it has not been seen before, but we are as yet entirely unable to say what the flame is really due to.

ARTHUR SCHUSTEL

Owens College, Manchester, Feb. 12

#### Science at Hastings

HAD we here a few more men like Mr. Alex. E. Murray, in my paper on "Science at Hastings" would never have been written. But I fail to see in what way he has "vindicated the honour of Hastings." With the exception of one or two sentences which require qualification, his letter is simply an emphatic repetition of what I said in the *Hastings and St. Leonards News*. The substance of my paper may be given in one of its sentences : "With the exception of occasional debates among the members of the Philosophical Society and the few scientific lectures in the winter programme of the Mechanics' Institution, there is in Hastings no public encouragement or aid to science. As to the Philosophical Society, Mr. Murray admits that, "owing to a variety of circumstances, it is not at present quite so flourishing as we could wish." In point of fact, during the session 1874-75, four papers were read and a conversation held. This Society is the only distinctively scientific one in the town, notwithstanding the "multiplicity" of institutions mentioned by Mr. Murray. Popular scientific lectures are occasionally given in connection with various associations for young men ; and the Mechanics' Institution also has a winter lecture session, but unfortunately the Committee find it very difficult to obtain lecturers, and are fain to eke out their list with musical evenings and readings. The Literary and Scientific Institution has for many years dropped the word "Scientific" from its name, and at present seeks merely to provide for a few of the older inhabitants of the town a quiet reading-room supplied with papers, a few reviews and magazines, and a box from Mudie's. Scarcely a new book has been bought for very many years. The meteorological instruments which the Institution "formerly possessed" were, with the exception of the barometer, broken long ago and the barometer has since been sold. At one time—twenty years ago—I was in the habit of taking the observations in the absence of the gentleman whose special business it was ; but it must be at least a dozen years since any observations were systematically taken.

In conclusion, I claim to have fully recognised in my paper all that is being done in Hastings in the interests of science, and I sincerely regret that Mr. Murray has not been able to discover any omission on my part. We have no museum, we have no public library in which there are scientific books recent or numerous enough to be of any use to a student, except in a school of two ; we have no Naturalists' or Field Clubs ; with the exception of the Philosophical Society, all the existing institutions in Hastings have practically lost what scientific character they may at one time have possessed ; and the Philosophical Society itself is neither exclusively scientific nor exclusively local in its aims, and is unfortunately "not quite so flourishing" as could be wished.

ARTHUR RANSOM

Hastings, Feb. 5

#### OUR ASTRONOMICAL COLUMN

THE VARIABLE STAR R LEPORIS.—This highly-coloured star, the variability of which was detected by Schmidt in 1855, is calculated to be at a maximum on the 28th of the present month. The mean period appears to be about 438 days, 230 days being occupied in passing from minimum to maximum, and 208 days from maximum to minimum. Probably the irregularities of variation which have been suspected are to be mainly attributed to the difficulty attending comparisons of a star of such intensely red colour. With regard to the colour, however, there is something more than a suspicion that it has sensibly diminished in intensity since attention was first directed to it (Hind, 1845, October). We are almost wholly indebted to Schmidt, who makes such excellent use of the favourable astronomical conditions under which he is placed at Athens, for our knowledge of the law of variation in R Leporis.





this condition are seen in the Marsupials, and in a still higher degree in the small order of Monotremes. These present a marked approach to the *Sauropsida*, or reptile and bird group. Such semi-transitional forms, as they may be called, furnish valuable indications of the route by which the higher types might have been brought about, and appear, upon the evolutionary hypothesis, to be unmodified survivors of a condition which was only transitory in the large bulk of the class. Their value as evidence for gradual development would be greatly strengthened if corroborated by palæontology. Beyond them nothing is known in the present condition of life of any truly intermediate forms between the Mammalia and the other class of vertebrates, and the same must be said, as far as we know at present, of all former ages. The line which we now draw round the class to separate it from all others will include within its limits all hitherto discovered mammalian remains. No forms more transitional, or approaching nearer to any other class, or even, as we shall see, so near as do the Monotremes, occur in the records of palæontology. Of course our evidence on the subject is only negative, and as such has little real value. The first appearance, of which we are at present informed, of mammals upon the earth, was early in the Mesozoic period, in the epoch called Triassic. At that time the other classes of Vertebrata, except, perhaps, birds (but our evidence here is defective), had long been well established and distinctly defined. Indications of mammalian life occur in various formations, at different ages, and at scattered points upon the earth's surface, throughout the Mesozoic ages, but during its later stages are entirely lost. These indications, though very fragmentary, all show animals of minute proportions, and for the class to which they belong, rather low organisation. With the commencement of the Tertiary period, however, a total change takes place. Wherever the great Cretaceous ocean bottoms have been elevated so as to become the fit habitation of terrestrial animals, there mammals of varied size, form, and function have been found to dwell, and have left their remains, and from henceforth to the present time there is abundance of evidence of their continuous occupation of the earth's surface. The total absence of all marine mammals in the Cretaceous epoch, the fauna of which is, on the whole, so well preserved, and the absence of land mammals in the Wealden, are facts, which though difficult to account for, must not be overlooked.

Before proceeding to the consideration of the history of the special groups of Mammalia, attention may be called to a few points of general interest relating to the whole class, in which palæontological researches appear to have shown some evidence of gradual modification or progression as time advanced. The first is a small point, as it relates only to one family of animals, but it affords a good illustration of the parallelism which has been observed between the development of the race and that of the individual. The earliest known forms of deer, those of the Lower Miocene, as remarked by Gaudry, have no antlers, as the young of the existing species. The deer of the Middle Miocene have simple antlers, with not more than two branches, as in existing deer in the second year. In the Upper Miocene, species occur with three branches to the antlers, but it is not until the Upper Pliocene and Pleistocene times, that deer occur with antlers developed with that luxuriance of growth and beauty of form, characteristic of some of the existing species in the perfectly adult state. Next, the teeth in the greater number of Eocene mammals, both herbivorous and carnivorous, were of a much more generalised character than at present, and, as shown by Owen, commonly presented the full typical number of three incisors, one canine, four pre-molars, and three molars in each side of each jaw, making forty-four in all, a number found only in two genera at present existing. These teeth, moreover, in

many species were more uniform in character and regularly placed, without intervals, in the jaws than in most of the later forms. They were also usually very short-crowned, and many cases can be traced of a successive lengthening of the crowns of the molars, and consequent greater provision for the wear of the organ, in a closely allied series of animals passing through successive geological epochs. Lastly, as remarked first by Dartet, and subsequently by Marsh, there has been in many groups a gradual increase of the size of the brain, as ascertained by the capacity of the interior of the cranium. Most of the Eocene mammals had very small brains in proportion to their size; this is well exemplified in the earliest known European Eocene carnivorous mammal, *Arctocyon primævus*, and still more strikingly in the huge American *Dinocerata*, animals nearly as large as the existing elephants, but whose brain cavity more resembles that of a reptile, being not more than one-eighth the capacity of that of a rhinoceros. The Miocene mammals of the same country had better developed brains, but even in the Pliocene Mastodons they did not equal the existing Proboscidea. A similar progression of brain capacity has been observed among deer, among the tapiroid Ungulates, and in a very well marked manner among equine mammals, especially from the Eocene *Orohippus*, through *Miohippus* and *Anchitherium* of the Miocene, *Pliohippus* and *Hipparion* of the Pliocene, to the recent *Equus*.

(To be continued.)

#### MADAGASCAR<sup>1</sup>

AS most probably many of our readers know, a wealthy Parisian, M. Alfred Grandidier, who is thoroughly acquainted with Madagascar in all its aspects, has undertaken a mighty work on the physical, natural, and political history of the island, which is to form, when completed, twenty-eight volumes in large quarto, profusely illustrated with coloured plates. Six volumes, three of text and three of plates, are to be devoted to the Mammals, the first of each of these being those under notice on the present occasion. They, together with the Birds, in three volumes, and the Crustacea, are under the editorship of M. Alph. Milne-Edwards. The Fishes are undertaken by Dr. Sauvage; the Reptiles by M. Grandidier; the Insects by MM. Kunckel d'Herculeas, Lucas, Oustalet, De Saussure; the Annelids by M. L. Vaillant, and the Mollusca by MM. Fisher and Crosse.

In the volumes before us there are 122 plates devoted to the anatomy of the Lemurian family *Indrisina*. *Propithecus diadema*, *P. edwardsii*, *P. verreauxii*, *P. deckenii*, *P. coquerelii*, *P. coronatus*, *Avahis (Micro-rhynchus) laniger*, *Indris brevicaudatus* are the species figured. Of these plates, thirty-nine refer to their osteology, more than twenty to their myology, forty to their visceral anatomy, thirteen to their external form, and twelve (as photographs) to the configuration of the feet. Most of these plates are exquisitely coloured, and all are beautifully drawn; the livers being the only organs with which we have any fault to find. The volume of letter-press only extends as far as the myology, the account of the viscera not having yet appeared. It is to do so in March next. From the drawings alone many particularly instructive facts may be learnt. The colic caecum of *Propithecus* is seen to be comparatively short and capacious, at the same time that the helix formed by the convolutions of the colon itself is as considerable as in any ruminant animal. In *Avahis* the helix is much less developed, whilst the caecum is longer. In *Indris* the caecum is enormously long, not being wide, the colic coil not forming a helix, but being disposed in parallel

<sup>1</sup> "Histoire Physique, Naturelle et Politique de Madagascar." Publiée par Alfred Grandidier. "Histoire Naturelle des Mammifères." Par MM. Alph. Milne-Edwards et A. Grandidier. Vol. VI. (texte) et Vol. IX. (atlas). (Paris: Imprimerie Nationale, 1875.)

transverse rows. The liver of *Avahis* is represented without any gall-bladder (it may be embedded), this viscus being large, and having, as in the typical lemurs, its fundus reversed from its ordinary position, and buried in the hepatic issue in the two other genera. The caudate lobe of the liver is absent, and the spigelian is of fair size. These points, it may be mentioned, have been previously recorded by Prof. Flower in his Hunterian Lectures before the College of Surgeons in 1872, on the visceral anatomy of the Mammalia. In *Propithecus* the left subclavian artery is shown to be given off from the innominate trunk, whence spring the three other main anterior vessels, whilst in *Avahis* and *Indris* it springs independently from the aorta. As in the other Lemurs and the Swine, the mesenteric arteries run straight to the walls of the viscera they supply, and do not form loops just before they reach them; they anastomose freely at their origins.

M. Milne-Edwards gives as the dental formulæ of the Indrisinæ the following:—

$$\text{Milk dentition} \quad . . . \quad i \frac{2}{2} c \frac{1}{1} m \frac{2}{3} = 22$$

$$\text{Permanent dentition} \quad . \quad i \frac{2}{2} c \frac{1}{0} p m \frac{2}{2} m \frac{3}{3} = 30$$

Whether or not this method of expressing the dentition is correct is a matter of uncertainty, it depending on the nature of the outer lower cutting teeth of the typical Lemurs. We cannot, with many zoologists, help retaining the opinion that the outer lower incisor-like teeth of *Lemur* and its nearest allies are canines, and they most certainly represent the outer pair in *Indris*, in which they are larger than the inner. The presence of a third lower milk molar confirms the opinion expressed by Prof. Huxley<sup>1</sup> in his memoir on the Angwántibo (*Arctocebus calabarensis*), that in the adult Indrisinæ it is a premolar which is missing in each semi-jaw.

M. Milne-Edwards gives elaborate measurements of the bones of the three genera, which are also represented in the graphic form, on ordinates, by which means excellent comparisons can be made at a glance.

In the myological section of the work, the contributions by Vrolik on *Stenops*, Messrs. Mivart and Murie on *Nycticebus* and the Lemuroidea generally, Van Campen and Van der Hoeven on the Potto, Burmeister on *Tarsius*, and Prof. Owen on the Aye-Aye are employed for comparison, and the whole monograph has filled the only important gap, till now vacant, in our knowledge of the anatomy of the Lemurs.

### SCIENCE AND ART IN IRELAND

AN important announcement as to the proposed action of the Government with regard to the various scientific institutions in Dublin is contained in the following article, which we reprint from the *Times* of Tuesday last:—

The subject of the administration of Science and Art in Ireland in connection with increased State aid has now been under discussion at different times for many years. It must not be imagined, however, that Ireland is not already provided with numerous institutions for the promotion of Science and Art, or that it lacks grants for that purpose. In Dublin alone there are under the management of the Royal Dublin Society, which is a chartered body, a Museum of Natural History, Botanic Gardens (with Botanical Museum), and a library. Next comes a purely national institution, the Royal College of Science, with its small industrial collections and the geological collections of the Geological Survey. On the borderland of Science and Art we have the Royal Irish Academy, with its library and Antiquarian Museum, containing the richest collection of Celtic antiquities existing out of Copenhagen, including the celebrated Tara Brooch and Tara "torques," and the Cross of Cong.

<sup>1</sup> Proc. Zool. Soc., 1864, p. 327.

Coming to the region of Art pure, we have the School of Art, under the management of the Royal Dublin Society; the Royal Hibernian Academy, corresponding to our own Royal Academy (which also has its School of Art); and lastly, the Irish National Gallery. So far as we can gather from the estimates, the total grant to Science and Art Institutions in Dublin is upwards of 25,000*l.* a year, though it is difficult to obtain very precise information on this head, as the votes are taken, some by the Science and Art Department, some by the Treasury, and some by the Office of Works.

The Library, the Natural History Museum, and the Botanic Gardens have since 1865 been entirely supported by the State, though managed by the Dublin Society acting as trustees, while the collections of the Royal Irish Academy, which receive an annual subsidy of about 2,000*l.* besides a house, have been very largely purchased out of public funds. The Royal Dublin Society has of late years devoted its energies and its private funds most usefully in furtherance of agriculture. The Royal Irish Academy not only covers the field of the Royal Society of England, but also takes under its care literature and antiquities.

It will thus be seen, to compare the State supported institutions in Dublin with those in London, that the elements of the British Museum, the Geological Museum, the South Kensington Museum, the National Gallery, and Royal Academy exist in Dublin, to say nothing of the Royal College of Science, which has a more complete course than our own School of Mines. In spite, however, of the number of these institutions, and, in fact, because of their number, the collections, whether of books, natural history specimens, or antiquities, have not had the completeness which one would expect. While on the one hand many have been inconveniently housed, on the other the Government has naturally felt a difficulty in improving their condition so long as they were in the hands of more or less irresponsible private bodies, and hence the many attempts to bring about a consolidation, to which we may briefly refer.

Thus we find that in 1862 the Treasury appointed a small Commission, with Sir C. Trevelyan as chairman, which made certain recommendations. Before these were acted on, however, the subject was, in 1864, taken up by a Committee of the House of Commons, of which Mr. Gregory was chairman. This body dissented widely from the views expressed by the Treasury Commission, and thus the matter rested till 1868, when the Government decided to constitute a separate Department of Science and Art for Ireland, "analogous in its constitution to the existing Science and Art Department in London for the United Kingdom;" and appointed a Committee, of which the Duke of Leinster, then Marquis of Kildare, was chairman, to report on the best means of carrying out the project.

The Committee, having upon it such representative Irish members as the Marquis of Kildare, the Very Rev. Dr. Russell, the then President of Maynooth, the Rev. S. Haughton, and Mr. G. A. Hamilton, the then Secretary of the Treasury, soon found it impracticable to organise such an independent department as had been contemplated, and applied for an enlargement of their instructions; in fact, it became evident very early in the inquiry that all but a small minority in Ireland were in favour of continuing the connection with the English Department. Teachers and students specially petitioned that the connection might be maintained, as they saw clearly that the severance would deprive them of the highest rewards and best promises of a career by cutting off the English field from them. However much some may regret the fact, the fact remains that in all vocations the highest talent will seek the place where it is most highly prized and rewarded, which in the case of the United Kingdom means London.

Acting upon this and other considerations, to which we need not further allude, the Commission unanimously came to the conclusion that the remedy they were seeking lay, not in the formation of a separate Department for Ireland—which, indeed, they went on to say would be detrimental to the interests of Science and Art in that country—but in the consolidation and better administration of the existing institutions, and in the filling up of some obvious gaps. The essence of their recommendations was the amalgamation of several of the collections into an institution strongly resembling the South Kensington Museum, but covering a wider field, which should be administered by a director, who should be in immediate relation not only with the Minister of Education, but also with the Irish Government. This scheme, however, had a great drawback in the eyes of many of the leading noblemen and gentlemen in Ireland who were interested in the existing institutions, because it entailed the deprivation in the case of the two principal societies—the Royal Dublin Society and the Royal Irish Academy—of the privileges they had hitherto enjoyed of administering large public funds voted for the Natural History Museum and the Botanic Gardens, as well as other institutions. This objection and, possibly, the economical views of the late Government, have sufficed to keep this question in abeyance since 1868; but it now appears that the present Government have determined to take some decided step, for they have, we understand, during the last few days communicated with the bodies principally interested in the scheme.

From the information which has reached us we gather that the plan now proposed is as complete as that indicated by the Commission of 1868, although it is not identical with it. Thus it has been decided to build a Science and Art Museum for Ireland similar to that now existing in Edinburgh. This will occupy a site adjacent to the principal buildings which now exist, and will consist of collections analogous to those of the South Kensington Museum, to which will be added the antiquarian collection of the Royal Irish Academy, and the industrial collection of the old Museum of Irish Industry. The building will also provide space for the Natural History Museum and Geological Collection, and will thus set free the present Natural History Museum, to which the library of the Royal Dublin Society will be transferred and formed into a public National Library.

As may be imagined, this comprehensive scheme will entail the expenditure of a large amount of public money, and the Government make the offer contingent on the surrender of the privileges to which we have before referred, and the vesting of all the property in the Government. With the view, however, of still enabling those who at present take so great an interest in the existing institutions to continue this useful co-operation and represent the special wants of the country, it is proposed that the new National Library shall be managed by a Council of twelve trustees—eight to be nominated by the Royal Dublin Society and four by the Government; while the administration of the Science and Art Museum, which is to be under a director appointed by the Crown, as in Scotland, will be controlled by a Board of twelve visitors—four nominated by the Lord Lieutenant; five by the Royal Dublin Society; and three by the Royal Irish Academy.

It is not proposed to interfere with the functions of the societies we have named, and we are glad to see that the Government propose still to continue the aid they now give to them.

In making these proposals the Government has taken the opportunity of putting on record its appreciation of the eminent services which have been rendered to both art and science by the societies we have named, and makes it clear that the motive for suggesting any diminution of their independence is, that the wants of the com-

munity with regard to such matters as public museums have now in Ireland, as long ago in England, outgrown the useful operation of private societies.

The surrender of what we may, we hope, without offence, term some of their ornamental functions, will no doubt be somewhat painful to their members; but we cannot suppose that they will allow their private feeling to stand in the way of a national scheme so rich in promise, and based on principles which we should be glad to see applied in other localities besides Dublin.

#### MINIATURE PHYSICAL GEOGRAPHY

THE sands of the Lower Bagshot series are exposed along the shore at Bournemouth and form the cliffs. They are agglutinated into a very friable sandstone, which

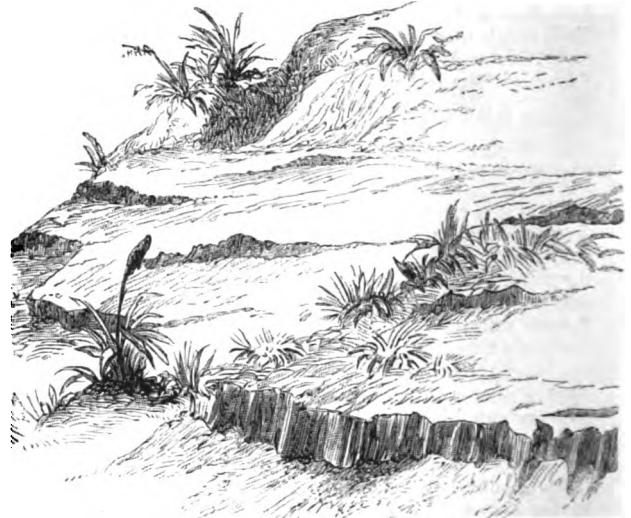

FIG. 1.

disintegrates under the influence of rain with extreme readiness. The siliceous grains are cemented together, probably by carbonate of lime. At any rate the adhesion of particle to particle is very slight and easily relaxed.



FIG. 2.

The result is that phenomena of erosion which elsewhere take years, centuries, ages, display themselves here on a miniature scale, and in a very short space of time. All the details of a river drainage system may be seen

with perfect completeness in the space of a few square yards. Watersheds bounding contiguous basins, gently sloping plains, deeper valleys, steeply cut ravines may be recognised according as the rock varies here and there in more or less of cohesiveness.

The slight inequalities in this respect give rise to many other details worth noticing. On the vertical surface of the cliffs the rock is etched in a manner scarcely perceptible unless the sun shines obliquely on its surface. In this way a rock apparently homogeneous is seen to have been originally built up of layers deposited at the most various angles in the manner characteristic of what is called false bedding.

Here and there an undisturbed talus at the foot of a cliff has been permeated by water carrying some cementing material which feebly binds together again the incoherent sand. The base gets washed or blown away, and the surface of the talus is seamed with miniature landslips leaving steep and precipitous cliffs of the frightful height of at least two to three inches. These precipices are scored and columned with the sharpest fluting as they have been planed down by the subsiding soil (Fig. 1 reduced).

Here and there again the rock is traversed horizontally by layers, in which the cementing material is ferruginous. When the rock is denuded down to this it first gets washed pretty bare and then broken up into angular fragments by the frost. Each of these fragments protects the rock beneath, and so gradually gets mounted upon a little pedestal like the perched blocks of a Swiss glacier or the mud columns in the valley of Visp (Fig. 2, natural size).

T. D.

#### PHYSICAL SCIENCE IN SCHOOLS

THE struggle which Physical Science has had to obtain a footing amongst the regular subjects of the school curriculum has not been altogether in vain, and the study of science now occupies a conspicuous place in the prospectus, at any rate, of many of our schools. But to those who, being behind the scenes, are acquainted with the real facts, the position which science occupies amongst other subjects, with a few honourable exceptions, is insignificant in the extreme. It is admitted as an axiom by all science teachers, that if the study of science is to be of any value, the student must, in some part at least of his work, be brought face to face with the facts of nature, and that unless this be the case the introduction of the subject into the school course is worse than useless; but how commonly does the so-called science-work of a school consist simply in the acquisition of so much "useful knowledge?" And even when in other respects the teaching is fairly satisfactory, the practical work is too often optional—an "extra," or taken on half-holidays, and so ruined by the competition of cricket and football.

We believe that a fair standard by which to judge of the present position of the study of science in schools is to be found in the "Regulations of the Oxford and Cambridge Schools Examination Board," and in the papers set at the examination for certificates (the first held) of July 1874. Certificates are awarded to those who succeed in passing in a certain number of subjects; and the possession of such a certificate should indicate that a boy has obtained a thorough education up to the point fairly to be expected on leaving school.

Regulation 7 provides that "the examination for certificates shall include the following subjects:—

"GROUP I.—(1) Latin; (2) Greek; (3) French and German.

"GROUP II.—(1) Mathematics (Elementary); (2) Mathematics (Additional).

"GROUP III.—(1) Scripture Knowledge; (2) English; (3) History.

"GROUP IV.—(1) Natural Philosophy; (2) Heat and Chemistry; (3) Botany; (4) Physical Geography and Elementary Geology.

Every candidate shall be required to satisfy the examiners in at least four subjects, taken from not less than three different groups."

From the foregoing Regulation, one would naturally suppose that equal value was attached to each of these subjects, an arrangement which would leave no room for the complaint that science did not receive its proper credit. Let us examine whether such is the case.

The examination papers show that out of more than fifty-two papers set, *only four* were set on scientific subjects. To pass in Latin it would seem that *five* different papers must be satisfactorily answered, in Greek *four*, in French and German *eight*, in Elementary Mathematics *three*, in Additional Mathematics *four*, in Scripture Knowledge *three*, in English *three*, in History *one*, in Natural Philosophy *one*, in Heat and Chemistry *one*, in Physical Geography *one*, in Botany *one*. We may not unfairly take these numbers as representing the relative value of the different subjects in the eyes of the compilers of the Regulations.

Thus, while a candidate who, having received his training in languages, selects, say Latin, French and German, English, and Elementary Mathematics, has to answer nineteen papers—the same certificate may be cheaply obtained from *seven* papers, by selecting Scripture Knowledge, Elementary Mathematics, Chemistry, and Physical Geography.

Next let us examine the kind of questions set. Elementary Mathematics means simply Arithmetic, Euclid, books i. and ii., and Algebra to simple equations. In Heat and Chemistry we find the following, amongst others (space does not permit to transcribe the whole paper).

1. Define "co-efficient of expansion." What relations subsist between the linear, superficial, and cubical expansion of a piece of iron?

2. Describe fully the successive changes which occur when a piece of ice is placed in an open vessel, and the vessel then gradually heated to, say, 150° C.

3. What are our available sources of heat?

4. What degrees on the Centigrade scale correspond to 16° R. and -4° F.? At what temperature will Fahrenheit and Centigrade thermometers give the same reading?

5. Distinguish between elements and compounds, and between compounds and mixtures.

6. What is the composition of the atmosphere? Give the outlines of a method for analysing it accurately. How is it proved to be a mixture and not a chemical compound?

7. I want to convert 132.4 grm. of lead nitrate into lead sulphate. How much potassium sulphate will effect this change, and how much lead sulphate shall I obtain? (Pb = 207, K = 39.)

In Physical Geography:—

1. How may the earth be proved to be a globe, and in what respects does it differ in form from a perfect sphere?

2. Show by examples how climate is affected by the position of a locality independently of the latitude?

3. Define the terms *watershed*, *denudation*. Give instances of denudation effected by rivers.

4. Explain the terms *dip*, *strike*, *joints*, and *faults*.

5. What is supposed to be the origin of coal, and on what facts is this supposition based?

6. Name and describe fully the accompanying specimens:—

[Specimens: Granite, oolite, dolomite, selenite, and two bivalve fossils.]

It is to be remarked that, with the exception of the last question, there is no test of a practical kind at all. Is the knowledge of the composition of the air, of the reasons for believing that the earth is round, of the meaning of the terms *watershed*, *dip*, &c.—is this the utmost that should be demanded of a boy of eighteen who has studied science instead of the older well-established subjects of classics and mathematics?

Compare with this the extent of knowledge expected in other subjects. French and German, for example, together form one subject: to succeed, the candidate must be proficient in dictation in each language; translation from unseen authors; the grammar, history, and etymology of the languages; translation from English into French and German, besides translation from books appointed. For the last examination, books which might be chosen were—in French, Pascal's "Provincial Letters;" in German, Goethe's "Faust" and "Italiänische Reise."

The relative value attached to different branches of science is also worthy of remark. Chemistry, for example, is supposed to be so far inferior to Botany as an educational study, that the slight subject of *Heat* is added as a make-weight.

It is really hard to determine whether the compilers of these Regulations (the head-masters of one or two of our most important schools being amongst them, if report errs not) have acted simply in ignorance of what physical science in a school ought to be, or whether this is an ingenious device to strangle science as a school study, and to get rid of the obnoxious interloper by driving the weak and idle to it, and thus giving it a bad name as "the refuge of fools."

N. MARSHALL WATTS

#### PROF. MAX MÜLLER

IT was decided at a Convocation held at Oxford on Tuesday that an inducement should be offered to Prof. Max Müller to continue to honour Oxford by remaining connected with that University. It would certainly have been a disgrace had no effort been made to retain the services of so eminent a scholar, which other countries are eagerly anxious to obtain. The proposal made by the Dean of Christ Church, which was carried by a large majority, was to relieve Prof. Müller of the obligation to lecture, and to provide for the appointment of a deputy, who should receive one-half of the salary of the present Professor. This scheme is confessedly somewhat of a makeshift; time was of importance, and the proper course, by statute, because lengthy, was not available. Vienna had offered the Professor a Chair of Sanskrit and provision for the publication of his books; and to this offer an immediate answer was necessary. The present, the Dean wished it to be understood, was a provisional arrangement in view of impending changes. The Dean was authorised to state that the Government "Universities" Bill would constitute an Executive Commission, with powers to receive schemes from Colleges, and to base upon them the new University and Collegiate organisation. He pledged himself there should be an opportunity given for considering in constitutional form the permanent arrangement of the matter at present in hand. He defended the decree from the charge of robbing Comparative Philology, for Sanskrit studies were an essential part of it, and the arrangement would give an admirable opportunity for some young man to make out his claim to the Professorship. He could have wished the arrangement had been more liberal, but, in fact, the University had come to the end of its tether. The Dean then dwelt on the high value of the Professor's services. He told how Mr. Max Müller had "audaciously" projected, when but a youth and a pupil of Burnouf, an edition of the Rigveda. For this he was forced to come to England, for which purpose he raised funds by translations, &c. Bunsen, on whom he called without introduction, had forwarded him to Prof. Wilson, and the India House, with sagacious liberality, took him up. Dean Gaisford had bidden men read Homer, with some ancient commentator, as the key to Greek literature. If these had been only accessible in manuscript, involving the reading, indexing, and perpetual annotation of infinite other MSS., who would have undertaken the task? And this was what Max Müller had done. Dean Liddell knew not whether to admire and

wonder at most—his ardour in commencing, his perseverance in continuing, or his genius in the execution of his work. With regard to a recent statement as to Prof. Müller's future work, the Dean stated the fact to be that the University had accepted the offer of publishing a choice selection of translations from Sacred Books—at the utmost, twenty-four volumes. But this, it was obvious, was sufficient to prevent the Professor from enjoying the position of a sinecurist. The Dean concluded by enumerating a list of the Professor's distinctions, and urged the University to keep him if it could, how it could, while it could.

We must say that most of those who spoke in the discussion which followed missed the real point at issue. Prof. Max Müller has already rendered such important services to Oxford, to England, and to Science, and proved himself so competent to continue these services, that there should have been no hesitation whatever about endowing him sufficiently to enable him to continue his valuable researches unhampered. But we must be thankful for small mercies at present, hoping from the hint dropped by the Dean that better things are in store.

#### PROF. NORDENSKYÖLD ON THE JENISEI<sup>1</sup>

I HAVE before mentioned the great abundance of extraordinarily delicate varieties of fish which Jenisei yields, and that during our river journey we made as complete a collection of them as possible. The steamer's tedious voyage was, besides, employed by me in collecting statements regarding the names of the most important varieties, the price paid for them on the steamer, and their size.

	Common weight.		Greatest weight.		Price.
Njelma <sup>2</sup>	... 13 lb.	...	50 lb.	...	80 kop. per pood.
Tschir	... 6 "	...	25 "	...	10 " each.
Omül	... 1½ "	...	3 "	...	2 " "
Muksum	... 4 "	...	12 "	...	9 " "
Salmon	... 16 "	...	80 "	...	— " "
Sterlet	... 3 "	...	30 "	}	... 150 kop. per pood.
Sturgeon	... 16 "	...	280 "		
Silj	... — "	...	— "	...	40 " "

The trade, however, is carried on here in this way, that the goods to be purchased are valued in coin, but payment is made in goods at the merchant's valuation, on which account the true price is perhaps considerably below that which is here stated.

After the numerous crew on the *Alexander* and the "lodjors" had attended with great devoutness a festival service in the church of the monastery and a neighbouring chapel where the holy founder's dust and work-harness are preserved, after we had seen several of the remarkable things belonging to the monastery, and among them an exceedingly well-preserved Slavonic Bible from the sixteenth century, and after I had paid a visit, along with the captain, to an aged cripple who in his youth had made a pilgrimage to Jerusalem, we steamed on. Our progress, as was commonly the case, was slow, in consequence of the strong current and the frequent stoppages, which of course we turned to account by making excursions to examine the natural history of the region, by conversing with the inhabitants, &c. The latter consist partly of Russians who have settled there, partly of natives, "Asiatics," who frequent the rivers during summer, partly on their own account, partly as employed by Russians. In such circumstances their dwellings consist of tents of quite the same form as the Lapp "kota." The Samoyede tent is commonly covered with reindeer skins, the Ostiak tent with birch bark. A number of dogs are always found in the neighbourhood of the tent, which during winter are used for general draught purposes, and in summer for towing up boats against the current—a means of transport on water which greatly surprised our seal-fishers. For this purpose a sufficient number of dogs are harnessed to a long line, one end of which is fastened to the stem of the boat. The dogs then go forward upon the level bank, where in this way

<sup>1</sup> Continued from p. 277.

<sup>2</sup> Njelma, Tschir, Omül, and Muksum are varieties of the Gwyniad. Silj is the fry, or young, of the same fish.



true dog-tracks are formed, and the boat, which requires only a moderate depth of water, is kept afloat at a sufficient distance from the bank by the rudder, which is managed by a person sitting in the stern of the boat. The boats are often hollowed out of a single tree stem, and may be notwithstanding, thanks to the dimensions the trees attain in these regions, of very beautiful form and very large. The dogs have a strong resemblance to the Eskimo dogs in Greenland, which are also employed as draught animals, which may perhaps be considered a proof that the same climatic circumstances and a similar method of employing a species of animals create like races. Most of the natives who come into intimate contact with the Russians at the present time, we are informed, profess Christianity. That many heathen customs still, however, cleave to them is shown by the following incident. At a "simovie" where we landed for some hours on Sept. 16, we as usual came upon a burying-place in the wood near the dwelling-houses. The corpses were laid in large coffins above ground, with a cross in nearly every case raised over them. At one of the graves there was a consecrated picture fixed to the cross, which must be considered an additional proof that a Christian reposed in the coffin. Notwithstanding this, several garments, which had belonged to the deceased, were found hanging on a bush near the grave, together with a bundle containing food, principally dried fish. At the graves of the richer natives we are informed that the survivors place, together with food, some rouble notes, in order that the departed may not be altogether destitute of ready money on his entrance into the other world. But that fine clothes are not considered any special recommendation with St. Peter was evidenced by the exceedingly shabby, tattered, and patched condition of the garments hung up at the grave in question.

Hitherto we had during our journey from Dudino up the Jenisei for the most part very fine, often warm, autumn weather. The first frost occurred south of Saostrovskoi on the night before Sept. 20, and from that date the temperature of the nights was generally under the freezing point. The days, however, continued to be warm and fine. The fall of rain was slight.

On the 20th we anchored at the mouth of one of the largest tributaries which fall into Jenisei from the east, viz., Podkamennaja Tunguska. Immediately below a welcome opportunity offered of taking soundings right across the river, which is here over a kilometre broad. A little distance from the western bank the lead showed four fathoms, afterwards the depth again diminished to 2½ fathoms, but afterwards increased anew to seven fathoms. At a number of other places also soundings were taken, which are believed to confirm the statement of the pilots that the depth of the river as far up as Jeniseisk is sufficient even for large vessels. However, in order to establish this with complete certainty, and to discover the most convenient channel for navigation, much more complete hydrographical surveys are required than those which we had an opportunity of making in passing.

As I have already mentioned, productive potato land and cabbage plots are to be found at the Skoptists' Colony, north of the Arctic circle, and the farther south we came, the more such patches of cultivation increased in size. No proper cultivation of grain is met with until we reach Sykobatka, situated in lat. 60°, but in the future it is quite certain that *when the woods and morasses are diminished*, a profitable agriculture may be carried on much farther north. Already from this point to the southern boundary of Siberia, or more correctly to the *steppe* lands of Central Asia, we have at most places more than 100 Swedish miles (1,000 kilometres), and if we consider that a belt of land of this breadth, for the most part covered with excellent, easily cultivated soil, extends right across the whole of Asia from Ural to the Pacific Ocean, we may form an idea of the immeasurable field of conquest for the plough of the cultivator which these regions offer, and the future which some time must open up for it.

Immediately south of Sykobatka we passed the church village Nasimovskoi, and a deserted gold-washer's "residence" lying right opposite, named after the first conqueror of Siberia, Jermakova. The "residence" originated in the discovery of beds of sand rich in gold in the pretty extensive territory of a tributary of Jenisei on the east of that river, which before the Californian discovery was renowned as the richest gold district of the globe. In a short time many colossal fortunes were made here, and the stories of the hundreds of *pounds* which one or another yearly washed, and the reckless, riotous mode of life of those whom fortune allowed to win the great prizes in the gold-washing lottery, still forms a favourite subject of conversation in the

region. Heightened rates of labour and diminished supplies of the noble metal have, however, of late, led to the abandonment of a number of the washings which formerly were most profitable, and the others scarce pay for the working. Many of the gold washers who were formerly rich, have, in the attempt to increase their wealth, been ruined, and disappeared; and others who succeeded in retaining their *pound* of gold—that is the mint-unit that the gold washers prefer to employ in conversation—have removed to Paris, Petersburg, Moscow, Omsk, Krasnojarsk, &c. All the "residences" are therefore now deserted, and form on the eastern bank of the river a row of half-decayed wooden ruins surrounded by young trees, after the disappearance of which in a short time only the tradition of the former era of prosperity will be found remaining. In one respect, however, these gold-washers have exercised a lasting influence on the future of the country; for it was through them that the first pioneers were spread in this desolate land, the first seed sown of the cultivation of the region.

At many places along the river there is to be seen besides another peculiar memorial chiefly from the time when thousands of labourers were collected at the gold-washings, viz., colossal flat-bottomed boxes formed of logs, which are here called "barks," which lie drawn up on the banks, more or less decayed. They were used for the transport of the necessaries of life on the river from Southern Siberia, and an idea may be formed of the calm flow of the Siberian rivers and their suitability for water communication, from the fact that in this way goods were transported as far as the most northerly "simovies" on the Jenisei, on the main river, from regions situated south of Minusinsk, near the Chinese frontier and along its tributary the Angara from Lake Baikal; in fact, still farther, for even the river Selenga, which falls into Lake Baikal from the south, is navigable for a good part of its course. In order, however, to sail up these rivers from Jeniseisk there are required, as I have stated before, some operations for clearing the channel, but they are inconsiderable in comparison with the importance of the object. "Barks" of average size, built for the carriage of grain from Minusinsk, cost 300 roubles, load up to 130 tons, and are managed during the voyage down the river by fifteen men. After reaching their destination they are sold, in case a buyer can be found, for a few roubles. Notwithstanding their awkward shape they are well adapted for the river communication in question, and they would be still more so if during the down voyage of a considerable train formed of twenty or thirty of such craft, a small steam-tug could be had like those that are employed in the Archipelago of Stockholm. In this way the crew on each "bark" might be reduced to one-third; and the freight, which is already low, be farther reduced.

Since Sept. 20 night frosts had often occurred, which naturally considerably diminished the results of our excursions at the steamer's stopping places. We became therefore more impatient to reach our nearest destination. The strong current and the frequent stoppages delayed our journey, so that it was not until Sept. 30 that we could anchor at the town Jeniseisk. Here we stayed some days for the purpose of getting news from Europe, examining the fine collections made in several branches of natural history by Herr M. Marks, an exile, and settling our affairs; in connection with which I ought specially to mention that the owner of the *Alexander*, Herr Balangin, declined to receive any payment for our long voyage in the steamer, on which I made over instead, as a memorial to him and the excellent master of the steamer, Herr Jarmerieff, the Nordland boat, in which we began our river journey, and which had afterwards been brought hither in tow.

We then proceeded on our return journey by land through Krosnojarsk, Tomsk, Omsk, Tjumen, Ekaterineburg, Tagilsk, Perm, Kasan, Nischni-Novgorod, Moscow, Petersburg, and Helsinfors to Abo, and thence by steamer to Stockholm.

With the exception of some short stoppages in the large towns we travelled day and night, and a sketch of this latter part of our journey would therefore be occupied principally with the agreeable and friendly reception which we uniformly met with, and the interest which was universally felt in our polar journey. The correspondence which has appeared on this subject in the newspapers may perhaps free me from the obligation of saying more on this subject.

Before I finish this letter I ought finally to mention that the large collections in natural history made by the expedition both in Novaya Zemlya and the Kara Sea, and during our river journey on Jenisei, all, with the exception of a large collection of fish from Siberia sent by caravan, have come to hand in good

condition. For the examination and description of these collections I wish to employ the younger scientific men of eminence in our country, and as the most of them cannot without too great a sacrifice undertake year-long labours more or less foreign to their proper employment, I have made an application to the Government for a grant of 10,000 crowns (about 550*l.*) to defray the expense of working up the collections. If this application be granted, and the collections of the expedition of 1875 thus become not a dead museum-material, but fructify for the purposes of science, I hope that the sea visited by the expedition, formerly almost unknown, will soon be reckoned among those of our globe which are well known in respect of their natural history.

Part of these scientific researches besides concern purely practical questions, and I shall therefore, as they are concluded, give you a short account of them.

A. E. NORDENSKJÖLD

#### ON THE SPECTRUM OF NITROGEN AND THAT OF ALKALINE METALS IN GEISSLER TUBES, BY M. SALET

IN 1872 Mr. Schuster published the important statement that "nitrogen, heated in a Geissler tube with metallic sodium, ceased to give the characteristic channelled spectrum." He described the bright lines he got in this case, and attributed them to pure nitrogen, considering the band spectrum to be that of an oxide of nitrogen, a compound destroyed by the alkaline metal. These conclusions were afterwards disputed, for, in repetition of the experiments, the channelled spectra were seen to disappear after action of the sodium, but they were replaced by various spectra, none of which belonged to nitrogen; so that, after its purification, this gas could not be detected by prismatic analysis. The chemical compound really formed by the action of oxygen on nitrogen is (as M. Salet pointed out) peroxide of nitrogen, a very stable substance, whose spectrum does not coincide with that, the appearance of which is to be explained.

In a recent note to the French Academy, M. Salet affirms (1) that the channelled spectrum may be produced with nitrogen heated in contact with sodium; (2) that the disappearance of the nitrogen spectrum is due to that of the nitrogen itself, which is entirely absorbed by the sodium under the influence of the electric discharge; (3) that the spectrum described by Mr. Schuster may probably be attributed to vapours of the alkaline metal.

He describes some of his more decisive experiments. A closed tube of hard glass was procured, 12 cm. long and 2 cm. in diameter; at one end were introduced two aluminium electrodes, about 1 cm. apart; to the other end was soldered a tubulure with an enlarged part, into which was put a small piece of sodium, then the tubulure soldered to the mercury pump. A vacuum having been made, the sodium was heated; it swelled and boiled, parting with hydrogen; the swelling at length ceased, and at a higher temperature the sodium was slowly volatilised. Then the apparatus was separated from the pump, with the blowpipe; and the bright liquid and globule of sodium was brought into the tube. After cooling, the enlarged part was separated, and the tube directly fused on to the pump. Then exhaustion was recommenced, and the sodium volatilised, care being taken that the condensation of the metallic vapour occurred only in the half of the tube not holding the electrodes; and nitrogen, pure and dry, was then admitted. A vacuum was produced anew three times with the nitrogen, the alkaline metal being volatilised each time. Lastly, the apparatus was closed, having a pressure of about 5 mm. It was now possible to fuse the globules, unite them, and volatilise them afresh a dozen times in contact with the same mass of gas, without the appearance of the spark between the electrodes being in the least degree modified. The Holtz machine was used, or an induction coil with a Leyden jar; the interpolar space was roseate violet, and gave the channelled spectrum with the greatest distinctness. When the disruptive spark of the Holtz machine is employed, the jet of roseate violet light giving the channelled spectrum is instantaneous, as can be shown by a simple method (which M. Salet described). By volatilisation the sodium may easily be brought to the neighbourhood of the electrode. It there appears in the form of brilliant globules of a very pure silver white; but if the tube be set in action, the portions subjected to the action of the luminous discharge are at once tarnished. The metallic surface quite disappears, and is replaced by a brownish black. At the

same time one sees in the appearance of the electric jet ~~change~~ produced which are caused by a greater rarefaction. If the surface of the sodium be renewed the action continues, and the spectrum of nitrogen presently quite disappears; the light yellowish, and due, for the most part, to sodium; there are a general, slight impurities (from the electrodes and glass). ~~what~~ give some strange lines.

M. Salet made a direct experiment to show this absorption of nitrogen by sodium under the influence of electricity. He used a tube like the one that has been described, but bearing a truncated barometer; and introduced nitrogen at a pressure of 27 mm. The absorption of the gas was sufficient for one to be able to follow with the eye the ascent of the mercurial column. After a few minutes, having twice renewed the surface of the sodium, no difference could be perceived between the mercury surfaces in the two branches of the manometer.

The author also sought to characterise this absorption chemically. He broke a tube and treated separately with water a portion of the sodium remaining bright and a portion of the sodium altered by electricity. Into the solution he poured Nessler's test. One of the two liquids was strongly coloured yellow; it was that containing the altered sodium, the other was not altered in aspect. There was formed, then, under the influence of electricity, nitride of sodium decomposable by water with production of ammonia. This body is formed only at a temperature higher than red, like nitride of magnesium; or even is not produced directly at any degree of heat, like ammonia. M. Salet proposes to prepare and analyse it.

#### NOTES

WE hear with regret that the publications of the Geological Survey of the Territories by Prof. Hayden are likely to be stopped by the partisans of rigid economy in the U.S. House of Representatives. If this step be carried out it will be a serious loss to the scientific men of Europe, as well as of America. The discoveries which have been made by the staff under Prof. Hayden's direction are of the highest value, both from a scientific and a commercial point of view, and the liberality with which they have been circulated in Europe by the American Government has earned the gratitude of all who care for the advancement of knowledge. We trust that the rumour is untrue. If it be true, we hope that a voice of remonstrance will go forth from Europe. The possibility of a political change putting an end to a great national work like that of Prof. Hayden illustrates one of the worst flaws in the American Constitution, the cancelling of all Government appointments at the election of a new president.

M. LEVERRIER was not present at the Anniversary Meeting of the Astronomical Society to receive the medal which for a second time has been awarded him for his valuable Planetary Tables. Ill-health, caused by his recent great labours, was, we believe, the cause of his absence.

THE Annual Address of the President of the Geological Society will be given at the Anniversary Meeting to-morrow.

WE are gratified by the statement contained in the Queen's Speech, that the Government intend to introduce, in the course of the session, measures relating to Primary Education and the Universities. An important article on the subject appeared in Monday's *Daily News*, in which the defects of the present constitution of our Universities are forcibly pointed out. It is also shown how important a bearing the composition of the Commission would have in the character of its work, and that it would be but a proper act of deference to the valuable labours of the Science Commission if the new commissioners numbered some eminent representatives of science. What the direction of the proposed University reforms is likely to be may be to some extent gathered from the "inspired" hint dropped by the Dean of Christ Church, on Tuesday, in connection with the proposal to retain the services of Prof. Max Müller for Oxford. The Dean was authorised to state that

the Government "Universities" Bill would constitute an Executive Commission with powers to receive schemes from Colleges, and base upon them the new University and Collegiate organisation. We shall deal at length with this important subject at the proper time.

WE hear a rumour—which we think not unlikely to strengthen into a more certain sound—that the scheme for removing the Oxford Botanic Garden from its present historical and picturesque site to the bleak and arid "parks," has fallen through, and that immediate steps are to be taken to put the existing establishment on an efficient footing.

THE *Times'* correspondent, telegraphing from Rome on Tuesday, states that the Working Committee appointed by the Italian Government to act in concert with the General Committee in London for carrying into effect the exhibition of a loan collection of scientific instruments, to be opened at South Kensington in April next, have just addressed a circular to the various scientific institutions and individual savans throughout the country. It informs them that His Majesty's Government ardently desires that Italy should also take part in the Exhibition, and requests them to examine what instruments in their collections may be most worthy of being exhibited. It especially calls their attention to instruments of an historic character, and to those which have been constructed and principally applied in Italy. In the case of important instruments, of which the use cannot be dispensed with for the length of time the Exhibition may remain open, or which are of too fragile or too delicate a description to incur the risk of transport, but which, from their novelty or perfection, merit being brought before the notice of scientific men through this Exhibition, the Committee request that models and photographs of not too small a size may be sent. These models and photographs are to be made at the expense of the institution or persons exhibiting, but in cases where they may not be able to support the expense, the Committee, in proportion to the importance of the instruments, will supply the means from a fund set apart for the purpose by the Minister of Public Instruction. The Committee suggest that especial regard should be had to the quality and interest of the objects sent, rather than to the quantity.

A SUPPOSED error in the determination of the date when Easter Sunday should fall in the present year has been made the subject of communications to various metropolitan and provincial journals. We shall enter more fully into this question next week; meanwhile it may be stated that the presumed error is an imaginary one, according to the strict methods for ascertaining the date of Easter Sunday, which is correctly fixed by our almanacs to the 16th of April.

A COMMITTEE has been formed at the Hague for the purpose of organising a movement to erect a statue in that city to Spinoza, the 200th anniversary of whose death occurs this month next year. Foreign committees have also been formed, and among the members of the English committee are Professors Bain, Huxley, Jowett, Max Müller, Tyndall, Principal Tulloch, Messrs. G. H. Lewes and Herbert Spencer. Committees have also been formed in Germany, Austria, Belgium, the United States, Finland, France, Italy, and Switzerland. We do not require to say anything in favour of this movement; now that the matter has been mooted it seems surprising that nothing of this kind has hitherto been done to honour the memory of one of the greatest, purest, and most cosmopolitan of philosophers. The movement only requires to be widely known to meet with adequate practical support; many who may differ seriously from Spinoza's philosophy will be glad of an opportunity to show their appreciation of a great, courageous, and disinterested thinker. The treasurer is Mr. A. W. Jacobson, the Hague, the president being Dr. M. F. A. G. Campbell, of the same place.

As regards our note in a former number on the Obi Expedition, we find that Dr. Finsch, of Bremen, whom we spoke of as about to accompany it, will himself be the conductor of it, and will be assisted by Dr. Brehm and Count Waldburg-Zeil, also the well-known microscopist Oscar Schmidt, of Strasburg. The Expedition is organised and sent out by the Verein für Deutsche Nordpolarfahrt in Bremen, and will proceed overland *via* Semipalatinsk and the Altai. It is expected to return late in the autumn.

WE are much pleased to see that Mr. E. L. Layard is gazetted to the Consulship of New Caledonia. In spite of the enormous pressure of business upon him during the late transfer of government in the Fiji Islands, Mr. Layard has managed to do a considerable amount of scientific work there; he has sent home large collections of birds, as well as several valuable papers.

WE have received a copy of the Statement by the Committee appointed by the British Association for the Advancement of Science for the purpose of continuing the investigation on the desirability of establishing a "close time" for the preservation of indigenous animals. Of the indirect and direct causes which tend to reduce the numbers of the Wild Fowl, which the "Statement" mostly concerns, the control of the latter of these causes forms its substance. It is shown that the ineffectual working of the "Wild Birds' Protection Act" depends on the insufficiency of the penalties imposed, the market value of Wild Fowl being high. It is also shown that as those who employ their time in the pursuit of these birds are in the habit of taking out a gun licence and of refraining from exercising their calling in certain waters and over certain lands, therefore they fully realise the nature of restraint, and would be willing—the better class of them, at least—gladly to recognise the propriety of a well-considered and stringent measure, which by effectually protecting Wild Fowl during the breeding season would secure to them a greater abundance at other times of the year. Whilst considering the protection of small birds as of minor importance, the Committee are of opinion that some steps for the regulation of bird-catchers might well be taken.

AT a congregation of Cambridge University on Feb. 3 the following grace passed the senate:—"That a grant of 50*l.* be made from the Worts Travelling Scholars' Fund to William Bridge, B.A., of Trinity College, to enable him to visit Naples, for the purpose of using Dr. Dohrn's Zoological Station, and making researches in Natural History, on the understanding that specimens be sent by him to the University, accompanied by reports which may be hereafter published."

AT the Royal Geographical Society on Monday last, Sir Henry Rawlinson intimated that Lieut. Cameron had solved the difficulty with regard to his followers, by purchasing a vessel at Loando for 1,000*l.*, in which they sailed early in January for the East Coast of Africa. By last accounts the explorer was still at Loando, whence he was to sail by the next steamer for Madeira. At the same meeting the Diary of the late Mr. Margary, from Hankow to Ta-li-fu, was read.

THE Council of the Society of Arts have appointed Mr. H. Trueman Wood as Assistant Secretary, under Mr. P. Le Neve Foster, Secretary of the Society. Mr. Wood has been for the last three years the editor of the Society's journal.

THE Senatus of the University of St. Andrews have conferred the degree of LL.D. on Mr. James Stuart, M.A., Professor of Mechanism and Applied Mechanics in Cambridge University, and on Mr. James Croll, of H.M. Geological Survey.

WE hear that ten days after the attempted ascent of Mont Blanc, noticed in our last number, an American lady ascended not only to the Grand Mulets, but to the summit itself, when

the temperature was  $-25^{\circ}$ . She reached the top on Jan. 31 at three o'clock in the afternoon, when the sun lighted up an immense panorama. The thermometer marked at the Grand Mulets  $-13^{\circ}$  and the Grand Plateau  $-19^{\circ}$ . The lady had with her several guides, and slept at the Grand Mulets on the evening of Jan. 31, returning by La Vallée on Feb. 1. She was enthusiastically welcomed by [the inhabitants of Chamounix.

ONE of the Exhibitions granted to Cambridge University by the Worshipful Company of Clothworkers to be awarded to Non-Collegiate Students for proficiency in Physical Science, has been gained by Alexander Scott, educated at the University of Edinburgh. It is of the annual value of 50*l.*, and is tenable for three years.

AN open scholarship in Natural Science, of the yearly value of 90*l.*, tenable for five years, will be competed for at Queen's College, Oxford, on April 25, and following days. Candidates should signify, as early as may be in March, to the Provost, their intention of standing.

THERE are 616 boys now on the school-list at University College School.

WE are glad to see that an influential movement is on foot to form a Bristol and Gloucestershire Archæological Society. Such a society will have a fertile field for varied work in Gloucestershire, and we have no doubt, from the names which are identified with the movement, that the Society, when formed, will produce valuable results. The inaugural meeting will be held some time during the Easter holidays.

It is proposed to open a school for field and laboratory instruction in Geology early in July, under the auspices of the Cornell University, at Ithaca, New York. The methods of instruction will be essentially the same as heretofore successfully employed at Penikese, Cleveland, and Peoria in the study of zoology and botany. The first and last quarters of the session will be spent at Ithaca, in laboratory work in connection with frequent lectures. About one-half of the session (second and third quarters) will be devoted to field work, with headquarters in an encampment in a mountainous region chosen for its fitness in illustrating geological structure. Prof. Theb. B. Comstock will have charge of this school. Similar schools with local field work where required are being organised under the direction of the professors in charge of the departments of physics, chemistry, botany, zoology, and free-hand drawing in Cornell University.

THE following College Lectures in the Natural Sciences will be given at Cambridge during the Lent Term:—Gonville and Caius College: On Anatomy and Physiology, by Dr. Bradbury; On Non-Metallic Elements, by Mr. Apjohn.—Christ's College: On the Physiology of the Senses, by Mr. H. N. Martin.—St. John's College: On Elementary Chemistry, by Mr. Main; Instruction in Practical Chemistry will also be given; on Palæontology (the Annuloidea and Annulosa), by Mr. Bonney; on Physical Geology, by Mr. Bonney; on Elementary Geology, by Mr. Bonney.—Trinity College: On Sound and Light, by Mr. Trotter; on Electricity and Magnetism (Elementary Course), by Mr. Trotter; Practical Physiology and Histology, by the Trinity Prælector in Physiology (Dr. Michael Foster).—Sidney Sussex College: On Botany (Vegetable Histology and Physiology), by Mr. Hicks.—Downing College: On Physiology (Papers and Catechetical Lectures, with special reference to the Natural Science Tripos and the Second M.B. Examination), by Dr. Bradbury. On Chemistry (Papers and Catechetical Lectures), by Mr. Lewis.

A LAUDABLE scheme is on foot to unite the local societies of Cumberland into an Association for the Advancement of Science and Literature, having for its objects the spread of culture, mutual assistance in the organising of lecture courses, &c.,

wholesome emulation among the constituent societies in the production of original papers, a yearly union in some town of Cumberland for the reading of original papers and discussion of subjects affecting the scientific and literary welfare of the community, and the publication, at the expense of the Association, of those original papers brought before the various societies which may be considered worthy by the Council.

THE *Iowa Weather Review*, No. 3, gives a brief *résumé* of the weather during each of the six decades of October and November last. Among the more interesting points noted are the occurrence of the Indian summer from the 18th to 24th October; the entire absence of snow or rain from the greater part of the State during November, and a rapid fall of temperature with a N.W. wind on the afternoon of the 28th November, amounting to upwards of  $40^{\circ}$  in twelve hours. The meteorological year, ending with November, was  $3^{\circ}8$  colder than the average, and Dr. Hinrichs, judging from the sequences of the weather during the past thirty-five years, ventured to predict a mild winter in Iowa. It appears from an examination of cyclones traced over Iowa that electrical phenomena manifest themselves at a considerable distance from the centre of the cyclone, a point of some interest to meteorologists, and deserving of further examination. A table showing the rainfall at sixty-five stations in the state, and another table giving the various meteorological averages at Iowa City during the past four years, complete this very interesting number.

IOWA being the only state in the Union having a meteorological system of its own reporting to a central office and furnishing state reports to the press, it has been resolved to exhibit at the Philadelphia Exhibition specimen schedules, books, postal cards, manuscript weather maps, publications, and diagrams of the climate of the State, in order to show the working of the Iowa Volunteer Weather Stations. It being manifestly beyond the resources even of the munificently supported meteorological system of the United States to undertake the investigation of many important inquiries, other states will probably be induced to follow the example of Iowa when the system there pursued is fully brought under their notice at Philadelphia.

IN a report to the Secretary of the Board of Regents, the erection of a physical observatory at the Iowa State University has been recommended. The detailed drawings on which the estimate of the sum required is based, show that the different storeys of the buildings are to be appropriated to a magnetic observatory, optical observatory and laboratory, self-registering meteorological instruments, and the keeping of records of observation, and a meteorological observatory, while on the roof will be placed a wind-vane, an anemometer, rain and snow gauges, and radiation thermometers.

THE Science and Art Department has issued a Catalogue of Apparatus for instruction in Practical Plane and Descriptive Geometry, Machine Construction and Drawing, Building Construction, Theoretical Mechanics, Applied Mechanics, and Steam, to the purchase of which the aid of 50 per cent. is given.

ACCORDING to letters received from Ternate by Prof. Parlatore, dated September last, from Dr. Beccari, we learn from the *Gardener's Chronicle*, that that adventurous traveller had discovered on Mount Arfak, in New Guinea, a *Balanophora* and an *Araucaria*, besides species of *Vaccinium*, *Rhododendron*, *Podocarpus*, *Umbellifera*, and a *Drimys*. We have merely these names to tantalise us, but they suggest a very interesting flora. From the same source we glean the following:—A School of Horticulture has been established at Copenhagen. There will be a national horticultural exhibition at Rome from May 6 to 14, the first of the kind that has taken place in that city.

THE additions to the Zoological Society's Gardens during the past week include three Burrowing Owls (*Pholopteryx cunicu-*

(*larva*) from South America, presented by Mr. A. Q. Lumb; two Golden Pheasants (*Taoumalca picta*) from China, received in exchange; a Tuft-headed Deer (*Lophotragus michianus*) from China, the first living specimen sent to this country, a Chinese Water Deer (*Hydropotes inermis*), five Darwin's Pucras Pheasants (*Pucrasia darwini*) from China, deposited; a Blue-cheeked Barbet (*Megalzma asiatica*) from India, purchased.

### SCIENTIFIC SERIALS

**THE American Journal of Science and Arts**, January.—This number commences with a paper of "Contributions to Meteorology," in which Prof. Loomis gives results derived from an examination of the United States weather maps and from other sources. Among the points observed are: that periods of unusual cold are generally accompanied by descent of air from the upper regions of the atmosphere, and they are almost quite independent of direction of the wind; that both in summer and winter the force of vapour in Philadelphia is greatest with the wind which brings the highest temperature, and conversely; that the rainfall there shows a diurnal maximum about 6 P.M. and a minimum about 3 A.M.; that in the northern hemisphere storms increase in frequency as we proceed northward as far as latitude 60°, and perhaps somewhat further; and that storms travel with less velocity over the Atlantic (19.6 miles an hour) than over the continents of America and Europe (26 miles an hour). The author compares storm-paths in America and Europe.—Mr. Rowland continues his "Studies on Magnetic Distribution," and one result he arrives at is, that hardening is most useful for short magnets; in very long bars it does not increase the total quantity of magnetism, but only changes the distribution. It would seem that almost the only use in hardening magnets at all is to concentrate the magnetism and reduce the weight.—This paper is followed by a useful summary and comparison of recent researches on Sound by Tyndall, Henry, and Duane.—Prof. Draper endeavours to determine the correction to be applied for effect of temperature on the power of solutions of quinine to rotate polarised light. The presence of sulphuric acid changes the rotation power of the alkaloid by 100°. Quinine used to be given in the form of sulphuric acid solution, and in the recently more popular form of pills or the like, its action is much less, and less certain; this difference being doubtless due to the change of molecular arrangement which is revealed in action of sulphate solutions of the alkaloid on light.—Mr. Allen has a note on extinct wolf and deer species from the lead regions of the Upper Mississippi.

**Poggendorff's Annalen der Physik und Chemie**, Ergänzung. Band vii. Stück 1.—In a paper in this number on the mechanism of magnetic induction, M. Chwolson deals with a phenomenon in production of the magnetic state by external magnetising force, with which theory has seemed to be in discordance. This is the fact, that  $\kappa$ , the so-called magnetisation number (or the ratio of magnetic movement produced to the magnetising force), in the case of small increasing forces, increases at the beginning, reaches a maximum, and with further increase of the force, becomes continuously smaller. This initial increase of  $\kappa$  seemed to contradict the theory of molecular magnets capable of being turned round. M. Chwolson's object is to show that it not only does not contradict it, but is directly deducible from it, and he arrives at this result from a closer study of the processes which, according to Weber's fundamental hypothesis, must occur in a magnetised body, and from a simple assumption as to the origin of molecule-repelling force.—There are three (largely mathematical) papers in this number relating to the mechanical theory of heat; we merely give the titles:—On temperature and adiabats, by M. von Oettingen; On the specific heat and true heat capacity of bodies, by M. Herrmann; and On the second principle of the mechanical theory of heat deduced from the first, by M. Sijlz.—M. Voigt contributes the first portion of a careful investigation of the constants of elasticity of rock salt; he here treats the case of bending.

**Der Naturforscher**, Dec. 1875.—In this number we may note some researches by M. Fleck, of Dresden, which appear to damp recent optimism in reference to salicylic acid as a means of disinfection. He finds that carbolic and salicylic acids may, under certain circumstances, even accelerate fermentation. Benzoic acid is more effective against fermentation, and cinnamic acid still better; but their small solubility in water is against their

use. The antifermentative action of benzoic, carbolic, and salicylic acids is dependent on the quantity of nitrogenous yeast-food; with increase of this the value of their action diminishes. The acids are not specific yeast poisons. Some experiments by M.M. Kolbe and Mayer have a similar bearing.—From observations made during the German North Polar Expedition, it is shown by Dr. Hann that the density of the sea-water increases both at the surface and at 900 feet depth, with the latitude, and is in the Polar seas considerably greater than in the Tropics. Hence Dr. Hann concludes that a temperature-compensation of the water of the ocean by unequal proportions of salt does not exist; the heavy Polar water must therefore have a tendency to flow towards the equator.—In an interesting paper on the rate of propagation of excitation in sensitive nerves, M. Bloch shows that the methods for measuring this, which depend on the will of the experimenter (making a signal), are unreliable. He describes an ingenious new method; and he finds the velocity in the spinal cord 194 metres per second, while in the nerves it is only 132 metres per second.—There is an abstract of recent researches by M. Exner, which go to prove, in opposition to M. Edlund, that the supposition of a special power of expansion by the galvanic current in a metallic wire is unwarranted.—We further note some instructive researches by M. Stefan on the comparative power of heat conduction of different gases.

### SOCIETIES AND ACADEMIES

#### LONDON

**Linnean Society**, Feb. 3.—Dr. G. J. Allman, F.R.S., president, in the chair.—William Hillhouse, Prof. E. R. Lankester, Daniel Pigeon, and David Robertson were elected Fellows of the Society. The following were proposed as Foreign members: Dr. Nylander, Professor of Botany, Helsingfors, and J. V. Barboza du Bocage, Direc. Roy. Zool. Mus., Lisbon.—Mr. Algernon Peckover exhibited a case of insects from Madagascar, collected by Mr. Kingdon. Among these Mr. Butler pointed out and made remarks on the scarce and remarkable *Actias Idae* of Felder's "Reise der Novara," the new Hawk-Moth, *Diodosida* sp., allied to a Congo species, also *D. fumosa*, Wallace, the *Danais chrysipus*, L., and its mimic, *Diadema misippus*, L., likewise a Homopterous genus allied to *Coomoscarta*, of Stål.—Mr. Henry Trimen read a note on *Bixa commersonii*, R.Br. He observed that the supposition of Commerson having obtained the type at Magellan Straits is founded on an error; Mr. Rob. Brown regarded it as belonging to the Seychelles. Mr. C. Walter has quite lately discovered specimens growing on coral cliffs in the Duke of York's Island, which, through the Baron von Müeller, of Melbourne, have been forwarded to this country for identification. The probability is that Commerson himself obtained his examples in 1768 from the same locality; its true habitat afterwards having been confounded from the name "Praslin" attached to the original specimen, being given to widely different places.—Mr. Bowdler Sharpe read a paper on the geographical distribution of the vultures (Vulturidae). These he divides into two sub-families Vulturinae, with six genera, and Sarcorhamphinae, with four genera, the distinctive characters and geographical range of which were commented on. The author likewise sketched out the classification of the birds of prey, as proposed by him in recent publications.—A short paper on New British Lichens, by the Rev. W. A. Leighton, was taken as read; in this six new species are described and figured.—The Rev. J. M. Crombie made some observations on two communications laid by him before the Society, viz., (1) *Lichenes capenses*, being an enumeration of the lichens collected at the Cape of Good Hope, by the Rev. A. E. Eaton, during the Venus Transit Expedition in 1874. (2) *Lichenes Kergueleni*, being an enumeration of the lichens collected in Kerguelen Land by the Rev. A. E. Eaton during the Venus Transit Expedition in 1874-5.

**Mathematical Society**, Feb. 10.—Prof. H. J. S. Smith, F.R.S., president, in the chair.—Messrs. A. Cockshott and R. T. Wright were proposed for election. The Secretary communicated a paper by Prof. Wolstenholme: Loci connected with the rectangular hyperbola, being inverse, with respect to its centres and vertices. Mr. Cotterill spoke upon the subject, referring to authors who had also treated of the loci in question.—Mr. W. Spottiswoode, F.R.S., read a paper on determinants of alternate numbers. The paper was founded on some unpublished notes on determinants and other functions of these numbers, communicated to the author by Prof. Clifford.—Mr.

Glaisher gave a brief sketch of a note by Mr. T. Muir, on the transformation of Gauss' hypergeometric series into a continued fraction.—The Chairman then dwelt in some detail on the partition of geometrical curves, the principal theorem being that, if  $D$  is the deficiency, the maximum number of distinct parts of the curve is  $D + 1$ . Professors Cayley and Clifford and Mr. S. Roberts took part in the discussion upon the paper.—Mr. J. Hammond gave an account of his paper on the sums of the products of  $r$  different terms of a series.—Prof. Clifford made a few remarks on pendular motion, in continuation of his paper read at the preceding meeting of the Society.—The President read part of a one-paged note on the pan-imaginary theory, by the Comte Léopold Hugo.

**Royal Astronomical Society.**—The Annual General Meeting was held at the Society's Rooms, Burlington House, on the afternoon of Friday, Feb. 11, Prof. Adams, president, in the chair.—Amongst the lives of deceased Fellows given in the Annual Report were those of Mr. Carrington, Prof. Selwyn, Mr. Vignoles, and Sir Edward Ryan; and amongst the deceased Associates were Prof. Argelander, M. D'Arrest, and M. Mathieu. Mr. Carrington has left the Society a legacy of 2,000*l*. He for many years served as secretary, and during that period published two important works, the one upon sunspots, and the other known as the Red-hill Catalogue of Circumpolar Stars. Mr. Carrington was the first to show the existence of the great drifts in the solar photosphere and to determine accurately the position of the sun's axis and the rotation periods of the various heliographic latitudes. After reading the Report of the Society, the President delivered his address upon the presentation of the Gold Medal to M. Leverrier for his investigations with reference to the perturbations of the outer planets.—The Astronomer Royal referred to Prof. Adams' address as one of a most exhaustive character, such as could only have been delivered by the Professor. The meeting then proceeded to the ballot for Officers and Council for the ensuing year, and the following gentlemen were declared to be elected:—President—Dr. Huggins. Vice-Presidents—Prof. J. C. Adams, Sir G. B. Airy, Mr. De la Rue, and Mr. Lassell. Treasurer—Mr. Whitbread. Secretaries—Mr. Dunkin and Mr. Ranyard. Foreign Secretary—Lord Lindsay. Council—Capt. Abney, Mr. Brett, Prof. Cayley, Mr. Christie, Mr. Glaisher, Mr. Knobel, Mr. Knott, Capt. Noble, Rev. S. J. Perry, Prof. Pritchard, Earl of Rosse, and Capt. Tupman.

**Anthropological Institute, Feb. 8.**—Col. A. Lane Fox, president, in the chair.—The President read his anniversary address, in which the papers read before the Institute during the past year were classified as follows:—Descriptive ethnology, nine papers; archæology, seventeen papers; ethnology, one paper; biology, three papers; comparative anatomy, four papers; psychology, one paper; sociology, two papers; philology, two papers. The remainder of the address was devoted to matters relating to the policy and internal affairs of the Institute. The Rev. W. Wyatt Gill read two papers on some traditions of the Harvey Islands, and demonstrated, by the assistance of genealogical tables of kings and priests, that the islands had not been inhabited more than about six centuries, and gave some instances from his own knowledge of canoes having drifted from very distant islands as a cause for the spread of the Polynesian race throughout the Pacific.—A paper by Mr. W. W. Wood, on some megalithic monuments in the Island of Rotumah was also read.

**Physical Society, Feb. 12.**—Annual General Meeting.—Prof. Gladstone, F.R.S., president, in the chair.—The following candidates were elected members of the Society:—Mr. W. R. Hodgkinson and Mr. H. M. Hastings.—The President read the report of the Council, of which the following is an abstract:—The Council points with satisfaction to the activity with which the work of the Society has been carried on during the year, as is shown by the number of papers read; and special reference is made to lectures which were delivered by M. Cornu, of Paris, and Mr. J. Norman Lockyer. The election of many distinguished physicists during the past year has given the Council much satisfaction, as it affords undoubted evidence of the progress of the Society and of the position it has now attained. The Society has to regret the loss of two members, Mr. Becker, who died on the 3rd of April, 1875, from bronchitis, in the fifty-fourth year of his age, and Mr. Waugh, who died on the 12th of October, from epilepsy, in his fortieth year. The Society has already published a work by Prof. Everett, on the Centimetre-Gramme-Second System of Units, and the Council is now

in communication with the family of the late Sir Charles Wheatstone with a view to the publication of his papers. Attention is drawn to the benefit which the Society derives from the use of the lecture-room, &c., which were generously placed at its service by the Lords of the Committee of Council on Education. It has been considered desirable to arrange that the Council may grant admission to all meetings of a session to approved persons who are not members of the Society. In concluding the Council records its thanks for the services which Dr. Guthrie has rendered in his office of Demonstrator, an office which was formerly an important one in the Royal Society, and the Council believes that much might be gained if arrangements could be made for reproducing before this Society the experiments described in original papers which appear from time to time in this country and abroad. Several alterations in the Bye Laws were then discussed and adopted, and the following Officers and Council were elected for the ensuing year:—President, Prof. G. C. Foster, F.R.S. Vice-Presidents: Prof. W. G. Adams, F.R.S., and W. Spottiswoode, LL.D., F.R.S. Secretaries: A. W. Reinold, M.A., W. C. Roberts, F.R.S. Treasurer, Dr. E. Atkinson. Demonstrator, Dr. F. Guthrie, F.R.S. Other Members of Council: Latimer Clark, C.E., Prof. A. Dupré, F.R.S., W. Huggins, D.C.L., F.R.S., Prof. H. M'Leod, Dr. C. W. Siemens, D.C.L., F.R.S., Dr. H. Sprengel, Dr. W. H. Stone, Sir William Thomson, LL.D., F.R.S., Prof. W. C. Unwin, B.Sc., and E. O. W. Whitehouse. The proceedings then terminated with votes of thanks to the President, the Lords of the Committee of Council on Education, the Demonstrator, Secretaries, and Treasurer.

**Geologists' Association, Feb. 4.**—Mr. William Carruthers, F.R.S., president, in the chair.—On the drift of the North Wales border, by D. C. Davies, F.G.S.—The covering of drift is most complete on the eastern slopes of the border down to the plain of Cheshire and Salop. The greatest thickness is on a north and south line between Wrexham and Oswestry, the maximum of 150 feet being attained between Ruabon and Wrexham. The exceptions to this rule occur in certain hollows and valleys of the hilly region. The best exposures are at old Oswestry gravel-pit, 500 feet above level of sea, and the gravel ridge of Gresford. The author also gave a line of pit sections ranging from north to south. Five groups were described:—1. Deposits of the Pre-Glacial period, due principally to meteoric action upon adjacent rocks. 2. Stiff clay with boulders of local and northern origin, Lower Boulder clay. 3. Sands and gravels, with beds of mud and clay, Middle Glacial. 4. Stiff clay with boulders of local and northern origin, Upper Boulder clay. 5. Peat deposits, freshwater shell-beds, redistributed gravels, &c., Post-Glacial. The Upper Boulder clay (group 4) fills up inequalities in the preceding beds; it varies in thickness from 1 to 20 feet, in places thinning out altogether; the immense boulders which strew the surface come from this rather than from the Lower Boulder clay. Referring to these boulders generally, besides representatives of most of the Welsh rocks, and notably of the ashes, traps, and greenstones of Glyn Ceiriog, there are three principal varieties of "Scotch granite." The first deep red, with large crystals of red felspar; the second, pinkish, from an admixture of white quartz and red felspar, fine in the grain; the third is a greenish-grey rock, resembling specimens from Sutherland, Kirkcudbright, &c. A consideration of the phenomena presented by the three groups of the Glacial period leads the author to the following inferences:—1. The majority of the deposits are of local origin, being derived from the mountainous region of North Wales, then an archipelago of islands. 2. But, from the plentiful admixture of foreign matter, he infers a sea open to the north. 3. He insists upon the necessity of aqueous conditions: the coast would be partly ice-bound, but there was no general ice-cap. Besides the general alterations of level there were local alterations of level; proofs of this were to be seen in the neighbourhood of Oswestry, beyond which town the Scotch granites do not seem to pass. This the author considered due to currents deflecting the ice-rafts, &c. He concluded with an account of the redistribution of Glacial material in Post-Glacial time.—On the first Irish cave exploration, by G. S. Boulger, F.G.S. The author showed how the direction of the chambers of caves is influenced by joints, and drew attention to the distinction between caves and rock fissures as influencing their fauna. Unnecessary to assume that there was more carbonic acid in the air during the quaternary period, as water containing '01 per cent is the most efficient solvent of limestone, suggested that allowance might be made



for a fluvial period in considering the rate of deposition of stalagmite, and also for the influence of herbage in reducing the present amount of water percolating the rocks. The habits of beasts of prey and of aged animals frequenting caves was next considered. Shandon Cave, near Dungarven, was then described, and an account given of its excavation by Prof. Leith Adams and the author, during which remains of mammoth, reindeer, red-deer, wolf, fox, hare, goat, and various birds were found. The author concluded with some suggestions as to the state of Ireland and of its fauna during the period when these deposits took place.

Institution of Civil Engineers, Feb. 8.—Mr. Geo. Robt. Stephenson, president, in the chair.—The paper read was on Carlingford Lough and Greenore, by Mr. James Barton, M. Inst. C.E.

WATFORD

Natural History Society, Feb. 10.—Anniversary Meeting.—Mr. John Evans, F.R.S., president, in the chair.—The report of the Council and the Treasurer's account for 1875, showing that the Society was in a prosperous condition, were submitted to the members, and the President delivered an address on the work which had been done by the Society in the investigation of the natural history of Hertfordshire, and on the field of investigation open to the members.—Mr. John Evans, F.R.S., was elected president for the ensuing year.

VIENNA

Geological Society, Jan. 4.—The director, M. v. Hauer, read the anniversary report, describing the work of the Society in its various departments. During the last two years geological surveys have been continued in the Tyrol, in Galicia, and the Bukovina. In the Tyrol, Dr. Stache, with the assistance of M. Koch, and of two volunteers, M. Schranz and Dr. Posewitz, mapped the principal part of the Oetzthaler Mountains, and the Mountains of Tirol-Vorarlberg, forming the boundary of Switzerland, northward from the Orter to the region of Balzers. At the same time M. Mojsisovics, with Dr. Hörnes and the volunteers, Dr. Reyer and Dr. Kotschy, completed the mapping of the region eastward from the porphyric massives near Botzen; northward to the Sexten and Puster valley; southward, including considerable parts of the Venetian Alps—as far as the line of dislocation near Primiero-Agordo-Zoldo; and in the east as far as the Piave; whilst M. Dölter made special investigations of the various eruptive rocks of the same region.—K. M. Paul, assisted by the Roumanian engineers, Const. Pilde and Const. Bottea, finished the detailed geological maps of the Bukovina, and in Galicia M. H. Wolf began the mapping on the eastern frontier of the country, between the Dniester southward, the line Siderow-Petlikowce northward, and the river Stry westward. On the whole 250 Austrian square miles have been mapped. Many other researches were carried on in almost all parts of the Empire. Among these are the following:—M. Stur examined the coal-mines of Bohemia, Moravia, and Silesia, for the purpose of making a detailed classification of their strata. By means of a grant that he obtained from the Urban-Schlönbach legacy, he was enabled to investigate and compare the large phyto-palaeontological collections in Dresden, Halle, Berlin, and Breslau. Moreover, he visited chiefly on behalf of the museum of the Geological Society, some of the most important beds of Lias and Jura fossils in Salzburg and the Salz-Kamergut. The Ministry of Commerce, intending to establish a special school for workers in stone, commissioned the vice-director, M. F. Fötterle, to examine such rocks near Predazzo as might be used for technical purposes; this he did, and the school was opened on December 15, 1875. At the request of the same Ministry, M. H. Wolf made geological researches along the line of some railroads, and M. G. A. Koch along the recently planned Arlberg tunnel, &c. After a summary report of the labours performed by the committee for the geological investigation of Bohemia, and the Geological Society in Hungary, which had mapped 150 square miles of the south-western part of Hungary, in the last two years, M. v. Hauer proceeded to speak of the travels of members of the Geological Society and other Austrian geologists in foreign countries. He mentioned the labours of M. Stache in Tunis, of M. Tietze, lately returned from Persia, and of M. Lenz in the western part of Africa; from the last, a letter dated Lope in the Okando, July 28, 1875, arrived some days ago. To this place he had been conducted from Elim-bareni by the old King Renoki, and he was going to pass through the dreaded regions of Oschebo (Mpangwe) in order to reach the

Umbeke, and if possible the Mikauke. "I shall try," Lenz writes, "to follow as far as possible a north-east direction; perhaps I shall succeed in reaching the upper course of the River Schari." Further, M. v. Hauer referred to Dr. Drasche, who intended to spend the winter on the Philippine Islands, and then to extend his investigations as far as Japan and Kamtschatka; also to the researches of Dr. Feistmantel in India. Finally, he gave a report of some expeditions sent from Vienna in the last two years to examine European Turkey and Greece. The work performed in the museum, the laboratory, and the study were not less successful than those in the field. In the museum have been newly arranged and classified according to their different zones, by M. D. Stur, the fossils of the Lias, Jura, and Tithon formations of the Northern Alps. This collection consists of 6,000 specimens under 1,214 numbers, found in 444 different localities; by M. Vacek have been arranged the neocomian fossils of the Northern Alps; by M. Hörnes, those of the tertiary from the Upper Danube and Vicenza. M. Stache completed the arrangement of the palaeontological collections from Istria. In the course of the last two years the museum has received valuable presents in minerals, fossils, species of rock or worked stones from more than ninety institutions, offices, friends, and protectors of the Geological Society. The library has been augmented by 1,735 volumes and sheets. It contained, at the end of 1875, 20,971 volumes and sheets; 161 new folios were added to the collection of maps. In the laboratory there worked, besides the chief, M. v. Hauer, and the assistant, M. C. John, the volunteers Baron Jüptner, M. Schönfeld, and M. Mattesdorf. Many analyses were performed, especially of iron-stones, coals, cokes, &c., also of rocks. The collection of artificial crystals, a scientific treasure that no other museum or laboratory can show in nearly such abundance, has been again augmented materially, and comprises now more than 2,000 specimens. As to the publications of the Society, the *Verhandlungen* and the *Jahrbuch* appeared in regular course; from the Memoirs in quarto, five sheets, including fifty-nine single and sixteen double plates, were published. M. v. Hauer expresses his gratitude, in the name of the Geological Society, to the Minister, Dr. Stremayer, for the liberality and protection he always showed to it. He also refers to the many kindnesses bestowed on the Society and its members in the course of the past year, and concludes by expressing his lively gratification at the resolution taken by Government to establish new professorships for geology in the Universities of Prague, Graz, and Innsbruck.—Papers were then read by Dr. Stache on the geology of the environs of Tunis; by Dr. R. Hörnes on the recently-discovered horizon with *Bellerophon peregrinus* at the base of the triassic beds in the Alps of South Tyrol; and by Dr. Dölter on some minerals of South Tyrol.

BERLIN

German Chemical Society, Jan. 24.—A. W. Hofmann, president, in the chair.—R. Fittig has found amongst the products of distillation of citric acid an anhydride  $C_6H_{10}O_3$  (boiling-point  $242^\circ$ ) of a bibasic acid  $C_6H_{12}O_4$ , a polymeride of crotonic acid, to which he gives the name xeronic acid. This acid yields well-defined salts, but passes at once into its anhydride when liberated. The same chemist is investigating the question if non-saturated compounds have free affinities. He is inclined to answer this question affirmatively for the following reasons. Hydrosorbic acid  $C_6H_{10}O_2$  absorbs easily HBr, yielding  $C_6H_{11}BrO_2$  monobromo-capronic acid; pyroterebinic acid  $C_6H_{10}O_2$  does not. Sorbic acid  $C_6H_8O_2$  forms  $C_6H_{10}BrO_2$  dibromocapronic acid. Fumaric acid  $C_4H_4O_4$  absorbs HBr yielding monobromo-succinic acid at  $100^\circ$ ; malic acid  $C_4H_4O_4$  is simply transferred into fumaric acid at ordinary temperatures by the action of HBr.—E. Fisher explains the action of nitrous acid on diethylurea, and described the first hydrazine of the fatty series obtained as follows:—

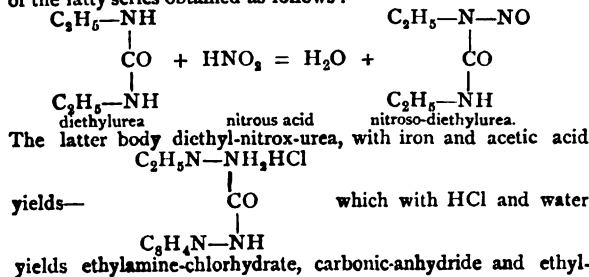

hydrazine combined with two HCl:  $C_6H_5NH-NH_2 \cdot 2HCl$ .—R. Benedich has introduced into pyrogallol both one and two molecules of ethyl, obtaining pyrogallic ethers by heating pyrogallol with ethyl-sulphate of potassium and caustic potash in closed vessels.—P. Marquart proves that commercial nitric acid contains iodine, and thinks that the violet reaction of sulphuret of carbon observed by Dr. Friedburg may be owing to this element. The latter chemist contradicts this supposition.—O. Döbner has transformed diphenyl-sulphurous acid  $(C_6H_5)_2SO_2H$  into a pihphenol  $(C_6H_4)_2(OH)_2$ , a dicarbonic acid  $(C_6H_4)_2(CO_2H)_2$ , and a dichloride  $(C_6H_4)_2Cl_2$ . The latter by oxidation passes into dichlorobenzoic acid, thus proving that the two atoms of chlorine, &c., are contained in the same  $C_6H_4$  group.—R. Meyer has transformed aniline-salts into aniline-black by treating them with permanganate of potassium.—P. Claessen recommends hydrate of baryta, prepared in a peculiar manner, for absorbing carbonic anhydride in quantitative analysis; separated by cotton-wool, some chloride of calcium is put into the tube to keep back the water discharged in the process. Numerous analyses prove its exactness.—T. Griess has treated nitrate of diazobenzol with ferrocyanide of potassium, transforming it thereby by reduction into a new substance,  $C_{10}H_{11}N_9 = (C_6H_5N)_2C_6H_4$ , and into azobenzol. This interesting discovery is most likely already known to English chemists.

## STOCKHOLM

Academy of Sciences, Jan. 12.—The Academy approved a report by a Committee, consisting of Herr Edlund and Rubenson, appointed to consider a proposal by the Board of Woods for establishing meteorological stations for the purpose of scientific arboriculture.—Herr Nordenskjöld gave a sketch of the scientific results of last summer's expedition to the Jenesei.—Herr Edlund communicated a paper entitled "Some Remarks on Galvanic Expansion," in which he gave a theoretical explanation of the fact discovered by him some years ago, that a metal wire, through which a galvanic current passes, expands to a greater extent than corresponds to the heating caused by the current. He then exhibited a specimen of the newly-published Tables of Logarithms, which had been calculated and printed by the calculating machine invented by Dr. Wiberg.—Herr Andersson gave an account of the contents of a report by Herr J. E. Zetterstedt, of a journey he had undertaken last summer, with a grant from the Academy, for the purpose of examining the flora, and especially the mosses, of the Silurian formation of Wester Götland.—The following papers were given in for insertion in the Academy's publications:—Contributions to the actinology of the Atlantic Ocean, by Dr. G. Lindström; Examinations of the nucleus, and the parts nearest to it, of the Comet of 1874, by Dr. N. C. Dunér, of the University of Lund; On Arionids and Limacinids in the zoological department of Rikks Museum, by the Intendant A. W. Malm; Remarks on the fossil flora of Bjuf, in Scania, by Dr. A. G. Nathorst. From the results of preliminary researches, the author concludes that the deposit must belong to the Rhætic formation, as it contains *Palissya Braunii*, Endl., *Teriopteris tenuinervis*, Brauns., *Pterophyllum acuminatum*, &c. He gives short notes on most of the species found, of which some have not hitherto been described. The locality has only two or three species in common with the flora at Pölsjö, formerly described by the author, and he thinks that the fossiliferous beds at Bjuf represent a lower level, and most closely resemble those of Seimstedt.—On the reciprocal lines of force, by Dr. C. F. E. Björling, of Lund University.

## PARIS

Academy of Sciences, Feb. 7.—M. Peligot in the chair.—The following papers were read:—On the chemical action produced by means of the discharges of an induction apparatus, by M. Becquerel. The effects are more marked than with the ordinary machine. With only two or four chromic acid couples, M. Becquerel obtained the reduction of copper, nickel, cobalt, &c., from paper moistened with their solutions. He also forms amalgams, following Davy's method.—Note on the metallic reductions produced in capillary spaces, by M. Becquerel. In organic nature, electro-capillary effects doubtless occur on rupture of vessels, e.g. of a vessel traversing a muscle. Here the blood is diffused and a coagulum is formed, which is in contact, on the one hand, with the blood; on the other, with the liquid moistening the muscle; hence a reducing or oxidising action, and the products formed may concur in closing of the aperture. M. Becquerel also explains the chemical reactions in capillary spaces when a voltaic couple is added.—On the formation of ethers, by

M. Berthelot. He here studies ethyloxalic, methyloxalic, acetic, and nitric ethers.—Report on a memoir of M. Peanecellier relating to the conditions of stability of arches.—Memoir on approximation of the functions of very large numbers, and on an extensive class of developments in series (first part), by M. Darboux.—New geometrical properties of the surface of the wave, which are interpreted by optics, by M. Mannheim.—On left curves of the fourth order, by M. Serret.—On the tunnelling operations in Mount Saint Gothard (continued), by M. Colladon. The compressing pumps employed give double the effect of those used in Cenis, and are only half the cost, while they occupy, with their motors, six or seven times less space. Four turbines at Goschenen and Airolo work twelve pumps, and the air obtained at pressure of eight atmospheres is 1,000 cubic metres per hour. The pumps give 200 strokes per minute, night and day. The boring machines used are those of Dubois and François, Ferroux, MacKean, and Turretini.—On the repartition of solar radiation at Montpellier during the year 1875, by M. Crova. The intensity of radiation is shown to reach maxima in spring and winter, and the coefficient of transmissibility in Hérault, is found very considerable, exceeding sometimes 0.80 when the thickness already traversed is equal to 2.—On a new chloruretted propylene, by M. Reboul.—On difficulties connected with the preparation of pure aniline, by M. Rozenstiehl.—On the products of the action of chloride of lime on amines, by M. Tscherniak.—On granular conjunctivitis; *résumé* of two missions having for object the study of diseases of the eye in Algeria, by M. Gayal. The disease named is endemic in the region of the Tell and of Sahara. It is often developed through contagion with the secretion; and among local causes are the hot winds charged with sand, the solar reverberation, and the difference of temperature between day and night.—Crystallisation of meteoric waters, by M. Tissandier. In a drop of snow-water evaporated, a number of cross or dagger-shaped crystals are had; the form often taken by nitrate of ammonia in meteoric water. M. Tissandier tried in vain to reproduce such crystallisation artificially from dilute solutions of nitrate of ammonia; he always got crystals ramifying about a median line. He attributes the other form to presence of organic matters.—On the traces of dislocation presented by the tertiary formation in the valley of the Oise.

## BOOKS RECEIVED

BRITISH.—Dr. Dobell's Reports on Diseases of the Chest. Vol. I, 1875 (Smith, Elder & Co.)—The Theory of Screws: Dr. R. S. Ball, F.R.S. (Hodges, Foster, and Co., Dublin).—Lessons from Nature: St. George Mirarr, F.R.S. (John Murray).—Royle's Materia Medica. 6th edition. Edited by Dr. Harley (Churchill).—Cattle and Cattle-Breeding: Wm. M'Combie, M.P. (Blackwood and Sons).—Excavations at the Kestlerloch: Conrad Merck (Longmans).—Marsden's International Numismata Orientalia: Part II. (Trübner and Co.).—The Native Races of the Pacific States of North America. Vol. V.: H. H. Bancroft (Longmans).—Reliquiæ Aquitanicæ: Lartet and Christie (Williams and Norgate).

## CONTENTS

	PAGE
THE LISBON MAGNETIC OBSERVATIONS. By JOHN ALLAN BROWN, F.R.S.	301
MARSDEN'S "NUMISMATA ORIENTALIA"	302
VAN BENEDEN'S "ANIMAL PARASITES." By Dr. T. S. COBBOLD, F.R.S.	303
OUR BOOK SHELF:— "The Scholar's Algebra"	304
LETTERS TO THE EDITOR:— Fritz Müller on Brazil Kitchen Middens, Habits of Ants, &c.— FRITZ MÜLLER	304
Prof. Tyndall on Germs.—Prof. JOHN TYNDALL, F.R.S.; L. PASTEUR	305
The Evolution of Hæmoglobin.—H. C. SORBY, F.R.S.	306
The Flame of Common Salt.—Dr. ARTHUR SCHUSTER	306
Science at Hastings.—ARTHUR RANSOM	306
OUR ASTRONOMICAL COLUMN:— The Variable Star R. Leporis	306
Saturn's Rings	307
The Minor Planet, Hilda (No. 153)	307
The Total Solar Eclipse of 1706, May 11-12	307
HUNTERIAN LECTURES ON THE RELATION OF EXTINCT TO EXISTING MAMMALIA, I. By Prof. FLOWERS, F.R.S.	307
MADAGASCAR	308
SCIENCE AND ART IN IRELAND	309
MINIATURE PHYSICAL GEOGRAPHY (With Illustrations)	310
PHYSICAL SCIENCE IN SCHOOLS. By Dr. N. MARSHALL WATTS	311
Prof. MAX MÜLLER	312
Prof. NORDENSKJÖLD ON THE JENESSEI. By Prof. A. E. NORDENSKJÖLD	312
ON THE SPECTRUM OF NITROGEN AND THAT OF ALKALINE METALS IN GIBBS'S TUBES. By M. SALET	314
NOTES	314
SCIENTIFIC SERIALS	317
SCIENTIFIC AND ACADEMIC	317
BOOKS RECEIVED	320

THURSDAY, FEBRUARY 24, 1876

## REPORT OF THE VIVISECTION COMMISSION

NO one who examines this voluminous Report of the Commission appointed some months ago to inquire into "the practice of subjecting live animals to experiments for scientific purposes," can deny that the Commissioners have done their work thoroughly, as they have done it without delay. The Commissioners evidently entered upon their important inquiry with the determination of discovering the whole truth as to the practice of vivisection, and of eliciting the opinions and reasons not only of its advocates but of its most determined opponents. A mere glance at the long list of names of the witnesses will serve to assure anyone that the evidence which has been obtained is the expression of the most weighty and trustworthy opinion on both sides, and both the advocates and opponents of the practice must feel relieved that the Commission was appointed and has done its work: the former will be glad that the true condition of things is now before the public, that the worst, so to speak, is known, and the latter that they now know definitely what they have to contend against.

The bulk of the blue-book is of course occupied by the evidence. Prefixed to this is the Report and recommendations of the Commissioners, and in the Appendices are contained various documents which throw light upon the inquiry and enable the reader to learn exactly what has been done in the matter up to the present time, and what will be the starting-point of Parliament in discussing the Report. We need do little more here than lay the Commissioners' recommendations before our readers. In their Report they candidly discuss the varied methods and uses of experimenting on living animals, the bearings of the evidence elicited during the inquiry, as well as every possible suggestion as to what legislative action ought to be taken in reference to the matter. As might be expected from the character of the men who compose the Commission, every point of importance is brought prominently out, the subject is looked at all round, and from every point of view. Their recommendations, therefore, which they give after briefly referring to the two Bills of last session, will without doubt have great weight with all who take an interest in the matter. They are as follows:—

"What we should humbly recommend to Your Majesty would be the enactment of a law by which experiments upon living animals, whether for original research or for demonstration, should be placed under the control of the Secretary of State, who should have power to grant licences to persons, and, when satisfied of the propriety of doing so, to withdraw them. No other persons should be permitted to perform experiments. The holders of licences should be bound by conditions, and breach of the conditions should entail the liability to forfeiture of the licence; the object of the conditions should be to ensure that suffering should never be inflicted in any case in which it could be avoided, and should be reduced to a minimum where it could not be altogether avoided. This should be the general scope of the conditions; but their detailed application should be left to be modified from time to time by the minister responsible according to the dictates of experience. In the administration of the system generally, the responsible minister would of course be guided by the opinion of advisers of competent knowledge and experi-

ence. Dr. Playfair's bill provided a machinery for the purpose, and some arrangements of the kind proposed in that measure would be necessary. But we think it is inexpedient to divide the responsibility of the Secretary of State with that of any other persons by statutory enactment, and we recommend that his advisers should be from time to time selected and nominated by himself. Their names should be made known to the profession and the public. It may be found desirable that one of the conditions to be attached to a licence should be that the experiments should be performed in some particular place; but this is a detail which may vary with circumstances, and we think it ought not to be stereotyped by statute.

"The Secretary of State must have the most complete power of efficient inspection and of obtaining full returns and accurate records of all experiments made. Any place in which experiments are performed must be registered and open to efficient inspection. The appointment of an inspector or inspectors will be necessary, and we have seen that the analogy of the Anatomy Act has been appealed to by many high authorities. It is to be observed that the duties under that Act are of a nature much more mechanical than those which will be required in the present instance. The inspectors must be persons of such character and position as to command the confidence of the public no less than that of men of science.

"Abuse of the power conferred by the licence must, of course, render the holder liable to its withdrawal; but this will involve great disgrace; and the withdrawal of the licence of an eminent man without real cause might be a serious public mischief. We have felt it necessary, therefore, to consider what steps should be taken when the question of such withdrawal may arise. We think that the holder of a licence, when he shall receive notice that the Secretary of State intends to withdraw it during the period for which it has been granted, should be at liberty to demand a public inquiry; that this inquiry should be held before one of the Judges of the Supreme Court, with two competent assessors to be appointed by the Secretary of State, the Court having the full power of conducting it as a legal investigation by summoning and swearing witnesses, issuing commissions, and so forth:—that on the result of this inquiry, the Secretary of State should determine whether the licence ought to be withdrawn, and when he decides in the negative, should have the power of giving the holder of the licence the reasonable costs of his defence.

"Magistrates ought to be empowered, on cause shown, to authorise the police to enter and search the premises of persons suspected of performing experiments without a licence, and the performance of such experiments without a licence should be penal.

"It has been suggested that cases may occur in which an urgent necessity may have occasioned an experiment when there has been no licensed person within reach, and it has not been possible to apply for a licence; such as a sudden case of suspected poisoning, arising, perhaps, in a remote place, when the experiment has been reasonably considered indispensable, for the purpose either of cure or of medico-legal investigation. *Bonâ fide* cases of this kind ought evidently to be free from the risk of vexatious prosecution, and this can be secured by vesting in the Secretary of State the power of putting a veto on a prosecution.

"We believe that by such a measure as we have now proposed the progress of medical knowledge may be made compatible with the just requirements of humanity. In zeal for physiology, the country of Harvey, Hunter, Bell, and Darwin may well endure the test of comparison. We trust that Your Majesty's Government and the Parliament of this kingdom will recognise the claim of the lower animals to be treated with humane consideration—and will establish the right of the community to be

assured that this claim shall not be forgotten amid the triumphs of advancing science."

The recommendations, we are confident, will meet with the approval of all moderate persons on both sides. Indeed, some may be inclined to think that Science has made too great concessions to popular feeling; that she has made concessions all who take the trouble to read the Report and evidence will allow. The reasonable opponents of vivisection will no doubt also be prepared to make concessions, as they must admit that, after the evidence adduced in this inquiry, its uncompromising suppression would be a calamity to humanity; and they must also admit that the outcry of "cruelty to animals" has had a very slender justification. We hope the Report will speedily be brought before Parliament, and the recommendations essentially adopted, so that both for the credit of science and for the satisfaction of popular feeling the practice may be carried on under well-defined and universally understood regulations.

#### "THE GEOLOGICAL RECORD"

*The Geological Record for 1874.* An Account of Works on Geology, Mineralogy, and Palæontology, published during the year. Edited by William Whitaker B.A., F.G.S., of the Geological Survey of England. (London: Taylor and Francis, 1875.)

THE late Sir Charles Lyell used to relate how, on the occasion of a visit which he paid to M. Deslongchamps at Caen, the eminent French palæontologist rose from the piles of books amid which he was working, and exclaimed, with a sigh of relief, "Let us devoutly thank Heaven that our lot is not cast with the next generation of geological workers!—for how they will manage to grapple with the ever-increasing literature of the science I am at a loss to conceive." The difficulty which Deslongchamps thus playfully anticipated is now a present and pressing one, which, it is not too much to assert, is almost painfully felt by every scientific student and worker. While, on the one hand, it is absolutely impossible that any man can read everything that issues from the press relating even to his own department of science, yet, on the other, no one can afford to neglect the results which are being obtained by his contemporaries. It is sad to remember that a large part of the energy of the illustrious Dalton was wasted—owing to his not being able to make himself acquainted with what other chemists of his day were accomplishing—in solving problems which had been already completely disposed of. And we are persuaded that the painful questions of priority in discovery which frequently arise between the workers in the same branch of science ought to be referred, not to the existence of petty jealousies or of a disposition to take unworthy advantages, but to the difficulty which each investigator finds in consulting the latest published results of his fellow-workers in the same paths of inquiry.

So far as relates to the scientific memoirs of past years, the Royal Society has conferred an inestimable boon on the labourers in every department of science by the publication of its admirable "Catalogue," for the appearance of the first supplement to which we are now anxiously looking forward. Aided by a grant from the British Association, too, the "Zoological Record" gives a yearly summary of the work which is being accomplished in that

department of science. It has long been felt as a serious and yearly increasing want—though one which has been already to some extent met by publications in France, Germany, and Switzerland—that no similar work of reference for the geological sciences has hitherto appeared in this country. We are now happy to inform the readers of NATURE that this want has been very admirably supplied by the volume, of which the title appears at the head of the present article.

In the preface to this work the editor gracefully notices the important services rendered by his fellow-workers, but he has not referred to the great difficulties which attended the first establishment of this important year-book of reference; for the overcoming of which difficulties we are mainly indebted to his own energy and perseverance. When the proposal for this work was first drawn up by Mr. Whitaker—whose well-known works on Tertiary Geology, and especially those relating to the vicinity of the metropolis, gave him such claims on the confidence of geologists—the Council of the British Association did not find itself in a position to accord to it immediately the same assistance as it annually gives to the "Zoological Record." Undeterred by this preliminary difficulty, however, Mr. Whitaker determined to proceed with his task unaided. A list of guarantors was formed, who agreed to indemnify the editor against pecuniary loss; and among those who thus signified their sense of the importance of the work, we find the names of Lyell, Poulett-Scrope, and Logan, who have not lived to witness its publication, together with those of almost all the leaders of geological science in this country. Happily, the sale of the work has sufficed, even during this its first year of publication, to cover all expenses; and a grant from the British Association will serve to remove any anxieties which the editor might have felt as to its future.

In the plan of the work we think that Mr. Whitaker has exercised a very wise discretion. He has not attempted anything like reviews or critical notices of the various books and memoirs which he catalogues. In the publications in which this has been done, like the "Die Fortschritte auf dem Gebiete der Geologie, 1872," edited by Dr. Hermann J. Klein, or the "Revue Géologique Suisse pour l'Année 1874" of Ernest Favre, we have nothing like the complete work of reference supplied by the publication of the "Geological Record." In the latter, the notices of the various contributions to geological science are confined to terse statements of the subjects treated in them, with an enumeration of the plates and maps by which they are illustrated. Where, however, a short account of recent discovery or a summary of a new classification could be given in a few lines, or the bearing of a memoir on the progress of science briefly indicated, this has been often well done in the work before us.

The difficult task of classifying the memoirs according to the various subjects of which they treat has been, on the whole, very successfully accomplished; and for the general superintendence of the work, Mr. Whitaker has secured the aid of a number of well-known cultivators of different departments of the science to act as sub-editors. Mr. Topley takes the departments of British and Economic Geology; Mr. Labour deals with the works relating to Europe, the Arctic Regions, and America; Mr. Drew with those on Asia; and Mr. Robert

Etheridge, jun., with those referring to Australasia. The important department of Physical Geology has been undertaken by Prof. Green, and those of Mineralogy and Petrology by Prof. Rudler; while the science of Palæontology has been equally well cared for—Mr. Miall taking the papers referring to the Vertebrata, Prof. Nicholson those relating to the Invertebrata, and Mr. Carruthers those on Fossil Plants. Besides the sub-editors, a number of other contributors have given their assistance in connection with this important work.

When we reflect on the immense body of literature on the different branches of the natural sciences which is yearly published, we shall find good reason to be satisfied with the approximately complete character already attained by this, the first volume of the "Geological Record." It is only necessary to refer to the yearly increasing activity of our great scientific societies, the continual formation of new local associations and field-clubs (whether connected with particular districts or with our Universities and public schools), most of which publish their own transactions, to show the difficulty of making a complete catalogue even of the scientific publications which appear yearly in the British Islands alone. But when we add to these the prolific publications of the different State surveys and the numerous scientific institutions of the United States and of our own colonies and dependencies; when we bear in mind the scientific activity exhibited by the French, German, and Italian speaking populations of Europe, and the books and journals written in languages, which of course few scientific men are able to read, such as the Russian, Danish, Dutch, Scandinavian, Hungarian, Bohemian, Serbian, &c.; and when we recollect that geological memoirs are published even in Japan and Tahiti!—we may have some idea of the magnitude and difficulty of the task with which the conductors of the "Geological Record" have to grapple.

In illustration of the energy which has been brought to bear upon this task, we may mention that the first volume of the "Geological Record" extends to nearly 400 pages; that the journals of which the contents, so far as they relate to geology, have been given in abstract, number nearly 200; and that the separate entries of books, memoirs, and maps exceed 2,000.

Henceforward, the yearly volumes of the "Geological Record" must find a place on the shelves of every scientific library; and in congratulating the editor on the manner in which he has surmounted the first and greatest difficulties of his arduous undertaking, we find only one cause for complaint. So far as the title-page shows, no arrangements have been made with agents residing abroad for the circulation of the work in America, the colonies, and on the Continent. We are persuaded, so very general is the use of the English language among the scientific men of all parts of the world, that so soon as this omission is remedied, the foreign circulation of the "Geological Record" will equal or even exceed that which it already has at home; while most valuable aid will be given in the preparation of the future volumes of the work by the secretaries of foreign societies and the editors of Continental and American journals sending copies of their publications, immediately that they appear, to the conductors of this important work of reference.

J. W. J.

## OUR BOOK SHELF

*Lessons on Rigid Dynamics.* By the Rev. G. Pirie, M.A. (London: Macmillan and Co., 1875.)

THIS work treats of the geometry of motion, D'Alembert's principle, reduction of the expressions for the effective forces, moments and products of inertia, energy, precessional motion, and certain differential equations which occur in treating of the subject of Rigid Dynamics. There is an excellent selection of exercises, many of which are worked out, and the answers are in many cases accompanied by useful hints. The book appears to us to be in every respect an admirable one, and to be a good introduction to the study of this difficult branch of natural philosophy. We agree with Mr. Pirie in thinking that much of the difficulty students find in this subject arises from the explanations which are given in the ordinary text-books being for the most part brief and often, in consequence, obscure. We believe the author's hope that his book may be useful not only to students of natural philosophy, but also to engineers, is likely to be realised. We cordially recommend the book.

*The Secret of the Circle, its Area Ascertained.* By Alick Carrick. (London: H. Sotheran and Co. Chiswick Press, 1876.)

ONE more contribution to the long list of works on the Circle, put forth with the usual assurance that now the question must be set at rest. "Dedicated with great deference to the different schools of learning and to the intelligence of the public generally in this and other countries, in the confident hope and full belief that the truth pointed out in these pages will soon be acknowledged." There is a prefatory notice taking us down to page 16 (there are 48 pages in the pamphlet), from which we learn that the author's name is an assumed one, and that he is now dead. "Introductory" takes us to page 39. "The Secret of the Circle, its Area Ascertained," occupies the rest of the book. The Rule given is, "Diameter  $\times$  radius  $\div$  four-sevenths" (*sic*), hence our friend  $\pi$  is equated to  $\frac{22}{7}$ . There are ten figures, some

pretty to look at, but there is a dearth of letters, and it is often hard to make out what parts are intended in the demonstration. There is much that is true and not new; for instance, that the inscribed dodecagon is equal to the inscribed square and half that square; what is new is not proved to be true. Thus to get the result, the circular segment bounded by the side of the dodecagon ought to be for his purpose  $\frac{1}{84}$  (radius)<sup>2</sup>, and this is not shown on

pp. 44, 45, for it is not proved there that Q contains the nine segments which it is said to contain. Hence we are led to say that the truth about the Circle is *not* to be found *here*.

*Australian Heroes.* By Charles H. Eden. (Society for Promoting Christian Knowledge).

MR. EDEN has written a very interesting book. As might be surmised from the title, he has brought into prominence the adventures of the explorers of Australia rather than the results of their explorations. Australia is unlike almost any other country which has been the field of exploration; its sameness, the dreary tameness of the bulk of the continent, the comparative paucity and low state of the aborigines, deprive an explorer's narrative of many of the points of interest to be met with in the case of other countries—Africa, for example, South America, or even the Arctic regions. Still this little book shows that during the comparatively brief period that Australia has been a field for exploration, there have been plenty of deeds of daring and determination and self-sacrifice in the cause of scientific knowledge, to render any skilfully

written narrative of Australian discovery interesting. Mr. Eden has told the story attractively, and the reader will not only be greatly interested, but will have a fair idea of what has been done to extend our knowledge of the "fifth continent" from its first discovery down to the trans-continental journeys of Warburton and Forrest—the latter, however, being referred to in a sentence or two.

### LETTERS TO THE EDITOR

[The Editor does not hold himself responsible for opinions expressed by his correspondents. Neither can he undertake to return, or to correspond with the writers of, rejected manuscripts. No notice is taken of anonymous communications.]

Dr. Bastian and Prof. Tyndall on Spontaneous Generation

I BEG you to allow me a few lines to protest, as Prof. Tyndall has done elsewhere, against Dr. Bastian's proceeding, in citing a number of observers in support of his views (NATURE, vol. xiii. p. 284), whose researches taken in each case—as a whole—furnish conclusive arguments against his views.

It is only by an inadequate statement that the observations of Dr. Pöde and myself—which appear in Dr. Bastian's list—can have this signification attached to them. Where we obtained the result which Dr. Bastian obtained, we were able to trace it to a violation of the experimental conditions. Our results conclusively and categorically contradicted the particular assertions contained in Dr. Bastian's book, the "Beginnings of Life," into the truth of which we set ourselves to inquire.

Feb. 16

E. RAY LANKESTER

### Radiometers and Radiometers

I HAVE recently been trying some experiments with a radiometer, obtained from Mr. Browning, and as some of my results are different from what I was led to anticipate, I should like to know whether there is anything special in my particular instrument, or whether other people have noticed the same things.

In Mr. Crookes' paper on "The Mechanical Action of Light," *Quarterly Journal of Science*, No. xlvii. p. 343, he states that "when only dark heat is allowed to fall on the arms [of the radiometer], as from a vessel of boiling water, no rotation whatever is produced." (The italics are mine.)

Now I find that my radiometer is particularly sensitive to dark heat, the presence of a heated copper wire, or still more that of an iron poker when only slightly warmed, instantly accelerating the number of revolutions.

But more than this: when exposed in a room to diffused daylight, the velocity of rotation is greatly influenced by the temperature of the room, and is by no means an indicator of the amount of light only.

One morning this week during the frost, upon looking at my radiometer, it appeared to be motionless, although standing not far from my study window. When placed nearer to the light it revolved, but so slowly that I thought the instrument must have received an injury. The room at the time was very cold, as the fire had not been lighted. After the fire had been lighted and the temperature of the room raised, the velocity of rotation increased, and upon observing the instrument just before dark, when the room was very warm, the rotation was considerably greater than it had been in the window in the middle of the day, although at the time there was only just enough light in the room to enable me to see the instrument at all. When I brought the radiometer near to the fire, which consisted only of dull hardly glowing coals, the rotation of the arms became so rapid as to render them almost invisible.

Upon taking the instrument out of doors between five and six o'clock in the afternoon, the thermometer a few degrees below freezing-point, the arms revolved slowly from right to left as usual, but upon bringing it near to a mass of snow, and shading the light off by some pieces of wood, I could see that the arms revolved slowly in the opposite direction, that is, in the same direction as the hands of a watch. Later in the evening I held the instrument in the open air in bright moonlight, the thermometer being at 24° F., and the rotation was again in the same direction as the hands of a watch. The next morning, when the temperature was nearly the same, but the air foggy with only feeble light, the arms revolved at about the same rate but in the

usual direction, from right to left. In the evening I again held the radiometer in the moonlight in the cold frosty air; the rotation was as before, from left to right. Carrying the instrument in my hand I approached the house, the hall door of which stood open. As I came within reach of the light and heat the rotation diminished, and at length ceased, but upon entering the hall it commenced again, only in the opposite direction. In fact, I could stand in such a position that upon moving a few feet either way, I reversed the direction of rotation, while between the two there was no motion at all.

I afterwards repeated the experiment in a different form. I placed the instrument in a cupboard in a very cold room, with a considerable quantity of ice. Upon just opening the cupboard door and peeping in, I could see that the arms were revolving very slowly, but distinctly, from left to right. Upon opening the door a little wider the motion ceased, and when still more light was admitted the motion was reversed. I then removed the ice and nearly closed the door—the rotation ceased entirely; but upon introducing a piece of heated iron the arms spun round as fast as they usually do in full sunlight, and this, be it remembered, when the cupboard was almost dark, the door being only just sufficiently open for me to see the instrument, certainly not more than a quarter of an inch.

T. N. HUTCHINSON

Rugby, Feb. 12

Since writing the above, I have been favoured with a note from Mr. Crookes, in which he points out to me that his results have been obtained by means of radiometers constructed with *pink* discs, and having no metal at all in the moving parts. In the little instrument that I have used the discs are of mica, blackened, of course, on the alternate faces, but mounted upon four metallic arms, apparently aluminium foil. Mr. Crookes observes: "I long ago gave up metallic instruments owing to their erratic movements while radiating or absorbing heat. I have mentioned this peculiarity of metallic radiometers in my papers for the Royal Society."

As this difference between the instruments used accounted, to some extent, for my obtaining results so different from those described by Mr. Crookes in the paper referred to, I felt at first that there was no further need to trouble you with these remarks, and that they had better be consigned to the waste paper basket. Upon second thoughts, however, it seems to me that there is still something that requires explanation, or, at all events, that I do not understand, in the different action of dark heat on pith only, and on mica mounted on thin metallic arms. The four arms are very fine, equally bright, and similar in all respects, hence it is difficult to see how rotation should be produced by the action of heat on the metallic parts of the apparatus. The vacuum, no doubt, is not so perfect as that obtained by Mr. Crookes with his exquisite Sprengel pump, but even this would hardly account for the "erratic movements" that I have observed.

I may add that since performing my experiments I have learnt that one of my pupils in Rugby School, Mr. H. F. Newall, has observed very similar results with a radiometer in his possession.

T. N. H.

### The Sailing Flight of Birds

HAVING had during several long voyages in the Pacific considerable opportunities for observing closely the flight of sailing birds, and especially of *Diomedea melanophrys*, or "Mutton Bird," as I believe it is called by the Australians, a few suggestions on the subject may perhaps not be uninteresting to your readers.

This bird differs considerably in size from the albatross of the Cape, but as the principles of its flight are the same, the few suggestions I wish to make will apply with equal force to both species, and indeed to all sailing birds.

The *Diomedes* of the Cape it is well known can support itself in the air for a very long time without flapping its wings, and in "The Reign of Law" it is stated that "sometimes for a whole hour together this splendid bird will sail or wheel round a ship in every possible variety of direction, without requiring a single stroke of its pinions." This may be accurately true, but in the case of the smaller albatross I refer to, between one and two minutes, or perhaps 1,000 or 2,000 yards in space, is more approximately the limit to which the bird's power of sailing is exercised. When the flight begins after rest the bird appears to feel very considerable difficulty in rising from the sea. It runs along the surface for some distance, flaps its wings very vigorously, and continues to do this after it has left the water, until it acquires a



satisfactory velocity. Its subsequent sailing flight until it again increases its rate of speed by flapping, I would suggest to be merely a utilisation of this original *vis viva* to the utmost possible advantage, the ascending and descending movements of the bird being nothing more than a change from actual to potential energy, and *vice versa*. Suppose, for the sake of simplicity, that the wind is dead ahead, and that the bird commences sailing horizontally with a certain *vis viva*. With this, by fixing its wings so as to present inclined planes to the direction of the wind, it is able to rise to a certain height, the velocity decreasing in some ratio to the ascent, and if the highest point capable of being reached is attained, the bird for the instant comes to rest; up to this moment the actual energy has been gradually changing into potential, and the bird gaining thereby a position of advantage. It is, however, extremely rare that this position is attained—most frequently the horizontal velocity is only partially destroyed. The planes of the wings being now changed with reference to the direction of the wind, the bird begins to descend; the potential energy is transformed into actual, and velocity is acquired, to be again changed into potential, and so on until it becomes necessary to renew it. The line of flight, therefore, of an albatross going directly against the wind consists of a series of undulations, the summits of which correspond to the instants of least relative velocities, or positions of greatest potential advantage; whilst the lowest points correspond to the instants of greatest relative velocity and least potential advantage.

During all this time *vis viva* is of course being extracted by the resistance of the wind, and the velocity after a while is so diminished that the bird loses its power of rising to a satisfactory position of advantage. It is then that flapping recommences and new power of flight is acquired. When it is remembered that the weight of a Cape albatross varies from 16 lb. to 20 lb., and the stretch of wings from 10 to 12 feet, it will be evident how great is the potential energy of such a bird at the height say of 100 feet, and also how complete is its power of utilising that energy. The question may be asked, how long will it be before 2,000 foot-pounds of work have been extracted by air moving at the rate of sixty miles an hour? for until it has been extracted, or nearly so, the sailing flight of the albatross need not cease. By means of a suitable mechanism for changing the inclination of the wing planes every few seconds, the sailing of the albatross, I believe, might be simulated without great difficulty. It is generally supposed that the stronger the wind the greater is the power of sailing-flight. In the special instance referred to, viz., that of sailing directly in the teeth of the wind, this is not the case. A good breeze is evidently better than either a very strong wind or a calm. In the one case, a too great resistance destroys the *vis viva* too rapidly; in the other, the bird suffers from a want of sufficient resistance, very much as a kite does during a calm.

In sailing in any other direction a violent wind may more or less aid the flight, and the velocity attained in some instances be enormous and very deceptive. It is this element, viz., the velocity acquired by sailing obliquely with the wind, that is so difficult for the eye to eliminate in estimating the actual power of the bird to sail against the wind. In flying with the wind, the resistance to the stroke being greater, the necessary speed may be more rapidly acquired and with fewer strokes, provided the bird has the requisite strength. But, as might naturally be supposed, sailing directly with the wind for any considerable distance is rarely or never seen, the bird not finding sufficient resistance in the air for its support.

From what has been said it will appear that the superior sailing power of the albatross, in comparison with other birds, is due—

(1) To its ability to acquire readily very great *vis viva* by means of its extremely powerful wings.

(2) To its almost perfect power of utilising this *vis viva* for the purpose of ascending or descending, i.e. of changing from a position of greatest actual to greatest potential energy and *vice versa*, with least loss of power through resistance of the air.

The above implies an extraordinary rigidity as well as absence of concavity of the wings, by which the bird is enabled to hold them in their place like two rigid planes, and thereby present their surface to the wind under the most favourable circumstances possible. The tremulous movement seen at the tips appears to be nothing more than vibrations due to the want of absolute rigidity in the pinions. The above suggestions, if tenable, furnish an explanation also of the flight of the flying fish—the undulatory motion, or rising over the crest of a wave, which has puzzled so many casual observers, being merely a change of some of the *vis viva* of its flight into potential energy. This means necessarily a loss of

velocity depending on the amount of rise, and implies the power of the fish to change its wing planes so as to ascend or descend. The original *vis viva* has of course been created by a preliminary rush through the water before emerging.

It will be seen from what has been said that the principle suggested, rightly or wrongly, as fully explaining the flight of the albatross, is that of a body—gifted with the most perfect power of placing itself in a position of advantage—sliding up and down inclined planes under the most perfect conditions possible.

R. A.

#### The Use of the Words "Weight" and "Mass"

In the review of Dr. Guthrie's "Electricity and Magnetism" (NATURE, vol. xiii. p. 263) the following words occur in reference to Dr. Guthrie's definition of the absolute unit of electric resistance: "Here, irrespective of other considerations, there is the fundamental error of using the term *weight* instead of *mass*."

It is very unfortunate that the word "weight" is ambiguous; and that the ambiguity is actually so great as to lead to all but universal confusion of ideas. It is *not* really improper to use *weight* as synonymous with *mass*, and, had Dr. Guthrie meant to refer to *mass*, his using the term *weight* would not have constituted any fundamental error. He would only have been using an old ambiguous word in the more authoritatively established of its two common meanings. By an Act of Parliament (18th and 19th of Victoria, Chapter 72, July 30, 1855) for the special purpose of establishing standard weights and measures, it is enacted that a certain piece of platinum referred to as a "weight of platinum" shall be denominated the Imperial Standard Pound Avoirdupois, and shall be deemed to be the only standard of weight from which all other weights and other measures having reference to weight shall be derived, computed, and ascertained. The gravity of a mass, or of a piece of matter, is not once named, or in any way referred to, in the Act as a thing for which a standard is meant to be established by that Act, nor is the word *force* or the notion of force put forward in any way in the Act. Thus the meaning attributed in the Act to the word *weight* is the same as is distinctly expressed in scientific language by *mass*.

However, on turning to Dr. Guthrie's book itself, I found a striking example of the troublesome perplexity which is involved in the ambiguity of the language in common use. A few lines below the passage touched on by the reviewer, the following sentence and appended note occur. (Text), "From the work done by the current in the experimental wire, the resistance in that wire is found, and this resistance is considered unity when the above measures are units, namely, 1 second time, 1 meter space, and 1 gram weight or force." (Note appended), "The force actually taken as unity is  $\frac{1}{981}$  gram, for this force acting on 1 gram for 1 second will give it a velocity of 1 meter a second." The text and the note are utterly irreconcilable. The confusion is complete.

I do not say that no one can possibly understand the subject with the common nomenclature; but I do say, from considerable experience in Glasgow University, where we are in the habit of using the absolute or kinetic system of force-measurement in *all* our calculations with the students of the Natural Philosophy Class, that it is extremely difficult to explain, with the old nomenclature, the beautiful, and in itself simple, kinetic system of Gauss, together with its connection with the gravitation system of force-measurement.

This session, however, I have found a very great simplification in adopting a suggestion of Prof. James Thomson to do away with the word *weight* altogether in cases in which its employment would involve ambiguity. He would still readily use the name, a pound weight, for the standard piece of iron or brass used in weighing; and would continue, so long as our present non-decimal system is maintained, to use the commercial term, a hundredweight of iron, meaning a certain quantity or mass of iron. But he has proposed that when we mean *mass* we should avoid the word *weight* as far as possible and use the word *mass*, and that where we mean downward force due to gravitation, called by Dr. Guthrie and his reviewer, *weight*, we should use the word *gravity*. Thus we may speak of a one pound force, or we may say "the gravity of a pound," but never "the weight of a pound." We can scarcely get rid altogether of connecting the idea of heaviness with the word *weight*, nor would our dictionaries at present allow us to do so; but it is quite proper to feel that, in speaking of a certain weight as being too great to

be resisted by a certain chain, we are using a colloquial and inaccurate expression, like calling a door *heavy* when we are not attempting the feat of Samson, but merely opening or shutting it, turning it on its well-oiled hinges.

During the present session we have aided ourselves in Glasgow with four very important helps to the teaching of the kinetic system of force-measurement. One is the improvement in nomenclature just referred to. The second is the use of names for the kinetic units of force. The British Association has sanctioned the use of the name *Dyne* for the kinetic unit of force founded on the centimetre, gramme, and second, as units of length, mass, and time respectively. Prof. James Thomson has given the name *Poundal* for the British kinetic unit of force founded on the foot, pound, and second. The third help is the construction by Prof. Thomson, for the first time, so far as I know, of spring balances for indicating poundals and kilodynes. The fourth aid is Dr. Everett's admirable book on the C. G. S. system of units.

J. T. BOTTOMLEY

University of Glasgow, Feb. 7

#### Seasonal Order of Colour in Flowers

I AM very much obliged to Mr. Buchan for his elaborate paper in *NATURE*, vol. xiii. p. 249, on the Flowering of Spring Plants (see my query, *NATURE*, vol. xiii. p. 129). Although agreeing with Mr. Pryor that the blue is anticipated by various other colours, yet I think that the method of inquiry by averages is the only basis we can go upon; and that is the plan I have adopted for some time. I have now a carefully-assorted collection of hyacinths, and I see that the blue and white are coming out nearly together, the red showing as yet no colour whatever. What would be the action of light upon blue or red flowers, if the blue or red ray was carefully excluded, if this could be done? Would the flower thrive, and if so, would its colour be much altered?

C. E. HERON ROGERS

Retford, Notts, Feb. 7

#### OUR ASTRONOMICAL COLUMN

VARIABLE STARS.—Herr Julius Schmidt publishes (in *Astron. Nach.*, No. 2,074) the results of observations of variable stars made at Athens in 1875, amongst which the following may be noted:—

1.  $\epsilon$  Bootis, a star to which he had directed attention some years since, as certainly variable though observed with difficulty on account of proximity to  $\epsilon$ , was found to be at a maximum on April 26—a good determination. In 1872 he assigned a period of 369 days from six observed maxima, commencing 1867, July 31, and as many minima, the first, 1867, November 18. Between the maxima of 1867 and 1875, we should have eight periods of about 353 days. The mean place of this star for the beginning of the present year is in R.A. 14h. 37m. 32s., N.P.D.,  $62^{\circ} 54' 1''$ .

2. Mira Ceti. Three curves drawn from comparisons of this star with  $\alpha$  and  $\gamma$  Ceti and  $\alpha$  Piscium gave the date of maximum, February 27.5, March 1 and 3 respectively, of which the latter is preferred. Calculating from the formula of sines in Schönfeld's second catalogue, the maximum of 1875 is fixed to February 24.2. Observed minimum, October 30.

3.  $\eta$  Geminorum.—The variability of this star was detected by Schmidt in 1865, and has since been confirmed by Schönfeld, who found for the brighter phase small and not very regular fluctuations, but for the minima a regular diminution and increase, the first continuing about six weeks, and the last perhaps rather longer. This is in near agreement with Schmidt's previous deductions. He had found by comparison with  $\mu$  Geminorum that  $\eta$  at times remained constant for several months about the maxima, of which, writing in 1869, he states he had been unable to assign the dates. In 1875, however, two maxima were noted, Feb. 25 and Sept. 23; showing an interval of 210 days. The period assigned in the last Mannheim catalogue is 229.1 days. This star is of a deep yellow colour. Variation between extremes of 3.2 and 4.2.

4.  $\epsilon$  Aurigæ.—Schmidt collects the results of his comparisons of the relative brightness of  $\epsilon$  and  $\eta$  Aurigæ, between the years 1843-1875. The star is irregularly variable within somewhat narrow limits.

5.  $\nu$  Herculis.—The principal period appears to be about 38.7 days, but according to Schmidt (*A. N.* 2,075) the curve exhibits waves of about twelve hours' duration, which are of the greatest depth at the principal minimum, and comparatively shallow at the maximum, and he has given a figure explanatory of what he considers to have been the law of variation between 1875, July 4, and Aug. 29. So unique a case appears to require further investigation.

6.  $g$  Herculis.—This reddish-yellow variable was discovered by Mr. Baxendell in 1857, and has been carefully observed by Schmidt. The period, according to Schönfeld, has varied between 40 and 125 days, the star thus resembling in the great irregularity of period the well-known R Scuti, which was discovered by Pigott in 1795. Last year Schmidt's comparisons showed three maxima and two minima, indicating periods 77, 73, and 77 days. The variation extends through little over one magnitude.

7.  $\alpha$  Cassiopeæ.—Of this star Schmidt remarks that the fluctuations of brightness in 1875 were not greater than in the cases of other stars, which are not yet placed upon the variable list.

8. T Coronæ Borealis (Nova 1866).—Mostly ninth magnitude, or rather fainter; exhibiting sensible variation, but to very small amount.

9. R Scuti.—Observed maxima on October 12 and December 8 give the short period of 57 days. The period entered in Schönfeld's second catalogue is 71.1 days. There are great irregularities in the case of this star, not only in the period but in the degree of brightness at both maximum and minimum; the former has been noted between 4.7 and 5.7, and the latter between 6.0 and 8.5.

MINOR PLANETS.—No. 131, *Vala*, discovered by Prof. Peters at Clinton, U.S., 1873, May 24, has so far been unsuccessfully sought at Pola and Berlin between limits of  $-30m.$  and  $+15m.$  in respect to the place of the ephemeris apparently founded on Stockwell's elements; the longitude of perihelion in this orbit differs materially from that given by Knorre's earlier calculation, and possibly a misprint or error of transcription may be the cause of the difficulty.—Prof. Tietjen notifies that the ephemeris of No. 141, *Lumen*, in the *Berliner Jahrbuch* for 1878, is vitiated by an error in *Astr. Nach.*, No. 2,030, where  $\omega$  is substituted for  $\pi$ ; the habit of some computers of giving the orbital angle between perihelion and node, instead of the longitude of perihelion itself, is certainly not without its inconvenience, and this is more particularly the case with early orbits of comets.—No. 156, discovered by Palisa, 1875, Nov. 22, has been named *Xanthippe*.—New elements of No. 158 give a period of 1,889 days, or 5.17 years.

THE SATURNIAN SATELLITE, HYPERION.—Observations of this faint object made with the 26-inch refractor of the U.S. Naval Observatory on forty nights between 1875, June 16 and Nov. 25, appear in No. 2,076 of the *Astron. Nach.* It is stated that the observations were generally made with difficulty. Prof. Asaph Hall acknowledges his obligations to Mr. Marth for his ephemerides of the satellites of Saturn, by which he has endeavoured to facilitate identification of these objects, and which could only have been prepared at an expenditure of much time and trouble.

#### THE DATE OF EASTER

WE revert to this subject with the view to reproduce the arithmetical rule to find Easter Sunday in the Gregorian Calendar, which was first given by the

eminent German mathematician and astronomer Gauss, in *Zach's Monatliche Correspondenz*, 1800.

1. From 1800 to 1899 put  $m = 23$ ,  $n = 4$ .
2. " 1900 to 2099 "  $m = 24$ ,  $n = 5$ .
3. Divide the given year by 19, and call the remainder  $a$ .
4. " " " by 4, " " "  $b$ .
5. " " " by 7, " " "  $c$ .
6. Add  $m$  to 19 times  $a$ , divide the sum by 30, and call the remainder  $d$ .
7. Add  $m$  to 19 times  $a$ , twice  $b$ , four times  $c$ , and six times  $d$ , divide the sum by 7, and call the remainder  $e$ .

Then Easter Sunday is March  $22 + d + e$ , or  $d + e - 9$  of April.

To apply this rule to the present year, we have—

1.  $m = 23$   $n = 4$
2. For  $\frac{1876}{19}$  remainder is 14 . . . . .  $a$ .
3. For  $\frac{1876}{4}$  remainder is 0 . . . . .  $b$ .
4. For  $\frac{1876}{7}$  remainder is 0 . . . . .  $c$ .
5. For  $\frac{23 + 19 \times 14}{30}$  remainder is 19 . . . . .  $d$ .
6. For  $\frac{4 + 0 + 0 + 6 \times 19}{7}$  remainder is 6 . . . . .  $e$ .

And Easter Sunday is March  $22 + 19 + 6 =$  March 47 or April 16; or  $19 + 6 - 9$  of April = April 16.

NOTE.—The following are the two exceptions to the above rule:—

1. If Easter Sunday is brought out April 26, we must take April 19.
2. If Easter Sunday results on April 25 by the rule, the 18th must be substituted when the given year, increased by one, and then divided by 19, leaves a remainder greater than 11.

PROF. FLOWER'S HUNTERIAN LECTURES ON THE RELATION OF EXTINCT TO EXISTING MAMMALIA<sup>1</sup>

II.

THE extinct *Marsupialia*, *Edentata*, and *Ungulata* were treated of fully in the previous course.<sup>2</sup> It is only proposed now briefly to recapitulate the principal results as bearing on the derivative hypothesis, and to call attention to some recent additions to our knowledge of the past history of these groups.

The *Monotremata*, represented only by the *Ornithorhynchus* and *Echidna* of Australia, the lowest and most reptilian of mammals, seem to be the survivors of a group of animals of intermediate structure through which the passage from the lower to the higher vertebrates was made. But of this palæontology has hitherto afforded not the slightest proof. Except some Pleistocene remains of one of the existing genera, no trace of any extinct animal allied to the *Monotremata*, or showing any decidedly intermediate characters between Mammals and the *Sauropsida*, has ever been found. The earliest known remains of mammals—in fact, all those of the Mesozoic period—appear to belong to the *Marsupialia*, although too little is yet known of their general organisation to pronounce definitely on their affinities. As early as the time of deposition of the Purbeck beds, below the Wealden, two very distinct types of dentition prevailed, bearing some resemblance to those characterising the modern polyprotodont and diprotodont types, the one being mainly carnivorous

or insectivorous, and the other frugivorous or herbivorous. True Marsupials, allied to the American Opossums, have been found in the Eocene and Lower Miocene formations of Europe, but not later. Many of the recently discovered insectivorous and carnivorous mammals of the North American Eocenes also appear to have been Marsupials, but the Tertiaries of no part of the world, except the Australian Pleistocenes, have yielded forms allied to the Wombats, Kangaroos, and Phalangers, now so characteristic of the fauna of that land.

Palæontology teaches scarcely anything of the past history of the *Edentata*, an order which might be supposed from the diversity in structure and geographical distribution of the animals now included in it to have occupied a conspicuous position formerly in the fauna of the world. The American gigantic Pleistocene forms, the *Megatherium*, *Glyptodon*, and their allies, are of great interest, but they are all closely related to the existing species of the same countries, and their progenitors have hitherto been sought in vain in the earlier formations of the country. Apparently they formed no part of the Eocene or Miocene fauna of the northern part of the Continent. The European Miocene *Edentates*, *Macrotherium* and *Ancylotherium*, appear to be more related to the existing Old World forms, but their structure is as yet very imperfectly known.

The difference between the *Perissodactyle* and *Artiodactyle* Ungulates was fully established in the earliest tertiaries, beyond which we are not able to trace their history. Recent researches of Leidy, Cope, and Marsh have enabled us to form a tolerably connected idea of the history of both these groups in North America. Before 1869 not a single Eocene *Perissodactyle* had been discovered in that country; it is now known that while the *Lophiodons* and *Palæotheriums* flourished in the Old World, similar forms ranged through the sub-tropical forests of the regions in which the stupendous mountain ranges of Western North America have since been elevated. None of these appear to be identical specifically with the European forms, and even the generic indications, being often founded only on very limited portions of the organisation, as a few teeth, must be regarded as provisional. The best known forms, *Hyrachyus* and *Palæosyops*, are respectively *Lophiodontoid* and *Palæotheroid*. Some are allied to the *Hyracotherium*, one of which, *Orohippus*, seems to connect that form directly with *Anchitherium*. One form only, *Dicerotherium*, is *Rhinocerotoid*; it is found in the uppermost Eocene strata of Utah, and gives the earliest indications of this group yet known. It seems to be connected with the lower Eocene *Hyrachyus* on the one hand, and the Miocene *Hyracodon* on the other. In the Miocene period, the *Perissodactyles* attained a great development of form and size, and the groups became more differentiated, and some of them highly specialised. True tapirs do not seem yet to have been met with. The *Palæotheroid* and *Lophiodont* forms had nearly, if not quite, died out, but the more horse-like *Anchitherium* was abundant, and appears to have continued the line from the Eocene *Orohippus* (which had four toes on the fore foot) to the true horses of the Pliocene period. *Rhinocerotoid* forms now became ascendant, being represented by *Dicerotherium* with a pair of lateral horns on the nasal bones, *Hyracodon*, a very generalised hornless *Rhinoceros*, with the complete number of incisor and canine teeth, and several species assigned to the European genus *Aceratherium*. But the most remarkable of the Miocene *Perissodactyles* of North America are a number of species of gigantic size, to the first known of which Leidy, in 1853, gave the name of *Titanotherium*, and of which other, or perhaps the same, forms have been named by Marsh *Brontotherium*, and by Cope *Symborodon*. Their head was large and much elongated, as in the *Rhinoceros*; but they had a pair of stout diverging osseous protuberances like horn cores on the nasals or anterior part of

<sup>1</sup> Abstract of a course of lectures delivered at the Royal College of Surgeons "On the Relation of Extinct to Existing Mammalia, with Special Reference to the Derivative Hypothesis," in conclusion of the course of 1873. (See Reports in NATURE for that year.) Continued from p. 308.  
<sup>2</sup> See Abstracts in NATURE, 1873.

the maxillaries in front of the orbits. Their molar teeth were of a simple Palæotheroid type, and the incisors and canines were very much reduced. Their fore feet had four and the hind feet three short stout toes. These animals which, according to the correct rules of nomenclature, should constitute the family *Titanotherida*, became extinct, apparently without successors, in the Miocene age.

In the Pliocene period, *Rhinocerotida*, in the form of *Aceratherium* and *Aphelops*, were still abundant, though towards the end of the period they became entirely extinct. True rhinoceroses, like those of the Old World with median horns, have never been met with in America. Remains of tapirs are also found but sparingly, and a great development took place in the various forms of three-toed horses, *Prototippus* and *Hipparion*, which replaced the *Anchitherium* of the Miocene. These in their turn gave way to true horses, of which remains of several species have been found in Pleistocene deposits, and scattered throughout almost every region of the Continent from north to south. These also became entirely extinct before the discovery of America by the Spaniards, a most remarkable circumstance when the fitness of the country for their maintenance, proved by the facility with which the descendants of horses introduced by the invaders have multiplied in a feral state, is considered. The tapir, in several modifications, still lingers in some districts of South and Central America, the sole direct representative of the vast and varied perissodactyle fauna of ages long gone by.

The remains of Artiodactyles in the hitherto explored American Eocenes are very scanty and unsatisfactory as affording indications of their characters. Towards the close of the period only do we find evidences of well-defined selenodont (*Agriochærus*) and bunodont (*Elotherium* and *Platygonus*) forms. No species corresponding to the European *Anoplotherium*, *Dichodon*, or *Xipodon*, have been discovered. During the Miocene period, however, Artiodactyles of both types abounded in North America. The selenodonts were chiefly represented by *Oreodon*, and the allied earlier and more generalised *Agriochærus*. These were numerous in species and individuals, but they became nearly extinct by the end of the Miocene, only surviving in the form of *Merychys*, the most modified form of the group, into the Pliocene. The first indication of the camel-like animals appears in this period in the form of *Poebrotherium*; also a few of the generalised Pecora are now met with, allied somewhat to *Tragulina*, as *Leptomeryx*, *Hypposodus*, and *Hypertragulus*, the latter a very minute species, but no true deer, *Bovida* or even *Traguli*, and no giraffes, *Helladotheria* or *Sivatheria*. The bunodonts were chiefly species of *Elotherium*, and an allied four-toed form, *Pelonax*, remarkable for horn-like lateral processes on its lower jaw, near the symphysis. Peccary-like forms also are now met with. In the Pliocene or Pleistocene periods, except the somewhat problematical *Cosoryx*, founded on some branched horn cores or antlers of a form perhaps allied to *Antilocapra* from the Niobrara Pliocene, all the animals can be assigned to existing families. Of the Suina, all belong to *Dicotyles*, or Peccary (which had formerly a more northern range than at present), or to the allied genus *Platygonus*, no true *Sus*, or *Phacochoærus*, *Babirusa*, or *Hippopotamus*, having been found. Thus the American bunodont Artiodactyles, instead of undergoing great and diverse modifications as did the corresponding animals of the Old World, have been gradually dwindling and contracting to the two closely allied species of Peccary, amongst the smallest and most insignificant of all the pigs, and a very old form, having existed (if teeth alone are sufficient evidence) since the Miocene age. The *Camelida*, on the other hand, appear to have flourished, the species being numerous, and the individuals attaining very large dimensions. It is probable,

in fact, that the family may have originated here, as a tolerably complete series of transitions have been traced from the Miocene *Poebrotherium*, through *Procamelus* and *Pliauchenia*, to the modern Llamas, which, though now confined to the south, once overran the North American Continent. If this view is correct, the Asiatic camels must have come into that country by immigration. A few traces of *Cervida* have been found in American Pliocenes, but their paucity, compared with the Old World, until the Pleistocene epoch, would lead to the belief that they cannot have originated there, but must have been imported from other lands. The same applies to the hollow-horned ruminants, of which no forms different from those now existing have been found in the fossil state.

(To be continued.)

#### THE EFFECTS OF THE SUN'S ROTATION AND THE MOON'S REVOLUTION ON THE EARTH'S MAGNETISM

WHEN the mean horizontal force of the earth's magnetism for each day of the year has been deduced from well-corrected observations of the bifilar magnetometer, and the results have been projected in the usual way, the curves thus obtained show successions of maxima and minima occurring in some instances at nearly equal intervals and in others abruptly and apparently without law. It has been found that these changes are experienced similarly at all stations where observatories have been placed on the earth's surface; they are therefore variations of the magnetic force of the whole earth. The results now considered, though derived from the observations at a single station, may thus be accepted as true generally for all places.

In the projection of the daily mean forces observed at Makerstoun in 1844, the first and last quarters of the year showed large oscillations of the earth's magnetic force, the maxima occurring near the times of new moon and the minima near those of full moon; the ranges of the oscillations were not equally great, and the oscillation disappeared in the months near midsummer. The mean result for the whole year seemed to show that great changes of the earth's magnetic force were due to the moon's position relatively to the earth and sun; but no explanation could be offered for the apparent irregularities in the lunar action. Eleven years later (in 1857), while discussing observations made near the equator, I became persuaded that the variations in question were really due to the sun's rotation on his axis. The result of a re-examination of the Makerstoun observations gave a mean period of nearly twenty-six days for the most probable duration of the magnetic oscillation.

Astronomers who till then had occupied themselves with the determination of the time of the solar rotation had found for it from 27.3 to 27.7 days. It was difficult, in the face of this result, to suppose that the magnets were better acquainted with the true time of the sun's rotation than the eminent observers, who, with the best telescopes, had watched the movement of the solar spots; and it was suggested that a movement of the sun's magnetic poles might explain the difference of the periods obtained. More recently, however, it has been found that the spots give considerably different times for the sun's rotation, and especially that those nearest the solar equator indicate, as Spoerer has shown, a period of 26.3 days, thus approaching nearly to that obtained previously from the magnetic observations. Dr. Hornstein, director of the Prague Observatory, discovered, independently, nearly the same period from his observations in 1870.

There still remained for explanation the irregularities already noticed in the lengths and ranges of single oscillations. I, on a reconsideration of all the discussions previously made by him, arrived some time ago

at the conclusion that the results obtained for the solar and lunar actions did not exclude each other, but that both sun and moon were concerned in the changes of the earth's magnetic intensity; and that possibly the variations in the character of the single oscillations were due to the sun and moon sometimes acting in the same and sometimes in opposite directions; just as in the case of the oceanic tides, for which the differences would be even greater were the solar more nearly equal to the lunar action.

This conclusion is put to the test; the mean variations derived from the observations for each of two successive years are calculated for periods of 26, of 27.3, and of 29.53 days, the two latter being the times of the lunar, tropical, and synodical revolutions respectively. The variations for each of these three periods corresponding to the positions of the moon and of a given solar meridian for each day of the year are then added together; the sums should represent the total actions of the two bodies for each day, and if no other causes are in question, they should agree with the observed variations.

I have shown that when the calculated results are projected so as to form a red curve, on the same mean line as a black curve representing the observations, the two agree very nearly with each other throughout the two years. The different durations and ranges of single oscillations, and the total disappearance of the latter in certain months, are found to be produced, as was supposed, by the greater or lesser agreement or opposition of the three actions.

These results demonstrate, I think, not only that the sun's rotation and the moon's revolutions produce variations of the earth's magnetic force, but that all the marked variations are really due to these causes.

There appears to be one exception to the generality of this conclusion, in sudden great changes, generally diminutions, of the earth's magnetism, which appear of variable magnitude and apparently at irregular intervals. I have examined these cases, and find that if a considerable diminution of intensity happen suddenly when a given solar meridian is in the same plane with the earth, that a similar sudden diminution generally occurs twenty-six days or some multiple of twenty-six days after, when the same solar meridian and the earth are again in the same plane. In one case the sudden loss of force begins five times in succession at the exact interval of twenty-six days.

If we examine these cases of successive disturbance when a given solar meridian arrives opposite the earth, we are induced to conclude either that the solar action exists only for this position, that is to say, that the earth is its cause; or that the action is continuous, but, unlike light and heat, is propagated only in one direction (or plane); or, which seems more probable, that the medium through which these actions are transmitted proceeds from the sun, is not uniformly distributed around it, nor always distributed in the same way. This idea may aid in explaining many facts in terrestrial magnetism for which hitherto no clue has existed.

We arrive then at the conclusions that the variations of the daily mean magnetic force are due to causes external to the earth, depending on the sun's and moon's motions; that all the principal variations of this force can be calculated approximately for each day in twelve months, on the hypothesis that the actions of these bodies are constant throughout the year for the same positions relative to the earth; and that the great magnetic disturbances (accompanied by the aurora borealis) are due to actions proceeding from certain parts of the sun's surface, since so many of them repeat themselves at intervals of twenty-six days, when the same solar point returns opposite the earth. It appears from other investigations that the sun's rotation produces marked effects on our atmosphere.

J. ALLAN BROWN

## PHYSICAL SCIENCE IN SCHOOLS

WE have received the following important communications on this subject:—

Dr. Watts has shown in last week's *NATURE*, p. 311, how the Regulations of the Oxford and Cambridge Schools Examination Board affect injuriously the interests of science in certain schools, viz., those in which boys have "studied science *instead of* the older well-established subjects of classics and mathematics."

But it is fair to say that these are not the schools which are common in the country, even if they are to be found at all; and the business of the Board was rather to examine effectively what schools profess to teach, than to direct their studies into a new line.

I do not think, or mean to say, that the Board and the headmasters, who are believed to have influenced its regulations, have acted in the interests of science altogether; but the way they have damaged its interests in all the principal schools of the country is not by making it "a refuge of fools," as Dr. Watts suggests.

I will, with your permission, point out how the Regulations affect the position of science at Rugby and similar schools.

The main inducement a boy has to go in for a certificate is to be excused the "Little go," if he is going to Cambridge; or "Responsions," if he is going to Oxford. To be excused any part of the Little go he must pass in Latin, Greek, Elementary Mathematics, and Scripture Knowledge; to be excused the whole of it, he must also pass in Additional Mathematics. And since four subjects are all that is required, these four or five are all that he will take up. To be excused Responsions, he must pass in Latin, Greek, and Elementary Mathematics, and in some one other subject. Naturally, he selects the easiest. This will be French, or Scripture Knowledge, or History, or English, according to his tastes. That the three last of these subjects are easier than any Natural Science is certain. All boys know something of them; they are not wholly new to any boy, and it is at any rate commonly believed here that boys have passed and obtained distinctions in them with very great ease. And boys have probably learned French for the last eight years of their lives.

It follows that boys destined for Oxford who know something of science do not take it up, as it would be profitless to do so, unless it is distinctly easier to them than any other subject they could select as a fourth subject; and boys destined for Cambridge do not take it at all.

It should also be observed that though the examination papers last year were very easy, yet the range they cover is rather large. What does "the Elementary Parts of Inorganic Chemistry" mean? This can only be discovered by a study of the examination papers. And certainly the wording is loose enough to enable the examiners to set harder papers, if it is found that the boys can do them.

The only important alteration in the description of the examination in Natural Science that I would make is a very obvious one, and one that might at once be made if any of the headmasters on the Committee would care to ascertain and represent to the University Board the interests of science at schools. It is to divide Group IV. like Group II., making the present part the elementary subjects, and adding to it an additional subject, viz., a practical examination in analysis (inorganic, qualitative), as necessary to be passed by those who wish to gain honours in science. To make this change would at any rate be a guide to a sound opinion on teaching science, though, while the grouping remains as it is, few boys will trouble the examiners.

The study of science at schools has now, it seems to me, entered on a fresh and not altogether unhealthy phase. Ten or twelve years ago there was an outcry for

it, and it was introduced into public schools, and protected, and nursed, and encouraged by scholarships at the Universities, &c. On the whole it got quite as fair play and more favour than could have been expected. Now it is no longer nursed; it is left to find its level. It is protected by regulations against the extinctive power of headmasters, and that is all. Meantime, the methods of teaching it are improving; the supply of teachers is increasing; the number of scholarships at the Universities is quite adequate to the demand for them; and the examinations for them are very good. With these favourable circumstances, and a slowly maturing opinion in the minds of most people that education in science is valuable as a part of training, I think we can afford not to be very impatient at the Regulations of the Universities Board, or at the strict neutrality of headmasters when the interests of science are concerned.

JAMES M. WILSON

May I be allowed a few words with reference to some criticisms passed in last week's NATURE on the Regulations adopted by the "Oxford and Cambridge Schools Examination Board" in regard to science?

I fully concur with the writer (Mr. N. M. Watts) that these Regulations and the two papers printed point to a low standard of scientific knowledge in our great schools. It must be borne in mind, however, that the Board does not issue these Regulations as an ideal scheme of school work, but merely intend them to answer the existing state of the case. With the curriculum of any school they have nothing to do, their function being to appoint examiners to such schools as apply for them, leaving the schools free, within reasonable limits, to choose their subjects.

Now granting Mr. Watts' premises that certificates can be obtained *very cheaply* by taking up two sciences instead of Latin and Greek, this would give an impetus to the study of those subjects in schools, resulting in a large flock of scientific candidates.

Whether this has been the case, the following abstract from the examiner's report of last July shows:—

Subjects.	Number of Candidates offering the subject.	Number who satisfied Examiners.	Number who obtained distinction.
Latin ... ..	438	308	37
Greek ... ..	433	253	35
French ... ..	51	34	13
Mathematics ... } (Elementary) }	455	328	—
English ... ..	43	26	9
History ... ..	305	234	82
Nat. Philosophy } (Mechanical) }	21	10	3
Nat. Philosophy } (Chemical) ... }	28	16	3
Botany ... ..	6	4	—
Phys. Geogra- } phy and Elem. }	15	7	—
Geology ... ..			

These results show that the number of candidates offering any branch of science is comparatively very small, only seventy out of a total of 461, of whom only thirty-seven succeeded in satisfying the examiners out of a total of 232; and of these thirty-seven only six succeeded in gaining distinction. These figures show, I think, that in proportion to the time and attention given to science in the schools examined last July, the papers set were neither unreasonably easy nor difficult. I wish especially to point out that increasing the difficulty of obtaining certificates by help of science would tend as far as possible to exclude science from the school curriculum, while retaining a low standard encourages boys who have

gained a certain crude scientific culture in the lower forms, not, as is so often the case, to let it drop entirely on reaching the sixth.

It does seem to me therefore wiser to commend the wisdom than to deplore the ignorance of the compilers of these Regulations, who aimed at testing the soundness of the small modicum of existing knowledge, rather than fixing a standard which would have practically acted as a prohibition of science.

In considering the amount of knowledge to be expected from boys of eighteen, we must remember the time usually devoted to science work. The following will, as far as my experience goes, be not an unfair statement of the case. A boy commences Latin and French at about eight years of age, at the same time imbibing the first ideas of Mathematics in Elementary Arithmetic; Greek (or German when it is substituted) at twelve or thirteen, and probably Euclid about the same age; Science seldom, if ever, before fourteen or fifteen. Thus the candidate offering himself for examination at eighteen has given ten years to Latin, six to Greek, and about three to Science, the number of hours in those three years given to Science being certainly less than that given to Greek. This programme would be true of certainly nine-tenths of our public school-boys who offer themselves for the examination, the remaining tenth consisting of boys who at seventeen show a distinct aptitude for Science or Mathematics, and who then drop a large proportion of their classical work and are enabled to devote one-half of their time, or thereabouts, to their special subjects. The complaint might with more reason be urged by the classical boys proper against these specialised boys, who are allowed to gain their certificates too easily. When the necessity arises, the standard will doubtless be raised, perhaps, by a division (similar to that made in the Mathematical Group) into Elementary and Advanced Science, with a provision that only one elementary science can be taken up.

Mr. Watts, in the article referred to, asks, rather contemptuously, whether "the knowledge of the composition of the air, the reasons for belief in the rotundity of the earth, the meaning of the words watershed, dip, &c., is the utmost that can be demanded of a boy of eighteen who has studied science instead of the older well-established subjects of classics and mathematics." I hope I have shown that the standard of the examination papers was not too low for the candidates who offered themselves. With reference to the desirability of the change in our whole system of education to which Mr. Watts refers, I may be allowed to say that there is by no means at present an agreement even amongst science teachers that such a change is desirable. I refrain from opening up this very wide subject, because I feel that the experiment has not yet had a fair trial.

Rugby

LINNÆUS CUMMING

#### THE ORGANIC IMPURITIES OF DRINKING WATER

ON Thursday last Prof. Frankland delivered a discourse to the Fellows of the Chemical Society at Burlington House on the detection and analytical determination of the organic impurities in potable waters. He said that the more his inquiries into the influence of water upon the public health had extended themselves the more had he become convinced of the great importance of this application of chemical analysis to the community at large, contending that, in the interests of the public health, the bringing to perfection of this branch of analysis was worthy of the greatest efforts of chemists.

The two chief objects to be kept in view in the analysis of potable water are, firstly, the discovery of the evidence of *past* pollution by organic matter; and secondly, the



quantitative determination of *present* or *actual* organic impurity.

The past history of a water is made out chiefly through the mineral products of oxidation which the polluting organic matters have yielded, and which are still present in the water. As these products are innocuous, it is obvious that if all kinds of organic matter behaved alike under the influence of oxidising agents, such evidence of previous pollution might be safely disregarded; but it is almost superfluous to point out that there are wide differences between various kinds of organic matter in regard to the rapidity with which they combine with oxygen; and of all kinds, that which is organised and living opposes by far the greatest obstacles to oxidation. Now the researches of Chauveau, Burdon Sanderson, Klein, and others, scarcely leave room for doubt that the specific poisons of the so-called zymotic diseases consist of organised and living organic matter, and it is now certain that water is the medium through which some, at least, of these diseases are propagated. It is evident, therefore, that an amount of exposure to oxidising influences which may resolve the dead organic matters present in water into innocuous mineral compounds, may, and probably will, fail to affect those constituents which are endowed with life, and Dr. Frankland adduced, as a striking instance of the persistency of the typhoid poison when diffused in water, the outbreak of a violent epidemic of typhoid fever in a Swiss village through the use of spring water, which, after contamination with the poison, had filtered through nearly a mile of porous earth, but which had nevertheless lost none of its virulent properties. As the typhoid poison is always liable to be present in sewage, and as there is no test for it, except its effects upon man, the discovery of previous sewage contamination in potable water ought to be one of the chief objects of the analyst.

The *actual*, or *present*, as distinguished from the *past*, polluting organic matter of potable water can only be ascertained from the amount of carbon and nitrogen found as constituents of the organic matter present in the water at the time when the analysis is made. The method of performing this operation, known to chemists as the "combustion" method, was fully described to the Fellows of the Society by the speaker eight years ago. Improvements since made were mentioned, and the following proofs of the delicacy and accuracy of the analytical method were adduced:—

To 100,000 parts of a sample of water, rendered as nearly chemically pure as possible, 1'5572 parts of sulphate of quinine were added. The water was then submitted to the method for determining organic carbon and nitrogen just mentioned. The following data compare the quantities of organic carbon and organic nitrogen thus actually added to the water, with those afterwards extracted in each of two analyses:—

	Present.	Found.	
		I.	II.
Organic carbon in 100,000 parts of water ... ..	0'857 part.	0'912	0'904 part.
Organic nitrogen in ditto	0'100 "	0'0996	0'098 "

To 100,000 parts of a similar sample of water 0'7786 part of sulphate of quinine was added, and the following results obtained on analysis:—

	Present.	Found.		
		I.	II.	III.
Organic carbon in 100,000 parts of water ... ..	0'429 part.	0'435	0'442	0'440 part.
Organic nitrogen in ditto	0'050 "	0'047	0'048	0'048 "

To 100,000 parts of a third similar sample of pure water 0'07786 part of sulphate of quinine was added. On analysis this water yielded the following numbers:—

	Present.	Found.		
		I.	II.	III.
Organic carbon in 100,000 parts of water ... ..	0'043 part.	0'047	0'050	0'055 part.
Organic nitrogen in ditto. ... ..	0'005 "	0'006	0'005	0'006 "

The close approximation of the experimental to the calculated numbers is the more striking when it is remembered that the weight of nitrogen *actually determined* in the litre of water used for analysis was, in the last series of experiments, only  $\frac{1}{10000}$ th of a gramme.

Applied to actual specimens of potable water, the accuracy of the method was tested by the uniformity of results obtained in the following duplicate analyses of the same samples of water:—

		Results of analyses expressed in parts per 100,000.	
		I.	II.
Thames water as supplied to London ...	Organic carbon	0'280	0'285 part.
	" nitrogen	0'032	0'035 "
River Lea water as supplied to London.	Organic carbon	0'231	0'239 part.
	" nitrogen	0'042	0'042 "
Kent Company's water as delivered in London	Organic carbon	0'054	0'056 part.
	" nitrogen	0'016	0'017 "

But as practical illustrations of the trustworthiness of the process, the speaker relied most upon the results of the monthly analyses of the water delivered by the eight metropolitan companies made for the Registrar-General during the last eight years, and embodied in two large diagrams which exhibited, at a glance, the results of nearly 800 separate analyses. One of these diagrams showed, by means of curves, the mean proportions of organic elements (organic carbon and organic nitrogen) in the waters of the Thames and Lea, and compared them with that found in the deep well-water of the Kent Company. It also showed the rate of flow of the Thames nearly opposite Hampton Court Palace, and consequently near the place where the Thames water companies abstract their supplies. This diagram showed how sharply the distinction between these three waters is drawn by the method of analysis. In no instance did the curve representing the average organic impurity in the Thames approach near to that indicating the like impurity in the deep-well water, whilst the curve of organic contamination in the Lea water intersected the Thames curve but thrice, and the deep-well curve only once in eight years; and even these intersections, when closely studied, were found to be striking illustrations of the delicacy of the analytical method.

The second diagram might be regarded as a magnified representation of the first. In it the curve representing the average organic impurity in Thames water was decomposed into five constituent curves showing the organic impurity in the water delivered by each of the five metropolitan water companies which abstract their supplies from the Thames; whilst the corresponding curve of impurity in the River Lea was split into two, one representing the impurity in the New River Company's water, and the other that in the beverage delivered by the East London Water Company. As deep-well water is delivered to London by one company only, the curve representing the minute impurity in this water was the same in both diagrams.

These diagrams demonstrated how faithfully the analytical results recorded, firstly, the well-known superiority of deep well over river water; secondly, the superiority of the water of the Lea to that of the Thames; thirdly, the variations in the three great conditions which govern the intensity of organic contamination in the river waters, viz., heavy floods, small floods when the river is low, and decay of vegetation in autumn; and lastly, the method has shown itself competent to reveal the finer shades of quality in waters drawn simultaneously from the same source, but treated differently by the various companies who manipulate them.

Against these advantages the process of analysis advocated by the speaker involves more trouble and more careful manipulation than are usually bestowed upon what are called "commercial" analyses, and although these drawbacks ought not to be paramount considerations, where such important issues are involved, yet if any other more simple method existed from which trustworthy quantitative information about the organic matter in water could be obtained, the more troublesome process would cease to have a *raison d'être*.

Such a simple alternative method of determining organic nitrogen, but not organic carbon, is now very extensively used by chemists. It is known as the "albuminoid ammonia" method, and depends upon the fact that, by boiling with an alkaline solution of potassic permanganate, most nitrogenous organic bodies are decomposed with evolution of ammonia. From the amount of ammonia so evolved, the proportion of organic nitrogen is calculated. A critical examination of the results obtained by this method conclusively demonstrates that it is incapable of converting into ammonia either the whole, or any definite proportion, of the organic nitrogen of potable waters. Indeed, this is shown not only by the following instances, but also by numerous others in which known quantities of nitrogenous organic matters of known composition were submitted to the process.

Results of analysis expressed in parts per 100,000:—

*Artificial Waters containing Peaty Matter.*

Sample No.	Organic nitrogen by combustion.	Organic nitrogen by albuminoid ammonia process.
1	068 part	016 part.
2	042 "	016 "
3	076 "	022 "
4	1015 "	308 "
5	1175 "	422 "
6	029 "	011 "

*Natural Waters.*

Chelsea Company's water	058 "	011 "
West Middlesex Company's water	027 "	012 "
Southwark Company's water	061 "	024 "
Grand Junction water	031 "	006 "
Lambeth Company's water	062 "	030 "
Artesian well water	033 "	{ 003 "
		{ 004 "
Sea water, No. 1	217 "	006 "
" No. 2	134 "	018 "

It is almost superfluous to say that any opinion as to the quality of a sample of water, based upon the albuminoid ammonia obtained, must be entirely untrustworthy.

Dr. Frankland summed up with the following conclusions, to which he had been led by the experiments of himself and others:—

1. That the "albuminoid ammonia" process of analysing water affords no evidence whatever of the absolute quantity, either of organic matter, or of organic nitrogen present in potable water.
2. That it does not indicate, even approximately, the relative quantities either of organic matter or of organic nitrogen in different samples of such water.
3. That it affords no indication, either of the presence or of the proportion, of *albuminoid* as distinguished from other nitrogenous organic compounds.
4. That the "combustion" process, though more troublesome, is the only method at present known which affords any trustworthy information respecting the organic matters present in potable waters.
5. That it is the only method which even professes to determine organic carbon in such waters.
6. That the determinations by it of organic carbon and nitrogen are fairly accurate, notwithstanding the very minute quantities of matter dealt with, and that the errors even of a comparatively inexperienced analyst fall far short

of the limits which would affect a verdict upon the quality of the water submitted to investigation.

7. That it is the only process which discloses the proportion of nitrogen to carbon in the organic matter of waters, such information being often of prime importance in reference to the origin of the organic matter.

8. That since the improvements which have been made in the mode of evaporating the water to be analysed, the process can now be conducted in any laboratory and with a moderate expenditure of time and labour.

*RELATION BETWEEN THE LIMIT OF THE POWERS OF THE MICROSCOPE AND THE ULTIMATE MOLECULES OF MATTER<sup>1</sup>*

THE subject which I have selected for my address is the relation between the limit of the powers of the microscope, and the ultimate molecules of organic and inorganic matter. I think I may at all events claim for this question sufficient novelty. Until the last few years the subject could scarcely have been attempted, and even now so many necessary facts are imperfectly known, that nothing more can be done than to fill the gaps with plausible assumptions. This necessarily imparts more or less of a speculative character to some of my remarks; but it appears to me that in his annual address the president of a society cannot do better than endeavour to point out the general bearings of what is already known on some great question, even if for no other object than to prove the need of further inquiry.

Though fully impressed with the imperfect state of our knowledge, yet, even now, the facts are sufficiently definite to indicate, if not to prove, the existence of as wide a world of structure beyond the limit of the power of the microscope, as what has been revealed to us by it is beyond the powers of the unassisted eye.

I propose to divide my subject into three heads—

1. The limits of the power of the microscope.
2. The size of the ultimate molecules of organic and inorganic matter.

3. Conclusions to be drawn from the general facts.

In considering the limits of the power of the microscope, I shall assume that the instrument itself is perfect, and that the invisibility of the objects examined is in no way dependent on the want of the necessary characters. The point to which I particularly wish to direct attention is the limit of visibility depending on the constitution of light, beyond which light itself is of too coarse a nature to allow of our seeing objects distinctly defined. This question has been treated of in an admirable manner by Helmholtz in the jubilee volume of *Poggendorff's Annalen* (1874, p. 573). The conclusion to which he arrives is that the limit depends on the confusion in the image due to the bright interference fringes overlapping the dark outlines of the object. This limit varies directly as the wave-length of the light, and inversely as the sine of half the angle of the aperture of the object-glass when illuminated by means of a condenser of equal aperture. According to this principle the limit for dry object glasses of 60° aperture is, roughly speaking, about equal to the wave-length of the light, and for the largest possible aperture equal to  $\frac{1}{2}$  the wave-length. In the case of immersion object glasses of the same aperture, the limit is about  $\frac{1}{4}$  of that for dry.

On comparing this theory with the results of observation, the agreement is very striking. It indicates exactly the same law for the increased defining powers of lenses of large aperture, as has been determined by experiment, and gives for the theoretical limit of distinct visibility  $\frac{1}{85000}$ th part of an inch, which is exactly the same as the mean of the experimental determination of a number of the most skilful microscopists. It also shows why in the case

<sup>1</sup> Anniversary Address of the President of the Royal Microscopical Society, H. C. Sorby, F.R.S., &c. Abstract by the Author.

of lines at equal intervals, like Nobert's bands or the markings on Diatomaceæ, it is possible so to manage the illumination that the dark fringes of interference may coincide with the true lines of structure, and give rise to good definition, even beyond the normal limit, and also agrees with the fact that lines less than  $\frac{1}{100000}$ th of an inch apart can be *photographed*, though *seen* with extreme difficulty, if indeed truly resolved, except under very peculiar and exceptional conditions; since the waves of light at the blue end of the spectrum, which are concerned in photography, are short enough to give good definition of lines so near together that the interference fringes due to the longer waves at the red end would give an indistinct image. Taking everything into consideration, the agreement between observation and the theory is so close as to make it extremely probable, and to justify the conclusion that the normal limit of distinct visibility with the most perfect microscope is  $\frac{1}{2}$  of the wave-length of the light. If so, we must conclude that, even with the very best lenses, except under special conditions, light itself is of too coarse a nature to enable us to define objects less than  $\frac{1}{80000}$ th or  $\frac{1}{100000}$ th of an inch apart, according as a dry or an immersion lens is used. We must also conclude that, *as far as this question is concerned*, our microscopes have already reached this limit, whatever improvements may remain to be made in other respects.

2. *The Size of the Ultimate Atoms of Matter.*

After discussing the results obtained by Stoney, Thompson, and Clerk-Maxwell, mainly derived from the properties of gases, I come to the conclusion that in the present state of our knowledge the best approximation that we can make to the size of the ultimate atoms of matter is the mean of their determinations. I adopt for simplicity  $\frac{1}{1000}$ th of an inch as the unit of length, and  $\frac{1}{1000}$ th of an inch cube, or  $\frac{1}{1000000000}$ th of a cubic inch, as the unit of volume. In the case of a true gas the number of atoms in the length of  $\frac{1}{1000}$ th of an inch at 0° C., and a pressure of one atmosphere, would be 21,770, and hence, in  $\frac{1}{1000}$ th of an inch cube, about 10,320,000,000,000.

If this gas were a mixture of two volumes of hydrogen and one of oxygen, on combining to form water there would be a contraction to  $\frac{2}{3}$ , and on condensing into liquid water a contraction to  $\frac{1}{170}$  of this; but since the molecules of the resulting liquid would contain three atoms of the gases, the total number of molecules of liquid water in a given volume would be  $\frac{2}{3} \times 770 \times \frac{3}{2} = 385$  times the number of atoms of a gas. This gives for the number of molecules of liquid water in  $\frac{1}{1000}$ th of an inch cube about 3,900,000,000,000,000.

As an illustration of a far more complex substance I take albumen, and calculating as well as one can from its chemical composition, and from the specific gravity of horn, I come to the conclusion that the diameter of the ultimate molecule of dry albumen is about 3.82 that of the molecules of water, and that  $\frac{1}{1000}$ th of an inch cube would contain about 71,000,000,000,000.

If such be the case, we must conclude that in the length of  $\frac{1}{50000}$ th of an inch (the smallest interval that could be distinctly seen with the microscope) there would be about 2,000 molecules of liquid water lying end to end, or about 520 of albumen. Hence, in order to see the ultimate constitution of organic bodies, it would be necessary to use a magnifying power of from 500 to 2,000 times greater than those we now possess. These, however, for reasons already given, would be of no use unless the waves of light were some  $\frac{1}{1000}$ th part of the length they are, and our eyes and instruments correspondingly perfect. It will thus be seen that, even with our highest and best powers, we are about as far from seeing the ultimate structure of organic bodies as the naked eye is from seeing the smallest objects which our microscopes now reveal to us. As an illustration, I have calculated that with our highest powers we are as far from seeing the

ultimate molecules of organic substances as we should be from seeing the contents of a newspaper with the naked eye at the distance of a third of a mile; the larger and smaller types corresponding to the larger and smaller molecules of the organic and inorganic constituents.

3. *General Conclusions to be deduced from the above facts.*

When we come to the application of these principles to the study of living matter we are immediately led to feel how very little we know respecting some of the most important questions that could occupy our attention. As illustrations I do not think I can select better than the facts bearing on the size and character of minute germs, and on Darwin's theory of ultimate organised gemmules.

For the sake of simplicity I will take into consideration only the albuminous constituent of animals, using the term *albumen* in a sort of generic sense. Whatever be the special variety of this substance, it is so associated with water in living tissues, that in most, if not all, cases they would cease to live, if thoroughly dried. Much of the water is no doubt present simply as water mechanically mixed with the living particles; but it appears to me that we ought to look upon some portion as being in a state of *molecular combination*. The existence of such a state of union is clearly proved by the optical characters of various solutions of the same coloured substance. These are by no means such as would result from the mere mechanical diffusion of very minute particles of the solid substance in the liquid, and cannot be explained unless we suppose that the coloured substance is to some extent in the state of molecular combination with the solvent. This molecular affinity is also in some cases manifested by a swelling up of a solid substance when placed in certain liquids, even when perfect solution occurs to a very limited extent. Such a condition appears to be very characteristic of the living tissues of animals, and makes it very probable that the ultimate living particles are molecular compounds with water, and not molecules of free dry albuminous substances. So little is known of the true proportion of water thus combined, that the only course now open is to suppose, for illustration, that living albuminous matter contains half its volume of water mechanically mixed, and one-fourth of free albumen, united with one-fourth of molecularly combined water. On this supposition a sphere of such living matter  $\frac{1}{1000}$ th of an inch in diameter would contain the following number of molecules:—

Albumen . . . . .	10,000,000,000,000
Water in molecular combination . . . . .	520,000,000,000,000
	530,000,000,000,000

The very small relative amount of dry matter in some living animals makes it probable that the molecularly combined water plays such an important part in their ultimate structure, that we may base our provisional conclusions on this total number of molecules.

*Theory of Invisible Germs.*

Calculating then from the various data given above, we may conclude that a spherical particle one-tenth the diameter of the smallest speck that could be clearly defined with our best and highest powers, might nevertheless contain no less than one million structural molecules. Variations in number, chemical characters, and arrangement would in such a case admit of an almost boundless variety of structural characters. The final velocity with which such particles would subside in air must be so slow that they could penetrate into almost every place to which the atmosphere has access.

*Darwin's Theory of Pangenesis.*

Full particulars of this theory will be found at p. 374 of vol. ii. of his work on the variation of animals. He nowhere gives any opinion as to the actual size of gem-

mules, or the number present in particular cases, but it appears to me interesting to consider how far the theory will hold good when examined from this more physical point of view.

For the sake of argument, I assume that gemmules on an average contain one million structural molecules of albumen and molecularly combined water. Variations in number, composition, and arrangement would then admit of an almost infinite variety of characters. On this supposition it would require a thousand gemmules to be massed together into a sphere, in order to form a speck just distinctly visible with our highest and best magnifying powers. By calculation I find that a single mammalian spermatozoa might contain so many of such gemmules, that, if one were lost, destroyed, or fully developed in each second, they would not be completely exhausted until after the period of one month. Hence, since probably a number are concerned in producing perfect fertilisation, we can readily understand why the influence of the male parent may be very marked, even after having been, as regards particular characters, apparently dormant for many years.

In a similar manner I calculate that the germinal vesicle of a mammalian ovum might contain enough gemmules for one to be destroyed, lost, or fully developed in each second, and yet the entire number not be exhausted until after a period of seventeen years, and the entire ovum might contain enough to last at the same rate for no less than 5,600 years.

These calculations are made on the supposition that the entire mass is composed of gemmules. Of this there is little probability; but still, even if a considerable portion of the ovum consists of completely formed material and of mere nutritive matter, it might yet contain a sufficient number of gemmules to explain all the facts contemplated by the theory of pangensis. The presence of any considerable amount of such passive matter in spermatozoa would, however, be a serious difficulty in the way of the theory, unless indeed very many spermatozoa are invariably concerned in producing fertilisation.

Taking everything into consideration, it does not appear to me that any serious objection can be raised against pangensis when examined from a purely physical point of view, as far as relates to the inheritance of a very complex variety of characters by the first generation, though there would have been many serious difficulties to contend with, if the ultimate atoms of matter had been very much larger than is indicated by the properties of gases.

When we come to apply similar reasonings to the second or following generations, we are compelled, along with Darwin, to conclude that gemmules have the power of producing other gemmules more or less closely resembling themselves, and of being collected together in the sexual elements, since otherwise the number that could be transmitted in a dormant state for several generations would be far too small to meet the requirements of the case.

#### Conclusion.

In my remarks I have made no endeavour to conceal our present ignorance of many very important questions connected with my subject. Want of the requisite data necessarily imparts a speculative character to many of my conclusions; but perhaps there is no more fruitful source of knowledge than to see and feel how little is accurately known, and how much remains to be learned.

#### THE TUFTED DEER OF CHINA

AMONG the many most valuable additions which Mr. R. Swinhoe has made to our knowledge of Chinese zoology, there are none more important than his discoveries in the deer-tribe. The Water Deer of Shanghai (*Hydropotes inermis*), first described in 1870, is one of

the most interesting of these. It is of small size, without horns of any kind, and with long canine teeth present in the males only. In outward appearance it in these respects closely resembles the Musk Deer. Its colour is light chestnut, and the hairy coat is harsh. It is called the *Ko* and the *Chang* by the Chinese. Sir Victor Brooke has demonstrated that its skull differs in important points from that of *Moschus*.

Still more recently, in 1874, Mr. Swinhoe has described another small deer from the mountains near Ningpo, of much the same size as *Hydropotes*; it also resembles this genus in being hornless and possessing large canine teeth in the males. Mr. Swinhoe, in the "Proceedings" of the Zoological Society (1874, p. 452), writes as follows:—"My friend and correspondent, Mr. A. Michie, wrote me a letter dated Shanghai, December 19, 1873, as follows:—'I send another note to overtake the mail, to tell you I have just found a new deer from the Ningpo country. It is a dark iron-grey or pepper-and-salt colour, like some Scotch terriers, with white tips to its ears, square-built (that is, straight back and pointed hip), with very short tail. On its forehead is a thick black mane, like the bristles of a boar. . . . It has the lachrymal sinus, but not so large as the Muntjac; in size the beast about equals the Muntjac.'" An excellent figure accompanies this description. It was drawn from a skin sent by Mr. Michie to Mr. Swinhoe, who has named the animal *Lophotragus michianus*.

A living example of this species, the first ever brought to this country, has just reached the Zoological Gardens in Regent's Park. From this male specimen it can be seen that the drawing above referred to, made from the flat skin, excellently represents the figure of the animal, and is truthful in that it shows the canine teeth and the absence of horns. In the living specimen there is a pair of hair-covered tuberosities on the frontal regions, at the postero-lateral angles of the hairy head-tuft, but, as in the Giraffes, these have no horns upon them. Comparing this condition with that of *Elaphodus cephalophus*, also from China, described by M. A. Milne-Edwards, the intimate relation of *Lophotragus* to the Muntjacs (*Cervulus*) is evident; the series of gradual antler-reduction being in the following order:—*Cervulus*, *Elaphodus*, *Lophotragus*. Whether *Hydropotes*, or *Moschus*, or both are extremes of this series, remains to be proved; and it must be mentioned that it is not perfectly certain, though highly probable, that the above-described individual specimen of *Lophotragus* exhibits its highest degree of antler-development.

#### NOTES

SOME weeks since it was stated that the collection of fishes made by Mr. Francis Day, Inspector-General of Indian Fisheries, would be deposited in the New Indian Museum at South Kensington. It was offered to and accepted by the Secretary of State for India, but it was subsequently considered that neither the expense of bottles in which to exhibit them, nor of spirit for their preservation, could be rightly debited to the resources of India. Mr. Wood, the well-known artist, very liberally proposed, in exchange for the type collection, numbering about 1,200 species, to increase Mr. Day's plates in his work, the "Fishes of India," from 160 to 190, or to 1,140 figures. The Director of the Indian Museum in Calcutta hearing of this arrangement, proposed to the trustees that he should secure it at once on these terms, and we understand that he has been instructed to do so. It will doubtless render the Museum in Calcutta the most complete in Indian fishes in the world; but whether this collection finding a place in the British Museum might not have proved more beneficial to science we leave for the decision of our readers.

MR. WILLETT has just issued a report on the Sub-Wealden boring, stating that the bore-hole has been widened and lined to

a depth of 1,760 feet, and that boring was recommenced on the 8th inst. at a depth of 1,825 feet, when the hard limestone passed into soft shales, and mentions the occurrence of imperfect specimens of ammonites, at 1,849 feet. Geologists will probably not be disposed to agree with Mr. Willett, "that the theory of the presence of a ridge of old rocks north of the English Channel and south of the Thames is no longer tenable," for we believe that no one ever denied that the Wealden axis was "a true anticlinal elevation." In stating that the Cretaceous rocks are the same thickness on both sides of the axis, Mr. Willett appears to forget that the old Palæozoic rocks were contorted and their upturned edges denuded, before the Secondary rocks, much less the Tertiary, were deposited, and in stating that the 1,800 feet of strata, explored by the boring, as well as the overlying beds, were "deposited during a prolonged and continuous subsidence of this part of the earth's surface," we believe few men of science will coincide with him. In the conclusion of his report, he offers personally to bear the cost of any boring in Kent or Sussex, above the Wealden horizon, which may reach the Palæozoic rocks, within a depth of 2,000 feet.

IN answer to Dr. Playfair on Monday, Mr. Cross said the recommendations of the Royal Commission for Scientific Instruction and the Advancement of Science had been for some time under the consideration of the Government. With reference to what steps the Government proposed to take in the matter, he would rather not anticipate, he said, the statement which it would be the duty of his noble friend the Vice-President of Council to make on the subject. We look forward with considerable interest to the statement which Lord Sandon has to make, and hope we shall not have long to wait for it.

MR. WARD HUNT stated last Thursday in the House of Commons that Capt. Nares will send a sledge party down to the entrance of Smith's Sound in the spring of this year, if possible, with despatches, for the chance of a ship from England calling there. The Admiralty have arranged with Mr. Allen Young, who is contemplating a voyage to the Arctic regions this year in his yacht, to look for cairns in which such despatches might be deposited, and he has, with great public spirit, consented to make this the primary object of his voyage, undertaking to bring home any such despatches, unless he can find means for sending them to England otherwise.

A LARGE and influential meeting of the citizens of Glasgow was held on Wednesday, Feb. 16, to make arrangements for the meeting of the British Association on Sept. 6. The Lord Provost presided. The University buildings were granted for the Association meetings. Most of the guarantee fund of 4,000*l.* was subscribed, and resolutions were adopted to extend the hospitality of the city to strangers attending the Association.

THE death of the well-known French engineer, M. Thomé de Gamond, is just announced. M. de Gamond is probably best known as the originator of the Channel Tunnel, and he died on the very day on which the Commissioners took the final steps for the completion of that great work. He was born in 1798 at Paris, but was educated in the Netherlands, where he gave great attention to hydrography. His great scheme was remodelled by him many times before it took its final form. It was brought before several International Exhibitions and Commissions, and he published a great number of pamphlets, documents, and books before the scheme gained the favour of those who were able to help him in carrying it out. He was not destined to see the boring actually commenced, but he saw all obstructions and objections removed. M. Thomé de Gamond had also conceived a vast scheme for the improvement of the streams and rivers of France. He proposed to enable the country to utilise the whole of its hydraulic resources, and was anxious to put

an end to the immense loss of water which might be used for irrigation and as a motive power. He was modest, energetic, and benevolent.

THE death of M. Adolph Brogniart, Professor of Botany and Member of the French Academy of Sciences, was announced in Paris on Saturday.

PROF. NILS PETER ANGELIN, Intendent of the Palæontological Department of the Riks Museum, Stockholm, and author of "Palæontologia Scandinavica," died at Stockholm on the 13th inst., aged upwards of seventy years.

THE death is announced of M. d'Orbigny, Assistant Naturalist at the Natural History Museum, Paris.

HERR VON LOEHER has recently read a paper before the Munich Academy of Sciences in which he argues that the Guanch or Wandsch population of the Canary Isles, who for more than a century repulsed all invaders, are the descendants of the Vandals. Most of the names of places are barbarian, but some Germanic. Many common expressions are a mixture of both, and names of persons are almost Germanic, as also religious phrases and the titles of public functionaries. Herr Loehrer believes that the Vandals or Goths settled in the Isles in the eighth century, finding there a weak barbarian population whom they subjugated, that they gradually lost the use of iron and shipbuilding, and mostly relapsed from Christianity into German heathenism, but, though degenerating in their complete isolation, retained the features and customs of their race in all essential points until their discovery by Europeans. Fair-haired mummies have been found in their tombs, and the dimensions of the skulls agree with those of Germanic races.

IN a letter to the Vice-Chancellor of Oxford, Prof. Max Müller expresses his great gratification with the decree passed in Convocation on Tuesday week. "It was solely," he says, "in order to secure the leisure necessary for the completion of my labours connected with the ancient literature of India that I came to the decision to resign my professorship. Now that you have in so generous a way granted me that leisure, I look forward with great satisfaction to spending the remaining years of my life at Oxford, and, if my health be spared, I still hope to be able to prove to the members of the University that they have bestowed this privilege on one not quite unworthy of their confidence."

A MAGNIFICENT new map of France has recently been completed by the French Engineering Department, and is now being published in sheets. It is on the scale of 1:500,000, and must take the place of all previous maps, most of which are, we believe, inaccurate in many important particulars. By means of various easily understood devices, the new map shows all the main natural and artificial features of the country, and by means of its metrical divisions, the distances of places from each other may be observed at a glance.

A VERY interesting museum will be opened in a few weeks at the village of Castleton, in the Peak of Derbyshire, a place much visited by geologists, &c. It will contain: (a) a series of articles of the Bronze and Neolithic periods from Switzerland, Denmark, Cissbury, Yorkshire, with a large number of the prehistoric remains from the tumuli, &c., near Castleton, the result of the explorations of Mr. Rooke Pennington, F.G.S., and Mr. John Tym during the last few years. (b) Palæolithic implements. (c) A magnificent series of the Pleistocene animals of the Derbyshire district—bison, grizzly bear, reindeer, rhinoceros, hyæna, &c. (d) A good geological series, of about 1,500 species of fossils numbering about 3,500 specimens, from Crag to Laurentian, and including a good Ichthyosaurus, Plesiosaurus, Crag and Eocene mammals, some good fish, &c. Most of the formations are well represented, but particularly those prevailing near Castleton (mountain limestone, Yoredale series, and coal

measures). (e) A series of minerals and rocks, the Derbyshire minerals being specially good; and some educational sets of fossils and minerals. All the above are properly arranged with explanatory notes, so as to be useful to the uninitiated and to teach geological rudiments, whilst affording advanced students opportunity of comparing their "finds" and naming them. (f) A series of the fauna and flora of North Derbyshire, including mammals (stuffed), birds, and their nests and eggs, ferns and mosses, &c. (g) Collection of old china, entirely obtained from the older houses in the neighbourhood, with old books, ornaments, coins, &c. (h) Set of archaic mining tools from the old lead mines of Castleton. (j) The natural and commercial productions of the neighbourhood. (k) Geological maps and sections, guide-books, and a small scientific reference library. Mr. Pennington's collections are all included in the museum.

THE investigation into the cause of the explosion at the Jabin pit, near Lyons, in France, seems to show that the workmen were not to blame for any imprudence in the use of their lamps, but that the catastrophe was probably produced by the inflammable air escaping from the coal beds by a great diminution of barometric pressure, which reached 10 millimetres in a few hours. This connection of explosions in mines with a diminution of barometric pressure has been frequently referred to recently in connection with explosions in England. The question has been asked whether it is not desirable to extend the system of storm warnings to coal-mining districts; if the miners could only be induced to attend to them there seems no doubt that a great saving of life would be thus effected.

A VALUABLE and in many respects exhaustive memoir on the temperature of the air at Brussels, by Prof. E. Quetelet, based on forty years' observations ending with 1872, appears in Vol. XLI. of the Memoirs of the Royal Academy of Belgium. The paper presents in a more extended and permanent form the leading features of the most important element of the climate of Brussels, which appeared about a year ago in the form of a small tract, briefly reviewed in NATURE at the time (vol. xi., p. 444).

MRS. MARSHALL HALL, sen., writes that the lady who made a successful ascent of Mont Blanc on the 31st ult., mentioned in our last number, was Miss Stratton, a Welsh lady, not an American.

AN apparatus of great delicacy has lately been devised by Dr. Mosso of Turin, for measuring the movements of the blood-vessels in man. A description of it, with figures, appears in *Comptes Rendus* of Jan. 24. The arrangement of the *plethysmograph* (as it is called) consists in enclosing a part of the body, the fore-arm, e.g., in a glass cylinder with caoutchouc ring, filling the cylinder with tepid water, and measuring, by a special apparatus, the quantity of water which flows out or in through a tube connected with the cylinder, as the arm expands or contracts. An opening in the cylinder is connected by a piece of caoutchouc tubing with a glass tube opening downwards into a test tube suspended from a double pulley with counterpoise to which the recording lever is attached, in a vessel containing a mixture of alcohol and water. When the vessels of the arm dilate water passes from the cylinder into the test tube, which is thereby immersed further, so that the counterpoise rises; in the opposite case water flows back from the test-tube into the cylinder, the test-tube rises, and the counterpoise descends. Among other applications of the apparatus, Dr. Mosso employs it in studying the physiology of thought and cerebral activity. The slightest emotions are revealed by the instrument by a change in the state of the blood-vessels. The entrance of a person during the experiment, in whom one is interested, has the effect of diminishing the volume of the fore-arm four to fifteen cubic centimetres. The work of the brain during solution of an arithmetical or other problem, or the reading of a passage difficult to understand,

is always accompanied by contraction of the vessels proportional to the effort of thought.

THE Perthshire Society of Natural Science has recently conferred a great benefit on the City of Perth by drawing attention through one of its members, Dr. Lauder Lindsay, to the many imperfections of its water-supply. Perth, as our readers know, stands on the banks of the finest river in the kingdom, and yet its water-supply is lamentably deficient in quantity and quality. The present system of supply was organised about fifty years ago, and Dr. Lindsay brought it to the test of the universally recognised principles of sanitary science, with the result stated. Unfortunately Perth lies very low, and on that very account unusual care must be taken to keep the supply of water pure. After the lesson which Dr. Lindsay has read the inhabitants, it will be their own blame if they do not exercise what would be genuine economy, and remedy a state of matters which must undoubtedly exercise a deleterious influence on the health and prosperity of the fair city. We think this practice of bringing science to bear on matters of local importance is one quite within the sphere of local scientific societies.

THE Meteorological Commission of Allier have now twenty regular meteorological stations at different heights, varying from 686 to 3,773 feet. These stations, together with eighty others for the observation of thunderstorms, have been established for the investigation of the local climates of the department. It is resolved by the Commission, in the interests of general meteorology, to connect its observations as much as possible with those which are collected at Paris.

THE additions to the Zoological Society's Gardens during the past week include a Bay Bamboo Rat (*Rhinomys badius*) from India, presented by Mr. Jas. Wood Mason; an Anderson's Kaleege (*Euplocamus andersoni*) from Burmah, two Hill Francolins (*Arboricola torquella*) from India, presented by Mr. W. Jamrach; a Sociable Vulture (*Vultur auricularis*), two Cape Francolins (*Francolinus capensis*) from Africa, presented by Mr. J. C. Hobbs; two White-necked Storks (*Ciconia episcopus*) from India, received in exchange; two White-backed Pigeons (*Columba leuconota*) from the Himalayas, a Tiger Bittern (*Tig. isoma brasiliense*), five Geoffroy's Doves (*Peristera geoffroyi*) from South America, purchased.

## THE INDUSTRIAL APPLICATIONS OF OXYGEN<sup>1</sup>

### II.

WE must now direct our attention to a small group of proposals for extracting oxygen from the air by purely mechanical means, without the aid of any chemical action. They are founded on one or other of two physical principles, diffusion or absorption.

T. Graham, whose "inquiries into the laws of the diffusion of gases" will always be remembered as one of the most perfect of his numerous and great researches, observed in 1866<sup>2</sup> that air drawn through a small fissure of a thin india-rubber leaf contains the constant proportion of 41.6 parts of oxygen to 58.4 parts of nitrogen, so that half of the nitrogen of the atmospheric air is kept back, and that this mixture makes red-hot coals burn with a flame. Deville,<sup>3</sup> however, tested this method with regard to its industrial merits, and found that it required too much time to be considered practical.

Endeavours to utilise absorption have been made in two different ways. Messrs. Montmagnon and De Laire obtained a patent in France in 1868 for a process, founded on the observations of Angus Smith,<sup>4</sup> according to which charcoal takes up more oxygen

<sup>1</sup> Translated, by permission of the editor, from the "Report on the Development of Chemical Industry, in conjunction with friends and fellow-workers, by A. W. Hofmann." The present article, as well as the previous one, it should be understood, are by Dr. A. Oppenheim. Continued from p. 295.

<sup>2</sup> Graham, *Compt. Rend.* lxxii, 471.

<sup>3</sup> Deville, *Wagn. Jahresber.*, 1867, 216. <sup>4</sup> *Bull. Soc. Chim.* [s], xi., 261.



than nitrogen from the air. They have found that 1,000 litres of charcoal absorb 925 lit. of oxygen and only 750 lit. of nitrogen. When moistened with water, 350 lit. of oxygen and 650 lit. of nitrogen are given off; so that 575 lit. of oxygen and 55 lit. of nitrogen remain, which may be extracted by means of the air pump. By repeating the same process with this gaseous mixture, they succeeded in obtaining oxygen in almost a pure state. Whether this method was ever employed on an extensive scale is unknown. But this has been the case with Mallet's<sup>1</sup> method, founded on the higher coefficients of absorption of water for oxygen, as compared with nitrogen. The coefficients of absorption of these gases in water are 0.025 for nitrogen, and 0.046 for oxygen. Multiplied by their volumetric proportion in the atmosphere 0.79 and 0.21, these figures yield the proportion in which these gases occur in water = 0.0197 N and 0.0097 O; or, the air absorbed in the water contains in one volume 0.67 N, and 0.33 O. If the non-absorbed nitrogen is now allowed to escape, and the absorbed mixture of the two gases is extracted from the water and submitted a second time to absorption, we shall find by multiplying their coefficients with the numbers just obtained, 0.67 (N) and 0.33 (O), that the mixture now absorbed will contain 0.525 N and 0.475 O. A third absorption will raise this proportion to 0.375 N : 0.625 O; a fourth to 0.25 N : 0.75 O; a fifth to 0.15 N : 0.85 O; that is the same relation in which the gases occur in the mixture ordinarily produced by Tessié du Motay's process. After the eighth absorption, the gas evolved is almost pure oxygen (0.973 O and 0.027 N).

Mallet's apparatus consists of a greater or smaller number of strong iron water-reservoirs, connected by forcing and sucking pumps. Into the first air is pumped through fine openings, at a pressure of about five atmospheres. After this the non-absorbed nitrogen is removed by opening a valve, and then by means of the second forcing and sucking pump the absorbed gas is drawn out of the first vessel and forced into the second. With four vessels a complete operation is performed in five minutes. If the vessels vary in size, decreasing from the first of 10 cb.m. to the fourth of 5 cb.m. in capacity, uninterrupted working will produce a result of 7,760 litres of a mixture containing 75 per cent. of oxygen per hour; or, 168 cb.m. in twenty-four hours. The cost of working and keeping this system in order is said to be trifling, and a small amount of superintendence will suffice if the machine is made automatic. Where working power is cheap, such as water power, or the lost heat of metallurgical processes, these methods might possibly be of use, especially for metallurgical processes themselves, which could be effectually assisted by mixtures containing a smaller proportion of oxygen.

Summing up the practical results of this long list of inventions, we find in the foremost rank the well-established method of Tessié du Motay. The next place is taken by the mechanical method of Mallet, just described; which, however, has not yet met with a practical verification.

We arrive at last at the question, What uses has pure oxygen hitherto served? As the supporter of combustion, we are indebted to it for warmth and light; as a means of respiration, it is the foundation of our lives.

Let us look at it then, from these three points of view. Its metallurgical uses claim our first attention. The important part it has performed in the history of platinum has been already described. We have learned to do without it in lead soldering; hydrogen or coal gas, burnt in air, supplying a sufficient quantity of heat. The example of this industry encourages us to cherish the greatest hopes for its further and wider employment. "Just as gold," says an esteemed metallurgical chemist,<sup>2</sup> "while it was still used in soldering platinum, destroyed its appearance by yellow marks, in the same way white soft solder offends the eye when applied to coloured metals. This unsightliness induced the Society for the Promotion of Industry in Prussia to offer a prize for the discovery of a yellow solder. It would be difficult to solve this question, unless a new easily fusible metal of a red or yellow<sup>3</sup> colour could be discovered. A better chance of success offers in the self-soldering of metals by means of the oxyhydrogen blow-pipe, which has already gained triumphs in the manipulation of two metals of different natures. Is it not possible with this powerful agent, which has succeeded in soldering lead with lead, and platinum with platinum, to solder every other metal and every alloy, just in the same manner; as tin with tin,

<sup>1</sup> Mallet, *Dingl. pol. J. cic.*, 112, and *Philipps on Oxygen*, Berlin, 1874, 24 ff.

<sup>2</sup> Clemens Winkler, *Deutsche Industrieblätter*, 1871, S. 182, and *Zeitschr. d. Vereins deutsch. Ingen.* xvi. 714.

<sup>3</sup> For which reason the offer of reward has since that time been withdrawn.

copper with copper, brass with brass, silver with silver, gold with gold, and even iron with iron?

"The probability of such an innovation exists, and there is no question of the tangible benefits to be derived from it.

"We need only picture to ourselves the neatness of a workshop in which soldering is effected by means of a light, elegant gas burner, instead of the soldering iron or forge; the workman remaining uninjured by the glowing heat, smoke, and vapours, able at any moment, by the turning of a cock, to regulate the supply of heat with the greatest nicety. We need but look at the solidity of a soldering which no longer depends on a foreign substance, but is the actual blending together of the two parts, thus saving material and work, as no filing of the soldered part would be required. Such palpable advantages must silence every prejudice, and give a strong impulse to the setting on foot of thorough and persevering researches on this subject."

Since oxygen has become cheap, however, its use has likewise been recommended in that largest branch of metallurgy, the production of iron and steel.

Cameron<sup>1</sup> advises the use of oxygen or enriched air, as produced by Mallet's absorption cylinders, instead of common air from the bellows for high furnaces; and here it will be well to remember that the absorption of oxygen in water has already accidentally contributed to this result, in a manner which leaves room for improvement. Br. Kerl<sup>2</sup> calls attention to the fact that air from water blowing machines is richer in oxygen than common air. Besides, it has already been observed that charcoal, when stored up, burns with increased vigour, because it has absorbed oxygen from the air, and that this forms a valuable assistance in refining iron.<sup>3</sup>

Kuppelwieser<sup>4</sup> recommends oxygenised air for the Bessemer process, and he is of opinion that the price of Tessié du Motay's method need not be greatly reduced to allow the use of oxygen for this purpose. A great future seems here to dawn on the application of oxygen! Nevertheless, we must not omit Le Blanc's<sup>5</sup> objection, that the necessity of using fire-proof materials would render the economical advantages very questionable.

But turn from the metallurgical application of oxygen to its use for illuminating purposes. The discovery of the oxyhydrogen light by Drummond<sup>6</sup> in 1826, and its employment in surveying and for lighthouses, has destroyed every doubt as to the value of oxygen for these purposes. The reduction of the price of oxygen brought it into wider use. This time America led the way.

H. Vogel<sup>7</sup> found oxygen successfully employed in New York in 1870, not only for lighthouses, signals, and ordinary buildings, but also to illuminate the beds of rivers, for the building of bridges, and for various appliances of the magic lantern. The building of the great Brooklyn Bridge over the East River, then in an early stage of construction, was facilitated by twelve oxyhydrogen lamps, which consumed about 2,000 cubic feet of oxygen daily. Instead of chalk cylinders, the more durable zirconium-cones were employed with great advantage, and in the same way the Théâtre de la Gaîté and the Alcazar, in Paris, were lit up with fairy-like brilliancy. In the opera house in New York, a diagram of about ten square metres was thrown on a screen of damp muslin, the lamp placed behind the stage, producing wonderful effects. The magic lantern has with the help of this light become very popular in lecture rooms, for the projection of apparatus, glass-photographs, and drawings, especially since Outerbridge<sup>8</sup> taught us to draw pictures with pen and ink on thin gelatine plates. The effects are easily explained when we remember that the oxyhydrogen gas yields a light sixteen-and-a-half times stronger than the same quantity of ordinary gas would yield.

The daily amount produced in 1870 by the New York Oxygen Company was 30,000 cubic feet (850 cb.m.). The oxygen is sold in iron cylinders (patent of Robert Grant, New York), nine inches in diameter and thirty inches in length, which are filled with oxygen under a pressure of twenty to thirty atmospheres.

<sup>1</sup> Cameron, *Berg-u. Hütten Zeitung*, 1871, 132.

<sup>2</sup> Br. Kerl, *Grundriss der Hüttenkunde*, i., 217.

<sup>3</sup> *J. pr. Chem.* ci. 397; *Bergwerks Freund*, iii. 513.

<sup>4</sup> Kuppelwieser, *Berg-u. Hütten Zeitung* 1873, 354.

<sup>5</sup> Le Blanc, *Journal f. Gasbeleuchtung*, 1872, 641.

<sup>6</sup> Drummond, On the means of facilitating the observation of distant stations in geodetical operations. *Phil. Trans.* 1826.

<sup>7</sup> H. Vogel, *Ber. Chem. Society*, iii. 901.

<sup>8</sup> In Vogel's Report, cubic metres is printed by mistake.

<sup>9</sup> Morton, *Journal of the Franklin Institute*, liii. liv. lv. See also Vogel in the passage quoted before.

The cylinder is sold at one dollar per cubic foot (35 dols. per cb.m.), including the oxygen it contains under ordinary pressure; the refilling with oxygen costs five cents per cubic foot under the pressure of one atmosphere,<sup>1</sup> a very high price, exceeding the calculation of Kuppelwieser more than twenty-two times. Tessié du Motay tried to apply oxygen to the lighting of streets and public places. The "Places" before the Tuileries and Hôtel de Ville were at that time brilliant with light given off from zirconium-cones under the influence of coal gas and oxygen. The unsteadiness of the flame and its great cost led him to prefer the carburation of hydrogen and of coal gas, by passing the gases through a vessel of heavy hydrocarbons fixed to every lamp before it entered the burner. In this way the Boulevards were illuminated from the Rue Drouot to the Rue Scribe with seventy oxygen burners. But this method was given up, and the preparation of a very heavy gas instead of the usual coal gas was at last resorted to, to be burnt by means of oxygen. In this new form the visitor to the Vienna Exhibition met with it at the railway station, Kaiserin-Elizabeth-Westbahnhof. We are permitted to extract the following description from an unprinted report of Herr Karl Haase, director of the Berlin Gas Company, given before the Berlin Town Council:—

"The appearance of the grounds surrounding the Elizabeth railway station, and of the hall itself, lighted up by a mixture of coal gas and oxygen, is in the highest degree surprising. The effects caused by the little bluish flames are quite peculiar, and cannot be compared with any other light. The green of the trees seems more vivid, the colours of the dresses more brilliant, and, above all, the faces of the people appear clearer, every shade and colour showing almost as distinctly as in full daylight, notwithstanding which the light did not tire the eyes.

"The favourable impression made on entering the grounds is heightened on entering the large second-class waiting-room, where everything, down to the minutest detail of ornamentation, is most distinctly seen by the light of the little flames of only two moderate-sized gaseliers.

"However, the best conception of the new method of lighting is produced in the up-train station-hall. Here, in order to make the comparison more striking, the ordinary platform used by up-train passengers was lighted with heavy gas and oxygen, only half the number of jets being lit as were used on the opposite platform, where the old gas was burning with the aid of oxygen. Notwithstanding the double number of lamps and the good quality of the gas, the space lighted by the new method was incomparably more brilliant. The shadows of the candelabra, and even of the smoky flames, were perceptible on the white walls."

In spite of this favourable impression, Herr Haase comes to the conclusion that the new double gas, conducted in two pipes, is not adapted for general private use, particularly for the following reasons:—"The advantage of its brilliancy is more than counterbalanced by its cost, which in Berlin, taking the usual lighting power as the standard of comparison, would amount to double the price of the ordinary gas: the consumer would not understand the working of the cocks: the oxygen would deteriorate in the long conducting pipes, and the repairs would be expensive, &c. Although for public buildings, for shops, and some other purposes, the new method might answer, it would be impossible to lay down three gaspipes for these limited ends." This opinion stands diametrically opposed to that of Schiele,<sup>2</sup> who warmly recommends the new method of lighting, but it is in close accordance with the opinion stated by Le Blanc,<sup>3</sup> about a year before, in a report to the Town Council of Paris. This report is the result of extensive researches by Messrs. Féligot, Lamy, Troost, De Mondéair, and Le Blanc, appointed a commission for the purpose by the Prefect of the Seine in 1869. They undertook to test the method on the Place de l'Opéra, as well as in the laboratory, by burning with half its volume of oxygen, in separate burners, ordinary coal gas, Boghead gas, and gas saturated with fluid hydrocarbons according to various systems. They came to the conclusion that at equal illuminating powers Tessié du Motay's method is almost always more expensive, mostly twice as expensive, as the usual illumination. Only in one case, where the fluid hydrocarbons of Boghead coal were used for carburation, according to Levéque's method, by saturating wicks with the oil and letting the gas pass over them, the price of the new

light appeared twice as cheap as the ordinary method, and that only when large burners were used, and consequently a greater quantity of light was produced.

The calculations were of course founded on the data furnished by the Tessié du Motay Gas Company respecting the prices of oxygen, of the carburation, &c. In truth, however, it appeared that in the last-named experiment 1 cb.m. of gas, instead of taking up 50 gr. of fluid hydrocarbons, as the company pretended, actually absorbed 266 gr.; and thus the economy, to say the least, became very questionable. As to the lighting power, it was possible to increase it so as to form three to seven times the power of ordinary street-burners. But Boghead gas can also produce three times the quantity of light, in suitable burners, without having recourse to pure oxygen, and for general purposes such an intensity of light is not desired; on the contrary, the light is lessened 30 per cent. by globes or shades. The Commission came to the decision, therefore, of advising the Corporation of Paris not to authorise the laying down of oxygen pipes, but rather to leave it to the company to supply oxygen and carburetted coal-gas in portable vessels to the comparatively few who stand in need of such an increased intensity of light.

The results arrived at in Brussels were no more favourable. During the last year lighting by oxygen was tried for a short time in some cafés, as well as in the Passage St. Hubert, and then discontinued<sup>4</sup> on account of the aforesaid objections. In Vienna, in April 1874, the Westbahnhof was still lighted with oxygen, but the system had spread no further; for in spite of its intensity and acknowledged beauty, the bluish moonlike light did not produce anything like a general satisfaction.<sup>5</sup>

The jury of the Vienna Exhibition inspected the oxygen lighting at the Westbahnhof. In the Exhibition building itself, oxygen industry was not represented.

If further experiments confirm the above opinions, the industry of oxygen will have lost the root from which it commenced to grow, because wherever it has sprung up it was fostered by the hope of being employed for illuminating purposes.

Many of the alleged disadvantages, especially the cost of the laying down of pipes, are avoided in the arrangement which Philipps<sup>6</sup> proposed for oxygen lighting. According to this proposition lamps (manufactured by George Berghausen, of Cologne) were to be fed with very heavy tar oil containing naphthalin, whilst oxygen was introduced through the middle of the wick. It is, however, very doubtful if any larger city would renounce the advantages of gas-light in favour of this arrangement, and consequently, if there is any chance of its application on a large scale.

Let us be all the more hopeful that oxygen industry will find its saving ally in metallurgy.

In medicine it has won no friend. Up to the present time there is nothing to contradict Pereira's opinion<sup>7</sup> in spite of many more recent praises of the medicinal powers of oxygen,<sup>8</sup> and we can therefore do no better than quote it anew:—

"Soon after the discovery of oxygen, its therapeutical application was in great favour. The want of a proper supply of oxygen to the body was considered to be the cause of many diseases, such for example as scorbute, and it was asserted to have been used in many cases with brilliant success. Beddoes<sup>9</sup> and Hill employed it in England. The latter declares that he found it useful in cases of asthma, weakness, ulcer, humor albus, and scrofulous bone diseases.

"These opinions have nevertheless been greatly modified on chemical, no less than on physiological grounds. In cases of asphyxia, caused by want of air, or by inhaling noxious gases, the respiration of oxygen may possibly be useful. For this reason it has been administered in cases of asthma threatening suffocation. But as the patients in such cases are scarcely able to inhale it, if it acts at all, it can only act as a palliative, and is decidedly incapable of preventing fresh attacks. In most cases where oxygen has been inhaled it was therefore powerless to help; and from the physical reasons stated above, very little success can be anticipated from its employment.

<sup>1</sup> Letter dated April 14, 1874, of M. Meissner, Professor of Chemistry in Brussels, to A. W. Hoffmann.

<sup>2</sup> Verbal communication of Professor Hlasiwetz.

<sup>3</sup> Philipps on Oxygen. Berlin, 1871, 46.

<sup>4</sup> Pereira, "Art of Healing." Translated into German by Buchheim, i. 217.

<sup>5</sup> Verbal communication of Prof. Dr. Oscar Liebreich.

<sup>6</sup> "Considerations on the use of factitious airs, and on the manner of obtaining them in large quantities." By F. Beddoes and J. Watt. Bristol, 1794-95. There was a Pneumatic Institute established in Bristol in 1798, in which the medical properties of gases were tried, and it was here Humphry Davy discovered the effects of protoxide of nitrogen.

<sup>7</sup> Deutsche Gewerbeszeitung, 1867, 18; see also Vogel.

<sup>8</sup> Schiele, Journal für Gasbeleuchtung, January 1873.

<sup>9</sup> Rapport de M. Félix le Blanc sur le nouvel éclairage oxyhydrique. Paris, 1872. Short extracts in the Journal f. Gasbel, 1873, 641.

"This did not prevent medical speculators from opening an institution in Berlin for inhaling oxygen, where it is now being sold at 7d. the cubic foot, while oxygen water is sold at 2d. the bottle. As water of 0° does not absorb 4 per cent. of its volume, a half-litre bottle contains less than 20 cb.m., or 0'0017 grammes of this gas! It seems incredible that such a dose should be expected to produce any effect whatever. Just as travellers are recommended to provide themselves with concentrated food, those who wish to climb the highest mountain tops, or by means of balloons reach great heights, where the thinness of the atmosphere might cause them dangerous inconveniences, are advised to use pure oxygen as a concentrated means of respiration. P. Bert<sup>1</sup> exposed himself and others in proper apparatus, to degrees of rarefaction of air, which far surpassed that of the greatest heights ever reached by man. The want of breath and symptoms of suffocation which ensued, when the barometer stood at from 300 to 250 mm., were, according to his account, at once relieved by one breath of pure oxygen. A mixture of the same with atmospheric air proved even more effectual than the pure gas, and, on an aerial voyage which the late MM. Crocé Spinelli and Sivel undertook from Paris on the 22nd of March, 1874, they provided themselves with mixtures containing 45 and 75 per cent. of oxygen to 55 and 25 per cent. of nitrogen. They were enabled by the help of this gas to make valuable physical observations,<sup>2</sup> at heights of more than 6,000 metres, leisurely and without any bodily inconvenience; and although Glaisher had succeeded in reaching still greater heights without this assistance, oxygen offers a means of gaining strata hitherto inaccessible."

These words, however, were scarcely written when the newspapers announced the death of the courageous navigators on a new aerial voyage; suffocation appears to have set in so suddenly as to incapacitate them at once from using their respiratory apparatus.

The physiological applications of oxygen form the bridge to some considerations on the practical uses of ozone, the discovery of which had been greeted by exaggerated hopes.

A. OPPENHEIM.

## SOCIETIES AND ACADEMIES

LONDON

Chemical Society, Feb. 17.—Prof. Abel, F.R.S., president, in the chair.—The president announced that Mr. James Duncan had presented the Society with a most life-like and spirited marble bust of Dr. Holmann. He then called upon Prof. Frankland to deliver his lecture "On some points in the analysis of potable waters." A report of this we give on another page.—A full discussion of the variation in purity of the water supplied during the past eight years by the various London companies followed, illustrated by most excellent diagrams, and the lecturer concluded by pointing out some of the objections to the other well-known processes employed for water analysis.

Zoological Society, Feb. 15.—Prof. Mivart, F.R.S., in the chair.—Mr. Sclater exhibited the parrot called in Tschudi's "Fauna Peruana" *Conurus illigeri*, and observed that it had been certainly wrongly determined. Mr. Sclater was of opinion that the bird belonged to a species hitherto unrecognised, and proposed to call it *Ara couloni*, after M. Coulon, of Neuchatel, who had sent the specimen for exhibition.—Dr. Cobbold, F.R.S., exhibited and made remarks on a Parasite (*Echino-rhynchus*), obtained from the Tamandua Anteatr, which had died in the Society's menagerie.—Mr. W. K. Parker, F.R.S., read the second portion of his memoir on Ægithognathous Birds.—A communication was read from the Rev. O. P. Cambridge, in which he described a new order and some new genera and species of Arachnida from Kerguelen Island, from specimens collected by Mr. Eaton during the Transit of Venus Expedition.—Mr. G. French Angas communicated descriptions of four new species of land shells from Australia and the Solomon Islands, which he severally proposed to name *Helix morebyi*, *Helix ramidani*, *Helix beatrix*, and *Helix rhoda*. Mr. Angas also made some remarks on the nomenclature of *Helix angasiana* of Pfeiffer, and *Helix bitaniata* of Cox.—Mr. Sclater read some notes, by himself and Mr. Salvin, on some of the Blue Crows of America, taken from specimens lately examined, and pointed

out certain changes which it would be necessary to make in the nomenclature of the group adopted in their "Nomenclator Avium Neotropicalium."

Geological Society, Feb. 2.—Mr. John Evans, F.R.S., president, in the chair.—Edward Richard Alston, David Corse Glen, Thomas Vincent Holmes, William G. M'Murtrie, Charles Bine Renshaw, Robert Drysdale Turner, and George Ferris Whitbourne, were elected Fellows of the Society.—Evidence of a carnivorous reptile (*Cynodrakon major*, Ow.) about the size of a lion, with remarks thereon, by Prof. Owen, F.R.S. The specimens described by the author consist of the fore part of the jaws and the left humerus of a reptile obtained from blocks of Triassic (?) rock from South Africa, forwarded by the late Mr. A. G. Bain. The upper jaw displays a pair of enormous canine teeth much resembling those of *Machairodus*, being of a very compressed form, with the hinder trenchant margin minutely toothed. There is no dentated border to the fore part of the crown. No teeth can be detected in the alveolar border of the right ramus of the lower jaw, which extends about an inch behind the upper canine. In the symphyseal parts of the lower jaw the bases of eight incisors and of two canines are visible, the latter rising immediately in front of the upper ones, to which they are very inferior in size, and being separated by a diastema from the incisors. In this character, as in the number of incisors, the fossil resembles *Didelphys*; and in structure both canines and incisors resemble those of carnivorous mammals. The left humerus is 10½ inches long, but is abraded at both extremities. It presents characters in the ridges for muscular attachment, in the provision for the rotation of the forearm, and in the presence of a strong bony bridge for the protection of the main artery and nerve of the forearm during the action of the muscles, which resemble those occurring in carnivorous mammals, and especially in the Felidæ, although these peculiarities are associated with others having no mammalian resemblances. The author discusses these characters in detail, and indicates that there is in the probably Triassic lacustrine deposits of South Africa a whole group of genera (*Galesaurus*, *Cynochampsia*, *Lycosaurus*, *Tigrisuchus*, *Cynosuchus*, *Nyktosaurus*, *Scalopsosaurus*, *Procolophon*, *Gorgonops*, and *Cynodrakon*), many of them represented by more than one species, all carnivorous, and presenting more or less mammalian analogies, for which he proposes to form a distinct order under the name of Theriodontia, having the dentition of carnivorous type; the incisors defined by position, and divided from the molars by a large lanianiform canine on each side of both jaws, the lower canine crossing in front of the upper, no ectopterygoids, the humerus with an entepicondylar foramen, and the digital formula of the forefoot, 2, 3, 3, 5; 3 phalanges. The author further discussed in some detail the remarkable resemblances presented by these early reptiles, in some parts of their organisation, to mammals, and referred to the broad questions opened out by their consideration. He inquired whether the transference of structures from the reptilian to the mammalian type has been a seeming one, due to accidental coincidence in species independently created, or whether it was real, consequent on the incoming of species by secondary law. In any case the lost reptilian structures dealt with in the present paper are now manifested by quadrupeds with a higher condition of cerebral, circulatory, respiratory, and tegumentary systems, the acquisition of which, the author thought, is not intelligible on either the Lamarckian or Darwinian hypotheses.—On the occurrence of the genus *Astrocrinites* (Austin) in the Scotch Carboniferous Limestone Series, with the description of a new series (*A. Bennieti*), and remarks on the genus, by Mr. R. M. Etheridge, jun. The author, in his introduction to the paper, commenced with a general history of the genus *Astrocrinites* of Austin, commenting upon the change of name it had received from the several authors who had written upon and noticed the species *A. tetragonus* of Austin. In 1843 Major T. Austin described this aberrant Echinoderm under the name *Astrocrinites*, assigning its geological horizon to be the Carboniferous Limestone, and locality Yorkshire. Dr. H. G. Bronn rejected the name *Astrocrinites* on account of its resemblance to *Asterocrinites* of Münster, and proposed instead that of *Zygocrinites*. Römer, from the four-rayed structure of our *Astrocrinites*, allied it to the Cystoidea rather than to the Blastoidea. Prof. de Koninck, and M. le Hon, however, referred *Zygocrinites* to the Blastoidea, and stated their reasons for so doing. Prof. Morris, in 1854, altered Austin's *Astrocrinites* into *Astrocrinus*, and does not notice Bronn's name, *Zygocrinites*. Prof. Pictet provisionally referred the latter genus structurally to *Codonaster*,

<sup>1</sup> Fouvielle (La Science en Ballon Paris, 1869), and elsewhere.

<sup>2</sup> Bert, Compt. Rend. 1874, 911.

<sup>3</sup> Compt. Rend. 1874, 946.

noticing, however, its four instead of five pseudambulacra. The author then notices at some length the species he proposes to call *A. Benniei*, which appears to differ much from Austin's *A. tetragonus*. The body or calyx of *A. Benniei* is tetradiate, having four convex lobes, three of which are alike, the fourth differing considerably from the others, the deep re-entering angles between the lobes are occupied by the pseudambulacra, the dorsal surface is densely covered with closely-set tubercles, but shows no point of attachment, the ventral surface is flattened, having a large central aperture, from which radiate the four pseudambulacra; excentric as compared with the ambulacral system is a second and pyriform aperture of complex structure. The component parts are then minutely described, followed by careful descriptions of the pseudambulacra, apertures, and ornamentation, also a discussion as to the presence of a madreporiform tubercle. The second part of the paper treats upon the affinities of *A. Benniei* (Ether.) with *A. tetragonus* (Austin). Part the third enters fully and critically into the systematic position of *Astocrinites* amongst the Cystoidea and Blastoidea. In the concluding and fourth portion of the paper, the localities and geological horizons are given. Twenty-seven figures, occupying three plates, accompanied the paper.—On the genus *Merycochærus* (family Oreodontidæ), with descriptions of two new species, by Mr. G. T. Bettany, B.A. Communicated by Prof. T. McKenny Hughes. An account was given of remarkable vertebrate tertiary skulls and other remains brought from Upper Oregon by Lord Walsingham, in 1872, and presented by him to the Woodwardian Museum, Cambridge. The characters of the family of Ungulates (Oreodontidæ), to which they belong, and of the genera of the family, were referred to, and supplemented from examination of these remains. The genus *Merycochærus*, previously known only from teeth and portions of jaws, was further defined and described from large skulls and portions of skulls. The remarkable size of the temporal fossæ, the form of the zygoma, and especially its great posterior transverse crest, are special points of interest. Finally two new species, *M. temporalis* and *M. Leidyi*, were defined and described.

Meteorological Society, Feb. 16.—Mr. H. S. Eaton, president, in the chair.—Frank C. Capel, Zophar Humphreys, Edward Mawley, Rev. George H. Mullins, William H. Watson, and C. Theodore Williams were elected Fellows of the Society.—The following papers were read:—On an improvement in aneroid barometers, by the Hon. R. Abercromby. The improvement consists in jewelling the ends of the arbor of the index hand like the ordinary pivots of a watch, and making the hand work under the cap instead of in the usual manner. The advantages gained are: (1) increased sensitiveness; (2) increased definiteness of the indications; and (3) diminished influence of weather on the bearings.—Meteorology in India in relation to cholera, by Col. J. Puckle, M.S.C. The author in this paper lays before the Society some facts in connection with several serious outbreaks of cholera in different parts of the Mysore country during the last fifteen years, and draws attention to the similarity of the abnormal meteorological conditions that existed on each occasion. Except in a few of the largest towns in India there are no sewers, and no sewer gas proper. Even in these exceptional towns the drainage is incomplete. The general sanitary arrangements are of the most primitive character. In the rural districts the inhabitants adhere to the Mosaic law, in so far that they go forth to the fields, but they do not carry the "paddle" with them for the purpose that was the exponent of the "dry earth" system; that necessary portion of the work is left to the drying action of a powerful sun, to the kites and other carrion birds, and, *horribile dictu*, to the pigs and poultry that afterwards are doubtless turned into food. In this way it is not difficult to conceive that sewage of the direst and most unadulterated kind may possibly be taken into the system through poisoned meat, or during rainfall it may find its way to open reservoirs or wells; from which two sources the inhabitants depend for their water supply. At other times during the hot, dry weather, when no rain falls, malaria may arise and be distributed through the agency of the atmosphere. Notwithstanding all that has been said and done, the clue to the mystery of the origin of the disease remains undiscovered. It is the same with the treatment. Remedies that at one time appeared to be most effectual have, at another, most signally failed. Even during the same attack, the same remedy that cured one person would fail in another, even where the same conditions apparently existed. Failure of the usual rainfall at the proper time, and abnormally

high and harsh temperature, have been concurrent with several attacks in Mysore and Southern India. At such times the open reservoirs or lakes and wells are much below the usual spring level, and any contamination received at such a time is obviously much less diluted, and more harmful. The author then gives an account of several attacks that have come under his own personal knowledge, which shows beyond doubt that the disease has been arrested by change of air and surroundings, and that ordinary sanitary practice has prevented a possible outbreak. After referring to the recent outbreaks at Bangalore and Madras the author says that everywhere the same story is told of the occurrence of cholera coincident with long absence of rain and a temperature abnormally high.—On sixteen months' rain at Bristol, by W. F. Denning.

Entomological Society, Feb. 2.—Sir Sidney Smith Saunders, C.M.G., vice-president, in the chair.—Mr. McLachlan directed attention to an article by M. Flaminio Baudi in the *Petites Nouvelles Entomologiques*, respecting the habits of *Cychnus cylindricollis*, which he had taken on Monte-Codeno, feeding on the body of a snail (*Helix frigidula*), into the spiral of which the beetle was enabled to enter by means of its long prothorax. Some interesting remarks were made by Mr. Bates and others on the peculiar structure and habits of the insect, which appeared to have been found only on a very sterile portion of the plateau of the mountain, and in no other part.—A valuable paper was communicated by Dr. D. Sharp, entitled "Contributions to an Insect-Fauna of the Amazon Valley (Staphylinidæ)." Of this important group of Coleoptera, 487 species were enumerated as inhabiting the valley, of which 463 were described as new; suggesting forcibly how little is really known of the Staphylinidæ of Tropical America. Dr. Sharp also stated that he had devised a method of covering and hermetically sealing the type specimens which, he believed, would accomplish their almost complete preservation, and that he hoped soon to be able to publish a description of the method. The author concluded with remarking on the great importance of certain sexual characters in distinguishing the species.

Institution of Civil Engineers, Feb. 15.—Mr. Geo. Robt. Stephenson, president, in the chair.—The paper read was on estimating the illuminating power of coal gas, by Mr. William Sugg, Assoc. Inst. C.E.

EDINBURGH

Royal Society, Feb. 21.—Prof. Kelland, vice-president, in the chair.—The following communications were read:—On the structure of the body-wall in the Spionidæ, by Dr. W. C. McIntosh.—On circular crystals, by E. W. Dallas.—Preliminary note on the flame produced by putting common salt in the fire, by C. M. Smith; communicated by Prof. Tait.

CONTENTS

	PAGE
REPORT OF THE VIVISECTION COMMISSION . . . . .	321
THE "GEOLOGICAL RECORD." By J. W. J. . . . .	322
OUR BOOK SHELF:—	
Pirie's "Lessons on Rigid Dynamics" . . . . .	323
Carrick's "Secret of the Circle" . . . . .	323
Eden's "Australian Heroes" . . . . .	323
LETTERS TO THE EDITOR:—	
Dr. Bastian and Prof. Tyndall on Spontaneous Generation.—Prof. K. RAY LANKESTER, F.R.S. . . . .	324
Radiometers and Radiometers.—T. N. HUTCHINSON . . . . .	324
The Sailing Flight of Birds.—By R. A. . . . .	324
The Use of the Words "Weight" and "Mass."—J. T. BOTTOMLEY . . . . .	325
Seasonal Order of Colour in Flowers.—G. E. HERON ROGERS . . . . .	326
OUR ASTRONOMICAL COLUMN:—	
Variable Stars . . . . .	326
Minor Planets . . . . .	326
The Saturnian Satellite, Hyperion . . . . .	326
THE DATE OF EASTER . . . . .	326
HUNTERIAN LECTURES ON THE RELATION OF EXTINCT TO EXISTING MAMMALIA, II. By Prof. FLOWER, F.R.S. . . . .	327
THE EFFECTS OF THE SUN'S ROTATION AND THE MOON'S REVOLUTION ON THE EARTH'S MAGNETISM. By J. ALLAN BROWN, F.R.S. . . . .	328
PHYSICAL SCIENCE IN SCHOOLS. By JAMES M. WILSON; LINNÆUS CUMING . . . . .	329
THE ORGANIC IMPURITIES OF DRINKING WATER. By Prof. FRANKLAND, F.R.S. . . . .	329
RELATION BETWEEN THE LIMIT OF THE POWERS OF THE MICROSCOPE AND THE ULTIMATE MOLECULES OF MATTER. By H. C. SORBY, F.R.S. . . . .	332
THE TUFTED DEER OF CHINA . . . . .	334
NOTES . . . . .	334
THE INDUSTRIAL APPLICATIONS OF OXYGEN, II. By Dr. A. OPPENHEIM . . . . .	336
SOCIETIES AND ACADEMIES . . . . .	339

THURSDAY, MARCH 2, 1876

THE GOVERNMENT SCHEME OF  
UNIVERSITY REFORM

THE speech of Lord Salisbury in the House of Lords on Thursday evening, on introducing a Bill for regulating the reform of Oxford University, will probably satisfy the expectations with which the declaration of the Government policy has been awaited. It is a fortunate circumstance that the conduct of the measure should be placed in the hands of one who is, at the same time, Chancellor of the University, a minister in whom both his party and the country have entire confidence, and also a well-known friend of the physical sciences. The Government scheme, therefore, is introduced under favourable auspices; and, in itself, so far as it has been yet revealed, it seems calculated to disarm all opposition. It is true that much yet remains to be learned concerning the modes in which the scheme is to operate. The names of the Commissioners, to whom a certain degree of control is apparently to be entrusted, will be looked for with anxiety; and the details, which will only be understood when the bill is printed, will also be of much interest to those who will be directly affected by them. But the general public, who are after all the party most concerned, is contented with the enunciation of principles which Lord Salisbury's speech contains. He argued, with great ingenuity, that it is not possible for Parliament to dictate to the University and College authorities the precise lines of reorganisation along which they are to proceed. This argument suggests much that a party critic may object to as involving an abnegation on the part of Ministers of their own proper responsibility. However that may be, it is certain that people at large are totally incapable of giving an intelligent approval to anything more definite than the proposals which Lord Salisbury has sketched. Indeed, it may be doubted whether the absence of complete knowledge to which Lord Salisbury himself pleaded guilty, though it may somewhat surprise and disturb Oxford residents, will not have the effect of bringing him into closer harmony with the general feeling of the country. The case for reform does not rest upon minor matters of detail which require research to discover and particular experience to appreciate, and of which the meaning might be altogether altered by further research and wider experience. The plain statement of the facts is enough, and upon that plain statement Lord Salisbury has wisely relied.

The collective revenue of the Oxford Colleges, after making certain necessary deductions, amounts to something over 200,000*l.* per annum; and as the number of undergraduates is less than 1,000, it follows that the average income per undergraduate is a little more than 200*l.* a year. It is important that this estimate should not be interpreted as if it meant the average cost of educating each undergraduate, as Lord Salisbury has not sufficiently guarded himself against the possibility of this confusion. The real meaning of the calculation is to indicate forcibly that at the present time endowment is out of all proportion to educational efficiency. Looking at the figures from another point of view, we find that,

out of the total endowments, Fellowships of one kind or another take just one-half or 100,000*l.* Of this sum, again, Lord Salisbury estimates that "idle Fellowships," or those to which no duties are attached, absorb from one-half to four-fifths. There is thus left a balance of from 50,000*l.* to 80,000*l.* a year, which is admittedly not devoted to academical purposes. It is important to recollect that this calculation comes to us upon the authority of Lord Salisbury. The late University Commission, rigidly limiting itself to its immediate functions, merely presented a general account of the income and expenditure of the Universities and their Colleges, and did not attempt to estimate the number of non-resident Fellows, or even to suggest what proportion of the endowments were unremuneratively expended. But this large sum is far from being all that University reformers will have to deal with. Lord Salisbury states that there must be added no less than 123,000*l.* per annum, which represents the probable augmentation in the rents of the College estates within the next fifteen years, as ascertained by the Commission of Inquiry presided over by the Duke of Cleveland. A yet further addition is suggested by Lord Salisbury, arising from the appropriation to educational purposes of certain ancient trust-funds vested in the Colleges, which are now misapplied. Of the amount of this latter source of income, it is impossible to give even an approximate guess. Lord Salisbury carefully refrained from hinting at any specific trust; and it is doubtful whether there are, at Oxford at least, any misapplied trust-funds of any magnitude, except perhaps the Hulsean endowment connected with Brasenose College. Lord Salisbury seems rather to have been glad to take the opportunity of stating his views with regard to the general question of modifying old endowments, than to have referred to any changes of practical importance. It is noteworthy, however, that his views entirely coincide with those expressed by Lord Derby before the University of Edinburgh last December; and thus the two most influential members of the Conservative Ministry are found in agreement upon a policy which has sometimes been claimed as the peculiar heritage of the Liberal party. Whatever may come from minor trusts, the whole available surplus of the endowments at Oxford may be fairly estimated at about 200,000*l.* a year. This sum, of course, is not at the present moment ready for distribution; but it is the amount which, allowing for vested interests and the slow processes of change, Lord Salisbury appropriates to the purposes of his scheme of reform.

That scheme itself has only, as yet, been indicated with very vague touches; but enough has been said to satisfy all reasonable hopes, and to encourage us to wait confidently for the filling-in of the details. In the first place, Lord Salisbury proposes to restore to the University, so far as money can do so, her ancient pre-eminence over the Colleges. The demands of the University for buildings and for professors are to be supplied out of the forfeited "idle Fellowships." "It may be wise to maintain a few of these latter, limiting the holding of them to a certain number of years; but I do venture to lay down that all the University wants, in the shape of museums, libraries, lecture-rooms, and the proper payment of teachers, should be provided for, before the subject of furnishing incomes to men who do nothing can be enter-

tained." The second principle enunciated by Lord Salisbury is the endowment of research—a principle which has been long advocated in these columns, but which now for the first time appears destined to obtain legislative sanction. In the case of its distinguished sojourner, Prof. Max Müller, the University of Oxford has already admitted its duties in this matter; and now research in the physical sciences, under the ægis of Lord Salisbury, and with all the authority that Parliament can lend, will put in its claim to be "made a part of the regular and recognised machinery of the University." To many persons this will be thought the greatest novelty contained in the speech, and it is significant that none of the three peers who followed the mover made any allusion to it in their brief remarks. But it is not necessary now to expatiate upon the importance of the proposal, or the valuable results that will flow from it. It is the first fruits of the Royal Commission on the Advancement of Science, and will lead, we trust, to the adoption of more of the recommendations made by that laborious body. It is of more importance on this occasion to call attention to a distinction which Lord Salisbury has apparently drawn, and to which the Colleges would do well to take heed. If we understand his words aright, he would impose upon the University the duty of supplying, of course from the College endowments, the capital sum that will be required "from time to time for buildings and apparatus, necessary for the purposes of research;" while he would leave to the individual colleges "to provide for the maintenance and benefit of persons of known ability and learning, who may be engaged in study or research in the realms of art and science." This distinction seems to us an important one, partly because it assigns to each the functions which they can best perform, with the least revolution in their characters; and still more because it insists upon two separate modes of endowing research, which are of equal value, and must be both demanded alike. We cannot forbear quoting at some length the comprehensive views of Lord Salisbury on this subject:—"We are of opinion that the mere duty of communicating knowledge to others does not fulfil all the functions of a University, and that the best Universities in former times have been those in which the instructors, in addition to imparting learning, were engaged in adding new stores to the already acquired accumulation of knowledge. There are new sciences which have gained, and which are pressing for, admission to the Universities, and I think no one can doubt that it is for the interest alike of the students and of the nation at large that such sciences should have full encouragement. . . . What I am particularly anxious for is that all branches of culture should have equal encouragement, and should be regarded, not as rivals, but as allies in the great and difficult task of cultivating and developing the human mind." Apart from these two leading features of the Government scheme of University Reform—the endowment of the University by the Colleges, and the endowment of Research—it remains only to notice the ease with which Lord Salisbury, in one short sentence, brushes aside "the religious difficulty" as unworthy of attention. "The teachers at Oxford are not clergymen now, and if we want to get the best men, we must get them from other sources than that which formerly supplied them."

With regard to the machinery by which these great

reforms are to be effected, it is better that criticism should wait until fuller explanation is given. On a first glance, it would seem that the colleges are to be allowed a year and a half to devise their own schemes of reform, subject only to the approval of the Commissioners. On this point we confess to a feeling of distrust of such "permissive legislation;" and are disposed to adhere to the old-fashioned liberal theory, which had its advocate in the Archbishop of Canterbury. "He believed that the Colleges are not an exception to the general rule which has been found to exist everywhere, that hardly any corporation was capable of entirely reforming itself without external pressure." It should never be forgotten that some colleges have already tried their hands at reform, and that none have yet made adequate provision for the wants of the University or of scientific research. The College which, in all educational matters, is usually recognised as the most efficient, has obtained final sanction to a scheme which does not allude to either of these subjects. Another college imagined but a few years ago that it was reorganising itself in accordance with the most modern ideal, when its teaching staff obtained permission from their episcopal visitor that they might one and all incontinently marry, and bought off his natural opposition by agreeing to retain all the existing clerical restrictions. It is whispered, at the present moment, that a third college has just matured a scheme by which each of the tutors shall receive a fixed salary from endowment of 800*l.* per annum. With these instances in view, it will manifestly be the duty of all sincere reformers to urge that the powers given to the Commissioners should be strong enough to override the possibility of such abuses. If only this be done, and if the name of Cambridge be added to the bill, the Government project will become in all respects praiseworthy.

#### LEGISLATION REGARDING VIVISECTION

IN our observations last week upon the Report of the Vivisection Commission, we remarked that some might be inclined to think that in the legislative measures recommended Science has made too great concessions to popular feeling, and a more careful perusal of this bulky volume tends to convince us of the correctness of this opinion. One of the most astonishing things referred to in the whole report is the small number of persons for whose restraint the new law is to be passed. Judging from some of the statements made by opponents of vivisection, one would think the vivisectors in this country must be counted by hundreds; but the Commissioners inform us that, on the contrary, not more than fifteen to twenty at the utmost are systematically engaged in the performance of experiments on living animals. They add, however, that experiments are, there is little doubt, occasionally performed by private persons, of whose number they can form no accurate computation. As there might be many such, and their experiments taken collectively might give good grounds for the belief that vivisection is extensively carried on in this country, we have tried to gain some information on this point from the statements of various witnesses. The Society for the Protection of Animals liable to Vivisection has published a pamphlet containing such extracts from the Report of



the Commission as tend to justify the position taken up by the Society, leaving the advocates of vivisection, as it tells us in a prefatory note, to give publicity to such parts of the evidence as favour their views. We have selected the witnesses quoted by this Society as giving evidence upon the extension and abuses of vivisection, in order that we might not run the risk of being misled by partial statements and of under-estimating the extent to which the practice prevails in this country.

The first of these, Dr. Acland, observes that the number of persons in this and other countries who are becoming biologists without being medical men is very much increasing; but beyond this statement, in which he appears to have in view professional physiologists rather than occasional experimenters, there is nothing in his evidence to lead to the belief that vivisection is practised to any extent by the latter class. Mr. G. H. Lewes tells us that so far from ignorant people exercising their fancy in cutting up live animals, even medical students are extremely reluctant to perform experiments at all on account of the trouble involved in doing so. Sir William Ferguson states that the impression on his mind is that experiments are done very frequently in a most reckless manner; but when we look for the grounds of this belief we cannot find anything except the accounts given by students of experiments they had seen during lectures. We should have thought a man of Sir William's experience would not have trusted to such hearsay evidence without farther investigation, knowing, as he must do, how students delight to exaggerate and to tell frightful stories of the dissecting-room for the pleasure of seeing their mother's or sister's eyes grow wide with horror at the tale. The evidence of other witnesses shows that such exaggeration must have been practised here, and that no such experiments as Sir William describes have been performed in any medical school in this country. But this witness is of opinion that it is only in laboratories and schools that vivisection is carried on, as in this country surgeons do not employ it for the purpose of acquiring dexterity, and he thinks there is not much amateur physiology. Such evidence from an active opponent of vivisection goes far to show that the number of occasional experimenters cannot be great, and that the practice of vivisection is almost entirely confined to the fifteen or twenty persons alluded to by the Commissioners. Small as this number is, we would have considered it right to legislate if anything like wanton cruelty had been shown to be practised by them; but the Secretary of the Royal Society for the Prevention of Cruelty to Animals admits that he does not know a single case of the sort, and that in general English physiologists have used anæsthetics where they think they can do so with safety to the experiment. Such being the case, it seems to us that the objections raised to legislative interference by several witnesses carry great weight. Those made by Mr. John Simon are especially worthy of consideration, not only on account of his well-known ability and clear-sightedness, but because his official position has given him a better opportunity of becoming acquainted with the working of laws and of forming a correct judgment regarding the probable operation of any proposed bill than other witnesses who are constantly engaged either in the laboratory or with the cares of practice.

The opinion he expresses that incompetent experimenters, careless of the sufferings they inflict, do not exist as an appreciable class in this country, is borne out by the evidence we have already referred to, and it does seem hard that physiologists of high reputation and unblemished character should be treated as a dangerous class, and should be licensed and regulated "like publicans and prostitutes under the licensing system;" Mr. Simon considers that it would afford facilities for the persecution of physiologists, and would enable those who are so inclined to hold them up individually to popular odium. That the inclination is not wanting is shown by the advertisements of the Society for the Abolition of Vivisection constantly appearing in the daily papers. In these an attempt is made to destroy whatever medical practice the authors of the "Handbook for the Physiological Laboratory" may have, and by thus reducing their means of livelihood to starve them as far as possible. This is done by representing them as so hardened by their pursuits and so callous to suffering as to be unfit for attendance at a sick-bed; although we learn from the evidence of Prof. Rolleston and Mr. Simon that two of them at least are exceedingly kindhearted men, and the other two have devoted themselves to researches having an unusually direct bearing on the prevention of disease or the alleviation of suffering.

Much and careful consideration is therefore wanted lest in the endeavour to prevent abuses which may hereafter creep into the practice of vivisection of animals we do not afford facilities for the mental vivisection so graphically described in the evidence of Mr. G. H. Lewes, of honourable, kind-hearted and sensitive men, whose pursuits are not merely advantageous to science but productive, as the Report clearly shows, of great benefit, both to the human race and the lower animals. Legislation may still be wanted in the interests of physiologists themselves, not less than of the animals on which they experiment, but what we have said is, we think, sufficient to show that this must be undertaken in no hasty spirit.

---

#### MISS BUCKLEY'S HISTORY OF NATURAL SCIENCE

*A Short History of Natural Science, &c.* By Arabella B. Buckley. (London: John Murray, 1876.)

THE object of this book is, as stated in the Preface, "to place before young and unscientific people those main discoveries of science which ought to be known by every educated person, and at the same time to impart a living interest to the whole, by associating with each step in advance some history of the men who made it."

We are also told that—

"When treating of such varied subjects, many of them presenting great difficulties both as regards historical and scientific accuracy, I cannot expect to have succeeded equally in all, and must trust to the hope of a future edition to correct such grave errors as will doubtless be pointed out, in spite of the care with which I have endeavoured to verify the statements made.

"As the size of the book makes it impossible to give the numerous references which would occur on every page, I have named at the end of each chapter a few of the works consulted in its preparation, choosing always in

preference those which will be useful to the reader if he cares to refer to them."

This last sentence fully accounts for the character of the work. We may say at once that we have not read it through. Our readers will probably soon see why. But we may get a good idea of its contents by dipping in here and there. Geologists do not require to break a mountain down into road metal in order to discover its structure. The book is by no means a paste and scissors production; it is evidently the outcome of very considerable mental exertion, not only in reading, but in thinking. But, unfortunately, the author seems to have accepted as equally trustworthy guides some of the best and most authoritative works extant, and along with them some, often of the trashiest, volumes [of the popular scientific literature of the day. In several, especially of the earlier chapters, the first class of works is mainly referred to, in others the second; a few chapters are based upon a mixture, consequently the result is extremely curious and instructive, at least to the scientific critic.

As a whole, the work is decidedly superior to any of the popular ones on which part of it is based; though of course, as they have to a certain extent leavened it, it is in many places not only inaccurate, but positively astounding in its misrepresentations. It is quite easy, however, to trace in each case the more extraordinary blunders to their popular scientific source.

Recent British popular scientific works, at least since we have lost such masters as Faraday and Herschel, have, in general, one or other of two marked characteristics. The honest but ignorant man, too ignorant to be aware of his own ignorance, complacently and in good faith writes preposterous nonsense. Our author has wisely let *him* alone.

Other quasi-scientific men are acute enough to know, perhaps even to admit to themselves (but only under the strictest seal of secrecy) their own ignorance. Sometimes they may condescend so far from their pedestals as to seek assistance from those who are really competent to give it, but even then they do not save themselves. The true critic easily perceives by a single loose word or phrase which such writers cannot refrain from adding to the accurate periods of their mentor (if only to save their own consciences on the question of originality) the true state of the case.

When the quasi-scientific writer feels diffidence in asking assistance, he gets out of his difficulty by adopting what has been well called the "cuttle-fish dodge," and bewilders his readers by squirting in their faces a cloud of inky verbiage. Our author has trusted too implicitly to *him*.

Our readers must now have a notion of what seems to us, at least, the character of this book. The style is clear and good, and many of the incidental remarks and comments are happy. The early chapters, referring as they do mainly to subjects little treated by the modern popular science writers, are, as a rule, very much superior to the later ones, and in many places may be not merely passed as satisfactory, but even highly commended. For instance, the discovery of the law of compression of gases such as air, at constant temperatures, is, for once in a popular book, actually assigned to Boyle himself, though even here the pernicious influence

of the popular quasi-scientific writers has asserted itself in the unwarrantable introduction of the perpetual Mariotte. There are some very sensible remarks on Werner and Hutton, and we are glad to see that William Smith's geological labours are heartily recognised. But what shall we say of passages like the following?—

"We owe to him [Scheele] the discovery of chlorine; and of manganese, barytes, fluor spar, and many *other earths* whose names I cannot expect you to know."

Or this—

"The determination of nitrogen completes the history of the discovery of those gases of which *fire*, air, and water are composed; but you will have noticed that we have not yet arrived at the new explanation of chemical changes which was to take the place of 'phlogiston.' The fact is that Black, Bergmann, Cavendish, Scheele, and Priestley, were all so cramped by the old theory, that though they discovered the facts they could not make the right use of them. *The man who did this, and who laid the foundation of modern chemistry, was the celebrated French chemist, Lavoisier.*"

We have taken the liberty of italicising two words in each of these extracts.

Again, Fresnel "found that [Dr. Young] also had the same idea [interference], and this led to a number of experiments, by which they proved at last that the waves in a natural ray of light do not move *merely* up and down like waves in a pond, but also from side to side; and that when light is polarised this complex vibration is destroyed and the waves of each separate ray move only in one direction." The italics here are in the text!

From the later chapters we make but two extracts; these will, we fancy, be thought quite sufficient:—

"If the water were free [in Joule's paddle experiment for the determination of the dynamical equivalent of heat] it would pass on into the air and we should lose sight of it; but the water is shut in and the force cannot escape, so now it employs itself in dashing to and fro all the little particles which make up the water, and producing the effect we call heat; and as it produces exactly 1° Fahr. of heat by the time the 1 lb. weight has fallen 772 feet, we say that *772 foot-pounds of force equals 1° Fahr. of heat.* You might easily prove to yourself in a somewhat unpleasant way that the force is there; for if you were to go on turning the paddle violently for many hours, and there were no means for the heat to escape, the motion of the particles would be so violent against the sides of the boiler that it would burst."

Here again the italics are not ours; but the whole passage shows clearly that the author has read this part of the subject in works in which scientific terms are used loosely or even inaccurately; while difficulties have been avoided, not explained. For when "we say that 772 foot-pounds of force equals 1° Fahr. of heat" we commit so many and such astounding blunders that it would be altogether impossible to enumerate them all in such a notice as this.

Let us, however, do what we can in a few lines to point out a few of them. Suppose them put as questions by a teacher employing this work as a text-book.

1. What is a foot-pound of force?

To this question the late William Hopkins, perhaps the ablest instructor whom Cambridge ever produced, would have at once replied, "The old story; the height of King's College Chapel in acres!" When *will* our elementary writers at last recognise that a force may b

represented by so many pounds' weight, but *cannot possibly* be represented by so many pounds' weight overcome through so many feet? <sup>1</sup>

2. What is 1° Fahr. of heat?

One might just as correctly ask, "What is 1 oz. troy of time?" We have heard of degrees of temperature, and of quantities of heat, but we are totally unable to conceive what could correctly be designated by 1° Fahr. of heat, though it is clear that it is here used for "the quantity of heat which can raise the temperature of a pound of water by 1° F." But let us proceed to our final extract:—

"If you have understood this explanation, you will have some idea of the theory that heat is altered motion; but to complete the history we require not only to turn work into heat, but also to turn heat into work. This had already been done many years before by a French engineer, M. Carnot, though he did not understand its real significance, but it has now been most beautifully proved by a long series of experiments made by M. Hirn, of Colmar, in Alsace. What M. Hirn practically did was to find out how much heat can be obtained from a ton of coals, and then to find out how much work was performed in an engine by that amount of heat. This was by no means a simple task, for much heat is lost in various ways in passing through the engine; and even when he thought he had allowed for all this, it was found that some of the steam had turned back into water on its way, and thus used up some of the heat. At last, however, when all was carefully measured and calculated, he found that *for every pound of water heated 1° F., enough work had been done to raise a weight of 1 lb. to a height of 772 feet.* This, you will notice, was exactly the converse of Joule's experiment, and proved that exactly as much motion is produced by means of confined heat as there is heat produced by means of checked motion."

This is certainly very novel information. We have hitherto been accustomed to think that "What M. Hirn practically did was [not] to find out how much heat can be obtained from a ton of coals," but to find how much of that heat disappeared by having been actually converted into useful work in an engine.

But enough has been said to show the necessity for the correction of those "grave errors" alluded to in the second extract made above from the Preface.

As to the chronological table with which the volume concludes, and which is carried on to 1874, we would only remark that it would not have been unduly extended if a little space could have been found for even a bare mention of a few such names as Andrews, Forbes, Graham, Stokes, Thomson, and Clerk-Maxwell in our own islands, and a few more like Helmholtz, Foucault, Plücker, and Weber abroad. Surely such names should have been caught at the very first cast of a net whose meshes were found small enough to seize Drebber, Franklin, Celsius, Reaumur, Fahrenheit, and Humboldt!

#### HASSALL ON FOOD

*Food: its Adulterations and the Methods for their Detection.* By Arthur Hill Hassall, M.D. (London: Longmans, 1876.)

THIS book is practically a new edition of the author's former work on "Adulterations Detected in Food and Medicine;" the main difference being, at least so far

<sup>1</sup> We can hardly blame our author for this blunder, great as it is, when we find substantially the same in a recent work by so learned and careful a writer as Guthrie. In § 130 of his "Magnetism and Electricity" we are surprised to read that a body falling to the ground "will, just before reaching the ground, have acquired a MOMENTUM, which is equal to the WORK done in lifting it." The small capitals are ours—and they but faintly express the agony with which we peruse such a passage.

as the plan of the work is concerned, that in the present volume it has been thought judicious to exclude the articles on drugs, which occupied indeed a very subordinate position in the older one. We cannot but commend the discretion thus shown: unsatisfactory as are many of the processes employed by the public analyst, viewed as methods of precision, none are more so than those applicable to the analysis of pharmaceutical preparations. It is probably to this fact that we must attribute the immunity from the raids of the inspectors which the apothecaries have on the whole enjoyed; otherwise we must assume that a higher standard of commercial integrity prevails with our druggist than with our grocer or milkman, a supposition to which, possibly, the milkman and the grocer would demur.

Despite the omission referred to, the present volume is nearly double the size of the former one; the increase in bulk may indeed be taken as commensurate with the increase in importance which the subject has of late years assumed. The additional matter comprises articles on the Function, Quantity and Preservation of Food, and on the influence of the utensils employed in its Preparation and Storage: on Unwholesome and Diseased Meat; and on Water and its Impurities. A considerable quantity of fresh analytical work has been incorporated, and the author has been at the pains to test the greater number of the various methods commonly employed in the detection of adulteration, and in the determination of its amount. In one or two instances, as for example, in the determination of milk-residues, he is scarcely just to his contemporaries. The chemistry on the whole is fairly good; thanks to the co-operation of Mr. Otto Hehner, whose assistance Dr. Hassall freely acknowledges. But we are inclined, in common, we are sure, with those who have attempted to make absolute alcohol, to doubt that this liquid is best prepared by digesting spirit of 90 per cent. with well-dried chloride of calcium (p. 795). It is well known that calcium chloride unites with alcohol to form a compound in which the alcohol plays the part of water of crystallisation, and which is only decomposed with difficulty. Much is said respecting the composition of "fusel oil" and "potato spirit," although neither the author nor his *collaborateur* thinks it necessary to indicate anything with respect to the existence of isomerism in the alcohols mentioned. On p. 676 we see Payen and Chevallier's analysis of hops given: on the following page precisely the same analysis is repeated as indicating the composition of crude lupulin, which we are further informed, amounts in good samples to about one-sixth of the weight of the hops.

The public generally, and Messrs. Allsopp and Co. in particular, will be alarmed to learn that the water used in the brewery of that eminent firm contains 7.65 grains of sulphate of zinc to the gallon! In the face of such a statement it is hardly sufficiently reassuring to be told that "the water is remarkable for its complete freedom from organic matter" (p. 681). The memory of the strychnine "scare" in connection with the national beverage has scarcely died out: we trust that Dr. Hassall will be the first to allay our anxiety as to the existence of white vitriol in our "pale" and "Burton."

A considerable section of the book is devoted to the

subject of wine and its adulterations ; for much on this matter the author is indebted to the valuable work of Thudichum and Dupré. The question of "plastering" meets with due consideration. This time-honoured operation (it appears to have been practised by the Greeks and Romans) consists in adding finely-powdered plaster of Paris, or sulphate of lime, to the must in the proportion of about 40 lbs. of the plaster to a butt of must, with the view of separating out the vegetable acids in the grape-juice, and thereby, in the opinion of our author, substituting "for the healthful and beneficial tartrates, a bitter and aperient salt"—sulphate of potash. The wines more particularly subjected to this process are sherry, port, and certain French and Greek wines. It appeared to Dr. Hassall "that any process whereby the sulphuric acid can be removed and the original tartaric acid restored, and in the form in which it previously existed, namely, as a tartrate of potash, is highly desirable, and would improve greatly the flavour and quality of all wines which had been plastered, and increase very considerably their money value." Accordingly he has devised such a process in conjunction with Mr. Hehner, and has obtained for it provisional protection with the intent to take out a patent : it consists in treating the wine with tartrate of barium, with occasional shaking, for three or four days. "At the end of this time all but the normal quantity of the sulphuric acid of the wine is precipitated as sulphate of barium, while the tartaric acid is restored in exactly the same amount in which it was originally present ; this, uniting with the now liberated potash, gives rise once more to the formation of tartrate of potash, the most characteristic saline constituent of all genuine wines." This "deplastering" process may have all the virtues which its authors claim for it, but since barium salts are in the highest degree poisonous, we, at least, should prefer that our sherry retained all its aperient qualities unimpaired, rather than it should be manipulated with compounds of that element.

In reading this book the question has more than once occurred to us : What must be its effect on the non-professional mind—or indeed on the mind of anybody who, with the view of extending his notions of the principles of alimentation, takes it up for an hour or so in the evening? He will find that the water he drinks may be swarming with *Scenedesmus quadricauda*, *Navicula spherophora*, and numerous other "living organisms," whose names and appearance are equally distracting ; he is told that the tea which he adds to it may be largely composed of the leaves of *Chloranthus inconspicuus*, or of "lie-tea," a vile compound of tea-dust, foreign leaves, sand, and oxide of iron, the whole occasionally coated with "Prussian blue, turmeric, China clay, or other white mineral powder." The sugar with which he sweetens the infusion may be infested with the *Acarus sacchari*, which, he is informed, belongs "to the same genus as the *Acarus scabiei*, or itch-insect, than which, however, it is larger, and possessed of an organisation still more formidable." The milk which he adds to it may be "blue" not merely as he is content to believe through the machinations of the vendor, but from the presence of what the author in one place, following Fuchs, calls *Vibrio cyanogenus*, and in another place

*Oidium lactis*, or *Penicillium*. The question whether fungus or vibrio pales into insignificance before the fact that milk of this kind gives rise to "gastric irritation" or "severe febrile gastritis." His bread may contain *Penicillium glaucum*, or *Oidium orantiacum* ; or it may be made from flour harbouring *Uredo segetum*, or *Puccinia graminis*, or it may contain the poisonous dandel, the symptoms produced by which, as he learns from a quotation from Pereira, "are two-fold : those indicating gastro-intestinal irritation—such as vomiting and colic ; and those which arise from disorder of the cerebro-spinal system—such as headache, giddiness, languor, ringing in the ears, confusion of sight, dilated pupil, delirium, heaviness, somnolency, trembling, convulsions, and paralysis." After this, such commonplace sophistications as alum, bone-earth, and mashed potatoes, can have no terrors for him. His butter, as indeed we learnt from a recent case referred to in NATURE (vol. xiii. p. 242), may be made from other products of the cow than milk, and even his modest rasher may have death lurking in its folds in the form of *Cysticercus cellulosus* or *Trichina spiralis*, concerning which he is told that the former finding its way into the intestines, "there fixes itself by its little hooks, and quickly grows, joint after joint, into a tape-worm ;" and that the latter is the cause of "frightful disorder, killing about 50 per cent. of its victims in terrible agony." No wonder that some of us make a 'poor' breakfast ; the marvel is that so many of us survive the dreadful meal. We can only account for the fact that numbers are known to exist and even to thrive on such food on the supposition that, like physostigma and atropia, the horrible things we eat act antagonistically and mutually obviate evil consequences : a supposition which we commend to the notice of Dr. Fraser ; or it may be, and with equal probability, that the 'living organisms' devour each other, like the Kilkenny cats, and leave no trace, not even their tails, behind them. We refrain from recounting the horrors which may await us at luncheon and at dinner. Even Dr. Hassall is merciful ; it was with a profound sense of relief and satisfaction that, turning to the end of the book, we discovered, on the strength of numerous certificates published by him, that some articles of food are, as a certain noble lady should have been, actually above suspicion, although, unfortunately, many of these articles rejoice in fanciful names which hardly serve to recommend them to prudent matter-of-fact housewives, doubtless long ago inured to the all-prevalent adulteration. Dr. Hassall no doubt considers himself a scientific man ; but there are cavillers who deem it an act of questionable taste that he should have appended to his book a series of advertisements extending over fifty pages, the greater number of which contain reports issued from his "Analytical Sanitary Institution." We are inclined, however, to look on the matter from what is doubtless Dr. Hassall's point of view, that having made existence scarcely tolerable to some of us by the revelations which it was his duty to make, it was simply an act of kindness to indicate how we might eat our daily bread (to ask for which would otherwise be a mockery) in peace and comfort, even though it should consist of Infants' Food and Angostura Bitters. T.

LETTERS TO THE EDITOR

[The Editor does not hold himself responsible for opinions expressed by his correspondents. Neither can he undertake to return, or to correspond with the writers of, rejected manuscripts. No notice is taken of anonymous communications.]

Prof. Tyndall on Germs

I AM very glad I wrote to you putting my questions to Prof. Tyndall. It has drawn from him a letter, full of all sorts of hints and prophecies and information and pleasant observations on details with which I had not thought of troubling him; and there is even a delicate bit of flattery for poor me, of whom the Professor knows nothing. It is really quite a gem of a letter, a beautiful example of that "tour piquant" referred to by M. Pasteur, which the Professor gives to everything he touches, and which we at home know how to value as well as any Frenchman. There is only one fault in it, and that is that the Professor, in the exuberance of his kindness, has unfortunately forgotten to answer my modest questions. But why does he liken himself to Horatius, and talk of enemies yet to be dealt with? Horatius did not sing his pœan before going into battle. And how can Prof. Tyndall have any enemies? I thought that scientific investigators were all brothers. I regarded Prof. Tyndall as a brother keeping a bright look out due north, and Dr. Bastian as a brother with his eye firmly set towards the south, while Dr. Sanderson seemed to me to be a remarkably silent brother gazing somewhere about sou'-sou'-west-and-by-south-a-quarter-south.

But to be serious. Briefly put, the situation seems to be this. Prof. Tyndall has propounded a theory—no mere speculation raising a trifling controversy to be settled privately with Dr. Sanderson or Dr. anybody else, but a momentous theory on which, as he says, "the lives of men depend," and the truth of which it concerns all men to sift. It is not addressed to any scientific coterie, but widely published for the benefit of the outside world, the like of me among the rest.

The theory as propounded stands or falls with the assertion that when, with due precautions, an organic fluid is boiled for a few minutes in a flask, which is then hermetically sealed, it is impossible to obtain bacterial putrefaction.

What Prof. Tyndall declares to be impossible, that Dr. Sanderson declares that he has done.

If Dr. Sanderson is right there is an end of the theory, and the lives of men must rest on some other basis.

If Prof. Tyndall is right, Dr. Sanderson (not to put too fine a point upon it) has blundered in his very careful experiments.

Anxious to know where I should look for the truth, I ventured to ask Prof. Tyndall which alternative he adopted. Instead of helping me out of my difficulty he has responded with a flourish of rhetoric about not crossing swords with Dr. Sanderson. It is plainly from no want of courtesy that Prof. Tyndall has declined to satisfy my curiosity. He can't help being courteous; and to the class to which I belong—simple students who hang upon the lips of Professors for their scientific sustenance—he invariably overflows with courtesy.

I am sure he would have answered me if he could.

Even now I should be grateful (and so I believe would many more of us outsiders) if on second thoughts he should resolve to put his rhetorical sword into the unadorned scabbard of common sense, and kindly try to answer three plain questions:—

1. Does he accept Dr. Sanderson's experiments, and give up his theory?
2. Does he reject Dr. Sanderson's experiments as untrustworthy, and why?
3. Can he suggest any third view which will reconcile his theory with established facts?

Unless Prof. Tyndall feels constrained by his regard for human life to give me a reply, I will not press him to do so, if it would be in the least embarrassing. Only, if there is to be an answer, I hope this time it will be direct to the point. Perhaps, after all, it is not absolutely necessary. Silence is sometimes more eloquent than speech.

Feb. 19

INQUIRER

[This letter was unavoidably delayed last week.—ED.]

The Mechanical Action of Light

In his recent lecture at the Royal Institution upon the Mechanical Action of Light, Mr. Crookes stated that his investi-

gations into this subject had enabled him to measure the repulsive force of light, and he calculated that the sun's light exercised a repulsive force upon the surface of the earth of 3,000 millions of tons, a force sufficient, he said, to drive the earth into space, were it not for the attraction of gravitation.

Let us look for a moment at this conclusion of Mr. Crookes. Granting that gravitation and a (hypothetical) tangential force cause the planets to revolve round the sun, the continuous action of a repulsive force emanating from the sun and impinging upon the surfaces of the planets, would cause them to spin round upon their axes just as a ball spins round when it is propelled along a resisting surface. This rotation would be in the same direction—right to left—as the revolution of the planetary bodies in their orbits.

But such an explanation of the rotation of the planets upon their axes will not, unfortunately, hold good, as upon this hypothesis their axes ought to be perpendicular to their orbits, whereas, with the exception of Jupiter, the equators of the planets are largely inclined to their orbits. If, then, the rotatory movement of the earth is not caused by the friction of a repulsive force emanating from the sun, it is clear that the effect of the 3,000 millions of tons which Mr. Crookes says continuously press against that half of the earth's surface which is exposed to the sun's rays, would be to retard not only the earth's diurnal rotation, but also its annual movement round the sun. Now there is no evidence whatever of retardation from any such cause, either as regards the earth or the planets with whose movements we are most familiar.

I do not in the least question that under certain circumstances light may repel solid, liquid, or gaseous bodies, and, indeed, if Mr. Crookes' general conclusions be confirmed, it may be found that the rapid extension of the tails of comets as they approach the sun may be due to the repulsive action of the sun's rays. As this force would be inversely as the square of the distance, the effect of the sun's light, acting in a straight line upon the highly attenuated matter of which a comet's tail is composed, would repel it with enormous velocity in a direction opposite to the sun as the comet approached its perihelion.

Manchester, February

GEORGE HICKS

Metachromism and Allied Changes

THE laws of metachromism, enunciated by Mr. W. Ackroyd (in his recent paper read before the Chemical Society, NATURE, vol. xiii. p. 298), have an apparent parallel in the order of colours shown by various series of combinations; there being but few exceptions to the following rule, in its application to binary compounds. Increase of the electro-negative element produces a colour change towards the red end of the spectrum, and vice versa. Thus the sub-oxides are generally blue, and the per-oxides yellow; the sub-sulphides white or yellow; and the per-sulphides red.

The examples which lead to this generalization are as follows:—

- K<sub>2</sub>O blue grey, K<sub>2</sub>O white, K<sub>2</sub>O<sub>4</sub> chrome yellow.
- K<sub>2</sub>S reddish yellow, K<sub>2</sub>S<sub>2</sub> orange, K<sub>2</sub>S<sub>3</sub> liver brown.
- K<sub>2</sub>Cl blue, KCl white, Na and Rb chlorides the same.
- Na<sub>2</sub>O blue, Na<sub>2</sub>O yellowish white, Na<sub>2</sub>O<sub>2</sub> orange.
- Cs<sub>2</sub>O blue, Cs<sub>2</sub>O white.
- (H<sub>2</sub>N)<sub>2</sub>S<sub>2</sub> yellow, (H<sub>2</sub>N)<sub>2</sub>S<sub>3</sub> orange yellow.
- CeO white, Ce<sub>2</sub>O<sub>3</sub> fawn red.
- U<sub>3</sub>O<sub>4</sub> green, U<sub>2</sub>O<sub>3</sub> brick red.
- FeCl<sub>2</sub> white, FeCl<sub>3</sub> brown.
- Cr<sub>2</sub>O<sub>3</sub> green, CrO<sub>2</sub> yellow green, CrO<sub>3</sub> red.
- MnO olive, Mn<sub>2</sub>O<sub>4</sub> red brown, Mn<sub>2</sub>O<sub>3</sub> black.
- MnS dark green, MnS<sub>2</sub> brown red.
- SnO olive brown, SnO<sub>2</sub> yellow.
- SnS blue grey, SnS<sub>2</sub> yellow.
- MoO purple brown, MoO<sub>3</sub> dark brown.
- MoS<sub>2</sub> lead grey, MoS<sub>3</sub> dark brown.
- MoCl<sub>2</sub> deep blue, MoCl<sub>4</sub> dark red.
- W<sub>2</sub>O<sub>5</sub> blue, WO<sub>3</sub> yellow.
- Sb<sub>2</sub>O<sub>3</sub> grey white, Sb<sub>2</sub>O<sub>5</sub> pale yellow.
- Sb<sub>2</sub>S<sub>3</sub> blue black, Sb<sub>2</sub>S<sub>5</sub> orange yellow.
- Bi<sub>2</sub>O<sub>3</sub> yellow, Bi<sub>2</sub>O<sub>5</sub> brown.
- Cu<sub>2</sub>Cl<sub>2</sub> white, CuCl<sub>2</sub> liver colour.
- PbO yellow, Pb<sub>2</sub>O<sub>4</sub> red, PbO<sub>2</sub> brown.
- PbS lead grey, PbS<sub>2</sub> red.
- Tl<sub>2</sub>O yellow, Tl<sub>2</sub>O<sub>3</sub> brown.
- HgI green, HgI<sub>2</sub> yellow or red.
- Au<sub>2</sub>O dark green, Au<sub>2</sub>O<sub>3</sub> brown.
- PtCl<sub>2</sub> olive, PtCl<sub>4</sub> orange.
- OsCl<sub>2</sub> green, OsCl<sub>4</sub> red.

With fuller information on the rare and unstable compounds, than is to be found in ordinary text books (such as "Miller's Elements"), no doubt numerous other instances might be noticed; these, however, will suffice to exemplify the general law.

With regard to black compounds, I have not included them in the above list, as they only complicate it unnecessarily; the ordinary term *black* being used to describe a very minute amount of any possible colour. It is only when the predominating colour is observed (as blue-olive-red-black, &c.), that the description is of any value. "Brown" is likewise ill-defined in its spectral position, as various tints called brown generally include a small quantity of any colour except blue. Black and brown compounds are therefore inconclusive without a spectral examination of the colour in each case.

The real anomalies to the above law are the following compounds. CrCl<sub>3</sub>, white, Cr<sub>2</sub>Cl<sub>3</sub>, violet; MnCl<sub>2</sub>, pale pink, MnCl<sub>3</sub>, green brown; As<sub>2</sub>S<sub>2</sub>, red, As<sub>2</sub>S<sub>3</sub>, yellow; HgCl<sub>2</sub> yellow white, HgCl<sub>4</sub>, white; AuI, yellow, AuI<sub>2</sub>, green. In these five pairs the law is apparently reversed, but they cannot be said to nullify an induction from thirty-five pairs, as enumerated above. A conformity of six cases in seven to a rule is sufficient to establish it as a law, from which the modifying causes have not yet been eliminated.

One or two other cases might at first seem to be also exceptions; but as they are really *salts*, in which the electro-positive of the base is the same element as that of the acid, they are not necessarily to be compared with binary compounds.

In the order of the colours, it will be observed that, in numerous cases, white occurs between blue and yellow compounds; and there is only one instance of a violet compound with more of the electro-negative element than its white connection. As white light comes (in the natural arrangement) between blue and yellow, this order is more in accordance with the spectrum than is the order of metachromism announced by Mr. Ackroyd, in which white occurs before violet.

It may be worth notice that the electro-negative elements (whose increase reddens the compounds) are, on the whole, rather more red and yellow than the electro-positive, many of which are bluish, and even dark blue, as Na.

This order of colours in successive compounds of a series (which might be called *taxichromism*) was observed by the writer some few years ago, in connection with the spectral order in metachromism; the latter, however, was only traced through a dozen or so, of the oxides, without pursuing the subject farther.

Bromley, Kent

W. M. FLINDERS PETRIE

#### Seasonal Order of Colour in Flowers

I THINK it may be useful to mention, in reference to several letters on this subject in NATURE, that light appears to have no direct influence on the tints of flowers. I quote the following from Sachs's Textbook, Engl. transl., p. 675:—

"As long as sufficient quantities of assimilated material have been previously accumulated, or are produced by green leaves exposed to the light, flowers are developed even in continuous deep darkness which are of normal size, form, and colour, with perfect pollen and fertile ovules, ripening their fruits and producing seeds capable of germination."

W. T. THISELTON DYER

#### Rainbow Projected on Blue Sky

AN instance of this phenomenon, which is referred to as rare in NATURE (vol. vii. p. 68), occurred to-day, Feb. 22, 4.30 P.M. The sky was almost quite clear and a light shower of rain falling, caused one to look upwards for the clouds whence it proceeded, but the air was uniformly clear near the zenith, though bordering the horizon all round there were some detached cumuli, and a few thin filmy modifications higher in N.E. There were no visible signs of the origin of the falling drops. On turning round to east, a solar bow was seen, for the most part on a background of azure. It was a *complete* bow and moderately intense. Near the vertex it rested on thin clouds, as did the extremities on the horizon, but they had no sensible effect on the phenomenon, for it was observed that as they receded from the upper portion, the bow remained intact and equally bright in all its parts. The arms spanned areas of blue sky. It was very transient, like the shower, and fading rapidly, was gone within 10 sec. after it was first observed. At 4.45 P.M., the left side of an incomplete bow was seen in N.E. on clear sky, except at the lower extremity:

no rain accompanied it. It was as evanescent as the first. The weather was very unsettled and showery with low barometer. Thermometer 50°, with brisk wind from W.S.W.—3½ inches of rain had fallen during the previous 9 days.

WILLIAM F. DENNING

Ashleydown, Bristol, Feb. 22

#### OUR ASTRONOMICAL COLUMN

OLBERS' COMET OF 1815.—The comet discovered by Olbers, at Bremen, on March 6, 1815, and with which his name has been usually associated, belongs to the group, the members of which revolve in periods a few years less than the period of the planet Uranus. The deviation from parabolic motion was remarked independently a few months after the discovery by Bessel, Gauss, Olbers, Nicolai, and Triesnecker. Bessel calculated elliptic elements so early as the middle of May, and was followed by Gauss in June, and the former subsequently investigated, as completely as was practicable at the time, the elements resulting from the whole course of observation and the effect of perturbation in the actual revolution.

When first detected, the comet is said to have been barely visible in a good achromatic, and according to the *Zeitschrift für Astronomie*, was not discernible without telescopic aid at any time; it is, however, upon record that in Russia it was seen with the naked eye. The last observation was made by Gauss at Göttingen, on August 25. At discovery on March 6, at 10 P.M., it was in R.A. 49°3 and N.P.D. 61°3, distant from the sun 1'47 and from the earth 1'30, and at Gauss's final observation it was in R.A. 217°1, N.P.D. 84°5, distant from the sun 2'10, and from the earth 2'36. Representing the intensity of light at discovery (calculated according to the usual expression

$\frac{I}{r^2 \Delta^2}$ ) by *unity*, a maximum of 1'4 was attained on May 3, and it had diminished on August 25 to 0'16, or one-sixth of that at discovery.

Bessel's determination of the elements of this comet and of the perturbations to the next return will be found in *Abhandl. der Berl. Acad. Mathem. Cl.* 1812-15. His definitive figures are as follow:—

Perihelion Passage, 1815, April 25	99867 M.T. at Paris.
Longitude of the perihelion	... .. 149° 1' 56"
" " ascending node	... .. 83° 28' 34"
Inclination to ecliptic	... .. 44° 29' 55"
Excentricity	... .. 0'9312197
Semi-axis major	... .. 17'63383

These elements apply to the date of perihelion passage; the longitudes from mean equinox of 1815.

To the above value of the semi-axis corresponds a period of revolution of 74'049 years. The distance in perihelion is 1'213 (the earth's mean distance from the sun being taken as *unity*), and the aphelion distance 34'055; the minor semi-axis is found to be 6'427. The ascending node is situate near the orbit of the planet Mars, and if the actual form of orbit is due to planetary attraction, it is probably to be ascribed to a near approach of the comet to Mars at some distant period. At the other node the radius-vector is 3'81 in the region of the minor planets. The comet, it will be seen, recedes beyond the orbit of Neptune, but near the aphelion it has a depression of nearly 40° below the plane of the ecliptic.

According to Bessel, the mean motion at the instant of perihelion passage in 1815 corresponded to a period of revolution of 27046'9 days, and he found that this would be diminished 824'5 days by the united action of the planets Jupiter, Saturn, and Uranus, thus obtaining 26222'4 days for the actual revolution, and fixing the next arrival at perihelion to 1887, February 9'4. Beyond doubt, however, this date may now admit of a closer determination, and very probably we may soon hear of a further investigation being undertaken. The original observations made at the Observatory of Paris, and those at one or two other observatories in greater or less detail, are



in our possession, and will admit of more accurate reduction than has yet been effected; while a more complete computation of the perturbations with the improved values for the masses of the disturbing planets must tend to diminish the uncertainty that at present exists with regard to the possible error of Bessel's determination of the date of next passage through perihelion. If this should fall about 1887, February 9, as he computed, we might expect that the comet would be detected in September previous in the constellation Monoceros; its intensity of light would gradually increase until its nearest approach to the earth (0.5) at the end of the year, when it might be a conspicuous naked eye object in Ursa Major, within 20° N.P.D., and possibly it would be observable till the following May. Subjoined are figures which will enable any reader who is interested in the matter to trace the comet's course more precisely, upon the above supposition as to perihelion passage.

	R.A.	N.P.D.	Distance from Earth.
1886, Oct. 2 ...	97°0	83°6	1.90
" Nov. 1 ...	106°8	78°2	1.25
" Dec. 1 ...	117°7	61°0	0.72
" " 21 ...	131°1	33°3	0.52
" " 31 ...	151°9	17°3	0.51
1887, Jan. 10 ...	216°8	10°5	0.55
" " 30 ...	272°3	23°2	0.69
" March 1 ...	278°8	34°2	0.88
" April 10 ...	265°4	41°4	0.95
" May 10 ...	245°5	53°0	1.01

MINOR PLANET, No. 160.—A telegram to the Astronomer Royal, through the Smithsonian Institution, notifies the discovery of another small planet on February 25, in R.A. 10h. 16m. N.P.D. 75° 28'; eleventh magnitude.

THE BINARY STAR  $\alpha$  LEONIS.—Dr. Doberck, of Col. Cooper's Observatory, Markree Castle, Sligo, publishes in *Ast. Nach.*, No. 2,078, provisional elements of this interesting star, viz., peri-astron passage, 1842.77; node, 151° 34'; node to peri-astron on the orbit, 122° 54'; inclination, 65° 22'; excentricity, 0.5028; period of revolution, 107.62 years.

SCIENCE AND ART IN IRELAND

IN our number for February 17, we reprinted from the *Times* an article on the proposed action of the Government in connection with the Scientific Institutions in Dublin. That article contained the substance of Lord Sandon's letter which was forwarded both to his Grace the President of the Royal Dublin Society and to the President of the Royal Irish Academy. This letter was laid before the Irish Academy at their meeting of the 14th Feb., and was by them referred to the Council of the Academy. This latter body having in several meetings fully considered the whole subject, submitted to the Academy on Monday evening, the 28th Feb., the following Resolutions:—

"1. That the Royal Irish Academy is desirous of co-operating with Her Majesty's Government in the measures necessary for the establishment of a National Science and Art Museum in Dublin, provided that the independence and usefulness of the Academy be not injuriously affected by such measures.

"2. That, while we consent to the transfer of our Museum to the Government, we think that its arrangement, as well as the purchase of additions, should be done through the Academy.

"3. That, in thus assenting to the transfer of its Museum to the Government, the Academy also thinks that adequate provision should be made for the continued acquisition of Irish Antiquities, which may hereafter be discovered or offered for sale; and that the collection of the Academy, together with such other Irish antiquities as shall be added to it, should be for ever kept apart from Miscellaneous Art collections in the possession of the Government, and be permanently maintained as a Mu-

seum of our National Antiquities, no portion of its contents being ever removed from the City of Dublin.

"4. That, considering the position which the Academy has long held, and will continue to hold, as the first Scientific, Literary, and Antiquarian Society of the country, the proportional representation proposed to be given to it on the Board of Visitors (sect. 12 of Lord Sandon's letter), is altogether inadequate; and the Academy further think that no paid official of the Science and Art Department should [be eligible to act as a representative on the Board.

"5. That, as the Academy is making a substantial concession in respect to its Museum, there should be provided in the yearly estimates, as laid before Parliament, instead of the several sums now annually voted, a sum of 2,000*l.*, to enable the Academy to discharge more completely its functions as a Scientific, Literary, and Antiquarian body, by making grants in aid of original research, by publishing the results of such research, by maintaining a library specially adapted to assist learned investigation, and by editing and printing ancient Irish Texts.

"6. That the Academy should be accountable, as at present, to her Majesty's Treasury, through the Irish Government, for the sum to be thus voted by Parliament, and should not be subject, in the conduct of its affairs, or the expenditure of its grants, to any control on the part of the Science, and Art Department, or any of its officers."

After some discussion the Academy adjourned to the 6th of March, when it is probable that the resolutions of the Council may be adopted by the Academy, and a deputation appointed to confer with her Majesty's Government on the subject.

The Council of the Royal Dublin Society have also, we understand, drawn up a report with resolutions, to be submitted to a special meeting of the Society which is to be held to-morrow.

We hope in our next number to be able to report the resolutions come to by both bodies, and in the meanwhile refrain from making any comments on the subject.

THE LOAN EXHIBITION OF SCIENTIFIC APPARATUS

A MEETING of the General Committee for this approaching Exhibition was held on Thursday last at the Science Schools, South Kensington Museum. The chair was taken by the Lord-President of the Council, the Duke of Richmond and Gordon, the Vice-President, Lord Sandon, M.P., sitting at his side. Many well-known representatives of science were present.

The Lord-President spoke as follows:—

"It gives me very great pleasure to meet you at the expiration of some twelve months since we first assembled to set in motion a plan for holding a scientific exhibition, and I am happy to be able to congratulate you upon the success which has attended your efforts. The exhibition promises to be the most brilliant one of the kind that has ever taken place in this country. Indeed, I doubt very much whether there has ever been any exhibition in England at all approaching in importance or merit the one which is to be held within the next few months; and I cannot refrain from tendering the thanks of her Majesty's Government to those gentlemen who by their exertions in bringing about this exhibition have contributed so much to the success which we hope will follow. We appreciate the efforts of those gentlemen the more because we know that, engaged as they are in various scientific pursuits, the time which they have devoted to this matter must have caused them considerable inconvenience, and only their love of science could have induced them to render the services which they have done for the carrying out of the object. It is also gratifying to find that this exhibition has met with such a large amount of favour in all parts of the Continent, and more especially

in Germany, where the Crown Princess seems to have evinced in this case her great interest in the country from which she came, and I believe it is mainly owing to her exertions and those of the Royal Family in that country that so far as Germany is concerned we are to be so ably assisted. It may not be uninteresting to the meeting that I should describe in a very few words what has been done in the present state of matters with regard to the exhibition. At meetings of the various sub-committees (appointed at the General Committee meeting in June last) during the months of February and November, reports were made of the results of visits to foreign countries by officers of the department. The sub-committees made various suggestions to the department as to objects to be procured. These have been acted upon, and many most interesting objects obtained. The committee also advised that gentlemen should be employed to visit various towns and leading manufacturers. This has been carried out with the best results by Prof. Shelley, Mr. Akroyd, Dr. Martin, Prof. Morris, Mr. Judd, and Mr. Norman Lockyer. The Foreign Secretary having through her Majesty's Ministers abroad urged the importance of co-operation on the part of foreign Governments, our appeal has been most cordially responded to. The Governments of Belgium, France, Germany, Holland, Italy, and Switzerland, have appointed committees to act in union with the general committee; and the Government of the United States has placed itself in communication with the various institutions and Government departments. Russia intends to contribute an interesting collection from the Pædagogical Museum; and the Russian Academy have formed a committee under Prof. Struve. The Austrian Minister of Instruction has taken the matter in hand for that country, and one of his officers, Mr. Fidler, is in correspondence with the Science and Art Department. I mention this to show you the intense interest that foreign countries have taken in the matter, and that to their assistance and co-operation we feel very much indebted. The appeals made to Government departments, scientific institutions, and men of science at home have been very well received. The Admiralty contributes a complete scientific outfit of a surveying ship, dredging apparatus, &c. The Post Office contributes as complete a historical collection of telegraphic apparatus as exists; much, however, unfortunately, has been broken up for want of a physical museum in which to deposit it. They also propose to communicate Greenwich time, and fire a time gun, to illustrate their method of communicating time throughout the country. The Trinity House, Ordnance Survey, Royal Observatory, and Geological Survey have also promised to contribute. From the War Office and India Office no replies have been received, but we understand they are taking steps to contribute several objects of interest, especially from the Royal Arsenal at Woolwich. The Royal Society contributes a most important collection, including some of Newton's apparatus. The Royal Institution contributes historical apparatus used by Faraday and others, and some of Dr. Tyndall's instruments. The Astronomical Society contributes Baily's apparatus for the Cavendish experiments, and Sir W. Herschel's telescope. The Geographical Society contributes maps and instruments. The Microscopical Society has promised to organise a collection of microscopes, which Mr. Sorby has especially in charge; the Horological Institute a collection of clock escapements, &c., and the Royal College of Surgeons has promised an interesting collection. King's College has promised to contribute the collection of the late Sir C. Wheatstone. At Owens College, Manchester, Professors Roscoe, Stewart, Schorlemmer, and Reynolds have promised to contribute valuable apparatus, as have also Professors Tait and Crum Brown at Edinburgh, and Sir W. Thomson at Glasgow. Trinity College, Dublin, has also promised to contribute. Contributions have been promised by

the following noblemen and gentlemen, viz.:—Dr. Jone Prof. Andrews, Mr. Gore, Lord Rosse, Mr. De la Rue Lord Cork, Dr. Frankland, Prof. Guthrie, Mr. Norman Lockyer, Dr. Ball, Prof. O'Reilly, Prof. Barrett, and Prof. Stokes. Among instrument makers who will contribute specimens of their apparatus may be mentioned Messrs. Elliott, Apps, Browning, Adie, Grubb, Cooke, and Tinsley. The following map makers will contribute:—Messrs. Stanford, Murby, and Keith Johnston. Numerous collections for teaching have been promised. Among these may be mentioned an exceedingly interesting collection prepared by Prof. Guthrie. All this apparatus is made out of simple materials by the students themselves. A committee, consisting of Dr. Stone, Dr. Pole, Mr. W. Chappell, and Mr. Baillie-Hamilton, are forming a most interesting collection illustrative of the scientific principles on which the construction of musical instruments is based. Mr. Markham is forming a collection of Arctic maps, Mr. F. Galton a collection of exploratory apparatus, Mr. Scott a collection of meteorological apparatus, and Dr. Mann a collection of instruments connected with atmospheric electricity. Various local committees have been formed to forward the objects of the Exhibition. Amongst them may be mentioned one at Leeds for Yorkshire, arising from the exertions of Prof. Thorpe. Among other interesting objects from Germany, we may look for some of Tycho Brahe's instruments, and the original air-pump of Otto von Guericke. From France we have as yet no very definite information, but we expect a very interesting collection, as the French Commission, consisting of members of the Academy of Sciences, have devoted considerable attention to the Exhibition, and the Conservatoire des Arts et Métiers have promised some of their finest things. From Italy it is hoped that some of the instruments used by Galileo, Torricelli, Volta, and Galvani may be obtained. In consequence of want of room in the South Kensington Museum, it is intended to hold the Exhibition in the western galleries of the buildings lately used for the Annual International Exhibitions, her Majesty's Commissioners having most obligingly placed them at our disposal for the purpose. I cannot overrate the advantages we have derived from the services of Mr. Norman Lockyer, who has been transferred temporarily to this department. Professors Guthrie and Goodeve have also assisted us most remarkably, and various learned societies have been invited to organise conferences and *conversazioni*." His Grace concluded (by suggesting the desirableness of forming one or two sub-committees for the purpose of making the necessary arrangements for the reading of papers, conferences, and receptions, and expressing his confidence that a cordial welcome will be accorded to distinguished scientific visitors from other countries.

Dr. Hooker moved "that a sub-committee be formed, consisting of the presidents and one vice-president of each of the learned societies, to consider the reading of papers, conferences, and demonstrations; and, secondly, the arrangements for the receptions." Mr. Warren De la Rue seconded the motion, which was carried.

### PROF. FLOWER'S HUNTERIAN LECTURES ON THE RELATION OF EXTINCT TO EXISTING MAMMALIA<sup>1</sup>

#### III.

**ORDER Proboscidea.**—This name has been appropriated to a well-marked group of animals, presenting some very anomalous characters, allied in many respects to the Ungulata, but belonging neither to the

<sup>1</sup> Abstract of a course of lectures delivered at the Royal College of Surgeons "On the Relation of Extinct to Existing Mammalia, with Special Reference to the Derivative Hypothesis," in conclusion of the course of 1872. (See Reports in NATURE for that year.) Continued from p. 308.

Artiodactyle nor Perissodactyle type of that order. It has been thought that they possess some, though certainly not very close, affinities with the Rodentia, and also with the Sirenia. It is certain, however, that the two species of Elephant which are the sole living representatives of the order, stand quite alone among existing mammals, widely differing from all others in many parts of their structure, being in some respects, as in the skull, dentition and proboscis, highly specialised, though in others, as in the presence of two anterior venæ cavæ and in the structure of the limbs, retaining a low or generalised condition. A considerable series of extinct forms, extending back through the Pliocene and Miocene epochs, show the same type under still more generalised outlines. Though no true Proboscideans have as yet been found in any Eocene formations, certain recently discovered forms of that epoch from North America, if their affinities are rightly interpreted, may link them to some unknown primitive type of Perissodactyle Ungulate. The consideration of these will, however, be reserved until the next lecture.

All the true *Proboscidea* are arranged in three principal groups or genera—*Elephas*, *Mastodon*, and *Dinotherium*. Their molar teeth, by which the extinct species are chiefly known, present a remarkable series of modifications, from the comparatively simple tapiroid teeth of *Dinotherium*, with two or three strongly pronounced transverse ridges, and a normal mode of succession, to the extremely complex structure and anomalous mode of replacement found in the true Elephants. The intermediate conditions occur in the various species of *Mastodon*. In this genus the enamel-covered transverse ridges of each tooth are generally more numerous than in *Dinotherium*, and often complicated by notches, or by accessory columns attached to them, but in the unworn tooth they stand out freely from the crown, with deep valleys between. In the Elephants the ridges are still further increased in number, and are greatly extended in vertical height, so that, in order to give solidity to what would otherwise be a laminated or pectinated tooth, it becomes necessary to envelop and unite the whole with a large mass of cementum, which completely fills up the valleys, and gives a general smooth appearance to the organ when unworn; but as the wear consequent upon the masticating process proceeds, the alternate layers of tissue of different hardness, cement, dentine, and enamel, which are disclosed on the surface, form a fine and very efficient triturating instrument. The modification of the tooth of a *Mastodon* into that of an elephant is therefore precisely the same in kind as that of the molar of a *Palæotherium* into that of a horse, or of the corresponding tooth of an early Artiodactyle into that of an ox. The intermediate stages, moreover, even as our knowledge already extends, are so numerous that it is not possible to draw a definite line between the two types of tooth structure. As regards the mode of succession, that of the modern elephants is, as before mentioned, very peculiar. During the complete lifetime of the animal there are but six molar teeth on each side of each jaw, with occasionally a rudimentary one in front, completing the typical number of seven. The last three represent the true molars of the ordinary mammals, those in front appear to be milk molars, which are never replaced by permanent successors, but the whole series gradually moves forwards in the jaw, and the teeth become worn away, and their remnants cast out in front, while development of others proceeds behind. The individual teeth are so large and the processes of growth and destruction take place so slowly, that not more than one, or portions of two teeth, are ever in place and in use in each side of each jaw at one time. On the other hand the *Dinotherium*, the opposite extreme of the Proboscidian series, has the whole of the molar teeth in place and use at one time, the milk molars having been vertically displaced by pre-molars in the ordinary fashion.

Among *Mastodons* transitional forms occur in the mode of succession as well as in structure, many species showing a partial vertical displacement of the milk molars, and the same has been observed in one extinct species of Elephant (*E. planifrons*).

Abundant remains of fossil elephants have been found in Pleistocene and Pliocene deposits in many parts of Europe, including the British Isles, in North Africa, throughout the North American continent from Alaska to Mexico, and extensively distributed in Asia. These species are chiefly known and characterised at present by the teeth, some of which resemble the existing Indian, and some the African type, but the majority are intermediate between the two, and make the distinction between *Elephas* and *Loxodon* as different genera quite impracticable. Others, again, approach so closely in breadth and coarseness of the ridges, and paucity of cementum to the *Mastodons*, as to have been placed by some naturalists in that genus. These form the group or sub-genus called *Stegodon* by Falconer. The best known extinct species of elephant are *E. primigenius*, the Mammoth, very closely resembling the existing Indian Elephant, of Pleistocene age, extensively distributed throughout Northern and Central Europe, North Asia, and North America, though most of the remains attributed to it in the latter country may belong to another species, *E. Americanus*, De Kay, which, according to Leidy, includes *E. Columbi*, Falc. In the frozen soil of North Siberia, complete animals, with the flesh and hair upon them, are often found, and their tusks are still collected in large quantities and in a sufficiently perfect condition to be used as ivory. *E. antiquus* and *E. meridionalis* are two other species found in Britain as well as Europe generally, of rather earlier date, and inclining more to the *Loxodon* type, as also do two species found in the island of Malta, *E. mnaidriensis* and *E. melitensis*, the latter the smallest known species of the group, sometimes not exceeding three feet in height when adult. The *Stegodon* forms, *E. cliffi*, *bombifrons*, and *insignis* of Falconer and Cautley, are all from India, which would appear, from the abundance of remains, variety of form, as well as the generalised characters of some, and the geological horizon (Lower Pliocene) to be the earliest habitation of the true elephant yet discovered.

The *Mastodons* are distinguished from the elephants principally by the form of the molar teeth; the only absolutely distinguishing character, and that somewhat of an arbitrary one, being that the third, fourth, and fifth molars have an equal number of ridges, whereas in the elephants the third and fourth are alike, but the fifth has a larger number. In addition to the great incisor tusks of the upper jaw they often, but not invariably, have lower incisors, which are always wanting in the elephants. They are all gigantic animals, equalling or exceeding the recent elephants in size. Their remains have been found in Europe and Southern Asia in Miocene and Pliocene beds, but not of an earlier or later date. Two species, *M. arvernensis* and *M. borsoni*, occur in England in the Suffolk Red Crag. They have also been found in both South and North America. In the latter, *M. Americanus*, Cuv., *M. ohioiticus*, Blumenb., with very simple ridged molars, is of Pleistocene age, its remains being found in great abundance and very perfect condition. It was, therefore, the last survivor of the genus. The *Mastodons* were divided by Falconer into three series called respectively *Trilophodon*, *Tetralophodon*, and *Pentalophodon*, according to the number of ridges upon the molar teeth.

The *Dinotheria* were also animals of elephantine proportions, strikingly characterised by the pair of huge tusks descending nearly vertically from the fore part of the lower jaw. The presence or absence of upper incisors has not yet been satisfactorily ascertained. The cranium was much depressed, differing from that of the elephants in the comparatively little development of the air-cells.

The remainder of the skeleton is imperfectly known, but apparently agrees in its general characters with the other Proboscideans. Its remains have been met with in abundance at Eppelsheim, near Darmstadt, and also in various other Miocene formations in the South of Germany, France, and Greece; in Asia Minor, Attock in the Punjab and Perim Island, but whether all belonging to one species (*D. giganteum*, Kaup.) or to several, the materials are not at present sufficient to determine. The genus has not hitherto been found in England or in America.

The gradual transition in the character of the molar teeth of various Proboscideans is well illustrated by the following table (compiled from Dr. Falconer's Memoirs) of the "ridge formula" of various species. The numbers are, however, only averages, and it must be remarked that the higher the numerical expression of the ridge formula in the species the more liable is the number of ridges to vary within certain limits, especially in the teeth of the lower jaw, where they are often in excess. Several species, apparently intermediate in ridge formula to those in the table, have since been discovered, as *Mastodon pentelici* and *andium*, which break down the distinction between the sections *Trilophodon* and *Tetralophodon*, and *Elephas melitensis* between *Loxodon* and *Eulephas*.

	Milk Molars.			True Molars.			Total.
	I.	II.	III.	I.	II.	III.	
<i>Dinotherium giganteum</i> ... ..	1	2	3	3	2	2	13
<i>Mastodon (Trilophodon) americanus</i>	1	2	3	3	3	4	16
<i>Mastodon (Tetralophodon) arvernensis</i> ... ..	2	3	4	4	4	5	22
<i>Mastodon (Pentalophodon) sivalensis</i>	3	4	5	5	5	6	28
<i>Elephas (Stegodon) insignis</i> ... ..	2	5	7	7	8	10	39
<i>Elephas (Loxodon) africanus</i> ... ..	3	6	7	7	8	10	41
<i>Elephas (Loxodon) meridionalis</i> ...	3	6	8	8	9	12	46
<i>Elephas (Eulephas) antiquus</i> ... ..	3	6	10	10	12	16	57
<i>Elephas (Eulephas) primigenius</i> ...	4	8	12	12	16	24	76
<i>Elephas (Eulephas) indicus</i> ... ..	4	8	12	12	16	24	76

(To be continued.)

THE FIRST GENERAL GEOLOGICAL MAP OF AUSTRALIA<sup>1</sup>

FROM its vast size and its peculiar conditions of physical geography the island-continent of Australia presents formidable difficulties alike to the topographical and the geological surveyor. Of its wide desert interior we know nothing more than what has been seen or conjectured along the tracks of the few adventurous men who have penetrated it. The eastern and southern colonies have been more or less thoroughly geologised, and expeditions have been sent to make known the capabilities of portions of the western and northern coasts. Several of the colonies have equipped geological surveys, though they have not always cared to maintain them. A great deal of miscellaneous knowledge regarding the rocks of the country has thus been acquired, but it is scattered through hundreds of blue-books, reports, memoirs, transactions of societies, newspapers, and other publications. Those who are most familiar with Australian geology, can best judge whether the time has now come when this store of diffused information may be profitably condensed in the form of a general map of the whole country. Mr. Brough Smyth has deemed that it may, and accordingly he has produced the present map—the first general geological map of Australia which, so far as we are aware, has been published.

No one could have performed so well as Mr. Smyth the difficult task of compiling this map. From his official position as Secretary for Mines in Victoria, he has, of

<sup>1</sup> First sketch of a geological map of Australia, including Tasmania. By R. Brough Smyth, F.G.S., &c.

course, unequalled facilities for doing justice to his own Colony; and from correspondence with the government departments of the other colonies, he has obtained access to all the stores of information which successive surveys and expeditions have brought into the archives of the different governments. In the winter of 1872-3 he obtained the consent of his own government to his plan for elaborating a general map of Australia, and he immediately set to work to solicit information from all quarters. In his Progress Report, dated Oct. 1, 1873, he acknowledged the assistance already received from Queensland, Western Australia, South Australia, and Tasmania, but regretted the existence of many blanks, instancing in particular the want of a geological map of the important colony of New South Wales. The present map, however, bears the conspicuous date of April 25, 1873, though confessedly incomplete in October of that year, and not published until November 1875. Mr. Smyth's name alone appears on the title. No doubt he will take care to state fully in the text which it is proposed to issue in illustration of the map, the share which others have had in the real geological surveying of which he has been the fruit. Still, when we think of the many years of bodily and mental toil which such men as W. B. Clarke, Selwyn, Daintree, and others have given to the working out of Australian geology, we cannot help expressing a feeling of disappointment that on the fore-front of this first geological map of the country no place should have been found for their names.

With the exception of this omission, which may have arisen from inadvertence, and may yet be fully atoned for, little but the most unqualified praise is to be given to this map. We have already had occasion to call attention in this journal to Mr. Brough Smyth's great energy, and to the important services which he is rendering, not only to the industrial development of Victoria, but to the progress of geology. He has probably never accomplished, however, any task more likely to be of service in Australia or more useful to geologists in other countries than this first sketch of a geological map of that great region. Though the scale of the map is only 1:110,000 or 110 miles to an inch, it is no doubt quite large enough for a beginning. It shows the salient features of the geology without too many confusing details. As a specimen of cartography, the map is one of the best which has recently appeared, and it does great credit to the taste and skill of the engravers and lithographers of the Mining Department at Melbourne, where it has been produced.

The first point about this map which will probably occur to most geologists is the comparatively large area over which it has been found possible to spread geological colours. The surveys and explorations of Queensland, New South Wales, Victoria, Southern and Western Australia, have sufficed to furnish materials for colouring most of the maritime tracts, as well as a large part of the eastern half of the continent. But it might have been supposed that in spite of the journals of the few adventurers who have crossed the interior, that great inland desert would have been left an uncoloured blank upon the map. Mr. Smyth, however, has made the most of every scattered notice and stray observation. He has coloured the exploring tracks across the country in such a way as to suggest very clearly what must be the geological structure of the interior. The eastern mountain-chain bringing up the crystalline and older palæozoic rocks from Bass Strait to Torres Strait is well shown. On the western coast an enormous mass of granite is marked as stretching over fifteen degrees of latitude, and spreading far into the interior, where it seems to pass under the vast sheets of "desert sandstone," which occupy so much of the low interior of Australia. Carboniferous rocks are coloured over large spaces in Eastern Queensland, but the compiler of this map stops the tint

short at the northern limits of New South Wales, and makes the coal-field of that colony Mesozoic, against the earnest protest of the Rev. W. B. Clarke, whose judgment on all matters concerning the geology of New South Wales is not to be lightly opposed. Cretaceous strata, first recognised from fossil evidence by Prof. M'Coy, are represented as covering a wide belt of country from the plains south of the Darling northwards to the Gulf of Carpentaria. The tertiary deposits are massed under one tint, which spreads over most of the interior, sweeping up to the base of the inland slopes of the Eastern Alps, and down to the coast-line for many leagues on the northern, western, and southern margins of the country.

No arrows to show prevalent inclinations of strata have been inserted on the map, and as no illustrative sections are given, the reader is left to infer the relations of the formations whose general area and boundaries are so clearly defined. The required information may be expected in the promised text to accompany the map. Another omission is the want of any sign for the gold and coal-fields. This might have been easily inserted without any diminution of the clearness and beauty of the map, and would have been of value to those who take interest in the mineral resources of the country. It is to be hoped that a new edition will soon be demanded, and that these small defects in a most useful and meritorious work will be supplied.

PHYSICAL SCIENCE IN SCHOOLS

WE have received the following additional letters on this subject:—

Your Rugby correspondents appear to me somewhat to misapprehend Dr. N. M. Watt's arguments on this important question. No satisfactory results, he maintains, can accrue from science teaching in schools until the subject is placed upon its true position of *educational equality*, both as regards range and time, with classics and mathematics, and no system of regulations or of examinations can be said to fulfil its object in which this position is ignored. I for my own part most cordially support Dr. Watt's views. The position at present accorded to science in English schools is, as Sir John Lubbock has clearly shown, anything but satisfactory, and this state of things seems likely to continue so long as the examinations for which the boys prepare persist in placing the science subjects in a distinctly inferior position to the older studies. Surely it is the part of examining bodies to lead and raise the education of the country. I think, however, that it has been fully proved that the "Oxford and Cambridge Schools Examination Board" has not done this, at any rate so far as science is concerned. The facts adduced by Mr. Cumming as to the small number of candidates presenting themselves for examination in science proves to my mind that the teaching of science is usually discouraged because it is usually not understood, and no efficient means of teaching science being as a rule provided, these subjects are not only neglected but their study becomes even despised by the boys. The truth is that it is the difficulty of obtaining such men as Mr. Wilson and Dr. Watts which renders the progress of science teaching in schools less rapid than some of us could wish. As soon as the supply of really competent and high class natural science masters becomes as large as that of equally distinguished teachers of classics or mathematics we may be sure that science will occupy no inferior position. Until that time arrives it behoves all those interested in the educational applications of science to take care that the teaching is really exact, methodical, and disciplinary, in short, scientific, so that if we do not progress rapidly we advance all the more surely, and we look with interest to the results of the education in those few schools such as Giggleswick and

Newcastle-under-Lyne, in which science has already been placed on a footing of equality with the older studies.  
Manchester, Feb. 26 HENRY E. ROSCOE

The remarks of Dr. Marshall Watts on physical science in schools in NATURE (vol. xiii., p. 311), seem to me to call for one or two observations in addition to those made by Mr. Wilson and Mr. Cumming in your columns last week (p. 329).

Dr. Watts selects a few questions from the examination papers that were set in heat, chemistry, and geology, by the Oxford and Cambridge Schools Examination Board in 1854, the first year of its existence, in order to show what he considers the very elementary nature of the knowledge required, and he adds that "with the exception of the last question [naming certain rocks and fossils] there is no test of a practical kind at all."

Now it is only fair to state that although it is quite true that there was no examination in practical chemistry in 1854, yet in the regulations for the next year "the elements of practical qualitative analysis" were added to "the elementary parts of inorganic chemistry," and last July those candidates who took in chemistry were examined for three hours in practical laboratory work, six substances being given to each boy for analysis.

Moreover, with regard to theoretical chemistry, the paper that was set last year was decidedly harder than that of the year before. I inclose a copy, and should be glad if you could find space to print it. As a matter of fact it is harder than the average chemistry papers of the London University Matriculation Examination, and quite as hard as an ordinary Oxford Pass Paper.

"Natural Philosophy (Chemical Division.) (Time 1½ hours.)

A.

"1. What happens when pure iron is dissolved in excess of dilute sulphuric acid? Give an account of the properties of the solution which is obtained, and the tests by which you would show what salt of iron is present. Suppose some of the solution were boiled with potassium nitrate, what changes would you expect to take place?"

"2. Explain atom, molecule, acid, base. How can you show the composition by weight and volume of hydrogen with chlorine, bromine, and iodine? mention the best methods of obtaining these compounds in the state both of gas and in solution.

"3. How is analysis of air made with the eudiometer? Describe how to correct the observations for pressure, temperature, and aqueous vapour. Suppose 100 c.c. of oxygen to be mixed with 10 c.c. of marsh gas and exploded, find the amount of the residual gases.

"4. What is the percentage composition of nitrous and nitric oxides? How are these bodies prepared? Distinguish between the properties of nitrates and nitrites.

"5. Describe briefly the manufacture either of sulphuric acid or of bleaching powder.

"6. Account for the production of carbon mon-oxide in the blast furnace, and show what action it has in reducing the roasted iron-stone. What is the best method of preparing carbon mon-oxide: in what respects does it differ from the di-oxide?"

"7. How is the metal aluminium prepared? Describe the manufacture of alum, and give a brief account of the properties of alumina.

"8. Describe the preparation and properties of the bodies SnCl<sub>4</sub>, HgC<sub>2</sub>N<sub>2</sub>, PbO<sub>2</sub>, K<sub>2</sub>Cr<sub>2</sub>O<sub>7</sub>, HCN.

"Practical Chemistry. (Time 3 hours.)

"1. The substances marked 1, 2, 3, 4 are simple salts.

"2. The substances marked 5, 6 are elements.

"You are requested to find out what they are, and to write a full account of the methods you use."

Now at the risk of being accused of taking a low standard, I cannot help thinking that although some of these

questions may be called "very easy," yet there are others quite sufficiently difficult for the ordinary public school-boy, who has a great many other things to work at besides natural science.

A boy must have read his chemistry thoughtfully, to say the least, who could answer the whole of Question 1 thoroughly. In Question 2 there is ample opportunity for showing a deeper knowledge than could be obtained by skimming over some "outlines of chemistry." So again the explanation and illustration of the peculiar oxidising and reducing properties of *nitrites*, in Question 4, and the description of the preparation and properties of the different bodies enumerated in Question 8, could, I maintain, only be given satisfactorily by boys who had acquired something more than a mere "modicum" of chemical knowledge.

It must also be borne in mind that in order to pass the Chemical Division of Group IV., a boy must take in, in addition to the chemistry of the metallic and non-metallic elements and practical analysis, either heat or magnetism and electricity.

Now although there may be reasons for combining together heat and chemistry, so long as it is understood that only the more elementary parts of heat will be required, yet it is certainly unreasonable to add on as an extra such a very comprehensive subject as that of magnetism and electricity, frictional and voltaic, including electro-magnetism.

Surely, to say the least, electrical science is quite as worthy of an independent existence as botany or geology, and I much doubt whether many would hesitate in admitting it to be much harder than either.

My own opinion is in favour of Mr. Wilson's suggestion—to divide Group IV. into Pass subjects and Honour subjects, requiring only an elementary knowledge of theoretical chemistry, and perhaps the simpler parts of heat for the one, while practical analysis with higher knowledge of heat, or electricity and magnetism, might be required from those who aimed at taking honours in science.

It is perhaps due to the school to say that we can hardly be supposed to be frightened at the prospect of these examinations. Last July three in the Sixth took in chemistry as a certificate subject: all passed and two obtained "distinction"—three being the total number who obtained such distinction out of the twenty-eight candidates who presented themselves for examination in this subject.

T. N. HUTCHINSON

Rugby

In my letter last week, p. 329, I said that the papers set in science in the certificate examination *last year* were very easy. This was a slip. I was absent from England when they were set, and had never seen them. I had in my mind the papers of the year before.

The papers of last year were quite hard enough. It must be remembered that very many schools give only *two lessons a week* to science.

JAMES M. WILSON

#### ANNIVERSARY ADDRESS OF THE PRESIDENT OF THE ROYAL GEOLOGICAL SOCIETY, JOHN EVANS, F.R.S.

MR. EVANS began by referring to the immense advances in geological science since 1825, when the Society received its charter, and pointed out that although there now existed a considerable body of professional or trained geologists, yet amateurs need not be discouraged from taking up the science which now embraces so wide a field that there is ample room for both. He then referred to the prosperity of the Society, to its publication, its medals, and other means for fostering the science, and to its valuable museum, an "interesting notice of which," he intimated, "appeared in NATURE, vol. xiii. p. 227." Mr. Evans then spoke of the present prospects of the science, of the bearing which recent discoveries in other branches of

knowledge has upon it, and of the direction in which ~~new~~ discoveries are likely to be made. In this connection he referred to the recent researches in solar physics by means of spectrum analysis and solar photography, as having a close and intimate bearing on the early history of the earth, and which we discussed by Prof. Prestwich in his inaugural lecture at Oxford (NATURE, vol. xi. p. 290). He spoke also of the importance of spectrum analysis to the metallurgist, referring to the researches of Mr. W. C. Roberts in quantitative analyses of gold-copper alloys. Mr. Evans then spoke at some length of the important results already attained by the *Challenger* Expedition as to the nature of the sea-bottom. In speaking of the Arctic Expedition, from which geology hopes to gain much, he referred to the powerful evidence which exists in the fossil flora of Greenland and Spitzbergen, of the prevalence in the Arctic regions at one period of a distinctly warm climate.

Mr. Evans then went on to say:—The three points which it appears to me are most important to bear in mind with regard to the Arctic flora are:—1, That for vegetation such as has been described, there must, according to all analogy, have been a greater aggregate amount of summer heat supplied than is now due to such high latitudes; 2, that there must have been a far less degree of winter cold than is in any way compatible with the position on the globe; and 3, that in all probability the amount and distribution of light which at present prevail within the Arctic circle are not such as would suffice for the life of the trees.

Should the present Arctic expedition succeed in finding traces of what must be regarded as a temperate, if not indeed a sub-tropical fossil flora, like that of Greenland, and Spitzbergen, extending to latitudes still nearer the pole, it does appear to me that geologists will be compelled to accept as a fact that the position of the axis of rotation of our planet has not been permanent; and they will have to call upon astronomers to find some means of admitting what they now regard as impossible.

An astronomer and mathematician of no mean ability, the late Sir John W. Lubbock, in a paper communicated to this Society in 1848, has speculated upon this subject, which was in consequence discussed by the late Sir Henry Delabèche in his Presidential Address in 1849.

Sir John Lubbock remarked that the dictum of Laplace as to the impossibility of accounting for the changes which have taken place on the surface of the earth, and in the relative positions of land and water, by a change in the position of the axis of rotation, was founded upon the absence of two considerations, both of which appeared to him essential. These were—

1. The dislocation of strata by cooling,
2. The friction of the surface.

The latter consideration is apparently of but little importance; but with regard to the former, he pointed out how, if from any cause the axis of rotation did not coincide with the axis of figure, the pole of the axis of rotation would describe a spiral round the pole of the axis of figure until it finally became, as it is at present, identical with it. He considered it unlikely that originally the axis of rotation should have coincided exactly with the axis of figure, unless the whole globe were perfectly fluid; but added that we might go back to a time less remote, when the earth was in a semifluid state, and in consequence of the different degrees of fusibility of different substances, was partly solid, in irregular masses, and the two axes did not, in consequence, coincide. We might, he added, assume the original state of want of uniformity between them to have been at a period even more recent, when the earth consisted of land and water, and was suited for the support of animal life. He then proceeds to show how, if, after any length of time the solid spheroidal part of the earth moved about any new axis of rotation, the water would occupy a new position about a new equator, land would become sea, and sea land, &c.

He adds that if the axis of the earth would suffer a displacement by reason of the causes which produce the precession of the equinoxes, we should have another and more natural way of accounting for the existing phenomena; but this has been held to be impossible.

I am not at present going to question whether this holding is correct; but with regard to Sir J. W. Lubbock's reasoning as to the necessity of the axis of figure coinciding with that of rotation, it appears to me of the greatest importance; for if it hold good, any alteration in figure cannot but have some effect on the position of the axis of rotation. No doubt, if the whole globe, or even the solid portion of it, were a regular spheroid, with a large



equatorial protuberance, any modification on its surface would have to be on an enormous scale to produce any sensible effect upon its axis of revolution. But, after all, is the earth, strictly speaking, a spheroid?—and are not some of the arguments and dicta based upon its spheroidal character founded on a fallacy? For it does appear to me a fallacy to treat as one homogeneous spheroid, a body partly consisting of a mass of solid or quasi-solid matter of irregular form, and partly of a liquid mass in constant motion, irregularly distributed over a portion of its surface. No doubt the contour of the liquid portion is, according to established geometrical laws, almost that of a regular spheroid; but its distribution, except in the case of inland seas, can have but little to do with the regulation of the movement of the solid body on which it rests. It is true that Laplace has maintained that “whatever may be the law of the depth of the ocean, and whatever the figure of the spheroid which it covers, the phenomena of precession and nutation will be the same as if the ocean formed a solid mass with this spheroid;” but do the position of the axis of revolution and its permanence in one spot come under the same category as precession and nutation? It certainly appears to me that the position of the axis of revolution must mainly depend upon the form of the mineral portion of the globe, and be but in the slightest degree affected by the distribution of the ocean, the specific gravity of which is moreover only about one-fifth of that of the more solid portion.

With regard to the permanence of the axis of rotation, if it must of necessity coincide with the axis of figure, and if the figure of the mineral portion of the earth, in consequence of upheavals and depressions, of the wearing away of continents and the transportation of their constituents by mechanical or even chemical means, is being constantly changed, so as to acquire a new axis, then the axis of rotation must also as constantly be undergoing a change of position.

Let us now glance at some of the irregularities of form of the more solid part of the globe as at present existing. The difference between the polar and equatorial diameters of our globe has been calculated at about 26 miles, or about 13 miles in the radius; but at the equator itself, little more than one-fifth of the circumference of the globe is dry land, and nearly four-fifths are sea; and this sea is by no means shallow, as the soundings taken by the “Tuscarora,” the “Challenger,” and other exploring vessels will prove. Leaving those taken near land out of the calculation, I find that 48 soundings in the Pacific, between 15° and 30° north latitude, give an average depth of 2,634 fathoms, or 5,268 yards, that is to say, within a few yards of three miles. The South Pacific does not appear to have been so well explored; but across the Atlantic, in the equatorial regions between 10° N. and 10° S., I find that an average of 32 soundings gives a mean depth of 2,309 fathoms, or 4,618 yards, while, in one spot in lat. 15° S., Sir James Ross did not find the bottom with a line of 4,600 fathoms, or nearly 5½ miles. In the Indian Ocean, within the same limits, 20 soundings give an average of 2,468 fathoms, or 4,936 yards, or more than 2½ miles. Taking these soundings as fair representations of the depth of the sea in the neighbourhood of the equator, it appears that we may at once reduce the equatorial diameter of the more solid part of the globe by from 5½ to 6 miles over nearly four-fifths of its circumference; that is to say, we may reduce the usually accepted equatorial protuberance from about 13 miles to a little over 10. It is not within my province to inquire whether the fact of so large a portion of the equatorial protuberance being of so much less specific gravity than if it were composed of mineral matter, will in any way affect the established calculations with regard to the precession of the equinoxes and the nutation of the poles, or, what is of more importance to us, the inferences with regard to the crust of the earth which have been thence deduced.

But while so large a portion of the surface of the land is, in the equatorial regions, so much below the normal level, there are, especially in the northern hemisphere, large tracts of land which, like the great plateau of Tibet, are some thousands of feet above it. The average elevation of the whole of Asia has, indeed, been estimated at 377 yards, or nearly a quarter of a mile above the sea-level. The depth of the ocean in non-equatorial regions must no doubt be taken into account; but practically, the spheroidicity of the globe, on which the stability of the pole has been held to depend, may be regarded as, even at the present time, considerably less than is usually supposed. When, however, we come to think of the enormous elevations and depressions which some parts of the globe have undergone during geological time, it is by no means difficult to imagine conditions under which the general average, so to speak, of the surface, would approach much

more nearly to the form of a sphere, and the globe would become much more sensitive of any disturbances of its equilibrium; but whether the globe is a sphere or a spheroid, it is hard to see why disturbances of its equilibrium should not affect the position of its axis of rotation.

Taking our globe with the distribution of land and water as at present existing, I should like to inquire of mathematicians what would be the theoretical result of such a slight modification, geologically speaking, as the following:—Assume an elevation to the extent, on an average, of 4,000 feet over the northern part of Africa, the centre of the elevation being, say, in 20° north latitude. Assume that this elevation forms only a portion of a belt around the whole globe, inclined to the equator at an angle of 20°, and having its most northerly point in the longitude of Greenwich, and cutting the equator at 90° of east and west longitude. Assume that along this belt the sea-bottom and what little land besides Africa it would traverse were raised 4,000 feet above its present level over a tract 20° in width. Assume further that the elevation of this belt was accompanied by corresponding depressions on either side of it, so as to leave the total volume of the mineral portion of the earth unaffected. Would not such a modification of form bring the axis of figure about 15° or 20° south of the present, and on the meridian of Greenwich, that is to say, midway between Greenland and Spitzbergen? and would not, eventually, the axis of rotation correspond in position with the axis of the figure?

If the answer to these questions is in the affirmative, then I think it must be conceded that even minor elevations within the tropics would produce effects corresponding to their magnitude; and also that it is unsafe to assume that the geographical position of the poles has been persistent throughout all geological time.

It is not the first time that I have insisted upon this point; for, some ten years ago, I pointed out another possible means of accounting for a change in the geographical position of the axis of the earth. My hypothesis was, however, founded on the assumption of the globe consisting of a comparatively thin crust, with an internal fluid nucleus over which the crust would slide when, from any geological cause, its equilibrium was disturbed. To this it has been objected—1st, That there would be a tendency in the transfer of sediment from one part of the globe to another, and in the various elevations and depressions of land simultaneously, to balance each other; and 2nd, that the friction over the nucleus would be too great, and that, owing to the earth being a spheroid and not a perfect sphere, any motion of the crust would be attended by great resistance, and the bending and rearing of its mass.

To these objections it may be replied that the effects of the transfer of sediment from one place to another, and of elevations and depressions of land going on at the same time, are just as likely to be doubled by the depressions taking place in the same hemisphere as the elevations, but on opposite sides of the pole, as they are to neutralise each other; and, 2ndly, that with a comparatively thin crust, the readjustment to a fresh position on a nucleus so slightly spheroidal as that supposed to exist in the earth, is not accompanied by any great change of form, or certainly not more than what the contorted rocks all over the world have undergone.

I am not, however, on the present occasion, going to attempt to prove that the assumption involved in my hypothesis is reasonable. How we are to account for all the vast oscillations of the earth's surface, which we find to have been going on ever since the earliest geological period up to the present day, on any assumption more reasonable, I will leave for others to determine. I have already called attention to the bearing which recent researches in solar physics have upon this subject, and I am content to leave the matter as it stands, in the hope that before many years have passed, we may learn more either in its proof or disproof.

The moral which I wish to draw from all that I have just said is this:—That so long as there is a possibility, not to say a probability, of the geographical position of the poles having changed, it is premature to invoke intense glacial periods to account for all the glacial phenomena which may be observed. Much as we must esteem the labours of M. Adhémar and Mr. Croll, and others who have gone so deeply into the question of glaciation—enormous as have been the effects of ice in this and other countries—there are many who cannot but feel that the ice-caps invoked almost transcend our powers of belief, and who will be grateful to any astronomer or mathematician who will bring the pole

Lyell's "Principles," 11th edition, vol. ii. p. 209.

round which they were generated, somewhat nearer to our doors.

There is yet one point on which, before quitting the subject, I may add a few words. Sir J. W. Lubbock, in the paper from which I have already quoted so much, has hinted at the possibility of some want of homogeneity in the constitution of the globe, so that in cooling, the position of the axis of rotation may have changed. The varying amount of subterranean heat and volcanic energy in the same region at different periods of the earth's existence has frequently been commented on, as has also the varying degree of subsidence or elevation in the same tract at different times. The forces, whatever they may be, to which these upward and downward movements are due, have, as Sir Charles Lyell has remarked, "shifted their points of chief development from one region to another, like the volcano and the earthquake, and are all, in fact, the results of the same internal operations to which heat, electricity, magnetism, and chemical affinity give rise."

Whether changes in the specific gravity of enormous masses of rock in consequence of their being heated would be of sufficient degree to disturb the equilibrium of the globe, is a difficult question; but the remarkable position of the magnetic poles of verticity with regard to the actual poles of the earth, and the distribution of the magnetic force over the earth's surface may, as has been suggested to me by Capt. F. J. Evans, F.R.S., have some geological significance. These poles are in lat.  $70^{\circ}$  N., long.  $96\frac{1}{2}^{\circ}$  W., and in lat.  $73^{\circ}$  S., long.  $147\frac{1}{2}^{\circ}$  E. If we draw a circle around the globe, cutting these two points, we find that the magnetic poles, instead of being  $180^{\circ}$  apart, are only about  $165^{\circ}$  distant in one direction, while they are about  $195^{\circ}$  in the other. In like manner the magnetic equator, or line of no dip, differs considerably in position from the terrestrial equator, being drawn about  $15^{\circ}$  to the south over South America, and about  $10^{\circ}$  to the north over Africa, and in passing the great Asiatic continent. There is also this singular circumstance, which was insisted upon by Sir Edward Sabine nearly forty years ago—viz., that if the globe be divided into an eastern and a western hemisphere by a plane coinciding with the meridian of  $100^{\circ}$  and  $280^{\circ}$ , the western hemisphere, or that comprising the Americas and the Pacific Ocean, has a much higher magnetic intensity distributed generally over its surface, than the eastern hemisphere, containing Europe and Africa and the adjacent part of the Atlantic Ocean. The points of the greatest intensity of the magnetic force, moreover, do not correspond with the magnetic poles, as there are two such foci in the northern hemisphere (those of America and Siberia) making it probable that there are two also in the southern hemisphere.

Such facts would seem more in accordance with a want of uniformity in the inner constitution of the globe than with its being a body all the parts of which are arranged in perfect symmetry. Some abnormal features in the direction of gravity in different parts of the world seem also to afford corroborative evidence to the same effect. The subject is one of perhaps too theoretical a character for the geologist to approach; but if any definite connection could be established between terrestrial magnetism and the internal constitution of the globe, we might, possibly, be justified in drawing the inference from its phenomena, that there are forces in operation in the interior of the earth by which its equilibrium may have been disturbed, and its axis of revolution thus caused to change in position.

(To be continued.)

### NOTES

THE Italian naturalist Beccari is again in New Guinea, exploring the north coast near Humboldt's Bay, along with an expedition sent out by the Governor-General of the Dutch Colonies. Of his former companion, D'Albertis, now at Yule Island, near the south-eastern extremity of New Guinea, we regret to hear that one of his collections from that district, containing about 35,000 insects and 700 reptiles, has been lost on its transit from Cape York. The bird-skins were, fortunately, not sent by the same vessel, and are therefore safe.

THE Paris Observatory has received for January last Meteorological observations made six times each day, at the Normal Schools, at the following thirty-four places:—Albertville, Alençon, Amiens, Aurillac, Avignon, Beauvais, Besançon, Bourges, Bourges, Caen, Carcassonne, Chalons, Chartres, Chaumont,

Clermont, Commercy, Dragnignan, Foix, Grenoble, Le Mans, Le Puy, Loches, Lons-le-Saulnier, Mâcon, Melun, Mirecourt, Nîmes, Orléans, Parthenay, Pérignaux, Privas, Rouen, Troyes, and Villefranche. The importance of this valuable system of observation in its bearings on the peculiarly difficult problem of the meteorology of France, it would be difficult to over-estimate, especially when taken in connection with the numerous observers of thunder-storms and other phenomena requiring few or no instruments for their observation, whose services are being secured in different departments.

PROF. CANTONI has intimated to the Permanent Committee appointed by the Meteorological Congress of Vienna that the Italian Government has been pleased to intimate its readiness to invite the countries which were represented at Vienna to attend a Meteorological Congress in Italy in the autumn of 1877.

THE Permanent Committee of the Vienna Meteorological Congress have announced their intention to hold their next meeting in London, in Easter week, commencing April 18 next.

NINE Lectures on the Shoulder-Girdle and Fore Limb of Vertebrata, will be delivered in the Theatre of the Royal College of Surgeons, on Mondays, Wednesdays, and Fridays, at 4 P.M., commencing on Monday, March 6, 1876, by Professor W. K. Parker, F.R.S.—Lecture I. March 6. The Vertebrate Skeleton. II. March 8. Shoulder-girdle and Fore Limb of Fishes. III. March 10. Shoulder-girdle and Fore Limb of Fishes. IV. March 13. Shoulder-girdle, Fore Limb, and Sternum of Amphibia. V. March 15. Shoulder-girdle, Fore Limb, and Sternum of Reptiles. VI. March 17. Shoulder-girdle, Fore Limb, and Sternum of Birds. VII. March 20. Shoulder-girdle, Fore Limb, and Sternum of Mammals. VIII. March 22. Shoulder-girdle, Fore Limb, and Sternum of Mammals. IX. March 24. Summary and conclusion.

THE following is the business to be brought before the Half-Yearly General Meeting of the Scottish Meteorological Society to-day:—1, Report from the Council of the Society; 2, Report from the Ozone Committee; 3, The Salmon, Grilse, and Trout Fishings of the Tweed, in relation to Meteorology, by G. L. Paulin, Esq., and the Secretary; 4, Report from the Herring Committee.

THE following memoirs and reports of the United States Geological and Geographical Survey of the Territories, under the direction of Prof. Hayden, are now in the press, and will be issued during 1876:—1. Monograph of the Rodentia of North America, by Elliott Coues and J. A. Allen. Quarto, about 500 pages, with numerous illustrations. 2. Monograph of the Geometrid Moths, by Dr. A. S. Packard, jun. 350 pages quarto, with 13 plates. 3. The Fossil Invertebrata of the Western Territories, by J. B. Meek. 600 pages quarto, and 45 plates, with numerous woodcuts in text. 4. The Fossil Flora of the Lignitic group of the Western Territories, by Leo Lesquereux. 65 plates, quarto. 5. The Ethnography and Philology of the Hidatsa Indians (Minnetares of the Upper Missouri). 400 pages, octavo. 6. Annual Reports of the Survey for 1874 and 1875. 7. Bulletin of the Survey for the year 1876; several important articles in press. Other works are in process of preparation, and may be printed before the close of the year.

THE *Bulletin* of the United States Geological and Geographical Survey of the Territories, Prof. Hayden in charge, has just issued Nos. 5 and 6, which close the year 1875. In No. 5, there are nine articles on various subjects of Geology and Natural History. In No. 6 there are four articles, with table of contents and complete index. It is suggested by Prof. Hayden that the two *Bulletins* of 1874 be bound with those of 1875, as Volume I. The index and title-page have been made with this idea in view. Volume I. will then comprise about 600 closely printed 8vo. pages, with 26 plates, sections, &c.

THE Cincinnati Observatory, since its reorganisation, under the charge of Mr. Ormond Stone, has again assumed a satisfactory position among kindred institutions in the United States. A School of Astronomy has been established, with quite a number of pupils. The double-star observations made by Prof. Mitchell have been reduced, and are ready for the printer. They embrace between 300 and 400 observations, made during the years 1846, 1847, and 1848. A series of double-star measurements has also been entered upon, restricted to those south of the equator, with a result of bringing to light quite a number of new close double stars.

THE first annual report of the Chicago Botanical Garden has been published. A plan has been prepared for the permanent arrangement of the entire ground. At the date of the report living specimens of ninety-five species of native plants had been placed in the garden, and seeds of 456 species collected in sufficient quantity for exchange.

WE understand that Dr. J. Gray McKendrick intends offering himself as a candidate for the chair of Physiology in Glasgow University, when Prof. A. Buchanan's intimated intention of resigning that chair has been carried into effect.

M. PAUL BERT has offered a prize for the best means of protecting the lives of aeronauts and mountain-climbers in circumstances where cold and rarefaction of the air become dangerous. The prize offered by M. Bert is a 20*l.* gold medal, and the competition is open up to December 31, 1876.

THE papers read on Monday evening at the Royal Geographical Society were, "On the Shuei Valley of Burmah," by Mr. Ney Elias; and "Afghan Geography," by Mr. C. R. Markham. The paper of Mr. Ney Elias described an alternative route into China to that which Mr. Margary had unfortunately taken, and been murdered. In introducing the second paper, on "Afghan Geography," Mr. Markham stated that its materials had been collected from the journals of the late General Lynch, compiled in Afghanistan. The paper gave full details of the history, geography, and antiquities of Afghanistan. General Lynch described the country through which he passed as being full of lovely valleys, inhabited by a gentle and hospitable people, as studded with mines of gold and silver and coal, as teeming with fertility, and as being rich in ancient monuments, in inscriptions, and in sculpture. A map of Afghanistan is being prepared in the War Office, embracing all the existing materials, and that map when published will show how many gaps in our geographical knowledge of Afghanistan still remain to be filled up.

THE *Bulletin* of the French Geographical Society contains a paper by M. V. A. Malte-Brun, giving an appreciative and sympathetic account of the organisation of the English Arctic Expedition and its progress up to the latest news received. M. Malte-Brun hopes to see the day when a French Expedition will set out for the North Pole. Abbé David's Second Voyage of Exploration in Western China, 1868-1870, is described, and M. J. Codine gives an account of the discovery of the African Coast from Cape St. Catherine to the Great Fish River by the Portuguese during the years 1484-1488.

ACCORDING to the *Annuaire* for 1876, there appear to be five English Academicians and twenty-nine English correspondents of the Institute of France. As Academicians in Science are Prof. Owen and Sir G. B. Airy; as Correspondents in the Class of Science are Professors Sylvester and Adams (Cambridge), Sir T. MacLear, Rear-Admiral Richards, General Sabine, Dr. J. P. Joule (Manchester), Dr. E. Frankland, Prof. A. W. Williamson, Prof. W. H. Miller (Cambridge), Dr. Hooker (Kew), Dr. W. B. Carpenter, Dr. Huggins, and Mr. Lockyer.

THE *Morgenblad* of Christiania states that a singular phenomenon was observed there after a recent violent storm. A

number of worms were found crawling on the snow, and it was impossible to find the places from which they had issued, everything being frozen in the vicinity. Similar circumstances were reported from several places of Norway.

M. CYBOULSKY, a mining proprietor in Siberia, is said to have given a sum of 100,000 roubles to help the Government to found the Tomsk University.

THE number of students registered in the Paris Faculty of Medicine this year is 6,500, the largest number yet reached. On February 22, the Municipal Council of Paris voted a sum of six millions of francs for the construction of new buildings round the old ones belonging to the Faculty. The property of the buildings now in existence has been given up by the State to the City of Paris on the express condition that they should always be devoted to the Faculty of Medicine.

MANY of our readers, we are sure, will rejoice to hear that a movement is on foot in Germany to abolish the crabbed printed German alphabet and adopt Roman type. We sincerely wish the movement may lead to the desired result, and that it will extend to the still more vexatious written alphabet.

A NEW scientific periodical entitled *Electricité* has been issued in Paris, under the patronage of Count Halley d'Arroz, director of the International Electrical Exhibition of 1877. It will be profusely illustrated, and will be used by the Commission of Organisation as one of its official organs.

THE Committee appointed by the Préfet de la Seine to superintend the construction of lightning conductors in Paris has been changed into a permanent one. A sum of 8,000*l.* has been appropriated by the Municipal Council for reconstructing all the lightning conductors in Paris, or at least all those which may be found defective or inefficient. This sum is a first instalment, as the whole of the work, it is supposed, will cost 50,000*l.*, although the Committee has not recommended the use of copper conductors. It is deeply to be regretted that the teachings of Sir Snow Harris are not better understood in France, as the Committee has adopted a number of excellent recommendations. Until the appointment of the Committee lightning conductors were constructed by ordinary blacksmiths, under the superintendence of architects who knew nothing of physics. A competitive adjudication took place on Feb. 19 between a number of competent electricians for the construction of all the lightning conductors on the Paris municipal monuments. The successful competitor is M. Grenet, the well-known electrician. A *cahier des charges* with seventy carefully-drawn provisions has been published. The electric continuity of conductors must be tested yearly, and the contractor will be paid by instalments, so that his claim will be cleared up only when the efficiency of his work shall have been tested during a certain number of years. The platinum cone has been abolished and replaced by a copper cone. The quality of the iron, as well as of the copper and solder, is to be tested by chemical analysis. The insulation of rods has been abolished as being useless. The Commission has diminished the diameter of protection area, which was supposed to be twice the height, and has reduced it to 1.45. The consequence is that rods are to be multiplied. The principal provisions of the 1876 *cahier des charges* have been drawn in accordance with the instructions published by the French Academy of Sciences in 1825.

WE have received a copy of the rules adopted at a recent meeting of the newly-formed Mineralogical Society of Great Britain and Ireland. The object of the Society is the study of mineralogy and petrology, and it will be composed of ordinary members, associates, and corresponding members. Besides general and annual meetings, local meetings may be held at any time and place as may be agreed upon by six members or associates. The Society will publish a journal. The President is

Mr. H. C. Sorby, F.R.S., the Secretary, Mr. R. P. Grey, F.G.S., and the Council is composed of men whose names are well-known in science.

THE head of the publishing firm of Didot, died a few days ago at the age of eighty-six. The deceased was a member of the Academy of Inscriptions, and under his direction the firm published a number of valuable scientific books. The Didot firm hold the office of printers to the French Institute, M. Gauthier Villars being only printer to the Academy of Science.

THE second annual meeting of the members of the Scientific Club was held at the Club House, Savile Row, on Thursday, the 17th Feb. Major F. Duncan, D.C.L., Chairman of the Committee, presided. The Report of the Committee, showing the rapid progress the Club had made during the past year, was unanimously adopted.

WE are asked to state that supplemental meetings for the reading and discussion of papers by students of the Institution of Civil Engineers have been appointed for the following Friday evenings:—February 25, March 3, 10, 17, 24, and 31. The chair will be taken at 7 o'clock on each evening, and successively by Dr. Pole, F.R.S., Sir W. G. Armstrong, C.B., F.R.S., Mr. H. Hayter, Mr. Woods, Mr. Bruales, and Mr. Berkley, Members of Council.

AMONG the papers in the published "Proceedings" of the Belfast Natural History and Philosophical Society for 1874-75 are the following:—Presidential Address on atoms and automata, by Joseph J. Murphy, F.G.S.; On some Irish Palæozoic fossils, by Rev. John Grainger, D.D.; On the water-bearing strata between Moira and Lurgan, by Robert Young, C.E.; On the geographical distribution of mammals, by R. O. Cunningham, M.D., Professor of Natural History, Queen's College, Belfast; A suggestion on chemical notation, by the president, Joseph John Murphy, F.G.S.; Further notes on some of the swimming birds frequenting Belfast Lough, with special reference to the Great Northern Diver, by R. Lloyd Patterson.

THE additions to the Zoological Society's Gardens during the past week include a Virginian Eagle Owl (*Bubo virginianus*) from N. America, presented by Mr. H. Knight; two Widgeons (*Marca penelope*), a Common Wild Duck (*Anas boschas*), a Lesser Black-backed Gull (*Larus fuscus*), three Herring Gulls (*Larus argentatus*), two Common Gulls (*Larus canus*), three Black-headed Gulls (*Larus rubibundus*), European, presented by Mr. C. Clifton; a Common Otter (*Lutra vulgaris*), European, received in exchange; a Darwin's Pucras (*Pucrasia darwini*) from China, a Rose-crested Cockatoo (*Cacatua moluccensis*) from Moluccas, deposited; a Zebu (*Bos indicus*) born in the Gardens.

### SCIENTIFIC SERIALS

THE *American Naturalist* has changed its form this year. In future it is to be published by Messrs. H. O. Houghton and Co., Cambridge, Mass., under the editorship of Dr. A. S. Packard, jun. The amount of matter is increased, and the articles will be of a more popular nature than previously. A department of Geography and Travel is added, and Dr. R. H. Ward, of Troy, N.Y., will superintend the Microscopy. There seems to be considerable difficulty in the production of a science journal in America, and we think that there is still room for improvement. The first paper in the January number is on "Burs in the Borage family," by Prof. Asa Gray, in which a new form, named *Harpagonella*, is described, having been obtained by Dr. E. Palmer, from Guadalupe Island, off Lower California.—The Rev. S. Lockwood describes the habits of the "Florida Chameleon" (*Anolis principalis*).—Mr. David Scott writes on the proper specific name of the Song Sparrow, *Melospiza fasciata* (Gondin), not *M. melodia* (Wilson).—Mr. J. C. Russell shows of what great value the New Zealand Flax (*Phormium tenax*) would be if a method of cleaning it could be discovered.—Mr. J. A. Allen discusses the availability of certain Bartramian names in ornith-

ology, and opposing Dr. Coues' desire to establish some of them. A list is given of those of Bartram's names which Dr. Coues wishes to re-establish.—Prof. N. S. Shaler describes the first session of the Harvard Summer School of Geology.—Ancient ruins in S.W. Colorado are illustrated and described from photographs taken by Mr. W. H. Jackson, the photographs of Prof. Hayden's United States Geological Survey of the Territories, including a house, a round tower, and a square one of Indian construction.—Reviews of Sach's "Botany" (English translation) and Caton's "Summer in Norway," with badly-engraved drawings, are given, together with notes, &c., which conclude the number.

*Fogendorff's Annalen der Physik und Chemie*, No. 11, 1875.—The tuning-fork has become an important instrument in physical observations, and this number of the *Annalen* begins with a description of experiments by Dr. Ettingshausen, with a stroboscopic tuning-fork apparatus, in which the motion of an electro-magnetically excited fork is observed through slits arranged in connection with another fork of nearly the same pitch placed near it. The following are some of his results:—Compared with pendulum motion, that of tuning-forks is somewhat retarded in the inward course, and accelerated in the outward. The vibration time considerably increases with increase of the time of closure of the circuit. The electro-magnetically excited fork vibrates (where the divergences are not too great) more quickly than if the vibrations were caused by elasticity alone. With equal amplitude the duration of vibrations increases slightly with the time the apparatus has been in action; and it decreases with increasing density of the surrounding air.—Electric phenomena occupy a large share of attention in this number, especially various actions of the spark. M. Peters, extending the researches begun by M. Antolik on "gliding" electric sparks, describes effects obtained by letting the spark glide on smoked paper brought near the machine on a glass table. The trace of the flash showed three different parts, each about a third of the whole length. In the *positive third* were numerous branchings outwards from a middle part, which consisted of a succession of parallel dark and bright strips (the darkest in the middle); the *negative third* showed no branchings, and the parallel strips were in reverse order; the *middle third* was distinguished by a greater width and brightness. M. Peters seeks to account for these phenomena. In another note he points out some differences between spark-forms from large inductors and those from the Holtz machine.—A paper by MM. Mach and Wosyka, also suggested by Antolik's experiments, furnishes reason for thinking that the soot figures produced are due to air motions, and especially sound motions.—Again, M. Riess gives an account of the phenomenon of weak electric sparks (as he called them), which differ from the ordinary strong sparks in form, light, sound, and other properties. A mode of producing them was formerly described. He observes that the greater length of the negative electrode has no essential connection with their production, and that, in regard not only to length, but to light and sound, they are independent of the composition of the circuit in which they occur.—Some striking new light phenomena of electricity are also described by M. Holtz.—In a note on the dielectric constants of liquids, M. Silow furnishes experimental proof of a proposition of Helmholtz with regard to attraction of two electric masses situated in an insulating medium, and a valuable paper by M. Herwig treats of the magnetisability of cylindrical iron pipes in different directions; he considers that in addition to the forces hitherto taken into account, there are further molecular magnetic forces which are of the greatest importance. These act within a magnetic line in the direction of the entire magnetisation, and in interrupted portions of a magnetic line in the contrary direction.—MM. Hildebrand and Norton endeavour to fill up some gaps in our knowledge of the properties of metallic cerium, lanthanum, and didymium; having obtained these elements by the help of the electric current, according to Bunsen's method, in quantities of nearly fifty grammes.—A note on impact machines is contributed by M. Sedlacek.

### SOCIETIES AND ACADEMIES

LONDON

Geological Society, Feb. 18.—Annual General Meeting.—John Evans, F.R.S. president, in the chair.—The Secretary read the reports of the Council and of the Library and Museum Committee for the year 1875. The position of the Society was

described as very satisfactory, although owing to various extraordinary expenses, the expenditure of the year was considerably in excess of its income. The Society was stated to be in a prosperous state, and the increase in the number of Fellows to be greater than in any previous year. The report also referred to the bequest by the late Sir Charles Lyell of the die of a medal and of the sum of 2,000*l.*, a bronze copy of the former and the interest of the latter to be given annually or from time to time by the Council as a mark of honorary distinction to some person or persons who shall be regarded as having aided the progress of Geological Science. It was also announced that Dr. Bigsby, F.R.S., has offered to found a bronze medal to be given in alternate years as an incentive to the study of Geology. The President then presented the Wollaston Gold Medal to Professor Huxley, F.R.S.; the balance of the proceeds of the Wollaston Donation Fund to Mr. J. Gwyn Jeffreys, for transmission to Professor Giuseppe Seguenza, of Messina, F.C.G.S.; the Murchison Medal to Professor Ramsay for transmission to Mr. A. R. C. Selwyn, F.R.S.; the balance of the Murchison Geological Fund to Professor Ramsay for transmission to Mr. James Croll; and the first Lyell Medal and the entire proceeds of the Fund to Professor Morris, F.C.S. The President then proceeded to read his anniversary address, an abstract of which we give on another page. The ballot for the Council and Officers was taken, and the following were duly elected for the ensuing year:—President: Prof. P. Martin Duncan, F.R.S. Vice-Presidents: Sir P. de M. Grey Egerton, Bart. F.R.S.; R. A. C. Godwin-Austen, F.R.S.; J. W. Hulke, F.R.S.; Prof. A. C. Ramsay, F.R.S. Secretaries: David Forbes, F.R.S.; Rev. T. Wiltshire. Foreign Secretary: Warington W. Smyth, F.R.S. Treasurer: J. Gwyn Jeffreys, F.R.S. Council: H. Bauerman; Rev. T. G. Bonney; W. Carruthers, F.R.S.; Frederick Drew; Prof. P. Martin Duncan, F.R.S.; Sir P. de M. Grey Egerton, Bart., F.R.S.; R. Etheridge, F.R.S.; John Evans, F.R.S.; David Forbes, F.R.S.; R. A. C. Godwin-Austen, F.R.S.; Henry Hicks; J. W. Hulke, F.R.S.; J. Gwyn Jeffreys, F.R.S.; Prof. T. Rupert Jones, F.R.S.; J. W. Judd; Prof. J. Morris; Prof. A. C. Ramsay, F.R.S.; Samuel Sharp, F.S.A.; Warington W. Smyth, F.R.S.; Admiral T. A. B. Spratt, F.R.S.; W. Whitaker; Rev. T. Wiltshire, F.L.S.; Henry Woodward, F.R.S.

Linnean Society, Feb. 17.—J. Gwyn Jeffreys, F.R.S., vice-president, in the chair.—Dr. D. D. Cunningham, Mr. W. C. Tuely, Mr. C. M. Wakefield, and Mr. C. F. White were elected Fellows of the Society.—“Additional observations on Ants,” by Sir John Lubbock, Bart. In this paper Sir John communicated some further experiments in continuation of those contained in his last memoir. As regards the cases in which when an ant has found a store of food, other ants make their way to it, he commenced by referring to some of his recent observations. To the edge of a board communicating with the nest he fastened three parallel strips of paper about a foot long (G, H, and I). One of these (G) led to a shallow glass tray containing a number of larvæ. The object of this was to ascertain how many ants would find the larvæ for themselves under such circumstances, and as a matter of fact none did so. On the middle strip (H), near the centre, and at right angles with it he placed two strips of paper 2 inches long, one (K) leading to another shallow tray containing larvæ (F), while the other (L) rested on the third strip of paper (I). He then took an ant (*F. nigra*), marked her, and put her on the tray F. She immediately took a larva, and went away to the nest along the strip of paper H. Now it is obvious that by always causing the marked ant to cross from the strip of paper, H, to the larvæ over a particular bridge of paper, K, and if whenever a stranger came, the paper bridges, K and L, were reversed, it would be shown whether the other ants who came to the larvæ had had the direction and position explained to them. In such a case they would go right notwithstanding the interchange of the paper bridges: but if they found their way by tracking the footsteps of the first ant, they would pass over the paper bridge K, and thus be led away from the larvæ to the strip of paper I. The result was that out of 79 strange ants which came up to the point at which the paper bridges diverged, 24 went straight along the strip of paper, H took the right bridge to the larvæ, while 44 were misled and went over the paper bridge K away from the larvæ to the strip of paper I. He then slightly altered the arrangement, transfixing one end of the two paper bridges by a pin, and so fastening them by one end to the strip of paper H, the other ends free, that each of them could

be turned either to the larvæ or to an empty glass tray. When the marked ant came he turned one paper bridge, K, to the larvæ, the other, L, to the empty tray; while whenever any other ant came he turned the bridges, so that K led to the empty tray and L to the larvæ. Under these circumstances, seventeen ants which came along the strip of paper H, without a single exception, went over the bridge K to the empty tray. He then varied the experiment by leaving the paper bridge K loose as at first; but instead of having a separate bridge L, he cut the strip of paper H into two pieces, H' and H". Then when a strange ant was coming, he rubbed his finger two or three times over the bridge K, so as to remove or at least confuse the scent. As soon as the ant had passed over the first part, H', of the strip of paper H, and had arrived on the part H", he took up the piece H' and placed it where the paper bridge L had been in the previous experiments, *i.e.* so as to connect the end of H with the empty glass tray. By this arrangement the bridge K was left in its place, and, on the other hand, there was a bridge which the marked ant had crossed and recrossed as often as K, but which led away from the larvæ. Under these circumstances, out of forty-one ants which found their way to the end of the strip H, and within two inches of the larvæ, fourteen only passed over the bridge K to the larvæ, while twenty-seven went over H' to the empty tray. Taking these observations altogether, out of 150 ants which came to the end of the strip of paper H, and thus within two inches of the larvæ, only twenty-one took then the right turn and arrived at their destination. These experiments therefore certainly seem to show that when ants flock to a treasure of food which one of them has discovered, they either accompany one another or else track it out by scent. The fact, therefore, is by no means an evidence of any high intelligence, or any complex system of communication, but is merely an instance of instinct, little higher than that which is found in other social animals. On the other hand, that some higher power of communication does exist, seems, however, to be obvious from some of the facts recorded in Sir John's previous paper. In the latter part of his present paper the author narrated a variety of experiments on the senses of ants, and on their power of recognising friends. A lively discussion followed the reading of the paper, in which Messrs. Lowne, Romanes, Mivart, and McLachlan, &c., took part.—Dr. Cobbold gave a notice of and exhibited several specimens of the new human fluke discovered by Prof. J. F. P. McConnell, of Calcutta. This parasite was first described by Dr. McConnell in the *Lancet*, Aug. 21, 1875. Prof. Leuckart, of Leipsic, unaware that the species had been already named, *Distoma sinense*, proposed the name *D. spatulatum* for it, which thus sinks into a synonym. Dr. Cobbold pointed out how the transparency of the specimens permitted all the internal organs to be well seen, and thus their structure could not readily be confounded with any other known species. The Entozoa found by Dr. Kerr, of Canton, and described by Prof. Leidy, did not belong to the above species, but to the great human fluke (*Distoma crassum*) discovered by Prof. Busk. Details of this last-named parasite have just been published in the Society's Journal.—A paper was read by Dr. John Anderson “On the cloacal bladders, and on the peritoneal canals in Chelonia.” The former seem first to have been described by Bojanus in *Emys europæa*, but since have received sparse attention. Dr. Anderson has ascertained their presence in a number of Asiatic genera and species, though they do not occur in others, *Testudo*, *Trionyx*, &c., to wit. He suggests these organs may be related to the habits of life, as it appears they are confined to those animals semi-terrestrial and semi-aquatic in habit, the true land and essentially water-living Chelonians being unprovided with them. Although known that some Chelonia draw in and eject water from the cloaca, the precise functions of the pouches in question have not been clearly determined.—The peritoneal canals have received elucidation from Cuvier, Is. Geoffroy, and Martin, but as to their relations, functions, and homology, Dr. Anderson is at variance with these savans. Basing his views on experimental injection and otherwise, he regards them as not connected with the generative functions, but rather agrees with Dumeril and Bibron as to their being accessory and subordinate to transpiration. He believes they have a distinct origin from the Mullerian ducts, and are homologous with the abdominal pore of Selachians and Ganoids.—The chairman called attention to a letter from the Director of the South Kensington Museum, in which the Committee of Council of Education desire the co-operation of the President and Fellows of the Linnean Society toward furnishing objects on loan for the forthcoming Exhibition of Scientific Apparatus.

Anthropological Institute, Feb. 22.—Mr. J. Park Harrison, treasurer, in the chair.—The Director, Mr. E. W. Braybrook, read a paper by the Rev. John Earle, M.A., on the Ethnography of Scotland. The author alludes to the great similarity in the physiognomy of the Norwegians and the Scotch as exhibited in photographic portraits, the likeness between the two peoples having also struck Dr. Beddoe. The conquest of the northern parts of Scotland, and especially Caithness, (Icelandic Kata-ness=ship promontory) is celebrated in the Sagas; and the author believed that the "harrying west" of the Danes along the eastern coast of Great Britain extended at least as far as the Firth of Forth. Vigfusson's Icelandic Dictionary supplies materials to illustrate numerous striking features in the Scottish language and the Norsk, e.g. bairn, carline, eldine, ettle, fey, (make); gar, greet, (to weep); speer, firth, &c. The Danish and Norsk districts in Scotland are the meeting ground of the great and divergent branches of the Gothic family—the Teutonic and the Scandinavian. In the Scottish language the Norsk element is almost undiluted with Saxon, and we gain from it Ethnological evidence, which recorded history does not distinctly afford. An analysis of the language Mr. Earle believes would bring out additional proofs that it is the permanent expression of the overlapping of the races above alluded to.

## BERLIN

German Chemical Society, Feb. 14.—A. W. Hofmann, president, in the chair.—E. Paterno and G. Briosi made preliminary communications on hesperidine obtained from oranges; 1,000 oranges yield less than 150 grains of the pure substance.—A. Ladenburg has found that isomeric diamines are acted upon by nitrous acid in very different ways. Parametatoluyliendiamine yields a well crystallised body  $C_7H_7N_3$ , amidoazotoluylene.—T. v. d. Hoff finds that succinic acid obtained in reducing malic acid with HI is optically inactive.—V. Wartha has discovered indigo in commercial litmus.—P. Weselsky described a reaction of phloroglucine. Mixed with nitrate of toluidine and nitrite of potassium it yields a precipitate of the colour of cinnabar.—A. Claus has found that the body until lately known as crotonchloral when treated with cyanide of potassium, yields not only chlorocrotonic acid  $C_3H_4ClCO_2H$ , but also a bibasic acid  $C_3H_4(CO_2H)_2$  and tricarballic  $C_3H_5(CO_2H)_3$ .—The same chemist described combinations of sulfo-urea with bichloride of mercury, and with oxalic acid.—R. Hasevleors, in using Deacon's chlorine-apparatus has remarked that the amount of HCl decomposed, sunk within six weeks from 80 to 2 per cent. He found the hydrochloric acid passing through the apparatus to be contaminated with sulphuric acid, and believes this to be the reason of the deterioration of the process. Sulphuric acid, so he believes, is decomposed into sulphurous acid, and oxygen and the sulphurous acid is reoxidised by retransforming the chlorine into hydrochloric acid:—

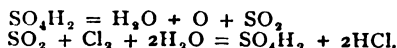

A support of this view is found in the fact that manufacturers that take great care in introducing hydrochloric free from sulphuric acid, are able to use the process for a comparatively longer period.—M. Neneky, who by the action of formic and acetic acids on guanidine obtained formo-guanamine  $C_2N_3H_5$ , and aceto-guanamine  $C_2N_3H_7$ , has also obtained two isomeric bases  $C_6N_5H_{11}$  by the action on guanidine on butyric and isobutyric acids. Aceto-guanamine, by taking up one or two molecules of water under the influence of potash, respectively yields guanide  $C_4N_4H_8O$ ; guanamide  $C_4N_3H_8O_2$ . By oxidation it yields cyanuric acid  $C_3N_3H_3O_3$ .—E. Bandrowsky, treating guanidine with valeric acid and caproic acid, obtained the corresponding guanamines,  $C_7N_5H_{13}$  and  $C_8N_5H_{15}$ .

## PARIS

Academy of Sciences, Feb. 14.—Vice-Admiral Paris in the chair.—The deaths of MM. Andral and Seguiet were announced.—The following papers were read:—On the ethers of hydracids, by M. Berthelot.—On the formation of amides, by M. Berthelot.—On hyposulphite of potash, by M. Berthelot.—Memoir on the approximation of functions of very large numbers and on an extensive class of developments in series (second part), by M. Darboux.—Vibrations of a homogeneous solid in equilibrium of temperature, by M. Felix Lucas.—On the movements of the heart when it is submitted to artificial

excitations, by M. Marey. The results obtained show that the heart is refractory to excitation during the greater part of a systolic phase. The systole produced (by excitation) is greater the longer its interval from the spontaneous systole which precedes it. After each systole produced, there is a compensating repose which restores the temporarily altered rhythm of the heart. This is important as confirming a law the author believes he has established, viz., that the work of the heart tends to remain constant.—On deviations from the laws relating to gases, by M. Mendéleeff.—On isomeric rosanilines, by M. Rosenstiehl. There are three of these, one derived from 1 molecule of aniline and 2 molecules of toluidine; another, 1 of aniline and 2 of pseudo-toluidine; the third, 1 of aniline, 1 of toluidine, and 1 of pseudo-toluidine; the latter constitutes, for the most part, commercial fuchsine.—On the optical activity of the reducing sugar contained in commercial products, by M. V. Aimé Girard and Laborde.—On a new element in the determination of chimi-calories, by M. Mauméné. Very various liquids undergo a molecular alteration (readily revealed by chemical action) without their nature being changed; the purely physical influence of heat gives them a sort of temper (température) during which their chemical actions produce extraordinary numbers of chimi-calories. Olive oil recently heated to about 300° behaves no longer like its former self when treated with hot acid, but it is not perceptibly altered in colour, odour, or density.—On a new acid pre-existing in the fresh milk of mares, by M. Duval. It appears to be distinct from hippuric acid, and the author proposes to call it *equinic acid*.—On the aptitude of oysters for reproduction from the first year, by M. Gerbe. Observation shows this to be a fact. Among these precocious mothers there are some whose shell, in transverse diameter, measures hardly 25 mm. Hence the prosperity of the reproducing portion of a natural oyster bed, does not depend only on the presence of large oysters. The quantity of eggs, indeed, is generally in proportion to the size of the oyster. Many oysters, especially the young, propagate twice in the season, under favourable conditions. The laying of eggs occurs at long intervals, possibly corresponding to lunar phases.—Reply to a note of M. Arm. Gantier, relative to the rôle of carbonic acid in the coagulation of blood, by MM. Mathieu and Urbain.—Description of the diplometer, by M. Landou. This is an instrument for measuring the diameter of an object at a distance and independently of its movements.—On the origin and mode of generation of atmospheric whirlwinds, and on the unity of direction of their gyratory motion, by M. Cousté. The whole mechanism of whirling movements in the atmosphere depends on two causes, gravity and heat; the weight of the air drives vertically from below upwards the less dense water-vapour which the heat has produced; and further, the weight of the air causes this gas to be precipitated (in horizontal, or at least inclined directions into the vacuum which the vapour tends to leave behind it in rising.

## CONTENTS

	PAGE
THE GOVERNMENT SCHEME OF UNIVERSITY REFORM . . . . .	341
LEGISLATION REGARDING VIVISECTION . . . . .	342
MISS BUCKLEY'S HISTORY OF NATURAL SCIENCE . . . . .	343
HASSALL ON FOOD. By T. . . . .	345
LETTERS TO THE EDITOR:—	
Prof. Tyndall on Germs.—INQUIRER . . . . .	347
The Mechanical Action of Light.—GEORGE HICKS . . . . .	347
Metachromism and Allied Changes.—W. M. FLINDERS PETRIE . . . . .	347
Seasonal Order of Colour in Flowers.—Prof. W. T. THISELTON DYER . . . . .	347
Rainbow Projected on Blue Sky.—WILLIAM F. DENNING . . . . .	348
OUR ASTRONOMICAL COLUMN:—	
Olber's Comet of 1815 . . . . .	348
Minor Planet, No. 160 . . . . .	349
The Binary Star $\alpha$ Leonis . . . . .	349
SCIENCE AND ART IN IRELAND . . . . .	349
THE LOAN EXHIBITION OF SCIENTIFIC APPARATUS . . . . .	349
HUNTERIAN LECTURES ON THE RELATION OF EXTINCT TO EXISTING MAMMALIA, III. By Prof. FLOWER, F.R.S. . . . .	350
THE FIRST GENERAL GEOLOGICAL MAP OF AUSTRALIA . . . . .	351
PHYSICAL SCIENCE IN SCHOOLS. By T. N. HUTCHINSON; JAMES M. WILSON . . . . .	353
ANNIVERSARY ADDRESS OF THE PRESIDENT OF THE ROYAL GEOLOGICAL SOCIETY, JOHN EVANS, F.R.S. . . . .	354
NOTES . . . . .	356
SCIENTIFIC SERIALS . . . . .	356
SOCIETIES AND ACADEMIES . . . . .	358



THURSDAY, MARCH 9, 1876

## CAROLINE HERSCHEL

*Memoir and Correspondence of Caroline Herschel.* By Mrs. John Herschel. (London: John Murray, 1876.)

ASTRONOMY may justly claim to be one of the most comprehensive branches of human knowledge, not merely from the immeasurable extent of the region which it undertakes to investigate, but from its embracing in a common boundary, and directing towards a common end, mental processes and lines of study which otherwise would have found but little ground for convergence and combination. It is, perhaps, not generally understood how varied are the courses, or how distinct the attainments, of those who are comprehended under the general title of "astronomers," or how strong, more especially, is the demarcation between the pursuit of theory and the practice of observation. Very different are the requirements of Greenwich and Parsonstown. The collection of facts, and the investigation of the laws which are gathered from those facts, are entirely distinct processes, and though the qualifications demanded separately for each have occasionally been found in combination, yet more frequently they have existed in individuals who have had little in common besides the general end of their pursuit. Laplace or Clairaut would have exhibited but little aptitude for wielding the instruments of Slough, and many an eye that has rested with the liveliest interest on the magnificence of the lunar scenery, or the mysterious glories of those regions where the great Creator has "sowed with stars the heaven thick as a field," would pore in vain on a page of intricate analytical formulæ, or perhaps turn from it with a feeling of positive dislike and annoyance.

At the head of the observing class in his own day everyone will recognise the name of William Herschel. He did not, indeed, stand as prominently alone as was formerly supposed in the adopted country which was so justly proud of him, for he had left a worthy rival in his native land, where Schröter, armed at first with his opponent's instruments, and afterwards with those of Schrader of Kiel, was doing most earnest and faithful work in his own way. On the moon, indeed, and on Venus and some of the planetoids, Schröter not only held his own, but gained an advantage which has been more fully appreciated as years have passed away. But in the starry heavens, where Schröter was inefficient, Herschel was supreme; and in his hands sidereal and nebular astronomy started out at once into a prominence which it has since fully maintained. Before his time some forty double stars had been casually noticed; his catalogues comprised about 700; and the host of nebulae grew in far higher proportion, from 103 in Messier's list, to 2,500, a great part of them most delicate and difficult objects. Nor was our own system without its corresponding enlargement, in a new and important planet at an unsuspected distance, with a train of most minute attendants, to say nothing of two additional satellites of Saturn: nor had the solar phenomena ever been so fully investigated or so clearly described. No wonder that the records of

English science should adorn the name of Herschel with a pre-eminent glory—

"Gloria sideribus quam convenit esse coævam,  
Et tantum cœlo commoriente mori."

But other talents, and those of a high order, were combined in the case of this illustrious man. Inheriting a family gift, he had been originally a musician of considerable eminence—not only the organist of a fashionable chapel in Bath, and sometimes giving thirty-five and thirty-eight lessons per week to lady-pupils, but rising above the ordinary level as a writer of good music. It is matter of great regret that much of his composition has been irrecoverably lost: but a portion seems to be still existing, and we earnestly hope may yet appear in a public form. It was, however, of more importance to one of the very first astronomers that he should also be one of the very first opticians of the age, and in Sir W. Herschel this was fully carried out. In him a consummate knowledge of practical optics aided the keen vision of the observer. Others had indeed attained great and perhaps equal perfection in the manufacture of reflecting telescopes. Those of the celebrated Short, though on the inferior Gregorian construction, were remarkable for their distinctness; nor had he shrunk from 12-inch apertures, or nominal powers, even in this case, of 100 per inch, though it may be feared that actual measurement would have considerably reduced their value. And as regards mere size, the French optician Noël, after many attempts, succeeded, in 1772, with a mirror of 2 feet, which, mounted as a Cassegrain, bore a power of 528, though with what distinctness does not appear, nor where the remains of this Colossus may be now. But the multitude of specula that Herschel had wrought—more than 400 of 7, 10, and 20-foot focus—before he succeeded to his satisfaction, and the wholly unprecedented effort that placed the 40-foot telescope at his command, merely constituted him the chief optician of his day; to this was added the special talent of acute and most persevering observation, which he possessed in very full development, and employed to the utmost, even to a very advanced age, and with a result exceeding all anticipation.

Any one, however, who has some practical acquaintance with the labour of observation with the larger class of telescopes, will readily perceive that such researches, especially when combined with such heavy and continuous optical work, could never have been accomplished alone. This must be eminently the case when far-stretching tracts of sky have to be explored for unknown objects; the distinct and equally important tasks of observing and recording are so incompatible as to be beyond the grasp of the most accomplished astronomer. Assistance must be had, and that no ordinary kind of assistance, but such as may really answer to its name—carelessness, or tardiness, or awkwardness being fatal in such a case to the idea of effectual aid. That Sir W. Herschel found in his sister Caroline such an assistant as materially contributed to his own success has long been familiarly known; but it has not been so generally understood how able was her co-operation, how laborious her night-watchings, how persevering her attention, how utterly unselfish in its absorbing and generous attachment her devotion to her brother's pursuits. It was to bring into due notice so uncommon a character, which

from its very constitution ever shunned the exposure of publicity, that the book now lying before us has been written. We will not predict for this memoir a brilliant but ephemeral popularity; it may be thought deficient in attractiveness by general and unscientific readers; and perhaps a very natural partiality may have led to the introduction of a good deal of unimportant and rather heavy detail; but it is a book full of interest for those on whose account we may suppose it to have been especially written; whose scientific tastes and leanings, particularly if connected with astronomical or optical pursuits, will awaken in them a ready sympathy with the difficulties, the labours, and the triumphs of those with whose domestic habits and inner life they are thus brought into familiar contact, and for the first time; for, as the authoress remarks, no good biography of Sir W. Herschel exists—a reproach, surely, to our astronomical literature.

As to the interest excited by the portrait of her own very remarkable and original character, exhibited in her own correspondence; how the talent, hidden during a neglected and almost menial youth—for she speaks of having tasted the drudgery of the scullery—was developed and cultivated by the brother who fully appreciated her abilities; how her unwearied industry and diligence could only be surpassed, if they were surpassed, by his own; how she gladly did his behests as a public singer; how they were for many years inseparable companions; how she attended upon him during the tedious polishing of his mirrors, often feeding him bit by bit when he was unable to leave off for meals, in one such instance for sixteen consecutive hours; how she prepared his astronomical work, watched with him through nights when the ink was frozen by her side, and calculated for him in days when others would have sought repose or amusement; as to all these evidences of talent and skill and patience, dedicated simply and humbly, and with the most complete disregard of health and even of personal safety, and utter abnegation of every selfish thought and feeling, to her dear brother's service, we would refer our readers to the book itself. In the portraiture of a very uncommon character they will assuredly not be disappointed.

But it contains also much interesting detail as to that brother's life, and draws a picture of his proceedings in many respects unlike what we, for our own part, had been used to suppose. Very little, we find, did he enjoy of that "retired leisure" which such a man should have had at command. His privacy is exhibited as mercilessly interrupted by the natural, but inconsiderate, curiosity of visitors. The munificence of his royal patron was interfered with very unjustifiably by "shabby, mean-spirited advisers." The labour and anxiety connected with the 4-foot mirrors, on which at one time no less than twenty-four men in two relays were kept polishing day and night, while he personally superintended the whole, and never allowed himself to sit down to table, told seriously on his health, and once caused his life to be for some time despaired of; and speaking of his latter days his sister remarks, "we have all had the grief to see how every nerve of the dear man had been unstrung by over-exertion; and that a farther attempt at leaving the work complete became impossible." Much of explanatory and connecting material would be required for such a memoir as is due to William Herschel; but what is here given is espe-

cially characteristic and valuable. We are led, while on the subject, to introduce a few anecdotes long ago communicated to us by one who in youth knew Sir William well, and which, we believe, are comparatively unknown. His regular after-dinner toast, according to the custom of those days, was "Success to astronomy." There was a vein of humour in his disposition, as is frequently seen combined with eminent talent; and on one occasion he sent his young companion upstairs to his wife's room to look at an extraordinary star, on which a telescope, which was called hers, was pointed. He did so, and found it was the figure of a star, fastened to, or represented in, the wall of Windsor Castle. When he had discovered the planet formerly called by his name, Sir Joseph Banks and other Fellows of the Royal Society attempted, to no purpose, to catch a sight of it. Finding this to be the case, he had a portable tube constructed of silk, packed it up with his mirrors, travelled to London, appointed a meeting with the doubters on the roof of Somerset House, and there exhibited to them the object which they had sought in vain; on which Sir Joseph took off his hat and made him a bow, an example which was followed by the rest of the company. It is greatly to be regretted that the biography of his illustrious parent was never taken in hand by one so especially qualified to fulfil the task as his equally gifted and equally celebrated son, some of whose beautiful letters, addressed to his aunt after her return to Hanover, form a great attraction in the volume of her Memoirs.<sup>1</sup> But we yet hope that the task may be accomplished, and that his most valuable papers, now stowed away, as it were, in the "Philosophical Transactions," may be published in a collected and more accessible form; and thus a monument raised to his well-earned fame, more permanent, at least as far as optics are concerned, than the works of his hands. For these, unfortunately, were of a perishable nature, owing to the defective character of the material which alone he could make subservient to his purpose. No specimen of the alloy of tin and copper employed can be expected to remain untarnished for any considerable time; and the restoration of its brilliancy can only be attained by the destruction of its original figure: if rendered by extraordinary skill as perfect as before, it will still not be the unaltered result of the great master's hand. We do not know whether a single mirror of Herschel's may now be remaining untarnished and untouched: an especially sad fate, we are reluctant to add, has befallen the much-valued 6-inch mirror which Caroline Herschel used so frequently, and bequeathed to the Royal Astronomical Society as an especially safe depositary for so precious a relic. Tarnished by a singular accident while in the temporary care of other parties, it was, we understand, attempted to be repolished without the Society's knowledge; but so unskillfully was this done, that it has not only lost its original figure, but now possesses none of any value at all; the very tube had to be patched to accommodate the lengthened focus; and the donor would hardly recognise her favourite instrument again.

One cannot but regret that such wonderful skill and

<sup>1</sup> There is a singular error in one of these letters (p. 288) describing the re-discovery of Enceladus, where *below* has been printed for *below*. At p. 317 the word *focus*, which has been introduced as a correction or explanation in one of Miss Herschel's letters, is a mistake.

labour should have been expended upon a material so little capable of doing it justice, when the employment of silvered glass would have given entire permanency to the beautiful curves which Herschel knew how to bestow. But that invention was reserved for Foucault at a later day. Had Sir W. Herschel known of it, the 4-foot mirror would not only have been of far easier workmanship, but would still be ready for a comparison of its merits, as to which there has been much discussion, with the productions of modern days. This, however, is rather matter of curiosity than of real use. It is no detraction from Herschel's well-deserved reputation to suppose that the four MS. volumes which he left behind, containing all the details of his experiments and processes, would be found to add little to the knowledge now possessed by our most successful reflector makers. As to metal-working, difficulties equal, and greater, have been encountered and vanquished by Lassell and the Earl of Rosse: as to silvered glass, Steinheil indeed has abandoned the undertaking, and of the quality of the great French reflectors we know little on this side of the Channel; but the near approach to perfection in the hands of English artificers, and especially of With (who, we are glad to hear, is contemplating an increase in his apertures), leaves no room for regret on that score. Never, probably, were reflecting telescopes more faultless than now; never could they challenge so fearlessly a comparison with the great achromatics of the day. May astronomers be found who shall be capable of working them to their fullest capacity and for their noblest end. But whatever future advances may be in store for us, whether in the optician's or the observer's hands, nothing in either respect will ever detract from the honour of Sir William Herschel, or of her whose memoirs we have now been perusing with so much interest. Her brother's place indeed might more easily be supplied: one equal to herself, as the most efficient, unwearied, self-denying, devoted of assistants we can scarcely expect to see again.

T. W. WEBB

#### MORESBY'S "NEW GUINEA AND POLYNESIA"

*Discoveries and Surveys in New Guinea and the D'Entrecasteaux Islands. A Cruise in Polynesia and Visits to the Pearl-shelling Stations in Torres Straits by H.M.S. Basilisk. By Capt. John Moresby, R.N. With Maps and Illustrations. (London: John Murray, 1876.)*

NEW Guinea has been much before the public recently. As our readers know it has been the field of a number of small exploring expeditions, the somewhat fragmentary results of which have only served to whet our appetite for more information. Most of these expeditions, under such men as Meyer, Beccari, D'Albertis, and Miklucho Maclay, have been occupied with the western part of the island, our knowledge of the eastern and larger half having been practically almost a blank. Capt. Lawson's wonderful work (*NATURE*, vol. xii. p. 83) with its abundance of astounding statements can scarcely be regarded as a contribution to our knowledge of the island, though it has made us still more anxious to know the truth about a land which, even in the present advanced state of geographical knowledge, seems to have

unknown wonders to reveal. Quite recently we heard of the discovery of a large river debouching on the south coast, and of a gigantic bird, and the signs of an equally gigantic quadruped having been seen. Only last week we were able to give some news of the indefatigable D'Albertis. Then the Australian colonists are casting longing eyes on the fertile island, and a proposed colonising expedition recently made a considerable stir in this country. All these circumstances have made us anxious to obtain trustworthy information concerning a country of three times the area of England, Wales, and Scotland combined.

Capt. Moresby's work is one of the most important contributions which have been made to our knowledge of the geography of New Guinea. It records in a simple and direct manner the results of four years of thoroughly painstaking and careful work, and, as far as it goes, may be relied on as perfectly trustworthy and accurate. Capt. Moresby does not pretend to give any information as to the natural history of the islands visited, his attention having been directed to their geographical and physical features, their industrial products, and the characteristics of the natives. On all these points valuable and substantial information will be found in the extremely interesting work before us. The time during which the *Basilisk* was at work in Polynesia and New Guinea was between the beginning of 1871 and the end of 1874.

The part of New Guinea to which Capt. Moresby mainly devoted his attention was the coast of that south-eastern projection, about most of which absolutely nothing certain was known, and the islands lying off it. Commencing at the bay shut in by Yule Island, some careful survey work was done, and two considerable rivers explored as far as obstructions would permit. From this point south-eastward the coast was diligently examined, and its main features will be found plotted in the map which accompanies the volume. The greater part of the length of the coast is fringed with reefs, which are the great obstruction to navigation in that part of the world. At several points along the coast more minute explorations were made of various inlets, and one or two other rivers were opened out leading into the interior. Coming to the south-east coast, Capt. Moresby definitely solved the problem as to its shape. The island ends in a wide fork, from which the north coast sweeps in a series of magnificent bays in a north-west direction, the outline of which, to a distance of between three and four hundred miles, Capt. Moresby has had the honour of laying down for the first time. Around the south-east termination of the island are clustered hundreds of beautiful islands ranging in size from a tiny speck up to the three considerable islands which are named after D'Entrecasteaux, and which until Capt. Moresby's visit were vaguely and inaccurately located; indeed it was not certainly known that they were islands at all. The south-eastern prong of the terminating fork is continued in three islands—Hayter, Basilisk, and Moresby—and all the islands of any size seem to support a large population of tractable and intelligent savages. While part of the south coast surveyed by the *Basilisk* is covered with unhealthy mangrove swamp, a large portion of it is a healthy and beautiful coral beach backed by tree-covered hills. Towards the south-east the coast gets

mountainous, a range of mountains running north-west through the centre of the island, having its culmination in Mt. Owen Stanley, 13,205 feet. The three islands mentioned above, as also the D'Entrecasteaux Islands, contain mountains of considerable altitude, and along a great portion of the north coast densely wooded mountains come right down to the coast. The north coast is marked by an almost entire absence of the reefs which are so characteristic of the south coast. Some minute survey work was done among the islands in the south-east, with the result that a passage has been found which will shorten most materially the voyage from Australia to China. Another important service done by Capt. Moresby to navigation was the accurate survey of the channel in Torres Straits.

Captain Moresby landed on many points of the coast surveyed as well as on the islands, and invariably he and his officers and men became the best of friends with the natives. Captain Moresby's skill in managing savages cannot be surpassed. By tact and patience he in almost every instance managed to obtain a cordial welcome from the natives not only of New Guinea, but of the many islands which he visited to the east of Australia. Not in a single instance was it found necessary to take life, and we would recommend all who have to deal with uncivilised people to study Capt. Moresby's tactics. The natives of the part of New Guinea visited Capt. Moresby speaks of as belonging to the Malay type, lighter coloured than the Papuans, and with the characteristic and elaborately done-up long frizzled hair. They are probably a modification of the genuine Papuan, possibly in the direction of the Malay type, though more probably the modification may be the result of circumstances or of mixture with or gradation into a more distinctly Polynesian type. They are well-made, gentle in demeanour, and stand comparatively high in the scale of uncivilised men, both in intelligence and in art. They are evidently comfortable and happy, living in good houses built on piles, and having abundance at hand to supply all their wants. Many of them seemed not to possess the bow—the spear, club, and hatchet being the chief weapons on the south coast. The officers and crew of the *Basilisk* brought away quite a shipload of weapons, utensils, and ornaments, some of them of really exquisite workmanship. The use of the metals is quite unknown among most of the people visited, who in many cases turned up their noses at the hoop-iron with which the ship was so abundantly supplied, and who with difficulty could be made to give the superiority of the iron hatchet. Capt. Moresby gives many valuable notes on these interesting people, which we commend to the notice of ethnologists. One very curious custom is referred to in the south-east, which, when first seen, roused the indignation of those on board the *Basilisk*, but which Capt. Moresby wisely tolerated. A native, followed by a number of others, rushed on board bearing a dog, which, before anyone could interfere, he caught by the legs and dashed out its brains on the deck. This was horribly shocking, but Capt. Moresby rightly surmised that it was meant as a pledge of friendship. Indeed, the poor natives were evidently utterly bewildered when the officer on duty bundled them out of the ship and threw the poor dog's body after them, and it was only on Capt. Moresby's

going on shore and professing friendship that they were quieted. Another method of friendly salutation is to squeeze the nose and the navel simultaneously with the fore-finger and thumb of each hand; the natives were quite ecstatic when Capt. Moresby and his men, with excellent tact, returned the grotesque salutation. This pleasant people extend all along the south and north coast visited, the black Papuans differing in many respects from the former, and seemingly quite untractable, not having been met with till about 148° E. on the north coast. Though Capt. Moresby does not profess to be either botanist or zoologist, and unfortunately none of his staff seem to have had the necessary qualifications, still naturalists will be able to glean some information from his notes as to the nature of the flora and fauna to be met with on the coast. We have referred to the signs which a recent expedition saw of some large quadruped living on the island; similar traces were found by the *Basilisk* expedition near the head of Collingwood Bay, the second large bay from the south-east, on the north coast of New Guinea. "Here Lieut. Smith observed the droppings of some large grass-eating animal in a spot where the bushes had been heavily trampled and broken. Our opinion was decided that a rhinoceros had haunted there; and we were much surprised, as the animal has never been believed to exist in New Guinea." This and other secrets of this interesting island cannot surely now remain long unrevealed.

We have referred at length to Capt. Moresby's account of his work in New Guinea, but the first half of the book contains a most interesting account of a cruise among the islands to the east and north-east of Australia, upwards of fifty of which were in this way visited. Almost everywhere was the *Basilisk* welcomed, and Capt. Moresby made excellent use of his opportunities in noticing the characteristics of the islands and the people, and in impressing upon the latter the desire of England to befriend them. In several places sad results were seen, and harrowing stories told of the visits of the Polynesian kidnappers, whose inhuman traffic Capt. Moresby set himself to put down. It seems doubtful whether some of the islands called at by the *Basilisk* have been visited by white men before. The natives were mostly fine-looking people, evidently allied to the gentle inhabitants of Southern New Guinea. On many of the islands white traders and missionaries are settled, in others the natives are still in their pristine and contented state. We assure both the physical geographer and the ethnologist that in this part of Capt. Moresby's work, they will find a very great deal to interest them.

The work altogether must be regarded as one of the most valuable recent contributions to geography. Capt. Moresby possesses many of the qualifications which go to make an explorer of the first rank, and he has the gift of telling his story in clear simple language, indulging in no theories, and filling every page with valuable information. In an Appendix he draws attention to the suitability of New Guinea for colonisation, and urges upon the imperial government, we think with justice, the annexation of it and all the neighbouring islands to the south and south-east. While portions of the island are evidently unsuitable for habitation by white men, a very large proportion of the country

would be found perfectly salubrious and productive in the highest degree. We cannot see the force of some of the arguments with which Capt. Moresby supports his plea for annexation. His strong attachment to the natives and his desire for their welfare we think mislead him as to how this is to be accomplished. If New Guinea is to be colonised by white men, all previous experience teaches us that the natives will inevitably suffer, will be demoralised, and ultimately extinguished. It is inexpressibly sad to think of such a fate overtaking these gentle and altogether superior natives of New Guinea; but how can it be helped, unless it is resolved to put a stop to the increase in the white portion of the world's population. We commend the Appendix to the notice of all interested in Australia, which already is beginning to feel itself overcrowded, and must sooner or later overflow, for, as is well known, the interior is a blank. If this country does not speedily annex New Guinea, some other country, with possibly less regard for the interests of the natives, certainly will. We hope at least that Capt. Moresby's work will be the means of giving a new stimulus to the exploration of this abundantly interesting island. Why don't the governments of the various Australian colonies combine to organise an expedition for its thorough exploration, with the countenance and assistance of the imperial government? With a man like Capt. Moresby at the head of such an expedition, how much might be accomplished.

#### OUR BOOK SHELF

*Sketches of British Insects. A Handbook for Beginners in the Study of Entomology.* By the Rev. W. Houghton, M.A., F.L.S. (London: Groombridge and Sons, 1875.)

THIS is an attractive little volume, suitable for a child's prize; it contains much useful and carefully selected information, accompanied by some excellent woodcuts, and six gorgeously coloured plates.<sup>1</sup> Although not wholly free from errors, most of them are happily confined to the chapter on Lepidoptera. It may not be amiss to point them out, as they are likely to mislead, and should be corrected in a subsequent edition.

It is doubtful whether the general reader will comprehend the author's statement that "there are no hermaphrodites in the class" of insects; the frequent occurrence of gynandromorphous specimens in collections being a seeming contradiction to this assertion.

The description of the oviposition of *Chrysopa* (pp. 62, 63) is not accurate. The insect, touching the surface of the plant-stem with her abdomen, draws out a thread of viscous matter, and by not at once excluding the egg attached thereto, gives it time to harden; it is *only by not removing her body*, or depositing the egg too soon, that the upright hair-like thread is produced.

In the chapter on Lepidoptera a number of statements are made, which (however seemingly true to the mere tyro in entomology) are perfectly erroneous: thus it is not true that butterflies ever have less than six legs, although the first pair are, in some families, aborted; butterflies cannot be separated from moths by any distinctions but those which serve to divide their families; for a butterfly has not always a pair of *club-shaped* antennæ, the antennæ of some

moths are distinctly clubbed. Although most butterflies carry the wings upright when in repose, the *Ageronia*, many of the *Erycinidæ* and *Hesperiidæ* settle with the wings flat and extended; some of the *Geometridous* moths on the other hand close them in an upright position over the back. The *Vanessæ* among the butterflies frequently fly by night, and are sometimes taken at sugar; whilst the *Castniidæ*, *Agaristidæ*, *Zyganidæ*, *Ægeriidæ*, many *Sphingidæ* and *Lithosiidæ*, some *Bombycidæ* and *Noctuidæ*, the *Uraniidæ*, some *Geometrina*, *Pyralidina*, *Tortricina*, and *Tineina* all fly by day.

The termination *inæ* should be used for sub-families; therefore it is incorrect to say that "the family *Papilionidæ* consists of two sub-families, the *Papilionidæ* and the *Pieridæ*."

The tails of the *Theclinae* are not a sufficient distinguishing character, since these appendages occur also in the British *L. beticus* and its allies.

The Camberwell-beauty has, of late years, been seen on the wing by most entomologists, and the manner in which the squeaking of *Acherontia atropos* is produced has been fully described in a previous volume of NATURE. The wings of the female Vapourer-moth, although very minute, are clearly distinguishable; this insect therefore cannot be said to be "entirely destitute of wings."

The female stag-beetle bites somewhat sharply, but the male has comparatively little power; it is frequently taken to school by mischievous boys to alarm their fellows, but we never knew of a case in which it caused actual pain.

*The Year Book of Facts in Science and the Arts for 1875.* Edited by C. W. Vincent. (London: Ward, Lock, and Tyler, 1876.)

THE present volume is a decided improvement on its predecessor, though it is yet far from being what we hope to see ere long—an annual record of science similar to the excellent American publication edited with so much ability by Mr. Baird. We are glad to observe that this year Mr. Vincent has embraced a wider range in his excerpts, though the newspaper reports of the papers read at the last British Association meeting seem to have been a little too heavily laid under contribution. But then one must remember what a godsend such reports must be to the editor of scientific scraps: two copies of each paper, a pair of scissors, and a gum-bottle, and the thing is done. It would, however, be an injustice to Mr. Vincent to leave our readers under the impression that this book is carelessly edited. Extracts from our own columns, the *Philosophical Magazine*, the *Comptes Rendus*, the *Chemical News*, the *Academy*, and other journals are largely made, and on the whole a wise discrimination and some care have been shown in the selection and arrangement of these scientific jottings. There are, at the same time, some striking omissions which ought hardly to have been passed over. No reference is made to Mr. Crookes's Radiometer and his experiments thereon, beyond a brief report of a discussion on the subject at the British Association. Nor is there any notice of the new system of quadruplex telegraphy, designed by Mr. Winter, nor of the largely increasing use of duplex telegraphy, owing to the valuable modification of that discovery—which really made the system a practical one—devised and carried out some time ago by Mr. W. H. Preece. We commend the editor to the columns of the *Telegraphic Journal* for information on these points. There are also other omissions of recent experimental researches, but as we have already said, this volume is not without its merits, and doubtless many will be glad to make use of the quantity of broken-up information it conveniently conveys. We presume Prof. Osborne, on p. 72, means Prof. Osborne-Reynolds.

<sup>1</sup> *Hesperiidæ* have also been taken at light.

<sup>1</sup> The plates are rather sticky, and consequently the tissue-paper occasionally adheres to them; this is, however, a matter for congratulation, as it subdues the excess of colour.

## LETTERS TO THE EDITOR

[The Editor does not hold himself responsible for opinions expressed by his correspondents. Neither can he undertake to return, or to correspond with the writers of, rejected manuscripts. No notice is taken of anonymous communications.]

## Professor von Siebold and the Freshwater Fishes of England

THE object of the present letter is to appeal to naturalists throughout the British Islands to assist Prof. von Siebold—the eminent zoologist of Munich—in his studies of the freshwater fishes of Europe. Prof. Siebold is preparing a new edition of his well-known work on that subject, and is exceedingly anxious to obtain specimens of some of our British freshwater fishes to compare with the specimens which he has collected from all parts of Europe. In spite of various attempts, he has, I am very sorry to have to say, failed to obtain specimens from English naturalists. I am sure that this can be only owing to the fact that he has not been able to make his wants known directly to those who could help him. I have not myself been able to do much in supplying the specimens of which he forwarded to me a list, but from the Thames at Oxford have sent him Dace, Bleak, Pope, Miller's Thumb, and Sticklebacks. The list to which I refer included the Graining and the Azurine fishes which have been obtained in or near Knowsley Park; and I have received a kind assurance from Lord Derby that efforts shall be made to procure specimens for Prof. Siebold. Specimens of these and of the Powan, the Pollan, the Gwynlad, and the Vendayce, are the chief desiderata which I am anxious to obtain for Prof. Siebold; his list also includes the Sharp-nosed and the Broad-nosed Eel.

If any naturalist who possesses specimens of these fish which he can spare for the purposes of scientific investigation, or who can by reason of local opportunity obtain such specimens, will forward them to me at University College, London, preserved in spirit, I will transmit them to Prof. Siebold, taking care that he shall know to whom he is indebted in each case.

A more difficult task, I am afraid, is that of procuring specimens of the Brine Shrimp, *Artemia salina*. Prof. Siebold has made an extensive study of specimens of *Artemia* and allied Branchiopoda from various European localities, and is anxious to compare English specimens with those from other localities. He wishes especially to obtain "gatherings" of these Crustacea in order to determine the absence, presence, and relative abundance of the male sex in different localities. Specimens from Lymington or from Guernsey would be very welcome.

I hope that through the columns of NATURE I may succeed in reaching those naturalists who, I am sure, are not few in number, who will be willing to contribute material for the valuable researches which Prof. Siebold has so long been carrying on.

E. RAY LANKESTER

March 5

## Seasonal Flower Distribution and the Radiometer Vagaries

ALTHOUGH apparently so dissimilar, there is an intimate connection between the seasonal order of colour in flowers and the seeming erratic behaviour of certain radiometers.

Whatever be the cause of the mechanical action of light which is now exciting so much attention, the kind of light remaining the same, the experiments show that different surfaces produce dissimilar effects, the results with pith discs applying to pith only and being different from those obtained with mica, which strictly apply to mica alone. This is due in all probability to the difference in inter-molecular conditions presented by the two substances. When these conditions are thoroughly understood and a proper margin allowed for experimental errors, the observations which seem now at variance will most likely be reconciled. To acquire the needed knowledge, it is my humble opinion that some modification of the present method will be required, because many of the comparative experiments which have been tried hitherto in the domain of radiant light and heat are open to the objection that heterogeneous bodies having been dealt with, a difference of chemical constitution has been introduced for which no allowance could be made. To obviate this in the present instance, and ascertain the result of such differences, would it not be well to employ the following typical mode of procedure:—

In preparing the radiometer, let the discs be dipped into melted

sulphur, or other convenient colour-changing body, and the completed apparatus inclosed in a jacket for the convenience of raising the temperature. A series of observations made at the normal temperature, when compared with a like series made at a high temperature, would doubtless reveal many interesting facts. There are many difficulties in the way which would take much experiment to overcome.

Now turn we to the flowers. The former question seems to depend probably upon the reflection of light, and the latter on absorption, the one being complementary to the other. I would here call the attention of your readers to the behaviour of inorganic coloured bodies when heated and to the laws of colour-change given in NATURE (vol. xiii. p. 298). There is here such an identity of relations as nearly to preclude the possibility of its being a mere coincidence. I shall speak more particularly of this in another note in a few days.

In reply to Mr. Rogers' query (p. 326), it may be remarked that *absorbed light* seems to be the active agent in vital work, e.g., it is the light absorbed by the retina which, as motion of some kind, is transmitted along the optic nerve. This being the case, it would seem highly probable that to exclude from a flower such light as it reflects would not affect it at all, although of course the only sure answer to such a query is experiment.

Feb. 28

WM. ACKROYD

## D-line Spectra

WITH reference to Prof. Stokes's courteous but rather theoretical explanation in NATURE, vol. xii. page 247 (which I have been prevented from acknowledging before), I would ask him or yourself for a practical explanation of the following simple experiment:—

1. If platinum wire be reddened from a constant source of heat, as that applied to it by means of a blowpipe and a candle, we find the D-line spectra indefinitely produced until incandescence takes place by *additional* heat, or, in other words, that their permanency is in direct proportion to the *bulk* of the wire used, and in inverse proportion to the amount of heat applied. We can therefore, by using a *thick* platinum wire and the ordinary flame of a blowpipe, produce D-line spectra as long as we like, or as long as the fuel lasts.

2. Now if this D-line producing flame be due to sodium, its action for a long period upon a reagent so sensitive to sodium as is *Boric Acid*, ought to give a reaction by which the presence of that alkali would be detected. Thus, if a pin's head speck of pure cobalt oxide be heated by a blowpipe in a bead of pure boric acid, it forms within it a *black ball* which the minutest trace of any *sodium* salt partially dissipates, causing a *pink* suffusion round the ball.

3. A boric acid bead fused upon the ring of a thin or ordinary platinum wire, which has previously been made incandescent by a blowpipe flame, *i.e.*, from which the D-line producing property has been previously removed, is clear, colourless, and refractive as a diamond; but if the same boric acid be fused upon a *thick* platinum wire with the same degree of heat, the bead is *opaline* and *almost opaque*; and this phenomenon seems evidently and only referable to the above-mentioned permanency of the D-line spectra produced in the latter case.

4. To settle this point, however, let us fuse a clear colourless bead of boric acid on an ordinary platinum wire, and screw that in a geometrical pen, along with, but a little *behind* (that is, *away* from the source of heat) a *thick* platinum wire, so that the D-line producing flame from the thick, hot wire, impinges constantly and for some time upon the clear boric acid bead; we find opacity produced as in the former case. Now, supposing sodium to be in this case, the producer of the D-line spectra, we ought to have, in the opalised boric acid, a tangible result of the effect of applying to it (according to Prof. Stokes) "free sodium," but, on heating in it, as before, a speck of cobalt oxide, there is *no* dissipation of any part of the resulting ball, nor the least pink suffusion, but, on the contrary, a reaction, decided indeed, but *almost exactly* the opposite of that caused by adding sodium to the bead in any proportion.

5. Let us now screw a platinum wire ring containing a boric acid bead with a cobalt-borate ball inside, into a geometrical pen behind another platinum ring containing a bead of some soda salt, and heat both together with a blowpipe, so that the orange flame from the latter impinges upon the former. Instead of opalescence, similar to that caused by the orange flame from the thick platinum (4), we find the viscid boric acid made *more*



*fluid and clear*, the cobalt borate ball partly dissipated, and, on cooling, the surface of the bead presenting a pink appearance, evidently caused by projected particles of soda, volatilised *per se*.

6. It would thus seem that the blowpipe is even a more delicate analytical weapon than the spectroscope, for it distinguishes between two flames exhibiting D-line spectra only, which spectrum analysis does not.

W. A. ROSS

March 6

The Screw-Propeller in Nature

Now that the question of the best form of the screw as a propeller has become of such importance it is interesting to note what Nature has done in this direction.

The seed of the ash (*Fraxinus excelsior*) is provided with a wing very delicately twisted, and, when the seed falls, the action of the air upon this screw-like wing causes it to revolve rapidly. The result is that the seed is kept suspended in the air for a comparatively long time, and is wafted by the slightest breeze to a considerable distance from the parent tree. I do not know that this peculiarity is referred to in any botanical work, but it very beautifully fulfils the object which characterises more completely the lighter-winged seeds, viz., the dispersion of the seed beyond the limits of the plant or tree which bears it.

I am not by any means sure that the screw on the ash seed will not by its own action, independently of any wind, work itself away, in its fall, from the perpendicular line. But, when the wind blows strongly—and it takes a strong wind to blow the seeds off at all—their range is very extensive.

The seeds hang stubbornly to the tree through the winter months, reserving themselves for the March gales, of which the wind-fertilising plants avail themselves so largely.

I should much like to know if any of your readers have observed this screw and studied its pitch, and it would be very remarkable should it prove that the pitch of this natural screw is the one which will give the most power to the propeller of a steamer.

The seeds of the maple and the sycamore have somewhat similar appendages, but the screw is, in neither case, so marked. If anyone, at this season, will throw up a stick at the seed clusters of ash, maple, or sycamore, he will find the seeds come fluttering to the ground like a cloud of butterflies and alighting quite as softly on the ground.

Feb. 15

ALFRED GEORGE RENSHAW

The Migration of Species

IN NATURE, vol. xii. p. 86, I read a communication signed "W. L. Distant," in which the writer states that sea-going ships were frequently visited by both birds and insects.

In confirmation of this fact, I can mention from my own observation two instances of birds visiting ships in which I was making the homeward voyage from the West Indies, and one instance on a voyage to New Zealand, in which the visitor was a butterfly.

In the first case, the ship being off the Spanish coast, but not in sight of land, a very handsome bird came on board. It was a species of dove, blue being the principal colour, with darker markings. Some of the seamen called it a Spanish dove. It was caged and taken home by one of the passengers.

In the second case, being in the neighbourhood of Bermuda, a large flight of a species of swallow settled on the vessel. These poor birds were in a very exhausted condition, and numbers of them were captured by a large cat belonging to the ship. The survivors continued their passage at daybreak next morning.

In the year 186—, on a voyage to New Zealand, we were one morning visited by a butterfly, there being at the time a light breeze blowing. My sons made great efforts to capture this interesting stranger, but unfortunately without success, as it fluttered overboard, and was soon lost to sight in the hollows of the waves. They, however, got sufficiently near to ascertain it to be a true butterfly. The colour consisted of various shades of rich orange brown, and the margins of the wings were deeply indented.

I made careful inquiries of the officers of the ship as to the proximity of land, and was informed that the nearest was the rock of St. Paul's, then fully two hundred miles distant.

M. DASENT

Patea, Taranaki, New Zealand, Nov. 18, 1875

The Three Kingdoms of Nature

SOME children were playing at a game called "The Kingdoms," which consists in the mention of various substances, and asking if they belong to the animal, vegetable, or mineral kingdoms. One little girl mentioned "water," and the company were puzzled as to which kingdom it should be assigned. Is there a sub-aerial or gaseous kingdom? Will you kindly enlighten the members of our

NURSERY?

March 4

OUR ASTRONOMICAL COLUMN

THE VARIABLE STAR,  $\beta$  PERSEI (ALGOL). — Herr Julius Schmidt, Director of the Observatory at Athens, publishes in the *Astronomische Nachrichten* the results of observations on the times of minima of this variable star, extending from August 1846 to November 1875. The epochs are given in Paris mean time with correction for the light-equation. The probable error of a single determination of the time of minimum from 183 observations by Schmidt is  $\pm 8.0$  minutes; fifty observations of Arge-lander gave a probable error of  $\pm 6.0$  minutes, and fifty-five observations of Schönfeld, one of  $\pm 4.6$  minutes, showing by a mean of the 288 observations a probable error of  $\pm 7.0$  minutes. The period assumed by Schmidt in the discussion of his Algol observations between 1840-1875 is 2d. 20h. 48m. 53.6s.

Some interesting details respecting this star are found in Schönfeld's "Der lichtwandel des Sterns Algol im Perseus" (Mannheim, 1870). His comparison stars and their relative assumed brightnesses were:—

Star.	Brightness.
$\nu$ Persei ... ..	0.9 in grades.
$\alpha$ Trianguli ... ..	3.5 "
$\delta$ Persei ... ..	7.8 "
$\beta$ Trianguli ... ..	9.1 "
$\gamma$ Persei ... ..	10.9 "
$\epsilon$ Persei ... ..	12.8 "
$\beta$ Arietis ... ..	16.7 "
$\iota$ Aurigæ ... ..	17.3 "
$\gamma$ Andromedæ... ..	23.4 "

The following, extracted from the more extensive table given by Schönfeld in his treatise, will indicate the law of variation as derived from the light curve:—

Distance from Minimum.	Brightness.
h. m.	Before. After.
4 30 ... ..	20.7 ... .. 20.8
1 0 ... ..	20.2 ... .. 20.2
3 30 ... ..	19.6 ... .. 19.2
3 0 ... ..	18.7 ... .. 17.7
2 30 ... ..	17.4 ... .. 15.8
2 0 ... ..	15.3 ... .. 13.2
1 30 ... ..	12.1 ... .. 9.8
1 0 ... ..	8.5 ... .. 7.6
0 30 ... ..	6.3 ... .. 6.2
0 0 ... ..	5.0 ... .. 5.6

The most probable period over which the variation extends is 9½ hours, and the minimum lies very nearly in the middle of the same. The most perceptible diminution of brightness occurs 1h. 26m. before the minimum, when the star is somewhat fainter than the mean of  $\gamma$  and  $\epsilon$  Persei, and the most perceptible augmentation when the star arrives at nearly the same degree of brightness, but 1h. 47m. after minimum. In this phase it is hardly fainter than the mean of  $\delta$  Persei and  $\alpha$  Trianguli. Schönfeld states that to his eye the variation of Algol is included between the magnitudes 2.2 and 3.7; he considers  $\gamma$  Andromedæ an average star of the second magnitude,  $\delta$  Persei 3.5,  $\alpha$  Trianguli about 3.1, and  $\nu$  Persei 4.1.

For elements of Algol we may adopt at present the following, derived from Schönfeld's last catalogue. First minimum of 1876 .. January 2.23233 Greenwich mean time; period 2.867288.

**CONJUNCTION OF JUPITER AND  $\beta$  SCORPII.**—Mr. J. Birmingham, Millbrook, Tuam, writes as follows with reference to the near approach of Jupiter to the bright star  $\beta$  Scorpii on the morning of Feb. 28.—“The weather prevented any observation until 19h. 25m. Greenwich M.T., when the western limb of Jupiter had nearly, but scarcely quite, reached the R.A. of the star. The micrometer-wire through the star then just grazed the northern edge of the planet, and so closely that it could not be said for certain that there had not been actual contact. Clouds coming on again soon put an end to the observation.” Allusion was lately made to the above phenomenon in this column.

**NOTE ON BIELA'S COMET.**—It will be remembered that when, on the appearance of Biela's Comet in 1805, the similarity of elements to those of the comet of 1772 had been remarked, it was pointed out by Gauss that the differences between the orbits, particularly the diminution of the inclination, could not be accounted for except on the supposition that in the interval the comet had undergone perturbations from one of the larger planets, and the necessary proximity could only have been consistent with the assumption that several revolutions had been performed in the interval between 1772 and 1805, as on the next observation of the comet in the spring of 1826 was proved to have been the case.

If we adopt the elements for 1772 assigned by the late Prof. Hubbard of Washington in his masterly investigation on the motion of this comet, we shall find the following distances from the orbit of the planet Jupiter:—

True Anomaly.	Radius vector.	Distance.
+ 156° 0'	5'029	0'316
157 30	5'143	0'281
158 0	5'180	0'283
+ 160 0	5'327	0'344

A true anomaly of 157° 30' corresponds to 645'5 days after a perihelion passage, and the comet would arrive at this point of its orbit, which may be taken as that of nearest proximity to the orbit of Jupiter about 1794'21, while the planet would be in the same longitude about 1794'43, and it thus appears that it was in the spring of the year 1794 that the very material changes in the elements of the comet's orbit were caused by the attraction of Jupiter. Another near approach of the two bodies would appear to have taken place towards the end of the year 1746.

### THE NEW GERMAN SCIENTIFIC EXPEDITION TO THE OBI

THE Expedition to Northern Siberia, fitted out by the “Verein für die Deutsche Nordpolarfahrt in Bremen”—the same Society which sent out the Second German North Polar Expedition, and published the excellent account of its results—left Bremen last week. The attention of the Council of the Society having been called to the immense unexplored area between the Jenisei and the Obi, it was resolved, as there were not sufficient funds for a naval expedition this year, to send out a small zoological and ethnographical expedition overland to the Obi, which appeared to be less known than the Jenisei. In this they received the warm support of the highest scientific authorities at St. Petersburg who were asked for advice on the subject. Dr. Otto Finsch, Director of the Zoological Museum at Bremen, was appointed leader of the expedition, and Dr. Brehm, the well-known author of “Das Thierleben” and many other natural history works was selected to accompany him. They were joined by Count Walburg-Zeil-Trauchburg of Stuttgart, who made an expedition to Spitzbergen in 1870 at his own expense, and who is well acquainted with physics and is a good botanist. Professor Oscar Schmidt of Strasburg, who had likewise intended to go, was unavoidably prevented at the last moment. The route selected is by St. Petersburg

and Moscow to Nishni, and thence in sledges via Kasan, Perm, Ekaterinenburg and Omsk to Semipalatinsk. Thence a detour will be made, if possible, into the Altai. From Ekaterinenburg they will go to Barnaul and down the Obi to the embouchure of this river. They will return to Germany in the autumn—certainly not without a rich harvest of results.

### UNIVERSITY REFORM

(Communicated.)

THE speech of Lord Salisbury on introducing a bill to reform the University of Oxford, inaugurates a fresh epoch in the history of University reform. The speech nominally referred to Oxford only, but the principles enunciated in it apply equally to both Universities. The defects of the Oxford system, pointed out with such clearness by Lord Salisbury, are also the defects of the Cambridge system, and the remedies to be applied, must, in their broader features, be the same for the two Universities.

Lord Salisbury lays it down as the cardinal point in his scheme of reform that, till the requirements of the University for teaching and research are satisfied, no portion of the funds of the colleges ought to be employed for endowing idle fellowships.

“I do not know,” he says, “that what is available from the whole of the idle fellowships will be required for University purposes, and I do not venture to lay down the principle that no fellowship should exist which would give the holder no educational work, and which should last for a few years. It may be wise to maintain a few of these, limiting the holding of them to a certain number of years, but I do venture to lay down that all the University wants in the shape of museums, libraries, lecture-rooms, and the proper payment of teachers, should be provided for before the subject of furnishing incomes to men who do nothing can be entertained.”

The enunciation of such views as these by a Conservative Minister must be hailed by genuine University reformers as a most reassuring sign of the progress of public opinion. Up to the present time such principles as those contained in Lord Salisbury's speech have only been whispered in secret by a few men who have been generally regarded as extreme and unpractical; but it is to be hoped that for the future these principles will form the starting-point of University reform. It is to be regretted that they have not been more distinctly embodied in the Bill presented to Parliament. The indefiniteness of the plan of reform there laid down, and the powers of resistance secured to individual colleges, seriously detract from its efficiency. We trust that these points will be altered in Committee; otherwise everything will depend on the wisdom, union, and determination of the Commissioners.

Lord Salisbury alluded to the more pressing wants of the University of Oxford, which include a new library, museum, schools, and other permanent structures; and states that for these alone an immediate outlay of 210,000*l.* is required. In addition to this sum a large yearly income is needed to bring up the staff of University teachers to a suitable standard both in numbers and efficiency. Large as are the wants of Oxford, we believe that those of Cambridge are also very large both as regards permanent buildings and the professoriate. This is not only shown by the report of the Buildings Syndicate of the University of Cambridge, but also by the recent appointment of a Studies Syndicate, which indicates that the present staff of teachers is generally considered inadequate. The above facts are in themselves sufficient to demonstrate that, if the principles laid down by Lord Salisbury are firmly carried out by the Commissioners it will

be necessary for them to abolish in a nearly complete manner the existing idle fellowships.

In fact the term "Fellow" will cease to be the name for a successful candidate in an examination, who, as a reward for his success, receives for a longer or shorter period a considerable income, and will become the title of one engaged in University work.

It must not, however, be lost sight of that the abolition of idle fellowships is only valuable as a means to an end—that end being the increased efficiency of the teaching and research in the Universities. On this account it becomes important to follow out the further changes which will be entailed by the abolition of idle fellowships.

On the abolition of these fellowships, all the colleges will be in possession of a large income entirely available for University purposes. A considerable part of this will no doubt be at once employed for the buildings and other permanent structures needed by the Universities, and will be handed over to the Universities either in the form of a yearly tax or a share of the college property. Of these two methods of contribution the former appears on the whole to be attended with the fewest inconveniences, and will have the further advantage of supplying at once an available income to the University.

On the most extravagant estimate it seems clear that, after all the requirements of the University for permanent buildings, &c., have been satisfied, the available revenues of the colleges will by no means be exhausted, but a considerable sum will still be left to meet the urgent need of fresh Fellows to carry on the work of the University.

Ought the money intended for the payment of these Fellows to be handed over to the University, or left in the hands of the colleges? Although some advantages might accrue from handing over the money directly to the University, yet the proposal cannot be entertained. No Conservative Government could thus despoil the colleges. The opposition would be too great and not improbably the whole scheme of reform might be ruined. If it is admitted that the money is to remain in the hands of the colleges, a further question arises as to the system under which the new Fellows are to be elected.

Is their election to be carried on by the colleges on the old system, or to be more or less directly under the control of the University? We believe that the value of the proposed reforms depends greatly upon the answer given to these questions.

In dealing with them in a practical way it is neither possible nor desirable to overlook the fact that a collegiate system of teaching exists. Were it proposed, while still leaving the money in the hands of the colleges, to remove the election of the Fellows completely from their control, they would feel greatly aggrieved and would offer the strongest opposition to the scheme. It certainly could not be looked on as otherwise than a hardship for the colleges, that they should have no voice in the election of the men who were to form their governing body.

It must not, however, be overlooked that so long as Fellows are elected on the present system, a great increase of efficiency in the teaching staff of the University cannot be anticipated.

The causes which render the present system unsatisfactory are for the most part easily detected. In the first place Fellows are not elected for their efficiency in teaching or in research, but on account of their success in an examination, a very unsatisfactory test either of their powers of research or their powers of teaching.

In the second place, the standard requisite to obtain a fellowship, especially at Cambridge, is very different in the various colleges. In some of the smaller colleges the standard is very low, yet were the present system to be continued, these colleges would go on appointing Fellows totally incompetent for their University position.

In the third place, the nature of the colleges as closed corporations causes it frequently to happen that, after a

man has been elected to a fellowship and continues to reside, he is appointed to a lectureship in spite of evident incompetency. In addition to these inherent faults in the existing mode of election to fellowship, the present system labours under great defects owing to the absence of centralisation. So great are these defects, that both Universities have recognised, and to a certain extent attempted to cope with them. Cambridge has done so by starting what is known as the "intercollegiate system of lecture;" a system which consists in the combination of the greater number of the colleges for the purpose of having common lectures open to the students of all the combining colleges. Oxford possesses a somewhat similar system, including several combinations of three or more colleges with the same objects as the one combination at Cambridge.

We cannot enter into the details of these systems, but confine ourselves to pointing out that they are generally recognised as very imperfect substitutes for a completely centralised system. They contain no sufficient guarantee for the efficiency of the teachers employed, and in the case of subjects where the students are few, the very existence of these systems interferes with the appointment of fresh lecturers, however incompetent the existing lecturers may be; and lastly they afford no help whatever to research.

The past action of the Universities themselves, as well as other considerations, indicate that the present system of election to fellowships ought to be abandoned, and a system involving greater centralisation substituted for it.

Though Lord Salisbury does not distinctly state that he regards this centralisation as necessary, yet the general tenor of his speech clearly indicates that he does so; and the very argument he has used against permitting the colleges separately to reform themselves, applies equally against their separate action in the election of Fellows.

To meet the requirements of the University in the election of Fellows, it is necessary to devise some system in which a central board, directing and influencing the elections, shall work in concert with the colleges in whom the actual election must be vested.

The function of the central board ought not only to be the indication of the men to fill the fellowships, but also the settlement of the branches of study in which teaching or research is required. In the election of Fellows by a college, no preference ought to be shown to a member of the college, and the lectures of the Fellows ought to be equally open to all the students of the University. In such subjects as natural science, rooms ought to be assigned to the Fellows in the University buildings.

Whatever system of election of Fellows may ultimately be found advisable, the colleges will necessarily be left completely free to elect their Tutors, Bursars, Deans, and other officers, and the election of a certain number of Fellows for college teaching ought to be left in their hands.

The partial inefficiency of the present staff of University professors will probably be urged as an argument against the centralisation of teaching in the University. This inefficiency, so far as it exists, has mainly arisen from its not being possible for men who have obtained a University post to rise in their profession; and we believe that by instituting a series of grades, the highest of which shall only be held by distinguished men, it will be possible to supply the stimulus as necessary for efficiency in a University career as in all other professions.

The efficiency of the Professoriate in the German Universities appears to be mainly due to the existence of this stimulus, and we may therefore hope that the presence of this alone is necessary in order to render the professors in the English Universities as efficient as those in the German ones. Promotion ought of course to be granted for research as fully at least as for successful

teaching, and a much-needed stimulus thereby given to learning in the Universities.

The remarks of Lord Salisbury on the question of research are quite as liberal as those on the questions of general education of the University. "The only point," he says, "in the connection to which I wish to call attention is that referring to research. We are of opinion that the mere duty of communicating knowledge to others does not fulfil all the functions of a University, and that the best Universities in former times have been those in which the instructors, in addition to imparting learning, were engaged in adding new stores to the already acquired accumulation of knowledge."

How best can research be combined with teaching? It will probably be found advisable to relieve from all teaching some of the professors who belong to the highest grade, and who have shown their capability for research; but we do not believe that this principle can with any advantage be generally adopted in the case of young and untried men. It would appear to be far safer to give opportunities of research by not demanding too much teaching work. With a large staff of lecturers it would not be necessary to demand from each more than two terms' teaching in the year. With only two terms' work and the remainder of the year free, ample time would be given for a teacher, not only to keep up with the progress of his subject, but also himself to advance it; but this point might be left for further consideration and experience.

The research we are anxious for is not confined to the natural sciences, but embraces all branches of learning, and we cannot better explain our view in this matter than by again quoting a passage from Lord Salisbury's speech. "What I am particularly anxious for," he says, "is that all branches of culture should have equal encouragement, and should be regarded not as rivals but as allies in the great and difficult task of cultivating and developing the human mind."

#### SCIENCE AND ART IN IRELAND

THE Royal Dublin Society held a special meeting on Thursday, March 2, to consider the Report of the Council on Lord Sandon's letter. In the absence of his Grace the Duke of Leinster, the President of the Society, the chair was taken by Sir George Hodson, Bart., one of the Vice-Presidents. Dr. Steele read the Report of Council, which concluded with a recommendation that the Society should sanction the Council's sending a deputation to London to press the following points upon her Majesty's Government:—

1. An assurance that the library, and the collections in the museums, shall be maintained in Dublin for the use of the public.

2. That ample accommodation shall be secured for the members of the Society for the purposes of their meetings, for their reading rooms, and for their officers; the whole being maintained for the Society, and under its own control.

3. That a suitable apartment as a reading room in connection with the library shall be provided for the exclusive use of the members of the Society.

4. That the members shall have the privilege, under reasonable restrictions and conditions, of borrowing books out of the library.

5. That the Agricultural Department shall be compensated by an equivalent for any space of which it may be deprived.

6. That the laboratory, with the services of an analyst, shall be preserved as heretofore for the purposes of the Society.

7. That the services of the present officers of the Society shall be retained; or the salaries and emoluments which they now enjoy secured to them.

8. That, as heretofore, an adequate staff shall be maintained for the purposes of the Society, or an equivalent grant to enable it to provide itself with the same.

9. That the members shall have free access to the new Institution at all times that such is open (whether by payment or otherwise) to the public.

That as some equivalent for the property surrendered, and as a compensation for a possible falling off in the income of the Society, an annual sum be granted to enable it to continue its several works of utility.

Mr. Ferguson moved a resolution in the following terms: "By reason of the very recent date of Lord Sandon's letter (Feb. 9, 1876) relative to the establishing in Dublin of a 'Science and Art Museum,' and the consequent short period the Council of the Society have had to make the Report thereon as this day laid before the Society, it is desirable that the consideration of the Council's Report be now adjourned till this day four weeks, for the purpose of enabling the Council to lay before the members of the Society such necessary information as will enable due and proper action to be taken on the several matters therein." This resolution was at once seconded by Dr. O'Donovan, and the necessity of adjourning was urged by several members to whom the leading facts in reference to the Society's relation to the Government, as stated in the Council's Report, appeared quite new. Dr. E. P. Wright said that the mover and seconder of the resolution asked for more light; to him it appeared as if the light they already had had dazzled them. Let the terms of the minute of the Science and Art Department of Sept. 21, 1865, be remembered, and how could the Society indulge in the illusion that the so-called Departments of the Society belonged to it otherwise than as in trust for the public? As to representing that the Government were not fully aware of the position of affairs, was it not a fact that the Chancellor of the Exchequer, Lord Sandon, and Mr. W. H. Smith had within the last few months personally inspected all the arrangements of the Society for themselves? and did anyone present doubt that Sir M. H. Beach had not a perfect knowledge of the Society's wants and merits? and then there had been a Parliamentary inquiry in 1864 and a Royal Commission in 1868. Why then waste time in asking for more information? Lord Sandon's letter was clear and explicit. Why not boldly face the inevitable, and see in the proposed scheme a means of having in Dublin what all desired, a National Library and a Museum of Science and Art? Several of the points asked by the Council it seemed probable would be yielded by the Government; but he appealed to those who had the true interests of their country at heart to support and co-operate with the Government in this matter, and not to treat them as Greeks, though bringing gifts. As the feeling of the meeting seemed to be in favour of having the Council's Report *in extenso* before them, he would move as an amendment: "That Lord Sandon's letter and the Report of the Council just read be printed and circulated among the members; and that this meeting do adjourn until this day fortnight—then to consider the same." This amendment was seconded by Lord Powerscourt, but on being put was negatived, whereon the original resolution was put from the chair and declared duly carried. It was further resolved that the Council should send a deputation to London to obtain such additional information as they could as to the intentions of the Government.

At a special meeting of the Royal Irish Academy, held on Monday last, the following amendments were adopted by a large majority:—

1. That the Royal Irish Academy being desirous of co-operating with her Majesty's Government in the measures necessary for the establishment of a National Science and Art Museum in Dublin, provided that the independence and usefulness of the Academy be not injuriously affected by such measures, is willing to consent to the

transfer of its antiquarian collections commonly known as its Museum, to the Government upon the conditions—

a. That the arrangement of the Museum, as well as the purchase of additions, shall continue to be conducted by the Academy; and that adequate provision shall be made for the continued acquisition of Irish antiquities which may hereafter be discovered or offered for sale.

b. That the Museum of the Academy, together with such other Irish antiquities as may be added to it, shall be for ever kept apart from other collections, and be permanently maintained as a Museum of our National Antiquities, no portion of its contents being ever removed from the City of Dublin, unless by permission given under the seal of the Academy.

c. That the Academy shall be accountable, as at present, to her Majesty's Treasury, through the Irish Government, for all sums voted by Parliament, and shall not be subject, in the conduct of its affairs or the expenditure of its grants, to any control on the part of the Science and Art Department, or any of its officers.

2. That, considering the position which the Academy has long held, and will continue to hold, as the first scientific, literary, and antiquarian Society of the country, the proportional representation proposed to be given to it on the Board of Visitors (sect. 12 of Lord Sandon's letter), is altogether inadequate; and the Academy further think that no paid official of the Science and Art Department should be eligible to act as a representative on the Board.

3. That there should be provided in the yearly estimates, as laid before Parliament, instead of the several sums now annually voted, a sum at least equal to what is at present voted, to enable the Academy to discharge more completely its functions as a scientific, literary, and antiquarian body, by making grants in aid of original research, by publishing the results of such research, by maintaining a library specially adapted to assist learned investigation, and by editing and printing ancient Irish texts, &c.

SCIENTIFIC INSTRUCTION AND THE  
ADVANCEMENT OF SCIENCE.

ON Wednesday and Thursday last week two separate deputations from the Council of the British Association waited respectively on Mr. Cross and the Lord President of the Council, the Duke of Richmond and Gordon, both introduced by Dr. Lyon Playfair, and headed by the president of the Association, Sir John Hawkshaw. The object of the deputations was to induce the Government to adopt certain recommendations of the Royal Commission on Scientific Instruction and the Advancement of Science.

Dr. Playfair said there were three points in the Reports of the Science Commission to which they desire to direct attention—namely, the recommendations as (1) the study of science in elementary and endowed schools, (2) the endowment of research, (3) the administration by a Minister of Science and Art.

Sir John Hawkshaw said that the matters which they that day desired to mention were chiefly treated in the Fifth and Eighth Reports. He read a memorandum on these points approved by those he represented. This document set forth that the Government possessed, through the elementary schools and through the authorities charged with framing schemes for endowed schools, the machinery for insuring scientific teaching. The public schools will follow the Universities; the Universities in England and Scotland are about to be the subjects of inquiry by Commissions, and science ought to be adequately represented on these Commissions. University College and King's College, London, Owens College, Manchester, and Trinity, Dublin, would require special consideration, and if further pecuniary assistance were granted them by

Government, guarantees should be taken for the further encouragement of scientific teaching. Direct endowments of research must be approached with caution. There would be no objection to the course of liberally endowing professorships in the several Universities, combining the duty of original research with a moderate amount of teaching to be attached to the professorship; an extension of the principle involved in the grant to the Royal Society might be advantageously resorted to, and the grant might be gradually increased. The Lord President of the Council was practically entrusted with the functions of a Minister of Education, responsible to Parliament; and it therefore seemed to follow that he should be made the responsible administrative head of the business connected with scientific institutions which receive their support from public grants, with the allocation of funds for scientific purposes, as well as of the business relating to the promotion of scientific instruction, as these matters all form an essential part of public education in science. Sir John Hawkshaw would only add to the document that it would be of great advantage if the State would establish, say, a laboratory for chemical science, and an observatory for physical investigations.

Prof. A. W. Williamson, Prof. Roscoe, Mr. Spottiswoode, Dr. De La Rue, and others spoke in support of the deputation's object, with which Mr. Cross said he sympathised very much indeed.

The Duke of Richmond and Gordon said the Government were well aware of the great importance of scientific education. With regard to the Reports of the Science Commission, he thought Lord Salisbury was now acting upon the Third Report, in respect to Oxford and Cambridge. It seemed to him that the endowment of professorships had not been altogether satisfactory so far as it had been tried. With regard to the Government grant to the Royal Society, that was a grant, not an endowment for those who work, but, as he understood it, a provision of apparatus. The sum of money was so expended. It was not an endowment of research. With regard to establishing physical observatories, the Government had taken action in the work connected with astronomical physics which Mr. Norman Lockyer was now carrying on, or beginning to carry on at South Kensington. With regard to the laboratories for chemistry and physics which Mr. De La Rue alluded to, it seemed to him they could not very well do more in that direction till they had the report of the Commission which was to inquire into the Universities' scheme proposed by Lord Salisbury. He concluded by assuring the deputation that the Government were quite alive to the great importance of the subject.

PHYSICAL SCIENCE IN SCHOOLS

I CONFESS I did not understand Dr. Watts's letter quite as Prof. Roscoe has done. But that is of little importance. Prof. Roscoe has opened wider questions as regards the position of Physical Science at Schools, and I should be glad of the opportunity, if you can spare me the space, of writing a little more at length on this matter, and, if possible, of thereby arriving at a distinct understanding what it is that the thorough-going advocates of science, like Prof. Roscoe, want. His letter is a good hearty grumble at things in general, and a good grumble from him wakes people up, and does us all good; but we want to know what specific changes he wants, and who is to make them. "Regulations" and "Examinations" and the "position accorded to science in schools," and the "discouragement to the teaching of science," want of "efficient means of teaching science," "difficulty of obtaining masters," are all in turn mentioned as obstacles. Some of these arise from one cause, some from another, and before any improvement can be effected, we must analyse the position of science at schools, see what

the circumstances are which affect it, and understand where pressure can effectively be brought to bear.

The position of science at schools is dependent on—

1. The Public Schools' Commission.
2. The Statutes and Regulations of each School; *i.e.*, the Governing Bodies.
3. The Indirect Influence of the Universities and other Examining Bodies.
4. Head-Masters.
5. Parents.

1. The Public Schools' Commission enforce the teaching of science by requiring (Reg. 3) that "In any examination of a boy (not being one of the senior boys) in the school, or in any report of a general examination, the proportion of marks to be assigned to Natural Science shall be not less than one-tenth nor more than one-fourth, as the Governing Body shall think fit." Also that (Reg. 6) "There shall be one Mathematical Master, at the least, for every 100 boys in the school, and one Science Master, at the least, for every 200 boys learning Natural Science in the school." Also that (Reg. 7) "Every boy shall learn Natural Science continuously from his entrance into the upper middle form, Div. II., until he become one of the senior boys in the school." Further, that (Reg. 8) Senior boys may pursue special subjects of study and discontinue other subjects for that purpose: and that (Reg. 11) "Any boy in the school who may evince an aptitude for Natural Science shall have facilities for that study." Also (Reg. 10), "Any boy entering the school shall have the opportunity of showing acquaintance with Botany, Physical Geography, or some other branch of Natural Science."

It is evident that the all-important question here is, who are senior boys? Regulation 5 says "the Governing Body shall from time to time determine the point in the school list above which the boys shall be reckoned as senior boys for the purposes of these regulations."

These regulations are dated Aug. 4, 1874.

I do not think any reasonable fault can be found with these regulations from Prof. Roscoe's point of view, unless he finds fault with Regulation 7, which does not give natural science equality "as regards range," with classics and mathematics. To this I shall recur again.

2. The Statutes of Rugby School order that three Major Exhibitioners shall each year be elected—to pursue their studies elsewhere—for general proficiency in the studies of the school; and that four Minor Exhibitioners shall be elected, for proficiency in Classics, Mathematics, Natural Science, and Modern Languages respectively. The Regulations (37) order that "Natural Science shall be obligatory on every boy in the middle school, and either Natural Science or German on every boy above the middle school." Also (40) that "two Major and three Minor Scholarships shall be given for proficiency in Classics; one Major and one Minor for proficiency in Mathematics; one Minor for proficiency in French, and one in Natural Science." These are open to all boys between twelve and fifteen years of age.

I think it cannot but be felt that Natural Science has not been ignored in these regulations; it is not indeed put on an *educational equality* with Classics, but it is respectfully treated.

3. The Universities and other examining bodies affect us greatly. We at Rugby are principally influenced by Oxford and Cambridge, and it is of their influence only that I proceed to say a few words. It is plain that at the Universities some subjects must be universal, and some optional. The compulsory subjects are Latin, Greek, Mathematics, and Scripture Knowledge; optional subjects are numerous enough. Science ranks there with Law, History, Moral Science, Medicine, &c. Does Prof. Roscoe think that this is wrong? I really wish to know whether any thoughtful man who has considered the

subject will say that science ought to be a *sine qua non* for admission or for a degree at the Universities? I certainly think that science has its right position among the optional subjects. The point in this system that is more doubtful is the position of Greek, whether it might not be ranked with the optional subjects, and so give fair play to those schools and portions of schools which teach Science instead of Greek, and which are practically relegated to the rank of middle class schools (whatever they are called), because they have no outlet into the Universities. This is a change that has been already discussed more than once, and the opinions are, I believe, so nearly balanced, that the existence of a few more such schools, and a little pressure from without, will probably soon cause the change to be made. There is no doubt that the ready sympathy between the Universities and the educational needs of the country will be shown in this as in other things.

This is a digression, however. To return. Such being their system, the Universities are asked to examine schools and award leaving-certificates. I have reason for thinking that it was felt that this was not a time for fettering schools, or preventing educational experiments; they therefore declined to lay down *any* universal subject of education. They grant certificates without requiring a knowledge of even Latin and arithmetic. Every school may select its own studies. They will not, however, grant a certificate without a certain variety of attainment: four subjects must be taken, speaking generally, from three groups. Language, Mathematics, Literature, and Science form the groups.

It seems to me, therefore, not fair, not a statement of facts, to charge the University examination for certificates with "placing the science subjects in a distinctly inferior position to the older studies." The position is exactly identical. As a *leaving* examination nothing can be fairer.

What I pointed out in my first letter (Feb. 24) was that the *leaving* examination from school was in fact, to our boys, an *entrance* examination to the Universities; and in it they select, of course, the compulsory subjects of the Universities, for otherwise the certificate has no value. Science is not one of these compulsory subjects, and therefore the indirect action of these examinations is adverse to science. But I do not see how it can, or ought to be, otherwise; only I wish that their examination in science was a little more carefully arranged, with a view of forming at schools a sound method of teaching science.

The Universities of course affect us greatly by their scholarships in Natural Science, which do more to guide the teaching than anything else, and by their training masters. The influence of men like Maxwell and Clifton in inspiring teachers of Physical Science is very great; and when this influence is wanting in any subject at the Universities, the schools are the bodies which suffer. The Professors of Chemistry and Physics at the Universities are masters of the situation.

4. Head-masters have, of course, the chief power at schools of making science teaching effective or the reverse. This is a delicate matter for an assistant-master to speak of; and I have no right to discuss in this place—nor indeed elsewhere—how far the Regulations of the Commission and Governing Body are carried out in letter or in spirit, here or elsewhere.

But I may point out that, except in rare instances, head-masters follow, and do not lead, public opinion on educational points. The competition between schools is close; their prosperity depends on their meeting the demands of the public; and few men are bold and clear-sighted enough to make with success a move in anticipation of a demand from the public. At present a Balliol Scholarship, or other University Scholarship, are the grand advertisements; got at whatever cost to boy or school, they *pay*. And head-masters, being but men, are influenced by this. To get one such scholarship, except



in cases of rare genius in a boy, costs the school a good deal, not in money, but in efficiency. To get one you must spoil several. First-rate proficiency in a subject, it is believed, can only be got when many are working together in it. Competition is stimulated by numbers. The success is less brilliant when the racers are few. A form is somewhat disorganised, it is urged, if some boys drop Greek, and others drop verses, or composition altogether; and thereupon many are kept to swell the triumph of the few. The possible disorganisation is an imaginary evil, I believe, but a real argument none the less, and science suffers much at schools from a want of freedom given to boys to drop some other subjects and pursue it as a principal study.

Then there is the inevitable silent disparagement of non-appreciation. Some men have genuine sympathy with learning of all kinds, and can make others feel that they respect a learning they themselves do not possess. But such men are rare. It is too often made plain to boys who "take to science," that they are regarded as failures—as we hear of some "ne'er-do-weel" that he has "taken to" sheep-farming in Australia. It is the entire and transparent honesty of this opinion that makes it so effective, and this adverse influence, which is deeper than words, and often in flat contradiction to them, will only be eliminated by the general growth of public estimation of science, and by the fruits that education in science can show. For this we must wait.

5. The last influence is that of parents and the public generally. From them, as far as I can judge, there is no trace of a demand for a revolution in education. The only subjects on which there seems to me to be a strong and tolerably united opinion, are the postponement of Greek in the education of young boys, and a desire for greater weight to be given to arithmetic, good writing, and geography. The teaching of science is desired, principally on grounds of utility, not of training; and choice of the time of introduction of it, the order of the subjects, &c., the stratification of science, in a word, has not been considered, except by very few.

Prof. Roscoe thinks science ought to have "educational equality both in range and time with classics and mathematics." Here I distinctly differ. I maintain, after trial, that it is unwise, and unscientific from an educational point of view, to attempt to teach science at school to boys till they have attained a certain standard of knowledge in arithmetic, and a certain power of reasoning and language, as shown by their attainments in geometry and Latin. Let science be held before them as a thing to be enjoyed when they are older and more advanced. It is spoiled for them, and they are spoiled for it, by its being taught them too soon. The dicta of men like Faraday and Sir John Lubbock, and Roscoe are misleading opinion on this point, and I wish to record my protest against them. Do Sir John and the Professor know, have they the slightest idea what the standard of arithmetic is in the lower forms and among the new boys of a public school? I will tell them. This was the entrance paper I set in Arithmetic last January. By the Regulations, "No boy shall be admitted who cannot work sums in Fractions and the Rule of Three."

"RUGBY SCHOOL, JANUARY, 1876.

"Entrance Examination.—Arithmetic.

"You are required to satisfy the Examiners in this paper.

1. Subtract one hundred and seven pounds, nineteen shillings and sixpence three farthings from two thousand seven hundred and three pounds, and threepence halfpenny.

Multiply the result by seventeen.

2. Write out the table of square measure, and find the number of ounces in a ton.

3. If 49 tons 15 cwt. 1 qr. 13 lbs. of coal are distributed among 23 persons, how much will each receive?

4. Multiply  $117.3s. 6\frac{1}{2}d.$  by  $3\frac{3}{4}$ .

5. Simplify  $2\frac{1}{2} \div 1\frac{1}{2}$  and  $\frac{2\frac{1}{2} - 1\frac{1}{2}}{7 \div 5\frac{1}{2}}$ .

6. If a man walk 4 miles, 1 furlong, 40 yards in one hour and 13 minutes, how far will he walk in two hours?

7. Multiply .105 by 3.027 and .105 by 3.027.

8. Find the cost of 3,653 articles at 7s. 13s. 6½d. each."

The plucking on this paper happily did not rest finally with me. But it may affect Prof. Roscoe's opinions if I tell him that if every boy had been required to answer one of the first three questions, and either 4 or 5, and 6, —1 per cent. would have failed: and the average age of these boys cannot have been under fourteen. This is a stubborn fact. No doubt boys ought to know more. But they don't.

What, therefore, we insist on is that boys, when once in the school, shall not begin science till they know something of fractions, decimals, and square measure, and half the first book of Euclid. Does the Professor think our standard too high?

To sum up, therefore, what has been said. The commission and governing body secure fair play to science; the Universities do the same, though the new examination is, indirectly, rather adverse to it. Head-masters follow, and do not lead the public; and the public has no very decided opinions just at present.

If, therefore, I were asked what I think ought to be the programme of those who are interested in the progress of physical science and of sound education generally, in schools, I should reply that our great aim ought to be the postponement of Greek in all schools, and its removal from the compulsory subjects in the examination for certificates that carry a University value; that meantime we ought to use the certificate examination, and improve it; and to demonstrate, if possible, to unbelievers, the advantage it would be to some boys to drop Greek and composition for the purpose of scientific study, and that such a liberty would not injure the efficiency of schools in classics. It will be well also to watch with care the progress of schools in which Greek is not taught at all. No index to public opinion can be more valuable.

"The History of Education," Henry Sidgwick says, "is the battle-ground and burial-ground of impracticable theories; and one who studies it is soon taught to abate his constructive self-confidence, and to endeavour humbly to learn the lessons, and harmonise the results of experience."

It is in this spirit—and I trust it is mine—that anything must be written that will now, in the present stage of the discussion, be a valuable contribution to the formation of opinion on this interesting and important question.

Rugby, March 6

JAMES M. WILSON

I should feel obliged if you would permit me to say that my views with regard to this question agree in the main with those of Mr. Hutchinson and Mr. Wilson.

The regulations of the Oxford and Cambridge Schools Examination Board were amended after the first examination in 1874, and the paper together with the practical work set last year was, in my opinion, sufficient in point of difficulty. Several of the candidates from Clifton, and doubtless from other schools, were quite prepared to work a much more difficult paper. That, however, is not the question which is to determine what shall be required of the average boy when he leaves school.

In Clifton College the Modern Side receives instruction in science at the rate of two lectures a week on chemistry and two on physics. Latin gets only three hours a week. A large number of boys (over fifty) attend voluntarily in the laboratory and thus have three or more hours a week of practical work, whilst a few of the more advanced receive two lessons in theoretical chemistry, besides doing a considerable amount of reading out of school. The subject is rewarded by marks at the same rate per hour as Latin, and also gets a fair share of prizes. In short, science at Clifton occupies a prominent and

<sup>1</sup> In the revise I have struck out this number. Its publication might be regarded as a breach of confidence. And it is almost incredible.

<sup>2</sup> "Essays on a Liberal Education." Macmillan, 1877.

honourable position in our curriculum. At other schools, as, for example, the Manchester Grammar School, I am told that even a larger proportion of the time of the boys is given to work of this kind; and on the whole I am inclined to think that, notwithstanding the reluctance of some of the old foundations to admit the interloper, yet that the prospects of science in connection with general education are exceedingly satisfactory and encouraging.

It would be a mistake to attempt to *displace* classical studies, as some people seem to wish, in favour of science or any other subject. It cannot be expected that all boys should have the same tastes or capabilities. It would be as much an error to compel a boy, who has shown no aptitude for science, to devote any large proportion of his time to that subject, when he might be getting on with his classics, as it would be to doom another to Latin prose when his heart was all the time in the laboratory. The true system I believe to be this. After passing through a junior school, in which all should be equally instructed in some branch of natural history or experimental science, boys should then be drafted off into one of three departments. There should be (1) a classical school, in which Latin and Greek should be the staple, though not to the exclusion of a certain modicum of mathematics and science; (2) a modern school, in which mathematics are predominant; and (3) a science school, in which languages, though subordinate to science, should not be altogether extinguished. This is very nearly the system pursued at Clifton, and I can testify to its practical convenience and success.

As regards the choice of subjects, though I believe chemistry is pre-eminent in its capacity for developing certain of the mental powers, I consider that the fullest advantage is not derived from it, unless it is taught in a certain way. I hold that teachers of chemistry in schools are wrong when they set about teaching boys according to the methods commonly in use in the instruction of ordinary chemical students. The latter have to apply their knowledge to practical purposes, and this is not the prime object to be kept in view in determining the educational value of a given subject.

And this leads me back to the question of examination papers. I consider that examiners have as much to learn as teachers in connection with their respective functions. At present it is too frequently, "How do you make this?" or, "What are the properties of that?" a style of question which is good enough in its way, but to answer requires very little intellectual effort. The preparation for such an examination is little better than "cram," and is of proportionately small educational value.

If examiners, whether in school or university, would take more pains in framing their questions so as to extract not alone that which is in the memory of the candidate, but to get the product of his brain, I believe great and important service would be rendered to scientific education.

WILLIAM A. TILDEN

Clifton College, Bristol, March 6

### PRINCIPAL CHARACTERS OF THE DINOCERATA

UNDER the above title, Prof. O. C. Marsh, of Yale College, has published several facts of great importance with reference to the structure of the huge Eocene Mammals of Wyoming, of which we have already given a short description (*NATURE*, vol. vii. p. 366) from the same author's memoirs.

We now learn that the brain as known from the inside of the skull was very remarkable, being proportionately smaller than in any other known mammal, the Spermaceti and some other whales alone excepted. In *Dinoceras mirabilis* the entire brain was not greater in any of its transverse dimensions than the spinal canal in the

cervical region. Its relative size and position can be best estimated from the accompanying drawing, copied from one given by Prof. Marsh, the brain in it being shaded, with a portion of the spinal cord attached. From the figure it is also evident that the olfactory lobes are proportionately large, at the same time that the cerebral lobes are hardly bigger than in some reptiles. The cerebellum must also have been small, whilst the cranial as well as the spinal nerves and the cord were immense.

The teeth are figured with their prominent V-shaped ridges, the dental formula being given as:—

$$i \frac{0}{3} c \frac{2}{1} p m \frac{3}{3} m \frac{2}{3} x s = 34.$$

The upper canines were very long and pointed, and peculiar expanded descending processes on either side of the lower jaw seem to have acted as guards to protect them whilst the mouth was closed. The condyles of the lower jaw were transverse, and therefore only allowed of an up-and-down movement. The molars were peculiarly small for the size of the animal and of the skull. The creature must have been carnivorous, as mastication could only have been slight, and the food therefore nutritious.

The feet are figured. They were very elephantine, there being five digits on each; these, with the carpus and tarsus, being short and compressed from above downwards. The terminal phalanges were well developed. The other bones much resembled those of the elephant in size as well as contour. Prof. Marsh tells us that the head could evidently reach the ground, and that there is no evidence of a proboscis.

These characters all point to the fact that in Eocene times there lived an order of animals which have no representatives at the present day, and that they were highly specialised in some points of their structure, whilst in others they were equally ill-developed.

### NOTES

We learn that a scheme is on foot for a memorial of the late Prof. Rankine. Students of Thermodynamics, Engineering, &c., will be doubly delighted to hear that the memorial is to take the form of an edition, in two handsome quarto volumes, of his valuable papers contributed to the various scientific societies and magazines.

A SERIES of lectures upon zoological subjects will be delivered after Easter in the Zoological Society's Gardens, in Regent's Park, on Thursdays, at 5 P.M. The following are the titles, together with the days on which they will be delivered by the respective lecturers:—April 27, Mr. P. L. Sclater, F.R.S., on the Society's Gardens and their inhabitants; May 4, Prof. Flower, F.R.S., Rhinoceroses and Tapirs; May 11, Prof. Flower, Horses and Zebras; May 18, Dr. J. Murie, the Manatee; May 25, Prof. Garrod, On Birds; June 1, Prof. Mivart, On Bats; June 8, Mr. Tegetmeier, On Homing Pigeons;

June 15, Prof. Garrod, on Reptiles; Mr. J. W. Clark, on the Beaver and its distribution; June 29, Dr. Carpenter, on the Zoological Station at Naples.

WE are in a position to state that M. Leverrier has not accepted a seat in the Berlin Academy of Sciences, as was announced recently in a London daily paper. He would have been present at the meeting of the Royal Astronomical Society, to receive his medal, had he not been prevented by ill-health. Although not serious, the illness was sufficient to keep him at home for a protracted period.

WE have received the *Atlas Météorologique de l'Observatoire de Paris* for the years 1872, 1873, and 1874, which has been prepared from documents received and discussed by the Departmental Meteorological Commissions, the normal schools, the observers, and others, and published with the concurrence of the Scientific Association of France. This very valuable publication, giving in detail results of much of the important meteorological work now undertaken by France, together with separate discussions on inquiries of great interest by such writers as Prof. Raulin, MM. E. Belgrand, G. Lenoire, and Brault, we shall take an early opportunity of more fully bringing before our readers.

A DAILY weather report, by the *Deutsche Seewarte*, began to be issued at Hamburg under the direction of Dr. G. Neumayer, on 1st January last, which shows on one map embracing nearly the whole of Europe, the distribution of pressure, wind, and cloud, and on another, temperature, rainfall, and sea disturbance, along with a general review of the state of the weather in the morning, the changes that have occurred since the afternoon of the day before, and occasionally a forecast of the weather to be expected. The reports are based on weather telegrams received from twenty-seven places situated in different parts of Germany, supplemented by reports from Great Britain, France, Italy, Austria, Russia, Denmark, Sweden, and Norway. The report is a valuable addition to the daily weather maps of Europe, and considering the great ability of Dr. Neumayer and his coadjutors, the system will be most efficiently worked.

WE have received from the South Australian Institute, Adelaide, six valuable meteorological diagrams, representing the main facts of the rainfall at Adelaide from January 1839 to October 1874, at Melbourne from January 1855 to July 1874, and at Sydney from April 1840 to July 1874. The diagrams for Adelaide are particularly full, showing the rainfall each day for the thirty-five years, the annual amounts, and the monthly averages and extremes.

THE Central Committee for the participation of Germany in the forthcoming Exhibition of Scientific Apparatus has up to the present admitted 260 applicants, who will exhibit altogether 2,300 instruments. The British Government has afforded every facility to the exhibitors, having sent specially-fitted carriages to Berlin for the safe conveyance of instruments of great value.

AT a recent meeting of the Sedgwick Memorial Committee at Cambridge, the treasurer announced that the fund amounted to 11,500*l.* This sum is, however, insufficient for the purpose of erecting a Museum worthy as a building to commemorate the late Professor, and it is hoped that additional subscriptions will still be forthcoming. It is intended that the Museum should form part of a group of buildings for Natural Science purposes. The whole question is under the consideration of a Syndicate.

AT a meeting of the *Senatus Academicus* of Aberdeen University, held on Saturday, it was resolved to confer the degree of LL.D. upon Mr. Charles Meldrum, the Observatory, Port Louis, Mauritius, and Mr. John Smith, Professor of Chemistry, University of Sydney,

A CROWDED meeting was held by the Italian Geographical Society on Tuesday morning in one of the large halls of the Collegio Romano for the purpose of taking leave of the Marchese Antinori, Signor Chiarini, Professor of Geology, and Capt. Martini, composing the expedition sent out to Central Africa. The President, Commendatore Correnti, ex-Minister of Public Instruction, addressed the meeting. Among the many distinguished persons present were Prince Humbert, Honorary President, and General Menabrea, member of the Council of the Society. In the evening a banquet was given to the members of the expedition, and yesterday they were to embark at Naples direct for Aden.

THE *Times* Berlin correspondent writes that Capt. Sosnovski, the Russian traveller, who has just threaded his way from the shores of China to the South Siberian frontier, has presented to his Government an explicit report upon new caravan roads to be formed through Mongolia.

M. GREARD, the Director of Public Instruction of the City of Paris, has just published his Reports, which contain a great number of interesting facts. In 1861, 48 children in each 100 were educated in the public schools of the city; in 1872 the proportion was 68 per cent.; but out of the remaining 32 per cent. only 20 per cent. are uneducated, the other 12 being educated in their families or in private institutions. The fact is all the more noteworthy that in the department of the Seine or suburban Paris, the number of schools and of pupils is diminishing. This is attributed to the impoverishment and sufferings resulting from the German and civil wars, which fell more heavily on the suburbs than on Paris itself.

M. ANSART, a captain in the French navy, has published, under the title "Anemology," an interesting article on the formation of winds, in the *Revue Maritime et Coloniale* for December. The principal aim of the author is to prove that the electrical attraction exerted on the clouds by the earth is an important factor in the generation of winds; the motions of the air being thus not merely dynamical as is generally supposed. Capt. Ansart is not the only meteorologist who has tried to take account of the electrical power of the earth. At the end of his essay he quotes the opinion published by M. Keller, who explains by attraction of the earth the production of waterspouts. He concurs in opinion with Capt. Ansart that the matter of the clouds under special circumstances is attracted by the negative electricity of the earth being strongly positively electrified. The rotation of a waterspout, according to Capt. Ansart, is caused by the attraction of the earth not being equally exerted on the whole of the surface of the cloud.

THE *Augsburg Gazette* states that the number of students registered in Berlin, of German nationality, is 1,884, in Leipzig 2,575, and in Munich, 1,087.

EARTHQUAKE shocks were felt in the province of Constantine, Algeria, at Philippeville and Giggely, two sea-ports, on the night of Feb. 22-23. The exact times for Philippeville were 1 and 1.30 A.M.; the direction north-west to south-east. Another motion was felt at Giggely on the 23rd, at 4 o'clock in the afternoon. M. Bulard, Director of the Observatory of Algiers, expected other shocks on the 4th or 5th of March, and has published the prediction in the *Moniteur de l'Algerie*.

MESSRS. HENRY S. KING and Co., inform us that it was by an inadvertence that Bernstein's "Five Senses of Man" was advertised as ready; it will not be out for at least a fortnight.

WE have just received the first number of the Italian *Giornale del Museo d'Istruzione e di Educazione*, containing forty pages of valuable matter connected with various departments of education. The Museum of which this journal is the organ, was founded

at Rome by decree of Victor Emmanuel in 1874, and is probably one of the finest and most complete educational museums in the world. It is freely open to the public, and teachers have ample facilities for taking advantage of its circulating library, and of the various other means which it possesses for furthering the cause of higher education.

A NEW French geographical journal has been established by M. George Renand, a member of the Paris Geographical Society, under the name of the *Journal Géographique Internationale*, which will be published twice a month. Each number will contain a coloured map.

MR. CUNLIFFE OWEN, the director of the South Kensington Museum, visited on Saturday last the photographic workroom established in the *Moniteur* office, Quai Voltaire, Paris. The peculiarity of the process used is the reproduction of colours by a series of chromo-printings. It is a combination of photography and chromo-lithography, which gives astonishing results, chiefly in the reproduction of models of engines and *natures mortes*.

THE March part of the *Geographical Magazine* contains two maps by Mr. Ravenstein, in connection with Lieut. Cameron's recently-accomplished journey across Africa. One of these is of a portion of South Africa, illustrative of Cameron's route from Lake Tanganyika to the west coast, and the other is a map of the country between Lake Tanganyika and Nyangwe, according to Livingstone and Cameron. The same number contains an interesting account by Lieut. Liardet of an ascent to the lake on the summit of the island of Taruini, in Fiji.

"THE Study of Natural Science" is the title of an address delivered to the Natural Science Classes in the University College of Wales, by Mr. F. W. Rudler, F.G.S., recently appointed Professor of Natural Science in the College. Mr. Rudler has sound notions as to the relations which ought to subsist between scientific and literary training in education, and of the methods which ought to be followed in the study of science.

WE have received a copy of the rules, list of members, and Papers read before the Cambridge Natural Science Club. The number of members is very limited, and the rules are sufficiently stringent to exclude all but men who mean to work. Some of the papers which have been read are of permanent value.

WE are glad to see that the Edinburgh Naturalists' Field Club, founded in 1869, is still in existence and evidently in a prosperous condition.

FROM its Tenth Annual Report, we are glad to learn that the North Staffordshire Naturalists' Field Club is in a prosperous condition; the number of members is now 330. The excursions and meetings during the past year appear to have been instructive and interesting. The Report contains the Annual Address of the President, Mr. C. Lynam, on the Sepulchral Monuments of Staffordshire. Other papers are: "The Geology of Needwood Forest," by Mr. W. Molyneux, F.G.S.; "Uriconium," by the Rev. J. S. Broad; "Ancient Church Bells in Staffordshire," by Mr. C. Lynam; and "Structural Features of Plants in relation to their uses in the Arts and in Medicine," by D. J. T. Arlidge.

PART 3 of Vol. I. of the *Transactions* of the Watford Natural History Society contains the following papers:—On the Botanical Work of the past Season, by R. A. Pryor, F.L.S., with a map of Hertfordshire; List of Works on the Geology of Hertfordshire, by W. Whitaker, F.G.S.; and A Few Words about some Local Ferns, by J. E. Littleboy.

IN the last-issued part of the *Transactions* of the Institution of Engineers and Shipbuilders in Scotland is a paper by

Mr. James Brownlee "On the Action of Water and Frictional Resistance or Loss of Energy when flowing at various velocities through a nozzle with a converging entrance and diverging outlet," with two plates.

THE President and Fellows of Magdalen College, Oxford, have commenced free courses of lectures on botany, zoology, and chemical physics, for artisans resident in Oxford. They will be continued throughout the present and Easter Term and the Long Vacation on each Saturday evening. The lectures are conducted by Prof. Lawson and Messrs. Chapman and Yule.

MESSRS. LEWIS AND CUNNINGHAME, special assistants to the Sanitary Commissioners with the Government of India, have just published a Report describing a series of important observations on the Soil in its relation to Disease.

"LIST of Hemiptera of the Region West of the Mississippi-River" (extracted from the *Bulletin of the Geological and Geographical Survey of the Territories*, No. 5, second series, Washington, January, 1876) is the title of a pamphlet by Prof. P. R. Uhler, who has thus added one to the many valuable hand-lists now being published in various parts of the United States. The need of monographs and synonymic lists in the present day is constantly making itself felt; without them the entomologist can scarcely keep pace with the rapid growth of his study; so that he hails the appearance of such a paper as the above, with its well-executed and clearly-defined plates, as a godsend, for which he can hardly be too grateful.

THE additions to the Zoological Society's Gardens during the past week include a Brown Monkey (*Macacus brunneus*) from Siam, presented by Mr. Thos. G. F. Hesketh; a Tyrant Eagle (*Spizaltes tyrannus*) from South America, a Many-zoned Hawk (*Melierax polyzonus*) from East Africa, two Brazilian Caracaras (*Polyborus brasiliensis*), white variety, from Patagonia, presented by Lord Lilford; two Common Pintails (*Dafila acuta*), three Spotted-billed Ducks (*Anas paciorhyncha*), eighteen Red-crested Whistling Ducks (*Fuligula rufina*) from North-west India, presented by Mr. E. C. Buck; a Ring-necked Parrakeet (*Palaeornis torquata*) from India, presented by Mrs. Henry Kingston; a Cape Dove (*Aena capensis*) from Africa, presented by Miss Barrer; an Indian Elephant (*Elephas indicus*), a Secretary Vulture (*Serpentarius reptilivorus*) from South Africa, deposited; a Greenland Falcon (*Falco candicans*) from Greenland, purchased; a Great Kangaroo (*Macropus giganteus*), a Red Kangaroo (*Macropus rufus*), born in the Gardens.

## ANNIVERSARY ADDRESS OF THE PRESIDENT OF THE ROYAL GEOLOGICAL SOCIETY, JOHN EVANS, F.R.S.<sup>1</sup>

### II.

MR. EVANS, in continuing his address, spoke of stratigraphical geology and of palaeontology, expressing his belief that all recent discoveries pointed to uninterrupted continuity in both regions. After briefly referring to the evidence found in Settle Cave of the pre-Glacial existence of man in this country, and to the Wealden boring, Mr. Evans spoke as follows:—

There is only one more subject on which I will say a few words, and which, as to some slight extent involving a question in which I am personally interested, I have kept for the end of my address.

It is one to which it appears probable that the earnest attention of geologists will immediately be called, namely, the water-supply of this vast metropolis. This is, indeed, not the first time that the attention of this Society has been called to it; for Professor Prestwich devoted to it a considerable portion of his presidential address in 1872. It has since been more fully discussed in the Sixth Report of the Commissioners appointed in 1868 to inquire into the best means of preventing the pollution of rivers, who have extended their inquiries somewhat beyond

<sup>1</sup> Continued from p. 356.

what appear to be the strict limits of their Commission. It is with their report that I am mainly concerned.

The Commissioners have expressed their opinion that the rivers Thames and Lea (or Lee, as the word is spelt in their Report) ought to be abandoned as early as possible, and especially the former, as sources of supply to London. They regard the condition of these rivers as hopeless, and point out that an abundance of spring- and deep-well water can be procured in the basin of the Thames and within a moderate distance of London; and they are further of opinion that the metropolis and its suburbs should be supplied, on the constant system, exclusively with this palatable and wholesome water.

They believe that within forty miles of St. Paul's a sufficient volume of deep-well and spring-water can be obtained for the present daily wants of the metropolis, but especially point to the chalk and upper green-sand above the Gault, as the sources of supply. They state that within thirty miles of London there is an area of 849 square miles "covered" by these formations, and that within 40 miles radius the area is 1,597 square miles.

They estimate, to a great extent guided by experiments carried on during many years under my superintendence, that the portion of the annual rainfall upon this large extent of porous rock, which sinks to reappear in springs and streams, may be taken at six inches annually, and point out that this amount of infiltration into the chalk area within thirty miles of the metropolis indicates the quantity of 202 millions of gallons daily, as the theoretical maximum supply available from that area. They suggest that the greater portion of this water, which now escapes in springs and in the river-beds at the lower levels of the absorbent district on which it falls, might be abstracted by a sufficient number of wells sunk below the present spring-heads of the district, and so constantly drawn upon, that there should always be a void for the reception of unusual rainfalls below the level at which the drainage of the district naturally escapes. They incidentally admit that any water drawn from the subterranean reservoir in the chalk by artificial means will be at the expense of the streams which now flow through the valleys in the chalk area, but do not give even a passing consideration to the effect upon that area of abstracting from it its natural supply of water, and conveying it—"convey, the wise it call"—to London—should the scheme they advocate ever be carried into effect.

It can hardly be believed that a proposal such as this, involving the diversion of the whole of the water from the natural springs and streams over an area of not less than 440 square miles—an area larger than that of several English counties—should have been brought forward without the slightest reference to what would be the result upon this vast extent of country, the inhabitants of which are to be sacrificed to the presumed needs of this overgrown city. It will, I think, come within the province of the geologist to point out not only where spring-water of good quality is to be obtained, but also what will be the effect of its abstraction upon the districts where it now exists in sufficient abundance to overflow into the streams. It will be for him to show what will be the effect of producing "a void below the level at which the drainage of the country naturally escapes;" how what are now fertile and even irrigated meadows will be converted into arid wastes; how watercress beds, now of fabulous value, will be brought to the resemblance of newly-mended turnpike roads; how in such a district all existing wells, many of them already some hundreds of feet in depth, will be dried, the mill-streams disappear, and even the canals and navigable rivers become liable to sink and be lost in their beds. And these results would, if the scheme were carried out, not be confined to some single spot, but would extend over hundreds of square miles.

It may perhaps be thought that I am exaggerating the size of the area, the natural water-supply of which it is proposed to abstract; but the calculation may be readily verified.

The quantity of water now daily supplied to London by the different water-companies, exclusive of the Kent Company, which already supplies deep-well water to the extent of 9,000,000 gallons daily, is stated to be 104,800,000 gallons. Now if the supply of 6 inches of rainfall per annum, absorbed over 849 square miles, be, as the Commissioners calculate, equivalent to 202,000,000 gallons daily, it is evident that it will require more than half that area to furnish 104,800,000 gallons daily, the exact figures being 440½ square miles.

It must, however, be remembered that the Commissioners regard this quantity as the theoretical maximum of water-supply available from such an area. And they are right in so doing; for in some years a far larger area would have to be exhausted in

order to produce so large a water-supply, since not unfrequently the quantity of the rainfall which percolates to a depth of only 3 feet into the soil, instead of being 6 inches, as supposed in the calculation, is as low as 3 inches. For three years running I have known the percolation through a depth of 3 feet of ordinary soil covered with vegetation to have been on the average only 3¼ inches, and through chalk under the same conditions, less than 5½ inches. It would appear then that it would be safer to regard the available spring-water supply as not representing more than 4 inches of the rainfall per annum, instead of 6 inches, in which case the area requisite to supply 104,800,000 gallons daily would be 660 square miles.

To avoid any possible error, let us look at the matter from another point of view. One inch of rain falling over a statute acre produces, as nearly as may be, 100 tons, or 22,400 gallons of water. Dividing this by 30 as representing the daily consumption of one person, there would be enough for one person for 743 days, or, say, for two for one year. Four inches of rain would render each acre capable of supplying the wants of eight persons, so that a square mile of 640 acres would supply 5,120 persons for one year. Calling the population of the metropolitan area 4,000,000, and dividing that number by 5,120, we arrive at an area of 780 square miles as necessary for their supply.

There can therefore be no doubt as to the vast extent of country which the proposal of the Commissioners would place under unnatural conditions with regard to its springs and streams.

No doubt wells may, in some few instances, be placed in such a position as to affect but slightly the neighbouring streams. The wells of the Kent waterworks, for instance, which supply 9,000,000 gallons daily, are so placed as mainly to derive their supply from water that would otherwise find its way into the Thames by springs along its bed; indeed, from the amount of chlorine present in the water, it may be doubted whether some portion of it is not derived from the Thames itself by filtration through the chalk. It seems probable that in the valley of the Thames immediately above London there may be spots from which a limited supply of water might be pumped without much injury to the neighbouring property; but a wholesale abstraction of the entire supply of spring-water from an area of even 300 or 400 square miles could not be otherwise than most disastrous.

On looking at the actual chemical analysis of the waters supplied by the different companies, as furnished by the Commissioners, there would at first sight appear to be some difficulty in understanding their reasons for so highly commending the Kent Company's water, and so unhesitatingly condemning that of the other companies, if we are to take as our guide the "previous sewage or animal contamination," on which so much stress is laid. It is hard to comprehend why, if river or flowing water which exhibits any proportion, however small, of "previous sewage or animal contamination," is to be regarded as suspicious or doubtful, the water in wells, say 100 feet deep, may be allowed 10,000 pints in 100,000, or 1 pint in 10, and may yet be regarded as reasonably safe. For, in these deep wells, if at no great distance from a river such as the Thames, it by no means follows that there is not some amount of comparatively direct communication through which water may trickle rather than filter, and not improbably the river-water below London is more objectionable for drinking purposes than it is higher up the Thames.

Let us for a moment compare the "previous sewage or animal contamination" of the water supplied by the different companies deriving their water from the Thames and Lea with that of the Kent Company's water. I take the average of the different analyses of each, as given at p. 270 *et seq.* of the Report:—

West Middlesex .....	3 083
Grand Junction .....	3 226
Southwark and Vauxhall .....	2 983
Lambeth .....	3 081
Chelsea .....	2 785
New River (excluding 1868) ...	2 751
East London .....	2 304

Average .....

Kent Company .....

or upwards of twice that of any one of the other Companies.

In this average, however, is included the water from the wells at Charlton and Belvedere, both of which are condemned

by the Commissioners. Omitting these two, the average is 3.780, which is still far higher than any of the others.

If we refer to the headings Organic Carbon and Organic Nitrogen, there can be little doubt of the superiority of the Kent Company's water, but judging merely from the statistics under the awful heading of "Previous Sewage Contamination," that of the River Companies seems the purest.

Why the source of supply from the two rivers should be condemned as hopeless it is hard to determine. This startling recommendation to give up the supplies of water on which London for centuries has depended, is brought forward just at a time when the most strenuous efforts are being made to purify the rivers Thames and Lea, and but a few years after the Commissioners on the Water Supply of the Metropolis, within whose proper sphere this question lay, had reported that with perfect filtration and efficient measures taken for excluding from them the sewage and other polluting matter, these rivers will afford water which will be perfectly wholesome and of suitable quality for the supply of the metropolis.

It is not for me to enter into the chemical part of this question, but I may venture to express a doubt whether considerably more might not be done by increased reservoirs for subsidence, and by artificial aeration of the water, in addition to filtration, so as to carry still farther the oxidation of any organic matter it may chance to contain.

I have less hesitation in strongly insisting on the fact that, irrespective of the New River water, the metropolis is already supplied with 9,000,000 gallons per diem, or at least 2½ gallons per head, of the deep-well water so highly commended, a quantity which would seem amply sufficient for dietetic and culinary purposes. I am, moreover, of opinion that the difficulty of distributing this water over the whole area by means of a second service distinct from that of the water for ordinary domestic purposes, though great, is by no means insurmountable. Even were the waters of the Thames and Lea unfit for drinking purposes, it is very far from being the case, that London is in the same plight as Coleridge's "Ancient Mariner," with—

"Water, water everywhere,  
Nor any drop to drink."

Enough is already there for all culinary and dietetic purposes, could it but be distributed; and to lay out incalculable sums of money and inflict incalculable mischief, in order to import chemically pure water with which to lay the dust in our streets, and to flush our sewers, seems "a multiplying improvement in madness, and use upon use in folly." We might almost as well import wine for the purpose; and in that case the Commissioners might find a historical parallel in the proclamation of Jack Cade:—"Here, sitting upon London Stone, I charge and command, that of the City's cost, the conduits run nothing but claret wine the first year of our reign."

As deeply interested in the water-power and general prosperity of one of the chalk valleys within the fated radius of thirty miles, I may have spoken strongly on this question, and may not unfairly be accused of having done so from interested motives. No one, however, can submit silently to an insidious attack upon the property which he is fairly entitled to hold; and after carrying on experiments, for upwards of twenty years, as to the percolation of water to the underground springs in a chalk area, I may claim some experience in such a question, and much doubt whether my judgment is seriously distorted. Even should the abstraction of water be spread over a much larger area than has been supposed, so as to reduce the amount conveyed away from any particular district; or even should the gross quantity required prove less than supposed, it may be left to any one who will take the trouble to investigate the matter, to determine whether the effects if wider spread, or somewhat diminished in intensity, would be much less injurious. Any injury from this cause would moreover be felt with double intensity at those seasons, which are of by no means unfrequent recurrence, when even without this gigantic artificial abstraction, the water in the upper portions of the chalk district becomes short, and wells which during the previous season may have had fifty or sixty feet of water in them run absolutely dry.

It now only remains for me to thank the Council, the officers of the Society, and the fellows at large, for the uniform kindness and consideration which they have extended to me, not only during the two years I have had the honour of being your president, but during the eight preceding years, during which I was one of your secretaries. I look back with pleasure on the prosperity which, during those ten years, the Society has

enjoyed, a prosperity which I hope may continue even in a greater degree, now that I quit this chair in favour of my old friend and fellow-secretary, Prof. Duncan, who is, in all respects, so thoroughly well qualified to fill it.

### SCIENTIFIC SERIALS

THE *Journal of the Chemical Society* for January contains the following papers:—Isomeric terpenes and their derivatives (Part V.), by G. H. Beckett and C. R. A. Wright, D.Sc. The authors in this paper describe the results of their experiments upon peppermint camphor from Japan. This substance has been shown by Oppenheim to be an alcohol (menthylie alcohol) of the formula  $C_{10}H_{16}OH$ , which by the action of dehydrating agents yields menthene,  $C_{10}H_{16}$ , this latter substance when treated with bromine yielding a tetrabromide  $C_{10}H_{12}Br_4$ , which on heating splits up into hydrobromic acid and cymene. The cymene thus obtained is identical with those previously obtained from other bodies. The authors have examined also the toluic acid from seven different cymenes, and conclude therefrom that "by the action of a large number of agents on terpenes and bodies related to them, absolutely the same cymene results, this cymene being identical with the paramethylpropyl benzene recently obtained synthetically by Fittica." Clove oil hydrocarbons and the liquid oil from camphor sublimation have also been examined.—On the decomposition of stearic acid by distillation under pressure, by George Johnston. The oils produced contain, among other products, mixtures of seven paraffins with the corresponding olefines.—On tolyl-phenyl, a new hydrocarbon, by T. Carnelley, B.Sc. The hydrocarbon is produced by the action of sodium upon a mixture of bromobenzene and pure bromotoluene (1 : 4) :—

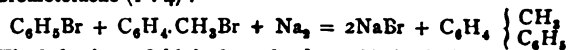

The behaviour of this hydrocarbon on oxidation is described, and also some of its nitro and amido substitution derivatives.—A simple form of gas regulator for maintaining a constant temperature in air-baths, water-baths, incubators, &c., by F. J. M. Page, B.Sc.—The remainder of the journal is devoted to abstracts from foreign periodicals.

THE January number of the *Ibis* commences with a paper by Mr. Robert Ridgway, of the Ornithological Department of the United States National Museum, Washington, entitled "Second Thoughts on the genus *Micraster*," in which he modifies his view previously expressed as to the reduction of the number of species, from an examination of the specimens in Messrs. Salvin and Godman's collection. The same author also writes on the genus *Glaucidium*, embodying the results of Mr. Sharpe's criticism of a previous paper by him on the same subject; *G. jardini* is figured.—Mr. D. G. Elliot has remarks on some type specimens of Trochilidæ from the museums of Neuchâtel and Florence; and notes on the Trochilidæ. In the former paper three of Tschudi's types—*Bourcieria inactivora*, *Heliodoxa leadbeateri*, *Leuciphus leucogaster*—are discussed. The male of the first is described; *Trochilus otero* (Tschudi) is the second; the third is one of two species only of the genus. Four of Sig. Benvenuti's types are described. *Mellisuga judith* is *Panoplitus flavescens*; *Mellisuga salvadorii* is the female of *Cyananthus cyanurus*; *Mellisuga ridolfii* is a female of *Eriocnemis vestita*, and *Polytmus cecilia* is *Campylopterus laxulus*. Mr. Elliot's second paper is on the genus *Lampropygia*.—Mr. C. Bygrave Wharton has Notes on the Ornithology of Corsica, describing 113 species, mostly from the west coast.—Mr. R. B. Sharpe gives Part I. of Contributions to the Ornithology of Borneo, with a plate figuring *Orthotomus borneonensis* and *Calamodyta doriae*, based on a collection made by Mr. Arthur Everett, *Circus spilomentus*, *Copsychus problematicus* (sp.n.), *Brachypodius immaculatus* (sp.n.), *Herpornis brunneus* (sp.n.), *Henicurus ruficapillus* are the species described for the first time from the island. Mr. Sharpe also determines two new species of South African birds collected by Mr. F. A. Barratt near the Macamac gold-fields. They are *Andropadus flavostriatus*, and *Bradypterus barratti*.—Mr. J. H. Gurney continues his notes on Mr. Sharpe's Catalogue of the Accipitres in the British Museum, discussing the Buteoninæ.—Mr. H. E. Dresser gives notes on Severtzoff's Fauna of Turkestan.—Prof. Newton writes on the assignation of a type to Linnæan genera, with especial reference to the genus *Strix*.—Messrs. H. Seebohm and J. A. Harvie Brown give notes on the birds of the Lower Petchora, based on an expedition made there last summer.



SOCIETIES AND ACADEMIES

LONDON

**Geological Society, Feb. 23.**—Prof. P. Martin Duncan, F.R.S., president, in the chair.—The Rev. David Charles, D.D., Thomas Musgrave Heaphy, C.E., William Smethurst, Edward Horatio W. Swete, M.D., and John Thomas Young were elected Fellows, and Prof. Joseph Gosselet, of Lille, a Foreign Correspondent of the Society.—The following communications were read:—On the greenstones of Western Cornwall, by Mr. John Arthur Phillips, F.C.S. In this paper the author brought forward evidence to show that the so-called "greenstones" of Penzance really belong chiefly to the following three classes:—*a.* Gabbros or Dolerites, in which the originally constituent minerals are either to a great extent unchanged, or, sometimes, almost entirely represented by pseudomorphic forms. *b.* Killas, or ordinary clay-slates. *c.* Highly basic hornblende rocks, exhibiting a tendency to break into thin plates; these under the microscope present the appearance of metamorphosed slates. Slaty rocks of a character intermediate between *b* and *c* also occur. In the Cape Cornwall district the "greenstone" are chiefly hornblende slates, sometimes with veins or bands of garnet, magnetite, or axinite. The rocks near the Gurnard's Head are almost identical with those of Mount's Bay. The crystalline pyroxenic rocks and metamorphic slates of the St. Ives district exactly resemble those of Penzance. The greenstones between St. Erth and St. Stephen's are probably altered ash-beds or hardened hornblende slates; unlike the hornblende and augitic rocks of the other districts, they do not occur in the immediate vicinity of granite, but elvan courses are always found near them. The percentage of silica in the two series of rocks is nearly constant; the hornblende slates contain about 10 per cent. less silica than the crystalline pyroxenic rocks, and there is an excess of iron oxides to nearly the same extent, their composition in other respects being very similar. The Killas is an acidic rock of essentially different chemical composition.—On columnar, fissile, and spheroidal structure, by the Rev. T. G. Bonney. Some of the above structures have comparatively recently been discussed by Mr. Mallet and Prof. J. Thomson. Both these authors agree in attributing columnar structure to contraction due to loss of heat while cooling, but differ in their explanation of cross jointing and spheroidal structure. In this paper it is sought to show that the principle proved by Mr. Mallet to be the explanation of the columnar structure is capable of a wider application. After a brief notice of some instances of columnar structure, the author described cases of a fissile structure seen in certain igneous rocks (especially in the Auvergne phonolites), closely resembling true cleavage, and often mistaken for it; also the tabular jointing of rocks; a peculiar form of this, where most of the segments are of a flattened convex-concave form; spheroidal structure and cup-and-ball structure. He showed by examples that Prof. Thomson's explanation of spheroidal structure was inadequate, and gave reasons for considering all these structures to be due to contraction. He also discussed more particularly the cup-and-ball structure, giving reasons for thinking that the spheroidal and the horizontal fissures were often to some extent independent of each other.

**Physical Society, Feb. 26.**—The president, Prof. G. C. Foster, F.R.S., in the chair.—The following candidates were elected members of the Society:—The Rev. R. Abbay, M.A., and Mr. W. Bottomley, sen.—Mr. A. Haddon exhibited and described a form of tangent galvanometer, so arranged that by the aid of an electric lamp an image of the needle can be projected on the screen, and its deflections thus made evident to large audiences. A horizontal beam of light falling on a mirror inclined at 45° is thrown vertically upwards. In its path it meets with a glass box containing a lozenge-shaped magnet about three-quarters of an inch long; above this needle is a graduated semicircle. The pivot supporting the needle is fixed in the centre of the glass plate which forms the bottom of the box. Above this box is a lens, and on the top of the whole is a second reflector parallel to the first. On either side of the needle is a hoop of stout brass wire, fourteen inches in diameter, one end of each hoop being insulated by a piece of ebonite, while the other end is in metallic connection with a brass ring which slides easily over the circular base of the instrument. The hoops are separated from each other by a distance equal to half

the diameter of either hoop, *i.e.*, 7 inches. The instrument having been placed at a distance from the screen equal to the focal length of the lens, and the needle brought to zero by rotating the graduated scale, the hoops are placed parallel to the magnetic meridian, and the instrument is ready for action. As an illustration of the manner in which the galvanometer is employed, Ohm's Law was proved in the cases of large and small external resistance.—Mr. O. J. Lodge, B.Sc., then described some investigations on which he has recently been engaged in reference to the flow of electricity in plane bounded surfaces, in continuation of a paper read before the Society in the early part of last year, by Prof. G. C. Foster and himself. After some introductory considerations, he pointed out that all the conditions of the flow of electricity are known for any number of poles in an unlimited sheet. The problem then consists in reducing cases of poles in bounded plates to corresponding cases in the unlimited plane, such that the flow conditions on the bounding line may be the same in both cases. The determination of these data, however, for limited planes of certain forms presents considerable difficulty. In studying questions of this nature there are two kinds of lines which must be considered. These are "equipotential lines," along which no electricity passes, and "lines of flow," across which no electricity passes. The boundary of any conducting surface will of course always be a line of flow, and, in a bad conductor, we can form an equipotential line by laying a band of copper in the required direction. If, therefore, in studying a surface of limited extent in contact with an electrode, we can find a point or points outside the surface such that, if they be made electrodes, the boundary line of the surface becomes a line of flow, we are at liberty to treat the surface as part of an infinite plane, and all the circumstances are therefore known. To take the simplest case, a straight line in an infinite surface will be a line of flow if equal sources be placed in pairs on opposite sides of the line so that one is the virtual image of the other; but, if the components of each pair are of opposite sign, it becomes an equipotential line. To make a circle of radius (*r*) an equipotential circle, we require a source A, within, and a sink B, without, such that  $C.A.C.B = r^2$ . To make it a line of flow we require two sources, such that  $C.A^1.C.A = r^2$  and an equal sink at C, the centre of the circle. The cases of an infinitely long straight strip and of a surface bounded by two straight lines inclined at an angle  $\theta$  were then referred to, and Mr. Lodge showed that the first requires an infinite number of external sources arranged on a straight line, and the second an infinite number on a circle except when  $\theta$  is a submultiple of  $\pi$ , the number then becoming finite. Diagrams of the images for certain cases of triangles and squares were also shown. The dimensions of the electrodes in contact with conducting surfaces are not matters of indifference. In a plane bounded by straight lines the electrodes within and without the boundary are of equal size, but when the boundary is a circle the areas of electrodes vary as the squares of their distances from the centre. It was then pointed out that not only the poles may be reflected in this way, but also every point in the sheet; and if the lines of flow or of potential are drawn inside a given circle for any arrangement of poles, the lines outside can be immediately obtained from them by inversion with regard to the centre of the circle by means of a Peaucellier cell. The author then described the manner in which the principle of Wheatstone's Bridge can be employed for tracing out lines of equal potential. If A and B be a source and sink on a conducting ring, and P any point on the ring between A and B and Q any point between B and A, then P and Q are of equal potential whenever  $\frac{PA}{PB} = \frac{QA}{QB}$ . If now the wire under the point P be flattened out into a surface, the above expression holds good for a certain line on that surface, which is therefore an equipotential line. Similarly by flattening out the wire under the point A, the line for which the expression then holds good is a line of flow for a certain distribution of poles. At this point the reading of the paper was adjourned to the next meeting of the Society.—Prof. McLeod exhibited a glass plate covered with a film of silver which had in places been deflagrated by means of Leyden jars, the poles being placed at varying distances apart. The form of the surface acted upon tended towards the Lemniscate of Bernoulli.

PARIS

**Academy of Sciences, Feb. 21.**—Vice-Admiral Paris in the chair.—The death of M. Brongniart was announced.—The following papers were read:—Meridian observations of small

planets, made at the Observatory of Greenwich (sent by the Astronomer Royal) and at the Observatory of Paris, during the fourth quarter of 1875, by M. Leverrier.—Theorems relative to the displacement of a plane figure, two points of which glide in two curves of any order and class, by M. Chasles.—Remarks on the laws of storms, by M. Faye. The older meteorology places the origin of great atmospheric movements in the lower layers, the new meteorology traces them to upper currents of the region of cirrus.—On fire-damp, by M. Faye. Instead of trying to suppress all causes of ignition (which is evidently impracticable, and has for result the allowing of large quantities of gas to accumulate till an explosion comes), would it not be well to supply the ceilings of the galleries with small open lamps every ten or twenty metres, so as to constantly burn the gas as it was presented? M. Berthelot gave some reasons against this method.—On the rotatory power of styrolène, by M. Berthelot.—On the invariability of great axes of the orbits of planets, by M. Tisserand.—Report on an apparatus of M. Vinot for recognising stars.—On the principles which ought to govern the construction of common lodgments (for men and animals), by M. Tollel. Outline of memoir. Barracks constructed, under the author's directions, for the eighth Army Corps, have realised an economy over the old system, of 300 francs per man, and 50 to 60 francs per horse, or 600,000 to 800,000 francs per regiment.—On the coefficient of dilatation of the air under atmospheric pressure, by MM. Mendeléeff and Kaiander. The most probable number is  $\alpha = 0.0036843$ , or about  $\frac{1}{272}$  instead of  $\frac{1}{273}$ , which has been adopted hitherto.—On some remarkable points in magnets, by M. Blondlot. If a very short magnetic needle, supported at its centre of gravity, be carried along near the surface of a magnet, then among its varying directions, those normal to the surface of the magnet are remarkable; the points to which they correspond M. Blondlot terms *orthogonal points*. One property of these points is that if a small magnetic body be placed at one of them, more mechanical work will be required to remove it from there to an infinite distance, than if it had been placed at any other neighbouring point on the surface of the magnet. Another property: the positions of equilibrium of a small magnetic body in relation to a magnet are precisely the orthogonal points.—Composition of the dark matter that is obtained in calcining ferrocyanide of potassium, by M. Terreil. It is a mixture containing, in minute division, cast-iron, magnetic oxide of iron, free carbons, and a small quantity of cyanide of potassium.—On the formation of anhydrous acids of the fatty and the aromatic series, by the action of phosphoric acid on their hydrates, by MM. Galand Etard.—On the products of the action of chloride of lime on amines, by M. Tscherniak.—Reply to the reclamation of M. Plateau, on the subject of digestion of insects, by M. Jousset. M. Jousset disputes M. Plateau's statement that in insects in the normal state, the digestive juices are all alkaline or neutral, never acid; also that the liquid secreted by the gastric coecums acts on starch but not on albuminoid substances.—M. Husson gave details of a process for testing, by means of sulphate of soda, the resistance of stones to frost.—M. Beyris described a convenient syphon, which consists of a caoutchouc tube; one end has a valve opening inwards, the other a stop-cock. The tube, stretched straight, is filled with liquid and the cock closed; you then put the valve end in the liquid, curve the tube, and open the cock.

Feb. 28.—Vice-Admiral Paris in the chair.—The following papers were read:—On the explosion of powder, by M. Berthelot. The chemical transformation is expressible, in every case, by a simultaneous system of very simple equations.—Researches on a sulphate which seems to contain a new oxide of manganese, by M. Fremy.—On the influence of mould on the nitrification of azotised substances of organic origin, employed as manures, by M. Boussingault. In sand and chalk there was little nitrification; it was in mould already nitrifiable, that all the azotised organic matters developed most nitric acid and least ammonia.—On fire-damp, by M. Faye. The ascent of the light protocarburetted hydrogen to the upper parts, takes place immediately, and it would there be burnt without danger. M. Berthelot replied.—On the methods of meteorology, by M. Sainte-Claire Deville.—Proposal made by Bouguer, in 1726, for obtaining from the log-books of all ships, by professors of hydrography, information useful to navigation, by M. de la Gournerie.—M. Dupuy de Lome, in presenting a work by M. Ledieu, "Les Nouvelles Machines Marines," recommended it for the application made of the mechanical theory of heat, to comparative examination

of new engines.—Report on the memoir published by Messrs. Noble and Abel, "Researches on explosives, fired gunpowder."—Report on a memoir of M. Alb. LePlay, on a system of irrigation of meadows by means of rain-water in the mountainous and impermeable strata of Limousin.—Note on the meridian circle of the imperial observatory of Rio de Janeiro, by M. Liais.—The heart experiences at each phase of its revolution changes of temperature which modify its excitability. Note by M. Marey. The cooling corresponds to the phase of less excitability.—On the oil of Elaëococca, and on its solid modification produced by the action of light, by M. Cloëz.—Means of preventing explosions of fire-damp, by the employment, *a tergo*, of compressed air, by M. Buisson. He would convey pure compressed air in pipes to the bottom of the mine, and drive the vitiated air outwards.—Note on the tracing of gearings by arcs of a circle; improvement on the method of Willis, by M. Léauté.—On some combinations of titanium (second note), by MM. Friedel and Guérin. This treats of the oxychloride and the sesquioxide.—On sulpho-phenylurea, by M. de Clermont.—On the antiseptic properties of borax, by M. Schmetzler. The body of a horse which had lain four months in a layer of borax earth in California, was quite fresh and odourless, the pupil clear and bright, the hair supple and well attached.—Reply to M. Glénard's last note on the rôle of carbonic acid in the phenomenon of spontaneous coagulation of the blood, by MM. Mathieu and Urbain.—On the reducing sugar of raw sugars, by M. Müntz.—Note on a new genus of fossil Entomostroaca from the carboniferous system of Saint Etienne (*Palaeocypris Edwardsii*), by M. Ch. Brongniart.—On the half November oscillation in America, by M. Hinrichs. This is as well marked, from Iowa up to Newfoundland as in Europe and Algeria. Curves are given.—On the manufacture of superphosphates destined for agriculture, by M. Millot. The retrogradation of these, after their ordinary preparation, is due to the presence, in the natural phosphates, of sesquioxides, and especially of sesquioxide of iron.—On movement in the hairs and foliar laciniations of *Drosera rotundifolia* and in the leaves of *Pinguicula vulgaris*, by M. Hecke. This refers to the action of chloroform and sulphuric ether placed near the plant under a bell jar. The effect was at first irritant, but, where the dose was not too strong (e.g., three drops of chloroform) the organs soon returned to a state of repose. The jar having been removed, it took eighteen minutes, in this case in open air, for the irritability to be removed.—Meteoric combustions, by M. De Fonvielle. He suggests a method of ascertaining aerostatically the amount of dust in a given layer of air. At the end of a pole is placed a surface of some square decimetres, held horizontal, one of the sides covered with very pure glycerine. Let H be the vertical height traversed by the aërostat, S the sticky surface in square decimetres, and  $\rho$  the weight of dust received. The amount in a cubic metre will be  $\frac{\rho \times 100}{HS}$ .—Reclamation of priority concerning the mechanism of an electric lamp, presented by M. Girouard.

## CONTENTS

PAGE

CAROLINE HERSCHEL. By Rev. T. W. WEBB . . . . .	361
MORSEY'S "NEW GUINEA AND POLYNESIA" . . . . .	363
OUR BOOK SHELF:—	
Houghton's "Sketches of British Insects" . . . . .	365
Vincent's "Year Book of Facts" . . . . .	365
LETTERS TO THE EDITOR:—	
Prof. von Siebold and the Freshwater Fishes of England.—Prof. E. RAY LANKESTER, F.R.S. . . . .	366
Seasonal Flower Distribution and the Radiometer Vagaries.—Wm. ACKROYD . . . . .	366
D-line Spectra.—Major W. A. ROSS . . . . .	366
The Screw-Propeller in Nature.—ALFRED GEORGE RENSHAW . . . . .	367
The Migration of Species.—Rev. M. DASENT . . . . .	367
The Three Kingdoms of Nature.—NURSERY? . . . . .	367
OUR ASTRONOMICAL COLUMN:—	
The Variable Star $\beta$ Persei (Algol). . . . .	367
Conjunction of Jupiter and $\beta$ Scorpii . . . . .	368
Note on Biela's Comet . . . . .	368
THE NEW GERMAN SCIENTIFIC EXPEDITION TO THE OHIO . . . . .	368
UNIVERSITY REFORM . . . . .	368
SCIENCE AND ART IN IRELAND . . . . .	370
SCIENTIFIC INSTRUCTION AND THE ADVANCEMENT OF SCIENCE . . . . .	371
PHYSICAL SCIENCE IN SCHOOLS. By JAMES M. WILSON; WILLIAM A. TILDEN . . . . .	371
PRINCIPAL CHARACTERS OF THE DINOCERATA ( <i>With Illustration</i> ) . . . . .	374
NOTES . . . . .	374
ANNIVERSARY ADDRESS OF THE PRESIDENT OF THE ROYAL GEOLOGICAL SOCIETY, JOHN EVANS, F.R.S., II. . . . .	376
SCIENTIFIC SERIALS . . . . .	378
SOCIETIES AND ACADEMIES . . . . .	379

THURSDAY, MARCH 16, 1876

## UNIVERSITY REFORM

THE discussion in the House of Lords on the second reading of the Oxford University Bill cannot be said to have been satisfactory. Those who took part in the debate were, almost without exception, Oxford men with high honours; and they evidently represented the opinions of the majority of Oxford residents. It is, indeed, a singular circumstance that there should be among the peers so large a proportion of persons who have gained first-classes, and who have themselves held "idle fellowships;" a proportion greater than can be found in the House of Commons. But the experience contributed by them, however valuable, ought not to have monopolised the whole discussion of the matter in a legislative assembly. Such experience is of the nature of one-sided evidence, which should be heard and weighed before a decision is reached; but which cannot be permitted to substitute itself for a thorough discussion of a subject of national importance. This aspect of the debate is the more to be regretted, because it will tend to encourage the feeling, which seems to be already predominant at Oxford, that the limited vision of the present race of University residents, together with their own pecuniary interests, is to determine the course of academic reorganisation. The hopes raised by Lord Salisbury's first speech will be dashed to the ground, if such petty matters as the difference between the legislative functions of convocation and congregation, the influence of the parochial clergy on either body, or the period during which an "idle fellowship" should be tenable, are thrust forward as the supreme considerations. These subjects, no doubt, require to be discussed and settled, once and for all; and it is, perhaps, an omission that they have not found a place in the Government measure. But no misfortune would be graver than if it were to go to the country, as the Liberal peers seem to wish, that the Bill does not contain principles of reform, in comparison with which these details sink into their proper insignificance.

Lord Salisbury's speech was welcomed, certainly by men of science, and we believe also by all those whose ideal of a university is not confined to what they learned during their adult school-days at Oxford or Cambridge, because he unhesitatingly announced two new principles, upon which the whole merits of the scheme turn. He proposed that the University should be endowed at the expense of the colleges, and that scientific research should take its place in the University by the side of religion and learning. Now, these two main principles were entirely disregarded in the discussion of last Thursday; or, when they were referred to, were "damned with faint praise." The Archbishop of Canterbury, whose speech was, on the whole, worthy of his position, professed himself ignorant of the precise meaning to be attached to the word "research;" as if there had not been, during the last three years, abundance of discussion on the subject in the press, and as if it had not been defined in the report of a Royal Commission. Both Lord Carlingford and the Earl of Morley reproduce the old argument, which to those familiar with the topic has long ago been worn

threadbare, that the endowment of teaching professors is the only endowment of research which is either desirable or possible. It is not necessary in these pages to show how entirely is this objection founded upon ignorance. It is enough to observe that those very persons who are the most ardent advocates of the present system of awarding fellowships as sinecures, express themselves as most fearful of the danger of opening these sinecures to the physical sciences, and imposing on their holders the duty of original investigation. Lord Morley was in his day a distinguished classical student at Balliol College; but, so far is he from understanding the new demands of the present time, that he concluded his speech with the following idle peroration:—"I trust that the University, reinforced by the proposed aids, will take up the proud position *she has so long held*, and will, I hope, long continue to hold, as *the head and centre of all science and learning*." With regard to the proposal to satisfy the admitted wants of the University out of the surplus income of the colleges, hardly a word was said. Everybody was too anxious to support the condemned system of "idle fellowships," to bestow a thought upon the profitable uses to which these misapplied funds might be devoted. And so the House of Lords read the Oxford University Bill a second time, without any deliberate consideration of its essential features, but evidently prepared to dispute in Committee over all sorts of uninteresting details.

There is, however, one important point, on which not only the House of Lords, but also the nation at large, seems in danger of being misled. This has reference to the intentions of founders, and the original object for which fellowships were endowed. It seems to be universally assumed that the intention of the founders was primarily to promote religion, and secondarily education. "Orignally," said the Earl of Carnarvon, "religion was the object of the University; then, after a struggle, learning was added;" and now it is proposed to complement the two former by the addition of research. Against the theory implied in the last clause nothing can be urged; but the two former statements represent a most perverted view of history. The Archbishop of Canterbury, who ought to be better informed, is equally wrong, though less positive. "We know very little, perhaps, now of the exact intentions of the founders. We do know that many of them were desirous to benefit their own souls by having masses celebrated in their own Colleges; . . . but when that is said, we know very little more than that they had a general desire to promote education." Now, as a matter of fact, there is no historical evidence whatever, to show that the University or the colleges commenced with religious observances, and that learning had a hard fight to enter in. So far as we know anything about the condition of the University of Oxford in the pre-collegiate epoch (and it is true that our knowledge of that period is very small), it is certain that the University of Oxford, like the sister University of Paris, was an assembly of teachers and students, by no means of priests and monks. Study was the primary object then, as later, to which religious functions were only subordinate. No doubt the majority of the learned men were *clerici*, i.e., in orders, but so were the lawyers at that time, and the Universities are no more ecclesiastical corporations than

are the Inns of Court. From the date of the foundation of the first college our knowledge becomes more definite. The original statutes have been preserved, and were published to the world by the University Commissioners about twenty years ago. The evidence, therefore, of the intentions of the early founders of fellowships is abundant, and it is also decisively clear. It was, no doubt, desired that the study of Theology should be supreme, and ample provision was made for divine worship; but it must be recollected that in those days Theology included Law, and did not exclude Natural Philosophy. But what the founders had foremost in view, as might easily be shown by copious extracts from their statutes, was not religion, or even education, but advanced study. The few earliest colleges make no reference at all to the endowment of teaching. Their fellowships were established "for the support of indigent scholars in the University of Oxford, who are bound to study and make progress in the divers Sciences and Faculties." The function of teaching was left to be performed by the University, and all those who had taken the higher degrees enjoyed the privilege, as they were under the obligation, of giving instruction. "To study, not to teach, was the business of the Fellows. The founder of Queen's College has even expressly stated that he intends his benefaction to relieve his Fellows from the necessity of teaching." The full period of study required for the degree of Doctor lasted for thirteen or nineteen years, varying in the different faculties; and the fellowships were intended to support poor students during this long season of probation. Nor must it be supposed that Theology and the Classics were the only subjects meant to be encouraged. Many of the founders made provision for the study of medicine; at New College Astronomy is specially mentioned; and William of Waynflete, in the statutes of Magdalen, expressly prescribes Natural Philosophy as one of the three departments of knowledge which the Fellows were to cultivate. Other instances of a similar nature might be quoted; but nothing further is required to prove what the colleges themselves will scarcely admit, that the fellowships were given not as prizes to stimulate clever boys, nor as subsidies for academical teachers, but to promote mature study. The appeal, therefore, to the intentions of the founder does not lie in the mouth of the advocates of the existing order of things, but is one of the strongest arguments that can be used by those who support the endowment of research, which turns out to be merely the restoration of the old practice.

#### MINERALS OF NEW SOUTH WALES

*Mines and Mineral Statistics of New South Wales.*

Compiled under the direction of the Hon. John Lucas, M.P.; also "Remarks on the Sedimentary Formations of New South Wales." By the Rev. W. B. Clarke, M.A., F.G.S. (Sydney, 1875.)

THE volume now before us is a companion to that we reviewed recently in this journal on the minerals and rocks of Victoria,\* and like it has been called forth by the necessity of cataloguing and describing the collection of

\* "Rocks and Minerals in the Melbourne Museum," NATURE, vol. xiii. p. 165.

specimens exhibited at the Metropolitan Intercolonial Exhibition held at Sydney in 1875, which consisted of rock-specimens, fossils, samples of coal, ores of iron, and other metals, collected by the Examiner of Coal-fields, the Government Geologists, and furnished to a large extent by the owners of mines, the whole being arranged by Mr. C. S. Wilkinson, Government Geologist to the colony. The volume also contains statistics of the minerals raised in 1874 and preceding years. These do not pretend to be more than approximations, but they are sufficient to enable us to see the strides this great colony is making in the development of those mineral treasures which are almost lavishly bestowed throughout the area already explored, and which give promise of still wider distribution; meanwhile, the authorities seem fully alive to the importance of having accurate returns. It is stated that "the arrangements for the future are such as it is hoped will secure the collection, publication, and preservation of complete and authentic returns, and no pains will be spared to render our records of the past more complete than they are at present."

It may interest our readers, however, to be put in possession of the latest returns, which are for the year 1874, and are as follows:—

	Total Value.
Gold ... ..	£30,656,246
Coal ... ..	6,565,328
Tin ... ..	866,461
Copper ... ..	807,476
Oil-shale (Kerosine) ... ..	261,414
Silver ... ..	77,216
Iron ... ..	15,434
Antimony ... ..	897
Total ... ..	£39,220,472

It is impossible to rise from a perusal of this volume without the conviction that the resources in not only the precious metals, but the more useful minerals—coal and iron—are practically inexhaustible, and that being developed by British colonists are destined, or are at least calculated, to produce a nation rivalling the mother-country in manufacturing industry. We gather that the colonists now fully perceive this themselves; and for this they are to no small degree indebted to the voluntary labours of that veteran geologist, the Rev. W. B. Clarke, who for a quarter of a century has been engaged in exploring the interior of the continent and unfolding its geological structure. A more detailed survey is now in progress, which has been attended with highly encouraging results; and it would be well for intending settlers to possess themselves of all the available information afforded by the maps and reports of the geological surveyors, as by this means they may become the happy possessors of treasures lying below the surface. Meanwhile, sufficient is known to enable us to give a short sketch of the physical features and geological structure of this great colony.

New South Wales is bounded on the south by the Murray River—separating it from Victoria—and on the north by a line generally corresponding to the 29th parallel, by which it is separated from Queensland.

The coast line extends from Cape Howe to Point Danger, a distance of nearly 700 miles, with the Ports of Wollongong, Sydney, Newcastle, and the Clarence River at intervals. At a distance from the coast-line, varying

from 30 to 150 miles, runs the Cordilleras range of mountains—sometimes serrated, at others tabulated—and reaching elevations of 6,000 or 7,000 feet. “The highest point in all Australia,” is at the head of the Murray River and near the boundary with Victoria, being, according to Strzelecki, 6,500 feet above the sea, but according to the later observations of Clarke 7,175 feet. From the base of this range the country extends in a spacious plain to the sea margin, and on the west into the great central wilds of South Australia, and the regions watered by the Darling, the Lachlan, and the Murrumbidgee Rivers. The central tract from the coast to the Cordilleras is occupied by the Sydney coal-field, having a sea-board of about 200 miles, and an area of over 15,400 square miles—as estimated by Mr. J. Mackenzie, F.G.S., Examiner of the Coal-fields—richly stored with coal, and, along its western margin, with iron. Newcastle in Australia is a coal-shipping port, as well as the Newcastle in the old country, and from the number of projected lines of railway communicating with it, it is clear that the neighbouring collieries are destined to distribute mineral fuel into the far interior, as well as to the ocean steamers and coast towns.

Another point of similarity between the mother-country and her daughter, dates from the far-off ages of Geologic time; for Mr. Clarke and other geologists have clearly demonstrated that the coal-beds of New South Wales and of Britain were elaborated in Nature’s workshop during the same Geological period; and on comparison it will be found that the general succession of the members of the Carboniferous series in the North of England and Scotland have their equivalents, as nearly as possible, at the Antipodes. This may be accidental, but it is at any rate a striking illustration of the prevalence of similar conditions over wide areas of the globe during the Carboniferous period.

The general succession of the Upper Palæozoic series of New South Wales and their possible British representatives is as follows:—

NEW SOUTH WALES.	GREAT BRITAIN.
(e) <i>Wianamatta Series</i> .—Shales, with fish ( <i>Palæoniscus</i> ), fresh-water shells, and plants. 500 feet.	(e) Possibly Permian Beds.
(d) <i>Hawkesbury Series</i> .—Chiefly sandstones, with ferns ( <i>Glossopteris browniana</i> ). 1,000 feet.	(d) Upper Red Sandstone of the Glasgow district.
(c) Upper Coal-measures of Newcastle, &c., with plants—as <i>Glossopteris</i> , <i>Sphenopteris</i> , Conifers—with sixteen coal-seams over three feet in thickness. 480 feet.	(c) Upper coal-measures of Scotland, with Millstone Series at base.
(b) <i>Upper Marine Beds</i> .—Shales, sandstones with coal-seams, &c., with numerous Lower Carboniferous shells ( <i>Spiriferæ</i> , <i>Producti</i> , Crinoidal stems. 350 feet. <i>Lower Coal-measures</i> .—Shales, sandstones with similar fossils. 100 feet.	(b) Lower coal-measures of Scotland of the Carboniferous Limestone age.
(a) <i>Lepidodendron Beds</i> .—Shales and sandstones, with Carboniferous plants ( <i>Cyclopteris</i> , <i>Knorria</i> , <i>Sigillaria</i> , <i>Lepidodendron</i> ) resting unconformably in Devonian beds.	(a) Calciferous Grit Series.

Though Prof. M’Coy considers, on palæontological grounds, that the upper beds of the above series may be of Mesozoic age, we are unable to concur in that view,

and consider Mr. Clarke’s demonstration of their Palæozoic age conclusive. The whole series, with the exception of the Wianamatta shales, are conformable throughout, and the differences in the flora and fauna between the Upper and Lower series are not greater than those between the Upper and Lower Carboniferous beds of Great Britain.

The quantity of coal raised in 1874 amounted to 1,304,567 tons, and the returns of the out-put since 1829 show a steady annual increase. The demand in the future is likely to exceed the supply; but collieries are being rapidly opened up where means of transport to the markets are available.

Amongst the most valuable products of the coal-fields are the “Kerosine shales,” a kind of oil-shale or cannel, of which 96,141 tons were raised in 1874 from three mines. These beds resemble the oil-cannel of Torbane Hill in Scotland, and the associated shales from which the celebrated paraffin oil is extracted. Some of these seams are exceedingly rich, and are used for the production both of petroleum and gas. Beds of clay-ironstone, besides large veins and masses of brown hæmatite, occur towards the base of the Carboniferous rocks in several places, amongst which those of Wallerawang are likely to become of the highest importance. A detailed account of the various ores has been drawn up by Prof. Livesidge, accompanied by chemical analyses, which show that the ores are rich, containing from 40 to 56 per cent. of metallic iron. Other iron-producing works have been established at Lithgow Valley and Berrinia, but space forbids fuller reference. For the accounts of the gold, silver, and precious stones, including the diamonds of Inverell and Armidale, we must refer to the pages of the book itself, which, though full from cover to cover of valuable information, suffers much from the want of a good index.

OUR BOOK SHELF

*Geological Sketches*. By L. Agassiz. Second Series. 8vo. pp. 229. (Boston, James R. Osgood and Co.; London, Trübner. 1876.)

No better idea can be given of this little book than is obtained from the first few words of the preface. “This edition of the ‘Geological Sketches’ offers nothing new to the public. Taken in connection with the former one, it only presents in a permanent form and in their original sequence all the geological and glacial papers contributed by Prof. Agassiz to the *Atlantic Monthly* during a number of years.” It consists, in fact, of five chatty papers on glacial phenomena in various parts of the world, written in that kind of personal manner that makes them read like a book of travels or a chapter of an autobiography. It is perhaps chiefly from this latter point of view that this collection is interesting. Whatever may be Agassiz’s position with respect to the interpretation of the phenomena of recent glaciers, there can be no question but that to him is due the first recognition of their former existence and extent in this country and elsewhere where they now no longer exist. From the day of that discovery in 1840, “Glacial Geology,” now a department by itself, has been steadily growing, till investigations into the work of ice has been carried into almost every part of the globe, not excluding the Tropics. Agassiz has therefore a fair right to the title of Father of Glacial Geology. He gives us here an interesting sketch of his first opening up this ground by his visit to Scotland, and puts in a popular

form his theory of the formation of the parallel roads of Glen Roy. We have a glimpse of his well-known tone of thought in the question which he says, in one of these essays, one *naturally* asks, "What was the use of this great engine set at work ages ago to grind, furrow, and knead over, as it were, the surface of the earth?" and finds as an answer that it was a special provision for making the surface fertile by ploughing it deeply and preparing it as a grain-growing soil. Perhaps we could not have a better justification for calling teleological arguments "barren virgins," with Prof. Huxley, than this instance, for if the glacial period were a special provision for the wants of man, we should be cut off from the conclusions, now almost proved by evidence, first that man existed in these isles *before* the glacial epoch, and second, that this epoch should rather be called the *last* glacial epoch, as there have been similar ones throughout geologic time. This last conclusion, involving the extension of glacial conditions through a long range of time, at various intervals, a conclusion largely due to Prof. Ramsay, will be only second in importance, when fully established to its extension in space so conclusively proved by Agassiz and others. The longest of the five papers in this collection is the most recent: "On the Physical History of the Valley of the Amazons," in which he gives his reasons for considering the whole of that valley to have been filled with ice, and to have extended much further to the east at that period. This is scarcely the place for discussing conclusions that have been made known in a larger work with the evidence stated; but we may call attention to the fact that no furrows, striae, or polished surfaces are anywhere to be found there, and the evidence, therefore, is not of that positive character that so remarkable a conclusion would seem to demand. The country is so little known that at any time fresh observations might modify any conclusion drawn from negative or secondary evidence.

*To the Victoria Falls of the Zambesi.* Translated from the Original German of Edw. Mohr. By N. D'Anvers. (London: Sampson Low and Co., 1876.)

In noticing the German edition of this work (NATURE, vol. xii. p. 231) we said that it was well worth translating into English, and we are therefore glad to see that Messrs. Low and Co. have put it within reach of the English reading public. The work is full of interest, and is a really valuable contribution to our knowledge of the region traversed—from D'Urban to the Victoria Falls of the Zambesi. Mr. D'Anvers has done his work of translating very satisfactorily, judiciously omitting a few passages which deal with matter already brought before English readers. All the original illustrations seem to have been retained, including the brilliant but tasteful chromo-lithographs. A new route-map, on a larger scale than the one in the German edition, has been constructed for this translation.

*Sport in Abyssinia, on the Mareh and Tackazee.* By the Earl of Mayo. (London: John Murray, 1876.)

THE Earl of Mayo seems to have published this book to show intending sportsmen in Abyssinia how not to do it. His expedition, organised solely for sport, was rather an unfortunate one. Very little sport was obtained by the author, and ere he had well set to work, he was taken so ill that he had suddenly to return to Massowah to catch a homeward-bound steamer. The work contains some shrewd observations on Abyssinian people and affairs, and will no doubt be appreciated by sportsmen.

*Health in the House.* By Catherine M. Buckton, Member of the Leeds School Board. Sixth edition. (London: Longmans and Co.)

THIS useful book consists of twenty-five lectures on Elementary Physiology in its application to the daily wants of Man and Animals, delivered to the wives and children

of working-men in Leeds and Saltaire. It will be found a great help to national schoolmasters and others engaged in education, who may desire to give their pupils clear ideas of the structure and life of man, together with a practical knowledge of the necessity of fresh air and cleanliness in their daily life. At the end of the book will be found questions on some of the lectures, a list of works useful for preparing lectures, and tables of foods most suitable for health.

### LETTERS TO THE EDITOR

[The Editor does not hold himself responsible for opinions expressed by his correspondents. Neither can he undertake to return, or to correspond with the writers of, rejected manuscripts. No notice is taken of anonymous communications.]

Corrections in the Address of the President of the Royal Microscopical Society (Vol. xiii. p. 332)

By some unaccountable oversight in copying out the data for calculating the number of molecules of liquid water, the factor expressing the specific gravity of the vapour of water was omitted, and afterwards overlooked. The number of atoms of a gas should really be multiplied by  $\frac{1}{2} \times 770 \times \frac{1}{6239} \times \frac{1}{2} = 617$ . But

moreover, on reflecting on the relative reliability of the determinations by the various authors of the number of the atoms in gases, it appears that in taking the mean, greater weight ought to be allowed to that by Clerk-Maxwell, since founded on more recent and accurate data. If his results be considered as of equal value to those of Storey and Thomson (combined, the mean would be reduced to so nearly the same extent as the molecules of liquid water would be increased by the above-named correction, that the numbers given in the address may be considered to be as good an approximation to the truth as can be determined in the present state of the question, and none of the general conclusions need be modified. H. C. SORBY

### Vivisection

I HOPE that you will permit me to call attention to a passage in the "Statement of the Society for the Protection of Animals liable to Vivisection on the Report of the Royal Commission on Vivisection" (published by the Society, 1, Victoria Street, Westminster). Under the heading "Extracts of Evidence on Extension of the Practice of Vivisection, and Abuses connected therewith," the following words occur (p. 22):—

"Dr. Crichton Brown describes:

"Forty-six animals sacrificed in trying if chloral were antagonistic to picrotoxine. Cases of poisoning by picrotoxine are of very rare occurrence. Twenty-nine animals used in Ferrier's series."

I will leave your readers to judge of the kind of impression which this passage tends to give; I will only ask, is it in accordance with the ordinary principles of justice that the following important details (also gathered from Dr. Crichton Brown's evidence) should be entirely omitted by the compilers of the Statement?

1. "Picrotoxine is sold in large quantities as Barber's poisoned wheat for the destruction of birds" (3218). Concealed in an edible substance, this poison must therefore pass largely through the hands of an ignorant and careless class of persons.

2. Dr. Crichton Brown "succeeded in proving that after a poisonous dose of picrotoxine has been given to an animal, if a dose of chloral be given subsequently the animal will recover" (3163).

3. The operation to which the animals sacrificed were subjected "consisted in the introduction under the skin of a little fluid by means of a perforated needle . . . the pain is infinitesimal" (3218).

4. The after effects are convulsions and death, and "convulsions themselves are not necessarily painful" (3218). This is proved by direct and distinct evidence.

5. In consequence of the use made of Barber's poisoned wheat, "numbers of animals die of it in convulsions every year" (3218). It is almost incredible that a course of action which may result in saving human life should be mentioned in the manner above quoted; while a course of action identical as far as the ultimate effect on the animals is concerned, in which



there is no question of saving life, and which is repeated a thousand times for the private benefit of its performers, is omitted!

6. In Dr. Ferrier's research, anaesthetics were so "carefully and liberally given," that five animals out of the twenty-nine sacrificed "died before they were touched or operated on in any way" (3178).

FRANCIS DARWIN

Down, Beckenham

The Use of the Words "Weight" and "Mass"

IN a letter with the above heading published in NATURE, vol. xiii. p. 325, Mr. Bottomley has recommended that the ambiguity of the word weight shall be avoided by using the phrase "the gravity of a pound" when we mean the downward force due to the earth's attraction upon a pound weight.

The ambiguity against which Mr. Bottomley wishes to guard is a very real one. Not to speak of common usage, which allows three meanings of the word weight to be loosely intermingled, we have two of these meanings adopted into scientific nomenclature. The universal practice in chemistry is to employ the word weight to signify mass, and anyone may satisfy himself that this use of the word could not be dispensed with in that science by making the attempt to substitute other forms of expression for the convenient words weight, heavy, light, heavier, lighter, as used by chemists. On the other hand, physicists have generally employed the term to signify a force, and the best writers on mechanics are careful to avoid using it to express mass.

But I fear Mr. Bottomley's remedy, if adopted, would introduce quite as serious, perhaps a more serious, ambiguity. Gravity is an acceleration. When we say that gravity is less in a balloon or in a mine than at the surface of the earth, or greater at Glasgow than at Manchester, we are speaking of alterations of *g*—the acceleration due to the earth's attraction; and it would create confusion to employ this word to designate forces also.

But a practice which I adopted in lecturing on mechanics in Queen's College, Galway, many years ago seems to meet the difficulty, and may perhaps recommend itself to other teachers. It is to use the word *gravitation* in the proposed sense.

If this were done, *gravity* at Glasgow would mean an acceleration; the *gravitation* of a kilogramme there would be a force; and *weight* would continue a word of doubtful import, to be judged of by the context, sometimes used for a force, sometimes for a mass, and sometimes for those pieces of metal which are employed as measures in weighing (as in the phrases "a set of weights," "a gramme weight"). In further support of my suggestion, it may be observed that the proposed use of the substantive *gravitation* follows legitimately in the English language from the established meaning of its correlative, the verb *gravitate*.

I would wish to take this opportunity of also recommending a prefix which I have found of the utmost service both to students by assisting them to acquire clear conceptions with ease, and to myself. We use the prefix *hyper* placed before the name of any metrical weight, as *hyper* decigramme, *hyper*-gramme, *hyper*-hektogramme, *hyper*-kilogramme, *hyper*-tonne, to indicate those forces of the absolute metrical series which are slightly larger in amount (about 2 per cent. more) than the gravitation at the earth's surface of the decigramme, gramme, hektogramme, &c., respectively.

When a student has to use weights as forces, as he must in the laboratory, he should be trained from the beginning to think of them in their relation to the neighbouring absolute forces. For instance, if he uses a hektogramme to exert a pressure, he should be encouraged to think of it rather as  $\frac{2}{10}$ ths of a *hyper*-hektogramme (which is a force) than as a hektogramme (which is more properly a mass). This will also keep prominently before his mind that the amount of the pressure depends on the station at which the experiment is made.

G. JOHNSTONE STONEY  
Queen's University, Ireland, March 9

MR. BOTTOMLEY remarks in his letter on weight and mass that appeared in NATURE, vol. xiii. p. 325, that "During the present session we have aided ourselves in Glasgow with four very important helps to the teaching of the kinetic system of force-measurement. . . . The third help is the construction by Prof. Thomson, for the first time so far as I know, of spring balances for indicating poundals and kilodynes."

Will you permit me to point out that about three years ago Prof. Ball, when introducing the C. G. S. system of units into the course of mechanics at this college, had a series of dynamometers in absolute measure specially constructed by Messrs. Salter, of West Bromwich. These dynamometers were exhibited at the Bradford meeting of the British Association, and will also be seen at the forthcoming Loan Exhibition at the South Kensington.

W. F. BARRETT

Royal College of Science, Dublin

Metachromism

MR. FLINDERS PETRIE in his interesting letter (vol. xiii. p. 348) criticises the abstract of my paper which appeared in NATURE some weeks ago. Before considering his communication, I would remark that my argument against Schönbein's theory accounting for metachromism is based upon the colour relation which he mentions. I gave a small table of anhydrous binary compounds which conform to the rule, and that table includes the chlorides of chromium which Mr. Petrie has pushed out into the cold. The relation is thus referred to:—"Those compounds in a series which show the highest amount of the basylous element have the most refrangible colours." So far as I am aware, it is there announced for the first time.

For the sake of clearness we will first examine Mr. Petrie's proposition:—"Increase of the electro-negative element produces a colour-change towards the red end of the spectrum, and *vice versa*."

Increase of the electro-negative element is accompanied by less refrangible colours, but to say that this increase produces the change is going farther than the observations warrant, is, in short, opposed to fact. For example, if we take the series of oxides of chromium which he gives—Cr<sub>2</sub>O<sub>3</sub> green, CrO<sub>3</sub> yellow green, CrO<sub>2</sub> red, I fail to see that increase of the electro-negative element, *i.e.*, colourless oxygen produces a change towards the red end, or, on the contrary, that decrease in the positive element does the same. The facts seem rather to show that colour in any body is dependent upon the proximity of its molecules, since we find bodies which, with like chemical composition but different densities, have different hues.

The metachromatic scale given on page 298 is not intended to be absolute, and may, in fact, need a little modification with the accession of more knowledge. But certainly Mr. Petrie's remarks do not affect it, because (1), the colour gradation he refers to is attended by chemical differences, whereas in metachromatic phenomena we have purely physical alterations; (2) white does not come between yellow and blue, either in the "natural" or in the metachromatic arrangement. For if by "natural arrangement" he means that of the pure spectrum, then green is what intervenes between blue and yellow, and white has its nearest counterpart in the ultra-violet grey. Quite recently this part of the spectrum has been termed "silvery grey" by M. Sauer. Independently of this, however, I was led to place white in the ultra-violet part of the metachromatic scale by certain mineralogical facts which I shall not trouble your readers with detailing here.

The assertion, then, that white comes between yellow and blue, would seem to rest upon the colour relation found to obtain between the oxides of the alkali metals, which really is not worth much, because of the little we know about the sub-oxides; and because even the chief series he gives, that of sodium, is an exception to the rule, Na<sub>2</sub>O<sub>2</sub> being pure white (Watt's "Dictionary," vol. v., p. 340), and not orange, as Mr. Petrie states; and, finally, because we cannot fairly compare the order of colour we see in the binary compounds with what we get in metachromatic phenomena, although to a great extent there is a colour parallelism which is remarkable.

WM. ACKROYD

Royal College of Chemistry, South Kensington,  
March 4

The U.S. Survey Publications

IN NATURE, vol. xiii. p. 314, I observed a note upon the rumour that the publication of Prof. Hayden's Geological Reports was likely to be stopped by the U.S. Government.

Having brought the paragraph under the notice of the Museum Committee of the Town Council, I am requested by them to communicate with you, and to say that several of these Reports have been received by the Leicester Museum, and are regarded as of great value; and that the Museum Committee will be glad

to co-operate in any proceeding which may be thought most likely to induce the Government of the United States to continue the publication of them. FREDK. T. MOTT  
Town Museum, Leicester, March 7

Origin of the Screw Propeller

I SHOULD like to remark, in reference to last week's letter on the origin of the screw propeller, that I have long considered the pectoral fins, which are so extremely useful to and prominent upon soles, or the family *Pleuronctida*, as being highly suggestive of this more modern mode of propulsion. Anyone who likes to watch these extremely interesting fish in their swimming movements and graceful gyrations may witness the action and I think attribute to its movements more than is possible in the case of ash and other seed vessels.

Valentines

WILLIAM EARLEY

The Three Kingdoms of Nature

IN reply to your correspondent's question as to which of the three kingdoms "water" belongs, I beg to state that the strict scientific definition of a mineral, adopted in most mineralogies, is as follows: a mineral is any *inorganic, homogeneous, natural* substance.

This definition obviously includes water, which is accordingly always described in books on mineralogy; and the fact of water being a liquid at ordinary temperatures cannot of course exclude it from the list of minerals. Indeed, in some mineralogies, gases—such as carbonic acid, sulphurous acid, and even the air—are described as minerals. Water, like many other minerals, can exist in more than one form; thus, if the temperature of our globe were much lower than it is, we should only have water in the form of the transparent crystalline solid, known as ice, which—like other minerals, such as sulphur, metallic lead, metallic mercury, &c.—has its own particular point of fusion; thus: sulphur melts at 226° F., water at 32°, mercury at 39°. All these substances still further resemble one another in their capability of being converted into a gaseous form, at certain fixed temperatures. These facts—with many others—prove water to be as much a mineral as calcite or gypsum. E. G. C.

Upper Holloway, N., March 13

The Recent Storm

YESTERDAY'S storm appears to have been a true cyclone, and to have passed nearly centrally over here about half-past one o'clock. I first noticed the barometer at 11 A.M. I forward observations:—

Sunday.	Barometer.
10 A.M. Wind and rain S. ...	—
11 " Strong ditto ...	27
12 " Ditto from S.W. ...	26.9
12.30 P.M. Increased ditto... ..	26.85
1 " Great gale, S.W. ...	26.8 falling still.
1.20 " Ditto, S.W. ...	At
1.35 " Calm ...	lunch.
2 " Strong wind from N. with driving sleet...	26.8 rising.
2.30 " Gale, snow and sleet. ...	26.85
3 " Ditto, rather increased ...	26.9
4 " Brisk breeze, N. ...	27
5 " Slight breeze, N. ...	27.35
11 " ... ..	27.9

Being a rise 1.75 inch in seven hours.  
Staplehurst, Kent, March 13 T. S. USBORNE

Bed-time

CAN any of your readers inform me on what ground the following saying is based, and to what extent it is true:—"One hour's sleep before twelve is worth two after." March 10 VITA BREVIS

OUR ASTRONOMICAL COLUMN

COMET 1840 (II.).—In *Astronomische Nachrichten*, No. 2,079, Dr. Kowalczyk, of Warsaw, publishes his investigation of a definitive orbit for the comet discovered at Berlin, by Prof. Galle, the present Director of the Observatory at Breslau, on the 25th of January, 1840.

\* N.B.—This is  $\frac{1}{10}$  lower than I ever saw it before.

This comet, which was last observed at Kremsmunster on the 1st of April, had already been made the subject of extensive calculation by Professors Plantamour and Loomis. The former, in 1843, discussing his own series of careful observations taken at Geneva, found (*Astron. Nach.*, No. 476) that a parabolic orbit represented the comet's course within the probable limits of error of observation; on including the series taken at Berlin he found the most probable orbit to be an ellipse, but of great excentricity to which little weight was considered to attach. Loomis, on his side, taking into account the effect of planetary perturbation during the interval of the comet's visibility, also found an ellipse, but with a more moderate excentricity, the period of revolution being about 2,420 years; the sum of the squares of the errors in the ellipse is diminished to one-third of the amount with the best determinable parabola. Loomis's investigation will be found in the "Transactions of the American Academy," vol. viii.; his orbits are not included in the extensive collection in Dr. Carl's "Repertorium der Cometen-Astronomie," a work which, notwithstanding its great utility to the student of this branch of the science, is yet not complete or free from numerical errors.

Kowalczyk starts with the parabolic elements obtained by Plantamour in 1843, comparing them with the whole course of observations. After introducing the corrections for aberration and parallax, and the earth's positions from Leverrier's tables, instead of those from the Tables of Carlini used by previous computers and by the usual method of equations of condition for ten normal places, he finally arrives at an elliptical orbit, very closely agreeing with observation, and showing a period of revolution of 3,789 years.

BERLINER ASTRONOMISCHES JAHRBUCH, 1878.—The Berlin Ephemeris for 1878 has been received during the past week. In its speciality—the ephemerides of the minor planets—Prof. Tietjen has evidently made a very vigorous and successful effort to keep pace with the frequent additions to the list; his volume contains approximate places for every twentieth day during the present year of 144 of the 160 small planets hitherto detected, and accurate opposition ephemerides of 71, occupying together one-third of the entire work. The collective table of elements to No. 147 inclusive is not the least important part of this volume of the *Jahrbuch*.

Prof. Tietjen continues to transfer to the Berlin work—of course after reduction to that meridian—the places of the moon from our *Nautical Almanac*, which, by order of the Admiralty, is invariably published three complete years in advance of that to which it applies, and considerably earlier than any other of the national ephemerides. The economy of labour of computation thereby effected, which is probably found by the conductor of the *Berliner Jahrbuch* of material assistance for the production of his extensive work on the minor planets, might possibly be extended in other directions. An ephemeris of the moon from Hansen's Tables, employed for all the European ephemerides, admits of pretty complete check at a small expense of calculation, and there appears to be no advantage derivable from an independent work involving such heavy labour as the computation of the moon's positions through a whole year. Prof. Tietjen contents himself with a few direct calculations from the Tables which he says "invariably exhibit a satisfactory agreement" with the results in the *Nautical Almanac*.

PHYSICAL SCIENCE IN SCHOOLS

WHEN I claimed for science a position of educational equality "both as regards range and time with classics and mathematics," I intended to express the amount of science teaching in the school curriculum which alone can satisfy the upholders of a scientific education. I am as fully aware as Mr. Wilson is of the

importance of a firm mathematical foundation, and I am as far from wishing to overwhelm the younger boys with science before they have mastered the elements of arithmetic and grammar and languages as he can be. My experience amongst boys has, however, not been such as to enable me to say exactly when a thorough science teaching ought to begin.

The mistake, as it seems to me, which is prevalent respecting science teaching in schools, is the notion that it is a subject to be lectured upon for two hours per week to those already educated, and who show an aptitude for it, whilst it can, and ought to, be introduced at a definite period as a regular part of school work. It is now usually made an extra subject, a quasi-amusement, put on the same footing as drilling or drawing, whilst it can, and ought to, be made as much a discipline as the Latin grammar or Euclid, affording, as it does, in my opinion, if properly taught, an excellent training ground for acquiring that reasoning power and habit of application which it is usually supposed can only be gained through one or other of these older channels. I am sorry that Mr. Wilson thinks that any man of science is misleading public opinion on this subject. This is a serious charge, but as it rests on a misconception, I remain convinced that in the long run public opinion will endorse our views.

It is out of my power to tell Mr. Wilson whose business it is to make the change to a better state of things, which he himself feels to be necessary, for he admits that the new examination is adverse to scientific education. I do, however, feel strongly that unless the authorities of our great schools and the examining Boards set earnestly to work to introduce this new discipline and give it (as many of them to their honour are now beginning to do) a fair field and no favour, the beneficial influence which these schools have had on English education, must soon begin to diminish.

The Balliol scholarships and the other great University "advertisements" I believe to be in many ways stumbling-blocks in the path of true education in this country; "the many," as Mr. Wilson truly says, "are kept to swell the triumph of the few," and the prizes have to be got "at any cost to boy or school." Are we never to break loose from this degrading bondage to the Moloch of examination? I for one think better both of commissioners, governors, and head-masters, and look forward with hope to the ultimate emancipation of school-boys from their ancient fetters. Then those subjects will be taught at school which are best suited to make the mass of boys good citizens, and to forward the highest interests of the country, instead of the great aim of the schoolmaster being to secure a Balliol scholarship. We shall then see less than we do now of University men taking to sheep-farming in Australia, and hear less complaint of the superiority of our continental friends both in pure science and its application.

HENRY E. ROSCOE

PROF. FLOWER'S HUNTERIAN LECTURES  
ON THE RELATION OF EXTINCT TO EXISTING MAMMALIA<sup>1</sup>

IV.

IT was mentioned in the last lecture that no true Proboscideans have been found below the Miocene strata, but among the most remarkable of the numerous recent discoveries in the Eocene formations of Wyoming Territory, North America, has been that of a group of animals of huge size, approaching, if not equalling, that of the largest existing elephants, presenting a combination of characters quite unlike those known among either recent or extinct creatures, and of which there were evidently

<sup>1</sup> Abstract of a course of lectures delivered at the Royal College of Surgeons "On the Relation of Extinct to Existing Mammalia, with Special Reference to the Derivative Hypothesis," in conclusion of the course of 1873. (See Reports in NATURE for that year.) Continued from p. 356.

several species living contemporaneously. To form some idea of their appearance, we must imagine animals very elephantine in their general proportions, elevated on massive pillar-like limbs, with the same complete radius and ulna, the same short, round, five-toed feet which distinguish the elephants from all other known hoofed quadrupeds. The tail, as in the elephants, was long and slender, but the neck, though still short was not so much abbreviated as in modern Proboscideans, and there is no good evidence of their having possessed a trunk. The brain was exceedingly small for the size of the creature. The head differed greatly from that of the elephants, being long and narrow, more like that of a rhinoceros, and, as in that animal, was elevated behind into a great occipital crest, but unlike that or any other known mammal, it had developed from its upper surface, three pairs of conspicuous laterally diverging protuberances, one pair from the parietal region, one over or in front of the orbits, and one near the forepart of the elongated nasal bones. Whether these were merely covered by bosses of callous skin, as the rounded form and ruggedness of their extremities would indicate, or whether they formed the bases of attachments for horns of still greater extent, either like those of the rhinoceros or the cavicorn ruminants, must still be a matter of conjecture. But in either case they must have given a very strange aspect to the creature which possessed them, and have been formidable weapons in encounters either with animals of its own kind, or with the fierce carnivorous beasts whose remains are associated in the same deposits with them. There were no incisor teeth in the upper jaw, but a pair of huge descending canine tusks very similar in position and form to those of the musk-deer. Behind these, and at some distance from them, were, on each side above and below, six molar teeth of comparatively small size, placed in continuous series, each with a pair of oblique ridges, conjoined internally, and diverging externally in a V-like manner, and with a stout basal cingulum. The lower incisors and canines were small, and are only known at present by their sockets. The dental formula is—

$$i \frac{0}{3} c \frac{1}{1} p \frac{3}{3} m \frac{3}{3} = 34$$

The first discovered evidences of the existence of animals of this group were described by Leidy in 1872, under the name of *Uintatherium*, from the Uintah Mountains, at the base of which they were found. Very shortly afterwards other portions of bones and teeth of either the same or closely allied forms, were described by Marsh as *Dinoceras*, and by Cope as *Loxolophodon* and *Eobasilus*. Whether these names will ultimately be retained for separate generic modifications, or whether they will have to be merged into the first, it would be premature to attempt to decide upon the evidence before us. A more important question is, what are the affinities of the animals, and what light do they throw on the general evolutionary history of the class to which they belong? Looking at the totality of their organisation as already known, at first sight they seem to present a considerable resemblance with the Proboscidea. The absence of the third trochanter, and of the fossa for the ligamentum teres on the femur, and the general form of the feet with their short broad toes are quite Proboscidean characters, but a closer examination of the structure of the carpus and tarsus, especially of the mode of union of the different bones with each other, shows more essential affinities with Rhinoceros. The same may be said of the cranium, so that on the whole they appear to come nearer to the Perissodactyle Ungulates than was formerly supposed. This relationship is strengthened by the discovery of other forms, constituting the genera *Bathmodon* and *Metalophodon* of Cope, of earlier geological age, which with the same general structure of the *Uintatheriidae* retain in a most interesting manner many primitive characters, especially the complete number of incisor and premolar

teeth. These are forms for fuller information upon which we anxiously wait.

The negative evidence (which of course must be received with the greatest caution in palæontology) of the absence of remains of any of these animals in the true Miocene or Pliocene deposits of North America, indicates that the race became extinct at least in that land, though it possibly may have emigrated elsewhere, and perhaps in Asia, may have laid the foundation of that family which first appears in the Old World under the more familiar aspect of typical Proboscideans. While, however, there are no grounds for assuming that the latter were derived directly from the Eocene Bathmodons and Uintatheriums, it is not too much to look upon these as affording some indications of the steps by which the process might have taken place, and, as such, their discovery is one of the most interesting that has been revealed by modern palæontological research.

It should be mentioned that Marsh, who has given us very full information upon the osteology and dentition of this group, has made of *Uintatherium* and its immediate allies a peculiar order of mammals, to which he gives the name of *Dinocerata*, while Cope, who formerly included them in the Proboscidea, and placed *Bathmodon* and its allies in the Perissodactyla, has recently formed an order called *Amblypoda*, containing two sub-orders, of which *Dinocerata* is one, and *Pantodontia* (*Bathmodon* and *Metalophodon*) the other.

The tertiaries of South America have yielded some very remarkable forms of mammalian life, the nature and affinities of which have greatly puzzled all zoologists who have attempted to unravel them. *Macrauchenia* has been already described among the Perissodactyle Ungulates, of which group it is undoubtedly a member, although in some characters somewhat aberrant. The articulation of the fibula with the calcaneum is an Artiodactyle, or perhaps generalised character. The teeth ally it to Palæotherium and Rhinoceros. *Homalodontotherium* from the banks of the River Gallegos, South-east Patagonia, is known by the teeth alone, which, though very generalised, are on the whole rhinocerot. *Nesodon*, from the same locality, also only known by the dentition and some parts of the skull, connects the last and *Macrauchenia* with *Toxodon*. These three genera have

the typical dental formula of  $i \frac{3}{3} c \frac{1}{1} p \frac{4}{4} m \frac{3}{3} = 44$ .

*Toxodon* is an animal about the size of a hippopotamus, of which many specimens have now been found in Pleistocene deposits near Buenos Ayres, which have been described by Owen, Gervais, and Burmeister. The teeth consist of incisors, very small lower canines, and strongly curved molars, all with persistent roots; the formula being apparently  $i \frac{2}{3} c \frac{0}{1} p \frac{4}{3} m \frac{3}{3} = 38$ . The cranial characters exhibited a combination of those found in both Perissodactyles and Artiodactyles, but the form of the hinder part of the palate, the absence of an alisphenoid canal, and especially the tympanic being firmly fixed in between the squamosal and the exoccipital, ankyloused to both, and forming the floor of a long, upward directed meatus auditorius, is so exactly like that of the *Suina*, that it is difficult to believe that it does not indicate some real affinity to that group. These characters seem to outweigh in importance those by which some zoologists have linked it to the Perissodactyla, and the absence of the third trochanter, and the articulation of the fibula with the calcaneum tell in the same direction. The structure of the feet is not known, but it is probable that it had five toes on each.

*Mesotherium*, Serres, also called *Typpotherium* by Bravard and Gervais, was an animal rather larger than a Capybara, and of much the same general appearance. Its skeleton is completely known, and shows a singular combination of characters, resembling *Toxodon*, or a

generalised Ungulate on the one hand, and the Rodents, especially the *Leporidae* on the other. In the presence of clavicles, of five toes on the fore-foot and four on the hinder, it differs from all existing Ungulates, and yet if it is considered as a Rodent, it must be looked upon as a most aberrant form. The teeth are  $i \frac{1}{2} c \frac{0}{0} p \frac{2}{1}$

$m \frac{3}{3} = 24$ . Although our knowledge of many of these

forms is still very limited, we may trace among them a curious chain of affinities, which, if correctly interpreted, would seem to unite the Ungulates on the one hand, with the Rodents on the other; but further materials are needed before we can establish with certainty so important a relationship, one which, if true, would alter materially some of the prevailing views upon the classification of mammals. It may be convenient provisionally to include those Ungulates which are neither *Artiodactyla* nor *Perissodactyla*, under a third heading, of which *Polydactyla*<sup>1</sup> would be the appropriate designation; though there is no evidence that they form such a homogeneous group as either of the other two.

(To be continued.)

#### PROF. HUXLEY'S LECTURES ON THE EVIDENCE AS TO THE ORIGIN OF EXISTING VERTEBRATE ANIMALS<sup>2</sup>

I.

TWENTY years ago the arguments as to the causes of the phenomena of organic nature, brought forward in support of the then recently advanced views of Mr. Darwin, were largely speculative; all one could hope to show was that no valid objections could be urged against the theory of evolution. But since that time "many have run to and fro and knowledge has been increased"; the question has come out of the region of speculation into that of proof; every day increases our familiarity with the phenomena of life on the globe in antecedent ages, and so gives us the only valid evidence obtainable as to the evolution of living things.

When we consider any animal at the present day there are three hypotheses which may be put forward with regard to its origin: that it arose out of nothing, that it had its origin from dead inorganic matter, or that it arose as a modification of some pre-existing living being. It is hardly worth while to consider the two first of these hypotheses—for the first it would be utterly impossible to obtain any evidence, and the second is devoid of all ground of analogy, and opposed to all our knowledge of what actually takes place. The last, on the other hand, should, if true, be capable of some sort of proof—at any rate it can be brought to the test of facts.

It is quite conceivable that all evidence as to the origin of an animal may have disappeared, and that the problem becomes, in consequence, insoluble by direct evidence, analogy and probability being the only guides left. As a matter of fact, however, we possess in the 70,000 feet of stone, gravel, sand, &c., which form the earth's crust, fossil remains imbedded in chronological order, and in many cases so perfectly preserved, that all important details can be made out almost as well as in the recent state.

The plan adopted in these lectures will be not to give all obtainable evidence with regard to the origin of each group of vertebrate animals, but to select from each class one or two definite cases of living animals, and to see what evidences can be obtained, by going back in time, as to the way in which they have come about, or at any rate as to the extent of the duration of their existence.

<sup>1</sup> An extension of the order *Toxodontia* of Owen, and *Ungulata multidentata* of Burmeister.

<sup>2</sup> A course of six lectures to working men, delivered in the theatre of the Royal School of Mines. Lecture I., Feb. 28.

To begin with fishes : we will take as our first example the very beautiful genus *Beryx*, a fish not unlike our sea-bream, found widely distributed through the deep seas, and extending to about 40° on each side of the equator. Like the perch or the sea-bream, it is a greatly *specialised* fish ; the head is immensely large, the bony rays supporting the fins hard and unjointed, the ventral fins or representatives of the hind limbs situated just behind the head, under the throat, the operculum curiously ornamented, and the air-bladder completely shut off from the gullet ; thus differing very markedly from a more *generalised* fish such as the herring or carp, in which the head is proportionally much smaller, the fin-rays soft and jointed, the ventral fins far back, the operculum not ornamented, and the air-bladder communicating by a duct with the œsophagus.

We now know that at depths greater than five or six hundred fathoms, the sea-bottom is to a great extent composed of a very fine greyish-white mud, sticky when first removed from the water, but afterwards hardening into a delicate friable stone, not at all unlike chalk. This mud, which is largely made up of shells of the minute marine organism *Globigerina*, forms the bed of thousands of square miles of sea in which *Beryx* lives, and there can be no doubt that when the fish dies it sinks to the bottom, and, its soft parts being destroyed, becomes gradually imbedded in the soft mud, there to remain until the present sea-bottom is upheaved and becomes dry land.

Now, as a matter of archæological evidence, what is known of the history of *Beryx* and of the source whence it proceeded? Naturally it is useless to seek for such evidence except in deposits formed under like conditions to those in which the fish lives at the present day. Through the whole of the Pliocene and Miocene epochs no deep-sea formations are known, but in the middle of the Eocene period—a time so remote that tropical plants flourished on the banks of the Thames, and crocodiles abounded in this country—we are acquainted with an extensive deep-sea deposit, the Nummulitic limestone, which, besides the fossil giving it its name, contains large quantities of *Globigerina*, in all essential respects like that of the present day. In this formation are found two forms closely allied to *Beryx*, but with such slight differences as to receive different generic names ; these are known as *Acanus* and *Pristigaster*. On passing from the Eocene or lowest tertiary to the chalk or uppermost secondary formation, which bears the closest possible resemblance to the modern Atlantic mud—the two may, in fact, be looked upon as belonging to one continuous series of deposits—we find an actual *Beryx*, a fish differing no more from the modern *Beryx* than the various modern species of *Beryx* do from one another. This fossil, owing to the fineness of the chalk-forming mud in which it was buried, is so perfectly preserved, that all the details of structure of its hard parts, even to the ornamentation of the scales, can be compared with those in the recent fish ; and in this way the most conclusive evidence is obtained that the differences which separate it from its modern relatives are of no greater importance than those by which the recent species of *Beryx* are distinguished from one another.

Thus we have positive evidence that a fish altogether like the *Beryx* of the present day, existed millions of years ago, before the Alps, the Himalayas, or the Rocky Mountains were upheaved, and has continued to live ever since. In face of these facts we cannot but conclude that the modern *Beryx* is derived from that of the chalk, and that the hypotheses of its creation out of nothing, and of its origin from inorganic matter are, for scientific purposes, simply non-existent.

As to the form from which the *Beryx* of the chalk was derived, we have absolutely no evidence, for there is no trace of any such fish in any lower formation.

We now pass on to a fish of a far older and less

specialised type than *Beryx*—the genus *Ceratodus*, recently discovered in Australia. This animal, which attains a length of six feet, is distinguished by the possession of very curious fins, consisting of a central lobe, with a surrounding fringe of fin-rays, and by the character of its teeth, which are produced into curious horn-like processes, so arranged that those of opposite jaws interlock. *Ceratodus* is probably a vegetable feeder, lives in fresh or brackish water, and is said sometimes to leave its native element and crawl about among the weeds on the bank. It is enabled to do this by the fact that it can breathe air directly as well as air dissolved in water ; it has, in fact, besides gills, an organ which is altogether a half-way house between the air-bladder of a fish and the lung of an amphibian.

In the Wealden, the most recent estuarine deposit of which we have any knowledge, there is no trace of *Ceratodus* to be found, but this is hardly surprising, as only two or three small patches of the earth's surface formed at this epoch have been examined, and animals have a geographical distribution at all times. But on passing back to the Trias, a formation as far from the chalk in point of time as the chalk from the present day, we find teeth belonging to an undoubted *Ceratodus*, in shape and in microscopic structure, exactly like those of the modern Australian fish. No other remains of the Triassic *Ceratodus* have as yet been found, but teeth are known to be so important a diagnostic character that no naturalist would have any hesitation in naming the genus to which the fish bearing such teeth should be assigned.

Thus we have a far more astonishing example of a persistent type than was afforded by our *Beryx*, and as in the case of the latter fish, all trace of the actual genus *Ceratodus* is lost at this point, and we are obliged to content ourselves with a few singular hints as to the way in which the type has come about. The most valuable of these hints are obtained by a study of a singular group of fish found in great abundance in the Old Red Sandstone. These are distinguished by the possession of curious fringed fins, unlike those of any other fish except *Lepidosiren* and *Ceratodus*—in fact, one genus, *Dipterus*, has fins quite like those of *Ceratodus*, and its teeth and skeleton were formed on just the same type. It is doubtful whether there is any relation between *Ceratodus* and *Dipterus* in the way of ancestry, but the resemblance between them is remarkable.

It must seem rather strange for a known evolutionist to select as examples two fish like *Beryx* and *Ceratodus*, which, of all others, seem most likely to support the notion that species are immutable. The adverse side only of the question has been stated to-night, the other side will be treated of on future occasions.

#### THE OLD RED SANDSTONE

AT a meeting of the Glasgow Geological Society on the 24th ult., Sir William Thomson, F.R.S., president, in the chair, Prof. Geikie, F.R.S., communicated the results of recent researches into the "History of the Deposits known as the Old Red Sandstone." After a preliminary outline of our present knowledge on the subject, he proceeded to consider the development of the Old Red Sandstone in the British Isles under its accepted three-fold division into Lower, Middle, and Upper. The Lower member, wherever its true base can be seen, is found to pass down conformably into the Upper Silurian rocks. But a well-marked line of demarcation, both by physical characters and fossil evidence, runs between the two systems. The Silurian formations continue replete with organic remains up to their uppermost zone ; but on entering the red strata of the overlying system we meet with a remarkably abrupt change, for the fossils almost wholly disappear, and those which occur belong for the

most part to fishes and crustaceans. The author pointed out the geological evidence in favour of great terrestrial oscillations as explained by Prof. Ramsay, whereby the bed of the Silurian sea in our area came to be raised into land with wide lakes and inland seas. He showed that the beginnings of the movements which led to those results could be traced back a considerable way into the Silurian period, that over large tracts the Silurian deposits had been upraised before the close of that period, and that the oscillations continued during the accumulation of the Lower Old Red Sandstone, as indicated by the coarse conglomerates, the great mass of the deposits, and the unconformabilities traceable in them. Recent detailed work of the Geological Survey has brought to light the fact that this lower division of the Old Red Sandstone attains an almost incredible thickness. In Lanarkshire and Ayrshire Mr. B. N. Peach has found it to measure 15,000 feet. In Perthshire, from the combined surveys of Mr. Peach and Mr. R. L. Jack, it has been ascertained to reach a depth of more than 19,000 feet. But the author has found that traced eastward into Forfarshire and Kincardineshire, its thickness rises above 20,000 feet. And yet in no case is its top actually seen, since it has either been removed by denudation, or buried under some more recent unconformable formation. Nor is its base to be found, since along the flank of the Grampians a great fault runs from the North Sea at Stonehaven to the estuary of the Clyde, with the effect of throwing the strata of the Old Red Sandstone on end, sometimes for a distance of two miles from the line of the dislocation. The amount of displacement must be in some places not less than 5,000 feet, as indicated by the position of occasional outliers of conglomerate on the Highland side of the fault. One of the most striking features in the formation is the enormous development of its contemporaneous volcanic rocks. These are underlaid in Kincardineshire by about 5,000 feet of sandstones and shales, and they pass under the grey flags and conglomerates of Forfar, and an upper series of red and purple sandstones. They consist of thick sheets of various porphyries with beds of tuff and enormous masses of coarse volcanic conglomerates. Zones of grey flagstones, including the well-known beds of Carmyle near Arbroath, are intercalated in them. In the Ochil Hills, according to the measurements of Mr. B. N. Peach, this volcanic zone reaches a depth of not less than 6,500 feet. It runs from the sea-coast at Dunottar through the chain of the Sidlaw and Ochil Hills to near Stirling. It reappears south of the Forth, in the Pentland chain, and stretches south-westwards in great force across Lanarkshire and Ayrshire. The author then alluded to the fossils hitherto noticed in this part of the Old Red Sandstone in different parts of Britain, pointing out the contrast they present to those of the preceding Silurian rocks. He showed that in Forfarshire the well-known crustaceans and fishes had been obtained from strata, lying not as hitherto supposed at the base of the system, but several thousand feet higher, and that the fish-bed found by Mr. Mitchell in Kincardineshire, and supposed by Sir Roderick Murchison to indicate from its Acanthodian forms an approach to the middle Old Red Sandstone, really lay below the position of the Turin flagstones so well explored by Mr. Powrie.

The so-called "Middle" Old Red Sandstone is not known certainly to exist anywhere else in Britain than in the north of Scotland. This subdivision was introduced by Sir R. Murchison, and is based wholly on the evidence from fossils. It presents a remarkably distinct series of ichthyolites, which have not been met with in the Lower Old Red Sandstone of the south, and which have therefore been held to mark a higher series of deposits. The "Middle" Old Red Sandstone is typically developed in the well-known flags of Caithness. Those strata, long since described by Sedgwick and Murchison, cover nearly the whole of that county, and stretch into the Orkney

and Shetland Islands. The author had measured a section of these on the east coast of Caithness more than 8,000 feet in thickness. They show conglomerates and red sandstones at the base, and similar strata reappear on different higher horizons. But on the whole, the series consists of dark-grey, hard, fine-grained flagstones, sometimes bituminous, often calcareous, and frequently abounding in remains of fishes, entomostraca, and land-plants. No evidence of contemporaneous volcanic action has yet been met with in these rocks. The general character of the whole series differs in many respects from that of the Old Red Sandstone on the south side of the Grampians, and appears to indicate widely different conditions of deposit. The basins in which the Caithness flags, and the Arbroath flags accumulated, were separated by the intervening mass of the Inverness-shire and Aberdeenshire highlands, as shown by the basement conglomerates on each side of the mountains. The author then dwelt on the fossil evidence and its bearings. He suggested that it could not be held to prove a "middle" series, and that it was not inconsistent with the idea that the Caithness flags really belonged to the Lower Old Red Sandstone, the peculiarities of their fauna not being greater than might be due to great differences of physical geography, and to the fact that the respective areas of deposit were isolated from each other. He further pointed out that some of the most characteristic forms of the lower group occur in the Caithness and Orkney beds, e.g., *Pteraspis*, and *Pterygotus*. The Caithness flags abound in land-plants like *Sigillaria*, *Lepidodendron*, and some of the peculiar Devonian forms found by Dr. Dawson in Gaspé. Some of these latter forms have recently been detected by Mr. R. L. Jack in the course of the work of the Geological Survey in Perthshire.

The red and yellow sandstones, red clays, and red conglomerates and breccias, included under the term "Upper Old Red Sandstone," are copiously developed in Wales, in Ireland, and in the south of Scotland. In the two last-named regions they have been shown to lie unconformably on all older formations, there being a complete physical discordance, and an entire difference in organic contents, between these strata and the Lower Old Red Sandstone. In South Wales a less marked break in the series may be suspected from the cautious descriptions given by Sir Henry De la Beche. In the north of Scotland Sir R. Murchison has described the Upper as graduating downwards into the Middle or Caithness flags. In Caithness itself, however, and in Orkney, they are completely discordant, and the same relation may be inferred to hold elsewhere. This uppermost member thus bears the same relation to the Caithness flags as to the Arbroath flags. Wherever the top of the series can be seen, it is found to pass gradually and conformably into the base of the Carboniferous system. So thoroughly do these two series of deposits dovetail with each other that no sharp line can be drawn between them. If we work our way into the red rocks from the Carboniferous side, we may claim them as merely the base of the Carboniferous system. If we approach them from the side of the Old Red Sandstone, we may well regard them as a late and unconformable sub-division of this system.

The author next adverted to the fossils peculiar to the Upper Old Red Sandstone, calling attention to the continuance of land-plants and ganoid fishes as characteristic Old Red Sandstone features. He then, in conclusion, pointed out the physical geography which appears to be indicated by the deposits of this period. It is still possible to map out some of the terrestrial and lacustrine areas which then marked the site of Britain. Hill-ranges, still in existence, formed prominent features in the landscapes of that time, though with many differences of outline; in particular, with water-filled bays, straits, long fjord-like inlets and scattered lakes which have been filled



up with sandstones, conglomerates, and breccias. The red stain of these deposits, occasional pseudomorphs of rock-salt and layers of gypsum, combined with ripple-marks and sun-cracks seem, as Prof. Ramsay has suggested, to indicate the concentration of the saline waters which filled these basins; while further evidence of the unwholesome nature of the water may be indicated by the general paucity of fossils in the strata, and by the immense numbers of well-preserved fishes which are sometimes met with crowded into a small space, as if they had come from fresher water elsewhere, and had been inclosed and killed in scattered pools. The peculiar breccias and brecciated conglomerates of the Upper Old Red Sandstone have been compared to some recent Glacial deposits, and the resemblance has been pointed out between the form of the stones in these deposits, and those in common boulder-clay. It should be noted also that in many cases these breccias occur in old valleys, and bear many of the characters of valley-moraines. Such are those to the east of Ullswater, and those which flank, and in some places penetrate the Lammermuir Hills. In the latter district worn dome-shaped bosses of rock underlying the breccias recall the aspect of true *roches moutonnées*. Another glacial feature is suggested by the basin-shaped hollows (apparently sometimes true rock-basins) in which the deposits lie. Further indications of ice are given by the remarkable patches of angular and rounded stones scattered through the red sandstones of Arran, the occurrence and position of which may be accounted for on the supposition that they are portions of shore-gravel, which have been frozen and transported in cakes of floating-ice.

Indications of terrestrial disturbance during the accumulation of the Upper Old Red Sandstone in Scotland are furnished by the Lammermuir Hills. Towards the close of the period, and thence through the deposition of the Lower Carboniferous rocks, volcanic action which seems to have been quiescent for a long interval, broke out again over the south of Scotland. To this period belongs the chain of old lavas and tuffs which may be traced from the mouth of the Nith eastwards by Langholm and the Tarras Water, to the head of the Slitrig Valley, and through the plain of the Tweed as far northwards as the Whiteadder. The Garlton Hills, Campsie Fells, and the ranges of hills which run down Renfrewshire and the north-east of Ayrshire, and are prolonged into Bute, the Cumbrays and Arran mark a prolonged series of volcanic eruptions during this same period. Probably the terraced hills of Lorne are of similar age. Traces of contemporaneous volcanic action occur likewise in the Upper Old Red Sandstone of the north of Scotland, and form a remarkable feature in the cliffs of Hoy, one of the Orkney Islands.

The author brought forward evidence to show that while the Upper Old Red Sandstone was being deposited in the British area, there existed outside that area a sea in which some of the characteristic corals, brachiopods, and other organisms of the time of the Carboniferous Limestone already existed. He pointed out the intercalation of limestone bands in the Red Sandstone series in Arran and elsewhere, a long way below the base of the Cementstone group which underlies the Carboniferous Limestone. These calcareous bands, full of species of fossils which are familiar in the Carboniferous Limestone, seem to indicate that while, on the whole, the Upper Old Red Sandstone, and the red strata at the base of the Carboniferous system were deposited under conditions unfavourable to the presence of at least corals, crinoids, and molluscs, their formation was interrupted by intervals during which clearer and less saline water prevailed, perhaps owing to the removal of barriers which allowed the access of the main ocean with its animal forms into the closed lagoons and inland seas of the Upper Old Red Sandstone.

ON REPULSION RESULTING FROM RADIATION<sup>1</sup>

THIS paper contains an account of experiments on the action of radiation on bodies the surfaces of which have their radiating and absorbing powers modified by various coatings. The difference between a white and a lamp-blackened surface in this respect was at first not very decided, and experiments have been instituted with the object of clearing up some anomalies in the actions observed. Two pith discs, one white and the other black, are suspended on a light arm in a glass bulb by means of a fine silk fibre; after perfect exhaustion the white and black discs are found to be equally repelled by heat of low intensity, such as from the fingers, warm water, &c. A copper ball is then tried at gradually increasing temperatures. Up to 250° C. it repels both equally, above that the black is more repelled than the white, and at a full red heat the repulsion of the black disc is very energetic. A lighted candle acts with more energy than the red-hot copper.

The presence of even a small quantity of aqueous vapour in the exhausted apparatus almost, if not quite, neutralises the more energetic action which luminous rays appear to exert on a blackened surface.

After describing several different modifications and some new forms of apparatus devised to facilitate experiment, the author gives a drawing of an instrument which enables him to get quantitative measurements of the amount of incident light falling on it. It consists of a flat bar of pith, half black and half white, suspended horizontally in a bulb by means of a long silk fibre. A small magnet and reflecting mirror are fastened to the pith, and a controlling magnet is fastened outside so that it can slide up and down the tube, and thus increase or diminish sensitiveness. The whole is completely exhausted and then inclosed in a box lined with black velvet, with apertures for the rays of light to pass in and out. A ray of light reflected from the mirror to a graduated scale, shows the movements of the pith bar. The degrees of deflection produced by the light of a candle at distances from 6 feet to 35 feet are given.

The experimental observations and the numbers which are required by the theoretical diminution of light with the square of the distance, are sufficiently close, as the following figures show:—

Candle 6 feet off gives a deflection of	218°
" 12 "	54
" 18 "	24.5
" 24 "	13
" 30 "	7
" 36 "	4.5

The effect of two candles side by side is practically double, and of three candles three times that of one candle.

The action of various solid and liquid screens is next given.

A candle three feet off, giving a deflection of 180°, has its action reduced to the following amounts by

Yellow glass ... ..	161°
Blue " ... ..	102
Green " ... ..	101
Red " ... ..	128
Water " ... ..	47
Alum " ... ..	27

A candle on each side of the apparatus, and equidistant from it, keeps the index ray of light at zero; by shading off either one or the other the light flies off to either extremity of the scale. This gives a ready means of balancing two sources of light one against the other. Thus,

<sup>1</sup> Paper read at the Royal Society, Feb. 10, by William Crookes, F. R. S., &c. Part III.

retaining the standard candle 48 inches off, on the left of the bar, the index is brought to zero by placing on the right

2 candles	...	...	...	...	67 in. off.
1 candle behind solution of sulphate of copper	...	...	...	...	6 "
" "	alum plate	...	...	...	14 "
A small gas burner	...	...	...	...	113 "

These experiments show how conveniently and accurately this instrument can be used as a photometer. By balancing a standard candle on one side against any source of light on the other, the value of the latter in terms of a candle is readily shown; thus in the last experiment the standard candle 48 inches off is balanced by a gas-flame 113 inches off. The lights are therefore in the proportion of  $48^2$  to  $113^2$ , or as 1 to  $5\frac{1}{2}$ . The gas-burner is therefore equal to  $5\frac{1}{2}$  candles.

By interposing screens of water or plates of alum, and so cutting off the dark heat, the actual luminosity is measured. In addition to this, by interposing coloured glasses or solutions, any desired colours can be measured either against the total radiation from a candle, its luminous rays, or any desired colour. One coloured ray can be balanced against another coloured ray, by having differently coloured screens on either side.

The variations in the luminosity of a "standard" candle will cease to be of importance. Any candle may be taken; and if it be placed at such a distance from the apparatus that it will give a uniform deflection, say of 100 divisions, the standard can be reproduced at any subsequent time; and the burning of the candle may be tested during the photometric experiments by taking the deflection it causes from time to time, and altering its distance, if needed, to keep the deflection at 100 divisions.

If the pith bar in this instrument be blacked on alternate halves, an impetus given by a ray of light always acts in the same direction of movement. A candle causes it to spin round very rapidly until the suspending fibre is twisted up, and the rotation is stopped by the accumulated torsion.

By arranging the apparatus so that the black and white surfaces are suspended on a pivot instead of by a silk fibre, the interfering action of torsion is removed, and the instrument will rotate continuously under the influence of radiation. To this instrument the author has given the name of the "Radiometer." It consists of four arms of very fine glass, supported in the centre by a needle-point, and having at the extremities thin discs of pith lamp-black on one side, the black surfaces all facing the same way. The needle stands in a glass cup, and the arms and discs are delicately balanced so as to revolve with the slightest impetus.

In the "Proceedings of the Royal Society" last year, the author gave a brief account of some of the earlier experiments with these instruments. In the present paper he enters very fully into the various phenomena presented by them, and gives Tables showing the number of revolutions made by the radiometer when exposed to a constant source of light removed different distances from the instrument. The law is that the rapidity of revolution is inversely as the square of the difference between the light and the instrument.

When exposed to different numbers of candles at the same distance off, the number of revolutions in a given time are in proportion to the number of candles, two candles giving twice the rapidity of one candle, and three, three times, &c.

The position of the light in the horizontal plane of the instrument is of no consequence, provided the distance is not altered; thus two candles, one foot off, give the same number of revolutions per second, whether they are side by side or opposite to each other. From this it follows that if the radiometer is brought into a uniformly

lighted space it will continue to revolve. This is proved to be the case by experiment.

The speed with which a sensitive radiometer will revolve in full sunshine is almost incredible. Nothing is visible but an undefined nebulous ring, which becomes at times almost invisible. The number of revolutions per second cannot be counted, but it must be several hundreds, for one candle will make it spin round forty times a second.

The action of dark heat (*i.e.*, from boiling water) is to repel each surface equally, and the movement of the radiometer is therefore arrested if a flask of boiling water is brought near it. The same effect is produced by ice.

From some observations made by the author, it appears probable that heat of a still lower refrangibility repels the white more than it does the black surface. Many instances are given of the radiometer revolving the reverse way. Thus, breathing gently on the instrument will generally cause this effect to be produced.

An experiment is described with a radiometer, the moving parts of which are of aluminium, blacked on one side. When exposed to the radiation from a candle, the arms revolve the normal way. On removing the candle they revolve the reverse way. Heated with a Bunsen burner the arms revolve the normal way as they are getting hot, but as soon as the source of heat is removed and cooling commences, rotation sets up in the reverse way, and continues with great energy till the whole is cold. It appears as if the reverse movement during the cooling is equal in energy to the normal movement as it is being heated.

It is easy to get rotation in a radiometer without having the surfaces of the discs differently coloured. An experiment is described with one having the pith discs blacked on both sides. On bringing a candle near it, and shading the light from one side, rapid rotation is produced, which is at once altered in direction by moving the shade to the other side.

The author describes many forms of radiometer, by means of which the movements can be exhibited to a large audience, or can be made to record themselves telegraphically on a self-recording instrument.

#### THE WATER SUPPLY OF THE METROPOLIS

IN the concluding portion of his anniversary address printed in the last number of NATURE (p. 376), the late president of the Geological Society severely criticises the proposal of the Rivers Commissioners to supply London with pure spring water. The Commissioners advise that the drinking water of London should continue to be derived from its present sources, but that it should be led away to its destination before it is mixed with the sewage of Oxford, Reading, Windsor, and other towns, and before it is fouled by the filthy discharges of paper mills and by other disgusting refuse.

Mr. John Evans thinks that it can hardly be believed that such a proposal as this should have been brought forward, involving, as he believes it would, if carried out, the conversion of the "fertile meadows" of the Thames Valley into "arid wastes," and the utter destruction of "watercress beds, now of fabulous value;" he adds that "even the canals and navigable rivers will become liable to sink and be lost in their beds." In predicting these dire results, he doubts whether his "judgment is seriously distorted," although he admits being deeply interested in the water power of one of the threatened valleys, and protests that no one can submit silently to an insidious (?) attack upon his property.

Having carefully studied for many years the hydrographical features of the Thames and other valleys, I have no hesitation in saying that Mr. Evans's fears are, for the most part, entirely unsupported by experience. Sterility

f surrounding land has not accompanied the withdrawal of vast volumes of water from the deep wells at Deptford, Thames Head, Caterham, Canterbury, Watford, Tring, or Richfield, and it is singular that Mr. Evans should have overlooked the fact that moisture is supplied to growing plants from above and not from below. However numerous the wells of a given district may be, the rain must still fall upon the surface of, and soak through, the land before it can reach them.

As the *dry-weather* flow of the Thames even above Teddington lock is 600 millions of gallons daily, it would be waste of time to discuss seriously the possibility of canals and navigable rivers sinking into their beds in consequence of the abstraction of about one-eighth of that volume from springs and deep wells in that portion of the river basin. With regard to the water-cress interest, it is true that the Rivers Commissioners have not been so deeply impressed as Mr. Evans with the stupendous importance of this department of Thames agriculture, but it can scarcely be doubted that a wealthy city, containing 4,000,000 of inhabitants, would be able and willing to pay for any damage which it might inflict upon this or any other branch of industry.

The two most disgusting impurities revealed by the microscope in Thames water, as delivered for dietetic purposes in London, are the fibres of partially digested flesh meat, and those of variously coloured rags. The presence of these objects in our potable water clearly indicates the two chief kinds of *insoluble* polluting matter cast into the Thames, although chemical analysis cannot always trace to its sources the *dissolved* animal and vegetable impurities which it finds accompanying these insoluble materials. The question raised, therefore, is simple enough:—Shall the inhabitants of this “overgrown city,” as Mr. Evans contemptuously terms it, drink the pure spring water which nature offers them in singular abundance in the Thames valley, or shall they not be permitted to taste this sparkling beverage until the paper manufacturers, in the exercise of what they call their rights, have washed their filthy rags in it, and half a million of people have polluted it by their drainage?

It is remarkable that whilst Mr. Evans shows so much consideration, in his presidential address, for the pockets of the watercress-growers, he has so little to bestow upon the inhabitants of the overgrown city, for he does not hesitate to propose that the latter should encounter the expense of two separate water services—one (pure) for dietetic, and a second (polluted) for other domestic purposes. Now, leaving out of consideration altogether the risk of the polluted water being often used for dietetic purposes instead of the pure, and the enormous cost and inconvenience of laying and maintaining a new set of water-mains throughout the hundreds of miles of London streets; the supply of each house with a new water service, together with the necessary alterations of the old pipes, could not cost, on the average, less than 4*l.* In February last 523,801 houses were supplied with water by the eight metropolitan companies, and we have consequently here an expense of more than 2,000,000*l.* Surely a very small fraction of this sum would suffice to buy up any injured watercress-growers, even at “fabulous” prices.

In their sixth report, the Rivers Commissioners of 1868 state that the basin of the Thames, including that of its tributary, the Lea, is upwards of 5,000 square miles in extent. Rather more than one half of this area, including the oolitic and cretaceous formations, is covered by a porous soil upon a permeable water-bearing stratum, the remainder being occupied by the Oxford, Kimmeridge, Gault, and London clays. The annual rainfall of this district averages about 28 inches, or 5,217 millions of gallons per day. Two-thirds of this vast volume of water is lost by evaporation, while, of the remaining one-third, one-half passes away in floods, and the other half only is at present available for springs and deep wells. But even this

small fraction amounts to 870 millions of gallons daily, and it is proposed to take for the supply of the metropolis only 120 millions of gallons after it has practically performed all its fertilising functions; whilst, of this volume, there is even now supplied to London, in dry weather, about twenty-two millions of gallons. It is highly probable, however, that the volume of water available at present for springs and deep wells could be augmented to an extent commensurate, or nearly so, with the amount so abstracted for the supply of London. The chalk, and to some extent the oolite of the Thames basin, constitute an immense sponge which sops up the water falling upon it and maintains it, partly by capillary attraction and partly by its resistance to flow, at considerable elevations above the nearest rivers. This sponge has been aptly likened by Mr. Thornhill Harrison to an inverted reservoir, and just as the *dry-weather* flow of the Thames and its tributaries could be augmented by the judicious use of artificial storage reservoirs, so could the total yield of spring water from this vast natural reservoir be increased, by artificially bringing the water in it to a lower level before the occurrence of the autumn and winter floods. The spongy reservoir would thus be rendered capable of receiving those heavy rainfalls which, at present unable to find storage room below, either run off the saturated surface and constitute the winter floods, or immediately displace a corresponding volume of spring water from the sponge forcing it into the Thames and its affluents.

In the concluding paragraphs of his address Mr. Evans tries to show, from the results of chemical analysis, that the polluted water of the Thames is purer than the spring water from the chalk, and he thus seeks to make the inhabitants of the metropolis content with their present supply. His statements on this subject are founded upon an entire misconception of the meaning of the analytical results. A most exhaustive chemical examination of the river waters of the Thames basin, on the one hand, and of the spring and deep-well waters on the other, has shown, in the most unmistakable manner, the immense superiority of the latter for dietetic purposes. Indeed, it is obvious that, even with the most efficient river conservancy imaginable, aided by the best efforts of the Legislature, the Thames must always receive so much pollution as to render its use for the supply of the metropolis highly objectionable. No preventive measures can hinder the washings of highly-manured land, the excrements of cattle, the imperfectly purified sewage of towns and villages, and the partially cleansed discharges from paper-mills, skinneries, and tanyards, from mingling with the stream in enormous volumes. Such matters, though not obviously offensive to the senses (when this highest practical stage of purification has been reached), are still, from a sanitary point of view, of a very dangerous character. But even if this were not so, and if fatal results had never been known to follow the domestic use of such water, the refined feeling which separates the civilised man from the savage, and which excites loathing at the bare idea of organic matter, which has recently formed part of a human body, being supplied for human consumption, ought here to assert itself, and secure the rejection of such a beverage.

E. FRANKLAND

SCIENTIFIC NOTES TAKEN IN THE HIMALAYAS

I.—Atmospheric Absorption.

THE following notes refer chiefly to spectroscopic work, and they are, I think, of interest, as they show the importance of establishing a regular series of similar observations at different points of the globe.

Prof. Vogel has lately published in Poggendorff's *Annalen* the results of his observations taken in the Red Sea and in the Indian Ocean. He comes to the

conclusion that the relative intensity of the blue and red end of the solar spectrum is subject to great variations, variations which do not seem to stand in a simple relation to the hygroscopic state of the atmosphere or to barometric pressure. My results, while entirely confirmatory of those of Vogel, point to the fact that in the higher regions of the Himalayas, and at the season the observations were made, atmospheric absorption takes place chiefly in the red end of the spectrum. The blue end of the solar spectrum, even when the light of the sun has passed through a cloud, is remarkably bright.

The following extract from my note-book will place this fact beyond doubt. The observations were conducted at Simla with a spectroscope of eight prisms of about 60°. The direct sunlight was reflected by means of a small mirror into the slit. The slit was generally adjusted until one line between  $D_1$  and  $D_2$  was distinctly seen. As far as I could judge, all the lines, but not more than those given in Angström's map, were seen. The rainy season had just begun, but had not yet appeared in the violent way it did after my departure from Simla :—

*Extract from Note-book.*

June 27, 8 A.M.—B beautifully shaded. Light visible in the blue as far as wave-length 4040, and most likely further, but the telescope cannot be moved to greater deviation.

9 A.M.—Space beyond B closes up, while in the blue the spectrum is as visible as before.

Red end closes up. Blue perfectly visible.

11.15 A.M.—The red closed up still more. The blue as clear as before.

The sky is beautifully blue, but a slight halo seen round the sun.

July 3, 5.30 P.M.—The atmospheric lines near D seen distinctly. The blue is exceptionally clear and visible as far as H. Sky rather cloudy, and halo round the sun.

6.30 P.M.—Sun very near horizon. Spectrum seen from C to G.

In judging on the visibility of the spectrum, it should be borne in mind that, owing to the great number of prisms, a great part of the absorption in the blue was due to the glass, and that, therefore, owing to the great dispersion in the blue and instrumental absorption, the blue was seen under peculiar disadvantage. The above are only a few out of many observations. I have observed the passage of a cloud in front of the sun without any apparent effect in the blue, while the red end was all cut off.

I was at the same time struck by the fact that the peculiar redness of the clouds in the evening, which we observe so often in our climates, was only rarely seen, and when seen the colour was rather yellow than red. On making this remark to a friend competent to judge, and who through a repeated sojourn in Simla was enabled to form an opinion, I heard that the redness of the sky at sunset was often and beautifully seen at the end of, and after the rainy season.

I now pass to a few observations which I have made in Upper Thibet, a country which lies beyond the range of the rainy season. The observations all point to the remarkable clearness in the blue. As I have said, the hygroscopic state of atmosphere, as measured by the wet and dry bulb or barometric pressure, cannot alone account for all the phenomena. I find, for instance, that the presence of vegetation affects the atmospheric absorption in a remarkable degree. In the Kyan Chu plain, for instance, the plateau on which I observed the mirage described in NATURE (vol. xiii. p. 67), objects at ten miles distance look as sharp and distinct as those half a mile off. It is, in fact, impossible to judge of distance. Crossing the Tagalung Pass (18,000 feet), we descended from that plain into the valley of the Indus. As soon as we reached vegetation, at a distance of only two marches from the above-

mentioned plain, and at height still above 12,000 feet, the whole aspect of the country is a different one. Distant mountains now take that lofty blue colour which gives such peculiar charm to the landscape. In the evenings especially you cannot help knowing that there is something between your eye and a distant object which affects its colour and distinctness, and through it you get a standard for judging distances. Without vegetation, even at a lower height, as, for instance, in the valley of the Bagha (Lahoul), you seem to look through a vacuum. In the upper part of the valley of the Indus, of which I am now speaking, I have not seen that clearness in the atmosphere which I have invariably seen in Switzerland at a height of 3,000 feet. The strong radiating power of the sun, which stands much more vertical in India, is evidently the cause of this, for it can only be organic matter floating in the atmosphere which can produce such a striking result. That the absence of any rain or deposit of any kind must not be left out of account is clear. The air in the side valleys of Cashmere, although rich in vegetation, is particularly transparent. Strange enough the principal valley of Cashmere, *i.e.* the valley of the Jehlum, is generally hazy, although there is a good deal of rain.

I have seen the planet Mars look almost white; Jupiter and the other stars at that time had a bluish tint.

II.—*Glaciers.*

On the maps of Upper Thibet one finds a great many glaciers marked down. From my knowledge of glaciers I would not have given to these frozen masses of snow the name of glaciers. On inquiring further into the matter, I find that from measurements made by Schlagintweit these so-called glaciers have only very little, if any motion; and judging from what I have seen and heard, I should say they must be only half-formed glaciers. The cause of this seems to me to be the want of pressure above the glaciers. In a country where the snow line is 19,000 feet high, and in which the mountains are seldom over 21,000 feet—for such is the country I am talking of—there cannot be a sufficient pressure to convert the snow into a clear mass of ice. I am however told that there is in Spiti one, but only one, glacier which deserves the name.

III.—*Temperature of the Blood.*

I am sorry that my observations on the temperature of the blood were cut short by untimely breakage of the thermometers. I have taken, however, a few observations in the plains of India, when the temperature of the air was higher than that of the blood. In a temperature of about 100° the blood was little above 98°.

IV.—*Parhelia.*

According to received opinions, parhelia are due to the refraction of light through crystals of ice. If this explanation is correct, and there seems to be no reason to doubt it, the following observations are of interest, as they show that even at the equator ice-clouds exist, and that parhelia are more often seen in India than in England. I have only once been lucky enough to see a parhelion in England, and that was since my return from India. In tropics and in the Himalayas I have seen within four months, eight times a rainbow-coloured ring round the sun. Its distance from the sun could only be measured by rough means, but it seemed to me to be larger than the generally given value of 22°, although near it. I subjoin the various observations :—

1. May 3.—Near Singapore, about sixty miles north of equator, at 5 o'clock P.M., part of a rainbow-coloured ring was seen, with the sun as centre. It stood on the white edge of a dark cloud.

2. Aug. 1.—At Dwara, in the Kulu Valley, almost the exact reproduction of the above phenomenon was seen on a cloud hanging on the side of a mountain. It was during the rainy season, at a height of about 5,000 feet. Weather rather hot.

3. Aug. 3.—Near the top of the Rotang Pass (13,000'), about 9 o'clock A.M., the lower half of a beautifully-coloured ring was seen for about half an hour.

4. Aug. 5.—Gondla (10,000'). At 3 P.M. a beautifully-coloured ring round the sun was seen on a very thin film of clouds in front of the sun. The blue was most distinct, and much purer than in the common rainbow.

5. Sept. 19.—While going down the Jehlum in a boat from Islamabad to Srinagur, I saw in the river the reflection of part of a coloured ring. Looking directly at the cloud, I saw the ring again on the white edge of a cloud. The sun was nearly setting.

6. Sept. 23.—At Baramula, at 4 P.M., I saw the same ring described above most distinctly, and making a complete circle round the sun.

7.—Marching out of Cashmere I was struck one morning by the appearance of the cloud being nearly the same as when I had before seen the circle in question. On looking carefully I could indeed see a faint trace of the ring.

8. Oct. 6.—At Peshawur (Punjab) I saw to the right of the setting sun about the sixth part of the coloured ring.

ARTHUR SCHUSTER

#### VISIT OF THE CHEMICAL SOCIETY TO THE ROYAL ARSENAL

IN response to an invitation from its president, Prof. Abel, F.R.S., the chemist of the War Department, nearly 500 Fellows of the Chemical Society visited the Royal Arsenal at Woolwich on Tuesday last. The presidents of most of the learned societies, together with other eminent men of science, were included in Mr. Abel's liberal invitation, so that during the day a constant stream of visitors flowed through the interesting workshops at Woolwich.

Beyond the ordinary attractions of the establishment, Mr. Abel had arranged to demonstrate the more important applications of science to warfare, and among these were included some experiments with gun-cotton and other explosives, the study of which he has made peculiarly his own. Indeed, the most attractive part of the programme from a scientific point of view was that carried out on the outskirts of the arsenal in the vicinity of the proof butts, where operations commenced by the firing of the big 80-ton gun. Col. Younghusband, F.R.S., R.A., the Superintendent of the Royal Gun Factories, as well as other heads of departments, had entered warmly into the spirit of the visit, and took considerable pains that every opportunity should be given the Fellows of witnessing the capabilities of this monster weapon. A charge of 250 lbs. of gunpowder, the grains of which measured nearly two inches cube, was introduced into the gun, and then the heavy bolt, or projectile, weighing 1,260 lbs. was rammed home. Those who were privileged to enter the chronoscope room, which is so small unfortunately, that scarcely a score of visitors could find room in it, were gratified with a sight of Boulanger's instrument for calculating the velocity of a cannon-ball in its flight, and as the thundering discharge was heard, this delicate apparatus proclaimed, simultaneously, that the projectile had been sent on its way at a velocity of nearly 1,500 feet a second, an impetus, it is said, sufficient to make a hole through the *Inflexible* iron-clad, with her twenty inches of armour and thick teak backing. The Boulanger instrument is easily explained. Placed in front of the gun, at an interval apart, are two wire screens, so arranged that the projectile in its flight tears through them one after another. From two magnets attached to the instrument hang two metal rods, and the instant the first wire screen is torn by the shot, a current of electricity is broken and the first of these rods falls. As No. 1 is in the act of falling, however, the second wire screen is broken by the shot releasing No. 2 rod, and this

sets in action a trigger which strikes No. 1 rod before it has yet completed its fall. If the shot has been slow in travelling from one screen to another, then rod No. 1 has, naturally enough, nearly fallen its entire length before it receives a stroke from the trigger; and the higher the mark is upon the rod No. 1, or in other words, the more it has fallen the less rapid has been the passage of the shot. After the mark is made one has merely to refer to a scale to get the velocity.

After the firing of the 80-ton gun came the gun-cotton programme, which Mr. Abel and Mr. E. O. Brown had arranged for the purpose of demonstrating in the first place the peculiar qualities of this explosive, and secondly its application to war purposes. To quote from this programme, Mr. Abel first gave "illustrations of some of the conditions which promote detonation of an explosive agent by a blow, or by the force exerted by an *initial* detonation." It was shown that gun-cotton refused to detonate except under very special circumstances, that is to say, neither a confined charge of gunpowder nor a small charge of unconfined mercuric fulminate brought about that result, which was only effected by a confined charge of fulminate, or by other masses of gun-cotton being detonated in its immediate vicinity.

Mr. Abel then went on to demonstrate the high speed at which detonation travels, the same being faster than any known agent, if we except electricity and light. A row of gun-cotton cakes half an inch apart, 36 feet long, was detonated at one end, and by crossing the row with several insulated wires connected with Noble's chronoscope (the wires being broken one after the other, as the detonation proceeded), it was proved that the velocity of the detonation exceeded 18,000 feet per second.

But it was the last of the gun-cotton experiments which proved the most interesting to the general body of visitors, as they illustrated the important uses of this valuable explosive. In these trials the gun-cotton was employed for the most part in a *wet*, and therefore *uninflammable* state, in which condition it detonates just as readily as when dry, provided a small charge of desiccated cotton is used to start the action. First of all, the value of detonation was shown in connection with cavalry raids in an enemy's country. Provided with a few pounds of gun-cotton and some fulminate fuses, a trooper might cut half-a-dozen lines of railway with very little ceremony, for, as Mr. Abel plainly showed, an eight ounce cake of the material exploded upon a rail, fractured the metals so completely as at once to block the line. In the demolition of wooden stockades, such as have caused us some difficulty in Perak lately, gun-cotton was shown to be equally efficacious, for a charge of wet cakes placed at the foot of such a structure on Tuesday last, levelled the same to the ground far more quickly than it takes to tell of the incident. Finally, a torpedo was fired under water constructed in the most primitive manner, by simply filling a large potato-net with gun-cotton slabs, and throwing it bodily into the water, a fuzze and dry primer being contained in the middle of the charge.

After lunch, which the president had hospitably provided for his numerous guests, and at the close of which Dr. Hooker, C.B., P.R.S., took the opportunity of thanking Mr. Abel for the intellectual treat he had provided them with, the visitors had the satisfaction of witnessing the process of big gun making, a forging of fifty tons of glowing metal (the coil of one of the 80-ton guns) being worked under the monster 40-ton steam-hammer for their especial behoof.

The last sight of all was certainly not the least interesting. It was the run of a Whitehead torpedo under water, the machine, as our readers may know, being shaped in the form of a cigar and propelled through the water, rocket-fashion, by means of compressed air, which issues from its tail. The passage of this submarine monster the whole length of a canal, termed the torpedo

range, brought to the close a day which the fortunate Fellows of the Chemical Society will certainly remember as one of the most instructive and enjoyable in their varied experiences.

#### NOTES

It is with the greatest regret that we announce the death of Col. Strange, the Inspector of Instruments to the Indian Government, who died on the 9th instant. We shall give an obituary notice next week.

AN impression has become general, through the statements of our contemporaries, that the Sub-Wealden boring has been permanently stopped. This is not the case; for at the last meeting of the committee it was determined to carry it on to a depth of 2,000 feet, and if funds continue to flow in with the success which has previously characterised this movement, the boring, it is hoped, will be carried to the greatest depth attainable. The boring has now reached a depth of more than 1,900 feet, and was to be recommenced this week; should, however, a greater depth than 2,000 feet be determined on, it will be necessary to enlarge and reline the hole, which will cost from 600*l.* to 700*l.* Arrangements are being made by which it is hoped that a continuous core may be obtained from the present depth to that of 2,000 feet. We believe the Government grant of a pound a foot for each foot bored ceases at 2,000 feet, and, looking to the important light the prosecution of this boring will throw, not only on many theoretical questions of modern science, but on so many doubtful points of practical interest to England, it is sincerely to be hoped that the advisability of continuing the grant will be seriously considered by her Majesty's Ministers.

WE have received from Messrs. Allsopp and from Dr. Hassall letters referring to the statement noticed in our review of the work of the latter on Food (vol. xiii. p. 345), that the water used by the former in the brewing of their ales contains 7.65 grains of sulphate of zinc. Dr. Hassall expresses great annoyance that through some inadvertence on his part this unfortunate error, as it obviously is, should have been allowed to get into his book. He points out, what no doubt would be evident to most readers, that sulphate of *zinc* is a mistake for sulphate of *potash*. He assures us that no trace of so deleterious a substance as sulphate of zinc has been found in the water used by Messrs. Allsopp, and that their celebrated bitter beer consists solely of the products of malt and hops, and the constituents of pure spring-water. A further letter from Dr. Hassall, for which we have not space, will be found in our advertisement columns.

WE are informed that Mr. J. E. Harting is engaged in editing for the "Transactions of the Norfolk and Norwich Naturalists' Society" ten unpublished letters of Gilbert White, which have recently come to light. The originals are in the possession of the Rev. H. P. Marsham, of Rippon Hall, near Norwich, and are addressed to his great grandfather, Mr. Robert Marsham, F.R.S., of Stratton Strawless, Norfolk. It is expected that this interesting publication will appear about the end of this month or early in April.

MR. STANFORD has sent us specimens of some very fine maps recently published by him. Two of these are Orographical maps of Europe and of England, and the public in general and educationists in particular ought to be grateful to Mr. Stanford for thus putting within their reach a style of map which has hitherto been peculiar to Germany. The maps are really admirable specimens of a very difficult kind of cartography, and we have only one fault to find with them. Unfortunately, the midland levels are coloured green, while the sea is coloured

blue, so that by gaslight the boundary cannot be distinguished. Why not have the nearest approximation to sea-level coloured white, the various higher levels of the land graduated shades of brown, and those of the sea by various shades of blue or green? This would be a simple and, we think, most intelligible plan. If the slight defect we mention—and it is only noticed under artificial light—were remedied, the maps would be nearly all that could be desired. The third map is a large-scale one, in four sheets, of British Guiana. The map is compiled from the surveys executed under H.M.'s Commission for 1841-44, and under the direction of the Geographical Society, for 1835-39, by Sir R. H. Schomburgk, revised and corrected to the present time by Mr. Cathcart Chalmers, Crown Surveyor of the Colony, and Mr. J. Gay Sawkins, Director of the Geological Survey of the West Indies and British Guiana, with additions by Mr. C. B. Brown. It will thus be seen that the map has been constructed on the latest and most trustworthy authorities. It is a curious fact that the boundaries between British Guiana and Venezuela on the one hand and Brazil on the other have never been properly adjusted.

WE have received a very important letter by Mr. Russell Government Astronomer at Sydney, which we regret that we have not space to reproduce *in extenso*. The letter refers to the excessively dry weather of Australia, which, indeed, has been so dry as to be really alarming, and reviews the results of rainfall observations made at Sydney during the last thirty-six years. This letter suggests to us that the unusual wet weather we have had here may be more than compensated by the excessively dry weather which has prevailed in Australia.

THE Duke of Richmond and Gordon stated in the House of Lords no Tuesday that the Vivisection question was under the consideration of the Government, but he could not say when any legislation would take place upon it.

A FEW days ago a meeting was held in Birmingham for the purpose of establishing a Philosophical Society, and it was found that the proposal met with very warm support. Some difference of opinion was expressed as to the propriety of including literary subjects in its programme, but the general feeling was in favour of keeping to a purely scientific course. A society of this kind is greatly wanted in this important centre, for science is represented there only by the Natural History Society, which, though it has done some good work, is found to have too limited a scope. With the prospect held out by the munificent founder of Mason's College for advanced scientific culture, there can be little doubt that such a society would do great good, and we wish it every success. A proposal for amalgamating the Natural History Society with the new Society has been made, and has been favourably entertained.

MR. R. W. CHEADLE is announced as having been successful in excavating from the well-known brick earth pit at Crayford a bone which was identified by Prof. Morris as the thigh-bone of a British species of lion. Mr. Cheadle found at the same time several rhinoceros' teeth in this cemetery of ancient life among the hop gardens of Kent.

PETERMANN'S *Mittheilungen* for March contains several important papers. H. Habenicht contributes a brief description to accompany a carefully, and notwithstanding its size, remarkably clear map of Europe, showing the distribution of the sedimentary rocks on that continent. A map of South New Guinea between 142° and 143° E. long. shows the course of the recently discovered Baxter River, accompanying which are accounts of the Macleay expedition and of Macfarlane and Stone's exploration of the Baxter River or Mai-Kassa. Lieut. Weyprecht continues his "Sketches from the Far North," in this part treating of the ice-pressure. The account of Lieut.-Col. Przewalsky's



travels in Mongolia and the Land of the Tunguts is continued also.

AT Monday's meeting of the Royal Geographical Society, the principal business was the reading of papers on the interior of New Guinea, by Mr. Stone and Mr. Macfarlane. The writers had found the coast district of New Guinea too barren "even for the cultivation of the banana," but concurred in stating that the country improved considerably as they travelled inland. There they found great fertility, a kind, hospitable people, and a country comparatively free from fever, whereas the coast was barren, the people were morose and warlike, and the climate was destructive of the health of Europeans.—No communication was made respecting Lieut. Cameron, but it was understood that at the last advices he was with his party at Loanda.

THE general staff of the German empire has published a report of experiments made in Germany on ballooning at the expense of the Imperial Government. The conclusions throw no new light on the subject, but the German officers believe that the mechanical direction of balloons is by no means an impossibility. They even suppose that the problem of ascending or descending without using ballast or the valve, is very likely to receive a speedy solution. They propose to the Government to determine by means of experiments what is the best diameter for the helix when it is applied to a balloon of a certain capacity. They propose also to try the efficacy of wings for propelling balloons. They are not of the common opinion that the diameter of balloons can be indefinitely enlarged.

MISS SHEEPHANKS has presented to the Royal Astronomical Society 200 volumes of works on Astronomy, some of them very rare; and Lord Lindsay has presented a large and valuable collection of the late Mr. Carrington's MSS. on the subject of sun-spots.

AT the last regular meeting of the Berlin Geographical Society, Herr Kiefert read a paper on the African Expedition of Lieut. Cameron, which he described as epoch-making, and declared that the general results were the most important since Livingstone.

THE Museum of Paris has lost the services of two of its most eminent professors, M. Milne-Edwards in zoology, and M. Delafosse in mineralogy; they have been placed on the retired list on account of old age. M. Milne-Edwards has been succeeded by his own son, a promising naturalist, and M. Delafosse, by M. Decloizeaux, a member of the Institute.

ON the 4th inst. the Berlin University held an extraordinary meeting to celebrate the fiftieth anniversary of the day on which Prof. Dove was received a doctor. An address was handed to him by Professors Mommson and Du Bois-Reymond. The Minister of Public Instruction was present, and a magnificent vase was presented to Dr. Dove on behalf of the Emperor of Germany. In the evening a banquet took place at the English Hotel. Among those present were Prof. Helmholtz and [a number of other German scientific notabilities.

THE Société Française de Navigation Aérienne has awarded a gold medal and diploma "for devotion to science," to Mr. F. W. Brearey, honorary secretary to the Aeronautical Society of Great Britain.

THE change of Ministry has been completed in France, and M. Wallon is no longer the Minister of Public Instruction. The learned gentleman left behind many warm sympathisers. His successor appointed last Friday is Mr. Waddington, an Englishman by parentage, born in France in 1828, naturalised a Frenchman, and a member of the Senate, but a Protestant by religion, and educated at Rugby and Cambridge. Great efforts are likely to be made to secure for France competent representation at the forthcoming Scientific Loan Exhibition.

THE Cambridge Museums and Lecture-rooms Syndicate report the urgent necessity for increased accommodation in the departments of zoology, comparative anatomy, and physiology, and recommend that steps be at once taken to supply the want. They suggest the erection of a building on a site adjacent to the present museums, to consist of three floors, with cellars under the central portion.

M. HARENT, the director of a private institution, is now the President of the Municipal Council of Paris. He has deposited a formal proposition asking the Council to establish several meteorological observatories for the analysis of rain, water, air, electrical determinations, and ordinary barometer and temperature readings. All these establishments are to be modelled after that of Montsouris, but on a smaller scale.

THE Daily Bulletin of Weather Reports for March 1873 issued by the chief signal officer of the War Department of the United States, has been received. The publication gives on a reduced scale the whole of the tri-daily weather maps for the month, each map being accompanied with (1) the synopsis of the weather conditions, and (2) probabilities of the weather during the next twenty-four hours, drawn from these conditions, and stated on each map at the time of its publication, together with (3) a statement of the actual facts as they occurred with which the "forecasts" of the office may be compared. This fearless and straightforward course of exhibiting equally its successes and its failures, is deliberately adopted by the office in order to facilitate inquiry by scientific men, into the theories and causes which have led to these successes and failures, from which inquiries the practical work of the office cannot fail to reap most substantial benefit.

THE additions to the Zoological Society's Gardens during the past week include 171 Sand Lizards (*Lacerta agilis*) from Italy, presented by Mr. H. Negretti; two Forster's Milvagos (*Milvago australis*) from the Falkland Isles, presented by Lord Lilford; a Great Frigate Bird (*Frigata aquila*) from America, three Black-backed Geese (*Sarcidiornis melanota*) from India, a Gull-billed Tern (*Sterna anglica*), European, a Crested Hangnest (*Ostinops cristatus*), a Cayenne Lapwing (*Vanellus cayennensis*) from South America, an Ogilby's Rat Kangaroo (*Hypsiprymnus ogilbyi*), a Vulpine Phalanger (*Phalangista vulpina*) from Australia, purchased; a Jackal Buzzard (*Buteo jacob*) from Africa, deposited; and a Yellow-footed Rock Kangaroo (*Petrogale xanthopus*).

## SOCIETIES AND ACADEMIES

LONDON

Royal Society, Feb. 3.—On Formulæ of Verification in the Partition of Numbers, by J. W. L. Glaisher, M.A., F.R.S.

Feb. 17.—"Researches upon the Specific Volumes of Liquids." By T. E. Thorpe, Ph.D., F.R.S.E., Professor of Chemistry in the Yorkshire College of Science, Leeds.

### II. On the Specific Volumes of certain similarly-constituted Inorganic Chlorides.

The results of the observations made by Pierre and Kopp upon the boiling-points, specific gravities, and thermal expansibilities of the trichlorides and tribromides of phosphorus, arsenic, and antimony, have led Kopp to suppose that the specific volumes of phosphorus, arsenic, and antimony, in their liquid combinations, may be identical. The same conclusion has been drawn with respect to tin, titanium, and silicon from Pierre's observations upon the tetrachlorides of these elements.

The common value of P, As, and Sb would appear to be about 27, that of Si, Ti, and Sn about 35. But on examining the details of the observations, it becomes evident that this conclusion is not strictly borne out by the results; the numbers obtained for the individual members of the group differ in many cases considerably from the common value, the divergences being far wider than could arise from errors of observation, either in the determination of the physical constants or in the estimation

of the atomic weights of the constituent bodies. In fact the order of the divergences would seem to render it probable that the specific volumes of the several members of a family of elements increase with their atomic weights.

In a former communication to the Royal Society the author has given the results of a series of observations on the specific gravities, boiling points, and rate of expansion of certain liquid chlorides of phosphorus. Since Roscoe has shown that vanadium is a member of the phosphorus group of elements, it appeared to him that a comparison of the specific volumes of the analogously constituted phosphoryl and vanadyl trichlorides might serve to throw additional light on this question of the relation of the specific volumes of the members of a family of elements to their atomic weights.

Three determinations of specific gravity of phosphoryl trichloride made with different bottles gave a mean number of 1.71185 at 0° compared with water at same temperature; compared with water at 4° the specific gravity is 1.71163.

The rate of expansion of phosphoryl trichloride from 0° to its boiling-point may be accurately represented by the expression—  
 $V = 1 + 0.001064309t + 0.0000012666t^2 + 0.00000005299t^3.$

Its specific gravity at 107.23 is 1.50987; hence its specific volume =  $\frac{153.38}{1.50987} = 101.58.$

The results obtained with the dilatometer in the case of vanadyl trichloride may be represented by the formula

$$V = 1 + 0.000965236t + 0.00000089826t^2 + 0.0000000319163t^3.$$

The mean of three experiments gives the specific gravity of vanadyl trichloride at 0°, compared with water at 4°, as 1.86527.

The specific gravity of vanadyl trichloride at 127°.19 is 1.63067; hence its specific volume is  $\frac{173.73}{1.63067} = 106.54.$

It is thus evident that the specific volumes of vanadyl and phosphoryl trichlorides are not equal; the compound with the higher molecular weight has the greater specific volume.

In the communication on the chlorides of phosphorus already referred to, it is shown that if it be assumed, as appears in the highest degree probable, that there is a relation between the manner in which the oxygen atoms in a compound are held in union and their specific volume, it follows that the oxygen atom in POCl<sub>3</sub> possesses the smaller of the two values 12.2 and 7.8 assigned by Kopp to oxygen, and accordingly that this atom is attached to the phosphorus by only one combining unit.

Thus—

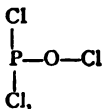

showing that the phosphorus atom in phosphoryl trichloride possesses the same atomic value as in phosphorus trichloride.

As the difference between the two values for the volume of oxygen, viz., 12.2 - 7.8 = 4.4, is but little less than between the specific volumes of VOCl<sub>3</sub> and POCl<sub>3</sub>, viz., 106.54 - 101.58 = 4.96, it is possible that the difference in the specific volumes of the two liquids may be due to the different manner in which the oxygen atoms are united to the vanadium and phosphorus atoms; for, if V be regarded as a pentad, VOCl<sub>3</sub> must be written—

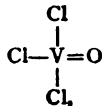

the oxygen atom having the value 12.2. Assuming Kopp's value for Cl, viz. 22.8, this would leave for P and V nearly the same specific volume, viz. :—

P ... ..	25.4
V ... ..	25.9

From the uncertainty respecting the particular volume to be assigned to the oxygen atom in vanadyl trichloride, our knowledge of the specific volumes of VOCl<sub>3</sub> and POCl<sub>3</sub> gives us little aid towards solving the question whether the several members of a family of elements have identical specific volumes.

With a view to obtain further evidence, the author has re-determined with special care the boiling-points, specific gravities,

and rates of expansion of the tetrachlorides of silicon, titanium, and tin.

The atomic weights of Si and Ti and of P and V show about the same gradational difference :—

Si ... ..	28.10	P ... ..	31.00
Ti ... ..	50.00	V ... ..	51.35

And, since the tetrachlorides are free from oxygen, the uncertainty arising from the specific volume of that element is eliminated. He has also compared the specific volumes of the trichlorides of phosphorus, arsenic, and antimony, making use of Kopp's determination in the case of the last-named compound. Material is thus obtained for the discussion of the question from analogous derivatives of two well-defined groups of elements, viz. :—

Si ... ..	28.10	P ... ..	31.00
Ti ... ..	50.00	V ... ..	51.35
		As ... ..	55.15
Sn ... ..	118.10	Sn ... ..	122.30

The results of the determinations of the specific volumes of the tetrachloride of silicon, titanium, and tin, liquids of analogous constitution and all derivatives of the tetrad group of elements, serve to establish the conclusion indicated by the difference in the specific volumes of phosphoryl and vanadyl trichlorides, that the specific volumes of the several members of a family of elements are not identical, but that the specific volume increases with the atomic weight of the member.

	Molecular weight.	Specific volume.
SiCl <sub>4</sub> ... ..	169.94	121.13
TiCl <sub>4</sub> ... ..	191.84	126.03
SnCl <sub>4</sub> ... ..	259.94	131.41

It is also noteworthy that the difference between the specific volumes of tin and titanium tetrachlorides is almost the same as the difference between the specific volumes of vanadyl and phosphoryl trichlorides; the difference between the atomic weights of vanadium and phosphorus is nearly the same as that between the atomic weights of titanium and silicon.

	Mol. weight.	D ff.	Spec. vol.	Diff.
POCl <sub>3</sub> ... ..	153.38	20.35	101.58	4.96
VOCl <sub>3</sub> ... ..	173.73		106.54	
SiCl <sub>4</sub> ... ..	169.94	21.9	121.13	4.90
TiCl <sub>4</sub> ... ..	191.84		126.03	

It would seem from this that the constitution of vanadyl trichloride is similar to that of the phosphoryl compound, and must therefore be expressed by the formula—

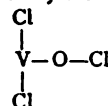

in which V appears as a triad, the oxygen atom having the same specific volume as in phosphoryl trichloride. On the other hand, the order of the divergences shown by P, As, and Sb (*vide infra*), would appear to indicate that V may be pentad in this compound, whence O would have the volume 12.2.

The numbers representing the specific volumes of the trichlorides of phosphorus, arsenic, and antimony exhibit a gradational order similar to that shown by the volumes of the tetrachlorides of silicon, titanium, and tin, and also by the specific volumes of phosphoryl and vanadyl trichlorides :—

	Mol. weight.	Spec. vol.
PCl <sub>3</sub> ... ..	137.38	93.54
AsCl <sub>3</sub> ... ..	181.53	94.64
SbCl <sub>3</sub> ... ..	228.68	97.82

although the differences are much less than in the cases of the two latter groups.

### III. On the Specific Volumes of Bromine and Iodine Monochloride; and of Ethene Bromide and Ethene Chloriodide.

The molecular weight of bromine is, as is well known, nearly equal to the arithmetic mean of the molecular weights of chlorine and iodine: hence the molecular weights of bromine and of iodine monochloride (ICl) are nearly identical. These substances closely resemble each other in physical properties. Both are dark-red liquids about three times heavier than water. Bromine boils at about 59°.5, and solidifies at -24°.5; iodine monochloride melts at +24°.5, and boils at 101°: the interval between the boiling- and melting-points is therefore approximately equal.

It appeared to the author of interest to determine (1) if the specific volumes of these liquids exhibit a relation similar to that which is shown by their molecular weights; and (2) if the relation of their specific volumes is preserved in analogous combinations of the two bodies. He has accordingly determined the specific gravities, boiling-points, and rates of expansion of bromine and iodine monochloride, and of the compounds which these substances form by their union with ethene,  $C_2H_4$ . The observations also serve to determine if bromine and iodine monochloride reserve, when in combination, the volumes which they possess in the free state.

It is evident from the observations that the specific volumes of bromine and iodine chloride are not equal, neither are the specific volumes of ethene bromide and ethene chloriodide; the bodies with the greater molecular weights have the greater specific volumes.

	Molecular weight.	Specific volume.
Bromine ... ..	159.90	53.62
Iodine chloride ... ..	162.31	56.32
Ethene bromide ... ..	187.90	97.30
Ethene chloriodide... ..	190.31	101.27

The number obtained for iodine monochloride differs considerably from the volume calculated by means of Kopp's values  $Cl = 22.8$ ,  $I = 37.5$ , viz., 60.3. The specific volume of bromine ( $Br_2$ ) is also less than Kopp's number, 55.6. The value assigned to chlorine is unquestionably far more accurate than that given to iodine, since the value of the latter element was calculated from only two or three compounds, whereas the former number was deduced from a comparatively large number of chlorinated products. That the value for iodine needs revision seems to be confirmed by Billet's observations of the specific gravities of liquid iodine at various temperatures. If his results be plotted down and the curve prolonged to the boiling-point of iodine, we find that the specific gravity of iodine at this point is 3.780; hence the specific volume of iodine (I).—

$$= \frac{126.85}{3.780} = 33.5.$$

If now this value be added to that of chlorine as given by Kopp, we get a result identical with the observed volume of iodine monochloride—

$$33.5 + 22.8 = 56.3.$$

If we subtract the specific volumes of  $C_2H_4$ , as calculated by the aid of Kopp's values ( $C = 11$ ,  $H = 5.5$ ,  $C_2H_4 = 44$ ), from the specific volumes of ethene bromide and ethene chloriodide, we obtain numbers which are nearly equal to the specific volumes of bromine and iodine chloride respectively—

$$97.30 - 44 = 53.30.$$

$$101.27 - 44 = 57.27.$$

This correspondence between the two sets of values seems to warrant the conclusion that bromine and iodine chloride possess the same volume in a compound which they have when in the free state.

It is not unreasonable to suppose that the same may be true of ethene itself, viz., that at its boiling-point it would possess the same volume which it has in the bromide and chloriodide at their respective boiling-points. On this assumption the specific gravity of liquid ethene would be—

$$\text{Calculated from } C_2H_4Br_2 \dots \dots \dots 0.641$$

$$\text{,, ,, } C_2H_4Cl_2 \dots \dots \dots 0.624$$

Chemical Society, March 2.—Prof. Abel, F.R.S., president, in the chair.—This meeting was entirely occupied with the discussion of the various points in connection with water analyses, raised by Dr. Frankland's lecture at the previous meeting. The debate, which lasted until a late hour, turned chiefly on the respective merits of Frankland and Armstrong's "combustion method," and of the "albumenoid ammonia process" of Wanklyn, Chapman, and Smith, for determining the amount of impurity in potable waters.

Mathematical Society, March 9.—Wm. Spottiswoode, F.R.S., vice-president, in the chair.—Messrs. Cockshott and R. T. Wright were elected members, and Messrs. Elliott, Leudesdorf, and Russell admitted into the Society.—Prof. Cayley made communications on the bicursal sextic and on the problem of three-bar motion. The discovery by Mr. Samuel Roberts of the triple generation of a three-bar curve throws a new light on the whole theory, and is a copious source of further developments. Prof. Cayley gives in its most simple form the

theorem of the triple generation; he also establishes the relation between the nodes and the foci, and further gives other researches. The two papers are intimately related to one another.—Prof. Clifford spoke on the classification of geometric algebras. He sketched out what had been done by Argand (1806); Möbius (1827); Peacock and the Cambridge School (1834); Hamilton (1843); Grassmann (1844, 1862); Peirce (1870); and mentioned results he has himself obtained, for some of which he had not yet got satisfactory explanations.

Zoological Society, March 7.—Dr. A. Günther, F.R.S., vice-president, in the chair.—Dr. Günther exhibited and made remarks on specimens of a minute Australian mammal (*Antechinus minutissimus*) and of a species of *Palythoa* parasitic on a Mediterranean sponge.—Prof. Garrod read a paper on the anatomy of the Courlan (*Aramus scolopaceus*), which he regarded as showing in many respects a close affinity to the Cranes (*Grus*).—A communication was read from Mr. T. E. Buckley, containing remarks on the past and present geographical distribution of the larger mammals of South Africa.—Dr. Cobbold, F.R.S., read the fourth of his series of notes on Entozoa.—Sir Victor Brooke, Bart., read some supplementary remarks on the newly discovered Persian Deer (*Cervus mesopotamicus*), based on additional specimens and information received from Mr. Robertson, H.B.M. Vice-Consul at Busreh.—A second communication from Sir Victor Brooke contained further observations on Schomburgk's Deer (*Cervus schomburgki*) of Siam.

Royal Microscopical Society, March 1.—Mr. H. C. Sorby, F.R.S., president, in the chair.—A paper was read by Mr. W. Hartley, F.C.S., descriptive of certain observations and experiments on the fluids contained in quartz cavities, and which appeared to be liquid carbonic acid, mixed in most cases with water. The subject was illustrated by drawings and by specimens, and experimental demonstrations under the microscope.—A paper was also read by Mr. F. Rutley on the structure of certain rocks, Obsidian and Leucite, and on the spheroidal structure observed in the perlitcs. The subject was freely illustrated by diagrams and specimens exhibited in the room. A paper by the Rev. W. H. Dallinger, on a new arrangement for illuminating and centering for high powers, was taken as read, it being understood that though of great interest it could not readily be explained without the numerous illustrations by which it was accompanied.

Institution of Civil Engineers, Feb. 22.—Mr. G. R. Stephenson, president, in the chair. The paper read was on the Probable Errors of Levelling, with Rules for the Treatment of Accumulated Errors," by Mr. Wilfred Airy, B.A.

Feb. 29.—Mr. Geo. Robt. Stephenson, president, in the chair.—The first paper read was on the floods in England and Wales during 1875, and on water economy, by Mr. George James Symons, secretary to the Meteorological Society.—The second paper read was on evaporation and on percolation, by Mr. Charles Greaves.

Victoria (Philosophical) Institute, March 6.—A paper on the Horus myth in its relation to Christianity, was read by Mr. W. R. Cooper, F.R.A.S.

MANCHESTER

Literary and Philosophical Society, Dec. 6, 1875.—Mr. C. Bailey, vice-president, in the chair.—Mr. Sidebotham, F.R.A.S., sent for exhibition some sand from a river far inland of New Guinea, containing particles of gold, magnetic and non-magnetic iron, foraminifera, silicified fragments of echini, and shells.—Mr. J. Cosmo Melvill exhibited two specimens of the Spurge Hawk Moth (*Deilephila euphorbiae*), said to have been captured in the larval state at Ecclesbourne, near Hastings, feeding in all probability on *Euphorbia amygdaloides*, as he subsequently visited the spot and could see no trace of any other Spurge.

Jan. 17.—Mr. John Barrow in the chair.—Mr. Sidebotham, F.R.A.S., exhibited a magnified drawing and specimens of *Lymexylon navale* from Dunham Park, and read a short paper on the life history of the insect, which he and Mr. Chappell had studied since its discovery in Dunham Park in 1872. Mr. Sidebotham also read a paper on *Psammodytes sulcicollis*, and exhibited specimens taken at Southport in 1875.—Mr. Plant exhibited various objects of interest, including a Longicorn Beetle (*Astino-mus adilis*) from a coal mine near Manchester; also cases of a North American Caddis Worm (*Phryganea* sp.) much resembling a mollusc of the genus *Valvata*, and once named by Lea *Valvata arenicola*.

## GENEVA

Physical and Natural History Society, Jan. 20.—Dr. Prevost, Head Physician to the Geneva Cantonal Hospital, presented a photograph of the brain of a person who had been affected with aphasia. The lesion, which consists in a slightly yellowish softening somewhat like cicatrisation, occupies a space of about two centimètres on the posterior part of the third left frontal convolution. The meninges are adherent on a level with the diseased point. The "island" of Reil is healthy except at a point which touches the affected convolution. The interval separating two convolutions of the "island" presents a yellowish coloration, and contains granulous bodies. The convolutions themselves of the "island" are, on the other hand, sound. This brain belonged to a woman aged seventy-five years, affected for about a month with right hemiplegia without contractions and without loss of sensibility, and who presented an almost

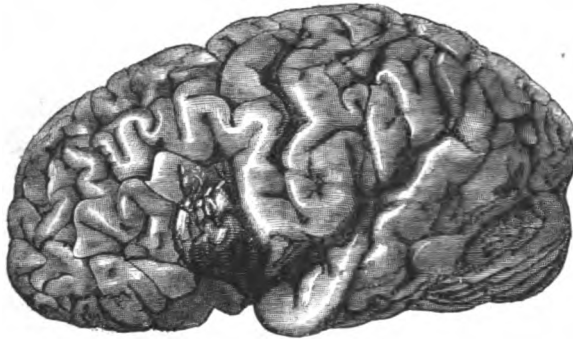

complete aphasia. Incapable of speaking, she pronounced only isolated syllables without any meaning, as *Eh, eh*: Ah, oi; . . . eh, baba - ah! ba, ba, sa-sa-ya. One day she said *maman*; this was the only comprehensible word she uttered. She succumbed twelve days after entry, to bronchitis, for which she came to the hospital. The lesion observed in this case is that which M. Broca regards as constant in cases of aphasia. It is known that M. Meynert and others, on the contrary, localise the faculty of speech in the lobule of the insula, which in the above case was scarcely touched. Dr. Prevost observed at the Cantonal Hospital another case of aphasia, in which the lobule of the insula was the seat of the lesion, while the third left frontal convolution was intact, and thinks we cannot localise exactly the faculty of language exclusively in either of the seats in question.

## PARIS

Academy of Sciences, March 6.—Vice-Admiral Paris in the chair. The following papers were read:—Note on geodesic operations undertaken in Brazil, by General Morin. A Commission is to determine the position of a series of stations from Rio de Janeiro to the town of San Juan de Rio Claro, and the mouth of the Tiele in the Parana. There will be measured an arc of parallel of about 23° S. lat. and 9° to 10° in longitude; and an arc of meridian from about 2° N. lat. to about 33½° S. lat. or more than 35½°.—Transformation of nautical astronomy through the progress of chronometry, by M. Yvon Villarceau.—Note on the steam jacketing of engine-cylinders, by M. Resal.—On the periodical variations or inequalities of temperature, by M. Sainte Claire-Deville. From further data he is able to show that the oscillation of the half of Nov. 1873 was perceptible over Europe, Asia, and America and the northern part of Africa; that is, over nearly the whole northern hemisphere. A similar oscillation in November, 1874, seems to be established.—On a new simplification of the fundamental law of electro-dynamics, by M. Clausius.—The Academy nominated candidates for the vacant chairs of zoology and mineralogy; MM. Alph. Milne-Edwards and Oustalet, for the former, MM. Descloizeaux and Janetaz for the latter.—On the absorption of bicarbonates by plants in natural waters, by M. Barthélemy. *Inter alia*, these bicarbonates do not serve the respiratory action, for the quantity absorbed is not in proportion to the rapidity of vegetation. During night, and in water equally saturated, the plants seem to excrete a part of the bicarbonates absorbed by day.—M. Dupuy de Lôme presented a memoir, by M. Bertin, on the rolling of ships.—M. Andrade described a new governor for steam-engines.—M. de Rostaing spoke of the antiseptic properties of the root of madder. A piece of meat had been kept from July, 1875,

to February 1876, in a pot containing the root in its form, and which had frequently been opened. The weight was reduced from 119 to 25 grammes. There was no development of live organisms.—Methods of preservation based on conservation of an invariable relation of derivatives of the same order, by M. Haton de la Goupillière. Geometrical demonstration of a relation due to M. Lagrange. M. Mannheim.—On the photometry of stars, and the transparency of the air, by M. Trepied. The author tabulates intensities calculated for various stars.—Analysis of the smoke of a blast furnace in the neighbourhood of Lougny. M. Gruner.—Action of electrolytic oxygen on glycerine. Renard. The glycerine diluted with two-thirds of its volume of acidulated water, is submitted to the electrodes from six elements; after forty-eight hours the liquor is saturated with carbonate of lime, filtered, and distilled, giving a dilute solution of glyceric aldehyde. The white residue, after evaporation, has the formula C<sub>3</sub>H<sub>5</sub>O<sub>3</sub>; M. Renard describes its properties. Note on the calorific action of certain regions of the brain and motor apparatus situated on the hemispheric surface, by M. Eulenberg and Lander. These experiments were made on dogs, which were submitted to chloroform and curare, and the brain-surface burnt with hot copper wire and stimulated by induction currents. As thermo-electric elements, Daniell needles were inserted under the skin of the paw, and connected with a very delicate galvanometer. The authors define the efficacious calorific region, and the relation of parts, and they explain the results by vaso-motor changes there which are probably connected with vaso-motor centres of the peduncle of the brain.—On the action of biliary secretions on pulse, the tension, the respiration, and the temperature, by M. Feltz and Ritter. It is shown that by injections of castor-oil into the blood, in proportions that are not toxic, the pulse is diminished in frequency, the respiration is retarded, the temperature and arterial tension are lowered.—Some remarks on MM. Feltz and Ritter's note, by M. Bouilland.—On the structure of the arterial bulb in fishes, by M. Carlet. *Ex ramis* (1) the bulb preserves the branchial arterioles from the shocks communicated by the heart; (2) it facilitates the action of the heart; (3) if its action be prevented, there immediately follows a considerable disorder of the hæmatosis.—Note on inverted sugar, by M. Maumené.

## BOOKS RECEIVED

BRITISH.—Evolution of the Human Race from Apes: T. W. Jones, F.R.S. (Smith, Elder and Co.).—Scientific Culture: Josiah P. Cooke, jun. (H. King and Co.).—Memoirs of Caroline Herschel: Mrs. John Herschel (Murray).—The Geological Record for 1874: William Whitaker, F.R.S. (Taylor and Francis).—Medicinal Plants. Part V.: Bentley and Son (Churchill).—Australian Heroes: Charles H. Eden (S.P.C.K.)

## CONTENTS

UNIVERSITY REFORM	.....
MINERALS OF NEW SOUTH WALES	.....
OUR BOOK SHELF:—	.....
Agassiz's "Geological Sketches"	.....
D'Anver's "Victoria Falls of the Zambesi"	.....
The Earl of Mayo's "Sport in Abyssinia"	.....
Buckton's "Health in the House"	.....
LETTERS TO THE EDITOR:—	.....
Corrections in the Address of the President of the Royal Microscopical Society (vol. xiii. p. 332).—H. C. SORBY, F.R.S.	.....
Vivisection.—FRANCIS DARWIN	.....
The Use of the Words "Weight" and "Mass."—G. JOHNSTON	.....
STONEY; Prof. W. F. BARRETT	.....
Metachromism.—WM. ACKROYD	.....
The U. S. Survey Publications.—FRÉDÉ. T. MOTT	.....
Origin of the Screw Propeller.—WILLIAM EARLEY	.....
The Three Kingdoms of Nature.—E. G. C.	.....
The Recent Storm.—T. S. USHORNE	.....
Bed-time.—VITA BREVIS	.....
OUR ASTRONOMICAL COLUMN:—	.....
Comet 1840 (II.)	.....
Berliner Astronomisches Jahrbuch, 1878	.....
PHYSICAL SCIENCE IN SCHOOLS. By Prof. HENRY E. ROSCOE, F.R.S.	.....
HUNTERIAN LECTURES ON THE RELATION OF EXTINCT TO EXISTING MAMMALIA, IV. By Prof. FLOWER, F.R.S.	.....
Prof. HUXLEY'S LECTURES ON THE EVIDENCE AS TO THE ORIGIN OF EXISTING VERTEBRATE ANIMALS, I.	.....
THE OLD RED SANDSTONE. By Prof. GEIKIE, F.R.S.	.....
ON REPUSSION RESULTING FROM RADIATION. By W. CROOKES, F.R.S.	.....
THE WATER SUPPLY OF THE METROPOLIS. By Dr. FRANKLAND, F.R.S.	.....
SCIENTIFIC NOTES TAKEN IN THE HIMALAYAS. By Dr. A. SCHUSTER	.....
VISIT OF THE CHEMICAL SOCIETY TO THE ROYAL ARSENAL.	.....
NOTES	.....
SOCIETIES AND ACADEMIES	.....
BOOKS RECEIVED	.....

THURSDAY, MARCH 23, 1876

## FRENCH AND SWISS TROGLODYTES

*Reliquiæ Aquitanicæ*; being Contributions to the Archæology and Palæontology of Perigord. By Edouard Lartet and Henry Christy. Edited by T. Rupert Jones, F.R.S. (London: Williams and Norgate, 1875.)

*Excavations at the Kesslerloch near Thayngen, Switzerland.* By Conrad Merk. Translated by John E. Lee, F.S.A., F.G.S. (London: Longmans, Green, and Co., 1876.)

ALTHOUGH the term Aquitaine employed in the title of this work is used in its widest sense as embracing the whole country between the Loire and the Cévennes, the prehistoric researches recorded in the seventeen quarto numbers of it, which have appeared periodically, commencing in December 1865, are confined to the Province of Perigord, and chiefly to the valley of the Vezère, a tributary of the Dordogne.

Here the river, which has cut its way deeply into the cretaceous rocks of the district, has formed a narrow tortuous valley, bounded on either side at intervals by cliffs rising to a height of 300 feet in some places. Above this the surrounding country forms an extensive plateau, varying in altitude, but rarely rising to any great height above the summit of the valley.

Owing to the different degrees of hardness of the calcareous rocks which form the precipitous sides of the valley, the weathering of the face of the cliff has been very unequal, the softer portions yielding to the action of the atmosphere have formed deep grooves, and in places, caves as much as 30 feet in depth have been formed, extending some of them, for a hundred yards or more along the sides of the cliff. As these caves afford convenient places of shelter, they have been occupied as residences by the inhabitants of the valley at many different periods, but more particularly by a race of prehistoric Troglodytes, who form the subject of the present work.

The presence of these people is indicated by successive layers of *débris* beneath the present floors of the caves denoting successive periods of occupation, and separated from each other in some places by a coating of stalagmite of considerable thickness. The small distance of some of the caves above the river proves that the latter can have deepened its course but little, if at all, since the caves were occupied by prehistoric men; the cave of La Madelaine, in which numerous works of art of the Troglodytes have been found, is but little above the level of extraordinary floods of the river at the present time, whilst those of Le Moustier and Les Eyzies are 90 and 100 feet respectively above the river. The position of the caves, consequently, affords little or no evidence as to the age of their contents, which has to be determined in two ways, firstly, by the associated animal remains; and secondly, by the nature of the relics of human workmanship. From both of these sources we derive proof of the greater antiquity of the Le Moustier cave than those of La Madelaine, Les Eyzies, and Laugerie Basse, in the same valley.

Comparing the fauna of these caves with that of other well-known finds of the prehistoric era elsewhere, we find that the following sequence has been established. Sum-

marising briefly, and omitting for the sake of clearness many details which ought, nevertheless, to have weight in a full consideration of the subject, the following are the animals, the remains of which are most prevalent in the different prehistoric periods. In the Drift, the mammoth, rhinoceros, horse, and ox, are the predominant animals, and the reindeer appears but sparingly. In the cave of Le Moustier the mammoth and reindeer are both found, but the latter is still found sparingly. In the other caves of the valley the same fauna is found, but the remains of the reindeer are abundant, and these caves are consequently attributed "par excellence" to the reindeer period. In the kitchen middens of Denmark both mammoth and reindeer are absent, and the class of domestic animals is represented only by the dog. In the oldest of the Swiss lake villages the mammoth and reindeer are also absent, although they existed formerly in the neighbourhood, as shown by the contents of the caves, and domestic animals are abundant. Both mammoth and reindeer are wanting in all the tumuli and other prehistoric monuments of the Celtic period, in Gaul, showing that they must have disappeared from this part of Europe before that time.

Turning now to the relics of human industry, we find a corresponding sequence in the different ages. In the Drift, none but the large, rude, flint tools known as the Drift type are found. In the cave of Le Moustier these large rude tools are also found, and here only amongst the caves of the valley, and they pass gradually into another form known as the side tool or scraper, which is also wanting in the later caves, where they are replaced by lance heads of finer make and finish. In these also, carved harpoon heads of bone begin to appear, and engravings of the mammoth and reindeer, scratched by the hand of man on fragments of horn and bone. No pottery or ground axes are found in any of the caves, nor was the art of spinning known. In the Danish kitchen middens, ground axes are found, though rarely; pottery is frequent, and the art of spinning in some form appears to have been introduced. In the oldest of the Swiss lake habitations, ground axes and pottery are abundant; spinning, weaving, and the cultivation of wheat was well known.

From the study of their arts we are led naturally to inquire into the physical peculiarities of the inhabitants of the caves; on this point, however, our evidence is somewhat meagre. Skulls of a brachycephalic type, and others approaching to that form, had led Dr. Pruner-Bey to attribute the inhabitants of France of the reindeer period to a Mongol origin, but in these caves we are introduced to a race of men whose form of cranium is decidedly dolichocephalic. In the valley of the Vezère at Cro-Magnon not far from Les Eyzies, a cave was discovered and explored by M. Louis Lartet, which contained the remains of four individuals. These remains were situated at the back of the cave, above a series of deposits which marked successive periods of the occupation of the cave, and the whole cave had been filled up by a talus which had fallen from above. The animal remains found in the relic beds of the cave consisted of bear, mammoth, lion, and horse. Reindeer was also found but in small quantities, and this circumstance, coupled with the absence of carved or engraved bone, led

the explorers to attribute the find to the earliest cave period. The position of the human remains, however, above the relic beds would, as Mr. Boyd Dawkins has shown in his work on "Cave-Hunting," be sufficient to throw doubt on their contemporaneity with the other relics of the cave were it not that skeletons have been since found in other caverns in the valley, and more particularly in that of Laugerie Basse, in positions which make it certain that they are of the age of the works of art found with them, and these skeletons correspond in their osteological peculiarities with those of Cro-Magnon. In both places the skulls are dolichocephalic, and both afford instances of men of large stature having platycnemic tibias, one of those from Cro-Magnon being, according to Boyd Dawkins, the extremest case of platycnemicism on record. We have therefore good grounds for believing that markedly different types of mankind existed in the south of Europe during the reindeer period. This result has been held by polygenists to afford satisfactory confirmation of their views, but we may be permitted to doubt the validity of such conclusions. If, as has been suggested by Prof. Huxley, this part of Europe was occupied in the earliest times by a race of Melanochroi, consisting of a mixture of the dark long-headed race of the south with the fair and presumably short-headed race of the north, it is evident that types as divergent as any that are to be found at the present time must have existed amongst the earliest known inhabitants of this region. A long previous period of geographical separation under different climatic conditions would be sufficient to give permanence to varieties as distinct as any that have been brought to light by the researches of Anthropologists. We are far from believing that the reindeer period has carried us more than a short way towards the origin of the human race.

Since the explorations of Messrs. Lartet and Christy were brought to a close, another chapter has been added to the history of the reindeer period by the discovery of Mr. Conrad Merk in the cave of Kesslerloch, near Thayngen, in Switzerland; the value of this discovery is greatly enhanced by its vicinity to the relics of the later inhabitants of the lakes. Had the lake habitations been occupied at the same time as the cave, evidence of connection must undoubtedly have been found, but the contents of the cave point undeniably to a period contemporaneous with the remoter Troglodytes of the Dordogne. Amongst the fauna the presence of the mammoth, rhinoceros, cave-bear, lion, and reindeer are alone sufficient to warrant this conclusion, whilst at the same time the works of art show a most remarkable resemblance to those of the French caves, and an equally marked contrast to those of the oldest of the Swiss lake villages. The carved harpoon heads of bone, the absence of pottery, the presence of deer-horns perforated with large holes bored from both sides, the use of which is unknown, and above all the engravings of animals, especially the reindeer, upon the horns of those animals, show that a condition of culture corresponding to that of the Dordogne people must have existed here.

Opinions differ as to which of the two localities have produced the highest types of art; the difference of style observable in the engravings is such as might be expected to exist amongst remote tribes, but the resemblance, when

compared with the productions of other races of savages is no less remarkable.

One of the engravings, attributed to the cave at Kesslerloch, calls for a few remarks. Of the genuineness of the relics discovered in this cave, no doubt has been entertained, with the exception of two. One of these, said to have been found by a workman in a heap of rubbish after the excavations had been completed, and under circumstances which gave rise to suspicion, represents a fox drawn front view, with the hind quarters foreshortened. The specimen has been placed in the Christy collection in Victoria Street, not as a genuine relic of the cave, but for convenience of future reference. It is worthy of observation that in all the genuine engravings from the caves of both places the animals are invariably drawn with a side view, and generally following each other in the same direction, much as a child might have drawn them, and the same peculiarity is often to be noticed in the bone engravings of the Esquimaux. The forger of Kesslerloch was no doubt not aware of this, or a feebler exercise of his artistic talent would have served him in better stead. He has, however, done good service by drawing attention to the fact that the fore-shortening of a figure represents a phase of art at which the men of the reindeer period had not arrived. Surprise has been expressed by many at the truth and freedom of some of these designs, *appertaining* to so remote a period of man's history; but when we consider how early the power of drawing animals is shown by many of our own children, and how much pleasure they take in exercising it, we need not wonder that a great development of the faculty of imitation should be found to exist side by side with the proofs of a low condition of culture. Upon the whole we see nothing in these or any of the prehistoric discoveries of our time to weaken our faith in a slow but continuous progression from lower to higher forms of art and industry.

#### THE BOTHKAMP SUN OBSERVATIONS

*Beobachtungen angestellt auf der Sternwarte des Kammerherrn von Bülow. Heft III. Edited by Dr. O. Lohse.*

WHOEVER knows the good work that has been done at the Solar Observatory at Bothkamp will hear with regret that the observatory has ceased to exist. It seems that the work was discontinued as soon as Dr. Vogel left it to take his place in the new observatory of Berlin. The history of M. von Bülow's observatory is a fresh proof that work which requires long and continued observations cannot be made dependent on the generosity of a single man, but must be carried on by the State; yet everybody will join in Dr. Lohse's hope that the proprietor of the observatory, to whose liberality we are indebted for the observations made during many years, by Dr. Vogel and Dr. Lohse, and for their publication, will decide to continue his generous and useful work at a future time.

In two previous parts Dr. Vogel has given us the results of his observations, and we are promised a fourth part containing some further researches of his. The third part, which has just appeared, contains the work done by Dr. Lohse.

The paper consists in great part of tables containing



observations. The list of sun-spots at the end of the publication and the various extracts from the note-book prove very useful to those who are engaged in researches of a similar kind. The observations seem to have been conducted with great care, and Dr. Lohse gives in every case the exact method by which the measurements have been made.

If we endeavour to review a work which is not being continued, at least for the present, we rather turn to the usual results of the observations than to a mere list of accumulated facts. This list, no doubt, may prove hereafter to be the most important part of the work, yet it is only made important by those who discuss the observations. The more doubtful and hypothetical part, concerning the conclusions, is therefore the better test for the moment, for we must not forget that without a guiding principle a mere tabular arrangement of facts is useless.

One of the most curious results of Dr. Lohse seems to be the discovery of a period of fifty days in the eruptive activity of the sun. Dr. Lohse took from the drawings of protuberances published by the Spectroscopic Society in Italy, the area of the protuberances as shown in the drawings for each day, and made a curve in which the times of observation formed the abscissæ and the area of the protuberances the ordinates. This curve first shows maxima and minima corresponding to maxima and minima of sun-spots. It next shows a short period of fifty days. During the years 1871, 1872, and the beginning of 1873, this period was well marked. From the middle of 1873, however, the whole solar activity became so small, owing to its chief periodicity of eleven years, that these secondary maxima cannot any more be distinguished.

We turn now to the spectroscopic observations, in which Dr. Lohse was led to somewhat similar conclusions as Mr. Lockyer. It is a well-known fact, that while nearly all the elements standing at the positive end of the electro-static series are found in the sun, we have as yet obtained no decided evidence of the more electro-negative elements. On the other hand, it is not probable that the sun should not contain so many bodies which play an important part in our world. Both Mr. Lockyer and Dr. Lohse came to the conclusion that we must look in the outer and cooler layers of the sun's atmosphere for evidence of the metalloids, but while Mr. Lockyer assumes that they exist as well in the hotter parts of the solar envelope, but under such conditions that we cannot identify their spectra, Dr. Lohse assumes that they do not exist except in the outer layers of the corona. Dr. Lohse is thus forced to assume a force in the sun which drives all the more electro-negative elements away from its centre. This is an hypothesis which we cannot accept, unless we have independent evidence in its favour, or unless it is the only one which will account for the facts; just as we could not accept Mr. Lockyer's hypothesis, if we had no evidence of changes in spectra produced by variations of temperature and pressure. Mr. Lockyer's hypothesis has a decided advantage over that of Dr. Lohse, for we have recently obtained such strong proofs of the changes of spectra produced by a variation of temperature and pressure, that we cannot help thinking that, had Dr. Lohse been acquainted with all these recent experiments, he would have come to the same conclusion

as Mr. Lockyer. This conclusion, indeed, seems inevitable, if it is once assumed that the metalloids really exist in the sun. It is important to mention that this presence of metalloids in the sun is rendered still more probable by the fact that the red and most likely cooler stars give spectra containing fluted bands.

It is interesting to notice that Dr. Lohse finds many of the unknown dark lines contained in the blue end of the solar spectrum to be reproduced in the spectrum of  $\alpha$  Herculis, and although weaker in that of  $\alpha$  Orionis, while they are absent in that of  $\alpha$  Bootis.

Dr. Lohse does not seem to arrive at any results differing much from those of other observers in his observations on faculæ and sun-spots. It is a matter of regret that he, most likely for the sake of brevity, does not enter more fully into the explanation of his own views. A discussion of ideas described in such a cursory manner is impossible, as such a description is necessarily incomplete.

We hope that Dr. Lohse will have occasion to follow out his researches, and do not doubt that he will be rewarded by most interesting results.

ARTHUR SCHUSTER

#### OUR BOOK SHELF

*The Absorptive Glands of Carnivorous Plants.* By Alfred W. Bennett, M.A., B.Sc., F.L.S., Lecturer on Botany at St. Thomas's Hospital. Read before the Royal Microscopical Society, Dec. 1, 1875. With one plate.

MR. BENNETT notices the occurrence in *Drosera rotundifolia*, *Pinguicula vulgaris*, and *Callitriche verna* of peculiar bodies, which at first sight might be mistaken for stomata, and consisting of two nearly hemispherical cells filled with protoplasm. Each of the hemispheres contain a darker nucleus-like spot, and each is surrounded by a thin-walled cell containing chlorophyll. From these hemispherical bodies are developed the papillæ with thin walls and containing chlorophyll. *Drosera* and *Pinguicula* are carnivorous, and Mr. Bennett suggests that *Callitriche* may also be carnivorous, from the occurrence of these peculiar bodies. It seems probable that they are really as Mr. Bennett thinks, absorptive glands, and they certainly bear a strong superficial resemblance to the quadrifid processes found and described by Darwin in *Utricularia* and *Genlisea*. The subject is a very interesting one, and it is to be hoped that further research will throw more light on the matter. It is rather difficult to get a clear idea of the structures from the plate, which seems a little out of drawing, and rather confusing.

W. R. MCNAB

*Reseña de las Rocas de la Isla Volcánica Gran Canaria.* Por Don Salvador Calderon. (Reprinted from the *Anales de la Sociedad Española de Historia Natural*. Tomo iv.) Madrid 1876.

IN this work, which is appropriately dedicated to M. Berthelot—to whom we owe one of the earliest descriptions of the geology of these interesting islands—the author gives some valuable information concerning the relations of the different classes of volcanic rocks to one another. He also describes some of the vast "Calderas" or craters so characteristic of this group of islands, and notices the theories which have been proposed to account for their origin. Of especial interest, however, is the account which he furnishes of the nature and composition of the different varieties of volcanic rocks, and the classification which he proposes for them. It would appear from this work of Señor Calderon, that the true or "sanidine-

trachytes" have not yet been found in these islands, but that the predominant felspathic constituent of the more acid rocks is always plagioclastic. Hence they are described under the names of Andesite, Trachy-dolerite, and Trachy-diorite. The first of these would appear, from the definition given, to correspond with the well-known lavas of Hungary, the last to resemble the greenstone trachytes or "propylites" of the same country. These trachytic rocks are found to assume at times a vitreous character, thus passing into obsidian; and they occasionally exhibit the perlite modification of structure. The basaltic rocks, noticed by the author, do not appear to offer any features of special interest.

*La Biologie.* By Dr. Charles Letourneau. Bibliothèque des Sciences Contemporaines. (Paris: C. Reinwald et C<sup>e</sup>, 1876.)

THIS small work within five hundred and fifty pages gives a concise description, in a popular form, of the phenomena exhibited by living organisms. "C'est une œuvre de vulgarisation," intended for the commencing student and the amateur. Such being the case many important facts have to be omitted, and much has to be embodied in a general form. As in most works many of the broad statements are apt to mislead. It is all very well to say, as does Dr. Letourneau, that the heart is trilocular in the reptiles and quadrilocular in birds, but considering the nature of that organ in the crocodiles, we think its nature in them ought to be mentioned. The title of the work is so all-embracing that we think it can hardly be justified by its contents. Morphology as well as physiology, together with the principles of evolution and classification, are all parts of "biology," nevertheless in the work before us morphology, and the immediate dependents of that science, are not touched upon. A more fitting title would have been "Comparative Physiology, Vegetable, and Animal." Several illustrations are introduced, and these are well selected; most if not all from other works. The descriptions are clear and concise, many too short to be of much service except as a first-book.

*Algebra for Beginners.* By James Loudon, M.A., Professor of Mathematics and Natural Philosophy, University College, Toronto. (Toronto, 1876.)

THIS work is an elementary one, taking the usual subjects up to and including Quadratic Equations. There is a chapter on Exponential Notation, giving a fair exposition of the Theory of Indices. There is nothing noteworthy in the execution: it is quite on a par with many similar text-books in this country, so that the chief point of interest is the information it gives us as to what instruction is given in the subject to the rising generation in Canada. The use of *monomial* strikes us as being affected. The work is exceedingly correctly printed. There are but six mistakes, we think, in the whole book, three of which are in the answers (xv. 3, xxxvii. 14, li. 16). Many of the questions are traceable to English sources.

#### LETTERS TO THE EDITOR

[The Editor does not hold himself responsible for opinions expressed by his correspondents. Neither can he undertake to return, or to correspond with the writers of, rejected manuscripts. No notice is taken of anonymous communications.]

##### Coloured Solar Halos

IN his interesting scientific notes taken in the Himalayas, and printed in the last number of NATURE (p. 393), Dr. Arthur Schuster mentions the frequency of the occurrence, in India, of rainbow-coloured rings round the sun, and states that he has only once seen this phenomenon in England. The apparition of a complete iridescent circle is no doubt rarely seen, but I have, since the winter of 1873-74, when I first observed them, so frequently seen fragments of such rings both in Switzerland and in

England, that their non-occurrence, when thin white clouds are near the sun, seems to me to be the exception rather than the rule. In this country, and generally at low elevations, they are not easily detected by the unassisted eye, but in the high Alps both in summer and winter I have rarely failed to see them, when the sun and a thin white cloud were at the necessary distance from each other; they are, however, much more easily observed when the eye is protected from the glare by the neutral tinted glass which is frequently used for snow spectacles. The first and most vivid iridescent halo I ever saw, appeared projecting from the side of a mountain from behind which the sun was about to rise, near the summit of the Fluela pass, and about 7,000 feet above the sea. This was in the winter of 1873-74, and the thermometer stood at 19° Fahr. Last August and the first half of September I saw them almost daily on the Riffelberg and at Pontresina, and I have repeatedly noticed fragments of iridescent rings during the past autumn and winter in crossing Kensington Gardens about 9.30 A.M. In London, however, the blue and green rays are rarely visible, owing no doubt to their absorption by the murky atmosphere, whilst the orange and red rays easily reach the eye. On Sunday last, with snow upon the ground, I saw, through neutral tinted glass, the orange and red of the halo as the thin edges of clouds approached, or receded from the sun, and on Monday I distinctly saw the green also.

I hold these coloured halos to be a decisive proof of the frozen condition of the clouds in which they appear; firstly, because the cloud seen on the Fluela pass, when the thermometer was 13° below the freezing point, must have been frozen; and secondly, because I have repeatedly seen a portion, at least, of the lower half of the iridescent circle in the high valleys of Switzerland by looking along a field of snow sloping upwards towards the sun, and when the thermometer indicated temperatures varying from -15° 5 Fahr. to +23° Fahr.

It would be worth while to have the occurrence or non-occurrence of these halos daily recorded in our meteorological observatories, as indications of the temperature of the air at great altitudes.

E. FRANKLAND

#### On the Evidences of Ancient Glaciers in Central France

IN NATURE, vol. xiii. p. 31, Dr. J. D. Hooker gives some notes of traces of ancient glaciers in Central France, especially in the Mont Dore, and in a following short letter (p. 149 of the same volume), in reference to this notice of Dr. Hooker, the late Mr. G. Poulett Scrope, the celebrated describer of the volcanic regions of that country, calls in question the exactness of Dr. Hooker's observations. Dr. Hooker in a subsequent letter (p. 166) insists upon the correctness of his views, which he seems to believe original and never before advanced. Neither Dr. Hooker nor Mr. Poulett Scrope seem to have known that I have already, in a paper published in the *Ausland* (1872, Nos. 20 and 21, pp. 460 and 512) entitled, "Erosions und Gletscherwirkungen im Mont Dore, &c." described the traces of glaciers to a still greater extent than even Dr. Hooker does. Not only did I name the place in question (which is situated just at the entry of the Gorge d'Enfer, upper valley of Mont Dore) and describe it as an ancient frontal moraine of a glacier, but I have also given the view of the late Prof. Lecoq (who was never an Abbé as Mr. Poulett Scrope seemed to believe), who says in reference to this locality, *that if ever a glacier had existed in Mont Dore it must have been in this valley.* But besides this point, which in itself is decisive, I noticed a great number of other localities affording examples of polished rocks, transported and rounded blocks, stone lines, and other evident traces of glaciers, which I will not re-enumerate, as they may be found in my above-mentioned paper.

It is quite clear that Mr. Poulett Scrope was in the wrong in denying that those signs in the Mont Dore are the effects of glacial action, but on the other hand, I must, in justice to myself, courteously remind Dr. Hooker that I have the priority in describing those marks as glacial traces which Lecoq interpreted as water-flood traces. I may say in conclusion that this learned geologist of Central France (Lecoq) personally turned my attention to those phenomena while visiting the Auvergne in 1867, and seemed inclined to accept my interpretation.

Breslau University, Prussia, March 10 A. VON LASAULX

#### The Uintatherium

IN the abstract of my lecture published in NATURE, vol. xiii., p. 387, it is stated that "the first discovered evidences of the

rence of animals of this group were described by Leidy, in 2, under the name of *Uintatherium*." Intricate questions of priority, such as those in which the nomenclature of many of the recent American palæontological coveries is unfortunately involved, cannot be discussed and dled in brief abstracts; but I see that the above statement aveys a wrong impression, which I shall be glad to correct. nes of some of these animals were discovered by Prof. Marsh d Lieut. Wann, of the Yale College exploring party, near ge Creek, Western Wyoming, in September 1870, and de- bided by the former in the following year (*American Journal Science and Arts*, July 1871, p. 351), though referred pro- tionally to the genus *Titanotherium*. There seems, however, be no doubt that Leidy's name, *Uintatherium* (*Proceedings of e Academy of Natural Sciences*, Philadelphia, 1872, p. 169; ad July 30, published August 1), was the earliest of the new- neric designations applied to any of the group, and therefore ight to be adopted for the whole, until it is clearly shown that y sufficiently important distinctions exist between them to rarrant their separation into different genera.

March 18

W. H. FLOWER

Morell's "Euclid Simplified"

IT is only quite recently that my attention has been directed to the review of "Euclid Simplified" in NATURE, vol. xiii. pp. 01-204. I shall endeavour to condense my reply to the criticisms obtained in that review as much as possible, taking them in the order in which they occur, which will simplify the controversy.

And firstly, it is objected that "the title 'Euclid Simplified' is a misnomer, for the method of Euclid (the geometer) is departed from altogether." I reply by explaining that by far the greater part of the theorems and problems, and also the method followed throughout in "Euclid Simplified" are taken directly from Amiot's "Éléments de Géométrie" (15th edition, 1873). In his preface to another work, "Leçons Nouvelles de Géométrie Élémentaire" (1865), Amiot says: "Les éléments de géométrie que nous venons de réimprimer et cette seconde édition des Leçons nouvelles de géométrie, sont deux ouvrages différents. Le premier n'est que l'exposé de la géométrie des anciens; le second est un essai de géométrie générale, c'est-à-dire qu'il comprend non seulement les éléments d'Euclide, mais encore les principes de la géométrie moderne, qui est resumée et, pour ainsi dire, personnifiée dans les travaux de M. Chasles, notre géomètre par excellence." I infer that in adopting and following Amiot's "Elements," I have followed the ancients and Euclid, though shortened and simplified.

At a subsequent part of the review the writer is exposed to severe animadversions for his intention to produce what is represented to be an epitome of the brilliant discoveries of M. Chasles. This matter can also be set at rest by referring to the extract from the preface of M. Amiot, previously given. Mr. Morell has only projected a compilation and translation from Amiot's "Leçons Nouvelles," and from Rouché and De Comberousse (1<sup>re</sup> Partie. Géométrie Plane. Appendice), also treating of modern geometry.

Passing from the title to the contents, I admit that the typographical errors are unfortunately numerous, nor is it possible to avoid this except by employing the best and most expensive printers. The misprints *maner* and cord, the omission of the word "side" before "of the equilateral triangle," and the passage relating to the quadrilateral *ABCD* must be referred to this category. The latter passage is translated from Legendre (edition 1868 [not 1872], p. 78), and requires the fourth side *AD* to be added, which has been omitted by the printer. For "without changing" read also "thereby changing"—in this case I confess an oversight of the writer.

I proceed next to meet the strictures of the reviewer relating to Gallicisms and the use of terms new to boys. In defence I might point to the Hellenisms and Latinisms in our School Euclid, and affirm that Gallicisms are more nearly akin to modern English.

I content myself with pointing to the employment of terms, condemned in "Euclid Simplified," by writers of approved excellence, including Gerard's "Elements of Geometry." It is objected that I write, p. 168, "The centre of similitude is the meeting-place." I find at p. 36 of Mr. Gerard's "Elements of Geometry," "The meeting point of two lines." . . . Again the terms "perpendicular to the centre, perpendicular to the middle," censured in "Euclid Simplified," ought to be taken in connection with the ensuing words: "to the centre of the straight line *AA'*" and "to the middle of *AB*." Thus ampli-

fied, the terms agree with those used by Mr. Wormell—"perpendicular to *DE* at its middle point *C*." "The perpendiculars to the sides of a triangle at their middle points." ("Modern Geometry," pp. 78-81.)

Before I dismiss this question of terminology, I wish to suggest that recent works on geometry in high repute, especially those I have just named, introduce very fully terms with which boys are not at all acquainted, and which are new in English. I briefly enumerate a list of these new importations: Escribed, exscribed, explements, intercepts (used as a noun), circumscriptible, intangence, bisectrix, extangent, median, a plane lune, octant, and many more which cannot be introduced here for want of space.

Considering the further criticisms, I beg to explain that no notice of the Association for the Improvement of Geometrical Teaching was inserted in the preface because absence from England and ill-health had severed me from all knowledge of its proceedings and of its Syllabus.

If the enunciations are loosely and inelegantly worded, Amiot must bear the blame which attaches in a greater degree to our translations of Euclid.

Further, the objection made to my use of the terms "capable angle" must extend to the use of the same term in Gerard's "Elements," p. 310.

In the definition of the parallelogram the printer has omitted "and parallel," words which I find in my MS. The term lozenge is used as synonymous with rhombus by Wormell ("Elementary Course of Geometry," p. 65), and Gerard, p. 235. The definition of the circumference is that of Amiot ("Elements," p. 40) and Gerard (p. 76). That described by the reviewer as the common school-boy definition is Wormell's, p. 28. The expression "a circumference is generally described in language by one of its radii" is thus given in Amiot: "On designe ordinairement une circonférence par l'un de ses rayons." I shall pass over the criticisms about "the" and "a" as too minute, also the remark about major and minor arcs met by Def. 36. Problem VII. shows any boy of ordinary intelligence how to bisect a line.

Derivation in notes is not treated syntactically, and can also be dismissed. But the remarks of the critic about the use of *R* as meaning right angle are met by referring to Wormell's (p. 173) use of *CCM* as greatest common measure. The term pentadecagon is used by Gerard (p. 202).

The proof of the ratio of two rectangles  $\frac{R}{r}$  is Legendre's; and

at p. 67, after showing that  $\frac{R}{r} = 4$ , he adds: "Ainsi le rectangle *R* contient quatre fois le rectangle pris pour unité" (*i.e.*, *r*). This conclusion in my book is criticised.

The reasoning to Theorem VI. (p. 148), which is called defective in the review, only errs by excess of proof. I have little more to add. The "Essentials of Geometry" are almost entirely a translation of a useful Spanish work by noted mathematicians.<sup>1</sup> The 205 exercises are throughout from Amiot, and as these 205 exercises are literally all from Amiot, it is a serious charge to say, like the reviewer, that many of them are objectionable in geometry. In Exercise 30 "a" quadrilateral is a misprint: read "this."<sup>2</sup>

J. R. MORELL

"Weight" and "Mass"

THE correspondence which has recently appeared in NATURE on this subject has great interest for those engaged in teaching Physics. I confess I regretted to learn that "gravity" had been diverted from its long recognised meaning in science—that pointed out by Mr. Stoney—at Glasgow, to be employed for one of the meanings of the word "weight." The symbol "g" is "gravity" represented by its initial letter, so that if the meaning of the word be changed, consistency would require that the symbol should be altered. I find, practically, no difficulty in restricting the word "weight" to the sense of force, insisting on the use of the phrases "mass of so many pounds, ounces, or grammes," and "force equal to the weight of a mass of so many pounds, grammes," &c.; for which, after some time, I allow the use of the phrase, "the weight of so many pounds."

On another point of nomenclature I would suggest that those who, like myself, think it necessary to use the British units co-ordinately with the metric, should adopt some analogue to the

<sup>1</sup> Their names will be given when I recover the book or get another copy.  
<sup>2</sup> The work of Mr. Wormell to which reference is made in this letter is (with one exception) his excellent "Modern Geometry," published by Murby.

*dyn.* I use *vis* (pl. *vires*) to express the absolute unit of force in the F. P. S. system of units, with the multiples *decemvires*, *centivires*, *millivires*. Thus nine *centivires* is very closely equal to the weight of twenty-eight pounds in this country.

I should add that the distinction between "weight" and "mass," generally recognised, but not uniformly insisted on in practice, is clearly pointed out in Prof. Everett's useful tables.

University Hall, March 18  
J. J. WALKER

**The Dry River-beds of the Riviera**

THOSE who have visited the Riviera of Piedmont will remember as one of its most remarkable features the broad stony river-beds, sometimes with a meagre rill trickling down a narrow channel in the middle, sometimes entirely dry, but never with any body of water sufficient to account for the immense bed; the Paglione at Nice, with its bed spanned by a bridge of three broad arches, and with a stream never more than four or five feet wide and a few inches deep, is a specimen of what I mean. Can any of your scientific readers tell me what and when was the change of climate which caused what must once have been large rivers to shrink into mere rivulets? To all appearance it must have been within historical times, as the river-beds are distinct and still bare, without any encroachment of vegetation. Probably the simplest way of accounting for the phenomenon would be, by showing that there has been a great diminution in the snow lying on the Alpes Maritimes, which are drained by these rivers. It is remarkable, too, that in many of the narrow valleys running up into the hills, now quite dry, there are evident traces of torrents and waterfalls apparently in recent times.

R. E. BARTLET

Nice, March 7

**The Ocelli in Insects**

AT vol. xiii, p. 168, H. Müller calls the attention of entomologists to a subject which has interested other entomologists before—the function of the ocelli in insects. With due deference to a suggestion made by such an authority, it seems to me that the size of the ocelli in hymenopterous insects is not dependent on their nocturnal habits. Why in hymenoptera more than in other orders? Indeed, it may be doubted whether in some insects the ocelli are organs of vision at all, or at least whether they are of any practical use as such in the imago. Their number, as well as size, differs in different species of the same order, seemingly without regard to their habits, whether diurnal or nocturnal, and in many moths they are so completely concealed by the scales that it is necessary to divide the head to ascertain whether they are present or absent, so that it is difficult to understand how they can be of any service as organs of vision. May they not in the imago, in such cases, be merely functional remnants of larval organisations.

C.

Colorado, Feb. 15

**The Recent Storm**

YOUR meteorological readers will probably guess that I have made an error of an inch inadvertently in the barometer readings of Sunday week. Also the last line should contain "nine hours" in place of seven.

T. S. USBORNE

Staplehurst, Kent, March 21

**OUR ASTRONOMICAL COLUMN**

STRUVE'S COMPANION OF PROCYON.—Mr. Otto Struve, in his remarks at the Royal Astronomical Society, in May, 1874, upon the later Pulkowa observations of the faint companion to Procyon, which he discovered on March 19, 1873, and which has been supposed to account for the anomalous motion of the latter, established by the researches of Prof. Auwers, referred to the circumstance of the small star not having been up to that time perceived with the 26-inch refractor of the Washington Observatory. Admiral Davis, the present superintendent of this establishment, has communicated to the *Astronomische Nachrichten*, the particulars of observations principally instituted for the purpose of confirming the existence of Struve's companion. The observations were commenced in November 1873, and have been continued

to the beginning of the present year. On no single occasion have Professors Newcomb and Holden, the usual observers, or any one who has examined the star with the 26-inch refractor, been able to detect a companion in the position assigned by the Pulkowa measures. Close faint stars have, however, been remarked in other positions, about three of which it is stated no doubt is entertained:—

1.	Position about 10°	Distance	6"
2.	"	36°	8"-8
3.	"	about 50°	less than 10"

And it is said to be quite possible there may be one or two more. No. 2 is the most readily visible.

Mr. O. Struve's measures gave the following mean results:—

1873, March 28	Position	90°.24	Distance	12".49
1874, April 10	"	99°.60	"	11".67

How then is the contradictory character of the Pulkowa and Washington observations to be accounted for? It can hardly be, as suggested by Mr. Struve, that "the surpassing brilliancy of the principal star may have hindered the recognition of the small companion in its neighbourhood," since notwithstanding it does not appear that a smaller aperture than 22 inches was employed during the Washington observations, three closer companions were considered to be certainly in existence. There remains the supposition of variability of light of the Pulkowa companion, if difference of atmospheric circumstances be ignored as inadequate to explain the want of success of other observers in detecting it.

Nothing more is heard of the Smythian orange-tinged eighth magnitude distant from Procyon in 1833, 145" on an angle of 85°. As is well known, the only observation confirmatory of the existence of this star is that by Mr. Isaac Fletcher, M.P., early in March, 1850, which gave for the position 84° 19'; most unfortunately the distance was not measured, because there is a star of similar brightness on very nearly the same angle but at a distance of about 330" measured by Capt. Jacob, Mr. Powell, and the late Lord Wrottesley. Anyone, however, who reads Mr. Fletcher's letter to Admiral Smyth, printed in "Sidereal Chromatics," p. 69, will see that there is little doubt the object observed in 1850 was the same that was measured, or rather estimated, as to position in 1833, the difference of distance not admitting of a mistake on the part of an experienced and careful astronomer. The more distant star was judged to be blue by Mr. Powell; the orange-tinge recorded in "the Cycle" is a characteristic of a large number of the known variable stars.

THE TOTAL SOLAR ECLIPSE OF 1883, May 6.—In this eclipse, in which the duration of totality where the sun is near the meridian will exceed five minutes, the course of the central line appears to be a most unfavourable one for observation, being almost entirely a sea-track. The elements are very approximately as follows:—

Conjunction in R.A., May 6, at 9h. 44m. 42s.	G. M. T.
R. A. ... ..	43° 30' 52"
Moon's hourly motion in R.A. ... ..	38 23
Sun's " " " " " " " " " " " "	2 25
Moon's declination " " " " " " " " " "	16 11 32 N.
Sun's " " " " " " " " " " " "	16 37 53 N.
Moon's hourly motion in decl. ... ..	7 26 N.
Sun's " " " " " " " " " " " "	0 42 N.
Moon's horizontal parallax " " " " " " " " " "	60 52
Sun's " " " " " " " " " " " "	0 9
Moon's true semi-diameter " " " " " " " " " "	16 35
Sun's " " " " " " " " " " " "	15 51

Hence the central and total eclipse begins upon the earth in longitude 156° 1' E. of Greenwich, and latitude 34° 43' S., and ends in longitude 86° 44' W., and latitude 13° 41' S.; the eclipse is central with the sun on the meridian in 147° 4' W., and 9° 11' S. The following are also points upon the central line:—

Long.	Lat.	Long.	Lat.
179° 51' E. ...	25° 43' S. ...	139° 51' W. ...	6° 53' S.
168 19 W. ...	19 52 S. ...	137 44 W. ...	6 24 S.
160 49 W. ...	15 49 S. ...	119 52 W. ...	5 51 S.
140 46 W. ...	7 8 S. ...	108 12 W. ...	7 51 S.

By a direct calculation for a point 140° 46' W., 7° 8' S. in the longitude of the Marquessas, totality is found to commence at oh. 39m. 30s. local mean time, duration 5m. 15s., the sun at an altitude of 64°.

**THE MINOR PLANETS.**—The four older minor planets, Ceres, Pallas, Juno, and Vesta, are now in pretty favourable positions for observation, and Vesta, which will be in opposition on the 28th inst., is very little below an average sixth magnitude in brightness, and may probably be detected without the telescope by those who are gifted with strong sight and are acquainted with the planet's position with respect to stars in the vicinity. On the 28th it will be a very little to the left of the line joining δ and ε Virginis, and nearly equi-distant from these stars, which are of the third magnitude.

Niobe, like Euphrosyne, is occasionally situate at a considerable declination. At the beginning of November next she nearly attains 53° N. in the constellation Camelopardus. An observer who may chance to meet with a small star which he has not before seen at a great distance from the equator, must not too hastily conclude that it belongs to the list of variables.

No. 160 was discovered by Prof. Peters at Clinton, U.S., on the morning of Feb. 21; it has been observed at Marseilles by M. Borrelly.

**ON THE ACTION OF LIGHT ON SELENIUM**

ON the 18th of last month Dr. C. William Siemens gave a lecture to the members of the Royal Institution on the above subject.

Commencing with a general reference to light as a natural force, he showed how little the potential action of light made itself evident to our senses, as with the disappearance of the light its effects seemed entirely to vanish; he then showed a temporary effect of light by its action on phosphorescent salts, which continue to glow for a long time after the source of light is removed, and drew attention to the permanent effect produced by the decomposition of the salts of silver in photography. He next referred to the radiometer, Mr. Crookes' little machine for illustrating light effects, which he brought forward for the purpose of showing the motive power of light, and closed his introduction by a reference to some experiments which he had made on a fungus that lives in the dark, and which, on analysis, gave no evidence of containing carbon, thus helping to favour the hypothesis that it is not heat, but the ray of light which breaks up carbonic acid in the leaves of plants in order to separate the carbon.

Selenium was discovered in 1817 by Berzelius, as a bye product from the distillation of iron pyrites. It is fusible, combustible, and similar to sulphur, phosphorus, and tellurium. If melted (at 217° C.) and cooled rapidly, it presents a brown amorphous mass of conchoidal fracture, and is a non-conductor of electricity; if heated only to 100° C., and retained for some time at this temperature, it becomes crystalline, and is a slight conductor of electricity, the conductivity increasing with battery power, and varying according to the direction of the current, as lately observed by Prof. Adams.

It was on the 12th of February, 1873, that the Society of Telegraph Engineers received a communication from Mr. Willoughby Smith, one of its members, of an observation made first by Mr. May, a telegraph clerk at Valentia, viz. that a stick of crystalline selenium offered considerably less resistance to a battery current when exposed to the light than when kept in the dark; this was corroborated by the Earl of Rosse, who clearly proved the action to

be due solely to light, and who also showed the effects of the light of different portions of the spectrum, and afterwards by Lieut. Sale, and conjointly by Messrs. H. N. Draper, F.C.S., and R. J. Moss, F.C.S.

About twelve months ago the matter was again taken up by two independent observers, Prof. Adams in this country, and Dr. Werner Siemens in Germany, and it was to the results obtained by the latter, and which have been communicated to the Academy of Sciences of Berlin, that the lecturer's remarks were chiefly confined.

The sensitive selenium plates made by Dr. Werner Siemens, with which experiments were made, are formed of two spirals of platinum wire, laid upon a plate of mica, in such a manner that the two wires run parallel without touching; upon the plate a drop of molten selenium is allowed to fall, and before solidifying, another plate of mica is pressed down; the two protruding ends of wire serve to insert the selenium element in a galvanic circuit. Amorphous selenium when thus tested produces no deflection of the galvanometer, either in light or darkness. If, however, a selenium disc which has been kept for some time at 100° C. and then cooled is inserted, a slight deflection of the galvanometer takes place when it is under the influence of light, but none in darkness. If now a selenium disc which has been kept for several hours at a temperature of 210° C., a point below that of the fusion of selenium, and which has been gradually cooled, is substituted for the other, a considerable deflection under the influence of light will be observed, whilst a hardly perceptible deflection takes place in the dark.

It was also explained, as the result of an experiment, that amorphous selenium did not conduct up to 80° C.; from this temperature to 210° C, its conductivity gradually increased, after which the conductivity again diminished; in cooling it followed the same law, but in a different ratio. The modification prepared by heating to 100° C. only is Dr. Werner Siemens' 1st, or electrolyte modification, whilst the other, prepared by heating to 210° C., is his 2nd, or metallic modification. In the 1st, the conductivity increases with rise of temperature; in the 2nd it decreases; the 2nd is a much better conductor, but is less stable, and its conductivity increases with the intensity of the light, as shown from the following table, in which is given the effects of different intensities of light on selenium (Modification II.) obtained by Dr. Obach in Mr. Siemens' laboratory at Woolwich on the 14th February, 1876:—

Selenium in	Relative conductivities.		Resistance in Ohms.
	Deflections.	Ratio.	
1. Dark ... ..	32	1'	10,070,000
2. Diffused daylight ...	110	3'4	2,930,000
3. Lamplight... ..	180	5'6	1,790,000
4. Sunlight ... ..	470	14'7	680,000

From these experimental results an extension of Helmholtz's theory is derived, viz., that the conductivity of metals varies inversely as their total heat (Helmholtz having only the sensible heat in view), and the influence of light upon selenium is explained by a change in its molecular condition near the surface, from the first or electrolyte into the second or metallic modification, or, in other words, by a liberation of specific heat upon the illuminated surface of the crystalline selenium.

In testing the sensitive selenium plate in the different parts of the spectrum, it was shown that the actinic ray exercised no sensible effect, that the effect increases as we gradually approach the dark red, and that beyond that point the effect again decreases, reaching almost zero in the heat rays; the value of the material then for purposes of photometry is apparent.

Dr. Werner Siemens has constructed a selenium photometer, in which the selenium is prepared so as not to be affected by the changes to which that substance is liable, and which consists of a single sensitive plate mounted upon a vertical axis, upon which it can be turned through a certain angular distance limited by stops. When touching the one stop the selenium stands opposite the normal candle, and when touching the other opposite the light to be measured, the distance upon the former being changed upon a scale until no effect upon the needle of a galvanometer is produced in turning the sensitive plate in rapid succession from the one stop to the other.

The lecture was concluded by the exhibition of a selenium eye, which Mr. Siemens had prepared to illustrate the extraordinary sensitiveness of the selenium preparations. It consists of a hollow ball with two circular openings opposite each other, the one being furnished with a lens  $1\frac{1}{2}$  inches in diameter, and the other with an adjustable stopper carrying a sensitive plate, which is connected by wires to a galvanometer and one Daniell's cell. The lens is covered by two slides representing eyelids, the ball itself being the body of the eye, and the sensitive plate occupying the place of the retina. Having placed a white illuminated screen in front of the artificial eye, on opening the eyelids a strong deflection of the galvanometer was observed, a black screen giving hardly any deflection, a blue one a greater, a red a much greater, but still short of that produced by the reflected white light. The eye was thus sensitive to light and colour, and as stated, it would not be difficult to arrange a contact and electro-magnet in connection with the galvanometer, so that intense light would cause the automatic closing of the eyelids. The artificial eye is subject to fatigue, and the lecturer considered that this experiment might be suggestive to physiologists as regards the natural conjoint action of the retina and the brain.

#### THE LATE COLONEL STRANGE, F.R.S.

LIEUT.-COL. ALEXANDER STRANGE, F.R.S., whose death we last week announced, was the fourth son of the late Sir Thomas Strange, and was born at Westminster on the 27th of April, 1818, and was educated at Harrow. On leaving school in 1834, at the early age of sixteen, he proceeded to India, and joined the 7th Regiment of Madras Light Cavalry, where his natural talents began to develop themselves. He shortly afterwards made the friendship of General Worster, who soon discovered that he had mechanical abilities of the highest order, and who subsequently instructed him in the use of astronomical and surveying instruments, and pointed out to him that nature had intended him for a scientific career. During the next few years he became a devoted student at the Magnetic and Meteorological Observatory at Simla, then under the direction of Major-General Boileau, R.E., at whose recommendation he was nominated, in 1847, by Col. (now Sir Andrew) Waugh, R.E., Surveyor-General of India, to the office of Second Assistant in the Great Trigonometrical Survey, where he found work suited to his talents. He was originally selected on account of his ability as an observer, and for his extraordinary mechanical skill, which in this department was of special value, and was displayed in such a remarkable degree as to call forth the highest commendation from Col. Waugh. In the season 1848-49 he was attached to the party under Capt. (now Col.) Renny Tailyour, R.E., in order that he might acquire a practical knowledge of geodetical operations. Such was the rapidity with which he made himself master of this difficult subject, that in 1850 he was promoted to the grade of First Assistant. Capt. Tailyour was ordered to undertake the triangulation of what is known as the "Karachi Longitudinal Series," which constitutes the southern flank of that considerable portion of the principal tri-

angulation of the Survey of India known as the North-west Quadrilateral. It commences at Sironj in Central India, and terminates at Karachi, in Sind. The extent of this arc of longitude is equivalent to 670 miles in length, covers an area of 23,000 square miles, and is one of the largest longitudinal arcs ever measured on the surface of the globe. At the end of the first season, Capt. Tailyour's services being required at head-quarters, Capt. Strange was ordered to take over the entire charge of the Series, and it is on this great undertaking that his fame as an Indian Surveyor rests. After crossing the Desert, over which the triangulation had to be carried nearly 200 miles, the work was carried on with the highest skill across the Plains of Sind, until at length, after much anxiety, and having overcome almost insuperable difficulties, the last angle which completed this great triangulation was measured on April 22, 1853, and the work brought to a successful close.

The remarkable energy and rapidity with which this series was carried on, under many and great difficulties, was reported by the Surveyor-General to reflect on him the highest credit. He was directed to join the Surveyor-General's camp near Attock, where he took part in the verificatory base line. After this he returned to Karachi with the base-line apparatus, and took a leading share in the measurement of the base-line at that place in the year following. Meantime he had been distinguished with the title of "Astronomical Assistant." In 1855 Strange joined the Surveyor-General's Head Quarters' Office, and in the following year was placed in charge of the triangulation which was being extended from Calcutta southwards towards Madras, along the eastern coast. In April, 1857, whilst conducting the triangulation in the Goomsoor Hills, a notoriously unhealthy tract, he was struck down by jungle fever, and was afterwards ordered to the Neilgherry Hills for the recovery of his health. In the year 1859 he was promoted to the rank of major, and in accordance with the then existing regulations of the service retired from the Survey, on which occasion he received the special thanks of the Government of India.

In January, 1861, he returned to England after twenty-six years' continuous service in India, and finally retired from the army as lieutenant-colonel on the 31st of December, 1861. His career in England was no less brilliant than that in India. In 1861 he was elected a Fellow of the Royal Geographical Society as well as a Fellow of the Royal Astronomical Society. He served on the Council of the latter from 1863 to 1867, and was Foreign Secretary from 1868 to 1873. On the 2nd of June, 1864, he was elected a Fellow of the Royal Society, of which he soon became a distinguished member; he served on the Council from 1867 to 1869.

In the year 1862 the Secretary of State for India in Council sanctioned the provision of an extensive equipment of geodetical and astronomical instruments of the first order, for the service of the Great Trigonometrical Survey of India, consisting of one great theodolite, two zenith sectors, two 5-foot transit instruments, two electro chronographs, two diagonal transit instruments, two 12-inch vertical circles, and three astronomical clocks. The task of designing and superintending their construction was entrusted to Lieut.-Col. Strange, who was also appointed to the post of Inspector of Scientific Instruments to the Indian Government. To enable him to test these valuable instruments as well as the current supply required by the Public Works, Survey, Meteorological, and various other Departments in India, an Observatory was established at the India Store Depot in Lambeth from designs prepared by himself. This observatory, in its various ingenious details, is a monument of Col. Strange's consummate mechanical genius.

At this Observatory, theodolites, levelling instruments, prismatic compasses, sextants, telescopes, barometers,



thermometers, drawing, and mathematical instruments of all kinds were rigorously inspected, compared, and verified under Col. Strange's personal superintendence, and the improved forms of instruments now supplied to the services in India, are in a very large measure due to his efforts, and it must have been a source of gratification to him to find that they were received with almost universal approbation. He devoted much anxious time and thought to the laborious task of testing the magnificent series of instruments above alluded to.

The telescope has an aperture of  $3\frac{1}{2}$  inches, with a focal length of 36 inches. The instrument is constructed upon what is known as "the flying micrometer plan," and possesses a great number of peculiarities which are quite unique. It will be found fully described in a paper read by him before the Royal Society in 1872. This is undoubtedly the finest instrument of its kind ever constructed, and will be an enduring monument to his unremitting energy and constructive genius. The zenith sectors were designed for the accurate determination of latitude, and in design are unlike any of their predecessors; being intended for portable instruments the problem was to get the maximum of power out of the minimum of weight, and in this he was eminently successful, for on comparing one of these with the weight of the zenith sector designed by the present Astronomer Royal for the Ordnance Survey of Great Britain it was found to be only about one-half. With regard to the performance of these instruments, Capt. J. Herschel, R.E., F.R.S., who has been employed in determining latitudes in Southern India, in comparing the facility of working the zenith sector and the former astronomical circles of the Great Trigonometrical Survey, states that "the sectors are competent to turn out at least double the amount of work of the same order," adding, "at this rate two or three years' work, would equal in amount the whole results up to the date of the arrival of the sectors, and ten years (a comparatively short period for which to arrange a system of observation on a matter of this magnitude) will see us in a position to look back on the arrival of the sectors as on the commencement of a new era." All the other instruments present evidences of Col. Strange's constructive genius.

Such is the amount of skill and forethought brought to bear upon the design of these exquisite instruments that an observer may select a series of stars differing only five minutes of time in Right Ascension. Each star is observed twice in reversed positions of the telescope at the same culmination, and each of the two reversed observations involves two settings of the telescope in altitude, four microscope, two level and one micrometer reading. To admit of all these operations being performed within five minutes of time, with the deliberation requisite for observations aiming at fractions of a second, demands the highest conveniences of instrumental construction.

After their completion and final testing, they were severally despatched to India, where they have for some years been employed in the Survey Department, unapproachable for manipulative facilities and giving results unsurpassed in accuracy. Indeed, it is not too much to say that these instruments, in the construction of which Col. Strange had the advantage of being so ably seconded by the late Mr. Cooke, of York, and the well-known firm of Troughton and Simms, are the most perfect and powerful geodetical instruments which have ever been constructed or are likely to be constructed for some years to come.

Among his publications which appear in the Memoirs of the Royal Astronomical Society, vol. xxxi., are the following: "On Testing the Vertical Axes of Altazimuth Instruments," "On a Direct Method of Testing and Adjusting the Equipoise of Altazimuth Instruments," "On a Proposed Isolated Flange for Conical Axes." In the Monthly Notices of the Royal Astronomical Society, vol. xxiii.: "On Aluminium Bronze as a

Material for the Construction of Astronomical and other Philosophical Instruments;" and in the Journal of the Royal United Service Institution, vol. vi., "Geodesy, especially relating to the Great Trigonometrical Survey of India." He contributed papers on various subjects to the Royal Society, the British Association, the Society of Arts, the Meteorological and other scientific and learned societies.

His scientific activity, however, was by no means confined to these questions, which came before him in his official capacity. In compliance with a request made by her Majesty's Commissioners for the International Exhibition of 1862, Col. Strange served the office of juror. He also performed the same functions at Paris in 1867. "While in the Royal Society," to quote from the memoir in the *Times*, "he insisted upon the accuracy of the measurements used in physical inquiries, in the British Association, and was the clear-sighted and constant advocate of increased instruction in science and the increased utilisation of it in our public departments; and he was among the first to insist upon the national importance of fostering the pursuit of knowledge in those fields which, though unremunerative to the cultivator, are eventually of the highest importance to the nation. To him belongs the whole credit of having initiated in 1868 the movement which resulted in the appointment by her Majesty of the 'Royal Commission on Scientific Instruction and the Advancement of Science,' of which his Grace the Duke of Devonshire was chairman, and the five years' labours of which have but recently terminated. Before he died he had the satisfaction of knowing that the proposals contained in the scheme which he originally propounded to the Commission, and on which nearly the whole of the witnesses were examined, were adopted in the main by the Commission, and recommended for the consideration of the Government. Thus the breadth of his views, and the clear-sightedness which he possessed not only combined to render his services to the Indian Government and to the various scientific societies, Councils, and Committees on which he served of the utmost value, but they have left a memorial in the recommendations of this Commission, some day, we hope, to be rendered more lasting by their adoption. He died on the 9th inst. at the comparatively early age of fifty-seven, and the void his death has created in the scientific world will be one very difficult to fill."

PROF. FLOWER'S HUNTERIAN LECTURES  
ON THE RELATION OF EXTINCT TO EXISTING MAMMALIA

V.

ORDER *Sirenia*. The purely aquatic habits and fish-like form of the animals of this order formerly caused them to be confounded with the Cetacea, but a more intimate knowledge of their structure has shown that they really belong to a widely different type of the class. Their skeleton is remarkable for the massiveness and density of most of the bones of which it is composed, especially the skull and ribs, and the bodies of their vertebræ want the disc-like epiphyses so well marked in the Cetacea. The existing members of the order pass their whole life in the water, being denizens of shallow bays, estuaries, and large rivers, but unlike the Cetacea they are never found in the high seas away from shore. Their food consists entirely of aquatic plants, either marine algae or fresh-water grasses, on which they browse under water, as the terrestrial Ungulates do on the green pastures on land. They are generally gregarious, slow and inoffensive, and apparently stupid in disposition. Though occasionally found stranded

<sup>1</sup> Abstract of a course of lectures delivered at the Royal College of Surgeons "On the Relation of Extinct to Existing Mammalia, with Special Reference to the Derivative Hypothesis," in conclusion of the course of 1873. (See Reports in NATURE for that year.) Continued from p. 388.

by the tide or waves, there is no evidence of their voluntarily leaving the water to bask or feed on the shore.

The species now existing are very few, and there is reason to believe that the time is not far distant when they will all become extinct. One species, the *Rytina stelleri*, or Northern Sea-cow, an animal attaining nearly the length of thirty feet, by far the largest known member of the order, from the North Pacific, was totally exterminated by the agency of man during the last century, and the surviving species, the Manatis and Dugongs, being valuable for their flesh as food, their hides, and especially for the oil obtained from the thick layer of fat which lies immediately beneath their skin, rapidly diminish in numbers as civilised populations occupy the regions which form their natural habitat.

The Manatis (genus *Manatus*), found on the Atlantic coasts of America and Africa, are rather fluviatile than marine in their habitat, ascending large rivers almost to their sources, and feeding chiefly on aquatic grasses. The Dugongs (genus *Halicore*) are more distinctly marine, feeding chiefly on algae. They inhabit the shallow waters, bays and creeks of various coasts of the Indian Ocean, the Red Sea, East Coast of Africa, the Indo-Malayan Archipelago, and north coast of Australia. There is probably not more than one species, but they have been divided into three according to the locality which they inhabit. *H. tabernaculi* from the Red Sea, *H. dugong* from the Indian Seas, and *H. australis* from Australia. These two existing genera present such well-marked distinguishing characters that if they alone were known they might be placed in separate families, but as in so many similar cases our knowledge of the extinct forms, imperfect as it is, goes far to bridge over the distinction between them. It is true that Brandt, a great authority on this group, divides the order into two primary sections—*Manatida*, consisting of *Manatus* alone, and *Halicorida*, containing all the other genera; but it scarcely seems that these can be considered in any sense as equivalent, especially as one of the distinguishing characters, the external form of the tail is unknown in the extinct genera.

The Miocene and early Pliocene seas of Europe abounded in Sirenians, to which the generic name *Halitherium*, Kaup, has been given. They had large tusk-like incisors in the upper jaw, as in the existing *Halicore*, though not so greatly developed. Their molar teeth are  $\frac{5}{5}$  or  $\frac{6}{6}$ , anteriorly simple and single-rooted, posteriorly with three roots in the upper jaw, and two below, and with enamelled, tuberculated, or ridged crowns, in which respect they approach nearer to *Manatus*, the molar teeth of the Dugongs being without enamel and single-rooted. The anterior molars were deciduous. Some species, at least had nasal bones, short, broad, but normal in position, whereas in all the existing genera these bones are quite rudimentary. Another and still more important evidence of conformity to the general mammalian type is the better development of the pelvic bone, and the presence of a small styliform femur articulated to the acetabulum, although no traces of any other part of the limb have been discovered. These ancient Sirenians were thus, in dental, cranial, and other osteological characters, less specialised than are either of the existing species, and if the intermediate links could be discovered, might well be looked upon as ancestral forms from which the latter have been derived, but at present the transitional conditions have not been detected. As far as we know, when changes in the physical conditions in the European seas rendered them unfitted to be the habitation of Sirenians, the *Halitherium* type still prevailed. If the existing Dugongs and Manatis are descended from them, their evolution must have taken place during the Pliocene and Pleistocene epochs, the one in seas to the east, the other to the west of the African continent, which has formed a barrier to their intercommunication. *Halitherium* remains have been found in many

parts of Germany, especially near Darmstadt, in France, Italy, Belgium, Malta, the Isthmus of Suez, &c. Until lately none were known in our own country, probably owing to the absence of the beds of an age corresponding to those in which they are found on the Continent; but quite recently a skull and several teeth have been detected among the rolled *débris* of Miocene formations, out of which the Red Crag of Suffolk is partially composed. The species are not yet satisfactorily characterised. Some of them appear to have attained a larger size than the existing Manati or Dugong. One of these from the Pliocene of Italy and France, having but  $\frac{5}{5}$  molar teeth, has been

separated generically under the name of *Felsinotherium* by Capellini, by whom it has been fully described. A portion of a skull found in Belgium has been named *Crassitherium*, by Van Beneden, and some compressed teeth, somewhat similar to, but larger than those of the Dugong, discovered in the department of Lot et Garonne, France, have given origin to the genus *Rytiodus* of E. Lartet. *Pachycanthus* of Brandt, from the Vienna basin, is also, according to Van Beneden, another form of Sirenian, of which, however, the skull is not known. In various Miocene and perhaps Eocene marine formations of the United States of America, remains of Sirenians have been discovered, but mostly in such a fragmentary condition that they afford at present little evidence of the early history of the group in that country. A more satisfactory discovery is that of a nearly complete skull and some bones from a limestone tertiary formation in Jamaica. It is of smaller size than the Manati, and as far as the teeth are concerned, of a still more generalised character than *Halitherium*, the dentition being apparently

$$i \frac{3}{3} c \frac{1}{1} p \frac{5}{5} m \frac{3}{3} = 48.$$

The incisors are small, not developed into tusks, the canines (wanting in all existing Sirenians) are rather longer than the incisors, judging by the sockets, and the molars are bilophodont, and covered with enamel. It has been described by Prof. Owen under the name of *Prorastomus sirenoides*. Unfortunately we have no knowledge of the geological antiquity of the formation in which it was embedded. Lastly must be mentioned the *Eotherium egyptiacum*, Owen, founded on the cast of a brain, with a small quantity of surrounding bone, discovered in the Nummulitic limestone of Eocene age of the Mokattam Hills, near Cairo. The brain is narrower than that of *Manatus*, and resembles *Halitherium*. This is of interest, as the most ancient known evidence of any Sirenian, whose age has been geologically determined.

The few facts we have as yet been able to collect of the former history of the Sirenians leave us as much in the dark as to the origin and affinities of this peculiar group of animals as we were when we only knew the living members. They lend no countenance to their association with Cetacea, and, on the other hand, their supposed affinity with the Ungulata, so much favoured by modern zoologists, receives no very material support. The assumption lately put forth with so much confidence that the Sirenians are the remains of a group of animals, through which the Cetacea passed in their evolution from terrestrial Mammalia, is quite without foundation.

(To be continued.)

#### PROF. HUXLEY'S LECTURES ON THE EVIDENCE AS TO THE ORIGIN OF EXISTING VERTEBRATE ANIMALS<sup>1</sup>

##### II.

IT was seen in the last lecture that no ultimate answer was obtainable as to the origin of the examples selected from the fish class, any more than is afforded as

<sup>1</sup> A course of six lectures to working men, delivered in the theatre of the Royal School of Mines. Lecture II., March 6. Continued from p. 389.

to the origin of the Anglo-Saxons by showing that they came from Friesland in the sixth or seventh century. The same remark applies to the origin of nearly all fishes, in fact, only one clear case of progressive modification is known in the whole class; this is afforded by the group of the *Pycnodonta*.

These are fish not unlike our John Dory in shape, which appear for the first time in the carboniferous rocks, and become extinct in the older tertiaries; they are distinguished by the possession of rows of large crushing teeth, and in place of a vertebral column had a gelatinous *chorda dorsalis* or *notochord*. The spinal cord above this was embraced by arches of bone, placed at regular intervals along the chorda; and, immediately below these neural arches, were attached the ribs, also bony. In the Carboniferous forms, both arches and ribs are quite distinct from one another, and are simply united by ligamentous fibres to the notochord; but, in the older Secondary species, they become expanded at their ends, and thus tend to embrace the notochord; and, lastly, in the Tertiary pycnodonts this process is carried to such an extent as almost to produce a ring of bone, like the body of a rudimentary vertebra.

Now let us turn to the next group of Vertebrate animals, that of Amphibia (frogs, toads, newts, and salamanders), which are distinguished from fishes by certain very striking peculiarities. Fishes are all capable of breathing the air dissolved in water by means of gills, and—a far more important distinctive character—their limbs always have the character of *fins*, which organs are seen in their simplest form in *Ceratodus*. In this fish, there is a long jointed cartilaginous axis, running down the middle of the fin, with rows of rays of the same substance on each side of it; the whole is invested by a fold of the integument, the margins of which are beset with horny filaments called fin-rays. In all fishes these elements are to be found, generally in a curiously modified condition; in the bony fishes, for instance, the central axis with its side appendages are broadened out and shortened, the fin-rays becoming at the same time so much larger as to form the main part of the fin.

Some modification of this type of limb is possessed by all fishes which have limbs at all; but the first character, that afforded by the respiratory organs, is not absolute, for there are some fishes which, besides gills, possess an apparatus for breathing air directly. This apparatus, represented by the air-bladder of ordinary fishes, first takes on its new character and becomes a lung in that remarkable genus, *Ceratodus*, in which it exists as a large cellular structure situated in the upper part of the abdominal cavity, just under the vertebral column, and connected with the gullet by a slit—the glottis—by means of which the fish can pass air from the mouth into the lung. It is not, however, this peculiarity of opening into the oesophagus which constitutes a lung, for the air-bladder of many fishes possesses an open duct of a similar nature; the great distinguishing feature is, that the blood taken to this bladder does not pass into the ordinary venous channels, but is returned immediately to the heart, in a purified condition, by a special vein. In *Ceratodus* there is no special vessel to carry blood to the lung, in other words, although there is a pulmonary vein, the pulmonary artery has not appeared; but in the Mudfish (*Lepidosiren*) of Africa and eastern South America, the development of the lung goes a step further, a special pulmonary artery being present, as in all the higher animals. Thus *Ceratodus* and *Lepidosiren* are truly *amphibious*, for they can be suffocated neither by removal from water like most fish, nor by immersion in water like the higher animals.

What constitutes the difference between these amphibious fish, and the lowest of the true Amphibia? Not the nature of the respiratory process, for many of the latter group, such as the blind *Proteus* of the Austrian

caves and the North American *Menobranchus* possess gills throughout life, but the structure of the limbs, which are now, no longer *fins*, but *legs*. A fish requires a broad surface for balancing itself in the water, locomotion being chiefly performed by the tail, but in land animals an apparatus is required capable of raising the body above the ground, and the limbs take on the form of a set of jointed levers. In its simplest form the higher vertebrate limb consists, first, of a single piece of cartilage articulated with the body, then two pieces side by side, then a number of small nodules, and lastly, five series of short jointed pieces; all of these become in the adult state more or less converted into bone. The first or proximal division of the limb is called the humerus in the fore limb, the femur in the hind limb; the next segment consists of radius and ulna in the arm, tibia and fibula in the leg; the nodular pieces are respectively carpals and tarsals, and the series of jointed bones or cartilages, the five digits. From the lowest Amphibia upwards, the limbs, when present, are always constructed upon this type.

Nevertheless, the Amphibia still retain certain fish-like characters, which are lost in the groups above them. They all, at some period of life, breathe by means of gills, although all have, in the adult state, lungs in addition. Some forms, such as the *Proteus* and *Menobranchus* mentioned above, retain their gills throughout life and are hence called *Perennibranchiates*; others, such as *Menopoma*, *Amphiuma*, &c., lose them in adult life, and are called *Caducibranchiates*. These two last genera, however, still retain traces of gill-clefts, but in all the Amphibia with which we are acquainted in this country, the frog, toad, and newt, even the clefts disappear, and the perfect air-breathing character is assumed.

These animals, in the course of their development, go through a very singular series of metamorphoses, comparable to those by which a grub is converted into a butterfly. At this season of the year, every pond is almost certain to contain frog-spawn, masses of transparent albuminous matter, with numberless imbedded eggs, consisting of yolk, black on one side and white on the other. A few hours after these eggs are laid, the process of development begins by the formation of a shallow groove, which appears quickly on the black, more slowly on the white hemisphere, and is just such a groove as would be produced by drawing a blunt instrument along the equator of a soft globe. The egg is thus divided into two masses. A second form appears at right angles to the first, dividing the whole egg into four; others appear, in definite order, cutting it up into smaller and smaller masses, until the whole yolk becomes granular, or formed of microscopic *cells*. Two ridges then appear, on the surface of the egg, and, uniting in the middle line, inclose a cavity, the lining membrane of which is converted into the brain and spinal cord. The head gradually becomes differentiated, and the mouth appears on its under side; the tail grows out, and the little creature, getting too long for the egg, becomes coiled upon itself, and, before long, ruptures the egg-membrane, and makes its exit from its mass of jelly.

It is now, to all intents and purposes, a fish; it has no limbs, its mouth is provided with horny jaws, and it breathes by means of a pair of plumose gills. It further differs from the adult frog in being herbivorous, feeding on water plants, to which it attaches itself by means of two suckers near the mouth. The tadpole grows rapidly, and, before long, a fold of skin appears on each side, which gradually closes over the gills, leaving, however, for a considerable time, a small opening on the left side. In the meantime the limbs appear, and the lungs are developed, the tadpole breathing for a time both by lungs and gills; the latter eventually disappear, the tail shortens, the limbs lengthen, the horny jaws are replaced by teeth, and an insect-eating tail-less frog is formed, the adult air-breathing form having thus been attained by a wonderful

series of changes, in which the fish, *Lepidosiren*, perenni-branchiate, and triton, are all represented.

One would be inclined to infer from these metamorphoses, that, on tracing the Amphibia back in time, the story of their origin should be told, but, as a matter of fact, palæontological history tells a different story altogether. Abundant remains of frogs and toads are found in the Miocene deposits, some of which are of so fine a character that even the tadpoles are preserved; but these tertiary frogs and toads do not differ, in any important particulars, from those of the present day, and the same is true of the tritons and salamanders. Some of the latter attained a very great size, and one of them—a near ally of the great Japanese salamander of the present day—has had a very singular fate, having been described, about the middle of the last century, as a fossil man, by the German naturalist Scheuchzer, who named it "*Homo diluvii testis*," the man who saw the flood!

In the Wealden and Purbeck formations no Amphibia have as yet been discovered, but, from the Lower Lias to the Carboniferous they turn up again in remarkable numbers, and of great size, but differing from existing forms in some important peculiarities, and affording no help whatever to our inquiries as to the origin of the existing or of the tertiary frogs, toads, and salamanders. Under the throat, these gigantic Amphibia had a remarkable shield of three bony plates, as well as a series of plates along the belly. Their teeth were large and powerful, and presented an extremely complicated structure, whence the group has received its name of *Labyrinthodonta*.

Thus, in tracing back the existing Amphibia, we find a great break in the secondary period, and then come upon a distinct group, the *Labyrinthodonta*, from which the existing forms cannot possibly be deduced. These, again, have been traced no farther back than the carboniferous epoch.

(To be continued.)

### PHYSICAL SCIENCE IN SCHOOLS

THE beginning of a discussion on any great subject elicits mainly differences of opinion; its end should be to establish agreement as to principles, and in great measure as to details. The first half of this dictum has been illustrated by the interesting letters in your columns on Physical Science in Schools; its entire confirmation as the correspondence proceeds will confer on education a benefit of the most timely kind.

The moment is a critical one for scientific teaching. Lord Salisbury's Bill will come to mean a revolution in the educational structure of the Universities; the Report of the Science Commission proposes to re-cast the teaching of the schools; public feeling, unexpressed as yet on other points, is distinct in wishing to see Science heartily recognised and systematically taught. If Science Teachers will agree as to what they want and press it vigorously, the game is in their hands.

I venture to lay down for consideration in NATURE certain propositions on this subject in the hope that they, or such others as may be preferred to them, may become the basis of the agreement we all desiderate:—

1. The business of a school is general education; the business of a University is special education.
2. The principal subjects taught at a school should be Literature, Mathematics, Science.
3. Each of these subjects should be studied in fixed relative proportions of time, from the very beginning of a school course until its close.
4. Scholarships offered for any one of these subjects to the exclusion of the others at the entrance on University life are mischievous in their effect on school teaching, and ought to change their character or be abolished.
5. Science should be taught to every boy in a school

for at least six hours in the week; holding a fair place in Entrance Examinations, being encumbered with no pecuniary charges unimposed on other subjects, and having a value in school-marks proportional to the time spent upon it.

Of these five theses, the first three and the fifth are in exact harmony with the recommendations of the Science Commission; the fourth follows necessarily from the others, as stigmatising a system whose continuance makes general school teaching impossible, and whose significance gains point from the curious admission of one of your correspondents as to the intellectual cost of a Balliol Scholarship.

The feasibility of teaching science to the youngest schoolboys, assumed in what I have said, demands a word of comment. The evidence on this point scattered through the Report of the Commission, and partly summarised in Report VI., pp. 6—9, is, if not overwhelming, so strong as to outweigh many-fold anything that has yet been said against it. I desire to advance with humility, but with great earnestness, my own experience, extending over fourteen years, in support of the view there laid down; and Mr. West's admirable letter in NATURE, vol. xiii., p. 48, represents, as I well know, the conclusions of many successful teachers. If grammatical analysis and arithmetical numeration are taught every day to boys of nine years old, why not the elements of science? It were well surely to inquire what parts of this vast subject and what treatment of them have been found suitable to younger minds; for the statement on the part of any individual that science cannot be taught to little boys means nothing more than that he himself has failed to teach it.

My object in writing is a practical one. I have stated the principles which seem to me to underlie all school science teaching worthy of the name, and I invoke a judgment upon them, possibly a reversal of them, at the hands of experienced teachers. If it be true, as we were lately told, that the head-masters are awaiting instruction from the public, let us prepare the public to educate their illustrious pupils. At any rate, let scientific men be ready to answer the appeal which will be made to them when the Report of the Science Commission comes before the House of Commons, with such unanimity as only abundant and unprejudiced discussion can generate. To let slip this opportunity will be to find, I fear, with the Jew of Malta, that "Occasion's bald behind."

W. TUCKWELL

I notice in your columns that a discussion has been conducted for some time past on that important subject, Physical Science in School Teaching. Permit me, as one possessing a deep practical interest in this matter, and also as a science teacher of some years' experience, to remark that in Scotland, generally, and in this great educational centre in particular, the chief obstacle which stands in the way of extended science teaching, is the simple apathy of educationalists to the claims of scientific instruction. It were well that, before disagreeing as to the exact mode of teaching, the claims of one science over another, and other points, science teachers should thoroughly agree as to the necessity for more openly enforcing their claims upon the notice of those who sit in high places in the world of educational management. I gladly welcomed an opportunity afforded me by the Edinburgh branch of the "Educational Institute of Scotland," in December last, to address the members of the Institute, consisting in the main of teachers of all subjects, on the "Place, Method, and Advantages of Biological Instruction in Ordinary Education." The substance of that address will shortly appear in *Fraser's Magazine*, and to that medium I would respectfully refer those of your readers who are interested in this question, for a *résumé* of a science teacher's work and method in the northern metropolis. I would fain hope that the argu-

ents therein stated, as applying to the extension of my special subject—Biology—may be found to suit the case. Claims of science teaching at large. And it may not be inappropriate to conclude by re-echoing the remark with which I started, namely, that if we can succeed in creating a demand for science teaching, by showing the true claims and true value of scientific instruction in an ordinary educational curriculum, we shall have paved the way for a harmonious and natural after-adjustment of such questions as have very ably been ventilated in NATURE during the past few weeks.

Edinburgh Medical School

ANDREW WILSON

I have read with considerable interest what may be gleaned from the evidence of your correspondents as to the state of scientific instruction in schools, and I think possibly if our space will permit me, that I shall be able to confirm some of the statements of previous writers. I have reason to believe that in some large schools where science is demanded as a branch of education it is practically suppressed, some of the clever lads are removed from the science classes in order to be "crammed" in classics, sometimes against their own desires, for the purpose, if possible, of making a show in school-lists as having obtained scholarships at Oxford. I am acquainted with facts which cannot be otherwise explained. Sometimes I have learned these from the boys themselves, sometimes from science-masters in different establishments. At one large school in connection with a College there are about 600 boys; formerly very nearly 100 attended chemistry lectures once a week, and about 25 attended the chemical laboratory of the College for 1½ hour. The subject was a voluntary one, and the undoubted interest shown by the scholars was very striking; one could see that they were being taught to think, it was something so entirely different from their ordinary school work. For the last year or two the number of boys attending these science classes has been limited almost entirely to those who intend matriculating at the London University, those whose parents expressly wish their sons to receive such education, or others "the most stupid and ignorant," who are so unlikely to hold their own in any other competition that it is considered they may be better fit for distinction in science. I need hardly say that one fails to make anything of the latter class, although, on the other hand, I have seen such lads display unusual mechanical skill. The number of boys from the school now attending the laboratory is only eight, and those who hear lectures about thirty-six. In a school with unusual facilities for scientific instruction at a small cost, since the teachers, the laboratories, the lecture-rooms, and the very costly scientific apparatus, all belong to the College, there is this small result simply because the pupils are prohibited attending the lectures on science lest, as it is said, "they should shirk their other work." This is certainly not equalising the various branches of human knowledge. In some schools the science masters are appointed not from among those who have made the teaching of science a study, but from that peculiar body who are willing to combine instruction in science (which includes, of course, Physics, Chemistry, Natural History, and Botany), with Mathematics, Classics, and Foreign Languages, and whose views as to the suitable remuneration for their services suggests a limited expenditure of thought, time, and money, on their own acquirements. From the present low estimation in which scientific knowledge is held, I should be exceedingly sorry to see the number of efficient science teachers increased. The capital expended on a classical education gives a far better, a more certain, and a quicker return than that invested in science. Hence the lamentations about the state of science in this country. Until the Head Masters and College dons have been so liberally educated as to understand that besides Classics and Mathematics there are other branches of knowledge which ennoble and enrich

the understanding, and further, until a legal status has been secured for professional scientific men, such things must continue.

W. N. HARTLEY

## NOTES

THE John Hopkins University, some account of the organisation of which we recently published, was formally instituted at Baltimore, U.S., on February 22. Prof. Gilman in his address hinted that elementary instruction in all branches of science is not contemplated at the new University. There will be no stated curriculum of four years. Great freedom is to be allowed both to teachers and to scholars; the former must be "free and competent to make original researches in the library and the laboratory;" the latter will be encouraged to "make special attainments on the foundation of a broad and liberal culture," and to make them through a "combination of lectures, recitations, laboratory practice, field work, and private instruction." Pending the filling of the several professorial chairs, the trustees will ask the most eminent men, both in Europe and America, to come to Baltimore during a term of years, and reside there an appointed time, "and be accessible, *publice et privatim*, both in the lecture-room and in the study." One most important appointment has already been made, by which England will lose, for a time at least, one of her most distinguished mathematicians; Dr. J. S. Sylvester has been appointed to the Chair of Advanced Mathematics, at a handsome salary. Prof. Sylvester will probably enter upon his duties in October next.

THERE is great activity at present at South Kensington; the preparations for the opening of the Scientific Loan Exhibition are in a forward state. A large number of contributions have been already received from France, Germany, Belgium, Holland, and Italy.

CONTRARY to the assertion of a contemporary, who apparently desires to mislead, the men of science of this country are giving the greatest help in the organisation of the Conferences and Conversazioni in connection with the Loan Exhibition; these will be held between May 16 and 31.

H.M.S. *Challenger* arrived at Monte Video on Feb. 15, and was to sail on Feb. 23 for Ascension and St. Vincent. The ship is expected to arrive in England about the end of May.

A CAREFULLY prepared and well classified and indexed Catalogue of Maps, &c., of India, and other parts of Asia, has been prepared by the Geographical Department of the India Office, and published by order of H. M. Secretary of State for India in Council. The Catalogue is accompanied with an Index-Map showing the different sheets which are published or which are being prepared by the engraver for publication.

M. J. CAPELLO, director of the Observatory at Lisbon, has selected Lisbon, Campo-Maior, Angra in the Azores, and Funchal in Madeira, as the stations from which meteorological observations will be furnished for international objects. Their situation, and the fact of their observations being made four times daily, have determined the selection of these four stations. The hours are well suited for purposes of international meteorology.

THE Belgian Academy of Sciences offers prizes for papers on the following subjects, to be sent to the Secretary, M. J. Liagre, at the Museum, Brussels, before Aug. 1, 1877:—1. To give a résumé of works which have appeared on the theory of continued fractions, and to improve it in some important point. 2. To examine and discuss, on the basis of new experiments, the perturbing causes which bear on determination of the electro-motive force, and on the internal resistance of an element of the electric pile; to exhibit in numbers these two quantities for some of the

principal piles. 3. New researches to establish the composition and mutual relations of albumenoid substances. 4. To establish, by direct observations and experiments, the functions of the various anatomical elements of Dicotyledinous stems, especially in relation to the circulation of nutritive substances and the use of the fibres of the liber. 5. Does the generative vesicle perform the same part in eggs which are developed without previous fecundation (by parthenogeneses) as in fecundated eggs? 6. Investigation of the cycle of evolution in a group of the class of Algæ. — The conditions usual in such competitions are laid down, and the prizes are gold medals varying in value from 600 to 1,000 francs.

THE *Athenæum* of Saturday last has a well-timed and justly severe note in connection with the filling up of two vacancies among the trustees of the British Museum. A writer in the *Times* has mentioned the names of Sir Henry Rawlinson and Mr. Layard as having claims for the vacant posts, and the *Athenæum* shows that only one trustee is appointed by the Crown, and that the two vacancies will be filled up by the Trustees themselves. "Let us hope," the *Athenæum* says, "that they may see fit to appoint the two scholars in question, or at least one of them. But if they are elected, they will succeed to a perfectly barren honour, unless they are subsequently placed on the Working Committees. It is notorious, that Dr. Hooker, who is a trustee, by virtue of his office as President of the Royal Society, has absolutely no voice in the disposal of the vast collections of natural history contained in the Museum; and that, although there is no naturalist among the trustees with the exception of Sir Philip Egerton. And it is doubtful whether such men as Mr. Layard and Sir Henry Rawlinson, whose sympathies are likely to be with progress and reform, with scholarship and education, will be quite in harmony with that system which has made the British Museum what it now is. They might not feel anxious to strengthen the hands of those officials who are said to have recently endeared themselves to the gentlemen and scholars beneath them by the issue of a slave circular (to use the name by which it is popularly known in the Reading-room), of which it is asserted that some member of the legislature will before long demand the publication."

WE are grateful to the *Daily News* for the advanced and decided views it always takes in matters affecting the interests of science; indeed its advocacy of the claims of science in the country is a distinctive feature of the paper. In an able article in Friday's issue the unsatisfactory condition of the British Museum is pointed out, and it is shown that until an entirely new system of management is instituted, no reform can be expected. "It would seem, indeed, as if the framer of the constitution of the British Museum had, with fiendish malignity, selected precisely those persons as trustees who could by no possibility find time to attend to their duties." It is shown that the recommendations of successive Royal Commissions have been ignored, and that no means have yet been taken to carry out improvements which would greatly increase the usefulness of the Museum. We hope that this article, in conjunction with the note in the *Athenæum* to which we have referred, will have some effect in stimulating the Government to carry out the recommendations of the Duke of Devonshire's Commission and take steps to render the Museum of greater service than it is to science and the country; and that even with its present drawbacks it does render great services must be admitted.

THE Royal Irish Academy has made the following grants out of the fund placed at its disposal by Parliament for advancing scientific research:—35*l.* to Rev. Eugene O'Meara for further Report as to the Distribution of Irish Diatomaceæ; 12*l.* to Prof. Leith Adams for a Report on Irish Pleistocene Mammals; 50*l.* to Rev. Prof. Haughton for a Report on the Tidal Constants of the Irish Coasts (towards the sum of 100*l.* required for the

expenses to be incurred); 25*l.* to Dr. Studdert and Mr. Plunkett for a Report on the Nature of the Mineral Waters of Mallow; 20*l.* to Dr. Chichester Bell for Report on the Chemical Constitution of Pyrol; 40*l.* 12*s.* 8*d.* to Dr. Emerson Reynolds for Report on the Atomic Weight of Glucinum; and 10*l.* to Dr. E. P. Wright for Report on Chytridia Parasitic on Floridææ.

THE Royal Irish Academy, at its stated meeting held on the eve of St. Patrick's Day, elected the following honorary members:—In the department of Science: Carl W. Borchardt, Alphonse Decandolle and Ernst Haeckel. In the departments of Polite Literature and Antiquities: Thomas Carlyle, Margaret Stokes, William Stubbs, Eugène E. Viollet-le-duc, and Ernst Windisch.

M. EMILE DE GIRARDIN and others are trying to organise a Universal Exhibition in Paris for 1878.

THE electric lamp and gramme machine which have been used so successfully at the Northern Railway Station, Paris, have been sent *via* Marseilles to Malta, to be employed in the illuminations when the Prince of Wales stops there on his way home from India.

IN the title to Mr. Evans's recent address to the Geological Society, we inadvertently prefixed Royal to the designation of the Society; we regret that so important a society has not attained to this dignity.

THE Imperial Zoological-Botanical Society of Vienna, celebrates, on April 8, its sixtieth anniversary.

ON July 1 an Exhibition of Arts, Manufactures, Agriculture, &c., will be opened at Helsingfors, the capital of Finland.

PROBABLY not many of our readers are aware of the fact that Great Britain has recently become possessed of the island of Socotra, near the mouth of the Gulf of Aden. Mr. P. L. Sclater calls attention to the fact in Saturday's *Times*, in order to intimate that we are almost completely ignorant of its natural productions. We trust, with him, that the new British Governor and his assistants will not neglect to furnish us, before long, with some account of the natural denizens of this *terra incognita*.

FEARS are entertained that the extraordinary dryness which has recently prevailed in Algeria will lead to a famine. It is stated that no rain has fallen this summer during the usual wet season.

IT is said that a number of governments have given their approbation to the scheme initiated by Austria for sending to the Polar regions a number of vessels to explore scientifically the countries which have been discovered by the *Polaris* and *Tegethoff* expedition.

VISCOUNT CARDWELL is to ask the Government to-day in the House of Lords what course they intend to pursue with regard to Cambridge University. In answer to the Marquis of Lansdowne who, on Monday, among other things asked whether Science would be represented in the Oxford University Commission as well as rank, dignity, and learning, the Marquis of Salisbury stated he had no objection to name the Commissioners next Monday, and at the same time he would state the nature of the amendments to be proposed by the Government.

VAST masses of dense smoke were reported to be issuing from Mount Vesuvius on Sunday; flame was visible at night; the apparatus at the Observatory was in a state of disturbance, and an eruption seems probable before long.

DR. PETERMANN has sent us one of the best maps we have seen illustrating Cameron's route between Lake Tanganyika and the coast. The map, which is based on that of the Royal Geographical Society, is on a comparatively large scale, shows the



utes of Cameron, Livingstone, Magyar, and the Pombeiros, Cameron's camping stations, all the rivers observed by Cameron, and is coloured to show the orographical features. It extends from 3° to 13° N. lat.

IN Monday's *Times* is a long letter from the Rev. S. Macfarlane, giving an account of an interesting trip in the missionary steamer *Ellangowan*, for 170 miles up the Fly River, New Guinea. The account seems to be essentially the same as that read at the last meeting of the Geographical Society. Signor Albertis was on board and obtained a considerable number of natural history specimens. Mr. Macfarlane sums up the results of the trip as follows:—"Several important ends have been attained by our visit to the Fly River. We have proved that there really is a navigable river there extending far into the interior of the country. We have opened up the way, which has hitherto been guarded with great determination by savages, and have taught them the danger of attacking European vessels. On our return we succeeded in establishing what appeared to be a genuine friendship between the natives and ourselves, exchanging presents. We have learnt something of the character of the interior; and, although we found it low and swampy up to the highest point we reached, we have at least proved that high land is not to be reached within at least two hundred miles by the course of the river, the first hundred being thickly populated by a mixed race—Papuan and Malayan—speaking different dialects, and at war with each other. They are an intelligent-looking, energetic people. We obtained a considerable number of specimens of natural history. We were disappointed at not reaching high land with populous and healthy villages suitable for stations."

THE death is announced of the widow of the late Hugh Miller at the age of sixty-four years. She took a chief part in editing her husband's works after his death, and gave much assistance to Mr. Peter Bayne in the preparation of the sturdy geologist's biography.

DR. PARKES, F.R.S., the distinguished professor of hygiene at the Army Medical Schools, died on the 15th inst.

THE Oxford Burdett-Coutts Scholarship has been awarded to Mr. A. H. S. Lucas, of Balliol College.

SEVERAL letters have appeared in the *Daily News* calling attention to the fact that on Sunday week red snow was observed to have fallen in several parts of the country—at Forest Hill and Streatham in the south of London, at Reading and at Thurston in Norfolk. This phenomenon was observed in ancient times, and is referred to by Pliny; in modern times it has been frequently observed in all parts of the world, and is familiar to Arctic explorers. The phenomenon is generally ascribed to the presence of an alga, *Protococcus nivalis*.

WE have received from the U.S. Geological and Geographical Survey of the Territories one of these valuable publications, which it is grievous to think the caprice of a political party may soon bring to a stop. This is a preliminary map of South-west Colorado, and part of Utah, Arizona, and New Mexico, showing the location of ancient ruins. The map is on the scale of five miles to an inch, and shows not only the sites of the prehistoric ruins which abound in the region, but the courses of the principal rivers and of dry gulches, and by means of lettering the general character of the surface of the country.

*Bulletin* No. 1, vol. ii. of the Geological and Geographical Survey of the Territories, under the direction of Prof. Hayden, is one of unusual interest. It contains seven articles, with the following titles:—1. A notice of the ancient remains of South-western Colorado examined during the summer of 1875. 2. A notice of the ancient ruins in Arizona and Utah lying about the

Rio San Juan. 3. The human remains found near the ancient ruins of South-western Colorado and New Mexico. 4. Ancient art in North-western Colorado. 5. Bead ornaments employed by the ancient tribes of Utah and Arizona. 6. Language and utensils of the Utes. 7. Fossil Coleoptera from the Rocky Mountain Tertiaries. The text is illustrated with twenty-nine octavo plates, embracing cliff and cave houses, arrow-heads, pottery, human skulls, &c. Mr. Scudder's article contains descriptions of thirty-one new species of fossil Coleoptera.

THE first section of the building for the American Museum of Natural History, in Central Park, New York, will be ready for occupation in the coming summer. Some time ago, our readers may remember, New York appropriated 700,000 dollars to commence this edifice, and it has also set aside for this section and its future extensions, 18½ acres of land worth from 5,000,000 dollars to 8,000,000 dollars. The whole edifice when complete will be about eighteen times as large as that now nearly ready, and will cost about 15,000,000 dollars. The collection is at present in a wooden building, which is visited by an average of 13,600 people per week—2,000 more than the average weekly number of visitors to the entire collections in the British Museum.

THE additions to the Zoological Society's Gardens during the past week include two Suricates (*Suricata senik*) from S. Africa, presented by Mr. G. Thorburn; a Knot (*Tringa canutus*), European, presented by Mr. C. Clifton; a Rhesus Monkey (*Macacus erythraus*) from India, presented by Mr. Robert Law Ogilby; a Bonnet Monkey (*Macacus radiatus*) from India, presented by Mr. J. Shortland; a White-Cheeked Capuchin (*Cebus lunatus*) from Brazil, presented by Dr. Lynn; an Aztec Couure (*Conurus aztec*) from Mexico: two All Green Parrakeets (*Brologerys liviacula*) from S. America, purchased; a Collared Fruit Bat (*Cynonycteris collaris*), born in the Gardens.

#### REPORT OF THE CAMBRIDGE STUDIES' SYNDICATE

THE Syndicate appointed in May last year to consider the requirements of the University of Cambridge in different departments of study, have just issued their Report. This contains many features of interest. We reprint the answers of the Board of Natural Science Studies to the questions sent by the Syndicate. What the nature of these questions is may easily be gathered from the answers.

1.—A—(a). The Board is of opinion that lectures are required in the University on the following subjects:—1. Principles of chemistry and inorganic chemistry, organic chemistry, physical and thermal chemistry, &c., analysis, elementary qualitative, analysis, elementary quantitative, analysis (1) of minerals (metallurgy, &c.); (2) organic; (3) volumetric; (4) spectrum.

Catechetical lectures are also required, suited for students of different degrees of attainment. There should be also laboratory teaching in practical chemistry, including qualitative and quantitative analysis and instruction in chemical research. Probably one term would suffice for each course of lectures, except the general course on chemistry and perhaps the course on organic chemistry which might occupy two terms each. For the special courses on analysis one or two lectures a week or three lectures a week for part of a term would suffice.

2. An elementary course on physics, occupying two terms. Special courses:—(1) General physics, dynamics, &c. (1 term). (2) Heat and thermodynamics (2 terms). (3) Sound and Light (2 terms). (4) Electricity and Magnetism (3 terms). (5) Methods of observation, &c. (1 term). Higher courses (chiefly mathematical):—(1) Heat and thermodynamics (1 term). (2) Sound and light (1 term). (3) Electricity and magnetism (2 terms). There should be a course of practical laboratory instruction extending over three terms, and special laboratory teaching for advanced students.

3. A course on elementary crystallography, and one on mineralogy, together occupying about two terms.

4. General geology, physical geography, and geological physics. Stratigraphical geology. Petrology. Palæontology—general.

Special Palæontological lectures and demonstrations in connection with the lectures on stratigraphical geology.

5. \*Elementary biology.
6. Systematic botany:—(1) \*Elementary and (2) Advanced.
7. Vegetable morphology and physiology:—(1) \*Elementary, and (2) Advanced.
8. Zoology:—General. Special, (1) Vertebrates. (2) Molluscs. (3) Insects. (4) other Invertebrates.
9. Comparative anatomy:—(1) Elementary and (2) Advanced. \*Embryology. Osteology.
10. Physiology:—(1) Elementary and (2) Advanced. \*Physiology of the senses. \*Physiology of nutrition.
11. Human anatomy, including animal mechanics, &c.:—(1) Elementary and (2) Advanced. \*Ethnology.

Each of the courses on the subjects numbered 5 to 11 would probably require two terms, except those marked \*, each of which might be concluded in one term. In many of these subjects more or less catechetical teaching would be desirable.

With respect to the distribution of these courses among different teachers:—

1. The general superintendence of the chemical laboratory with the delivery of one course of lectures, usually those on general chemistry, would sufficiently occupy the time of the professor. Organic chemistry, including the superintendence of the practical work in this subject, would occupy the greater part of the time of a second professor. He might, however, in some cases also deliver one of the special courses. Some of the special departments of chemistry might perhaps be undertaken by demonstrators, but for the remainder, and for catechetical instruction with a proper division of classes, two additional teachers are at present needed who may very well be inter-collegiate lecturers.

2. The superintendence of the physical laboratory, with the teaching of such branches of mathematical physics as are not provided for by other professors under the jurisdiction of the Mathematical Board, would probably occupy all the time of the Professor of Experimental Physics. The special experimental courses might, if necessary, be given by demonstrators, but at least one regular teacher of experimental physics in addition to the professor would be desirable.

3. The mineralogical teaching at present required in the University might be given by the professor, the students being referred for the chemical part of the subject to one of the teachers of Chemistry.

4. Stratigraphical geology, petrology, and Palæontology would each require a separate teacher. Lectures on different portions of stratigraphical geology might be delivered in different years. Parts of the course on general geology (*e.g.* that on glacial phenomena, earth movements, &c.) might be given by the lecturer on stratigraphical geology. Some parts (*e.g.* that on volcanic phenomena) being undertaken by the petrologist. Special demonstrations on Palæontology in connection with the course on stratigraphical geology might be given by curators or demonstrators.

5. The course on elementary biology might be given by a demonstrator acting under a Professor of Physiology or of Comparative Anatomy.

6. The elementary and advanced courses on systematic botany might be given by one teacher.

7. The elementary and advanced courses on vegetable morphology and physiology might be given by one teacher. A third botanical teacher (for cryptogamic botany) will probably be required at a future time.

8. The general course of zoology requires one teacher. The teaching which is at present required in the special departments of zoology might be given by Curators of the Museum, who should also act as demonstrators; but special teachers of each of the four departments will be required eventually.

9. The elementary and advanced courses on comparative anatomy might be undertaken by one teacher. The courses on embryology and osteology might be given by demonstrators; but each subject is important enough to occupy the whole time of a teacher if a suitable one is available.

10. The elementary and advanced courses on physiology require one teacher. The remarks made on embryology and osteology apply also to the subjects of the physiology of the senses and the physiology of nutrition.

11. Elementary and advanced courses on human anatomy might be undertaken by one teacher. The subject of ethnology would be best undertaken by a separate teacher if circumstances should admit.

A (*β*). It is desirable that the University should have the opportunity of inviting men who have devoted themselves successfully to the prosecution of special departments of science to give lectures in the University; but the delivery of such lectures must depend rather upon the men being forthcoming than upon any *a priori* consideration of what subjects require elucidation.

B (*α*). Viewing this question with reference simply to the numbers of students, there appear to be no branches of natural science in which the classes which require to be put through exactly the same course in the same term are so large as to require division.

B (*β*). The approximate number of students in the University classes in most of the above great groups of subjects is from twenty to thirty; in the class of elementary biology the number is larger; in chemistry the number is nearly a hundred. The number may be expected to increase.

C. In most of the natural science subjects opportunities for individual personal intercourse between teachers and students occur in the course of laboratory and field work. Most of the professors encourage the students to ask questions after lecture, and some give short catechetical lectures before the ordinary lecture.

D. For the superintendence, under the professors, of the laboratory work, and for giving instruction in such of the special chemical subjects as may not be otherwise provided for, four demonstrators are required. If the number of students increases, more demonstrators will be required. In physics not less than three demonstrators will probably be required. Each of the professors or other principal teachers of chemistry and physics will require a lecture assistant, and boys to do general work in connection with the laboratories will be required in the proportion of about one to each demonstrator. In the geological Museum three curators or demonstrators will be required—one of these at a time would be occupied as a demonstrator in assisting the professor and the Palæontologist—the others would be engaged in the general work of the Museum. The petrologist would require a curator who should also act as demonstrator. The Professor of Geology also requires an assistant to prepare and keep in order diagrams, maps, models, &c. The teacher of systematic botany requires a demonstrator. The teachers of vegetable morphology, of comparative anatomy, and of physiology will each require demonstrators in the proportion of one to every ten or fifteen students. Assistance in the same proportion will be required for the class in elementary biology, but this may probably be provided from the staff of the teachers of comparative anatomy, physiology, and vegetable morphology. Four curators, who might also act as demonstrators, will be required for the special departments of zoology. One or two demonstrators in human anatomy will be required.

E. In addition to special libraries attached to the different departments, a general scientific library, easily accessible from the Museums is required. In *Chemistry*. A new and more spacious laboratory is urgently required. To this should be attached a museum of chemical preparations. In *Geology*. A new museum has long been an acknowledged want. In *Botany*. Workrooms are required in connection with the Herbarium; also a laboratory for vegetable morphology and physiology, including rooms for microscopical work, &c. In *Zoology*. Workrooms are required for the professor, superintendent of the museum, curators, and demonstrators. In *Comparative Anatomy*. A laboratory is required, including dissecting-rooms, rooms for microscopical work, &c. In *Physiology*. A laboratory is required, including chemical laboratories, rooms for microscopical work, &c. In *Human Anatomy*. Dissecting-rooms are required, and rooms for microscopical work. Each department will require rooms for research, microscopes and other apparatus, as well as diagrams.

Such are the requirements necessary to make instruction in natural science fairly complete. In the physical departments the wants of chemistry are the most urgent; teachers of palæontology and petrology are urgently required. In reference to more immediate wants of the biological departments, it may be stated that the present teaching staff consists of the Professors of Anatomy, Botany, and Zoology and Comparative Anatomy, each of whom, except the Professor of Botany, has a demonstrator.

The chief teaching of physiology is at present conducted by the Trinity Prælector in Physiology. The additions to the teaching staff most urgently required are (1) a professor or teacher of comparative anatomy; (2) a more definitely recognised teacher of vegetable morphology and physiology; (3) two

curators in zoology (molluscs and insects), to act also as demonstrators; (4) two Demonstrators of Physiology; (5) an additional Demonstrator of Comparative Anatomy; (6) an Assistant-Curator of the Herbarium, to act also as Demonstrator of Systematic Botany; the Professor of Botany being *ex officio* Curator of the Herbarium. The appliances most urgently needed are laboratories for chemistry, comparative anatomy, physiology, and vegetable morphology, and workrooms for the zoological museums.

II. (a) It is desirable that all the teachers in each of the several departments should be grouped in one organisation.

(b) The Board considers that while there is room in the University both for professors and lecturers, appointed directly by the University, and for inter-collegiate lecturers, it is undesirable to have lecturers in natural sciences teaching members of their own colleges exclusively.

(c) It appears that physiology, comparative anatomy (as distinguished from zoology), and vegetable morphology and physiology (as distinguished from systematic botany), are so important and so distinct that they should be entrusted to independent professors, but till this can be done the subjects may be undertaken by other lecturers.

(d) It seems desirable that the selection of University professors should be entrusted to a body of about seven electors, of whom a majority should be residents in the University; that such electors should be appointed either for life, for a term of years, or by virtue of holding some official post, and that those who are not *ex-officio* electors should be nominated by the Board of Studies with which the professorship is connected, and be elected by the Senate. Further, that the selection of other teachers appointed by the University, but not directly subordinate to the professors, should be made by similar bodies of electors resident in the University, or by the several Boards of Studies, and that demonstrators should be appointed as at present.

(e) It seems desirable that in the case of the recognition of individual inter-collegiate lecturers by the University, the appointment of such lecturer should receive the confirmation of the several Boards of Studies.

III. (a) It seems highly desirable that the professorial and inter-collegiate lectures should be brought into closer relations with each other; and it seems probable that this may be effected, in part at least, by organising meetings of the professors and other teachers in each department, in order to arrange a plan of combined action in teaching, and to consider and determine a scheme of lectures, such scheme to be submitted to the Board, and, if approved by the Board, published at the beginning of the academical year by its authority.

Further, the Board thinks it desirable that the university should appoint, from time to time, on the recommendation of the Boards of Studies, lecturers on any subject or subjects which may not at the time be adequately represented by professors, inter-collegiate lecturers, or other teachers.

(b) The Board is not prepared to suggest any further provision for the organisation of the professorial lectures in its department.

With respect to inter-collegiate lectures, the control exercised by the Board over the authoritative publication of the scheme drawn up after consultation with the professors would, it is hoped, be sufficient for the effective organisation of the whole system.

(c) The power given to the Board of Studies of remitting for further consideration any scheme of professors' lectures which the Board disapproves, may be used to prevent any undue interference of one professor with the departments properly belonging to another.

With regard to competition in a wider sense, the Board does not see that any regulation of it is necessary or desirable.

Considering the importance in many cases of the lectures on natural sciences being delivered in a central building, and of the University collections being made as much use of as possible, it is desirable that power should be possessed by the Museums and Lecture-rooms Syndicate, or by some other University authority, to allow inter-collegiate or other lecturers, recognised by the University, to make use of University lecture-rooms, museums, &c., with the consent of the professors concerned, and under such conditions as may be found necessary to avoid interference with the work of the professors or risk of injury to the collections.

IV. There seem to be two ways in which the advancement of knowledge may be assisted by organisation. One is by giving

mature students (in which light the Board must regard the professors and inter-collegiate lecturers) some amount of leisure for the prosecution of their studies, and some inducement to pursue them with energy, and to give the results of them to the world. The other is by giving opportunity to younger students, such as our younger graduates, who may show promise of capacity to do original work, and who are anxious to attempt it, the opportunity of making their first essays, under skilled guidance and under favourable conditions, in some place where their qualifications can be judged and their results appreciated.

A considerable part of the original work done by those engaged in the higher teaching at Cambridge must probably be always done during the vacations, but it must be always difficult for a professor, or other advanced teacher, to keep himself well acquainted with all that is being done in his department, to say nothing of advancing knowledge in it, unless the more engrossing kind of work is so distributed and arranged that each of the principal teachers should have one term in the year of, at any rate, comparative leisure. For any additional stimulus that may be necessary in order that such leisure may be employed for the benefit of science we must look to public opinion.

In order to encourage and facilitate the advancement of knowledge by the younger graduates, it seems desirable that most of the rather numerous demonstratorships which are required should be temporary appointments, and should be offered to such of the younger graduates and others as shall have shown a desire to attempt original work, and given promise of capacity for doing it. The work of the demonstrators, however, if it is properly done, takes up so much time and energy that but little original work can be expected from them, unless they too are allowed, at any rate, comparative freedom from work for one term in the year, during which they may be expected to assist the professors in their researches, or to carry on work of their own under the direction of the professors. They should not be allowed to take private pupils. In all branches of natural science it is desirable that the teaching should be continued throughout the terms and not be limited as at present to the middle two-thirds.

### SCIENTIFIC SERIALS

*American Journal of Science and Arts*, February.—The first article is an obituary notice of Sir W. E. Logan, read before the Natural History Society of Montreal last October.—Mr. W. B. Taylor contributes a continuation of his history of recent researches in sound.—Mr. A. H. Rowland continues his studies on magnetic distribution, in which he critically examines M. Jamin's recent work.—On the rifts of ice in the rocks near the summit of Mount McClellan, Colorado, and on the different limits of vegetation on adjoining summits in the territory, by Edward L. Berthoud. Mount McClellan is 13,430 feet high, and contains mines which are extensively worked. At a height of 13,100 feet, and about 30 feet from the entrance of the tunnel of one of the mines, were three or four veins of solid ice, parallel with the bedding of the rock, and filling all its inner side with cracks and fissures. In another tunnel 300 feet westward and about 100 feet from the entrance, veins of ice were also met with. It has been suggested that this ice has remained ever since the Glacial period. The mountain presents these two strange antagonistic phenomena in immediate proximity. On one side of the valley there is a mountain slope facing north-east, well grassed, totally devoid of shrubs and trees, where the rocky *débris* are underlain by a perpetual icy coat hundreds of feet in depth, supporting on its surface a growth of plants strictly Alpine and Arctic, and abounding with Ptarmigan, *Lagopus leucurus*, and the tail-less, earless marmot. A list of plants found bloom Oct. 2, 1875, is given. Less than half a mile distant on the opposite slope of the vale *Pinus aristata* of large size and a profuse growth of birches, willows, grasses, and arbutus abound.—On a new form of lantern galvanometer, by Francis E. Nipher, which possesses the advantages of being adaptable to any vertical lantern; the distance between the deflecting coils is readily varied and can be adjusted to currents of various intensity; the resistance of the galvanometer is quickly varied from one half to twice the resistance of the galvanometer coils.—On the occurrence of tartaric acid, with some remarks on the molecular structure of glyceric acid, by S. P. Sadler. A comparison is made of two views taken of glyceric acid, and it is suggested that there are two isomeric acids, one of which is normal and the other an unsymmetrical acid.—On the "chloritic formation" on the western

border of the New Haven region, by J. D. Dana.—A new Tertiary lake basin, by G. B. Grinnell and E. S. Dana. During recent explorations a new series of Tertiary deposits has been found at Camp Baker, Montana; they indicate the existence in this region of a Miocene lake basin, which was succeeded by another lake basin in Pliocene time.—The remaining papers are: The product of the action of potassium on ethyl succinate, by Ira Remsen.—The action of ozone on carbon monoxide, by the same.—The appendix contains an article on the Dinocerata, by O. C. Marsh, with five plates.

*Journal de Physique*, Dec. 1875.—We simply name the principal papers in this number, which are mostly of a mathematical nature:—Application of the laws of Coulomb to electrolytes, by M. G. Lippmann.—On the determination of condensing power, by M. Terquem.—On the magnetisation of steel by currents, and on the situation of the poles in long needles, by M. Bouty.—On an experiment relative to the transformation of forces (we refer to this more fully elsewhere).—Criticising a paper of Mr. Tomlinson's on the action of solids in liberating gas from solution, M. Gernez disputes that observer's result in the experiment in which a small metallic cage with very close meshes is introduced into seltzer water. M. Gernez says that, varying the experiment in many ways, he has always found that the gaseous mass imprisoned in the cage increases at expense of the dissolved gas. In a few minutes it increases sufficiently for bubbles to be formed in the larger meshes, and one may even determine beforehand the points where gaseous liberation will take place, by enlarging certain meshes with the point of a needle.

## SOCIETIES AND ACADEMIES

### LONDON

Royal Society, Feb. 17.—“On Experimental Contributions to the Theory of Electrolysis,” by Alfred Tribe, Lecturer on Chemistry in Dulwich College. Communicated by J. H. Gladstone, Ph.D., Fullerian Professor of Chemistry in the Royal Institution.

Linnean Society, March 2.—Prof. G. J. Allman, president, in the chair.—Sir Victor A. Brooke, Bart., Mr. R. B. Croft, Dr. Ralph Gooding, Mr. F. J. Horniman, and Mr. W. Percy Sladen were elected Fellows of the Society.—Preceding the business routine, it was the painful duty of the President to announce the demise of John J. Bennett, F.R.S., who formerly, and for twenty years most creditably acted as secretary to the Linnean Society. Among his scientific labours the “*Plantæ Javanicæ*” worked out a then imperfectly-trodden field; his colleague in the said volume being Robt. Brown, *facile princeps botanicorum*. Mr. Bennett afterwards, and for years, was chief of the botanical department of the British Museum, retiring to Sussex, where he died. As a man he worked well, wisely, and energetically, and his name will always be remembered among botanists and friends as ripe in science, humanity, and fulness of heart. Another Foreign Member who has lately died, M. Adolphe T. Brongniart was among the most distinguished botanists of our age and a Fellow of the Society for upwards of forty years. His fame will rest on his “*Végétaux Fossiles*,” wherein he may be said to have laid the foundation of fossil botany. He, moreover, wrote a vast number of other original and independent memoirs, and still found time for years to conduct as editor the botanical section of the *Annales des Sciences*, enriching the same with his great erudition.—J. Gwyn Jeffreys, F.R.S., exhibited on behalf of Sir James Anderson, a fine and interesting specimen of the so-called felt or blanket sponge, *Astonema subulense*, Kent. This was picked up Aug. 24, 1875, along with the telegraph cable from a depth of 550 fathoms off Cape Finisterre.—Mr. C. Stewart called attention to peculiarities of the large rosette spicules found in its fluffy structure.—A mould of the upper surface of the cranium of the fossil *Ornithochirus* and various fragments of the skeleton were exhibited and commented on by Prof. Seeley; these illustrating points raised in a former paper of his “On the Organisation of the Ornithosauria.”—A paper was read on a new genus of Turnercææ from Rodriguez, by I. B. Balfour, F.L.S. The tree in question is known to the inhabitants under the name of *Bois Gaudine*, and grows on the hilly parts of the island. It possesses a fine-grained, light-coloured wood, which, however, is not much used. The tree itself is handsome though small, being very erect in habit; its terminal branches are clothed with a light-green foliage. This new genus *Mathurina*, has close relationship to

*Erlichia*, but differs manifestly from *Turnera* and *Wormskieldia*, its circumscribed habitat, moreover, lending additional interest. Mr. J. G. Baker, of Kew, in addition, stated that the botanical results of this Rodriguez Transit of Venus Expedition, through Mr. Balfour's collecting, had yielded some 280 species of flowering plants and ferns. Of these 110 were common weeds and 170 species indigenous to the island. The botany of Rodriguez, with a total area of fifteen miles, has now been fully settled by Mr. Balfour's researches, and these go to sustain its flora as belonging to the temperate region, and not truly tropical in character.—A paper on pollen was communicated by M. P. Edgeworth, F.L.S. The pollen grains of some 400 species have been carefully examined and drawn to scale by the author, those of the main orders of plants receiving comparison. It results from his survey that some families appear to have the bodies in question of variable forms, while others are remarkably uniform in shape.—Notes on algae found at Kerguelen Land (by the Rev. A. E. Eaton), by Prof. Dickie, F.L.S. In this paper three new species, *Sphacelaria corymbosa*, *Melobesia kerguelini*, and *Ptilota eatoni* are described. The total number of algae recorded are 65; of these 16 belong to the Olive, 34 to the Red, and 15 to the Green series. While there are 9 peculiar to the island, 21, or about one-third, are also found on European shores.—A list of the Musci and Hepaticæ collected in Kerguelen Island (by the Rev. A. E. Eaton), by William Mitten, F.L.S., was taken as read. This contains reference to 38 mosses and 13 liverworts, of the former, *Bartramia eatoni*, of the latter, *Tylmanthus viridis* and *Balantiopsis incrassata*, are new to science.—W. Carruthers, F.R.S., in calling attention to the specimens on the table, gave a résumé of the recent researches of Prof. De Bary of Strasbourg, into the potato fungus. The Peronosporæ De Bary separates into three genera. In *Cystopsis* the conidiophores grow in large bunches, the conidia, or bud-cells, being developed in single rows in basipetal order. In *Peronospora*, from a tree-like mycelium, conidiophores arise singly or in small bunches at the end of the branches, and have no successors in the direct line. *Phytophthora* differs from the last in its multiple and successive conidia, which, when shed, leave swellings on the branches. The ripe conidia in all, when placed in water, produce zoospores, or nucleate moveable cells provided with cilia. These penetrate the plants, and, ceasing to move, develop threads, or mycelium. By another sexual method of propagation the oogonia, bladder-shaped female cells, after being fertilised by the small male cells, antheridia, produce from their protoplasm a thick-walled oospore. Mycelial threads sprout from this latter and the above process is repeated. A considerable period of inactivity may, however, precede the germination of the oospore, which in this case hibernates for the winter, whilst its host decays. The conidia, De Bary states, propagate and spread the fungus during the summer season only, but do not live through the winter. He has, moreover, found in decayed potato tubers bodies exactly corresponding to oospores. On experimenting with the oogonia of these and planting them in potatoes he obtained bodies which conducted themselves precisely like zoospores, and in most respects resembled those of *Pythium*. Other experiments with them, on the moistened legs of dead flies and bodies of mites, resulted in their complete phases of development, which was watched step by step, the zoospores producing a plentiful crop of mycelium, &c. As this new fungus in many ways differs from the *Phytophthora infestans*, he names it *Pythium vexans*, on account of his trouble therewith. He regards it as a true Saprolegnia. De Bary has likewise investigated the question of the perennial mycelium of *Phytophthora* occasionally discharging the function of hibernation where the oospores are not found in the district. He believes he has established by proofs that there are two methods whereby the conidia pass from the tuber to the foliage. The general opinions held in this country De Bary is at variance with. Mr. Worthington Smith replied at some length to Mr. Carruthers' epitome, and criticised De Bary's conclusions unsparingly. Dr. Masters supported Mr. Smith's views, as opposed to Prof. De Bary's interpretation of the subject at issue. Further discussion of this interesting topic was postponed till next meeting. A series of the said parasitic fungi prepared by De Bary were exhibited under the microscope to the Fellows present. His complete memoir hereafter is to appear in the Roy. Agric. Soc. Trans.

Chemical Society, March 16.—Prof. Abel, F.R.S., president, in the chair.—Before commencing the ordinary formal

business of the Society, Dr. J. H. Gladstone rose and in a short speech proposed a vote of thanks to the president for the exceedingly enjoyable visit to the Royal Arsenal at Woolwich on the preceding Tuesday, and for his generous hospitality on that occasion. This was seconded by Dr. Gilbert and carried by acclamation. The following papers were then read:—On crystallized glycerin, by Dr. P. F. van Hamel Ross; notes on the fatty acids and on a suggested application of photography, by Mr. W. H. Hatcher.—On stibine, by Mr. F. Jones.—On the use of platinum in the ultimate analysis of carbon compounds, by Mr. F. Kopfer;—and on the action of organic acids and their anhydrides on the natural alkaloids, Part v., by Mr. G. H. Beckett and Dr. C. N. A. Wright.

Royal Astronomical Society, March 10.—Mr. Huggins, president, in the chair.—Since the last meeting the Society has received a valuable present of rare books from the library of the late Mr. Sheepshanks. Lord Lindsay has also presented the Society with the sun-spot manuscripts and observations of the late Mr. Carrington, a very valuable series, which has been made use of in determining the present received values of the elements of the position of the sun's axis and the drifts of the solar photosphere.—A paper by Dr. Royston Piggott was read on a star-illuminated transit eye-piece. A sheet of glass, on which a thin film of silver is deposited, is placed in the focus of the eye-lens; transparent lines are drawn on the film, instead of wires, and as the star passes across the lines it is seen to flash out brightly. The film of silver is made sufficiently thin to permit of the star being seen when it is between the lines, but it appears that the lines themselves are only visible, except in the case of very large stars, when the star disc is in transit across a line. Capt. Abney read a paper on photographing the least-refracted end of the solar spectrum. He said that within the last two years many attempts had been made to photograph the ultra-red rays. Dr. Vogel, in 1874, and more recently Capt. Waterhouse, had made use of aniline dyes in the collodion. They stated that with a red dye the collodion was found to be most sensitive to the red end of the spectrum. He had repeated these experiments, and had obtained only partial success; he had, however, from considering the chemistry of the question rather than the physical explanation which had been given and which he believed to be a mistake, been led to try other experiments as to mixing gum resins with the collodion, and had obtained a compound which was very sensitive to the long wave-lengths, so that he had been able to obtain distinct traces of the spectrum beyond A. He hoped to continue his experiments and to give a fuller account of them to the Society at a later meeting.—Two papers were read on the proper motion of the star B. A. C. 793. It appeared from the remarks of the Astronomer Royal and Mr. Dunkin that there is no sufficient evidence to prove that its proper motion has changed during the present century.—Capt. Noble drew attention to a paper by M. Normand on the occultation of stars by the planets as a means of determining the solar parallax. He wished the owners of large telescopes to determine with what degree of accuracy they could observe the occultation of minute stars at the limb of Mars.

Entomological Society, March 1.—Prof. Westwood, president, in the chair.—Dr. G. Kraatz, President of the German Entomological Society, Berlin, and Mr. Clemens Müller, of Berlin, were elected Foreign Members; and Mr. O. E. Jansen was elected an Ordinary Member.—Mr. Jenner Weir exhibited two grasshoppers, in an undeveloped state, taken by himself in the Rhone valley, *in copula*—a peculiarity which had frequently been observed among the Hemiptera. He also exhibited a remarkable moth from Madagascar belonging to the *Uranidea*, bearing a very striking resemblance to a *Papilio*, except that it had the antennæ of a moth, and the hind wings were destitute of tails.—Mr. E. Y. Western exhibited Coleoptera taken chiefly in Switzerland.—Mr. W. Arnold Lewis exhibited a specimen of *Argynnis dia* taken in England by Mr. Wallace A. Smith. Mr. Smith, who was present at the meeting, stated in answer to various inquiries by the President, that he had taken the specimen in 1872 in Worcester Park, and distinctly remembered the capture, as it was the first fritillary he had ever had in his possession, and also that it had never been out of his possession since.—Mr. Bates read a paper from Mr. Trovey Blackmore to Mr. McLachlan stating that he was much interested in observing a notice in the Proceedings of the Society respecting the habits of *Cychnus cylindricollis*, reported by M. Baudi to feed on snails. He had already called attention (in the *Entomologist's Monthly Magazine*, vol. xi. p. 214) to the fact that the *Carabus stenocephalus*, Fairm., fed on

snails, which in Morocco were so very abundant as to form a marked feature in the landscape by covering the bushes so thickly as to resemble, at a distance, clusters of blossom. He had captured in all eighteen specimens of this rare *Carabus*, and of these fifteen were obtained either feeding on snails or climbing up bushes of *Retama*, which were covered with snails, especially with *Helix planata*. The *Carabus* having an unusually long head, and the prothorax being narrowed anteriorly enabled it to thrust its head and prothorax a considerable distance into the shell in search of its food. Mr. Blackmore referred to some other North African species of *Carabi*, which he thought might be found to have similar habits to those of *C. stenocephalus*.—The President read a paper entitled "A Dipterological Note from Pompeii," containing remarks on the habits of the genus *Bombylius*. The President also presented descriptions of some new species of *Tipulida* in the British Museum, accompanied by drawings, showing them to be furnished with hind legs of unusual length.—Mr. John Scott contributed a monograph of the British species belonging to the *Hemiptera-Homoptera* (family *Pryllidae*), together with a description of a genus which might be expected to occur in Britain.

Physical Society, March 11.—The president, Prof. G. C. Foster, F.R.S., in the chair.—The following candidates were elected members of the society:—W. H. Coffin, T. D. Humidge, and Rev. G. H. Hopkins.—Prof. W. G. Adams gave an account of some researches on which he has been engaged in connection with the influence of light and heat on the electric conductivity of selenium, and exhibited numerous experiments in illustration. The subject has also been studied by Lieut. Sale and Dr. W. Siemens of Berlin, and as a general result it is found that after it has been kept in the dark, the resistance of the metal is diminished by exposure to light. The effect, however, both of heat and light, is different in the several states through which the metal passes. Thus when a piece of amorphous selenium is gradually heated to about 100° C. kept at this temperature and slowly cooled, its resistance at first is so great that it cannot be measured by the ordinary arrangement, but as its temperature increases, the resistance diminishes and increases again more slowly when the metal is allowed to cool. The resistance of several pieces which at the higher temperature were from one to three megohms were found to be from 100 to 130 at the ordinary temperature. If this selenium be placed in a paraffin bath and heated, its resistance diminishes, and when the temperature is kept constant above 140° C. for some hours and the metal is then slowly cooled, it assumes a crystalline structure, and its resistance diminishes as it cools. The resistance of such selenium at ordinary temperatures increases with the temperature. The effect is more marked as the temperature of the paraffin bath is increased. In studying the effect of light, the metal which had been heated to 140° C. was exposed to a candle at distances of 1,  $\frac{1}{2}$ , and  $\frac{1}{3}$  metre; the initial resistance being 115,500 ohms. The readings in these three cases were 112,000, 108,700, and 101,500. Deducting each from the initial number we have 3,500, 6,800, and 4,000 ohms as the changes of resistance due to exposure at these distances. Hence the effect of light varies inversely as the distance or, what amounts to the same thing, directly as the square root of the illuminating power. These considerations have led Prof. Adams to suggest the use of selenium for comparing the illuminating powers of different sources of light, and he exhibited the arrangement which he proposes to use for this purpose. The action of light of different degrees of refrangibility was then exhibited, by allowing the light from several parts of a spectrum of the electric lamp produced by a bisulphide of carbon prism to fall on the metal, the remainder being cut off by means of a screen, in which there was a narrow slit. The violet light gave a deflection of about two divisions on the screen, the greenish yellow four, the orange red five and a half, and the deep red nine divisions. The effects produced by the greenish yellow and the deep red are at times nearly equal. It may easily be shown by raising the temperature of the metal that the effect of light on its conductivity is essentially the same in kind at a low and moderately high temperature. The fact that light and not dark heat produces the observed effect has been shown by sending the beam through solutions of iodine in bisulphide of carbon. A very small effect on the metal was always observed, but this may be assumed to have been due to light, as in all cases it was possible to see the form of the carbon points through the solution. This fact may also be strikingly shown by exposing selenium through which a current is passing to the flame of

a Bunsen burner, first, when in its ordinary condition, and afterwards with the air openings at the base closed. It was shown that, whereas in the first case the effect produced was equivalent to three divisions of the scale, in the latter case one-tenth of the current produced by the exposure deflects the needle to the end of the scale. Prof. Johnstone Stoney then explained the theory which he has suggested in explanation of the phenomena observed in the radiometers of Mr. Crookes, which has been published in the *Philosophical Magazine* for the current month. The theory rests on the supposition that there is an excessively small trace of residual gas in the sphere in which the moving discs are enclosed. When the apparatus is exposed to heat the blackened side of the disc is slightly warmed, and this warms a layer of air in contact with it. At the ordinary atmospheric pressure, Prof. Stoney assumes the layer so warmed to have the thickness of a sheet of paper, when the temperature of the disc is 20° C. above that of the surrounding air, and on such a supposition we may calculate it for any other pressure and temperature. If we diminish the pressure the thickness varies inversely as the pressure raised to the power  $\frac{1}{2}$ . Thus if the disc be raised  $\frac{1}{2}$ ° C. above the surrounding air, and the exhaustion carried to the  $\frac{1}{100000}$ th of an atmosphere, the layer will have a thickness of more than a decimetre, and the effect of the air will then be peculiar. If the gas is of such a density that the glass envelope is beyond the range of this action, the gas beyond the limiting distance will be cold, but if the effect reach the glass, conduction will take place to it. There will then be a procession of warm molecules towards the glass, where they will be cooled down, and form a number of cold, slow-moving molecules, which will go back to the disc and beyond it. And these processions will be intermixed with molecules taking no part in the action. In consequence of this, very few members will travel far in their paths; a portion of the motion of each, however, will be carried forward in the right direction. So long as these processions go on, the slow-moving molecules which reach the front of the disc are thrown off more vigorously than from the back. Prof. Stoney considers the pressure thus produced to be that measured by Mr. Crookes. With a pressure of the gas of  $\frac{1}{100000}$ th of an atmosphere, an elevation of temperature of  $\frac{1}{2}$ ° C. will produce the force actually observed, while if the exhaustion be carried to  $\frac{1}{100000}$ th the elevation of temperature necessary will be  $\frac{1}{2}$ ° C. Thus with the greater pressure a lower temperature will suffice, but other influences will then be brought into play tending in an opposite direction. It was pointed out that on this theory the action may be considered as closely resembling electricity, and Mr. Crookes has shown that the glass envelope is often itself slightly electrified.

PARIS

Academy of Sciences, March 13.—Vice-Admiral Paris in the chair.—The following papers were read:—Observations of the moon made with meridian instruments of the Paris Observatory during 1875, by M. Leverrier.—Second note on the transformation of nautical astronomy, through the progress of chronometry, by M. Yvon Villarceau.—Observations of temperature at the Muséum during 1875, with electric thermometers placed at depths of 1 to 36 metres in the ground; and *résumé* of ten years' observations, by MM. Becquerel. This *résumé* shows that the mean annual temperatures of the ten years increase regularly from 1 to 36 metres, at the rate of about one degree per 30 or 31 metres difference of level. An aquiferous sheet of 26 metres gave a slight excess of temperature. At 36 metres the temperature was constant and equal to 12°·42 (mean temperature at 1 metre = 11°·31).—On the silicification of platinum and of some other metals, by M. Boussingault.—On the flood of the Seine in February and March 1876, by M. Belgrand.—Observations on M. Resal's recent communication on steam-jacketing of engine cylinders, by M. Ledieu.—Note on water-pipes, by M. Boileau.—On the linear equations of the second order, of which the integrals are algebraic, by M. Jordan.—On the transit of Venus of Dec. 9, 1874, by M. Andriéu. The diameter of a star (of sufficient brightness) varies with the aperture of the instrument with which it is observed; the author verified this experimentally, and he draws some inferences relative to the transit observations.—On the eggs of Phylloxera, by M. Lichtenstein.—On a process of direct application of sulphide of carbon in the treatment of phylloxerised vines, by M. Allié.—Treatment of phylloxerised vines with sulphide of carbon introduced and diffused in the soil by means of an aspirating apparatus, by MM. Crolas and Jobart. An iron tube, with terminal apertures, is inserted in the ground; air is drawn off through it

by a pump, while sulphide of carbon is sprinkled over the surface; thus the vapour penetrates the soil. The cost is 320 francs per hectare.—On the employment of potash and of lime in treatment of the vine, by M. Demaille.—On the overthrow of the Grand-Sable at Salazie, by M. Vélain. The case was strictly analogous to that of landslips in Switzerland (not a volcanic phenomenon).—On a means of preservation against the accidents caused by fire-damp in mines, by M. Minary. The gas, being lighter than air, ascends, and M. Minary would make a series of vertical excavations in the roof to receive it, the apertures merely allowing the gas to enter and the air to escape. The collected gas could be drawn off to the surface by pipes. Should the gas in these reservoirs be largely mixed with air, he would place in them a system of porous tubes to separate it by endosmose, and these would be connected with the suction pipe.—Letter from M. Peters on the discovery of the planet (160) communicated by M. Le Verrier.—Observation of the planet (160) made with the garden equatorial, by MM. Henry.—Observations of same planet at the Observatory of Marseilles, by M. Borrelly.—On the approaching return to perihelion of the periodic comet of D'Arrest, by M. Leveau.—On polar auroras, by M. Planté. When the positive electrode of a strong secondary battery is brought towards the liquid surface of a vessel of salt water in which the negative electrode dips, you observe, according to its distance from the liquid, a corona of luminous particles round the electrode, or an arc bordered with a fringe of bright rays, or a sinuous line which rapidly bends to and fro on itself; the latter being especially similar to what one observes in auroras (like the undulation of drapery moved by the wind). Purple and violet tints appear as well as yellow. The liquid is greatly agitated, and steam rises more abundantly the further the electrode penetrates. Sound and magnetic perturbations are had, like those accompanying auroras. The negative electrode did not give the above phenomena, and auroras are probably due to a flow of positive electricity. Probably the imperfect vacuum in the upper regions plays the part corresponding to the negative electrode in the experiments, and the electricity comes from tropical regions.—Source of carbonic oxide, characteristics of formines, and of polyatomic alcohols, by M. Lorin.—On the canga of Brazil, and on the basin of fresh water at Fonseca, by M. Gorceix. Canga is a ferruginous conglomerate formed (according to the author) from *débris* of itabirites carried down by water, and cemented by ferruginous water.—On the causes which have brought about the retreat of glaciers in the Alps, by M. Gruner. From meteorological observations at St. Bernard, he finds that the period 1861-74, compared with the previous twenty years, shows an increase of mean temperature of 0°·92, a diminution of water of 0·204m, and, especially, a reduction of one-half in the falls of snow, 4·846m. instead of 10m. At Geneva, a similar change has been perceptible.—M. Cagnant called attention to a bed of kaolin at Saint Beaudelle, in the department of Mayenne. It would be well suited for manufacture of sulphate of alumina, which could be used for clarifying the Paris sewage water.

CONTENTS

	PAGE
FRENCH AND SWISS TROGLODYTES . . . . .	401
THE BOTHKAMP SUN OBSERVATIONS By Dr. ARTHUR SCHUSTER . . . . .	408
OUR BOOK SHELF:—	
Bennett's "Absorptive Glands of Carnivorous Plants" . . . . .	403
Calderon's "Volcanic Rocks of the Canaries" . . . . .	403
Letourneau's "Biologie" . . . . .	404
Loudon's "Algebra for Beginners" . . . . .	404
LETTERS TO THE EDITOR:—	
Coloured Solar Halos.—Dr. E. FRANKLAND, F.R.S.	404
On the Evidences of Ancient Glaciers in Central France.—Prof. A. VON LASAULX . . . . .	404
The Uinatharium.—Prof. W. H. FLOWER, F.R.S. . . . .	404
Morell's "Euclid Simplified."—J. R. MORELL . . . . .	405
"Weight" and "Mass."—J. J. WALKER . . . . .	405
The River-beds of the Riviera.—R. E. BARTLETT . . . . .	406
The Ocelli in Insects.—C. . . . .	406
The Recent Storm.—T. S. USBORNE . . . . .	406
OUR ASTRONOMICAL COLUMN:—	
Struve's Companion of Procyon . . . . .	406
The Total Solar Eclipse of 1883, May 6 . . . . .	406
The Minor Planets . . . . .	407
ON THE ACTION OF LIGHT ON SELENIUM . . . . .	407
THE LATE COL. STRANGE, F.R.S. . . . .	408
HUNTERIAN LECTURES ON THE RELATION OF EXTINCT TO EXISTING MAMMALIA, V. By Prof. FLOWER, F.R.S. . . . .	409
PROF. HUXLEY'S LECTURES ON THE EVIDENCE AS TO THE ORIGIN OF EXISTING VERTEBRATE ANIMALS, II. . . . .	419
PHYSICAL SCIENCE IN SCHOOLS. By Rev. W. TUCKWELL; Dr. ANDREW WILSON; W. N. HARTLEY . . . . .	412
NOTES . . . . .	413
REPORT OF THE CAMBRIDGE STUDIES' SYNDICATE . . . . .	415
SCIENTIFIC SERIALS . . . . .	417
SOCIETIES AND ACADEMIES . . . . .	418



THURSDAY, MARCH 30, 1876

## BLASIUS ON STORMS

*Storms; their Nature, Classification, and Laws, with the Means of Predicting them by their Embodiments, the Clouds.* By William Blasius, formerly Professor of the Natural Sciences in the Lyceum of Hanover. (Philadelphia: Porter and Coates. London: Lockwood and Co.)

WHATEVER may be thought of this work as a contribution to the extremely difficult question of the theory of storms, its delightful "positiveness of statement born of conviction," makes it a very readable book; and, further, the fresh facts contained in its pages, collected in most cases with evident care, form a useful repository to meteorologists in the study of atmospherical disturbances. In matters pertaining to general meteorology, the author is less at home as regards his facts, such as when he states that the heat of the sun's rays scarcely penetrates an inch into the surface of the land in the course of a day. He is also at fault as regards the seasonal distribution of atmospheric pressure over the globe, and the extent over which the south-west monsoon spreads to westward off the coast of Africa.

A storm is defined to be "in general the movement of the air caused by its tendency to re-establish an equilibrium which has in some manner been disturbed, and we may call all such movements storms, whether they are gentle breezes or furious hurricanes, whether they are accompanied by more or less condensation of moisture or clouds, or even by none at all; in general the laws of the motion and changes of the wind in re-establishing an equilibrium must be the same, whether the action takes place in a greater or less degree" (p. 43), and the author "is certain that the storm is the conflict of air-currents of different temperatures, and that the barometric depression is the effect of their movement" (p. 5). Thus storms are considered in a very broad sense,—in fact, they are regarded as synonymous with the whole atmospherical movements, and the book is therefore an attempt to state the theory of the circulation of the atmosphere.

Since the disturbances which occur in the distribution of the temperature and humidity of the air are either vertical or horizontal, it follows that the equilibrium will be restored either by the setting in of ascending or descending currents of air, or by the setting in of horizontally-flowing currents. Observation affords abundant proofs of the existence of all these types of aerial movements. In accordance with this conception of atmospherical disturbances and consequent movements which follow, Prof. Blasius classes all storms under three heads, viz. :—1. *Local or vertical storms*, which are stationary and centripetal, being produced by the atmosphere tending to re-establish in a vertical direction an equilibrium that has been disturbed; the characteristic cloud being the cumulus. 2. *Progressive or lateral storms* which travel, being produced by the atmosphere tending to re-establish in a lateral direction an equilibrium which has been disturbed. This second class of storms are of two kinds, viz., *equatorial or north-east storms* (winter storms), which are produced by a warm current displacing a cool one to supply

a deficiency towards the poles, the temperature changing from cool to warm, the direction in which they travel being to the north-east quadrant, and their characteristic cloud being the stratus. *Polar or south-east and south-west storms* (summer storms), which are produced by a cool current displacing a warm one to supply a deficiency toward the equator, the temperature changing from warm to cool, the direction in which they travel being to the southern semicircle, and their characteristic cloud being the cumulo-stratus. 3. *Loco-progressive or diagonal storms* (tornadoes, hail-storms, sand-storms, waterspouts, &c.), which travel locally, are rotatory, and are produced by the atmosphere tending to re-establish the equilibrium of a polar storm which has been disturbed in the plane of meeting of the two conflicting currents by a peculiar configuration of the ground, their characteristic cloud being what the author calls the conus, instances of which are presented by the funnel-shaped cloud of waterspouts.

In the explanation offered of the most important of these classes, viz., the winter storms, their origin is attributed to an assumed distribution of atmospheric pressure from the equator to 80° lat. N., and to the polar and equatorial currents which result from this distribution of pressure, and which conflict with each other—the shifting of the atmosphere with the motion of the sun toward the north during spring and summer and toward the south during autumn and winter, taking place not regularly, but interruptedly, by repeated oscillations like the waves of the rising and falling tide. In the winter storm there is an area of lowest barometer marking the region where the equatorial current overlaps the polar current and the theatre of the cloud and rain which accompany the storm, with two regions of high barometer, one in front and the other in the rear of it. These three regions move forward thus :—The region of high barometer, which apparently moves far in front of the storm, is the receding polar current; the region of low barometer, the uprising current; and the region of high barometer, in the rear of the storm, the in-blowing equatorial current. It is asserted that the area of the storm, or the region of conflict between the equatorial and the polar currents, must assume the form of an ellipse, and not that of a circle, and that the air in a storm does not move around one centre, much less around the line when the *plane of meeting* of the polar and equatorial currents meet the earth's surface, but in straight lines from the circumference of the ellipse toward the region of the uprising equatorial current. The progressive velocity of the storm depends on the greater or less resistance with which the polar current opposes the displacing equatorial current, since the greater this becomes during the development of the storm, the more the plane of meeting must rise or approach a vertical position, and thus the progressive velocity of the storm be proportionally retarded.

It is unnecessary to follow Prof. Blasius through his theory of the atmospheric movements comprehending our winter storms, which we have stated as far as possible in his own words. It may be enough to point out that at least those regions of the globe with whose meteorology Prof. Blasius does not appear to be very familiar, present facts not in accordance with his theory, proving that storms do not necessarily arise from great currents which can be traced to equatorial or sub-tropical regions on the

one hand, and to polar regions on the other, or even to have had their origin in these regions; and that the idea of two great atmospheric currents having in storms a common *plane of meeting* (Begegnungs-fläche) is a mere supposition. Such statements as these: "The storm is the *conflict* of air-currents," and "the barometric depression is the *effect* of their movement," are, to say the least, altogether unwarranted in the present state of our knowledge.

The tornado is conceived as originating from the sultry calm felt before it, which is due to the conflicting of the two aerial currents, bringing about a state of equilibrium by the great compressive force they exert against each other. This equilibrium is disturbed by a particular uneven configuration of the earth's surface, and the disturbance produces the tornado. Leaving out of view the imagining action of conflicting aerial currents, it will be enough to point to the geographical distribution of tornadoes as disproving this theory of their origin.

Notwithstanding these very serious drawbacks, the book will repay perusal as being the production of one who not unfrequently gives evidence of acute observation, and who has thought out his subject for himself. The following may be given as specimens of what are repeatedly to be met with:—"Meteorology is fully as much a science of the earth's surface as of the air." "The wind changes, not by the veering around of one and the same current, but by a succession of different currents, blowing inwards." "Among the meteorological elements the real direction of the wind is the most difficult to arrive at, especially at observatories above cities or near mountains and coasts, and wind observations are therefore in general the least reliable." "The thermometer, as measuring a primary effect, is, with the hygrometer, at least as important as the barometer."

The theory of atmospheric movements remains still to be stated, and it needs scarcely be added that this cannot be done till we have a better knowledge than we yet possess of the physics of the atmosphere with its vapour, and of the merely mechanical effects of ascending, descending, and horizontally-flowing currents of air.

#### ANDERSON'S "MANDALAY TO MOMIEN"

*Mandalay to Momiën: A Narrative of the Two Expeditions to Western China of 1868 and 1875, under Col. E. B. Sladen and Col. Horace Browne.* By John Anderson, M.D., F.R.S.E., &c., Curator of Imperial Museum, and Professor of Comparative Anatomy, Medical College, Calcutta. With Maps and Illustrations. (London: Macmillan and Co., 1876.)

MANY details concerning the latter of the expeditions referred to in this volume have been made known in this country through the daily papers, in connection with the much-to-be regretted murder of Mr. A. R. Margary. Indeed, Dr. Anderson states that his work was suggested by the interest called forth by the repulse of the recent mission and the tragedy attending it. The principal object of both expeditions was to prepare the way for establishing an overland trade-route between Burmah and China, and thus save the delay and expense of a roundabout sea voyage. That the establishment of such a route is desirable from a commercial point of view

is maintained by all who have a knowledge of the circumstances, and in the meantime appears to have been frustrated by the machinations of native traders who think it their interest to shut out British enterprise from a field which is evidently capable of great development. This uncivilised shortsightedness will no doubt in the end be defeated, though in the meantime it has cost this country the loss of a brave and accomplished servant.

Dr. Anderson, who was medical and scientific officer to both expeditions, does not pretend to give in the present volume more than a narrative of the general work of the expedition; a full and illustrated report of the natural history results, is, however, we are glad to learn, in active preparation, and will be published by the aid of the Indian government. Meantime, in the very interesting narrative before us, numerous details will be found of value from a scientific point of view. Dr. Anderson has made use not only of his own notes, but to some extent of those of other members of the expeditions, and has evidently studied with care the results achieved by the French expedition from Saigon to Yunnan under Lagrée, Garnier, and Carné, as well as the literature of the subject generally. The result is that the reader will obtain a clear account of the British connection with the route referred to, and be in a position to understand the present state of affairs and future negotiations.

The real starting-point of the first expedition under Col. Sladen, was Mandalay, the capital of Burmah, which was founded by the present king only in 1853, but which is already a large and evidently well-constructed city. An interesting description of Mandalay, and of the royal court, and some of its customs, is given by D. Anderson. From this point the party sailed in a steamer up the Irawady to Bhamo, which is about thirty miles from the boundary between Burmah and Yunnan, and is the headquarters of the Chinese traders who seem at present to monopolise the trade between Burmah and Western China, and whose opposition had no doubt much to do with the difficulties encountered by both expeditions. After many troubles with regard to carriers the expedition left Bhamo and proceeded by Ponline, Ponsee, Manwyne and Nantin to Momiën, beyond which it could not proceed.

Yunnan was at the time in a state of anarchy caused by the rebellion of the Panthays, or Chinese Mohammedan population of this region, which added greatly to the difficulties and dangers of the expedition. Nevertheless, even from a commercial point of view, it seems to us much was accomplished, but probably more from a scientific point of view. The natural history results, we have said, are being prepared for publication, but in the present volume the geologist, and especially the ethnologist, will find a great deal that is valuable and interesting. Dr. Anderson has evidently taken careful notes as he journeyed along, and a somewhat minute description of the course of the Irawady and of the country on its banks, and its antiquities between Mandalay and Bhamo will be found in the work. There were so many delays between Bhamo and Momiën that Dr. Anderson had many opportunities of studying the country and the people, and these he evidently took ample advantage of. To the Kakhyens and Shans especially he paid great attention, and his account of these peoples must be considered a valuable contribution to ethnology.

The Kakhyens especially are a very interesting race. They inhabit the mountains on the border-country between Burmah and China, and Dr. Anderson considers them as cognate with the hill tribes of the Mishmees and agas. The name Kakhyen is a Burmese appellation, and the people are widely spread under other names, as Singphos, Kakoos, &c. They do not seem, however, to be a genuine aboriginal population in Burmah and Siam as so many hill-tribes are elsewhere.

“By their own account the hills to the north of the Tapeng, for a month’s journey, are occupied by kindred tribes. South of the Tapeng, they occupy the hills as far as the latitude of Tagoung, and, as mentioned, were met with on our voyage near the second defile. To the east, they are found occupying the hills, and, intermixed with the Shans and Chinese, almost to Momien. Here they, as it were, run into the Leesaws, who may be a cognate,

which exists among these half wild tribes, reminds us strongly of that which prevailed in the Scottish Highlands in the so-called “good old times,” before the abolition of the hereditary jurisdictions. They have many curious superstitions and customs, which Dr. Anderson describes with great minuteness. Everything in “the heavens above, the earth beneath, and the waters under the earth” seems to have its particular “nat” or spirit; “every accident or illness is the work of some malignant or vindictive one of ‘these viewless ministers.’” The will of these “nats” is consulted by means of a medium, who works himself up into a state of great agitation, so as to become “possessed.” The Kakhyens are not very bold warriors, though they are great braggarts, and very troublesome to deal with. They are altogether a very interesting people.

With regard to the wide-spread Shan race, also, many details will be found in the volume, the result both of Dr.



Kakhyen Men.

but are not an identical race. The two chief tribes in the hills of the Tapeng valley are the Lakone and Kowrie or Kowlie, but numerous subdivisions of clans occur. All are said to have originally come from the Kakoos’ country, north-east of Mogoung; and Shans informed us that two hundred years ago Kakhyens were unknown in Sanda and Hotha valleys. To give one instance of their migrations. The Lakone tribe have at a very recent period driven the Kowlies from the northern to the southern banks of the Tapeng. A Lakone chief, having married the daughter of a Kowlie, asked permission to cultivate land belonging to his father-in-law; receiving a refusal, he took forcible possession, and drove the Kowlies across the river to the hills where they now dwell.”

The Kakhyens are divided into numerous tribes or clans, between which there does not appear to be any strong common bond of union. Indeed, in very many respects, the system of government, if it may be so called,



Kakhyen Matrons.

Anderson’s own observation and of the observations of previous explorers. The Shans of Yunnan belong to the Tay-Shan or Great Shans of the Tai-race, the branches of which, under different names, are found extending to the eleventh parallel, their various states being tributary to Siam, Burmah, and China. The Shans of Burmah have become closely assimilated to the Burmese in all respects; the Yunnan Shans are the remnants of the Shan Kingdom of Pong, conquered by the Chinese in the fourteenth century, and which included part of Burmah.

“The Shans proper of these valleys are a fair race, somewhat sallow like the Chinese, but of a very faintly darker hue than Europeans, the peasantry, as a rule, being much browned by exposure; they have red cheeks, dark brown eyes, and black hair. In young people and children, the waxen appearance of the Chinese

is slightly observable. The Shan face is usually short, broad, and flat, with prominent malars, a faint obliquity and contraction of the outer angle of the eye, which is much more marked in the true Chinese. The nose is well formed, the bridge being prominent, almost aquiline, without that breadth and depression characteristic of the Burman feature. The lower jaw is broad and well developed; but pointed chins below heavy, protruding lips are not infrequent. Oval faces laterally compressed, with retreating foreheads, high cheek-bones, and sharp retreating chins, are not infrequent; and the majority of the higher classes seemed to be distinguished from the common people by more elongated oval faces and a decidedly Tartar type of countenance. The features of the women are proportionately broader and rounder than those of the men, but they are more finely chiselled, and wear a good-natured expression, while their large brown eyes are very scantily adorned with eyebrows and eyelashes. They become much wrinkled by age, and, judging from the numbers of old people, appear to be a long-lived race. They are by no means a tall people, the average height for men scarcely reaching five feet eight, while the women are shorter and more squat in figure.

A minute account of these people, their manners, customs, dress, &c., is given by Dr. Anderson. Some of the ornaments worn by the women are of most artistic workmanship.

The latter part of the volume contains a clear account of the second expedition undertaken to open a trade route between Burmah and China, but which, as we have said, came to an untimely and sad end about a year ago in the murder of Mr. A. R. Margary. Dr. Anderson sets forth the whole circumstances with evident fairness, and yet it is difficult to say exactly who was to blame in the matter. That such a trade-route as it was attempted to establish would be of great advantage to all concerned, there is no doubt; and no doubt also it only requires time to establish it. There is yet a very great deal to be learned both with regard to the natural history of that part of the world, and with regard to the several interesting races of people which form its population. Dr. Anderson's work is a valuable contribution to such a knowledge, and the clear and straightforward manner in which he writes adds greatly to the intrinsic interest of the information with which his pages teem. The illustrations of the country and the people are charming, and the two maps enable the reader to follow satisfactorily the footsteps of the explorers.

#### OUR BOOK SHELF

*A Class-book of Chemistry.* By Edward L. Youmans, M.D. (London: Henry S. King and Co., 1876.)

"THIS book is not designed as a manual for special chemical students. It aims to meet the wants of that considerable class, both in and out of school, who would like to know something of the science, but who are without the opportunity or the desire to pursue it in a thoroughly experimental way. Such a class-book as the present . . . must be but a brief compendium of general principles and descriptions of the most important substances, and is not to be judged of by the fulness of its details." This extract from the author's preface sufficiently explains the objects which he has had in view in compiling the book before us. Certainly the work has no claims as a text-book for students; for the general reader we are afraid it will prove of little interest. Within the compass of about 350 pages we have an account of Gravity, Heat, Molecular Attraction, Electricity and Light, besides Chemistry

proper. Surely the day has passed when this kind of thing could be tolerated in a book which professes to teach science. People cry out against the teaching of science as a regular part of educational discipline. It is all very well in its own place, they say, but the only true mental training is to be derived from a study of classics.

If boys and youths devote years to the careful study of ancient languages, they can scarcely fail to receive at least some benefit. If, on the other hand, they pass rapidly through a course of training (?) in science, with the aid perhaps, of such a book as that before us, they quickly forget what they have learned, and, so far as mental training is concerned, they had better have left science alone altogether. Our chief objection to the present work is that it seems calculated, probably unconsciously calculated, to further the delusion that science is a thing to be taken up in a leisure hour, but not a thing the study of which requires, while at the same time it increases, every activity of the mind. If the study of science is to be made a discipline, that study must not be pursued in the spirit of Dr. Youmans' book. The student must not content himself with a superficial knowledge of a few facts, nor even with gaining one or two generalisations; he must be taught to amass facts on the basis of his own observation, to separate the more important from the less important facts, to classify these facts and at last to rise to a generalisation which shall enable him to group together and so explain what had appeared to be isolated phenomena. Dr. Youmans' book can afford the student little help in such a process as this.

Of course it must be admitted that there is a large class of people who have neither leisure nor inclination to make science a study, but who are nevertheless desirous, and properly desirous, of knowing something of what science has done and of the way in which she has accomplished her work. Such people will, we are afraid, receive but little enlightenment from the work we are noticing. There is just sufficiency of detail to make the whole subject appear uninviting, but not enough to make the book valuable to the student. The mass of isolated facts is too great for the ordinary reader; he would soon, if not bewildered, become fatigued.

A book designed for the purposes stated in the preface to the present work requires to be written more from the standpoint of some central idea, round which is grouped together such a number of facts as may serve to illustrate and enforce that idea. The relation of the facts to the general theory and of the theory to the facts may then be made the means of inculcating a certain amount of true scientific training.

While we thus complain of the general scope of Dr. Youmans' book, we must give the author praise for the manner in which some parts of his work are written, more especially the chapter on theoretical chemistry. The chapters on descriptive chemistry are exceedingly meagre in details, but pretentious in the ground which they appear to cover.

M. M. PATTISON MUIR

*Injurious Insects of Michigan.* By A. J. Cook, of the Michigan State Agricultural College. Fourth Report of State Board of Agriculture for 1874.

THIS useful and instructive pamphlet is to a great extent compiled from the writings of Messrs. Riley, Fitch, Le Baron, Walsh, Harris, Curtis, and Packard. It is illustrated by numerous woodcuts from the able pencil of the justly celebrated Prof. Riley, of Missouri. Its object is to enlighten farmers, gardeners, and fruit-growers of the State of Michigan, as to the general appearance, structure, and habits of noxious insects; at the same time suggesting means by which the increase of these pests to agriculture may be arrested. The "Colorado Beetle" and the "Grape Phylloxera" occupy a conspicuous place among these enemies of man.

The pamphlet winds up with a valuable hint to house-

keepers whose carpets are in danger from the attacks of the Clothes Moth. "Take a wet sheet or other cloth, lay it upon the carpet, and then run a hot flat-iron over it, so as to convert the water into steam, which permeates the carpet beneath and destroys the life of the inchoate moth."

LETTERS TO THE EDITOR

[The Editor does not hold himself responsible for opinions expressed by his correspondents. Neither can he undertake to return, or to correspond with the writers of, rejected manuscripts. No notice is taken of anonymous communications.]

Water-supply of the Metropolis

I HAVE no intention of entering into a controversy in your columns with my friend Dr. Frankland, but his letter in your impression of March 16 seems to require some reply.

When I made the remarks which are called in question by Dr. Frankland, I was careful to say that I might not unfairly be accused of having done so from interested motives, an admission of which no one who reads Dr. Frankland's letter can say that he has not taken the full advantage. I am not ashamed of my occupation, and am quite ready to admit another historical parallel afforded by Jack Cade, and confess that I, or those who have gone before me, "against the king, his crown, and dignity, have built a paper-mill." But, whether paper-manufacturers "in the exercise of what they call their rights" are polluters of streams or no, is a question into which I never entered, and is entirely beside the points which I raised.

These are in the main avoided by Dr. Frankland. The two Commissioners, a portion of whose report I criticised, and of whom it is as well to observe Dr. Frankland is one, recommend that the Thames and the Lea should be entirely abandoned as sources of supply for domestic use in London, and particularly refer to the Chalk in the neighbourhood of London, and not to the distant springs of the upper Thames as the future source of supply. In his letter to you Dr. Frankland states that "The Commissioners advise that the drinking water of London should continue to be derived from its present sources, but that it should be led away to its destination before it is mixed with the sewage of Oxford, Reading, Windsor, and other towns, and before it is fouled by the filthy discharges of paper-mills, and by other disgusting refuse." I presume that these two statements can be reconciled, but looking at the proposal that the water should be procured "within a moderate distance of London" the calculations as to the area of 849 square miles of Chalk and Upper Greensand within thirty miles of London, and looking at the enormous expense of conveying water more than thirty miles, I took that radius as representing the area out of which some district was to be placed under unnatural conditions with regard to its springs and streams, in order to supply our vast metropolis, which I am told it is contemptuous to term "overgrown." I never spoke of the fertile meadows of the Thames valley, about which Dr. Frankland makes merry, and I never intentionally alluded in the slightest degree to the main valley of the Thames, except to say that both below and above London there might be spots in it from which a limited supply of water might be pumped without much injury to the neighbouring property. My comments were intended to be confined to districts in which the proposal of the Commissioners could be carried out of sinking wells below the present spring-heads, and so constantly drawing upon them that there should be always a void below the level at which the drainage naturally escapes. If this does not mean the drying up of the streams by cutting away their natural sources of supply I shall be glad to know what it does mean.

If Dr. Frankland were as well acquainted as I am with the gravelly soil of some of the low meadows in Chalk districts, he would cease to be surprised at the possibility of their being converted into "arid wastes" by the abstraction of the water with which they are now charged up to within a very few feet of their surface. In the valley in which I live I have known the peaty soil above such gravel, even without the artificial abstraction of the moisture below, become during a dry summer sufficiently arid accidentally to catch fire and continue burning for days.

But then I am told that the wealthy City of London would be able and willing to pay for any damage it might inflict in procuring its water supply. I can only say that the word "compensation" does not occur in the Index to the Report of the Rivers Commissioners, and I have sought in vain for any allusion

to it in the text. Perhaps Dr. Frankland is not aware that at the present time the state of the law is such that even when compensation has been provided for by Act of Parliament, it has been held to be inapplicable in the case of wells being dried, on the ground that an action will not lie in respect of the loss of underground water, and therefore that no statutable damage has been inflicted.

As to the prescription for increasing the supply of spring water in a Chalk district by lowering the level of the subterranean reservoir, I may observe that in most of such districts floods are almost unknown, the soil being sufficiently absorbent to imbibe all the rain that falls, except when by chance the surface is frozen. The lowering of the water which, except in the valleys, is now usually from 100 to 200 feet below the surface, would make no difference in the receptive power of the soil on the hills, and could not be effected in the valleys without laying the streams, which now flow through them, dry.

As to London encountering the expense of a separate water supply for dietetic purposes, I can only say that if it can be effected for 2,000,000/., as suggested by Dr. Frankland, it will in my opinion be far cheaper than the plan the Commissioners advocate. It is as a rule more economical to make use of what we have, than to discard all existing appliances and commence on a new system. Perhaps the Water Companies may have a word to say on this point.

The concluding paragraph of Dr. Frankland's letter seems to have been written under some misapprehension. I distinctly stated that "if we refer to the headings of Organic Carbon and Organic Nitrogen there can be little doubt of the superiority of the Kent Company's water." I may, however, be under some misconception as to the statistics under the awful heading "Previous Sewage or Animal Contamination," in which, possibly, I do not stand alone. What I ventured to suggest was that the Commissioners on the Water Supply of the Metropolis, within whose proper sphere this question lay, were not altogether wrong in reporting, that with perfect filtration and efficient measures taken for excluding from the rivers the sewage and other polluting matter, the Thames and Lea would afford water which would be perfectly wholesome, and of suitable quality for the supply of the metropolis.

If this proved impossible, then I ventured to point out that there was already in London a sufficient supply of water of the kind recommended by the other body of Rivers Commissioners.

I must not, however, waste your space and your reader's time, but will in a few words mention my principal reason for taking up this subject, which, however, apart from any such reason, I considered would be of interest to geologists.

It was this, that in an otherwise admirable and exhaustive public report, measures were advocated involving in all probability great inconvenience and loss to large tracts of country, without, so far as I could see, one single reference to such loss and inconvenience. With the advocates of a private scheme such a disregard of injury to others would be reprehensible, though possibly not uncommon, but some greater consideration of the interests involved might fairly be expected from a public document.

JOHN EVANS

Nash Mills, Hemel Hempsted, March 18

Evidences of Ancient Glaciers in Central France

MANY lovers of natural history who have not the opportunity of seeing foreign scientific periodicals, may learn the advantage of taking such a paper as NATURE in the correspondence which was published between Dr. Hooker of Kew and the late Mr. Poulett Scrope, on the evidences of ancient glaciers in Central France.

The objections raised by Mr. Poulett Scrope, and the pleasure of examining such evidences as are adduced by Dr. Hooker, have induced me to accept the invitation of friends, who also enjoy such researches, to again visit Auvergne for the purpose of examining the Mont Dore valley for glacial traces, and I would gladly avail myself of any observations made by other geologists in that region, if they would do me the favour of sending me the notes of any localities to the address below.

In the meantime M. A. von Lasaulx, of Breslau University, claims the priority over Dr. Hooker in describing glacial traces in the *Ausland* periodical, in 1872, as occurring at the entrance of the "Gorge d'Enfer." I have also before me, as I write, a travelling note-book of Sir Wm. Guise, President of the Cotswold Naturalist Field Club (date, June, 1870), in which he refers

to observing "moraines," "ice-action," "boulders," and "*blot perchls*" in the same region.

My object in sending these lines to NATURE is to ask for notes of localities where glacial traces may be seen, as an aid to those who hope to examine more closely into the glacial phenomena of Central France.

W. S. SYMONDS  
Pendock Rectory, Tewkesbury, March 25

#### Metachromism

A FEW words of explanation may seem necessary after Mr. Ackroyd's observations (NATURE, vol. xiii. p. 385) on my previous letter regarding the above subject.

The question as to whether a change of composition can be said to *produce* or to *accompany* changes of physical properties, is a matter of words which the chromium series does not affect, as the relative number of atoms of the two elements is the test of arrangement followed.

With regard to the two colour scales—one co-existent with alterations of composition, the other with alterations of temperature—I never wished to "criticise" Mr. Ackroyd's results, but solely to point out a resemblance which I had observed a few years ago, and which I was not aware that that gentleman had noticed. The two series need not necessarily be similar; and, whatever other reasons may exist for placing white in the ultra-violet, the question in hand is not whether the ultra-violet rays produce the same sensation on our eyes as a mixture of all the colours, but, Do the white compounds in question, when spectroscopically examined, *only* show the ultra-violet, leaving the rest of the range in darkness, or do they show a complete spectrum? If the first, then of course their place of classification would be in the ultra-violet; but if they give a whole spectrum (as the compounds do to which I referred), then they must be classed as having an average refrangibility greater than yellow light (because they have blue in addition to it), and less than blue light (because they have yellow also), for the centre of luminosity (on each side of which the total of light rays is balanced) falls in the green.

If we had only to deal with monochromatic substances, then of course the usual *pan-spectral* white would not need to be considered, and green (as Mr. Ackroyd says) would be the only appearance to be classed between blue and yellow.

Thus "the assertion that white comes between yellow and blue" does not "rest upon the colour relation found to obtain between the oxides of the alkali metals," though it is in accordance with the rule given on p. 347, in the six sets of the oxides and chlorides there mentioned; the sole case not agreeing with it being that of the chromium chlorides, which, however, may be accounted for.

As to the orange colour of  $\text{Na}_2\text{O}_3$ , as Miller does not mention any colour, Turner was referred to; and if he is in error, that one instance may be laid aside; in any case it does not affect the relative natural order of blue and white.

Bromley, Kent

W. M. FLINDERS PETRIE

#### Socotra

WHEN I wrote the letter to the *Times* about Socotra, alluded to in NATURE, vol. xiii. p. 414, I was not acquainted with the excellent topographical memoir on this island by Lieut. J. R. Wellsted, published in the Geographical Society's Journal for 1835 (Journ. R. Geog. Soc. v., p. 129). After perusing it I am more than ever of opinion that Socotra is well worthy of the attention of the naturalist, and may probably possess many most interesting indigenous plants and animals. Unless matters are very different from what they were in 1834, there can be little difficulty in exploring the island, and if, as we are told, it has really become British property, I trust we may not have to wait much longer for some information about its zoology and botany. "Socotran Aloes" and "Dragon's Blood" are at present almost its only known natural products, and Lieut. Wellsted mentions but one native animal—a species of Civet.

P. L. SCLATER

11, Hanover Square, W., March 27

#### Coloured Solar Halos

SOLAR Halos such as described by Dr. Frankland (NATURE, vol. xiii. p. 404), may be seen on about seventy-five or eighty days in the year, here, and are commonest in the spring, but it is extremely rare for them to be brightly coloured. I speak

of the ordinary solar halo of about  $22^\circ$  radius, but the great halo of about  $46^\circ$  radius, is always distinctly coloured, though not a common phenomenon. It is not the "murky atmosphere" of London that hides the colours of the ordinary halo; they usually do not exist, except dull red and orange, and perhaps a faint tinge of blue. This is owing to the great breadth of the halo, which causes the colours to overlap and mix together; here it is very seldom that the halo is narrow and the colours consequently bright, as they seem to have been when seen by Dr. Schuster (p. 394). I doubt whether the name "parhelia," which he gave them, is correct; I understand that term to mean mock suns (or a bright small portion of a halo), a phenomenon visible here on thirteen days in a year on the average.

I may add that though I am rather easily dazzled, I find no difficulty in seeing halos with the naked eye.

Sunderland, March 28

T. W. BACKHOUSE

#### "Euclid Simplified"

MR. MORELL'S defence is a curious one, and amounts to this: "If my book is a bad one I am not to be blamed, because I have copied from Amiot, Legendre, and others. If I have made blunders in derivations, &c., again I am not to blame, but to be pitied, because I could not employ better printers." As in our former notice we limited our remarks to a few only of the objectionable features in "Euclid Simplified," so, in our present notice, we shall select a few only of the points put forward in Mr. Morell's letter, though we may observe in passing, that we see no reason to retract any of our previous comments. We think that our readers will agree with us when we state our belief that Mr. Morell has utterly failed in most, if not in all cases, to appreciate the force of our objections. Mr. M. correctly quotes Dr. Wormell (pp. 78-81), but fails to see that his own statement is widely different; had he written "perpendicular to the straight line A A' through its centre" (p. 41), "perpendicular to A B through its middle point" (p. 42), we should not have found fault with him. Again, the reference to Mr. Gerard (p. 310) is not to the point; we can understand what is meant by a "segment capable of a given angle," but we still object to the term "capable angle." The revised definition of a *parallelogram* is now (see text and letter), "a quadrilateral of which the opposite sides are equal and parallel!" We did not object to the term *lozenge*, which is a well-known one, but to the way in which it was introduced.

We turned to Dr. Wormell's definition of *circumference* with some curiosity, and found that (with the exception of "plain" being printed for "plane") it was perfectly right, and that Mr. Morell had again failed to see the point in our citation of the schoolboy's definition. We contend that Amiot's sentence, as quoted by Mr. Morell, does not mean what Mr. M. makes it to mean. Dr. Wormell's use of G. C. M. is perfectly legitimate, but does not warrant, so far as we can see, the use of *R* for *right angle* (seeing it is conventionally applied to another purpose) unless, indeed, it be explicitly stated in the text that *R* is so used.

We said (p. 204) that in Theorem VI., p. 148, the reasoning is defective. Mr. Morell replies it "only errs by excess of proof." We will reproduce the "proof," and leave the decision to our readers. "The area of a trapezium A B C D is equal to the product of its height B E by the half sum of its bases A C and B D. Drop the perpendicular B E on A F, and *bisect it by line G H*. Produce the base A C to F, making C F = D B. Then the two triangles D H B and F H C which have for bases the base D B of the trapezium or C F = D B, and which have also the same height,  $\frac{1}{2}$  B E, are equal. The area of triangle F H C =  $\frac{1}{2}$  D B or C F  $\times$   $\frac{1}{2}$  B E; that of triangle D H B =  $\frac{1}{2}$  D B  $\times$   $\frac{1}{2}$  B E. These triangles, having equal angles, are therefore equal. But," &c. Upon this we remark, we are not told *how* G H is drawn—the pupil is to infer that it is parallel to B D. Now we must suppose H connected with B and F, and cannot assume that B H F is a straight line, hence, though triangles H F C, B H D are equal, it does not follow that angles F H C, B H D are equal, hence too we cannot assume A B F to be a triangle. But really we must apologise for taking up space with such elementary details. For Mr. Morell's benefit we give the following:—Produce A C to F, making C F = B D, join B F, cutting C D in H, then triangles C H F, B H D are equal, and triangle A B F = A B D C, &c.

Enough has been written on this, in its present form, objectionable book. At any rate we hope that any one who has



thought of introducing the work into school use on the strength of one or two hastily written commendations of it, will be induced in consequence of what we have written, to examine the work for himself. We feel confident that any competent geometer who opens the book at almost any page, will endorse our criticisms, and say "the half was not told." In brief, the definitions are faulty, the enunciations are faulty, the proofs are faulty, and the typography is faulty; if these things do not make a bad book we do not know what does. The defence is, "if the enunciations are loosely and inelegantly worded, Amiot must bear the blame which attaches in a greater degree to our translations of Euclid." Alas! poor Amiot! this is an unkind cut, Mr. Morell!

R. TUCKER

March 6

**Bullfinches and Primroses**

I HAVE a bullfinch which was hatched last summer after primroses were over. They were therefore quite new to him when I offered him the first I could get this season. He pulled it to pieces quite indiscriminately, biting stalk, flower, or calyx quite indifferently, and the same with a few more which were given to him at the same time. But since then he has often had a few at a time, perhaps twenty or thirty in all, and he now almost always bites out the lower part of the calyx, as described in NATURE, vol. ix. p. 482. Sometimes he bites a little too high up, but almost instantly tries again with better success. When that part is eaten he attacks the stalk rather than the corolla.

Last spring I offered primroses to four bullfinches belonging to friends. Not one seemed to pull the flower to pieces according to any method. Two of them I saw only once. Another (an old bird and somewhat shy), after being supplied with the flowers for several days, seemed as unskilful in picking out the tit bit as he was at first. The fourth was a young bird. His mistress was called away before she had heard what was the peculiarity for which I was watching. A few days later she told me she had been giving him primroses in the meantime, and had noticed that he ate only the green part. In those few days he had learnt the art of primrose eating, not indeed quite perfectly, but wonderfully well considering how little practice he had had.

C. A. M.

**Seasonal Order in Colour of Flowers**

It seems that Mr. Thiselton Dyer has thought fit to conclude the different observations made on this interesting subject by copying a part of Sachs's "Text-book." He will, I hope, allow me to point out to him the latest researches respecting the influence of light on the colour of flowers, published by E. Askenasy, in the *Botanische Zeitung*, 1876, Nos. 1 and 2. This author made experiments with several flowers which had sufficient food at their disposal, and found that some of his flowers changed their colour when placed in the dark, while it was not so with others. Therefore it cannot be said that light has no influence. The cause of this difference, observes the author, has as yet not been explained; other experiments will have to be made to clear up this point.

I think the colour of most flowers is a thing that by continued inheritance during a very long lapse of time has become almost constant, and cannot be changed in a few weeks or months. Long-continued experiments with the same flowers and their offspring would, perhaps, show more considerable changes than Askenasy found.

So much for the point referred to by Mr. Dyer.

As to the seasonal order itself, a continuation of Mr. Alexander Buchan's observations would be necessary, and probably also experiments with the several parts of the spectrum to which the flowers are to be exposed.

As this letter was written, I read that of Mr. Wm. Ackroyd (NATURE, vol. xiii., p. 366); doubtless every one will expect with great interest his following note.

J. C. COSTERUS

Amsterdam

**Plant Fertilisation**

SOME short time since I observed a rather curious case of plant fertilisation through the medium of insects, and thinking—as the subject is one which is attracting much attention from botanists at present—it might be interesting to some of your readers (more especially perhaps as occurring in this remote part of the world), I take the liberty of forwarding you the particulars in the hope that you can find a corner for them in your valuable journal.

Growing rather abundantly just on the coast here is a small shrub belonging, I believe, to the sub-order Coffese, having numerous small greenish flowers, the interior of the corolla tube filled with silky white hairs, and the style bent in a peculiar manner, so as to bring it to one side of the tube. I observed the anthers delusce before the flower buds open covering the stigmatic surface (which is simply a thickened continuation of the style) with pollen. I noticed that all the individuals of this species of shrub were visited by a kind of ant in large numbers, and as soon as a flower opened they began pulling out the hairs, lining the corolla tube, and often biting off the stamens also, in order to clear a way down to the nectar contained at the bottom of the tube. In doing so they often support themselves by clinging to the pollen-covered style with their posterior legs. The bend in the style which brings it to the side of the corolla tube prevents it from being an obstruction while they are obtaining the nectar, although, so eager are they to get it even to the last drop, that in a few old flowers I noticed even the style removed. The pollen keeps dry for a considerable time, so that cross-fertilisation is effected by the removal of pollen from the stigma of one flower to that of another.

We have here, therefore, several adaptations of structure and habit to ensure that end. The deluscence of the anthers while in the bud removes the pollen from a part of the flower where it would in all probability be wasted (when the ants bite off the anthers) to another part, where by a peculiarity in its structure, viz., the bend in the style, it is protected and transferred to other flowers. The hairs in the corolla-tube, by rendering the approach to the nectar difficult, and thus making the use of the style as a support needful, also increase the chances of cross-fertilisation.

M. S. EVANS

Durban, Natal, South Africa, Jan. 25

**The Visibility of Mercury**

PERHAPS some of your readers may, like myself, have been struck with the remarkable brilliance of Mercury to the naked eye on the evening of January 26. I scarcely ever remember to have seen the planet so well deserving the epithet *στίλβων*. Since April, 1858 I have noticed it twenty-one times with the naked eye at its evening apparitions. It seems difficult to reconcile the lament of Copernicus that he would die without seeing Mercury with the accounts of his life. The common reason given is, that it was always enveloped, to him, amid the vapours of the Vistula. But he did not pass all his life in that part of Europe. At one time he went to Bologna and stayed with Dominic Maria, a professor of astronomy in that place. After this he proceeded to Rome, where he was made professor of mathematics, and where we find him actually engaged in making observations about the year 1500.

The amateur may look out for Mercury near the western horizon, after sunset, about the following dates:—1877, Jan. 10, April 29; 1878, April 10; 1879, March 26; 1880, March 7; 1881, Feb. 20; 1882, Feb. 2; 1883, May 6; 1884, April 18; 1885, March 31; 1886, March 15.

Tycho Brahe, who could not have enjoyed a very favourable latitude for picking up the planet, gives us the following notes in his "Historia Cælestis":—

1585, Nov. 15.—"Apparuit hoc tempore matutino  $\delta$  tanquam rubricunda quædam stella secundæ magnitudinis et mediæ, quasi 2 et 1 magnitudinis."

1590, March 1.—" $\delta$  adamodum apparenter videbatur, instar stellarum primæ magnitudinis, adeo ut eam, quæ in dextro humero Orionis est, magnitudine visibili representaret. Si  $\delta$  diametrum visibilem feceris 23', non inconvenienter se habebit."

1596, March 15.—"Erat hæc vespérâ apprimè serenum et medicocriter tranquillum.  $\delta$  hæc vespérâ satis fuit conspicuus quippe cujus quantitas stellam inter primæ et secundæ magnitudinis referebat."

Measurements of the diameter of the planet are best obtained when it is seen in transit on the sun, of which there will be a very favourable opportunity for several hours on May 6, 1878. After this, it is doubtful whether we shall see Mercury on the sun again this century in England, as he passes off the solar disc on May 10, 1891, about half-an-hour after sunrise, and on Nov. 10, 1894, the ingress of the planet is only a few minutes before sunset. For a transit to be seen thoroughly from this country we must wait till Nov. 12, 1907, and Nov. 6, 1914, both of which will be visible throughout here.

SAMUEL J. JOHNSON

Upton Helions Rectory, Crediton, Feb. 21

How Typhoid Fever is Spread

THE case recently reported (NATURE, vol. xiii. p. 331) by Prof. Frankland from a Swiss village, where the poison of typhoid fever is said "to have filtered through a mile of porous soil, but which had nevertheless lost none of its virulent properties," is certainly so striking that some further reference to authorities seems requisite. If it can be satisfactorily proved that this was the most likely and reasonable origin of the case, it will give additional weight to every endeavour for preserving our water supply from every conceivable impurity; but unless based on the opinion of a competent and skilled investigator of such cases, it will lay us open to the charge of receiving any similar statement that favours our view, however rash. As medical officers of health it is our duty frequently to trace the origin of cases of this disease, and my anxiety to have further information of this case will thus seem reasonable, and I hope will meet with some reply from the distinguished professor.

J. MITCHELL WILSON

Rochdale, March

The Ash Seed Screw

MR. ALFRED GEORGE RENSHAW would like to know (NATURE, vol. xiii. p. 367) whether the pitch of the ash seed screw is that which would give most power to the propeller of a steamer.

There is no screw on the samara of the ash (*Fraxinus excelsior*) while it is green. The pitch of the screw, at the same date, differs on different trees, and also on different seeds of the same tree, and also on different parts of the same seed.

Why the wing generally becomes twisted as it dries is a very interesting question. But what seems to me the most remarkable fact about this phenomenon is, that in every case, and on all trees alike, the thread of the screw is in one direction; that direction being the same as in a cork-screw, or ordinary screw-nail.

All varieties of the wild oat (*Avena fatua*) and the fly oat (*A. sterilis*) have long awns, which also in the green stage are straight, but which in ripening become twisted. And in these also, the direction of the screw is uniform and the same as in the ash seed; but the pitch of the screw is variable.

Are these facts the same in other parts of the country? Are the screws left-handed on the south of the equator?

Summerhill, Aberdeen, March 20 A. STEPHEN WILSON

OUR ASTRONOMICAL COLUMN

THE COMPANION OF SIRIUS.—Mr. Wentworth Erck, of Sherrington, Co. Wicklow, in a communication dated March 21, notes the fact of a considerable diminution in the angle of position of the small star accompanying Sirius, which was detected by Alvan Clark in January, 1862—since the earlier measures, and adds that he cannot now estimate it at more than 55°. This retrograde motion is a consequence of the theory of Dr. Auwers, supposing the *comes* to be the cause of the anomalous proper motion of Sirius, which has formed the subject of several elaborate memoirs by this eminent astronomer. His last elements of the presumed disturbing body, adapted to the form of double star orbits, are as follow:—

T ... ..	1843.275	Excentricity ... ..	0.6148
Node ... ..	61° 57' 8"	Semi-axis ... ..	2".331
$\lambda$ ... ..	18° 54'.5	Period ... ..	49.399 yrs.
Inclination	47° 8'.7	Motion, retrograde.	

The following angles of position and distances are given by these elements:—

1862.0	Pos. 85.4	Dist. 10".10	1874.0	Pos. 65.5	Dist. 10".95
1865.0	" 79.9	" 10.78	1876.0	" 62.1	" 10.59
1868.0	" 75.0	" 11.15	1878.0	" 58.4	" 10.05
1871.0	" 70.3	" 11.20	1880.0	" 54.2	" 9.33

Dr. Auwers gives a comparison of his calculated angles and distances of the centre of gravity, with those of Clark's companion to 1867, the agreement being pretty close throughout. But there can be no doubt that the calculation has given the angle too great since that year.

The Washington observations show the following differences:—

1872.25	... Position (c-o)	+ 5".6	... Distance (c-o)	- 0".7
1874.18	... ..	+ 6".3	... ..	- 0".7
1875.24	... ..	+ 7".2	... ..	- 0".7

In the above orbit the limits of distance are 2".31 at 1841.84 for a position of 302°.5, and 11".23 at 1870.13 for position 71°.7, and Auwers remarks that under the former condition the angle changes one degree in ten days, while under the latter condition 233 days are required for the same diminution.

Our correspondent mentions that Lassell's "new star" (Mem. R. Astron. Soc., vol. 36, p. 18), "though exceedingly faint, was distinctly visible. Pos. circa 130°, distance circa 75," with 7½ inches aperture power, Mr. Lassell, 1865, January 14, found the position 127°.0, distance about one minute.

Dr. Gyliden, from the meridian-altitudes of Sirius, observed by Sir Thomas Maclear at the Cape of Good Hope during the years 1836 and 1837 found for the annual parallax of the star  $\sigma^{193}$  (*Bulletin de l'Acad. de St. Petersburg*, t. vii.). Adopting this value, Dr. Auwers finds for the mean distance between the companion and Sirius, 37 times the earth's mean distance from the sun, and for the masses of Sirius and companion 13.76 and 6.71 respectively, in units of the sun's mass. The parallax  $\sigma^{193}$  corresponds to 1,068,700 times the sun's distance from the earth.

D'ARREST'S COMET.—M. Leverrier's *Bulletin International* of March 18, contains the definitive elements obtained by M. Leveau for the next return of this comet to perihelion in 1877, with an ephemeris for every 20th day throughout the year, which sufficiently defines the circumstances of the next appearance. The whole of his long-continued investigations relating to the motion of this comet have been conducted by M. Leveau with extreme care and minuteness, so that by his investigations, in continuation of those commenced by M. Villarceau, the theory of D'Arrest's comet has been placed upon a similar footing of accuracy to that, upon which the theory of the periodical comet of Faye now stands through the labours of Dr. Axell Möller of Lund.

The next perihelion passage of D'Arrest's comet is found to occur 1877, May 10.339 M.T. at Paris, and the comet appears to attain its maximum intensity of light about a fortnight subsequently. Other elements of the orbit which apply to 1877, Jan. 14, are:—

Longitude of the perihelion	... ..	319 9 15	M. eq.
" " Ascending Node	... ..	146 9 28	1880.0
" " Inclination	... ..	15 43 9	
" " Excentricity	... ..	0.6278048	
Logarithm of perihelion distance	... ..	0.1199444	
		Motion direct.	

The elements usually found in catalogues of cometary orbits are here substituted for others given by M. Leveau.

The semi-major-axis of the orbit is 3.54139, to which corresponds a sidereal revolution of 2434.2 days.

When this comet was last observed by Herr Julius Schmidt at Athens, on December 20, 1870, the intensity of light was 0.154; the greatest intensity attained in 1877, about May 26, is only 0.22, and it is certain that large telescopes will be required for the proper observation of the comet. When theoretically brightest, it rises at Greenwich less than two hours before the sun, and as this difference increases towards the end of the summer, the intensity of light is diminished by one-half. The comet will be nearest to the earth in the middle of October (distance = 1.40). M. Leveau promises in a subsequent communication a precise ephemeris for the whole year, and, it may be remarked, it very rarely happens that there is any necessity for predictions extending over so long a period.

PROF. HUXLEY'S LECTURES ON THE EVIDENCE AS TO THE ORIGIN OF EXISTING VERTEBRATE ANIMALS<sup>1</sup>

III.

IT will be necessary to preface our remarks as to the origin of the next highest group of Vertebrates—that of Reptiles—by some account of the distinction between them and the Amphibia, and by some observations on what zoologists mean by the terms “higher” and “lower” as applied to animals or groups of animals.

In external form there is little difference between such a reptile as a lizard, and such an amphibian as a newt, and there seems, at first sight, to be no reason why they should be placed in different primary groups. In former times, as a matter of fact, the essential difference between reptiles and amphibians was not seen, and the two were united into a single class; but modern researches have shown that, beneath this external similarity, lie great and important differences, the chief of which we must now consider.

In the first place, no reptile, at any period of its life, possesses gills, and, in consequence, the breathing of air dissolved in water becomes impossible. Nevertheless, reptiles, in common with all the higher animals, have, at one period in their existence, slits leading from the throat to the exterior, in precisely the same position as the branchial clefts of an amphibian, but functionless.

Secondly, certain organs, known as “foetal appendages,” are developed in connection with the young animal before it leaves the egg, and serve a temporary purpose in its economy. In the possession of these appendages, as well as in the absence of gills, reptiles agree with birds and mammals, and differ from fishes and amphibians.

The young reptile is produced from an egg of relatively large size, and consisting of a considerable mass of yolk, surrounded by a quantity of transparent “white” or albumen; the whole being invested by a hard or soft shell. The yolk does not divide as a whole, but the process of division is confined to a small patch on its surface; in fact, the reptilian egg answers to the amphibian egg, plus a quantity of additional matter, called accessory, or food-yolk, which is unaffected by the process of yolk-division. It is the small superficial patch, answering to the whole amphibian egg, which is converted into the body of the young reptile, the accessory yolk becoming gradually smaller and smaller, as its substance is used up in the nourishment of the embryo; in the meantime it forms a bag attached to the umbilicus of the embryo, and hence called the *umbilical vesicle* or yolk-sac; it is the first of the foetal appendages, and the only one which occurs in any vertebrate below a reptile, being possessed by certain fishes.

After the embryo has attained a certain size, and has come to lie, like an inverted boat, on the yolk-sac, a fold grows up, all round it, from the surface of the yolk, and, the edges of the fold coming together above, a bag is formed enclosing the embryo into the interior of which a watery fluid is secreted, in which the little creature lies. This natural water-bed is called the *amnion*; it is the second of the foetal appendages, and no trace of it is to be found in any fish or amphibian.

The third and last of these curious embryonic appendages, the *allantois*, grows out from the tail-end of the embryo as a pear-shaped body, solid at first, but soon converted into a sac, which extends round the embryo and yolk-sac, immediately beneath the membrane of the shell. The cavity of the allantois acts as a receptacle for the nitrogenous waste of the embryonic body, but its chief function is as a respiratory organ; for this purpose it is supplied by blood-vessels which form a close network

over its outer layer, and the blood contained in these coming into close relation with the external air, through the porous shell, readily exchanges its carbonic acid for the atmospheric oxygen.

As the embryo grows, the yolk-sac becomes smaller and smaller, and is eventually completely drawn into the interior of the body of the young reptile, which by this time completely fills the shell. In many cases a horny knob is developed on the nose, and, with this, the now ripe embryo breaks the shell from the interior; the amnion and other membranes are burst, the allantoic circulation is stopped, the first inspiration is taken, and the little creature is born.

There are several minor points in which reptiles are distinguished from amphibia, amongst which we will only mention the articulation of the skull to the first vertebra by one condyle instead of two, the presence of a bone called the *basi-occipital* in the hinder part of the skull floor, and the fact that the branchial apparatus is reduced in the adult to the small *hyoid* bone or cartilage, which supports the tongue.

In what respects is a reptile a higher organism than an amphibian? When one animal is said to be higher than another, one of two things may be meant: its structure may be more complicated, as a carved platter is higher than a simple trencher; or its parts may be so arranged as to form a more complicated mechanism. The mere repetition of parts does not raise an animal in the scale; a worm with a hundred segments is no higher than one with ten, any more than a mill with ten pairs of stones is a higher kind of machine than one with a single pair. But if, instead of multiplying the number of millstones, two pairs only were used, one of which was adapted for coarse, the other for fine grinding, a machine of a far higher order would be produced, and it is a similar differentiation of parts for special uses and co-adaptation of structures to given purposes which raises an animal above its fellows.

Judged by this standard, a reptile is a decidedly higher animal than an amphibian; its skeleton, for instance, is a better piece of work, the joints being more neatly finished, and the whole mechanism much more perfect.

A third test is based on the facts of development. We saw that a frog, in the course of its development, went through a stage in which it was, to all intents and purposes, a fish, and that it was only after passing through this stage, as well as that of a branchiate amphibian, that it attained its higher adult character. Now the reptile stands in just the same relation to the amphibian, with regard to its development, as the amphibian to the fish. During the earlier stage of its growth it presents certain amphibian characters, such as the presence of gill-clefts; but these lower stages are passed over; the reptile goes beyond the highest amphibian in its development, and is therefore, in this respect also, to be considered as a higher animal.

At the present day there are four types of reptiles: the lizards (*Laartilia*), snakes (*Ophidia*), turtles and tortoises (*Chelonia*), and crocodiles (*Crocodylia*). We will now direct our attention to the first of these groups.

Most existing lizards have four well developed limbs, a long tail, a scaly armour, sometimes supplemented with plates of bone, and teeth, not set in distinct sockets, but firmly fixed to the jaw. The skull is so constructed that the hinder nostrils open far forwards into the mouth. The vertebrae have a peculiar and characteristic form, their articular surfaces being concave in front and convex behind, except in the Geckos or wall-lizards, and that remarkable New Zealand genus *Hatteria* or *Sphenodon*. The heart is composed of three chambers, two auricles and a single ventricle, the latter being again partly divided into two, and thus showing a slight advance on the amphibian heart, in which the ventricle is quite single.

Lizards are very abundant, especially in hot climates;

<sup>1</sup> A course of six lectures to working men, delivered in the theatre of the Royal School of Mines. Lecture III., March 13. Continued from p. 412.

most of them are land animals, a few only being inhabitants of fresh water, and one—the genus *Amblyrhynchus* of the Galapagos Archipelago—lives on the seashore, and, if hard pressed, takes to the sea.

Through the whole of the Tertiary epoch the lizards are essentially the same as those now existing. Some of the Secondary species, also, have the same characters, but in the chalk are found, in addition, strange marine lizards, such as the genus *Mosasaurus*, which attained a length of 30 feet. As far back as the Purbecks, the lizards have vertebræ like the existing kinds, but on descending to the Solenhofen slates we find abundant remains, which present the lower character of bi-concave vertebræ, and the same is true of all the still older forms, such as the *Telerpeton* of the Triassic sandstones of Elgin and the Permian *Protosaurus*.

Thus the older lizards have a slightly simpler structure than those of the present day, but resemble them, on the whole, so closely, that we must conclude our existing forms to have been derived from the ancient ones, and have no need whatever to assume their special creation. Lizards, then, offer another example of what is meant by a persistent type.

A remarkable instance of this persistence is afforded by a case of quite the same order as that of *Ceratodus*, described in the first lecture. The *Hatteria*, mentioned above, differs from all other lizards in many particulars. Its jaws are armed with a horny beak, and its upper jaw has two rows of teeth, one on the maxillary, the other on the palatine bones; the teeth of the lower jaw bite between these, like a pair of scissors with a double upper blade. The vertebræ are bi-concave, and, along the belly, are placed a number of bony plates.

No other existing form whatever is known presenting these characters, but, about the year 1858, a number of fossils were discovered in the sandstone of Elgin, and amongst them the remains of a large lizard with bi-concave vertebræ, abdominal plates, a horny beak, a double row of upper jaw teeth, and, in fact, altogether like the existing *Hatteria*.

The crocodiles are the only other reptiles the history of which it will be possible to notice in this course. Two of the most important characters by which they are distinguished from lizards are, the lodgment of the teeth in distinct sockets and the position of the hinder nostrils or posterior nares. The maxillary, palatine, and pterygoid bones are so disposed as to form a remarkable shelf or partition in the roof of the mouth, thus bringing the posterior nares to the hindermost part of the throat. The soft palate forms a veil in front of these apertures, and hangs down so as to rest on the back part of the rudimentary tongue, and thus, except when the animal is swallowing, entirely shuts off the cavity of the mouth from the air passages. This arrangement has been prettily explained by the crocodile's habit of killing its prey by drowning; it is said that it can hold a captured animal under water, while its own nostrils—placed at the end of the long snout—are just above the surface, and thus is enabled to breathe freely, the air passing through the posterior nares, behind the veil of the palate, and so to the lungs, while its prey is being suffocated. This is an admirable explanation as far as the crocodile is concerned, but, unfortunately, it is probably untrue, for precisely the same arrangement is found in the Gavial and other crocodilians which live upon fish.

(To be continued.)

#### PHYSICAL SCIENCE IN SCHOOLS

PROF. ROSCOE has taken the right view when he says that science teaching in schools will remain unsatisfactory as long as it does not receive the same range and time as the subjects which at the present time

preponderate so greatly. Granting the necessity of devoting more time to science, it follows, almost as a matter of course, that science teaching ought to begin at an earlier age than now. For else, where is the time to come from? The other alternative—to add a couple of years to the time required to pass through the present curriculum of a public school—would be accepted by very few parents. But there is no need for this alternative. The teaching of the elements of physical and chemical knowledge is most beneficially begun in early years. Some of the foremost thinkers of the scientific world assert and support this view, as may be gathered, for instance, from the *Scientific Report of the Royal Commission on Science Teaching*. I would mention, in addition to this, that Liebig strenuously advocated ("Chemische Briefe," Leipzig und Heidelberg, 1865, 50th letter) the teaching of such elementary chemistry in *village schools* as bears upon the constitution of air, water, the ash of plants, and explains the process of combustion. The great German philosopher would hardly have done so, without being sure that the pupils will profit by the teaching. The average age of such a pupil is, I believe, twelve years, and he receives, as far as I am aware, no preparatory instruction in algebra or geometry.

It is surprising to find a man of the educational eminence of Mr. Wilson battling against early science teaching. I am inclined to ascribe his opinion on this matter to an incomplete view taken by him of the true significance science teaching has. Mr. Wilson considers the study of physical science as a means of developing merely the reasoning faculty of a boy, leaving out of sight the equally important function of calling forth and sharpening the faculty of *observation*. As for reasoning alone, certainly, the languages, and still more, mathematics, afford at least an equally good basis. It is just the circumstance that a sound teaching of science shows to the young mind the difference between evidence as resting (wholly, or to the greatest extent) on the *teacher's statement*, and evidence based on *facts put actually before the pupil*, which makes the study of science so valuable from a general educational point of view.

Early beginning of science teaching suggests itself for yet another reason. Everyone, with but the least experience in educational matters, knows that in order to be successful in instruction, one must repeatedly go over the same ground during the curriculum of a boy's education, and gradually expand the subject in the repetition. Why, then, shall not science, if it is to enter organically into the education of a boy, and not be merely tacked on to him, receive the same treatment? Let a boy at the age of ten or eleven begin with witnessing all the experiments which are usually performed in illustrating those sections of Chemistry and the science of Heat, that are required from the candidates of the London University Matriculation Examination. Let the boy become thoroughly acquainted with the *facts*, and let at this time as little theory be placed before him as possible. After such a course, which might be made to fill up two years, there should be a pause in the study of these branches of science for a year, or even two, before allowing the pupil to resume the same in a fuller and more theoretical way. The hours gained might be given to mathematics. Of course it would be out of place to give here anything like a programme of how the above idea should be realised; I must just content myself with throwing out the hint. After the initiatory course the pupil will be in better condition to follow later the theoretical parts than he is under the present system, where he has to overcome simultaneously the novelty of the facts and the difficulties of the theory.

Science acquired in this way will be very different from that which is hastily got up in the last six or eight months of a boy's stay in the school, and mostly, too, under the pressure and anxiety which accompany the preparation for some examination, say the London University Matriculation.

The scientific culture which pervades the educated classes of Germany is usually ascribed to the efficiency of the Universities ; I believe it would be more correct to put it down to the sound education in scientific matters which the boys receive in the public schools, for it is only the smaller number who proceed to the Universities : the majority go after commercial and industrial pursuits.

R. GERSTL

University College School, London

**ON DETERMINING THE DEPTH OF THE SEA WITHOUT THE USE OF THE SOUNDING LINE<sup>1</sup>**

THIS is the title of a paper which has been presented to the Royal Society, and Mr. Siemens gave at the meeting of the 24th ult., a description of the instrument which he has designed with this object. He commenced by giving a mathematical statement of the effect of local attraction, to a certain depth, on a body placed at the surface of the earth, assuming it to be of uniform density, spherical in form, and unaffected by centrifugal action. For small values of depth (*h*), this attraction is  $2\pi h$ , the original formula from which this is adduced is :—

$$2\pi h \left(1 - \frac{2}{3} \sqrt{\frac{h}{2R}}\right),$$

and by substitution of  $2R$  for *h* in this, Newton's statement of the total attraction  $\frac{4}{3}R\pi$  is obtained.

Now, if in place of the solid substance which forms the exterior crust of the earth, whose density may be taken to be the mean density of superficial rock, water, a material of less density is substituted, it is shown that the total attraction must be diminished, and the measure of this diminution is a measure of the depth of light substance which has been substituted for heavy. If we were in possession of the exact mean density of the earth, of that of the surface-rock, and of sea-water, a scale could be calculated beforehand, to show what depth would agree with a certain diminution of the measured effect of gravitation. Such an approximate calculation was made in designing the instrument, but Mr. Siemens has preferred to compare the readings of the instrument with actual soundings, in order to obtain a scale.

The instrument which is called a bathometer is represented in the accompanying illustration, and consists of the following parts : a weight being a column of mercury affected by variation of gravitation, a counterbalance being springs unaffected by variation of gravitation, and an arrangement by which the variations in gravitation can be read as depth in units. The column of mercury is maintained in a vertical steel tube having cup-like extensions, the lower portion being closed by a corrugated diaphragm of thin steel plate, and the upper portion containing an aperture for filling the instrument, having a screw stopper. The internal diameter of the tube is reduced at the upper portion, in order that the vertical oscillations of the mercury produced by the motion of a vessel in a sea-way, may be reduced to a minimum, and the instrument is suspended in a universal joint above its centre of gravity, so that it may always hang in a vertical position at sea, and is enclosed in an air-tight casing so that it may not be under the influence of atmospheric changes. The weight of the column of mercury is balanced at the centre of the diaphragm by the elasticity of the steel springs, and the *modus operandi* of the instrument is evident ; as the mercury diminishes in potential through the effects of diminished attraction, the action on the springs diminishes, and these shorten upon themselves.

There are some peculiarities in the mechanical arrangement of the instrument which repay examination. Both ends being open to the air, its indications are not

By C. William Siemens, D.C.L., F.R.S.

affected by variations of atmospheric pressure. With regard to temperature, the instrument is *parathermal*.

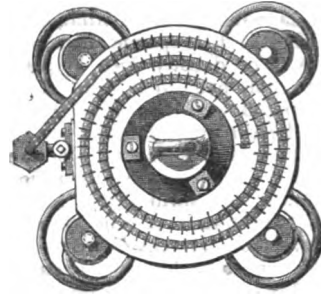

Its peculiar form has been the result of scientific inquiry. It was first discovered by experiment that well-tempered

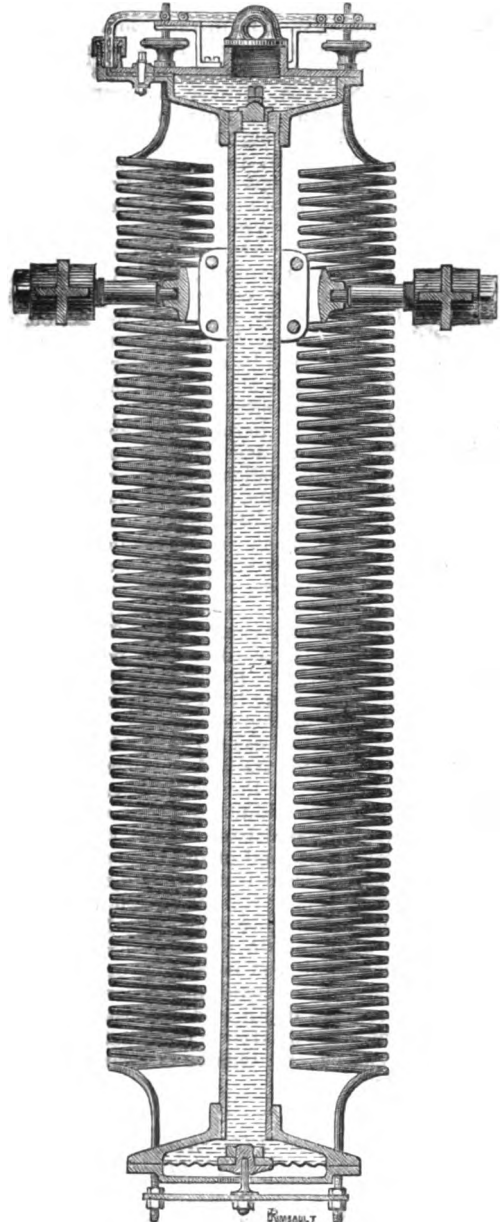

steel springs diminished in potential with rise of temperature in a constant ratio, it was therefore necessary that

the potential of the mercury should diminish in the same ratio. Mercury contained in a tube of uniform section would always have the same potential, for as it expanded and lengthened by heat, its specific density would diminish, and the product of density into height would remain constant. If contained in a tube of infinitely small diameter, compared with the diameter of the cup-like extensions, the height would remain constant, whilst the potential would diminish in the ratio of the expansion of mercury, but this is different from the ratio of the diminution of potential of the springs, and in order that these ratios may be accordant, or in other words that the equilibrium of the whole system may be the same at all temperatures, the peculiar form has been employed represented in the illustration, which is between the two forms already referred to.

The amount of the variation of gravitation with variation of depth is exceedingly small, and requires some method for indicating it. The method employed in the results hitherto tabulated and presented with the paper is by means of electrical contact, which is established whenever a sounding is to be taken, between the centre of the steel diaphragm and the end of a micrometer screw, which is at other times insulated from the body of the instrument. The screw is of such pitch, and the circular plate which turns with it has divisions so proportioned, that each division represents a depth of one fathom.

The readings of the instrument have been compared with soundings taken by means of Sir Wm. Thomson's steel wire sounding apparatus, and the accordance between the two is very satisfactory, especially as the bathometer, from the very nature of its action, gives a mean of the surrounding depths, whilst the sounding-line gives the actual depth below the ship. The reading of the instrument is also effected by means of a spiral glass tube, connecting by means of liquid, less dense than mercury, with the mercury in the upper cup; this arrangement has lately been tried and found to work successfully. The instrument is also available for the measurement of height; in mountain ascents, however, the elevated land will influence its readings, and allowance would have to be made for the effect of this local attraction.

The chief disturbing element in the use of this instrument is the effect of latitude, which will have to be ascertained approximately before its readings can be accepted as true indications of the depth. The difference between the total attraction of the earth at the pole and on the equator amounts to  $\frac{1}{130}$  of its effect at the equator, the rate of increase in travelling from the equator to the pole being as the square of the sine of the latitude. The amount of this variation is easily calculable in fathoms of depth, to be tabulated for use with the instrument.

The principal value of the bathometer would be to serve the mariner as an additional means of determining his position when he was debarred from taking astronomical observation on account of the state of the weather. If the contour of the ocean bed were laid down on charts more perfectly than it is at present, and if these were in the hands of the mariner, he would be able to tell from his bathometer what was the depth of ocean below him, and whether that depth was increasing or decreasing in pursuing his course; he could also observe the rate of increase or decrease of depth, and in consulting his chart he would be enabled to determine his actual position with considerable accuracy, and thus be forewarned of the approach of danger.

#### PHOTOGRAPHY OF THE RED AND ULTRA-RED END OF THE SPECTRUM

IN 1874 Dr. Vogel communicated to the scientific public that he had been able to photograph the least refrangible rays of the solar spectrum by using what are known as the Uranium Dry Plates prepared by the

Uranium Dry Plate Company. At the same time he experimented with other bromide plates, using dyes to give them distinctive tints. He then enunciated that the sensitiveness of the plates for the hitherto unphotographed portion of the spectrum was due to the colours employed, and apparently all his efforts have been diverted in elaborating this idea. Last summer I commenced a series of similar experiments to see whether the discovery could be made of practical use in photography; and have arrived at the conclusion, that the colouring matter gives this extended sensitiveness owing to the compound of silver formed and not to the colour itself, in fact, that the tint given to the film necessitates a very prolonged exposure. The additions of resins, nitro-glucose, and other similar compounds containing carbon to the bromized and bromoiodized collodion soon convinced me that it was the organic salts of silver to which we must look for sensitiveness in the yellow red and ultra-red rays of the spectrum. Nearly every resinous body seems to prolong the photographic spectrum towards the ultra-red, and one or two in particular, also when the film is least colourless when viewed by transmitted light, that then it is probably in the most impressionable condition. Another point which is worthy of notice is, that a film dried from moisture, taking, in fact, the form of a dry plate, is always most readily acted upon by the ultra-red end of the spectrum. Probably this is due to the absorptive qualities possessed by the silver nitrate solution, and not really from an increased sensitiveness of the compound salts when dry.

If ordinary pyroxylin be employed for the collodion it is generally less suitable than if it contain a certain quantity of nitro-glucose, or other similar body; and it frequently happens if this be absent entirely that the photographic spectrum will stop short near  $\delta$ .

Taking a collodion made with pyroxylorin prepared at high temperatures and using the ordinary solvents (in the alcohol of which suitable resin and bromides are dissolved), it will be found in general that when the silver salts formed through them by the sensitizing bath, or by emulsifying them by direct addition of silver nitrate to the collodion, are presented to the action of the spectrum, the whole of it will be impressed with a developable image. With three prisms of  $60^\circ$  and one of  $45^\circ$  twenty minutes is sufficient exposure to give when the slit is nearly closed, a lens of four feet focus being used as the objective.

When this is overcome it will be possible (and I hope shortly to do so) to present a complete photographic map of those lines which lie beyond A to a distance at least equal to D - A, a point beyond which I have not as yet been able to obtain an image. The great difficulty to be encountered is that of finding a sharp focus for the different points of the invisible spectrum, the change in length from one point to another being very rapid.

Uranium and iron salts have also furnished me with spectra which are well worthy of notice. With the latter salt more especially the action of the heat-rays is very decided, though at present it seems to me that the exposure must be very prolonged.

I propose at a later date to give details of all the most interesting of these experiments sufficient to enable anyone to repeat them who may desire to do so.

W. DE W. ABNEY

P.S.—It may be as well to state that the best results with resin plates have been obtained when a modification of alkaline development has been adopted.

#### RAOUL PICTET'S SULPHUROUS ACID ICE-MACHINE

THE countries between the 40th degrees of N. and S. latitude have in general too temperate winters to admit of natural ice being obtained in any quantity; and yet these are the countries in which it is most required.



The high price at which it is sold prevents many people from buying it. It is for the purpose of rendering the supply of this useful and healthful article abundant and cheap that ice-making machines have been devised. These are of three classes, of which we shall give a brief account in order to show the advantages of the new invention, due to the ingenuity of a young Genevese physicist, M. Raoul Pictet.

The first class comprises the Ammoniacal Machines. These are based on the principle, applied by M. Carré, of the solution of ammonia in water. A saturated solution of ammonia is introduced into a boiler which is heated to  $140^{\circ}$  or  $150^{\circ}$  C. The ammonia is disengaged under strong pressure, and is liquefied in a condenser washed by a current of ordinary water. The liquid ammonia flows into the refrigerator, where it is evaporated and it returns into the liquid in a gaseous form. The evaporation is the source of the cold, which may be made very intense.

In order to work an apparatus of this kind, it is necessary that the first operation be effected, *i.e.*, the liquefaction of the ammonia in the condenser. For this purpose it is necessary that the pressure in the boiler correspond to the tension of ammonia vapour, at the temperature of the water of condensation,  $30^{\circ}$  C. at least in warm countries. This pressure is raised then to fifteen or eighteen atmospheres, an enormous pressure, liable to great danger.

Under so great tension the gas traverses cast-iron walls of two centimetres, the joints leak, not being air-tight, and the ammonia rapidly escapes from the apparatus. The alkaline solution must then be constantly renewed, which is very costly. There is another inconvenience. The fire under the boiler causes deposits, which, increasing day by day, give rise to the danger of an explosion. The fear of such a catastrophe demands constant watchfulness.

In countries less warm, with a water of condensation at  $20^{\circ}$ , the tension of the ammonia hardly exceeds eight atmospheres. In these circumstances the Carré machine works well and produces economical results. But in such countries natural ice is abundant, and the service rendered is consequently of less value.

The second class includes the Ether Machines. Sulphuric ether was first employed for the manufacture of ice in England. A large pneumatic pump draws up the vapours of ether, which are formed in a tubular refrigerator, and compresses these vapours in a condenser bathed in spring water. The evaporation may also freeze the water contained in the tanks, while the compression of the vapours and their condensation in the condenser transfer to the spring-water all the heat freed from the water in the tanks, transformed into ice. A pipe allows the condensed ether to return to the refrigerator, and be again subjected to volatilisation.

These machines, more simple than the ammonia ones, are, however, less workable. Ether is a liquid of small volatility, and gives only weak tensions. At  $-4^{\circ}$  or  $-5^{\circ}$  C., this tension varies from 4 to 8 centimetres of mercury according to the quality of the ether. The cylinder of the pneumatic machine must then be of considerable dimensions in order to draw up a small weight of ether and produce a limited amount of cold. The whole of the first half of the machine works with an almost complete vacuum, but if the joints, the walls of the tubes, and the caulking of the cylinder are not perfectly hermetic, atmospheric air will enter the apparatus; and should the manometer show that it is present to the extent of one or two centimetres, the evaporation of the ether will be arrested. With the smallest amount of air present the machine becomes unworkable; a hole no larger than a pin-point is sufficient to paralyse the half of its normal product.

Another inconvenience arises from the fact that ether

is not a body perfectly constant in its chemical characteristics. Under the action of frequent changes of condition, of frequent volatilisations and condensations, it becomes acidified and transformed into less volatile isomeric bodies. On this account it is necessary frequently to change the active liquid, which is very troublesome and expensive.

Lastly, the greases with which the piston of the cylinder is lubricated form a close mixture with the ether, a mixture which is carried into all the apparatus, and which also tends to trammel its regular working.

The third kind, Compressed Air Machine, is the least workable of all, and has invariably failed on trial. Its principle is as follows:—Air is compressed in a large cylinder to nearly three atmospheres. This compression raises the temperature of the air to about  $150^{\circ}$  C. A current of water cools this air, which enters cold into a second cylinder, where it expands from three atmospheres to the ordinary pressure. This work which it produces upon a second piston is equal to the deduction of the original work, for the two cylinders are joined *en suite*, and are worked by the same rod. The air which is expanded lowers the temperature, and gives the second cylinder about  $60^{\circ}$  of cold. This air may be utilised to manufacture ice, or to cool cellars, apartments, &c.

This machine, in order to work well, requires large cylinders and close-fitting pistons with very little friction, a perfectly regulated introduction into the expansion cylinder, and orifices, valves, and flaps without a flaw. But these conditions are almost impossible to realise in practice. A piston of large size, travelling in a cylinder under a temperature from  $-50^{\circ}$  to  $-60^{\circ}$  C., is an abundant source of friction, for it is only imperfectly lubricated by glycerine. A thick coating, produced by the solidification of the vapour of water in the expansion cylinder, is also a cause of accident and trouble in the working. Lastly, the smallest derangement in the aspirating or compressing valves of the first cylinder puts an entire stop to the production of cold. These machines, therefore, are absolutely unequal to the practical solution of the problem.

A machine capable of easily performing the work must comply with the following five essential conditions:—1. Too great pressure must not occur in any part of the apparatus. 2. The volatile liquid employed ought to be so volatile that there will be no danger of air entering; *i.e.*, the pressure must be at least one atmosphere in order to be in equilibrium with the external pressure. 3. It is necessary to have a system of compression which does not require the constant introduction of grease or of foreign materials into the machine. 4. The liquid must be stable, it must not decompose by the frequent changes of condition, and it must not exert chemical action on the metals of which the apparatus is constructed. 5. Lastly, it is necessary, as far as possible, to remove all danger of explosion and of fire, and for this reason the liquid must not be combustible.

If we examine the series of liquids investigated by M. Regnault, only one will be found to satisfy these essential desiderata; this liquid is sulphurous anhydride,  $\text{SO}_2$ .

In fact, this body is liquid under the atmospheric pressure at a temperature of  $-10^{\circ}$  C., and it does not give pressures higher than four atmospheres at a temperature of  $35^{\circ}$ . This liquid does not act on metals or fats; it is not combustible, and is the least expensive of all known volatile liquids. By the process of manufacture discovered by M. R. Pictet, it costs less than sulphuric ether.

Thus, by taking advantage of the general principle of the evaporation of a volatile liquid to produce cold, and utilising sulphurous acid, we can obtain a machine which gives results constant in every country, and which acts in a perfectly mechanical and normal manner in all latitudes. The following is a brief description of a typical

machine, manufacturing 250 kilogrammes of ice per hour :—

A cylindrical tubular copper boiler has a length of 2 metres and a diameter of 35 centimetres ; 150 tubes of 15 millimetres traverse its entire length, and are soldered by their extremities to the two ends. This first boiler is the refrigerator. It is placed horizontally in a large sheet-iron vat, which contains 100 tanks of 20 litres each. An incongealable liquid, salted water, is constantly circulating in the interior of the refrigerator by means of a helix. This liquid is re-cooled to about  $-7^{\circ}$  in a normal course, and it licks on its return the sides of the tanks which contain the water to be frozen.

In the space reserved between the tubes of the refrigerator, the sulphurous acid liquid is volatilised, its vapours are drawn up by an aspirating force-pump, which compresses them without the condenser. This condenser is a tubular boiler, the same as the refrigerator ; only a current of ordinary water passes constantly into the interior of the tubes to carry off the heat produced by the change of the gaseous into the liquid state of the sulphurous acid, and by the work of compression. A tube furnished with a gauge tap, adjusted by the hand once for all, permits the liquefied sulphurous acid to return into the refrigerator to be subjected anew to volatilisation.

Sulphurous acid has the exceptionally advantageous property of being an excellent lubricant, so that the metallic piston which works in the cylinder of the compressing pump requires no greasing. Thus the introduction of foreign matter into the apparatus becomes entirely impossible.

The work necessary to manufacture 250 kilogrammes of ice per hour is at the most seven-horse power.

A cold of  $7^{\circ}$  in the bath is amply sufficient to obtain in the tanks a rapid and in every way economical congelation.

With these mechanical arrangements the following important advantages are realised :—1. The pressure never exceeds four atmospheres. 2. There is never any entry of air to fear, the pressures, as far as  $-10^{\circ}$  C., being always above that of the atmosphere. 3. The volatile liquid employed is perfectly stable, undecomposable, and without chemical action on metals. 4. All greasing in the machine is dispensed with. 5. The volatile liquid is obtained at a very low price, and it is accompanied by no danger of explosion or fire. 6. The cost of production of the ice approaches infinitely near to the theoretic minimum : it is about 10 francs per ton of ice.

By means of all these advantages the practical problem of the manufacture of ice may be considered as solved for all climates, and the process of M. Pictet will not fail to be speedily adopted in all warm countries as soon as it becomes known ; it is in such countries that its happy results will be specially utilised and appreciated.

A small specimen of M. Pictet's machine will be shown at the forthcoming Loan Exhibition of Scientific Apparatus at South Kensington.

#### APPARATUS FOR DEMONSTRATING THE TRANSFORMATION OF FORCE

IN a recent number of the *Journal de Physique*, M. Crova describes a convenient apparatus for showing the relations between heat, electricity, and mechanical force. The arrangement is as follows :—

Two of Clamond's thermo-electric generators are connected in surface, and put in communication with a Gramme machine in such a way as to set this in action. In the circuit is inserted a sort of electric lamp, in which a platinum wire placed in the centre of a small globe (which protects it from agitation of the air) can be raised to incandescence. The only difficulty of the experiment consists in so regulating the length and diameter of the

platinum wire as that it may be raised to a red heat, while the thermo-electric current retains sufficient intensity to drive the Gramme machine. A circuit entirely metallic then is obtained, with which the following transformations can be effected :—

1. The Gramme machine being excluded from the circuit, a portion of heat, transformed into electricity by the thermo-electric pile, reappears in the state of heat in the platinum wire.

2. The platinum wire being excluded from the circuit, and the Gramme machine introduced, a portion of heat, transformed into electricity in the pile, produces mechanical work in the machine, which acts as a motor.

3. The platinum wire and the machine being included in the circuit, a part of heat, transformed in the pile into electricity, produces heat in the wire and work in the motor. If we then stop the motion of the Gramme machine, we find the incandescence of the platinum wire increased. The machine being liberated, on the other hand, is set agoing again, and the incandescence of the platinum wire diminishes in proportion as the motion is accelerated. In this way is rendered sensible to the eye the expenditure of heat necessary to develop an increasing quantity of mechanical work.

4. Taking the handle of the machine, we turn it in the direction of the rotation the current produces, but with an increasing velocity. In this way a velocity is reached such that the incandescence of the wire completely disappears.

5. If the handle be turned in a direction opposite to that of the rotation the current communicates, there is considerable resistance, and the incandescence of the wire increases rapidly ; on turning more quickly, the wire is fused. Thus, in the metallic circuit under consideration, the circulation of a given quantity of energy may appear exteriorly in the form of heat or of mechanical work, the one of these quantities being the complement of the other. If by an exterior force we introduce into the circuit an additional quantity of work, the increase of the quantity of energy put in circulation is rendered visible by the incandescence of the wire ; any communication outwards from the circuit, of a certain quantity of energy which circulates in it, appears, on the other hand, in diminution, or even disappearance, of the incandescence.

#### NOTES

LORD SALISBURY, on Monday, named the following as Commissioners under the Oxford University Bill :—Lord Selborne (Chairman), Lord Redesdale, the Dean of Chichester, Mr. Mountague Bernard, Sir Henry Maine, Mr. Matthew White Ridley, and Mr. Justice Grove. The feeling among scientific men is one of intense disappointment, leading to the conclusion that it is useless any longer to consider whether Oxford will ever be in a position to do anything for the promotion of science.

THE report of the Cambridge Board of Mathematical Studies to the Studies' Syndicate contrasts with the reports of most of the other boards in the paucity of its suggestions for improvement. They do not seem to think that very much is required in order to perfect the system of mathematical teaching. They believe in the probable stability and development of the system of inter-collegiate lectures, but say very little to assist its development, and they say nothing about the present vehement competition by means of private tuition, and the defective method of study that it induces. In answer to the question how University teaching may be organised so as to give the greatest encouragement to the advancement of knowledge, "the Board offer no suggestions under this head." Is this quite what might have been expected in a report bearing the signatures of Stokes, Cayley, Adams, Clerk-Maxwell, Sir W. Thomson, Tait, Lord

Rayleigh, and James Stuart? May there not be some unobvious explanation of this phenomenon? The whole report consists of only forty-one lines.

THE *Daily News* of Thursday last contains a letter from its *Challenger* correspondent, giving an account of the voyage from Valparaiso to Monte Video between December 10 and February 16. Most of the work of this cruise was done among the islands on the South American coast between the Gulf of Penas and the Straits of Magellan, and at the Falkland Islands. A considerable number of soundings were taken, and successful hauls made; the naturalists landed on several islands and made collections of specimens. This is the first part of the last section from Valparaiso to England, when the work of the ship will be completed.

MR. W. Spottiswoode, F.R.S., has been elected a corresponding member of the French Academy of Sciences, in the Geometrical Section.

ON the 21st inst. a fine bronze statue of the late Lord Rosse, erected in the principal street of Parsonstown, was unveiled. It is described as one of the latest and best of Foley's works.

GEOLOGICAL Time was the subject of Prof. McKenny Hughes' lecture at the Royal Institution on Friday evening. He told the audience that "A wise man before building a structure first examined the nature of the foundation," and he then proceeded to inquire into the nature of the evidence upon which the calculations have been made, as to the rate of denudation of valleys, the wearing back of sea coasts, the growth of peat-mosses, and the deposition of alluvium. He endeavoured to show by means of examples of exceptional phenomena, happening at long intervals and lasting for indefinitely short periods, that such calculations were utterly fallacious, and concluded by comparing our position to that of a "man in a cockle-shell boat, trying to sound an almost unfathomable ocean, firstly, with too short a line; secondly, with too heavy a weight; and lastly, with a weight so light that he was perfectly unaware when he touched the bottom." "To doubt," a great biologist tells us, "is the first principle of modern science," but in life, as in art, there are lights as well as shadows, and geological time is so intimately connected with the history of life upon our globe, and with the knowledge we possess of past denudations that have produced those missing leaves in the chapters of the earth's life history that geologist's call unconformities, that we venture to think that though we may not have reached the bottom of the deeper oceans, yet we have certainly sounded some of the most shallow seas. We therefore look forward with pleasure to hearing another lecture from Prof. Hughes, in which drawing on his abundant resources, he will leave the negative for the positive, the unknown for the known, and show us step by step the lights modern science has already thrown on the great cosmical, physical, and biological changes that are involved in the term "Geological Time."

AT the meeting of the Vienna Geological Society, on March 7, Mr. Hauer read a letter dated Manila, Jan. 11, 1875, from Dr. Drasche, who has been staying at the Philippine Islands since December 8 last, and intends to remain there for about six months longer for the purpose of investigating the active volcanoes and obtaining some knowledge of the geological composition of the island of Luzon. Four considerable excursions have been already made—1. To the plain of Pampanga, with the ascent of the Arayat and the Cordillera of Zambales. 2. The southern shore of the Laguna de Bey, ascent of the extinct volcano Maquilin, and a visit to the solfatara Tierra Blanca. 3. Ascent of the volcano Tael. 4. River Poray and Cueva de San Mateo. The wide fertile plain in which Manila lies is composed of clay strata recently raised from the sea, abounding

with such species of fossils as are still living in the neighbouring sea. The plain is bordered by a range of hills, consisting of pumice-tuff. On the higher mountains behind these there are found trachytes and andesites, besides the tuffa. Of special interest among these is an amphibole-andesite, containing a great deal of olivine, that composes the Arayat. It is the most basic eruptive rock that Dr. Drasche has noted as yet on the isle of Luzon, and belongs probably to a more ancient volcanic period. On the Arayat, which had been hitherto considered as an extinct volcano, neither eruptive matters nor any other signs of distinct volcanic action are to be discovered. Near the River Poray there were found, besides greenstone-trachytes and conglomerates, large masses of a white limestone, partly crystalline and containing fossils, chiefly fragments of corals. When Dr. Drasche despatched his letter he was about to undertake a journey of two months to the wild northern regions of Luzon that have hardly ever been visited by geologist as yet.

DR. PARKES, whose death at the comparatively early age of fifty-six years we announced last week, was a man whose loss will be felt in many circles of society; he had connections with many scientific bodies, and, we believe, was universally known, beloved, and admired in the medical profession, for the scientific advancement of which he did so much. He served the State in various capacities throughout his life, but is specially known in connection with the Army Medical School, which owes a great part of its efficiency to his exertions and example. He had had a good training in scientific investigation, and his application of the principles of science to the conduct of research in his own department led to valuable results. Dr. Parkes was elected a Fellow of the Royal Society in 1861, and his contributions to its proceedings have been numerous and of high value. Among these we may mention his three papers on the Effects of Diet and Increase in the Elimination of Nitrogen during Muscular Action; in 1870, 1872, 1874, he also contributed papers on the Effects of Alcohol on the Human Body. Dr. Parkes, indeed, seems to have been a model of what a scientific physician should be, and to this he joined a character that attracted the love of all who knew him.

LETTERS received in Sydney from Signor D'Albertis, the Italian naturalist, we learn from the *Times*, who has been for some time resident on Yule Island, on the coast of New Guinea, give further accounts of the belt of coast land, twenty to twenty-five miles in width, of which he is able to speak, and so much of the land beyond this limit as was visible from the summit of a hill about 1,200 feet high. From this eminence he saw a large extent of plains, indented with lagoons, with the River Amama (the Hilda of the *Basilisk*) flowing downward from a northerly direction to its junction with the Nicura, which discharges its waters into the sea. Apparently, this stream is deep enough to be navigable far into the interior, but its channel is seriously obstructed by fallen timbers. He ascended the Nicura River for a distance of eighteen or twenty miles, and found it fringed with mangroves for the first ten miles, after which these gave place to splendid thickets of the Nipa palm, while the eucalyptus and the grass tree flourish at some distance from the stream. He crossed the Amama several times, and describes it as flowing through a large and fertile valley, apparently uninhabited, and well adapted for pastoral purposes. Nowhere did he find the natives possessing any knowledge of gold, silver, or any other metal. He confirms what has been said by Mr. Wallace and other travellers as regards the island being peopled by two races, the one mentally and physically superior to the other; the invaders having driven the indigenous tribes into the interior. The earlier inhabitants of New Guinea have darker skins than their conquerors, are shorter in stature, and their countenances are more prognathous than those of the coast tribes. The western

side of New Guinea appears to be chiefly inhabited by the indigenous Papuans, and the eastern by a superior race.

THE mail steamer *Congo* arrived at Madeira on Saturday with Lieut. Cameron on board; his health is perfectly restored. The *Congo* left Madeira the same afternoon, and is expected to arrive in England during the present week. Sir H. Rawlinson announced to the Geographical Society on Monday that it is proposed that Lieut. Cameron should appear at the next meeting of the Society, and as it is expected that the audience will be unusually large, the meeting will be held in St. James's Hall on Tuesday week, April 11.

AT the last meeting of the Geographical Society Capt. Anderson, R.E., read a paper on "The North American Boundary from the Lake of Woods to the Rocky Mountains." Capt. Anderson was chief astronomer of the North American Boundary Commission.

THE most important paper in the last (February) part of the *Bulletin* of the French Geographical Society is the first part of Dr. Nachtigal's account of his travels in Central Africa in 1869-74. M. H. Duveyrier has a paper on Lieut. Cameron's trans-African journey, and the account of Abbé David's second exploring journey in the West of China, and M. J. Codine's paper on the Portuguese discoveries on the Western African coast in 1484-8 are continued.

WE have received the first number of *La Revue Géographique Internationale*, whose proposed fortnightly appearance we announced recently. It is a well-printed quarto of sixteen pages, and starts with a very promising programme. The most notable paper is on Ancient Geographical Monuments of the Tenth and Eleventh Centuries, by M. E. Cortambert, being a notice of the principal maps of that time which have reached us. Under the heading of "Courriers de l'Extérieur" letters from correspondents in various parts of the world are published.

INTELLIGENCE from Kasan announces that the German Exploring Expedition to Western Siberia has arrived there.

THE state of Mount Vesuvius was reported by the *Daily News'* correspondent on Sunday to have been unchanged. Prof. Palmieri wrote from the Observatory on Saturday: "Smoke is still abundant. There is a reflected glare at intervals from the fire within the crater. No lava has yet made its appearance." No immediate eruption is, however, expected.

THE annual meeting of the Iron and Steel Institute was commenced on Tuesday in London, and will be concluded on Friday. The Bessemer Medal for 1875 was presented to Mr. R. F. Mushet. To-day the Council will be entertained at dinner by the Lord Mayor, at the Mansion House.

M. FRIEDEL, an able mineralogist, has been appointed Professor to the Museum of Natural History of Paris, to fill the place vacated by the retirement of M. Delafosse. It is to M. Delafosse that is due the admirable arrangement of the Gallery of Mineralogy in the Museum.

THE Lords of the Committee of Council on Education have given directions for a course of instruction in Botany to be delivered at South Kensington, commencing about the middle of June, 1876. This course will be given by Prof. Thielton Dyer, M.A., B.Sc., &c. It will consist of a daily lecture, with practical instruction in the Laboratory, and will extend over about eight weeks. A limited number of Science Teachers, or of persons intending to become Science Teachers, will be admitted to the course free of expense. They will also receive their travelling expenses to and from London, together with a maintenance allowance of 30s. per week while attending the course. The hours of attendance will be from 10 A.M. to 4 or 5 P.M.

A "VICTORIA and Albert Palace Association" has just been formed. It is intended, if the consent of the Government can be obtained, to build a palace on the banks of the Thames, near Battersea Park, for the "health, recreation, and instruction of the metropolis," combining "the amusements of the Crystal Palace, the pleasures of the Albert Hall, with the instruction and benefits furnished by the Kensington Museum." It is hoped that the palace will be opened on May 1, next year.

AN International Exhibition is to be held in Paris in 1878 or 1879 at latest.

THE *Bulletin de la Société des Sciences d'Alger* for 1875 contains interesting papers on the ethnology of the Barbary races, by M. J. A. N. Perrier; and the geography, ethnography, geology, zoology, and archaeology of Algeria, by Prof. Jourdan. Meteorological tables are appended, giving the observations made from three to five times daily, the barometric observations being made unfortunately with an aneroid, by which their value is much lessened.

A COURSE of Twelve Lectures on Geology, free to the public, will be delivered in the large hall of the London Middle Class School, Cowper Street, Finsbury, on Tuesday and Friday evenings, at eight o'clock, commencing April 4, by Dr. W. B. Carpenter, C.B., F.R.S.

PROF. RUBENSON has published in the *Transactions* of the Royal Academy of Sciences at Stockholm, a discussion of the rainfall of Sweden, with five plates, from the observations made at twenty-nine stations from 1860 to 1872. From this discussion we learn that Göteborg is the wettest, and Kalmar the driest station; that in advancing from S.W. to N.E. the line of maximum precipitation passes from Göteborg to near Gefle, and that as regards seasonal distribution, the maximum is assimilated to that of continental Europe, occurring generally in July and August, and the minimum to that of the eastern part of Great Britain, south of the Grampians, occurring in March and April. Two valuable tables are added, one giving the monthly means at places at which long-continued observations have been made, and the other the annual averages for the twelve decennial periods, beginning with 1751.

IN the *Bulletin International* of the Observatory of Paris, P. Denza gives an interesting notice of a comparison of the barometers at fifty-five of the Italian stations, made by him during 1870-75. The comparison was made in each case with the normal barometer of the Observatory at Moncalieri, whose error had been ascertained by comparison with the standard of the Paris Observatory through that of the Observatory at Turin.

WE have received the meteorological observations made at the Naval Hydrographic Office at Pola for January last. This number is the first of a new series giving the hourly observations of the barometer, thermometer, and anemometer, including both direction and force of wind, together with the daily and hourly averages for the month. The position of Pola on the comparatively confined basin of the Adriatic gives a peculiar value to these hourly observations.

IN the *Quarterly Journal of the Meteorological Society* appear, among other matters, a paper on the rainfall at Calcutta for the twenty-eight years ending with 1874, by Mr. R. Strachan, in which the main facts are carefully summarised and tabulated in a useful form; a description of a self-regulating atmometer, by Mr. S. H. Miller; and a short paper by Mr. William Marriott, on the reduction of barometric observations, with a table for combining the corrections for index error, temperature, and altitude. The table will facilitate the work of reduction, and is sufficiently exact for most practical purposes for which such tables are required, and may be used in preparing observations and means for the press, provided the observations and means themselves be also printed uncorrected for height.

**EXPERIMENTAL RESEARCHES ON THE EFFECTS OF ELECTRICAL INDUCTION, FOR THE PURPOSE OF RECTIFYING THE THEORY COMMONLY ADOPTED<sup>1</sup>**

THE theory generally adopted in treatises on Physics and Electricity to explain the fundamental fact of electrical induction in an insulated cylinder A B, acted on by an electrified body C, is as follows:—It is admitted that on the extremity B of the induced cylinder, that is, the extremity next to the inductor C, is found only the electricity opposite to that of the inductor; while on the rest of the same cylinder is found only electricity similar to that of the inductor. But these two opposite electricities are both supposed to be endowed with tension, consequently they ought to be divided by a neutral line. When it is wished to represent in a graphic manner the electrical distribution

indicated, obtained by induction upon the cylinder A B, this is done by means of Fig. 1. In this figure A B represents the induced and insulated cylinder, c the positive inductor, a b the neutral line, a p b the negative induced electricity, which may also be called induced electricity of the first kind, and a q b the positive electricity, or induced electricity of the second kind.

It is obvious that the explanation commonly adopted for electric induction cannot hold for the following three reasons:—1. Because, as the two opposite electricities possess tension, they ought on that account to neutralise each other as they are present on a conducting cylinder. 2. Because in putting into communication with the earth the extremity B of the induced cylinder, upon which extremity it is admitted that the homonym of the inductor is not found, nevertheless that only is dissipated, while the opposite electricity, which is found on the same extremity, remains there entirely, notwithstanding its communication with the earth.

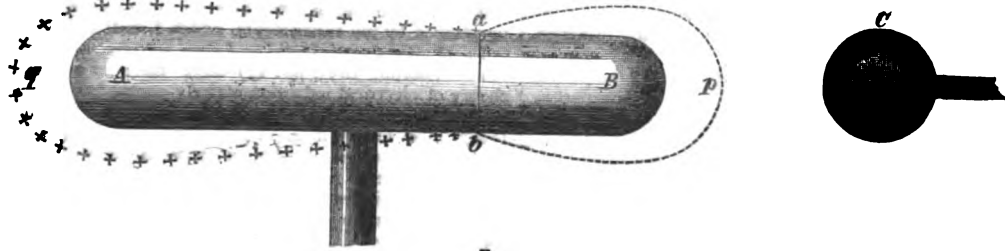

FIG. 1.

3. Because of the two kinds of electricity which coexist upon the induced insulated body, only the homonym of the inductor is dissipated by contact with the air. The experimental proofs upon which this old theory is based do not prove the facts indicated while the action of C is being exerted, contrary to what is stated in treatises on Physics. But in what follows we shall give other experimental and irrefragable proofs to demonstrate that the explanation indicated is not admissible.

Melloni<sup>2</sup> having discovered that the above-mentioned explanation was altogether erroneous, proposed another, which is as follows:—Upon the induced and insulated cylinder A B is found everywhere electricity of the same kind as that of the inductor, i.e., induced electricity of the second kind; but to a much greater degree at the extremity A, furthest from the inductor and much less at the extremity B, nearest to the same inductor. As to induced electricity of the first kind, it does not possess any tension, i.e., it is entirely latent (dissimulated) on the extremity B, nearest to the inductor, and proceeding from this extremity B towards the extremity A, furthest from the same inductor, it always goes on diminishing. It is for this reason that upon the induced insulated body there is a section in which the induced

electricity of the first kind, entirely concealed, will be equal to that of the second kind, entirely free. Also these two opposite electricities may coexist upon the induced and insulated cylinder, without neutralising each other.

In order to represent graphically this electrical distribution, obtained by induction upon the cylinder A B, and regarded as true by Melloni, let us make use of Fig. 2. In this figure A B represents the induced and insulated cylinder, C represents the positive induction, a b the section of electricities equal to each other but of opposite kinds; m, a, p, b, n, the induced of the first kind, and a, q, b, h the induced electricity of the second kind, i.e. the homonym of the inductor.

The new theory of Melloni, the truth of which I have proved by means of the experiments afterwards described, does not complicate the explanation of the facts which depend upon it. On the contrary, it tends to present them all in a unique and invariable aspect, the only one which is really natural and conformable to observation.

In the light of this new theory we see clearly (1) why the two opposite electricities coexisting on the induced and isolated cylinder do not neutralise each other; (2) if the extremity B,

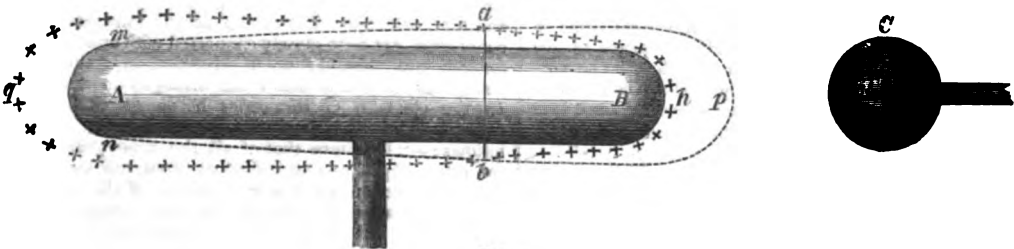

FIG. 2.

the nearest to the inductor C, is put into communication with the ground, the homonymous electricity of the inductor alone is lost, and not the opposite electricity; (3) why, of the two kinds of electricity which are found upon the insulated induced body, there is lost, by contact with the air, only the homonym of the inductor.

The cylinder A B, insulated and subjected to the influence of c, develops in a state of tension only the electricity homologous to that of the inducing body. The opposite electricity is completely latent, and becomes sensible only after the suppression of the inductive force.

When a proof-plane applied to the extremity B of the induced and insulated cylinder is subtracted from its influence, there is always seen the resultant of the two electricities which are found on the same extremity, both of them having become free, on the same proof-plane subtracted from the induction. This resultant may be either positive or negative, or even *nil*, relatively to the extremity B; but in each of these three results, we are bound to admit the pre-existence of two component electricities, opposite to each other, one completely latent, the other completely free, upon the same extremity.

If any element whatever of the section a b (Fig. 2) can be removed when insulated from the induction it will give a *nil* resultant.

Melloni, in the communication above referred to, confesses

<sup>1</sup> An Exposition of the Two Theories of Electric Induction. By M. Paul Volpicelli.

<sup>2</sup> "Comptes Rendus," t. 39, p. 177 (July 24, 1854).

that he is not able exactly to assign the true cause of certain facts relative to electric induction, in the phenomenon in question. We shall see in what follows, that nothing remains obscure in the theory developed by Melloni, when we reflect on the existence of what is called curvilinear induction, which was discovered by Faraday, and which is now acknowledged as a reality by all those who have kept themselves abreast of electrostatic science.

All that we have indicated in order to render clear the explanation given by Melloni of the electrostatic fact of which we have spoken, will be proved with a much greater amount of evidence by the experiments which follow. But, before describing them, it will be useful to give a brief historic sketch of the researches of different physicists as to the effect of electrical induction. The greater part of these researches are favourable to the theory of Melloni, while some are opposed to it. This theory will be acknowledged as true when it is proved that the induced electricity of the first kind does not possess any tension, or, what comes to the same thing, when it is proved that the homonym of the inductor exists also in the extremity B of the induced and insulated cylinder.

**HISTORICAL.**—Electrostatic induction, or electrical influence, was first observed by Canton in 1753 (Phil. Trans. vol. 48, part i., p. 350). Franklin continued his researches, but Wilke and Æpinus gave a greater development to the discovery indicated.<sup>1</sup> We conclude from the works of Canton that this physicist knew also the induction now called curvilinear; for he indicates several circumstances depending on the same phenomenon. The first who recognised, more than 100 years ago, that induced electricity of the first kind, that is with the sign opposite of the induction, does not possess tension, was Æpinus.<sup>2</sup> Subsequently Lichtenberg clearly announced that induced electricity of the first kind has no tension.<sup>3</sup> De Luc was also of the same opinion,<sup>4</sup> as also the celebrated Volta.<sup>5</sup> This Italian physicist<sup>6</sup> admitted the want of tension in the induced electricity opposite to that of the inductor, and admitted moreover that the electrical influence is exercised by means of a *partial* dissimulation of the inducing electricity, and the entire dissimulation of the induced electricity with opposite sign, a fact which is always verified. It seems that the question whether or not induced electricity of the first kind can have tension, was discussed for the first time by Lord Mahon and Volta, about 1787, to judge from what De Luc says.<sup>7</sup>

Among notable physicists who afterwards admitted that induced electricity of the first kind has no tension—before that doctrine was reproduced in a more developed form by Melloni, July 25, 1854—we must also reckon Fischer. This will be seen in reading Fischer's "Mechanical Physics," translated by Biot (4th ed., Paris, 1830, p. 238-242). The physicist Pfaff admitted completely the want of tension in induced electricity of the first kind.<sup>8</sup>

The celebrated Ohm, in a paper "On an unrecognised property of latent electricity," criticises Pfaff, and concludes that it is not true that induced electricity of the first kind has no tension.<sup>9</sup> Consequently if Ohm had known of the existence of the influence named curvilinear, he would, by means of his experiments, have arrived at the contrary conclusion. The curvilinear influence discovered by Faraday, was unknown also to Melloni, but, however, he did not fail to recognise the truth that the induced electricity opposite to that of the induction does not possess tension.

C. F. Mohr, a Coblenz pharmacist, criticises Pfaff, stating that in his experiments, the induced cylinder received the electricity by communication.<sup>10</sup> But we know that by operating on a very dry day, such communication does not take place; and yet by experimenting well, the result obtained by Pfaff is obtained, which triumphantly refutes Mohr.<sup>11</sup>

<sup>1</sup> Fischer's "History of the Arts and Sciences," Göttingen, 1804, vol. v., p. 726.

<sup>2</sup> "Tentamen theoriæ electricitatis et magnetismi," Petersburg, 1759 § 42, No. 2.

<sup>3</sup> See Erleben's work "Elements of Physics," sixth edition. Göttingen, 1794, p. 519.

<sup>4</sup> "Ideas on Meteorology," vol. i., second part, p. 334, § 360-1 (Paris, 1787).

<sup>5</sup> See his collected works, vol. i., part i. Florence, 1816, p. 258, line 4.

<sup>6</sup> Ibid, p. 200, line 6 from bottom, p. 260, line 14, and pp. 222-277.

<sup>7</sup> "Ideas of Meteorology," vol. i., part i., p. 292, § 324-5.

<sup>8</sup> Zehler's "Physikalisches Wörterbuch," vol. iii., p. 311 (Leipzig, 1827, p. 1).

<sup>9</sup> "Neues Jahrbuch der Chemie und Physik," by Schweigger Seidel, vol. v., p. 129 (1832).

<sup>10</sup> "Pogg. Ann. der Phys. u. Ch.," vol. xxxvi., pp. 224-8 (1835).

<sup>11</sup> "Op. cit. Val. 44, p. 332, and p. 334, line 1 (1838).

M. Riess gives a general *résumé* of the question in the "Repertorium der Physik" (vol. ii., p. 29; Berlin, 1838). He believes that by adopting the vertical position of the induced cylinder, instead of the horizontal position commonly adopted, we may be convinced that the pith balls, or even the gold leaves, diverge by the tension of the induced electricity—opposite to that of the inductor—which they possess. But this is not altogether true, since the *chief* cause of this divergence consists in curvilinear induction, which is not impeded in the vertical position of the induced cylinder. Moreover, we cannot at all understand the choice of an induced cylinder placed vertically, to which, without any good reason, M. Riess has given the preference for the purpose of proving the phenomena of electrical induction, since these phenomena are always the same, and are equally well explained in an induced cylinder, whether it be vertical or horizontal. M. Riess, in his memoir "On the power of propagation of induced electricity,"<sup>1</sup> produces some observations against the memoir which Pfaff published in reply to that of Mohr. We shall see that the same observations are evidently overturned by my experiments, which I shall shortly describe.

In M. Riess's work "Die Lehre von der reibungselekticität" (Berlin, 1853, pp. 177-207), there is a very elaborate theory of electrical induction entirely opposed to that announced by Melloni, and agreeing with the old and commonly adopted theory; but the arguments and experiments of Riess are reduced to nothing by the arguments and experiments which I shall afterwards describe.

Two memoirs were published by Knochenhauer in Poggendorff's *Annalen*, in the first of which (vol. 47, p. 455, 1839) the author treats explicitly of induced electricity, and denies that it possesses any tension, at the same time also asserting that the electrical influence cannot traverse the conductors; all this agrees with our point of view. In the second memoir (Pogg. Ann., vol. 51, p. 125, 1840) he treats of the power of induction of the *Coibents*, an argument which has a close connection with electrical induction. We ought to observe here that Fischer, long before Pfaff and Knochenhauer, asserted that induced electricity had no tension. It is really extraordinary that neither Fechner nor Riess ever sought to examine the physics of Fischer in connection with the subject of electrical induction.

Knochenhauer, in a memoir in Pogg. Ann., 1843, vol. 58, p. 311, replies to Fechner, maintaining against him that induced electricity of the first kind must be regarded as entirely latent.

The physicist Petrina, in a memoir the object of which is to prove the erroneousness of the hypothesis that the electric influence can traverse a conductor,<sup>2</sup> shows himself favourable to the absence of tension for the induced electricity opposite to that of the inductor, and concludes that Fechner had by no means refuted the experiments of Knochenhauer which admit this absence of tension.

According to the inferences to be drawn from the memoir of Petrina above referred to, it appears that this physicist was one of the first to recognise, in 1844, curvilinear electrical induction, already demonstrated by Faraday in 1839. This phenomenon, and that of the inability of the electric influence to traverse the conductors, are both closely connected with and comprised in the fundamental phenomenon of electrical induction.<sup>3</sup> Faraday's researches referred to below are arranged in a series of thirty. In the eleventh of this series he speaks of his experimental researches on curvilinear induction,<sup>4</sup> and expresses himself as follows:—"I believe that of all the consequences which flow from the hypothesis of induction from molecule to molecule, curvilinear action is the most important of all. As the existence of such an action has been established with certainty, I do not see how the old theory of rectilinear action at a distance can be maintained, or how anyone can oppose induction from molecule to molecule." It is really astonishing that in no modern treatise on Physics or on Electricity do we find any mention of curvilinear induction, which may easily be tested by repeating the experiments of Faraday, as also the other experiments which I have published.<sup>5</sup> We must, however, except the treatise of De la Rive and that of M. Gavarret; in the latter there is a paragraph entitled, "Induction through dielectrics can be exerted in a curved line."

(To be continued.)

<sup>1</sup> "Pogg. Ann.," vol. 44, p. 624.

<sup>2</sup> "Pogg. Ann.," 1844, v. 61, p. 116.

<sup>3</sup> See Faraday's "Experimental Researches—Electricity," and "Catalogue of Scientific Papers," vol. ii. (Lond., 1868).

<sup>4</sup> See also "Pogg. Ann.," 1839, vol. 46, p. 537.—De la Rive, "Traité d'Electricité" (Paris, 1854), t. 1, p. 138-9.

<sup>5</sup> "Comptes Rendus," 1856, t. 43, p. 719.



## SOCIETIES AND ACADEMIES

LONDON

**Geological Society, March 8.**—Pro. P. Martin Duncan, F.R.S., president, in the chair.—W. J. Chetwood Crawley, Walter Keeping, Joseph Thompson, and William Walker, were elected Fellows of the Society. The following communications were read:—1. On the influence of various substances in accelerating the precipitation of clay suspended in water, by Mr. Wm. Ramsay Principal Assistant in Glasgow University Laboratory. Communicated by Prof. Ramsay, F.R.S., V.P.G.S. The author referring to the fact that clay when suspended in water in excessively minute particles, settles more rapidly when the water contains salts in solution, noticed the opinions expressed by previous writers on the subject, and gave the results of experiments made by him, from which it would appear that the rapidity of precipitation is proportionate to the amount of heat absorbed by the salts in process of solution. By another series of experiments he found that the fluidity of the respective solutions had apparently no influence on the rapidity of deposition of the clay. He also found that clay is deposited less quickly in acid solutions than in solutions of salts, and more rapidly in a solution of caustic soda than in one of caustic potash. In solutions of common salt of different strengths he found that clay settled in the inverse order of their specific gravities. From all these results the author is inclined to attribute the varying rapidity of the settling of clay suspended in saline solutions to the varying absorption of heat by the solutions. When water containing suspended clay was heated, the rapidity of the settling of the clay was proportionate to the heat of the water. The author suggests that the increased rapidity of settlement may be due to the greater amplitude of vibration of the molecules of water when heated; the vibrations being performed in equal times, particles descending at right angles to the plane of vibration will experience less resistance from the molecules of water. A note by Prof. Ramsay, briefly indicating some of the geological bearings of these results, was appended to the paper.—2. On some Fossiliferous Cambrian Shales near Carnarvon. By Mr. J. E. Marr. Communicated by Prof. T. McKenny Hughes, F.G.S. With an Appendix, by Mr. Henry Hicks. The shales described by the author extend from about three miles S.W. of Carnarvon to Bangor, running nearly parallel to the Menai Straits. They are faulted against Lower Cambrian to the east, and disappear against a dyke on the west. The shales vary from greyish black to bluish black in colour, and are generally sandy and micaceous, but in places chiefly clayey. Fossils were obtained from three places on the banks of the Seiont, namely, near Point Seiont (where the beds are concretionary in structure), along the old tramway from Carnarvon to Wantlle, and near Pellig Bridge. The first-named locality is richest in fossils; and here there is a greenstone dyke, parallel to the bedding of the rock, and altering the shales for a distance of about four yards from the edge of the dyke. The fossils seem to indicate that the deposit belongs to the upper part of the Arenig group. Mr. Hicks pointed out that the fauna clearly showed that these beds belong to the Arieng group, many of the species being identical with those found in the upper part of that group at St. David's Shelve, and in Cumberland. The new species found by Mr. Marr are a *Caryocaris* (*C. Marrii*) and an *Aegina* (*A. Hughesi*). The other fossils were *Didymograptus indentus*, *D. bifidus*, *D. Murchisoni*, and the var. *furcillatus*. Species of *Barrandea*, *Trinucleus*, *Lingula*, *Obolella*, *Dicyna*, &c., and *Orthoceras caeresiense*. The rock in its general character is extremely like that at the same horizon in the succession at St. David's Shelve, and in Cumberland, and indicates, therefore, the prevalence of similar physical conditions when deposited. The rock is such as would be formed over an even sea-bottom at some considerable distance from land and in moderate deep water. Mr. Hicks looked upon this discovery as of considerable importance, since it clearly proved the position of beds hitherto imperfectly known, and moreover shows that similar conditions prevailed over extensive areas at the time these beds were deposited. It also furnished further evidence in support of Mr. Hicks's opinion that no break occurs anywhere in the Welsh area between the Cambrian and Lower Silurian rocks.—3. On the occurrence of the Rhætic Beds near Leicester. By Mr. W. J. Harrison, Curator of the Town Museum, Leicester. The sections described by the author are shown in brick-pits in the Spinney Hills, forming the eastern boundary of the town of Leicester, and in the Crown Hill on the eastern side of a valley excavated by the Willow Brook. In the latter locality they are capped by Lower Lias. They have a slight dip to the south-east.

The brick-pits show a thickness of about 30 feet of Rhætic beds above the Triassic red marl, to which their stratification is parallel. The lowest bed is a light-coloured sandy marl about 17 feet thick, traversed by three or four courses of harder, whiter stone, and containing crystals of selenite, pseudomorphs of salt, and numerous small fish-scales. A single insect wing was obtained from it. This bed extends across the valley of the Willow Brook, and forms the base of Crown Hill. Above it comes the Bone-bed, from 2 to 3 inches thick, containing numerous small teeth, bones, and scales of fishes and Saurians, including large vertebræ of *Ichthyosaurus*, ribs probably of *Plesiosaurus*, and some bones of Labyrinthodont character. Two species of *Axinus* also occur. The Bone-bed is followed by about 2½ feet of coarse black shales, overlaid by a very thin band of hard reddish sandstone, with casts of *Axinus*, and this by about 2 feet of finely laminated black shales containing *Cardium rhæticum*, *Avicula contorta*, and a Starfish (*Ophiolepis Cardium*). Above these come about 5 feet of shales with sandy partings, the lower foot rather dark and containing *Avicula contorta*, *Cardium rhæticum*, *Ostrea liassica*, and a new *Pholidophorus*; the remainder light-coloured, but with the same shells. The topmost bed in the section is a band of nodular limestone 6 inches thick. The same sequence is observed in Crown Hill. There are indications of the existence of a second nodular limestone and of beds of light-coloured clay and sand, but obscured by drift, in which, however, blocks of limestone occur with *Monotis decussata* and *Anoplophora musculoides*. The author indicates other localities where traces of the Rhætic beds are to be seen, and states that wherever the true junction of the Trias and Lias is exposed, the Rhætics appear to be invariably present. The paper also included some particulars with regard to borings in the Trias near Leicester.—4. Hæmatite in the Silurians. By Mr. J. D. Kendall. The author referred to a former paper in which he showed that direction of the hæmatite deposits in the Carboniferous Limestone of Cumberland and Lancashire is parallel to that of the meridional divisional planes, or nearly north and south; while the deposits in the Silurians are in two directions, some parallel to one set of divisional planes and some to the other. In the present paper he describes a deposit of hæmatite at Water Bleas, in the parish of Millom in Cumberland, in Coniston Limestone, which appears to be altogether unlike those referred to in his former paper. The Silurians here are all conformable, with a strike about 65° N.E. and S.W. and a dip of about 80° to N.W., but their order is inverted. The hæmatite occurs in the Coniston Limestone in the form of short veins, varying in width from a few inches to 9 feet, running in the direction of the strike, and having the same dip as the limestone, their deposition having taken place along the bed-joints of the rock. The author accounts for this difference in the deposits by the fact that in the Coniston Limestone at Water Bleas the bed-joints are much more persistent than the divisional planes, which are very irregular and not at all so strong and open as the bed-joints.

**Zoological Society, March 21.**—Dr. E. Hamilton, vice-president, in the chair.—Mr. Sclater exhibited and made remarks on a series of skins of the parrots of the Fiji Islands, obtained by Mr. E. L. Layard belonging to the collection of Lord Walden, and called special attention to a new species of the genus *Pyrrhuloxia* of Reichenbach from the Island of Tavuni, which Mr. Layard had proposed to call *P. taviunensis*.—Mr. A. G. Butler read a paper containing descriptions of some new Lepidoptera from the collection of Lieut. Howland Roberts.—A communication was read from Mr. Andrew Anderson, containing corrections of and additions to a former paper of his on the Raptorial Birds of North-Western India.—Mr. Howard Saunders read a paper on the *Stercorariinae* or Skua Gulls, in which he revised and corrected the synonymy of several species, and traced their respective ranges so far as they were known. He considered that *Stercorarius chilensis* (Bp.), although more nearly allied to the Northern form *S. catarrhactes* than to *S. antarcticus*, was perfectly distinguishable from either by its constant rufous coloration of the underparts and axillaries; its range as at present known being restricted to the West coast of South America. The range of *Sterc. pomatorhinus* was shown to extend from S. lat. 82° N. to about 30° S., and that of Richardson's Skua, to which he restored the original, but lately disused name of *Stercorarius crepidatus* reached from 82° N. to more than 40° S., on the coast of New Zealand: *S. spinicauda* (Hardy), from the African coast, being regarded as merely this bird in winter dress.

Anthropological Institute, March 14.—Col. A. Lane Fox, president, in the chair.—Mr. Stanbridge, of Daylesford, Victoria, exhibited and presented a collection of stone implements from Australia. It consisted of some axe heads, a mounted stone spear head, some wallongs, or grinding stones, and a Yowiwi, or large flat stone, on which the Nardoo seed is ground. A large stone implement, supposed to be for digging, was also lent. The president considered this last was an unfinished tool which would have been reduced in size if finished; but it had been used apparently in its present state, one of the ends being much rubbed.—Capt. Melford Campbell, President of Nevis, exhibited some stone implements. One of these, a knife or dagger, from Honduras, is 10½ inches long, and made of a thick flake of buff coloured chert of a fine amber hue; similar but smaller specimens from the same place are already in the Christy collection. Three polished Celts, from Turk's and Cairo Islands were shown by Capt. Campbell.—Mr. H. H. Howorth read a paper on the Samatæ, which was followed by a discussion.—Mr. H. Dillon, the Director, read a translation by Capt. R. F. Burton, of two letters from H. B. M.'s Vice-Consul at Lissa, H. Topich, on some human remains recently found in the Island of Pelagosa.

Meteorological Society, March 15.—Mr. H. S. Eaton, M.A., president, in the chair.—R. Trout Hawley Bartley, M.D., John Wuford Budd, Lieutenant-Colonel George E. Bulger, W. Brown Clegram, M. Inst. C.E., J. Sanford Dyason, John Eanson, Assoc. Inst. C.E., Thomas W. Grindle, Assoc. Inst. C.E., Major F. Bonnycastle Gritton, Junius Hardwicke, F.R.C.S., Alfred O. Walker, and the Rev. E. William Watts, M.A., were duly elected Fellows of the Society.—The following papers were then read:—On the Rhé-electrometry of Marianoni, by Robert James Mann, F.R.A.S.—On the variation of errors in hydrometers, by R. Strachan.—On the deduction of mean results from meteorological observations, by L. F. Kántz (translated from the *Reperitorium für Meteorologie*, by J. S. Harding).—Summary of observations made at Stanley, Falkland Islands, during 1875, by F. E. Cobb.—Contributions to the Meteorology of West Australia, by R. H. Scott, F.R.S.

Victoria (Philosophical) Institute, March 20.—A paper was read upon the flint implements found in Brixham Cavern, in which the author, Mr. Whitley, alluded to the statements of Mr. Pengelly, whose active superintendence of the exploration of the cavern under the auspices of the Royal and Geological Societies was deserving of the warmest thanks of all geologists. Mr. Whitley complained that the Report of the Royal Society and the specimens had been allowed to lie by for fifteen years before being published and rendered accessible to the public. The consequence was, that for a long time theories having no foundation in fact had been promulgated as to these specimens, and several statements in regard to Brixham Cavern and its contents had been made in well-known geological works, which did not accord either with the recent Report of the Royal Society or Mr. Pengelly's subsequent one.

Institution of Civil Engineers, March 21.—Mr. Geo. Robert Stephenson, president, in the chair.—The paper read was descriptive of the hydraulic canal lift at Anderton, on the River Weaver, by Mr. Sidengham Duer, B.Sc., Assoc. Inst. C.E.

PARIS

Academy of Sciences, March 20.—Vice-Admiral Paris in the chair.—The following papers were read:—On the first method of Jacobi for integration of equations with partial derivatives of the first order, by M. Bertrand.—On the inferior limit which should be set to admission of steam into a steam-engine, by M. Resal.—On the storms called *foehn* in Switzerland, by M. Faye. These occur in certain parts, when a cyclone from the south-west meets the Alps; instead of showers and fall of temperature, the wind blows hotly and dryly; there is also a marked barometric depression. Around the special region the tempest produces its ordinary effects. The facts are explained by the gyratory descent of a mass of air, deprived by the mountains of the cirrus which whirlwinds formed in the upper regions usually carry downwards. Now it is objected against M. Faye's theory of storms that a descending current should give a barometric maximum; but here, with manifest descent, there is a minimum. The barometric depression (both in the *foehn* and the ordinary storm) is a simple consequence of the gyratory movement, not the index of a strong suction excited from above on the inferior layers.—Note on an apparatus for determining the intensity and the law of development of pressures in the bore of guns

with reference to the time, by M. Morin. The gaseous pressure is caused to press out a metallic jet of tin, the length of which increases with the pressure with sufficient regularity (each millimetre corresponds to about 237 kilogrammes of pressure per square centimetre). A piston is in contact with the tin cylinder, and a pencil at the end of its rod gives a tracing on a chromometric apparatus.—Determinations of nitrates and of ammonia in the water of the Seine, made on 18th March, 1876, above the bridge of Austerlitz, by M. Boussingault.—On the volume of the Seine, and the flood of 17th March, 1876, by M. Belgrand. This flood is the third highest in this century (the highest was in 1802). The Seine, in its greatest flood, gives fifty-two times more water than at low water.—On the spectrum of calcium, by Mr. Lockyer.—Actinometric measurements on the summit of Mont Blanc, by M. Violle (he will shortly give his results).—On the next hatching of winter eggs of *Phylloxera*; note by M. Bébiani.—Physiological action of *Amanita muscaria*, general phenomena of the poisoning; effects on organs of circulation and respiration, and disorders of calorification, by M. Alison, *inter alia*, the lowering of temperature by this substance, and the restoration to normal temperature with atropine are important.—On the means employed for education and instruction of deaf mutes, by the method of articulation, by M. Magnat.—Impossibility of the equation  $x^2 + y^2 + z^2 = 0$ , by M. Peppin.—On the behaviour of chronometers, by M. Rouyaux.—Geometrical solution of the problem of determining the most probable place of a ship by means of any number of straight lines of altitude greater than 2, by M. Bertot.—Influence of temperature on magnetisation, by M. Gauguain. The new facts given are briefly these:—When a steel bar in contact with a magnetic pole is gradually heated to a blue tint, the magnetism first increases, reaches a maximum, then decreases. The bar being allowed to cool while in contact, the total magnetism increases all the time, so that, when the bar has cooled to the surrounding temperature, it has much greater magnetism than before heating. The total magnetism of the bar, brought back to ordinary temperature, is greater the more the bar has been heated (at least under the temperature giving a blue tint). After breaking contact of the cooled bar for a few seconds it loses a part, but not all, of the increase of magnetism that resulted from heating.—On a rock intercalated in the gneiss of the Mantiqueira, Brazil, by M. Gorceix.—Reply to two critiques by M. Faye, by M. Hildebrandsson. He calls attention to three facts. It is rare that the form of isobars is circular. Synoptic charts show that the air moves spirally towards the centre of a minimum. The anterior and the posterior parts of a squall are quite different, so that after passing the centre you have a sudden change in the weather; and this is explained if the motion of the air have an upward component, for then other air unceasingly flows in from different regions. The facts cited are in opposition to M. Faye's theory.

CONTENTS

	PAGE
BLASIUON ON STORMS . . . . .	421
ANDERSON'S "MANDALAY TO MOMIEN" ( <i>With Illustrations</i> ) . . . . .	422
OUR BOOK SHELF:—	
Youmans' "Class Book of Chemistry" . . . . .	424
Cook's "Injurious Insects of Michigan" . . . . .	424
LETTERS TO THE EDITOR:—	
Water Supply of the Metropolis.—JOHN EVANS, F.R.S. . . . .	425
Evidences of Ancient Glaciers in Central France.—REV. W. S. SYMONDS . . . . .	425
Metachromism.—W. M. FLINDERS PETRIE . . . . .	426
Socotra.—P. L. SCLATER, F.R.S. . . . .	426
Coloured Solar Halos.—T. W. BACKHOUSE . . . . .	426
"Euclid Simplified."—R. TUCKER . . . . .	426
Bullfinches and Primroses.—C. A. M. . . . .	427
Seasonal Order of Colour in Flowers.—J. C. COSTERUS . . . . .	427
Plant Fertilisation.—M. S. EVANS . . . . .	427
The Visibility of Mercury.—REV. SAMUEL J. JOHNSON . . . . .	427
How Typhoid Fever is Spread.—J. MITCHELL WILSON . . . . .	428
The Ash Seed Screw.—A. STEPHEN WILSON . . . . .	428
OUR ASTRONOMICAL COLUMN:—	
The Companion of Sirius . . . . .	428
D'Arrest's Comet . . . . .	428
PROF. HUXLEY'S LECTURES ON THE EVIDENCE AS TO THE ORIGIN OF EXISTING VERTEBRATE ANIMALS, III. . . . .	429
PHYSICAL SCIENCE IN SCHOOLS. By R. GERSTL . . . . .	430
ON DETERMINING THE DEPTH OF THE SEA WITHOUT THE USE OF THE SOUNDING LINE. By DR. SIEMENS, F.R.S. ( <i>With Illustrations</i> ) . . . . .	431
PHOTOGRAPHY OF THE RED AND ULTRA-RED END OF THE SPECTRUM. By CAPT. W. DE W. ABNEY, R.E. . . . .	430
RAOUL PICTET'S SULPHUROUS ACID ICE-MACHINE . . . . .	431
APPARATUS FOR DEMONSTRATING TRANSFORMATION OF FORCE . . . . .	434
NOTES . . . . .	434
EXPERIMENTAL RESEARCHES ON THE EFFECTS OF ELECTRICAL INDUCTION, FOR THE PURPOSE OF RECTIFYING THE THEORY COMMONLY ADOPTED. By PROF. VOLPICELLI ( <i>With Illustrations</i> ) . . . . .	437
SOCIETIES AND ACADEMIES . . . . .	439

THURSDAY, APRIL 6, 1876

## PREECE'S TELEGRAPHY

*Telegraphy.* By W. A. H. Preece, C.E., Divisional Engineer, Post Office Telegraphs; and J. Sivewright, M.A., Superintendent (Engineering Department) Post Office Telegraphs. (London: Longmans, Green and Co., 1876.)

IT is with feelings of great disappointment that we lay down the latest book on Telegraphy. In a work professedly a text-book of science, one of the series that contains Clerk Maxwell's Heat, Jenkin's Electricity, Good-ve's Mechanism, and the books of Bloxam and of Miller, we certainly were not prepared to find the part of science consistently left out. We considered, in fact, that when two authors, high in their profession, undertook to supplement a recognised want in so distinguished a series of text-books, we might expect to receive from them the best and the newest information obtainable on the subject that they profess to deal with.

In the last twenty years the advances in our knowledge of the science of electricity and magnetism and of the principles of telegraphy, a branch of electrical science applied, have been very great and very important. The science and the practical application of electricity have occupied a large part of the attention of the foremost investigators in physical science. The labours of Gauss, Weber, Faraday, Joule, Helmholtz, Thomson, Maxwell, and of the celebrated British Association Committee on Standards of Electric Resistance have given to the student on the one hand and to the practical engineer on the other, a system of laws, of methods of calculation, and of experimental results as to properties of matter, that make the science of electricity perhaps the most exact of all the branches of Natural Philosophy. To ignore every exact principle from first to last of a science so well founded, and to substitute for a clear statement of these well-known principles a few sketchy paragraphs not worthy of the middle of last century, is not, in our opinion, the proper introduction to a *scientific* text-book on Telegraphy for beginners.

The authors of the work before us naturally think that "Electricity being its main theme a certain acquaintance with the elementary principles of that science must be assumed on the part of the reader." However, "the differences which exist among electricians with respect to the signification of many of the technical terms employed in connection with telegraphy render it necessary that the student at the outset should have a clear comprehension of the meaning of those which will be used in this work." Accordingly they proceed to give him a "clear" idea of "Electric quantity," "electric potential," "electric resistance" in the following way:—

"Electricity is an agent pervading terrestrial and solar space, and is as universal in its effects as are heat and light. We are cognisant of its existence when we hear the roar of thunder and see the flash of lightning, but we do not know its particular form any more than we know that of heat or that of light. The sound of the thunder and the flash of the lightning affect the ear and the eye—

we hear the sound and see the light—but we do not assume the existence either of sound or of light as distinct entities or things [Remarkable statement]. We can speak of the quantity of sound caused by the explosion of a cannon or by the blowing of a penny whistle, the quantity of light emitted by a gas jet or by a farthing rush-light; the quantity of heat required to melt a pailful of ice or to solder a metal joint, without implying by the term quantity a mass or volume of anything actually present."

Notions such as these as to quantity are quite new to us. We would suggest as an examination question for science classes the comparison of the quantity of sound caused by an explosion with the quantity caused by blowing a penny whistle for a week.

Our authors proceed:—

"The term implies relative magnitude only. It is the answer to the question, 'How much?' It implies the notion of more or less. When we speak of the magnitude of electricity present or passing, we speak of its *quantity*. When we read of the church spire destroyed, of trees riven to splinters, of wires fused, or of flocks killed, the damage done is due to the electricity passing, and the amount of that damage is proportional to its magnitude or *quantity*. If we take a piece of sealing-wax, a glass rod, or an ebonite comb, and rub it against the coat-sleeve, we find it has the property of attracting feathers, straws, and other light bodies. Electricity has been excited upon its surface, and the force of attraction is found to increase with the quantity of electricity present. Conversely the force with which bodies are attracted is an indication of the quantity of electricity excited. Hence we learn that *ELECTRIC QUANTITY is the magnitude or amount of electricity present.*"

The italics and capitals in all the quotations are due to the authors.

With no further explanation or hint of anything more definite, but with a few lines, apparently meant for an explanation of the algebraic method of representing numbers by letters, the authors calmly remark:—

"The unit quantity of electricity in general use has been called a *weber*, from Weber, one of the great German philosophers."

This is absolutely everything that is given to the elementary student to enable him to understand what is meant by quantity of electricity. Not a single experiment is described, except the electrostatic experiment of rubbing a glass rod, an experiment which has very little to do with the electromagnetic unit of quantity, the weber. Not a hint is given of the electromagnetic, electrochemical, or thermal effects of the current. We can picture to ourselves a student of lively imagination in sad perplexity as to whether the unit of current is to be expressed in terms of trees destroyed or of church-spires smashed per second, and as to the numerical relation between unit damage done and the weber. All this in the face of the beautifully simple absolute system of electrical measurement now universally adopted!

Space does not permit us to transfer to our pages in full the notions of the authors on other fundamental questions, though some of them are not less important than that which has just been noticed. A few lines of quotation must suffice.

"POTENTIAL," we learn, "*implies that function of electricity which determines its motion from one point to another.*"

We doubt whether the elementary student will obtain from this definition (?) or from the accompanying explanations, any criterion for knowing a point of high potential from a point of low potential, or any idea of how to reckon numerically the potential at a point, or even the difference of potentials between two points.

Next we learn that "RESISTANCE *implies that quality of a conductor in virtue of which it prevents more than a certain amount of work being done in a given time by a given electromotive force.*" This is prefaced by the extraordinary remark that "The transference of electricity, such as that from a charged cloud to the earth, from a rubbed glass to a rubbed comb, a signal from Europe to America, may take place in different times; the path between A and B offers obstruction to the passage of electricity; the medium through which it passes . . . is an obstacle to be overcome." The unit of resistance is, it is said, called the *Ohm*, from Ohm, the German physicist, but the laws of Ohm are not stated, nor is the beginner even told to connect with them the idea of diminishing the current between two points by increasing the resistance between them; and with the exception of the mysterious and inaccurate reference to work done, just quoted, (and the work done in the circuit by no means presents itself directly to the attention of the beginner in electrical studies), there is nothing to afford a clue to the effect of the resistance in a given circuit. This remarkable chapter concludes as follows:—

"The nature of electricity itself is not known, nor is it necessary to the telegraphist that it should be known by him. He is only interested in its quantitative measurement and its application to practical purposes. Let him master its elementary principles, its general ideas, its properties and its conditions, and he can well afford to leave to physicists the discussion of its nature, and to mathematicians the determination of its laws."

We have no objection to these general sentiments, but we venture to think that for any one who wishes to write a book on telegraphy a moderate amount of attention to what the naturalist (we can't call him physicist) and mathematician have to impart would not be out of place.

We are far from satisfied with the chapter on batteries and with the chapters on construction; in fact our idea of what the artisan class and the beginners in science schools should expect to learn from a text-book of science in no way agrees with the ideas of the authors of this book. We cannot think that the last chapter (fifteen pages), describing the message-forms used in the British postal telegraphs, and a mass of technicalities even to the inserting of the received message in an envelope and handing it to the messenger, will be of use to anyone. And yet the dimensions allowed for the book have compelled the authors, as they tell us, "to abandon the submarine cable branch of the subject"! Similarly, "quadriplex, multiplex, and other novel systems of telegraphy have been omitted." . . . "The discussion of Ohm's laws and the apparatus depending upon them are not dealt with." Everything scientific is in fact left out.

There is a mass of technicality in the chapter on batteries, of which a host are described with their prices,

&c. If space were of no consequence this would most interesting but, for want of space, we presume, principles of testing batteries for electromotive force: resistance are omitted. The chapters on construction contain elaborate discussions as to charring, tarring, netising, kyanising, boucherising poles, about the merits of different kinds of wood, about earth-borne a multitude of other things, while the principles of a parallelogram of forces practically applied to the fixing poles by stays and struts are not mentioned. We have thought that Mr. Preece, Mr. Sivewright, and coadjutors leave but little choice to the artisan as to materials and the tools to be employed in construction of telegraph lines, and that practical application of the science of dynamics to the case in hand would be of far higher value to the man who is actually engaged: stepping the poles and fixing the stays and struts, than a not very perfect description of the methods adopted in the preservation of timber. The gauge of the iron employed in Post Office Telegraphs is given. We are left to wonder whether in selecting wire any test as to electric resistance is applied or not; and we are not told what kind of preliminary electrical test, if any, ought to be applied. In fact, though these questions are intrinsically of extreme importance, they ought not to have been allowed utterly to displace the fundamental principles of the science of telegraph construction and of telegraphy. While they form a part of the whole subject, and they do form a very important part of it, they should have occupied a subordinate place in a book for beginners. Those who want an elementary text-book on the science of telegraphy, want more than a description of the practice, as their land lines, of the British Postal Telegraph department.

The chapters taken up with the instruments are, in our opinion, the best part of the book. The instruments used on land-lines are well described. Interesting information is given as to rates of working. Some of these show very wonderful results of practice. For example we learn that an experienced operator usually punches forty-five words per minute. Now a word contains 45 letters, and if we take it that an average letter contains, including the space that divides it from the next letter, four dots, we find that at this rate of punching 135 dots per second are made. If three more dots could be made per second, the strokes with the mallets would nearly cease to be heard distinct one from the other, and a deep musical note four octaves below the middle C on the pianoforte would be the result. We wonder whether this could be done were the operator to punch a few times over some sentence that he knows by heart.

We have noticed in reading the book some errors that it would be well to correct in future editions. On p. 21, damp ground is said to abstract a certain portion of the current. On p. 32, a battery is described as Thomson's, which is not used, and never was used, except for an experiment. Sir W. Thomson has arranged a gravity battery, very different in form from that here described, and which, being in use with his Siphon recorder, is generally known as his battery. In figures 69 and 93 the battery is represented as short-circuited by the sending key. On the whole, however, the diagrams are clear, and descriptions of the instruments well written.

MUSICAL INSTRUMENTS AT SOUTH KENSINGTON

*A Descriptive Catalogue of the Musical Instruments in the South Kensington Museum. Preceded by an Essay on the History of Musical Instruments. By Carl Engel. Second Edition.*

THE collection of musical instruments in the Museum at South Kensington is one of considerable and of varied interest. Consisting, as it does mainly, of the instruments employed by various nations within the last few centuries, it exemplifies the improvements in art and the gradual development of scientific principles in construction. But it includes also instruments of more remote dates such as would range within "the middle ages," and a few of prehistoric period. In the last case a similarity of musical instruments and of musical systems may be an important assistance in determining the ethnology of an extinct people, while the practice of opposite systems by neighbouring races will be a strong inference that they sprung from different stocks.

The excellent Catalogue, of which we have now a second edition, includes a prefatory essay by M. Carl Engel on the early history of musical instruments, and he has enhanced its utility by adding the scale of notes which many of the instruments would produce. This was practicable in the case of pipes, flutes, or other wind instruments from extant examples, but not with such as were stringed, because they would not remain in tune.

When a nation is found to have employed instruments constructed for the diatonic octave scale, such as the intervals of our A B C D E F G A, it is a proof that the possessors practised harmony, although it may have been but to a limited extent. The reason is that the fourth and seventh notes of such scales require different basses to the others, and would not be agreeable to the ears without the addition of such basses. On the other hand, if we find a scale of but five notes within an

octave, the two omitted will be the fourth and seventh of the scale on that very account. We may in such cases conclude with safety that melody was the chief attraction to the people, and that harmony was either unknown or little appreciated.

We should bear in mind that the most ancient recorded octave scale of Greece and of Northern Asia and Africa is the minor; but there may have been exceptional cases of the use of the major, because the ancient Greeks had a five-note major as well as a five-note minor scale in their chromatic system. Nevertheless, it can have been but little practised by them in early ages because it was never admitted into their precepts. There is no Greek treatise upon music which includes the major scale; and yet the transition from one to the other was most easy, for whoever begins upon the third note, instead of the first, of any minor scale, will transform it into its "relative" major. These are the particular points to be borne in mind in estimating remote dates for musical instruments.



FIG. 1.—Ancient Pipe of the Chiriqui. (Central America.)

And now to apply these principles to three of the instruments of different races discovered in Central and in South America. Among the ancient graves of the Chiriqui in Central America small pipes and whistles of pottery, which produce several sounds, have been found, of which one has six finger-holes, but in that case the

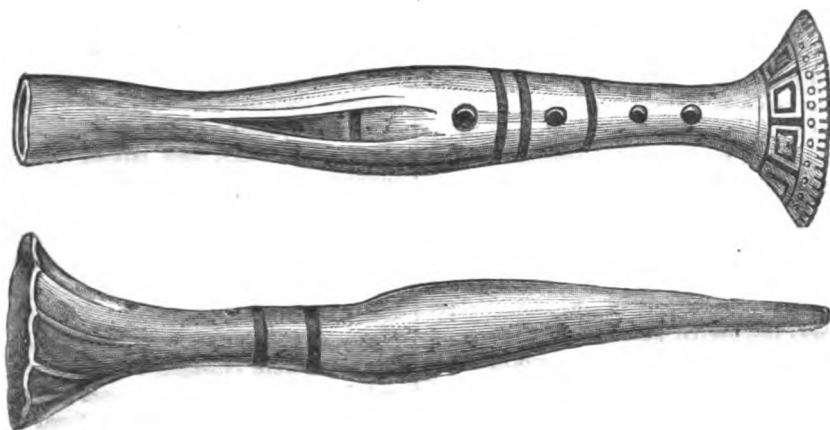

FIG. 2.—Pipes of the Aztecs.

notes have not been ascertained, while others have four notes, E F G A. These form the ancient Greek tetrachord, and the Greeks acquired their knowledge of music from the nations of Northern Asia and Northern Africa, especially from Egyptians, Chaldeans, and Phœnicians. Can any one of these nations have been in contact with the

Chiriqui of Central America? The scale is fitted for chanted recitations rather than sufficient for music proper. F would be the chanting note of the above, with the power of ascending, for expression, to G and A, and with that of descending to the major seventh, E in preparing for a close. In this sense the notes are pure, good, and

true parts of a major scale. They are such as a correct musical ear would dictate, but they tell little as to the cultivation of music.

Upon the same page (67) M. Engel passes on to the *Pitos* (of the flageolet kind) used by the Aztecs. These are of reddish pottery, having four finger-holes, and producing five notes, including the open note of the pipe

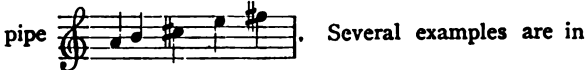

Several examples are in the British Museum. Although *Pitos* vary in size they have all the same pitch of sound, says M. Engel, and are easy to blow. They have but five notes to the octave, in the major scale, and this has been popularly called "The Scotch Scale." M. Engel terms it *pentatonic*, but, if it must needs have a Greek name, we prefer *pentaphonic*, since two of the intervals for an octave scale are of minor thirds. The points to be remarked in these *Pitos* are that the various lengths should have been so proportioned as to be of the same pitch, and that the scale should be major. We may say of the Aztecs, as of the Chiriqui, that the practice of harmony did not obtain among them, but the Aztecs had advanced further in the direction of melody, and had in all probability a custom of playing many pipes together in unison. They were also advanced in the manufacture of pottery. It is often convenient to suppose that a people is "indigenous," and it may have been so for many centuries, but the speculation for ethnologists is "Whence originally came the Aztecs?"

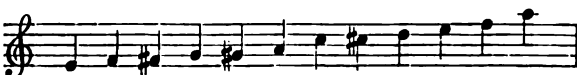

FIG. 3.—Huayra-puhura of the Inca Peruvians.

The third case is of the Inca Peruvians (p. 70). They had a *Syrinx*, or *Pandean pipe*, which played in octaves. The seven double pipes were of equal length, but the one pipe was closed at the end, and its fellow open. When M. Engel says: "The reader is probably aware that the closing of the pipe at the end raises its pitch an octave," it is an error in writing—he means that closing the end lowers its pitch an octave. The Peruvian *Syrinx* is *pentaphonic* in the key of C major. The scale is printed as beginning with the octaves of A, which we suspect to be a misprint for B, and the reason will presently appear.



Another instrument of the same class "was discovered placed over a corpse in a Peruvian tomb, and was procured by the French general Paroissien." The scale of this set of pipes, as given by M. Engel, is as follows:—



It commences with E, the major Seventh below F, the key-note, just as we suppose the preceding pipes should have been given. It then forms an ascending chromatic scale of F to the extent of an octave, excluding only the Fourth and the *minor* Seventh of the scale. The reason is

evidently because those two are not good melodic intervals. They require their own basses to render them agreeable to the ear, and the instrument does not include

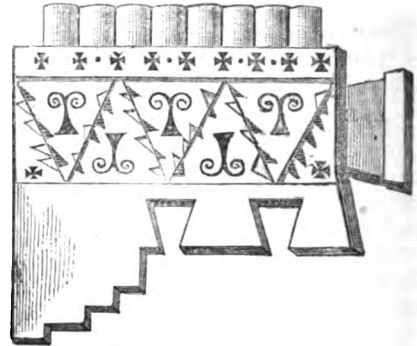

FIG. 4.—Huayra-puhura of the Inca Peruvians.

a bass. On the other hand the *major* Seventh, or *semi-tone* below the key-note, is included. It is a good melodic interval, and the French term it *la note sensible*. The only tone above the octave is A, which adds to the instrument a run over the common chord of A major.



This is a remarkable and an excellent melodic scale, which has not been duly appreciated by M. Engel. He says: "The musician is likely to speculate what could have induced the Peruvians to adopt so strange a series of intervals—indeed it seems rather arbitrary than premeditated."

A little reflection upon the intervals of the harmonic, or natural, scale would have satisfied M. Engel that these Peruvians had exceptionally correct ears for music. It is not, as he supposes, any "natural predilection for that series of intervals which may be called the pentatonic scale, because it contains only five different intervals in the compass of an octave" (p. 311) but, "because" the two omitted notes are unsatisfactory to the ear in unaccompanied melody. They are "irrational" intervals, and therefore they have been rejected by nations in all quarters of the globe, Scotch and Irish, Egyptians, Chinese, Malays, Peruvians, Aztecs, and others. Even Europeans, who cultivate harmony, reject the minor seventh in minor scales.

M. Engel has fulfilled a laborious duty with great industry and ability. A more intricate subject than the ever-changing names of the musical instruments of past ages could scarcely be found. It is next to impossible that it should be quite perfect. Sometimes the names of instruments were changed without any appreciable reason, and, in many cases, those names were absurdly misplaced. For instance, an Italian monochord for measuring intervals was called *tromba marina*, and was translated into English as a "trumpet marine." Dr. Burney not unnaturally assumed that it must have been a trumpet made of a shell, like the Triton's conch, but it consisted of three long pieces of wood, glued together triangularly and it had one string to be sounded by a bow. Again, as to the guitar in Spain. It had but four strings until about the sixteenth century, and then, seeing that foreign



ols had six strings, the Spaniards increased the number upon their guitars to six, and termed them vihuelas, without adopting the distinctive feature of the viol—the bow. No es otra cosa esta guitarra sino una vihuela quitada la sexta y la prima cuerda," says Juan Bermudo, in 1555,— "This guitar is no other than a vihuela deprived of its first and sixth string"—but M. Engel has, by mistake, given the name of vihuela to the earliest guitars with four strings, as upon the portico of the church of Sant-Jago li Compostella, and others. In England, in the sixteenth century, the vihuelas were termed Spanish viols, and are so named among the musical instruments left by Henry VIII., but eventually they were reinstated in the name of Spanish guitars, while the old English cittern, strung with wire, and the number of strings increased from four to six (single or double), was the guitar of the last century. M. Engel has not recognised this change. The English had also a small instrument with four catgut strings, very like the four-stringed Spanish guitar called the gittern, or ghittern. It differed chiefly from the Spanish instrument in having a lute-shaped back instead of a flat one. M. Engel does not explain how this instrument differed from the guitar, although he has given to another its Latinised name, quinterna or guinterna.

Again, it is not in accordance with English usage to term large pieces of bamboo partially split, in order that, by shaking them, the sides may be rattled together, "castanets;" neither were castanets called *crotala* by the ancients, as M. Engel supposes. The ancient castanets were made of nut-shells, cockles, oyster-shells, or small pieces of metal, and were called *krembala*. "And beating down the limpets from the rocks," says Hermippus, "they made a noise like castanets" (*κρεμβάλιζοναι*). The *krotala* were maces and other large and loud rattles to be used in the worship of Cybele. Sometimes the two parts were detached and held in two hands, and sometimes they had a hinge or spring at one end, to be sounded by closing the hand suddenly so as to knock one against the other. The stork was called *crotalistris*, from the noise made by the bird in striking together the two bones of its beak.

M. Engel's history is a little at fault when he writes that "The earliest organs had only about a dozen pipes," and that "The largest, which were made about 900 years ago, had only three octaves, in which the chromatic intervals did not appear" (p. 108). This passage must be looked upon only as a prelude, intended to magnify, by contrast, the improvements which have been made in Germany and other parts of the Continent of late years. It can have no other meaning—for the organ at Winchester had 400 pipes in the tenth and eleventh centuries. It is fully described by a contemporary musician, the author of a once celebrated, but now lost, treatise, *De Tonorum Harmonia*. Two lines of extract will suffice:—

"Sola quadringentas quae sustinet ordine musas,  
Quas manus organici temperat ingenii."

Wolstan's *Life of St. Swithun*.

M. Engel makes also a mistake of from 400 to 500 years in the date of a manuscript, and, acting upon this mistake, he claims priority for Germany over England for the first use of the fiddle-bow. Strings have but a fleeting tone, unless it be sustained by friction, and the principle is so simple as to be intelligible at one glance,

and therefore to be readily adopted. But the first example yet discovered is in an Anglo-Saxon MS. of the earlier half of the eleventh century, where one gleeman is playing the fiddle while another is throwing up and catching three balls in rotation (Cotton MS., Tiberius, c. vi.). This is the figure with the primitive fiddle:—



FIG. 5.—Anglo Saxon Fiddle. XI<sup>th</sup> Century. (British Museum.)

It will be seen that the shape of the body of the instrument prevents the use of the finger-board for the production of the higher notes, and to obviate this difficulty, a hole was subsequently made through the back, so that the performer's hand might have more command over the strings. In this form the Anglo-Saxon or early English name was *cruth*, Anglicè, *crowd*, a crowder and a fiddler being synonymous.

"The fiddler's crowd now squeaks aloud," &c.



FIG. 6.—Crowd. English. About the XIII<sup>th</sup> Century.

The third stage of improvement was to diminish the size of the body, to give it indented sides so as to allow free action to the bow, and lengthen the neck, as in the



early English *citra*, *cetera*, or more modern *cittern*. "Fu la cetera usata prima tra gli Inglesi," says Galilei. Examples of instruments of this kind are frequent, but M. Engel startles us by exhibiting the following as an original "*German Fiddle*, IXth century, St. Blasius."

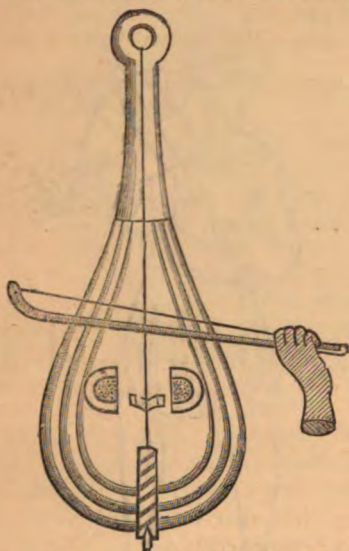

FIG. 7.—Fiddle String. XIIIth Century. (St. Blaise.)

The above is copied from Gerbert's "*De Cantu et Musica Ecclesiæ*," vol. ii., and is derived from a manuscript which was formerly in the monastery of St. Blaise, and which Gerbert describes as "about 500 years old!" (ex cod. San. Blas. annorum. circ. 500, p. 139) as he wrote in 1774. That would bring the date to the second half of the *thirteenth* century, instead of the eighth or ninth, as M. Engel states in his text. Moreover the plate is not intended to exhibit a fiddle, but a *fiddle-string*. It is called *lyra*, and the word is explained in two of the glossaries collected by Mr. T. Wright. A fiddle would have had more strings than one, in the thirteenth century, and the strings would have been fastened to pegs instead of a single string passed through a ring.

It will be seen from the above that the claims for Germany are put forth in the strongest light by M. Engel, and that other countries may not so readily acquiesce in them. We ourselves should raise many demurrers to his claims and conclusions, but they would apply to the prefatory essay and to the musical instruments of Europe, rather than to those of the rest of the world. While we cannot but wish that M. Engel's nationality had been less strongly developed, he is justly entitled to the credit of having ably fulfilled his commission, and of having exerted extensive research.

#### OUR BOOK SHELF

*Notes on the Practical Chemistry of the Non-Metallic Elements and their Compounds.* By William Procter, M.D., F.C.S., Lecturer on Chemistry at St. Peter's School, York. (London: Simpkin, Marshall, and Co. York: the Northern Educational Trading Co.)

THIS is a handbook on the Practical Chemistry of the Non-metallic Elements, designed to meet the requirements of pupils of Mechanics' Institutions, and of Science

Classes of a similar kind. The true man of science welcomes every worthy means of spreading scientific truth, and does everything in his power to propagate that truth. He will regard with a jealous eye each work brought forward with a view of extending a knowledge of the sciences; and with a work intended for the use of a class whose opportunities of gaining knowledge are very limited, his scrutiny will be all the closer. A book written for the information of such should be couched in the simplest language, and the sense conveyed should be at once clear and comprehensive. In these respects Dr. Procter's little work cannot be termed a success. To use no stronger expression his language is frequently very vague. For example, on page 14 the author in speaking of "*Chemical Affinity*" says: "hence, in order that this force may be exercised by the particles coming within the sphere of each others' attraction, the substances must be in the state of liquid or gas." There can be but one way of understanding the latter part of this quotation, viz., that no chemical action can take place, unless the materials taking part in that action are each and all of them in a liquid or gaseous state. Dr. Procter is scarcely less happy in his definitions of bases, acids, &c. He says: "An acid is a compound of an electro-negative radical with hydrogen, which hydrogen it can exchange for a metal or basylous radical, and it is therefore replacable." Again, "A salt is a compound produced by the action of a base upon an acid with the displacement of the hydrogen of the latter." How can such definitions convey to the minds of pupils proper ideas of the true natures of acids and bases? Such explanations would not inappropriately be termed *indefinitions*. Chapters are devoted to chemical calculations, and chemical manipulations, and here doubtless the readers will find many useful hints for their guidance in the preparation of their apparatus, &c. In the body of the book Dr. Procter treats of the non-metallic elements, giving the ordinary methods of preparing them, and their compounds, and illustrating the characteristics of each by interesting and instructive experiments. A few pages devoted to the chemistry of water, qualitative analysis of gases, and the preparation of ordinary reagents, complete a book, which, designed for a good purpose, and containing much useful information, at the same time shows want of care in compilation, and also lacks lucidity. Printer's errors are much too numerous.

#### LETTERS TO THE EDITOR

[The Editor does not hold himself responsible for opinions expressed by his correspondents. Neither can he undertake to return, or to correspond with the writers of, rejected manuscripts. No notice is taken of anonymous communications.]

##### The Use of the Words "Weight" and "Mass"

Nothing could illustrate more forcibly the necessity of rendering definite the meaning of some of our present fundamental terms in connection with the science of dynamics, than a comparison of my letter to you on this subject (vol. xiii. p. 325) with the letter of Mr. Stoney, in reply to it (vol. xiii. p. 385), and that of Mr. Walker who follows Mr. Stoney.

When we who call ourselves teachers do not agree as to the signification of the most elementary terms we use, it is not to be wondered at, if those who come to learn should fail to attain clear ideas on a part of the science, where such confusion of nomenclature prevails.

My letter to you was for the purpose of pointing out an ambiguity of language, and of suggesting, in order to get rid of this ambiguity, not an alteration of the meaning of any word whatever, but a very simple restriction in the use of words, and the bringing into more frequent employment a very valuable old word—*gravity*—which has been lying ready for use but left almost idle. Mr. Stoney admits the ambiguity to be a very real one.

Mr. Stoney, however, says: "I fear Mr. Bottomley's remedy,



if adopted, would introduce quite as serious, perhaps a more serious ambiguity. Gravity is an acceleration. When we say that gravity is less in a balloon, or in a mine, than at the surface of the earth, or greater at Glasgow than at Manchester, we are speaking of alterations of  $g$ —the acceleration due to the earth's attraction; and it would create confusion to employ this word to designate forces also."

Now I do not think that the use of the word gravity as an acceleration is at all common. On the contrary, I have looked into all the books at my command and I cannot find any support whatever for such a use of the word. Every one is accustomed to speak of the "force of gravity." To speak of the force of an acceleration would be a complete anomaly.

All the dictionaries that I have seen support my view that gravity means force, and does not mean acceleration. Take, for example, a good modern book, the Imperial Dictionary. There I find—Gravity (Lat. *gravitas* from *gravis*, heavy). 1. Weight, heaviness. 2. In philosophy—that force by which bodies tend or are pressed, or drawn towards the centre of the earth—and so on; showing that gravity always means force, though it has various shades of meaning in its occasional applications.

Chambers' Encyclopædia says that the force which causes bodies to fall towards the earth is termed *gravity*. The article goes on to speak of the force of gravity at the earth, at various heights above the earth, and at the moon. Acceleration is nowhere mentioned as a meaning of the word gravity.

Even if it could be shown that a few people have so far departed from the original etymological sense and prevailing use of the word gravity, as to employ it for an acceleration instead of for a force, this would only prove that the word is, to that limited extent, subject to ambiguity at present. The course that I advocated was to avoid ambiguity by employing the word *gravity*, used in its most common, and most authoritative sense, instead of a thoroughly ambiguous word *weight*, in certain cases where misapprehension from the use of the latter word is likely to occur.

It seems to me that Mr. Stoney and Mr. Walker have been led away by thinking of the letter  $g$ , rather than of the important question at issue. The letter  $g$  stands for a number. One way of specifying what number  $g$  stands for, is to say that it is the numerical expression for the acceleration due to gravity, that is, the acceleration due to the force of gravity acting on a falling mass. But this is simply because  $g$  is the number which represents the force in Gaussian units on unit mass, and because the force of attraction on any body is proportional to the mass of the body. The latter is an experimentally discovered law. To say with Mr. Walker that "the symbol ' $g$ ' is gravity," and with Mr. Stoney that "gravity is an acceleration," seem to me expressions equally elliptic on the one hand, and, without full explanation, misleading on the other.

If Mr. Stoney offers any method of getting rid of the ambiguity better than that already introduced, others will gladly adopt it. As to Mr. Walker's proposal to confine the use of the word "weight" to mean force, my former letter was partly for the purpose of showing this to be impossible. The act of parliament, regulating weights and measures, settles that matter. Mr. Stoney's letter forms, also, a sufficient answer to Mr. Walker's proposal.

University, Glasgow, March 27 J. T. BOTTOMLEY

P.S.—Allow me to thank Mr. Barrett for his information as to the earliest use of spring balances for kilodynes.

If Mr. Walker is serious in proposing to use *vires* for British kinetic units of force, he ought to avoid *centivires* and *millivires* for 100 vires and 1,000 vires respectively. These would be utterly incompatible with the use of the prefixes *centi*, *hekto* and *milli*, *kilo* in the now established metrical system.

#### Birds as Astronomical Objects

THE following note which appears in the last number of *Stray Feathers* (iii. p. 419), seems to deserve more attention from astronomers than it will perhaps receive unless published where it will meet the eyes of others than Indian ornithologists. I beg leave, therefore, to ask that it may be reproduced in NATURE.

"Looking at the sun this morning, I saw birds very frequently pass the disc. Some were in focus with the sun itself, the wings being quite sharp against the disc, and must have been several miles high, but some were much nearer, and I estimate

their distance from me at about two miles by the focus required to see them. These last must, however, have been quite a mile above the earth's surface, and of course many were a great deal higher.

"I suppose they were Kites, but the appearance there was rather as though the wings were long and narrow like those of Swallows, whereas I should have expected the points to be blunted by the irradiation.

"The estimated distance between the tips might be a couple of feet.

"Possibly this may interest some of the readers of *Stray Feathers*.

"J. TENNANT, R.E.

"Roorkee, 23rd September, 1875."

On this note the editor of *Stray Feathers*, Mr. A. O. Hume, remarks:—

"Many of those birds must have been quite invisible to the naked eye. I have no doubt that Vultures, Kites, and Eagles often soar for hours at heights at which they are thus invisible to us, though we and our doings are quite within the grasp of their far-seeing gaze. This would help to account for the marvellous manner in which, when an animal is killed in the plains, an apparently speckless sky becomes in an incredibly short space of time crowded with 'an heavenly host.'"

We know so little with respect to the height at which birds do or can fly, that I am sure all ornithologists would gladly avail themselves of any observations on the part of helioscopists or other astronomers that would bear upon the matter, and I may add that perhaps the evidence they could offer might be of importance as regards the migration of birds. In Mr. Hume's remarks I entirely concur.

ALFRED NEWTON

Magdalene College, Cambridge, March 25

#### How Typhoid Fever is Spread

THE case in which the poison of typhoid fever mixed with drinking water was transmitted through nearly a mile of porous earth, and which was mentioned in the abstract of my discourse to the Fellows of the Chemical Society (NATURE, vol. xiii., p. 331), is fully described (in German) in the 6th Report of the Rivers' Commission on the Domestic Water Supply of Great Britain. It will shortly appear, in English, in the Monthly Journal of the Chemical Society. Meanwhile perhaps I may be allowed to trespass upon your space with the following remarks:—The outbreak of typhoid fever occurred at the village of Lausen, near Basel, in Switzerland, and it was exhaustively investigated by Dr. A. Hägler of Basel, who has given a full account of it in the "Deutsches Archiv. f. Klin. Med. xi." The source of the poison was traced to an isolated farmhouse on the opposite side of a mountain ridge, where an imported case of typhoid, followed by two others, occurred shortly before the outbreak. A brook which ran past this house received the dejections of the patients and their linen was washed in it. This brook was employed for the irrigation of some meadows near the farm-house, and the effluent water filtered through the intervening mountain to a spring used in all the houses of Lausen, except six which were supplied with water from private wells. In these six houses no case of fever occurred, but scarcely one of the others escaped. No less than 130 people, or seventeen per cent. of the whole population, were attacked, besides fourteen children, who received the infection whilst at home for their holidays, and afterwards sickened on their return to school.

The passage of water from the irrigated meadows to the spring at Lausen was proved by dissolving in it, at the meadows, 18 cwt. of common salt, and then observing the rapid increase of chlorine in the spring water; but the most important and interesting experiment consisted in mixing uniformly with the water 50 cwt. of flour, not a trace of which made its way to the spring, thus showing that the water was filtered through the intervening earth and did not pass by an underground channel.

These are the main features of the case, but there are other interesting details showing how carefully the investigation was conducted; for these, however, I must refer Mr. Mitchell Wilson to the works above cited. It affords a clear warning of the risk which attends the use, for dietetic purposes, of water to which even so-called purified sewage gains access; notwithstanding that, as at Lausen, such water may have been used with impunity for years, until the moment when the sewage became infected with typhoid poison.

E. FRANKLAND



Lisbon Magnetic Observations

MR. DE BRITO CAPELLO, Director of the Lisbon Magnetic Observatory, having addressed to me several interesting results having reference to the notice of his observations which appeared in NATURE, vol. xiii. p. 301, I am anxious to communicate them to your readers.

With reference to the movement of the declination magnet from 8 A.M. to 2 P.M. Mr. Capello gives me the following mean values for each year from 1858 to 1875:—

1858 ... .. 8.74	1867 ... .. 6.15
1859 ... .. 10.54	1868 ... .. 7.17
1860 ... .. 10.11	1869 ... .. 8.42
1861 ... .. 9.00	1870 ... .. 10.83
1862 ... .. 7.84	1871 ... .. 10.60
1863 ... .. 7.65	1872 ... .. 9.45
1864 ... .. 6.94	1873 ... .. 8.22
1865 ... .. 6.61	1874 ... .. 7.23
1866 ... .. 6.19	1875 ... .. 6.09

These quantities, Mr. Capello remarks, show the maxima 1859.8 and 1870.9, and the minimum 1867.1, agreeing very nearly with the epochs of maximum and minimum sun-spots.

It also appears as if the minimum had been reached again last year, the mean oscillation (6.09) being less than in 1867. This agrees with the conclusion derived by me from the Trevandrum observations, and communicated to the French Academy of Sciences last year. Dr. R. Wolf had previously (as I now find<sup>1</sup>) concluded from his sun-spot observations that the minimum would probably appear in 1875-6; and he considers we have now one of the short periods, which his tables of sun-spots show may be expected every 80-90 years. My own conclusion to the same effect (that we have now a short period) was founded on a consideration of the magnetic observations. The last short period was that from the maximum 1829.7 (shown by Arago's observations) to that of 1837.5 (shown by Gauss's observations), an interval of rather less than eight years. If we may take 1875.5 as the epoch of the present minimum, then the interval from the last is nearly nine years. As the interval from the minimum of Arago (1824.2) to the next was nearly 9.2 years, we find a space of nearly forty-two years from the last short period to this one. Should this hold for the next maximum it will occur about 1879.0.

Mr. Capello has obtained the interesting result that the curve showing the mean diurnal disturbance of the vertical magnetic force is the exact inverse of that for the mean diurnal disturbance of declination at Lisbon; a movement of the north pole of the declination magnet towards the west corresponding to one downwards of the south pole of the balance needle. It appears also that the difference of sign in the temperature coefficient for the balance magnet due to changes of the compensation bar from brass to zinc and zinc to brass, on which a remark was made in NATURE, vol. xiii. p. 302, does not affect the results for the diurnal variation, each year giving the same mean law of a minimum vertical force between 11 A.M. and noon, and a maximum near 5 P.M. whatever the sign of the temperature coefficient. It appears also that the results at Lisbon are confirmed by those obtained at Coimbra, ninety miles to the north.

JOHN ALLAN BROWN

The Early History of Continued Fractions

THE reviewer in NATURE, (vol. xiii., p. 304), very properly points out that the first mathematician who used continued fractions was Cataldi, and not Lord Brounker, as is still often stated.

To this fact I drew attention in a pamphlet, published in 1874, not then knowing that De Morgan had done the same many years ago. There is, however, in connection with the same subject, another historical fact almost equally interesting, which few in this country seem to be aware of, and which therefore it may be desirable to bring before your readers.

Daniel Schwenter, a professor at Altdorf, in the first quarter of the seventeenth century, made use of the present well-known process for expressing the ratio of two integers as a continued fraction, and calculated the convergent, exactly in the mode at present followed. He does not indeed seem to have written as we now do the actual continued fraction obtained in any case,

<sup>1</sup> "Astronomische Mittheilungen," 38, p. 378, July 1875.

but the process of repeated division, and the mode of finding the convergents were most fully described and exemplified by him.<sup>1</sup>

The following, therefore, seems to be, in few words, the early history of continued fractions:—

1. Cataldi published, in 1613, his discovery that the square root of an integer can be expressed as an interminate continued fraction, e.g.,

$$\sqrt{18} = 4 + \frac{2}{8 + \frac{2}{8 + \frac{2}{8 + \dots}}}$$

2. Schwenter, almost certainly without knowledge of what Cataldi had done, published in 1636 the mode of changing an ordinary fraction into a continued fraction with unit-numerators, and of calculating therefrom convergents to the given fraction, e.g.,

$$\frac{117}{233} = \frac{1}{1 + \frac{1}{3 + \frac{1}{6 + \frac{1}{4 + \frac{1}{2}}}}}$$

3. Brounker, very probably in ignorance of what had been done by Cataldi and Schwenter, made the discovery that

$$\frac{\pi}{2} = \frac{1}{1 + \frac{1}{2 + \frac{4}{2 + \frac{9}{2 + \dots}}}}$$

which was published by Wallis in 1655 ("Arithmetica Infinitorum" p. 181), along with a tolerably complete theory of continued fractions in general.

The necessary details bearing on these three main facts will be found in a painstaking work by Prof. Favaro, "Notizie Storiche sulle Frazioni Continue," Roma, 1875, or in shorter form, in a school "programme" by Dr. Günther, "Beiträge zur Erfindungsgeschichte der Kettenbrücke," 1872.

That Cataldi, Schwenter, and Brounker, starting from totally different points should all light on the continued fraction form, and that it should be twice (perhaps nearly thrice) lost, are certainly strange facts, forming a curious chapter in the history of scientific discovery.

THOMAS MUIR

High School of Glasgow

The Dry River-beds of the Riviera

MR. R. E. BARTLETT (NATURE, vol. xiii. p. 406) asks for some theory to account for the existence of the broad stony river-beds of Piedmont. He instances the Paglione at Nice, which is indeed the merest rudiment of a river for the greater part of the year. But if Mr. Bartlett will wait, not so much for the snows on the Maritime Alps to be melted, as for the rainy weeks of autumn to come again,

Quam fera diluvies quietos  
Irritat amnes,

he will see that that now despicable river annually flows with a vehemence and a volume worthy of its size. Many a dry and insignificant torrent-bed in the neighbourhood of Nice swells during the rainy season to a torrent indeed; the thoroughness with which they then drain the adjacent slopes is amply sufficient to explain their existence and their appearance when their "occupation's gone."

HENRY T. WHARTON

London, April 2

The Flame of Common Salt

HAVING been much interested in the progress of the investigations concerning the blue flame of common salt when thrown into a coal fire, I made the following experiments, by which I came to the conclusion that the origin of the blue flame is due to the presence of copper, which occurs in nearly every coal as an ingredient of the pyrites.

According to "Berzelius," by agency of the blow-pipe, small

<sup>1</sup> See "Daniel Schwenter, Delicia physico-mathematicae," Nürnberg, 1636, p. 111. "M. Daniel Schwenter's Geometriae practicae novae et auctae, Libri IV." durch Georgium Andream Böcklern, Nürnberg, 1657, p. 431.



traces of chlorine can be discovered by dissolving at first a larger quantity of oxide of copper in a bead of microcosmic salt; if, then, any substance containing chlorine be brought in contact with the bead on the point of the blue jet, the blue flame of the blow-pipe is coloured azure blue; the same colour is even exhibited when chloride of sodium and oxide of copper are heated in the bead; the yellow flame of the sodium is scarcely visible, and does not conceal the azure blue flame.

In making the above experiment, I immediately suspected that the blue light imparted to the coal corresponds with the light of the microcosmic bead, the chlorine of the salt combines with the copper, which burns with the azure blue flame.

To convince myself that the blue colour is not due to any other cause, I took a charcoal fire free of copper, and threw salt into it; the salt gave a slightly yellow flame of sodium, and not the minutest trace of a blue flame could be discovered, though large quantities of salt were used, but on throwing the slightest quantity of oxide of copper on to the charcoal, the azure blue colour occurred instantly.

The following chlorides, HCl, KCl, NH<sub>4</sub>Cl, BaCl<sub>2</sub>, CaCl<sub>2</sub>, which I had at my disposal, exhibited more or less a blue colour when cast into a coal fire.

T. N. MÜLLER

Middleton St. George

OUR ASTRONOMICAL COLUMN

DOUBLE STARS.—Baron Dembowski communicates to the *Astronomische Nachrichten*, Nos. 2,076–2081, his later measures of double-stars, amongst which is a considerable number of well known binaries. The measures are given in a slightly modified form from that adopted in most of the Baron's previous important communications, which commenced in vol. 62 of the above periodical.

For the sake of facilitating a comparison with the best-determined orbits of revolving double-stars, we extract a few of the most recent Gallarate epochs or means of the year's measures:—

Name of Star.	Year.	Position.	Distance.	Position (c - o).	Distance (c - o).
Castor ... ..	1875'25	235°03	5'54	+ 0°94	+ 0°39
ζ Cancri ... ..	1875'14	130°94	0'74	+ 0°88	- 0°05
ξ Ursæ Maj. ... ..	1875'27	317°56	1'09	+ 6°44	- 0°13
γ Virginis... ..	1874'93	159°35	4'77	+ 0°80	0°00
ξ Bootis ... ..	1874'89	286°32	4'54	+ 1°12	+ 1°02
η Coronæ Bor. ... ..	1875'41	66°69	0°86	- 3°13	- 0°13
ξ Scorpii ... ..	1874'96	68°97	7'12	- 1°80	+ 0°06
ζ Herculis ... ..	1875'52	149°09	1'41	- 1°20	- 0°09
70 Ophiuchi ... ..	1875'52	83°72	3'48	+ 3°11	+ 0°85
δ Cygni ... ..	1875'02	335°26	1'60	- 1°13	- 0°14
z 3062 ... ..	1875'67	292°17	1'47	- 4°62	+ 0°14

The orbits with which the above comparisons have been made are by the following calculators; the periods of revolution are added.

Castor ... ..	Thiele ... ..	996'85 years.
ζ Cancri ... ..	O. Struve ... ..	62'4 "
ξ Ursæ Majoris ... ..	Hind ... ..	60'68 "
γ Virginis ... ..	Thiele ... ..	185'01 "
ξ Bootis ... ..	Hind ... ..	168'9 "
η Coronæ Bor. ... ..	Wijkander ... ..	41'58 "
ξ Scorpii ... ..	Thiele ... ..	49'05 "
ζ Herculis ... ..	Dunér ... ..	34'22 "
70 Ophiuchi ... ..	Schur ... ..	94'37 "
δ Cygni ... ..	Behrman ... ..	415'1 "
z 3062... ..	Schur ... ..	112'64 "

Comparisons are omitted in the cases of several binaries, the orbits of which have been worked up to about present time, principally by Dr. Doberck, of Markree Observatory. Mr. W. Plummer's orbit of ζ Cancri gives the angle 15° greater than the measures, the distance nearly agreeing. The orbit of ξ Ursæ Majoris by Dr. Ball, of Dunsink Observatory, Dublin, is not available as printed in the "Monthly Notices" of the Royal Astronomical Society, the excentricity being omitted, and the same element has escaped also in Dr. Doberck's orbit of σ Coronæ Borealis.

THE EQUATOR OF MARS.—Sir W. Herschel's determination of the position of the plane of the equator of this planet, from observations made in the autumn of 1783, was communicated to the Royal Society in December of the same year. He found for the inclination of the axis to the orbit, 61° 18', and therefore for the obliquity on the globe of Mars, 28° 42'; the inclination of the axis to the ecliptic, 59° 42', the north pole being directed in 1783 to longitude 347° 47'. From these figures we deduce for the ascending node of the equator of Mars upon that of the earth (N) 48° 9', and its inclination thereto (I) 41° 27'.

Olbiers, from the observations of Schroeter and Harding, on the south polar spot upon Mars in October and November, 1798, found for the longitude of this pole 172° 54'·7, and the latitude 60° 33'·2, and hence we have for the ascending node of the equator on the orbit, 84° 54', and for the obliquity on Mars, 27° 57'; the ascending node of the equator of Mars upon the terrestrial equator 50° 29', and the inclination 39° 14'.

But the determination which has been generally relied upon as the best yet available is that made by Dr. Oudemans, now director of the Observatory at Batavia, from measures by Bessel with the Königsberg heliometer, 1833–37. For about 1834·0 he found the longitude of the north pole of Mars 349° 1', and its latitude 61° 9'. The node of the orbit of the planet in the ecliptic being at this time in 48° 16', and the inclination 1° 51', we have for the ascending node of the equator of Mars on his orbit, 80° 50', and for the obliquity of the Martial ecliptic, 27° 16', and therefore for the ascending node of the equator of Mars upon the terrestrial equator, 47° 34', and its inclination, 39° 56'. Assuming these figures to apply to 1834·0, we get for 1877—

$$N = 47^{\circ} 55' \quad I = 39^{\circ} 46'.$$

A SOUTHERN COMET (?).—The *Wanganui Herald* (N.Z.), of January 20, says:—"What appeared to be a small comet was visible in the south, in the constellation of Argo Navis, for about two hours last night, the rising moon rendering it invisible. It was very small, and appeared to be rapidly moving towards the east." The summary number of the *Melbourne Argus* of January 25 has no reference to the visibility of a comet, and the above notice at present requires confirmation.

PROF. FLOWER'S HUNTERIAN LECTURES ON THE RELATION OF EXTINCT TO EXISTING MAMMALIA<sup>1</sup>

VI.

THE order *Cetacea* is one of peculiar interest, having many specialities of structure, and being sharply defined from all other groups, with no outlying or doubtful forms at present known. Being purely aquatic animals, and all of considerable size, their remains are more readily preserved than those of some other orders. None, however, have been met with in the well-explored deposits of the cretaceous seas, or indeed in any European strata (with the doubtful exception of the cervical vertebrae of *Palaeocetus* from Ely), earlier than the Miocene. Abundant remains are, however, found in various Miocene and Pliocene marine beds, notably at Antwerp, in many parts of France, Germany, especially the Vienna basin, Italy, and South Russia. They are also found, though in a less perfect condition, in the crags of the east of England. In the Eocene deposits of the eastern states of America, the strange and gigantic Zeuglodon occupies the place of the ordinary *Cetacea*, which occur in the Miocene and later ages.

Among the existing members of the order there are two very distinct types, the toothed whales or *Odontocetes*,

<sup>1</sup> Abstract of a course of lectures delivered at the Royal College of Surgeons "On the Relation of Extinct to Existing Mammalia, with Special Reference to the Derivative Hypothesis," in conclusion of the course of 1873. (See Reports in NATURE for that year.) Continued from p. 410.



and the baleen whales or *Mysticetes*, and none of the known extinct forms present true transitional or intermediate characters; but it must be remembered that even such remains as have been already collected have not yet been thoroughly worked out. The *Mysticetes* appear, at first sight, the most specialised and aberrant, in the absence of teeth, in the presence of whalebone or baleen, in the form and size of the mouth; but as we see in other groups, dental characters and all such as relate to the prehension of food generally, are essentially adaptive, and consequently plastic or prone to variation, and hence cannot well be relied upon as tests of affinity. In another character, also adaptive, the laxity of the connection of the ribs with the vertebral column and with the sternum, and the reduction of that bone in size, allowing great freedom of expansion of the thoracic cavity, for prolonged immersion beneath the water, the *Mysticetes* have passed beyond the *Odontocetes* in specialisation. On the other hand, the great symmetry of the skull, the more anterior position of the nares, and their double external orifice, the form of the nasal bones, the presence of a distinctly developed olfactory organ, the mode of attachment of the periotic bone to the cranium, the presence of a cæcum, and the regular arrangement of the alimentary canal, the more normal characters of the manus and the better development of the muscles attached to it, and the presence (in many species at least) of parts representing a hind limb, all show less deviation from the general mammalian type than is presented by the *Odontocetes*. Taking all their structural characters into consideration, as well as what we know of their past history, it does not appear that we can consider either type to have been derived from the other, at all events in the form in which we see it now, but must rather view them as parallel groups.

Among the *Mysticetes*, in the especially distinguishing characters of the division, the *Balenoptera* are less specialised than the *Balaena*, which in the greater size of the head, the length and compression of the rostrum, the development of the baleen, and the shortness of the cervical region, are exaggerated types of the former, and yet they retain more fully some primitive characters, as the better development of the hind limb, the pentadactylous manus, and the absence of a dorsal fin. Both forms are found distinct in a fossil state as far back as the early Pliocene, but generally represented by smaller species than those now existing. The *Mysticetes* of the Miocene seas were, as far as we know at present, only *Balenoptera*, some of which (*Cetotherium*, Brandt) were, in the elongated flattened form of the nasal bones, the greater distance between the occipital and frontal bones at the top of the head, and the greater length of the cervical vertebrae more generalised than those now existing. In the form of the mandible they are considered by Van Beneden to present more approximation to the Cetodonts.

Among the toothed whales, the earliest known form, the *Zeuglodon*, was far the most aberrant, approaching in the structure of its skull and teeth to a more generalised but very low carnivorous type. In smallness of cerebral cavity, compared to the mouth and other parts of the skull, it is as far below all other known cetaceans, as the singular *Arctocyon primævus* is below all carnivores. One could quite imagine that the skull of a very degraded seal would present many features in common with *Zeuglodon*, and this is the only near link we seem to possess between the Cetacea and the rest of the animal world. All the resemblances which some naturalists have seen between the skull of *Zeuglodon* and the *Sirenia* are purely superficial and imaginary. The forward position of the narial aperture and the length and flatness of the nasal bones which this animal possesses in common with (though to a greater extent than) the *Mysticetes*, we may suppose to be common primitive cetacean characters, though completely lost in all other known *Odontocetes*.

Even the *Squalodons*, which in dental characters so much resemble the *Zeuglodons* as to have been placed in the same genus by some zoologists, agree in their essential cranial characters with the ordinary dolphins. They are, in fact, dolphins with double-rooted molar teeth, peculiar to the Miocene formations of Europe and America. Among existing dolphins, *Platanista* has been considered to conform most to the general type of mammalian structure. It is therefore interesting to find a similar form (*Champsodelphis*) well represented among the earliest fossil remains of Cetaceans in Europe, and others abundant in North America. Apart from these the greater number of toothed whales range themselves under the two principal heads of *Ziphioids* or *Physeteroids*, and *Delphinoids*. The former are an ancient group, of which the remains are exceedingly numerous in the Antwerp and Norwich crags, and of which the existing sperm whale is a highly modified and specialised form. Among the latter, *Delphinus* and its various modifications may be regarded as the dominating type of Cetaceans at the present day, abundant in slightly differentiated species, and abundant in individuals. They are in this respect to the rest of the order, much as the hollow-horned ruminants are to the Ungulates.

It seems in vain at present to speculate upon the origin of the Cetacea. They present no marks of closer affinity to the lower classes of Vertebrates than do the rest of their own class. Indeed, in all that characteristically distinguishes a Mammal from the oviparous Vertebrates, especially in the nervous and reproductive systems, they are far above many other groups of the class. There is no existing order of land mammals to which they can be said to be decidedly and unquestionably allied. Their agreement with the *Sirenia* is mainly in modifications of structure adapted for a somewhat similar mode of existence, while in many essentials the difference between them is as wide as that between any other two orders. Taking into consideration many of their habits, and their food, and bearing *Zeuglodon* in mind, a relationship to the Carnivora through the seals seems indicated; but if the mode of development has the weight many modern zoologists are disposed to assign to it, their affinities would be rather with the Ungulates, an order from which, on other grounds, they are far removed.

(To be continued.)

#### ON REPULSION RESULTING FROM RADIATION.—PART IV.<sup>1</sup>

IN this paper the author describes experiments on the repulsion produced by the different rays of the solar spectrum. The apparatus employed is a horizontal beam suspended by a glass fibre, and having square pieces of pith at each end coated with lampblack. The whole is fitted up and hermetically sealed in glass, and connected with an improved mercury-pump. In front of the square of pith at one end a quartz window is cemented to the apparatus; and the movements of the beam, when radiation falls on the pith, are observed by a reflected ray of light on a millimetre-scale. The apparatus was fitted up in a room specially devoted to it, and was protected on all sides, except where the rays of light had to pass, with cotton-wool and large bottles of water. A heliostat reflected in a constant direction a beam of sunlight, which was received on an appropriate arrangement of slit, lenses, and prisms for projecting a pure spectrum. Results were obtained in the months of July, August, and September; and they are given in the paper graphically as a curve, the maximum being in the ultra-red, and the minimum in the ultra-violet. Taking the maximum at

<sup>1</sup> Abstract of a paper read before the Royal Society, Feb. 10, 1876, by William Crookes, F.R.S., &c.



100, the following are the mechanical values of the different colours of the spectrum :—

Ultra-red ... ..	100
Extreme red ... ..	85
Red ... ..	73
Orange ... ..	66
Yellow ... ..	57
Green ... ..	41
Blue ... ..	22
Indigo ... ..	8½
Violet ... ..	6
Ultra-violet ... ..	5

A comparison of these figures with those usually given in text-books to represent the distribution of heat in the spectrum is a sufficient proof that the mechanical action of radiation is as much a function of the luminous rays as it is of the dark heat-rays.

The author discusses the question, "Is the effect due to heat or to light?" There is no real difference between heat and light; all we can take account of is difference of wave-length; and a ray of a definite refrangibility cannot be split up into two rays, one being heat and one light. Take, for instance, a ray of definite refrangibility in the red. Falling on a thermometer it shows the action of heat, on a thermopile it produces an electric current, to the eye it appears as light and colour, on a photographic plate it causes chemical action, and on the suspended pith it causes motion. But all these actions are inseparable attributes of the ray of that particular wave-length, and are not evidence of separate identities.

The author enters into some theoretical explanations of the action of the different parts of the spectrum, but these cannot well be given in abstract.

An experiment is described by which sunlight was filtered through alum, glass, and water screens, so as to cut off the whole of the ultra-red or dark-heat rays. The ray of light which was thus freed from dark heat was allowed to fall on the pith surface of the torsion-apparatus, when it produced a deflection of 105°. On interposing a solution of iodine in disulphide of carbon the deflection fell to 2°, showing that the previous action was almost entirely due to light. With a candle tried under the same circumstances, the light filtered from dark heat produced a deflection of 37°, which was reduced to 5° by interposing the opaque solution of iodine.

In order to obtain comparative results among discs of pith coated with lampblack and with other substances, a torsion-apparatus was constructed in which two or more discs could be exposed one after the other to a standard light. One disc always being lampblackened pith, the other discs could be changed so as to get comparisons of action. If the action of radiation from a candle on the lampblackened disc be taken as 100, the following are the proportions obtained :—

On Lampblackened pith ... ..	100
Iodide of palladium ... ..	87·3
Precipitated silver ... ..	56
Amorphous phosphorus ... ..	40
Sulphate of baryta ... ..	37
Milk of sulphur ... ..	31
Red oxide of iron ... ..	28
Scarlet iodide of mercury and copper ... ..	22
Lampblackened silver ... ..	18
White pith ... ..	18
Carbonate of lead ... ..	13
Rock-salt ... ..	6·5
Glass ... ..	6·5

In consequence of some experiments tried by Professors Tait and Dewar, and published in NATURE, vol. xii. p. 217, the author fitted up a very sensitive apparatus for the purpose of carefully examining the action of radiation on alum, rock-salt, and glass. The source of radiation was a candle. Perfectly transparent and highly polished plates of the same size were used, and the deflection was

made evident by an index ray of light. Taking the action on the alum at 100, that on the rock-salt in five successive experiments was 81, 77·3, 71, 62·5, 60·4. This increasing action on the alum was found to be caused by efflorescence, which took place rapidly in the vacuum, and rendered the crystal partially opaque. A fresh alum plate being taken, this and the rock salt were coated with lampblack and replaced in the apparatus, the black side away from the source of radiation, so that the radiation would pass through the crystal before reaching the lampblack. The action of radiation was in the proportion of blacked alum 100 to blacked rock-salt 73.

Rock-salt and glass were next tested against each other *in vacuo* in a torsion-balance. Professors Dewar and Tait say that rock-salt is inactive when the beam from a candle is thrown on it, while a glass disc is active. The author has failed to corroborate these results; he found the mean of several concordant observations to be—rock-salt 39, glass 40.

*The Measurement of the Force.*—The author describes a torsion-balance in which he is enabled to weigh the force of radiation from a candle, and give it in decimals of a grain. The principle of the instrument is that of W. Ritchie's torsion-balance, described in the Philosophical Transactions for 1830. The construction is somewhat complicated, and cannot be well described without reference to the diagrams which accompany the original paper. A light beam, having two square inches of pith at one end, is balanced on a very fine fibre of glass stretched horizontally in a tube, one end of the fibre being connected with a torsion-handle passing through the tube, and indicating angular movements on a graduated circle. The beam is cemented to the torsion-fibre, and the whole is enclosed in glass and connected with the mercury-pump and exhausted as perfectly as possible. A weight of 0·01 grain is so arranged that it can be placed on the pith or removed from it at pleasure. A ray of light from a lamp reflected from a mirror in the centre of the beam to a millimetre-scale 4 feet off shows the slightest movement. When the reflected ray points to zero, a turn of the torsion-handle in one or the other direction will raise or depress the pith end of the beam, and thus cause the index ray to travel along the scale to the right or to the left. If a small weight is placed on one end so as to depress it, and the torsion-handle is then turned, the tendency of the glass fibre to untwist itself will ultimately balance the downward pressure of the weight, and will again bring the index ray to zero. It was found that when the weight of the  $\frac{1}{100}$  of a grain was placed on the pith surface, the torsion-handle had to be turned twenty-seven revolutions and 353°, or 10073° before the beam became horizontal. The downward pressure of the  $\frac{1}{100}$  of a grain was therefore equivalent to the force of torsion of the glass thread when twisted through 10073°.

The author next ascertained what was the smallest amount of weight which the balance would indicate. He found that 1° of torsion gave a very decided movement of the index ray of light, a torsion of 10073° balancing the  $\frac{1}{100}$  of a grain, while 10074° overbalanced it. The balance will therefore turn to the  $\frac{100000000}{100}$  of a grain.

Divide a grain weight into a million parts, place one of them on the pan of the balance, and the beam will be instantly depressed.

Weighed in this balance the mechanical force of a candle 12 inches off was found to be 0·000444 grain; of a candle 6 inches off 0·001772 grain. At half the distance the weight of radiation should be four times, or 0·001776 grain; the difference between theory and experiment being only four millionths of a grain is a sufficient proof that the indications of this instrument, like those of the apparatus previously described by the author, follow rigidly the law of inverse squares. An examination of the differences between the separate observations and the mean shows that the author's estimate of the sensitiveness



of his balance is not excessive, and that in practice it will safely indicate the millionth of a grain.

One observation of the weight of sunlight is given; it was taken on December 13; but the sun was so obscured by thin clouds and haze that it was only equal to 10·2 candles 6 inches off. Calculating from this datum, it is seen that the pressure of sunshine is 2·3 tons per square mile.

The author promises further observations with this instrument, not only in photometry and in the repulsion caused by radiation, but in other branches of science in which the possession of a balance of such incredible delicacy is likely to furnish valuable results.

### SCIENCE IN GERMANY

(From a German Correspondent.)

A FEW years ago Edlund attempted to decide the question whether the galvanic current is capable of directly altering the volume of a conductor through which it flows, or not, *i.e.*, whether changes of volume were demonstrable that were independent of the heat produced in the conducting wire? The results of his experiments appeared to furnish an affirmative answer to this question. More recently, Streintz published an investigation, the result of which was a confirmation of Edlund's view on the expanding power of the galvanic current. The expanding action found by Edlund was from 2·8 to 6·5 per cent. of the action of the heat simultaneously produced; that found by Streintz was considerably greater. In soft iron it amounted to 27 per cent. of the action of the heat.

From the fundamental importance which attaches to this question, in relation to the theory of galvanism, and from the difficulty of demonstrating the volume-changes referred to, apart from the actions of the heat simultaneously produced, it was desirable that the subject should be investigated by a method as free from error as possible. Such an investigation has lately been carried out by Herr Exner, in Vienna. The essential points of his method are as follows:—

Two pieces, *a* and *b*, of the same wire, about equally long, were suspended vertically one over the other, as indicated schematically in the figure. The lower piece, *b*, passed centrally through a glass tube, *c*, which was quite open above, but closed below with a cork, which merely gave passage to the wire *b* by a short glass tube

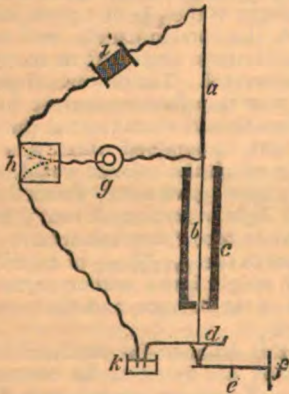

(2mm. wide) inserted in it. From the lower end of the wire *b* hung the plate *d* for holding weights. This was furnished at its base with a sharp iron point, meant to act on one arm of a lever which could be turned about *e*, while the other arm bore the mirror *f* at right-angles to its axis, and so in a vertical plane. If the image of a vertical scale were observed in this mirror with a telescope, the least change in length of the wires *a* and *b* could thereby be perceived. From the point of con-

nection between *a* and *b* a wire was connected with the battery *g*. The other pole of the battery was connected with the commutator *h*, and thus the current could be sent either through the rheostat *i* to the suspending point of the wire *a* and through the latter back to the battery, or on the other side to the mercury cup *k*, in which is dipped the bent end of a short copper wire soldered to the plate, *d*, establishing thus a conductive connection between the commutator *h* and the wire *b*. Through the latter the current then went back to the battery. One could thus easily send the current successively through each of the two wire-pieces, *a* and *b*, separately, and so observe the elongation experienced by each. Since, as has been said, the two pieces *a* and *b* were not exactly equal in length, their elongations were also not exactly equal; to make them equal, the rheostat *i* was inserted, by which the resistance in the circuit *g h i a g* was so regulated, that with unchanged battery the successively observed elongations of *a* and *b* were the same. Water was now allowed to pass through the glass tube *c*, in order to take away as much as possible of the heat produced in the wire *b* by the galvanic current. If, now, the current passed through *b*, only the elongation which might occur independently of the heat action of the current would be observed, the heat produced being removed by the flowing water.<sup>1</sup> If, however, the current passed through *a*, both an elongation produced in *a* through direct action of the current, and the elongation through action of heat would be observed at the same time. [These experiments might of course also be made with only one piece of wire, *e.g.* *b*. The second piece *a*, serves only for making the observations more quickly in succession.]

It was found that the galvanic expansion expressed in percentage of the heat-expansion was only about 1·2 to 2·2 per cent.; and no connection was recognisable with the nature of the metal employed. If it be considered that these values, of course, can only be an upper limit, it will follow from the smallness of the effect obtained that there is no sufficient ground for the hypothesis of a special expansion-power of the galvanic current. There can hardly be any doubt that the slight expansion which the water-inclosed wire still shows is simply and alone due to the heat remaining in it. W.

### THE INTERNATIONAL METRIC COMMISSION AT PARIS

IN previous numbers of NATURE<sup>2</sup> some information has been given of the proceedings of the International Metric Commission of Paris, and of the progress of their work in providing new international standards of the metric system. The construction of the new standard metres and kilogrammes of platinum-iridium, which was entrusted to the French section of the Commission, is now approaching completion, and their comparisons with the old standards of the Archives and with each other will probably be commenced early this spring.

It has been already explained that the definitive verification of the new standards was entrusted by the Commission to a permanent committee of twelve of their members, each representing one of the principal civilised countries interested. For the purposes of providing the committee with the necessary means of exercising their duties, and of giving an authoritative international character to the new standards, and to the regulations to be adopted for the custody and use of the new international metric prototypes, a diplomatic conference was held at Paris in March 1875, when a convention was entered into for effecting these objects.

Papers relating to the meeting and proceedings of this diplomatic conference, drawn up by Mr. Chisholm, the Warden of the Standards, who was the representative of

<sup>1</sup> It may happen that the heat of the wire is not entirely carried off by the flowing water.

<sup>2</sup> Vol. vii. pp. 197 and 237; vol. viii. p. 403; vol. x. p. 130.



Great Britain at the Conference, were laid before both Houses of Parliament last session by Her Majesty's command. Some further information upon the subject is contained in the Ninth Annual Report of the Warden of the Standards, recently published.

The following is a summary of the terms of the Convention, which bears date Paris, May 20, 1875.

By the two first Articles the high contracting parties agree to found and maintain at their common expense an International Bureau of Weights and Measures, scientific and permanent, its seat to be at Paris. The French Government will undertake to facilitate the acquisition, or if requisite, the construction of a building to be specially appropriated for this purpose.

Article 3 fixes the conditions under which the International Bureau will execute its functions. It is to be placed under the exclusive direction and superintendence of an International Committee of Weights and Measures, which itself is to be under the authority of a General Conference of Weights and Measures formed of delegates from all the contracting Governments.

The President for the time being of the Academy of Sciences at Paris is to be the President of the General Conference of Weights and Measures. But this body will not be called into existence until the verification of all the new standards shall have been completed, when it will be convoked for the purposes of sanctioning them and their distribution. All the Governments who send delegates to the International Metric Commission will be entitled to be represented at the General Conference.

Articles 5 and 6 relate to the organisation of the International Bureau, the International Committee, and the Conference General. The duties of the International Bureau are specified as follows:—The verification and conservation of the new metric prototypes of the metre and kilogramme, the construction of which has been entrusted to the French Section of the International Metric Commission; the verification of all the copies of these prototypes and their periodical comparisons; the verification and comparison of geodesical measuring instruments; and the comparison and verification of standards and scales of precision.

Articles 7, 9, and 10 fix the establishment of the International Bureau and the mode of defraying the expenses by contributions from all the contracting governments, according to a scale based on the respective amounts of their actual population.

These expenses are limited by Articles 5 and 6 of the Regulations annexed to the Convention to the total amount of 400,000 francs (16,000*l.*) for establishing the Bureau and providing it with all the requisite instruments, together with an annual sum not exceeding 100,000 francs (4,000*l.*) for the current expenditure, reducible to 50,000 francs (2,000*l.*), after the completion and distribution of the new national metric standards.

Articles 11, 12, 13 of the Convention reserve the right to every other civilised state to take part in it, under specified conditions; and enable the contracting parties by common agreement to make all such modifications in the terms of the Convention as may be found by experience useful; they also allow any of the contracting parties to withdraw from the Convention at the expiration of a term of twelve years.

A series of Regulations are annexed to the Convention, which fix the details of the organisation of the International Bureau, and of the composition and functions of the International Metric Committee and of the General Conference. Some transitory provisions are also annexed, relating to the completion of the construction of the new standards by the French Section, and their verification and distribution; as well as the mode of constituting the new International Committee and the General Conference.

At the Conference, the sittings of which were continued

during March and April 1875, twenty of the principal civilised countries were represented, viz.:—Germany, Argentine Republic, Austria and Hungary, Belgium, Brazil, Denmark, Spain, United States of America, France, Great Britain, Greece, Italy, Holland, Peru, Portugal, Russia, Sweden and Norway, Switzerland, Turkey, and Venezuela.

The Convention was signed by the plenipotentiaries of seventeen of these countries. The Governments of three countries—Great Britain, Holland, and Greece—declined to take part in the Convention. They were willing to take part in it, and to contribute towards the expenses of the International Bureau, if its objects were limited to the verification of the new metric standards and the custody and use of the new prototypes, but they refused to take part in a Convention which established a permanent international institution for other and larger scientific objects, and for promoting the progress of the Metric System.

Further grounds for the refusal of the British Government were that by the terms of the Convention the International Metric Commission, to which delegates from this country were appointed by the Government, was virtually suppressed, and its functions and duties transferred to the new Committee; that the *propagation* of the metric system was declared to be one of the primary duties of the new General Conference, thus sanctioning the objectionable precedent of directly authorising a scientific body to interfere with national usages in countries where the metric system has not been adopted.

The result of their Governments declining to take part in the Convention has been that the representatives of Great Britain and of Holland have been compelled to decline to act upon the new International Committee, which was fixed by the Convention to be formed of the twelve members of the Permanent Committee, with the addition of the representatives of Italy and Switzerland. The Committee now consists of the following twelve members, who are to have the direction of the International Bureau:—

General Ibañez,	representing Spain, President.
Dr. Förster,	Germany.
Dr. J. Herr,	Austria.
M. Stas,	Belgium.
General Morin,	France.
Prof. Hilgard,	United States of America.
Dr. Wild,	Russia.
General Baron Wrede,	Sweden.
Prof. Broch,	Norway.
Husny Bey,	Turkey.
Prof. Govi,	Italy.
Dr. Hirsch,	Switzerland, Secretary.

Under the terms of the Convention, the ratifications were to be exchanged on Dec. 20, 1875, and the committee to enter on their full functions on Jan. 1, 1876. Meanwhile, as soon as the provisional instrument of the Convention was signed by the plenipotentiaries on April 15 last, the Committee were authorised at once to constitute themselves and to make their preliminary arrangements. They accordingly held five meetings and elected their president and secretary, as already stated, and they provisionally appointed Prof. Govi director of the International Bureau. By Article 6 of the Regulations annexed to the Convention, the yearly salary of the secretary to the Committee is fixed at 6,000 francs (240*l.*), and that of the director of the Bureau, who is to reside there, is fixed at 15,000 francs (600*l.*). The Committee at the same time selected the Pavillon Breteuil in the park of St. Cloud as the site of the Bureau.

On Dec. 20, 1875, the representatives of eleven out of the seventeen contracting Governments met at Versailles, and exchanged ratifications of the Convention. It was announced that the Governments of Austria and Hungary, the United States of America, and Portugal, had



not yet been able to obtain the sanction of their Legislatures for the ratification of the Convention, and they requested further time for this purpose. The Argentine Republic and Venezuela also requested further time, and the requests were granted. Brazil alone declined to ratify the Convention and take part in its objects.

Before the adjournment of the late French National Assembly, they passed a law which was introduced by the French Government to grant the Pavillon Breteuil at St. Cloud, with some adjoining land, to the directors of the International Bureau for the purposes of this scientific institution, so long as it shall continue in existence.

The following appear to be the approximate proportions which the several contracting States will have to contribute towards the expenses of the new International Metric Bureau, based on Article 20 of the Regulations, by which the unit of contribution is to be determined from the population of each State, expressed in millions, and multiplied by the coefficient 3 for those countries where the metric system is adopted compulsorily; by 2 where it is adopted permissively; and by 1 for other countries.

States.	Population in Millions.	Coefficient.	Product of Units.	Approximate Contributions.		
				Establishment.	Annual, First Period.	Annual, Second Period.
1. Germany ... ..	41	3	123	£2,353	£587	£294
2. Argentine Republic	2	1	2	38	10	5
3. Austria ... ..	20	3	60	2,066	516	258
4. Hungary ... ..	16	3	48			
5. Belgium ... ..	5	3	15	287	72	36
6. Denmark ... ..	2	1	2	38	10	5
7. Spain ... ..	25	3	75	1,434	358	179
7. United States of America ... ..	42	2	84	1,607	402	201
8. France ... ..	38	3	114	2,181	545	272
9. Italy ... ..	27	3	81	1,550	387	194
10. Peru ... ..	3	3	9	172	43	21
11. Portugal ... ..	7	3	21	402	100	50
12. Russia ... ..	83	1	83	1,598	400	200
13. Sweden ... ..	4	1	4	76	20	10
13. Norway ... ..	2	1	2	38	10	5
14. Switzerland ... ..	3	3	9	172	43	21
15. Turkey ... ..	38	3	102	1,950	487	244
16. Venezuela ... ..	2	1	2	38	10	5
	360	—	836	£16,000	£4,000	£2,000
Approximate units of contribution ...				£19	£5	£2 10

If Great Britain had taken part in the Convention, the contribution from this country towards the expenses of establishing the International Bureau would have been about 600*l.*, and towards the annual expenditure for the first period about 150*l.* a year.

The International Committee are now therefore in a position at once to commence operations. They are to meet at least once a year, and between their session can deliberate and pass resolutions by correspondence. They considered that at least a year must elapse from Jan. 1, 1876, before their new building and instruments will be ready for use. They therefore passed a resolution charging their executive to notify to the French Section that the Committee would not be prepared to commence their comparisons and verifications of the new Metric Standards before the spring of 1877. This will give plenty of time to the French Section to complete the construction of these new Standards and to make all such comparisons with the Standards of the Archives and with each other as may be necessary to ascertain

their values with the requisite precision, before delivering the Standards to the International Committee for definitive verification.  
H. W. CHISHOLM

PHYSICAL SCIENCE IN SCHOOLS

IT may contribute profitably to the discussion of the subject of Physical Science in Schools, if I state briefly the experience of an effort, extending over twenty-eight years, to give this subject a prominent, if not its merited place in our work. I may say that my boys rarely go to a university, and are almost wholly absorbed in professions, manufactures, and commerce.

Mr. Tuckwell's propositions (NATURE, vol. xiii., p. 412) are good, but perhaps the following modifications are better:—

1. The business of a school is general education; the business of a university is special education.
2. The branches of study for the general education of a school should be Language, Mathematics, Natural Science, and Art.
3. Some knowledge of each of these should be imposed on every pupil; but each pupil should be allowed to apply himself chiefly to that branch of study for which he shows the most natural aptitude, and which therefore will to him be the best means of education.

4. The matriculation examinations for entrance to the universities should require a fixed standard of knowledge of all these branches of education; and give equal honours for excellence in either.

I think this would place science on an equal footing with language and mathematics, in both school and university, and would in due time relieve us of the conventional pedantry which regards language as the only sufficient standard of an educated man, and ignorance of the simplest elements of science as no disgrace.

Now for our own practice and experience. At nine or ten years of age our boys get simple lessons on wild flowers, which they collect, are taught to examine and describe, and write a simple account of; necessary help of course being given.

On graduating to the upper school, which they do from ten to twelve years of age, they get three hours a week for descriptive lessons on botanical and zoological subjects, with reproductions and as much of classification as is practicable; and on meteorological phenomena and heat, illustrated by the daily and seasonal variations that affect themselves. The object here is to cultivate the observing powers, to induce discrimination of distinctive features, and to promote a thoughtful apprehension of the most easily discerned natural phenomena.

In the next grade four hours are given to science, and the study becomes more special. Mechanics is the subject taken, and if this subject be treated simply, and care be taken not to overrun the mathematical knowledge, it may be made sufficiently attractive, and a valuable means of thoughtful training in science.

In the next grade two hours a week are taken from mechanics, and chemistry is begun.

In the next grade the other two hours are taken from mechanics, and given to physiology—1. Vegetable; 2. Animal; so that the subjects here are physiology and chemistry with manipulation. In this grade, also, one hour a week is taken from the two commonly given to geography, and given to political economy. The boys in this grade will also often give special time to chemical manipulation, and to practical work in physiology. We have also workshops where a considerable amount of very good work in both wood and metal is regularly turned out, play time only being used.

It may be that I am rather exacting on my own efforts, but I have never been satisfied with our science teaching, and the current discussion of the subject in NATURE has added very materially to my dissatisfaction. To be dis-



satisfied with one's work, however, is one thing; how to make it better is quite another. In chemistry we have perhaps all the means commonly employed. In physiology we can get objective illustrations brought into the class-room, and can use the microscope and diagrams. In mechanics our workshops supply practical work, but for the class-room we have only the most homely practical examples, and I know of no apparatus that is not cumbersome, needlessly costly, or ineffectual. Johnstone's admirable illustrations and the black-board are our chief agents. I would travel far to get a practical knowledge of means and methods by which we could improve our own, in teaching this subject.

I believe that such knowledge as I have indicated may be profitably given even to very young boys. They learn thereby to distinguish the precise features and qualities of natural objects, and the conditions of ordinary phenomena; and such teaching undoubtedly exercises in the best way the observing powers which develop much earlier than the reflective faculty. I am inclined to say that teaching elementary science to boys from ten to thirteen is a greater success than teaching grammar, *i.e.*, that the principles involved are more easily seen, excite more interest, and become therefore a better mental discipline. We rarely have boys come to us with any knowledge of science, and when they have, it has generally been acquired from lectures, and is worthless as a means of education. We do not lecture, but do real hard class-work, and take periodical examinations on this work, giving it equal value in these and our grade examinations with language and mathematics. We have no reason to believe that this work interferes with or deteriorates the work in language and mathematics, in which subjects we find our boys quite equal, and, except in very rare cases, I may say, superior to incomers of like power, and who have had no science teaching.

The great number of men eminent for their vast scientific attainments, who have achieved this eminence in spite of our non-scientific, I may almost say anti-scientific system of education, clearly indicates that many of us have an inherent scientific power or genius surpassing our power in any other direction. I plead for such that they have the same chance of being floated on their scientific voyage as the linguist and the mathematician have on theirs: and I have seen no satisfactory plea why they should not. Value for value I claim for the science man a higher status in our present social life than is due to either linguist or mathematician.

My experience as a schoolmaster has revealed to me many cases where the talent for language or mathematics has been so low that the education effected by these has been of the meanest kind; or where the incessant failure has produced a stolid ignorance, a kind of mental paralysis, most disheartening to all concerned. Such cases have come into my hands, and I have seen intelligence rekindled, and mental power aroused by simple science teaching, and the power even for other subjects enhanced thereby. I plead for these feeble ones. Is it not a crime to them to keep the mind fixed on what to them is abstruse and unintelligible, and to shut against them the inspiring book of nature, which may contain the only intellectual sunshine of which their being is susceptible?

Allesley Park College, Coventry

T. WYLES

I shall be obliged if you will permit me to remind Mr. Wilson of certain passages in his article contained in "Essays on a Liberal Education."

In his letter (*NATURE*, vol. xiii. p. 373) Mr. Wilson writes:—

"I maintain, after trial, that it is unwise, and unscientific from an educational point of view, to attempt to teach science at schools to boys till they have attained a certain standard of knowledge in arithmetic, and a certain power of reasoning and language as shown by their

attainments in geometry and Latin. Let science be held before them as a thing to be enjoyed when they are older and more advanced. It is spoiled for them, and they are spoiled for it by its being taught them too soon. The dicta of men like Faraday and Sir John Lubbock and Roscoe are misleading opinion on this point, and I wish to record my protest against them."

But in "Essays," &c., Mr. Wilson wrote:—"Moreover, the kind of knowledge that science offers is not only wide and interesting and elevating, but it is also exact; and this exactness is a very great merit. It is a knowledge of things and not of words. In the education of the upper classes there is too little of positive and exact knowledge. . . . And natural science supplies this want of clearness and certitude better than arithmetic or geometry." And again:—

"But here is even a stronger ground for advocating the introduction of science as an element in all liberal education, and that is its peculiar merit as a means of educating the mind. . . . All that can be said on this point has been said over and over again, and I can contribute nothing except my daily experience that what is said is true. . . . Science is the best teacher of accurate, acute, and exhaustive observation of what is. . . . And of all processes of reasoning it stands alone as the exhaustive illustration."

Giggleswick, April 4

W. MARSHALL WATTS

#### NOTES

THE date now finally fixed for the opening of the Scientific Loan Exhibition is the 1st of May. This delay is entirely owing to the unexpected richness and variety of the collection. Germany alone sends upwards of 2,500 objects, many of them of the greatest value. Although France has sent some very fine objects for exhibition, she will, on the whole, be rather poorly represented. The Italians are sending all the riches of their storehouse at Florence, including Galileo's telescopes.

ON the 31st ult. a meeting, at which several well-known English biologists were present, took place at the house of Dr. Burdon-Sanderson, at which the advisability of establishing a society or association for the purpose of promoting the progress of physiological research in England, was considered and discussed. Eventually the matter was referred to a committee, who will report to a future meeting; after which some conversation followed as to the question of legislation, the general feeling of those present being that no opposition ought to be made on the part of scientific men to any measure framed in accordance with the recommendations of the Royal Commission.

A MOVEMENT has been organised for erecting a monument to the late Jean Baptiste Donati. The idea originated with the professors of the Physical and Natural History Museum of Florence, and it is proposed to erect the monument in the new observatory of Arcetri, which was in a manner Donati's work. We are sure there are many admirers of Donati in this country who will gladly subscribe to such a monument. The foreign Legations and Consuls of Italy are authorised to receive and transmit subscriptions to the Committee for Donati's monument, to whom they may be sent direct, at the Natural History Museum, Florence.

It is proposed to raise by subscription a fund for the purpose of establishing a Memorial in honour of the late Daniel Hanbury; the amount of each contribution not to exceed one guinea. The form suggested for the memorial is that of a medal to be called the "Hanbury" medal, to be awarded for original research in the Chemistry and Natural History of Drugs by investigators in any part of the world. Dr. Hooker, Sir George Burrows, Sir James Paget, Sir Robert Christison, Dr. Allman, Dr. Warren de la Rue, Prof. Abel, and Mr. T. Hyde



Hills, have already expressed their cordial approval of the movement, and consented to be placed on the Committee now in course of formation; Prof. Atfield and Messrs. Carteighe and Bremridge are acting provisionally as secretaries.

LIEUT. CAMERON arrived at Liverpool in the *Congo* on Sunday, and as might be expected, was received with the greatest enthusiasm. Besides his relatives there were present the Liverpool municipal authorities, and Mr. Tinne, as representative of the Royal Geographical Society. Lieut. Cameron was attacked by scurvy on reaching the west coast of Africa, but is now to all appearance quite recovered, and looks strong and well. On Monday he was quite the lion of Liverpool, where he was fêted and toasted and justly treated as a hero who has accomplished a great and useful work. He gives a glowing account of the interior of Africa, and hopes that his journeyings will lead to its commercial development. There is no doubt that at the meeting of the Geographical Society next Tuesday, in St. James's Hall, he will meet with a warm reception. On Tuesday he met with a hearty welcome on his return to Shoreham, near Sevenoaks, of which place his father is vicar.

A COMMISSION of the Geographical Society of Paris has awarded the Society's Great Medal to Dr. Nachtigal, the German North African explorer. It is stated that owing to the arrival of Lieut. Cameron, steps will be taken by the Society to award extraordinary honours to the British explorer who has done so much for African discovery. The anniversary meeting of the Geographical Society is to take place on the 9th of April.

A DISCOVERY of great importance to prehistoric archaeology has just been made in France. On March 2, while some workmen were excavating in a quarry of Jurassic limestone, near the little commune of Cravanche, about three kilometres N.W. of Belfort, at the base of a hillock, they came upon a small opening which was found to lead into a cave of large dimensions. On entering the cavern its floor was found to be covered with human bones, so disposed as to lead to the belief that the cave formed a prehistoric place of sepulture. Magnificent stalagmitic columns rise from the floor, but without corresponding stalactites. It would seem as if these columns were partly natural and partly artificial, as they appear to be disposed in a sort of systematic method, after the form of dolmens. It is in these cavities that the multitude of bones have been found. The skulls are raised slightly above the level of the rest of the bodies, which appear to be in a somewhat bent position. Several polished flint weapons have also been found, three beautiful ornamented vases in the form of urns, polished stone bracelets, and a mat of plaited rushes. The cave itself is calculated to be about 36 metres long and about 12 in breadth and height; and numerous galleries, or side-caverns, run off the main one. Immediately on the discovery of the cavern, the authorities of Belfort took measures to guard it and the treasures it contains in the interests of science, and M. Félix Voulot, who has given great attention to the subject of prehistoric archaeology, has been charged with carrying on the researches. M. Voulot hopes to be able to disengage from the stalagmitic covering at least one entire skeleton. There is no doubt that we have here important remains of the polished stone period, but it is confidently expected that further research will bring to light relics of a much older period; indeed the writer in the *Revue Scientifique*, of April 1, from which the above details are taken, hopes that remains will be found not only belonging to the Tertiary, but even to the Cretaceous period. The cavern is situated in a bed of one of the lower strata of the Jurassic period (lower oolite), "on the exact limit of the shore of the ancient Jurassic sea."

THE following arrangements of the Royal Institution lectures after Easter have been announced:—Prof. P. M. Duncan, F.R.S.: Four lectures on the Comparative Geology and former

Physical Geographies of India, Australia, and South Africa; on Tuesdays, April 25 to May 16. Prof. Tyndall, D.C.L., LL.D., F.R.S.: Seven lectures on Voltaic Electricity; on Thursdays, April 27 to June 8. Prof. W. K. Clifford, F.R.S.: Two lectures on the Present Relations of Science and Philosophy; on Saturdays, April 29 and May 6. Prof. W. G. Adams, F.R.S.: Three lectures on some of Wheatstone's Discoveries and Inventions; on Tuesdays, May 23 to June 6. Frederick J. Furnivall: Two lectures on Chaucer; on Saturdays, May 13 and 20. J. A. Symonds: Three lectures on the Medici in relation to the Renaissance; on Saturdays, May 27 to June 10. The Friday evening meetings will be resumed on April 28, at 8 P.M., when Prof. Gladstone will give a discourse on Methods of Chemical Decomposition illustrated by Water. Discourses will probably be given by G. J. Romanes, W. Froude, C. T. Newton, J. F. Moulton, Sir John Lubbock, and Prof. Tyndall.

IN the Mauritius *Overland Commercial Gazette* of March 3, Mr. Meldrum refers to a small but violent cyclone which swept over the island on Feb. 19. Although its approach was announced by the Observatory on the previous day, it was only on the evening of the 18th that it was known with certainty that a gale was imminent. The wind was at its strongest between 2 and 7 A.M. on the 19th, and during that interval it had a velocity of 66.5 to 77.5 miles per hour. The lowest barometric pressure was 29.102 at 4 A.M. on the 19th, and during the night the mercury oscillated considerably. Between 3 and 4.30 A.M. several flashes of lightning were observed. The rainfall at the Observatory was only 2.94 inches. The chief interest of this cyclone is an unusual rate of progression, and the suddenness with which it came on. Its centre passed N. and N.W. of the island at a distance of forty to fifty miles. On the 23rd and 24th it was evident that another cyclone was approaching; fortunately, however, after approaching from the N.E. to about 160 miles of the colony, the storm recurred to the southward, otherwise the colony would have suffered severely. Mr. Meldrum mentions, as an interesting coincidence, that from the 10th to about the 22nd a large sun-spot was visible.

AT the concluding Gilchrist Lecture to the Students of the St. Thomas Charterhouse School of Science, Mr. W. E. Forster, M.P., occupied the chair, and spoke of the importance of teaching science in elementary schools, and of the ungrounded apprehension that thereby rudimentary education would be neglected. He believed it was the duty of the country to give children in elementary schools as much learning in science as they could obtain while they remained there, and should not be afraid to teach them science because their station in life was humble. He believed that if science were substantially and practically taught it would do nothing but good. He was well aware that some of those who had taken part in the education movement thought that if science were taught in elementary schools there would be increased danger of the neglect of good elementary teaching; but he did not think there was any ground for such apprehensions; on the contrary, he thought it would be found that, generally speaking, where science was taught best there was the best teaching of such elements as reading, writing, and arithmetic.

WE regret to hear of the death, at the age of sixty years, of Dr. Letheby, the well-known analyst, for many years Medical Officer of Health for the City of London, and Lecturer on Chemistry at the London Hospital. Dr. Letheby was a Fellow of the Linnean and Chemical Societies.

THE death is announced of Signor Severino Grattoni, the Italian engineer, who, amid great obstacles, carried out the execution of the Mont Cenis Tunnel.

THE Iron and Steel Institute concluded its London Meeting last Friday; the papers read were all of a purely technical



nature. There are now about 900 members of the Institute, the next meeting of which will be held in Leeds in September.

THE Institution of Naval Architects commences this year's session to-day, and will continue its meeting to-morrow and Saturday in the hall of the Society of Arts. Lord Hampton, G.C.B., D.C.L., president, will occupy the chair. Among the many papers to be read are the following:—On the unequal onward motion in the upper and lower currents in the wake of a ship, and the effects of this unequal motion on the action of the screw propeller, by Prof. Osborne Reynolds.—On the theory of pitching, by W. Froude, F.R.S., Vice-president.—On the telegraph-ship *Faraday*, by C. W. Merrifield, F.R.S., Associate Member of Council.—On the propulsion of bodies, by R. Griffiths.—On a new form of hydraulic propeller, by M. E. François.

AT the conclusion of Prof. Huxley's Course of Lectures at Jermyn Street, which we are reporting, Mr. F. Wilson proposed a vote of thanks to the lecturer, and alluded to the state of Prof. Huxley's health. The vote was enthusiastically responded to, and Prof. Huxley, in reply, remarked that the gentleman who had kindly proposed the vote of thanks was under a mistake about his health, he was never better in his life; but, as it had been truly said, "If you had been ill it took at least four years to persuade your friends that you were well again."

THE *Pandora*, Capt. Allen Young's yacht, is now being prepared at Southampton for another voyage to the Arctic regions in search of despatches from the expedition under the command of Capt. Nares. The yacht will be ready for sea in the course of a few weeks.

WE are requested to state that Mr. E. B. Tylor gives his lecture on "Ordeals and Oaths" to-morrow evening at the Royal Institution; there seems to have been some misunderstanding as to the date.

WE believe there are a good many people who would wish to visit the *Challenger* on her return to England, while all her equipments are *in situ*, before she is gutted. We are sure that if the authorities are made aware of the existence of such a desire on the part of the public, they will make arrangements to gratify it.

ON Easter Monday and following days the Geologists' Association will make an excursion to Nottingham and Belvoir Castle.

IT is stated as probable that the site of the proposed International Exhibition at Paris in 1878 will be the Bois de Boulogne and Passy.

M. BALARD, the well-known natural philosopher, who has taken part in most of the International Exhibitions that have been held, has died at Paris at the age of seventy-four. M. Balard was a member of the Academy of Sciences for more than thirty years. He was Professor of Chemistry at the Sorbonne. He leaves no written book, but his teaching was much admired.

ON March 25 an earthquake was felt at Algiers and vicinity at 6h. 34m. in the morning. The duration was three seconds. A second movement, less intense, was felt at 7h. 2m. in the afternoon. In the evening a strong storm set in from the S.W., and a deluge of water followed.

WE have received a copy of the rules recently adopted for the Cumberland Association for the Advancement of Literature and Science. The Association consists mainly of a number of local societies in Cumberland, and will hold an annual meeting, at which reports will be read from the affiliated societies, and the objects of the Association furthered by lectures, papers, addresses, discussions, &c. The association intends to publish at

its own expense such portions of its own or of any of the associated societies' communications as may be deemed advisable. The objects of the association are laudable, and we wish it success. Its first annual meeting will be held at Whitehaven in May.

WE would recommend to the notice of teachers, the Rev. George Henslow's paper on "The Practical Teaching of Natural Science in Schools," which is published in *The Educational Times* of March 1, and a paper in the April number by the Rev. P. Magniss, on "The Teaching of Natural Philosophy in Schools."

AT the College examination at Downing College, Cambridge, in June, a Foundation Scholarship, of the value of 80*l.* per annum, will be awarded for proficiency in Natural Science. Particulars may be obtained from the tutors of the College.

SEVERAL important German publications have been forwarded to us; we regret that we are unable to do little more than give their titles. They may all be obtained through Messrs. Williams and Norgate, of London and Edinburgh. Dr. Hermann Hager has published a fifth edition of his useful little work, "Das Mikroskop und seine Anwendung" (Berlin: Sprengel). It is intended as a guide to medical men, pharmacists, students, &c., and is largely illustrated.—"Werden und Vergehen" (Berlin: Bornträger) is the title of a work by Carus Sterne, of Berlin, in which an attempt is made to trace the development of the universe from the nebulous "world-cloud" to man. Its tone may be inferred from the fact that it is admirably dedicated to Prof. Haeckel.—Prof. J. C. G. Lucae has completed his work on the Anatomy of the Seal and Otter, "Die Robbe und die Otter" (Frankfort: Winter), *Phoca vitulina* and *Lutra vulgaris*, a monument of minute research. The first part of this work we noticed in vol. viii., p. 222; the complete work contains thirty-two fine plates.—Dr. M. J. Schleiden has published a curious work on Salt—"Das Salz" (Leipzig: Engelmann), its purpose being to trace the history, the symbolism, and describe the various uses of salt to man. Its main object is to show what an important effect salt has had on human culture.—"Grundriss der anorganischen Chemie" (Leipzig: Voss) is the title of a handbook by Dr. Rudolf Arendt, intended for use in German Middle, Higher, and Training Schools.—Under the title of "Physiologisches Methodik" (Braunschweig: Vieweg) Dr. Richard Gscheidlen, of Breslau University, has published what seems an admirable handbook of practical physiology. It is profusely illustrated with beautifully-executed woodcuts.—Under the title of "Theoretische Kinematik, Grundzüge einer Theorie des Maschinenwesens" (Braunschweig: Vieweg und Sohn), Prof. Reuleaux has published a work on Mechanics which will, no doubt, take a first place among treatises on this subject. Messrs. Macmillan and Co. will shortly publish a translation of Prof. Reuleaux's work.

MESSRS. Williams and Norgate have sent us "Nouveaux Éléments de Physiologie Humaine" (Paris: Baillière), by Prof. H. Beaunis, a work which, we believe, will take a high rank as a text-book.—A French translation of the Guide to Analysis of Water, by Dr. Reichardt, of Jena, has been made by Prof. G. E. Strohl, of Nancy; it is published by Reinwald, of Paris, and sold here by Williams and Norgate.

UNDER the editorship of Mr. R. Brough Smyth there has been published a Descriptive Catalogue of Rocks, Minerals, and Fossils, illustrative of the Geology, Mineralogy, and Mining Resources of Victoria, Australia, intended for exhibition at the Philadelphia International Exhibition. The list contains altogether 880 specimens.

MESSRS. PARKER and Co. have published Prof. Prestwich's lecture "On the Geological Conditions affecting Water Supply to houses and towns, with special reference to the modes of supplying Oxford."



THE Prince of Wales is bringing home with him a large collection of living animals, including, among the most important, two Musk Deer, three Thars, a Manis, three adult Ostriches, four Elephants, five Tigers, three Leopards, sixteen Impeyan Pheasants, more than twenty Tragopans and Cheer Pheasants, several other Deer and Antelopes, together with Fruit Pigeons, Peafowl, &c. These His Royal Highness intends to have exhibited as one collection, and as such they will be deposited in the Gardens of the Zoological Society, a suitable house being in course of erection, and now nearly completed, for their reception.

THE additions to the Zoological Society's Gardens during the past week include a Lesser White-nosed Monkey (*Cercopithecus pelturista*) from West Africa, presented by Mr. F. Ward; a Common Marmoset (*Hapale jacchus*) from South-east Brazil, presented by Mrs. Cleaver; a Wild Sheep (*Ovis burrhel*), an Impeyan Pheasant (*Lophophorus impeyanus*) from the Himalayas, deposited; two Wheatears (*Saxicola arnanthe*), European, purchased; two Cuming's Octodons (*Octodon cumingi*) born in the Gardens.

## SOCIETIES AND ACADEMIES

LONDON

Royal Society, March 23.—“Description of a Mammalian Ovum in an early condition of Development,” by E. A. Schäfer, Assist. Prof. of Physiology in Univ. College.

The author describes the ovum of the cat from five, in the stage where they were rendered evident as scarcely perceptible swellings in the cornua uteri. In their long axes they were  $\frac{1}{4}$  inch long; in their short,  $\frac{1}{5}$  inch. No mesoblast was anywhere present between the hypo- and epiblastic layers, which latter were clearly separable from one another and nearly in contact only in a small part, where only the cells of each were in more than single layers. At this spot also, the cellular elements of each layer being perfectly recognisable, an exquisitely fine pellicle, which in section appears as a mere line, passes over and forms a definite boundary to the outer surface of the hypoblast at the thickened area. This is named the *membrana limitans hypoblastica*, and is found to be perfectly homogeneous and continuous, becoming stained slightly with carmine, and is probably a cuticular formation produced by the underlying cells. This structure seems to have been as yet unnoticed; the mesoblast cells without doubt first appear outside it, which is in favour of the epiblastic origin of that layer.

“On the nature of the force producing the motion of a body exposed to rays of heat and light,” by Arthur Schuster, Ph.D., Demonstrator in the Physical Laboratory of Owens College. Communicated by B. Stewart, F.R.S., Professor of Natural Philosophy in Owens College, Manchester.

Mr. Crookes has lately drawn attention to the mechanical action of a source of light on delicately suspended bodies *in vacuo*; I have made a few experiments with the view of finding out the seat of the reaction which evidently must tend to move either the enclosure or the source of light. I have found that the action and reaction is entirely between the light bodies suspended *in vacuo* and the exhausted vessel.

Mr. Crookes' “Light-Mill” was suspended by means of two cocoon fibres, forming a bifilar suspension from the top of a vessel which could be exhausted. A slight movement of the enclosure could be easily detected by means of a concave mirror attached to it. A beam of the oxyhydrogen lamp was concentrated on the light-mill, which then revolved about 200 times a minute.

The light was cut off at the beginning of the experiment by means of a screen, and the position of rest of the glass vessel was read off by means of the dot of light on the scale. The screen was then suddenly removed, and in every case a large deflection of the glass vessel was observed. The vessel was deflected in the opposite direction to that in which the mill turned. When the velocity of the mill had become constant, the vessel returned to its original position of rest, but on suddenly cutting off the light the vessel was again deflected, but in the opposite direction as on starting the experiment. The vessel therefore now turned in the same direction in which the mill turned.

These experiments are easily explained on the assumption that the force acting on the vessel enclosing the light-mill is exactly equal and opposite to that acting on the mill itself. While the velocity of the mill in one direction is increasing, a force acts in the opposite direction on the vessel. When the velocity has become constant, the force which tends to drive the mill round is exactly counterbalanced by the resistance which opposes the motion of the mill. The two forces acting on the vessel will therefore counterbalance, and the vessel will return to its original position of rest. When the light is cut off, the resistance will stop the motion of the mill. The reaction of the resistance will act on the enclosure, and the enclosure will turn in the same direction as the mill.

By means of the reaction on the enclosure I have been able to calculate the strength of the force; and I have found that the pressure on a surface on which the light of equal intensity to that used in my experiments falls is equal to that produced by the weight of a film of water equal in thickness to the length of a wave of violet light.

March 30.—“On the Placentation of the Lemurs,” by Wm. Turner, M.B. (Lond.), Professor of Anatomy, University of Edinburgh. Communicated by Prof. Huxley, Sec. R.S.

In the introduction to this memoir a description was given of the observations made by M. Alphonse Milne-Edwards on the gravid uteri of several genera of lemurs. The author then proceeded to describe the gravid uteri of six lemurs which he had received from Dr. Andrew Davidson, of Antananarivo, Madagascar, viz., *Propithecus diadema*, *Lemur rufipes*, and *Indris brevicaudatus*. He then summarised the conclusions he had arrived at in the course of his dissections, and showed that the placenta in these animals was diffused, and presumably therefore non-deciduate. The paper concluded with a discussion of the bearing of these observations on the classification of the lemurs, and on the theory of the descent of the deciduate mammals from a primæval root-form of Prosimiæ.

“The Residual Charge of the Leyden Jar,” by J. Hopkinson, M.A., D.Sc. Communicated by Prof. Sir William Thomson, F.R.S.

Linnean Society, March 16.—Prof. Allman, president, in the chair.—Messrs. Edward R. Alston and David Blair were elected Fellows of the Society.—Dr. J. Anderson communicated a note “On the plastron of the Gangetic Mud-turtle, *Emyda dura*,” detailing an instance where eleven instead of the usual nine bones were present. This occurred in an embryo from the egg, and it further appears that ossification and coalescence of the extra pair of bones is coincident with birth.—Mr. A. W. Bennett read a paper “On the rate of growth of the flower-stalk of the hyacinth,” in which he showed that the greatest energy of growth is in the lowermost part of the stalk. This agrees with the recorded observations respecting the relative growth of different nodes of a stem, where the greatest energy is always at a considerable distance from the apex. But it offers a contrast to the phenomena exhibited in the submerged flower-stalk of *Vallisneria*, where the greatest energy of growth is in the terminal portion beneath the flower-bud.—Mr. Francis Darwin laid before the Society the results of his observations “On the hygroscopic mechanism by which certain seeds are enabled to bury themselves in the ground.” These related chiefly to the Feather-grass, *Stipa pennata*, but similar phenomena obtain in other grasses, in *Anemone montana* and certain of the Geraniaceæ (as Hanstein has recorded, 1868). The essential structures are—a sharp point with reflexed hairs, and a strong woody awn, so bent as to possess a lower vertically helical and an upper horizontal part. With moisture the spiral portion of the awn untwists, causing the horizontal part to revolve, while the flexure between them disappears and thus straightens the awn. A reversal of this process succeeds on the awn becoming dry. In the case of *Stipa* the long, feathery, horizontal part of the awn is easily entangled in low vegetation, and the seed retained vertically, with point on the ground. With wetting the awn untwists, but the horizontal part prevented from revolving, the rotation is transferred to the seed, which latter has superadded pressure of its point, by a conversion of the awn to straighten itself. Again, as the awn dries the seed is not pulled out of the ground, but curiously enough is thrust deeper down; the reflexed hairs being subservient. By such combinations and alternate actions complete burial of the seed ensues. The special advantage of seeds being thus imbedded is obscure; in *Stipa* being unconnected with germination, though possibly a



protection from birds. The effects of changes of temperature Mr. Darwin points out. Hildebrand's and Hanstein's explanations of the torsion he thinks inadequate. Darwin's observations prove it resides in the individual awn-cells. When isolated and dried these latter twist on their own axis, similarly in direction, &c., to the awn and with moisture untwist. Finally, this remarkable power is shown to depend on the molecular structure of the twisting cell-walls. Nägeli and others' researches into twisting cells have not led hitherto to their importance in plant life.—The Secretary briefly referred to a technical paper by the Rev. J. M. Crombie, "On the Lichens of Antarctic America collected by Dr. R. O. Cunningham during the Voyage of H.M.S. *Nassau*, 1867-9." In this ninety-seven species and varieties are recorded; twenty-four of these and a genus, *Endocena*, are attributed to be new.—A discussion on the potato fungus followed. At the President's request Mr. Carruthers reiterated the salient features of Prof. de Bary's recent investigations. He called attention to the difference in thickness of the mycelial threads carrying oospores and antheridia, to the septate character of the threads, and to other points collectively adverse to Mr. W. Smith's views of the "resting spore" of *Peronospora*; De Bary believing two fungi have been confounded. The Rev. M. Berkeley defended Mr. Smith's conclusions as opposed to De Bary's, asserting that as the former, by photographs and drawings from nature, had shown the sexual congress of antheridium and oogonium derived from the unequal sized spawn-threads, no reasonable doubt of their connection existed. Admitting De Bary's extensive knowledge of fungi, Mr. Berkeley, nevertheless, objected to his style of criticism. Mr. Smith himself read a long written reply answering De Bary's objections in detail. He averred that Sadebeck's recent observations supported his own as to two sizes of mycelial threads, and the other objections raised with regard to the oogonia and antheridia. As to septal character of the threads, this belongs to *Peronospora*, those of *Pythium* being destitute in this respect. He further alluded to the warty bodies of Montagne's *Artotrogus*, showing De Bary had misconceived their nature. The Strasbourg professor's animadversion on the life-history of Smith's "resting-spore" being yet incomplete is weakened when the former admits it may take a year to resolve, and as yet only nine months have elapsed since the discovery of the bodies in question. Other remarks pertaining to the "resting-spores" being found in dry leaves, after decay in water, and on perennial mycelium were made, Mr. Smith concluding that De Bary had not entirely comprehended his publications on the subject. Mr. Renny expressed his opinion that the points were not absolutely settled on either side, discrepancies still appearing to him to exist. De Bary's objections were allowable on the ground of his extensive acquaintance with the subject, while possibly Smith may not have given the exact value to what he saw. Mr. T. Dyer suggested that the bodies of the so-called *Artotrogus* may be but mycelial dilatations, and not true oogonia; on this ground a fresh investigation might be necessary to ascertain its relations to the questions at issue. Mr. A. Murray, Mr. Cooke, and Dr. Masters each made a few remarks. Mr. Carruthers, in conclusion, thought Mr. Renny had put the case fairly. De Bary only meant to question Smith's knowledge of the conidia, not that he was ignorant of the potato fungus; he, De Bary, may have misunderstood Smith's drawings, but in the elucidation of facts and truths he certainly could not fairly be accused of hypercriticism, seeing that he himself had carefully watched and studied the development, mode of hosts, &c., since 1874.

Geologists' Association, March 3.—Mr. William Carruthers, F.R.S., president, in the chair.—On the Bagshot sands in the Isle of Sheppey, by Major F. Duncan, D.C.L., F.G.S. A recent section, made with the object of lowering a road, has exposed a considerable part of Bagshot sands, colour pale or light yellow, with clay lines, resting on the top of the dark London clay. The distinctive features are absence of green-sands, presence of thin layers and nodules of iron-sandstone, absence of fossils. As there is no discoloration of the sands at the base of the section the author thought they might have been sub-aerial deposits—blown sand; otherwise he considered that there would have been a shading off between the clays and the sands. This theory, the author thought, might serve to explain the well-known variability of this series.—On some rock fragments in the above-described section, by Mr. W. H. Shrubsole. These had been found 6 to 18 inches from the surface and were all igneous, except some specimens of hard sparry limestones. After discussing the possibility of these fragments having been

brought to Sheppey by human agency, the author contended that, although their position in the described section may have been due to such a cause, still that they must originally have been conveyed on ice, towards the close of the Glacial epoch, and been stranded whilst Sheppey was emerging from the sea.—Known facts and unknown problems in Arctic geology, by Charles E. De Rance, F.G.S., H.M. Geol. Survey. The existing glacial phenomena of the Arctic regions, Greenland, and Spitzbergen, were described, marine shells of existing species occurring at heights of more than 1,000 feet above the sea, and living marine Crustacea in fresh-water lakes elevated many feet above the sea-level in Polaris Bay. The observations on the discoloration of the waters of the Arctic Ocean were dwelt upon, and the bearing on the phenomena observable on the English Glacial deposits. The crystalline rocks of the north coast of America and the Greenland coasts were referred to the Laurentian system, and the whole of this area stated to have been land, during the Lower Silurian epoch. The Upper Silurian, however, was shown to be well represented in all the islands of the Arctic Archipelago, and the "Ursa Stage" of Prof. Heer, Devonian, or Lower Carboniferous, with coal-seams, to be present in synclinals in the latter, and also to exist in Spitzbergen and Bear Island, as do the overlying mountain limestones. The Lias and Oolitic rocks of the Arctic Islands, East Greenland, and Spitzbergen were described, and the Cretaceous plant-bearing beds of West Greenland, and their associated coal-seams. The Miocene basalts of Mid-Greenland, with their associated plants, were mentioned as probably connected with the basalts of East Greenland, and as ranging to Spitzbergen.

Physical Society, March 25.—Prof. G. C. Foster, F.R.S., president, in the chair.—The following candidates were elected members of the society:—The Marquis of Salisbury, Prof. Liversidge, W. Ackroyd, Tolver Preston, W. Merritt.—Mr. O. J. Lodge, B.Sc., made a communication on the flow of electricity in a plate, in continuation of a paper which he read before the society on Feb. 26. In order to apply the principle of images already described to the flow of electricity in plates bounded by straight lines, it is necessary that the angles of the plate should be aliquot parts of  $180^\circ$ ; and, since this condition excludes obtuse angles, the number of rectilinear figures which can be treated is very limited. They are rectangles, equilateral triangles, two cases of right-angled triangles, the two limiting cases of the isosceles triangle for which the equal angles are  $0^\circ$  and  $90^\circ$  respectively, and many cases of the general two-sided polygon or "wedge," including the regular two-sided polygon or "strip." Since the images of a pole in a wedge lie on a circle as in a kaleidoscope, Cotes' property of the circle may be applied to obtain expressions for the potential of any point, and for the electrical resistance of the plate to the flow from any number of point poles situated anywhere in it. The expressions are rather long, but they become simpler in certain special cases which were pointed out. Making the angle of the wedge vanish the expressions modify into corresponding expressions for the strip, the resistance expressions of which always contain hyperbolic trigonometrical functions of the positions of the poles. The potential functions for a circular sector also follow from a general case of the wedge. The general resistance formula, applied to the case of the isosceles right-angled triangle leads to some continued products, all of which are generalisations of Wallis' expressions for  $\frac{\pi}{2}$ . The product of these products, which is itself of the same

form, has been reduced by Mr. J. W. L. Glaisher to the complete elliptic integral usually denoted by  $K$ , its modulus being  $\text{Sin } 45^\circ$ . This quantity appears in all the resistance expressions for right-angled triangles and squares which the author has yet examined. The case of an equilateral triangle leads to more complex and interesting products, which were reduced by Mr. Glaisher to the product of two theta-functions, with  $\text{Sin } 75^\circ$  as a modulus. When the conditions of flow are known in one rectilinear figure they may be extended to a large number of others by alternate processes of reflecting the plate in one of its own boundaries, and of cutting it along one of its straight flow or equipotential lines. Diagrams of such transition figures were shown. In order to obtain the resistance of a compound conductor by means of the known resistance of its components, it is necessary that the flow conditions in each component shall remain entirely unaffected by their being connected together. Thus if the resistance of a circuit consisting of two wires side by side is to be deduced from the resistance of the wires separately, by the ordinary method of adding their conductivities, it is

necessary either that the wires shall not touch each other, or that if they do, no flow shall pass across the junction. This rule is often overlooked, and the oversight has given rise in certain cases to a notion of electrical "interference." The concluding part of the paper has to do with the flow conditions when fine poles are combined with point poles in a sheet, especially when point electrodes are introduced into a sheet when a uniform current or "river" is flowing across the sheet.—Dr. Guthrie then communicated a fourth paper on salt solutions and attached water. It consists mainly of an account of an examination of the behaviour of a salt solution, when cooled below the freezing point of water. Having shown in previous communications that every salt solution, when of a certain strength solidifies as a whole, at a certain temperature as a cryohydrate, the present research was directed to the determination of the temperatures at which, (1) ice separates from solutions of strengths weaker than the cryohydrate, and (2), the anhydrous salt or some hydrate richer than the cryohydrate, separates from solutions stronger than the cryohydrate. About twenty typical salts have been examined in this manner, and curves were exhibited in which the abscissæ represent strengths, and the ordinates solidification temperatures. All the curves have a similar character and exhibit a point of contrary flexure, between the origin representing pure water at 0° C. and the cryohydrate. Between the cryohydrate and the 0° C. degree of saturation, they are nearly straight lines, and are continuous with the curves of solubility above 0° C. The joint effect of two salts in depressing the temperature of ice-formation was also examined. From previous experiments the general law that the temperature of a freezing mixture is identical with that of the solidification of the cryohydrate of the corresponding salt, appeared not to be the case with iodide of sodium. It now appears that this salt offers no exception to the general law and that what was previously mistaken for the cryohydrate is really a sub-cryohydrate solidifying at a higher temperature. Certain remarkable cases of supersaturation were discussed which show that a solution may be supersaturated in a 3-fold manner, (1) with regard to ice (2) with regard to a salt, and (3) with regard to the cryohydrate of the salt. The parallelism between a boiling saturated salt solution and a glaciating one was pointed out.

## PARIS

Academy of Sciences, March 27.—Vice-Admiral Paris in the chair.—The following papers were read:—Influence of variations of pressure on the working of chronometers, by M. Yvon Villarceau.—On the small movements of an incompressible fluid in an elastic tube, by M. Resal. The velocity of propagation of waves is equal to the square root of the product of the coefficient of elasticity and the thickness of the tube divided by that of the diameter of the tube and the density of the liquid.—Observations of temperature at the Museum of Natural History during 1875, with electric thermometers placed in the air and in turf-covered and bare ground, by M. Becquerel. The temperature was, on an average, somewhat higher in the turf-covered ground than in the bare ground, and in the former it never descended below zero.—On the comparative movements of the thermometer and barometer during the commotion of March, 1876, by M. Sainte-Claire-Deville. The periodic oscillation of the temperature from 9th to 13th March did not fail to be produced, and the law of non-synchronic parallelism of temperature and pressure is realised even in the most sudden variations of these two elements.—Remarks *appropos* of Mr. Lockyer's communication on new lines of calcium, by M. Sainte-Claire-Deville. In twoneighbouring groups of mineral substances, there are most frequently two minerals belonging respectively to each, and characterised by the same basic element. Now of all simple bodies it is calcium that most commonly plays this double rôle. Is this connected with its double behaviour under the influence of dissociants?—Experiments on the schistosity of rocks, and the deformations of fossils correlative to this phenomenon; geological consequences of these experiments, by M. Dabrée (first part). The press used in these instructive experiments could give a total pressure of 100,000 kilogrammes on the plates.—Reproduction of Amblystoma observed in the museum, by M. Blanchard. The Amblystoma of Mexico is the adult form of the Axolotl, and the fact observed is important as disproving the idea of the sterility of certain Batrachians in the adult state.—Continued observations of solar protuberances during the second semester of 1875, by P. Secchi. These comprise seven rotations. It is a period of prolonged minimum; the absolute minimum not yet reached

(March). Protuberances varying from 2 or 3 one day 12 the next. The hydrogenic flames were commonly though 2 or even 3 minutes in height (say 60 terrestrial meters); this indicates great tranquility. The *chuve* was very low at the equator, but often reached a great at the poles (24 and 30 seconds). This is the effect placement of maxima towards the poles.—Mr. Spott was elected correspondent in the section of Geology room of the late M. Le Besgue.—Report on a memoir Bourgoin, entitled "Researches in the succinic series"—Treatment of coal-tar and of sulpho-carbonates against Phylloxera M. de la Vergne.—Analytic theory of the movements of satellites, by M. Souillart.—Results of actinometric experiments on the summit of Mont Blanc, by M. Violle.—Vertical thermal flow in a bar of iron, by M. Decharme. The time by the flow to reach different points in the bar are directly proportional to the squares of the distances of these points from the heated end; or, the velocities of thermal flow are inversely proportional to the squares of the distances. (The cooling is then the heating).—Study on stratified light; by Messrs. Neyreneuf.—The elephants of Mont Dol; organographic system of molar teeth of the mammoth, by M. Sirodot.—Micrographic researches on the transformation of colloid photographic operations, by M. Girard. Microscopic examination of colloidion enables one to know the nature of the bodies to follow the reactions produced in photographic impressions. On communications at a distance by water-courses, by M. Bouze (sealed packet deposited in 1870). Lines are dispersed and earth currents utilised.—On the conditions of immediacy of an expression with ordinary differentials of a function, by M. Pujet.—Impossibility of the equation  $x^2 + y^2 + z^2 = 0$ , by M. Pepin.—On the exchange of ammonia between the waters and the atmosphere, by M. Schlessing. The ammonia condensed by a given quantity of water increases rapidly with the diminution of temperature. It is a mistake to suppose that ammonia of a cloud is condensed almost entirely into water.—Sources of carbonic oxide; new mode of preparing very concentrated formic acid, by M. Lorin. In this preparation, dehydrated oxalic acid is used in place of sulphuric acid, and formate.—On the constitution of the excretory canal of a hermaphrodite organ in *Leucochron candidissima*, Beck, and *Bulimus decollatus*, Linn., by M. Dubruell.—On the relation between number of molar teeth in the dog and dimensions of the bones of the face, by M. Toussaint. The normal number for molar teeth of the dog is  $\frac{6}{7}$ , but in the extreme, the

types of bulldog and greyhound the formulæ of  $\frac{5}{7}$  or  $\frac{5}{8}$  for the former, and  $\frac{7}{9}$  for the latter, are met with. One may follow the transformation of the formulæ by examining intermediate types.—Researches on the convergence and divergence of formulæ of Fourier's representation, by M. Paul de Raymond.

## CONTENTS

PREECE'S TELEGRAPHY . . . . .	
MUSICAL INSTRUMENTS AT SOUTH KENSINGTON (With Illustrations).	
OUR BOOK SHELF:—	
Procter's "Non-Metallic Elements and their Compounds."	
LETTERS TO THE EDITOR:—	
The Use of the Words "Weight" and "Mass."—J. T. BOTTOMLEY.	
Birds as Astronomical Objects.—Prof. ALFRED NEWTON, F.R.S.	
How Typhoid Fever is Spread.—Dr. E. FRANKLAND, F.R.S.	
Lisbon Magnetic Observations.—JOHN ALLAN BROWN, F.R.S.	
The Early History of Continued Fractions.—THOMAS MUIR.	
The Dry River-beds of the Riviera.—HENRY T. WHARTON.	
The Flame of Common Salt.—T. N. MUELLEN.	
OUR ASTRONOMICAL COLUMN:—	
Double Stars . . . . .	
The Equator of Mars . . . . .	
A Southern Comet (?) . . . . .	
HUNTERIAN LECTURES ON THE RELATION OF EXTINCT TO EXISTING MAMMALS, VI. By Prof. FLOWER, F.R.S.	
ON REFUSION RESULTING FROM RADIATION.—PART IV.	
SCIENCE IN GERMANY (With Illustration).	
THE INTERNATIONAL METRIC COMMISSION AT PARIS. By H. W. CHISHOLM.	
PHYSICAL SCIENCE IN SCHOOLS. By T. WYLES; Dr. W. MARSHALL WATTS.	
NOTES . . . . .	
SOCIETIES AND ACADEMIES . . . . .	

THURSDAY, APRIL 13, 1876

## A RESEARCH FUND FOR THE CHEMICAL SOCIETY

AN offer has lately been made to the Chemical Society, which has for its object the establishing of a fund to be applied in aiding the development of scientific chemistry. The offer comes from Dr. Longstaff, who proposes giving the society the sum of 1,000*l.*, on condition that at least an equal amount be raised and invested together with his gift, in approved security. To make this offer known to the Fellows of the Chemical Society, the following circular has been sent to them, and already the major part of the required 1,000*l.* has, in donations varying from 1*l.* to 100*l.*, been raised.

Chemical Society,  
Burlington House, Piccadilly, W., March, 1876

Dear Sir,

I am instructed by the President and Council of the Chemical Society, to request your consideration of a matter, which they hope will elicit your interest and active co-operation.

The advancement of Chemical Science, which constitutes the special object of the Chemical Society, may be promoted chiefly in two ways:—

1. By facilitating the early acquirement by students of Chemistry of a knowledge of the results of chemical research carried on in this and other countries.

2. By affording direct assistance to workers in chemical science, with a view to encourage and facilitate their labours in experimental research.

The Chemical Society has sought from the time of its foundation to aid in the first of these objects by the publication of original papers communicated to the Society; and, during the last five years, a special guarantee fund and liberal aid from the British Association for the Advancement of Science have enabled the Society to establish, on a firm footing, the publication of monthly abstracts of original papers published in this country and abroad, on chemistry and allied branches of science.

The Chemical Society has also recently endeavoured, as far as its funds would permit, to afford assistance to chemists undertaking original investigations, by the extension of its library, and occasionally by grants of small sums of money, when pecuniary aid was applied for. The limited resources of the society have, however, restricted the number and amount of these grants within very narrow limits. In 1872, Mr. T. Hyde Hills placed at the disposal of the Chemical Society the sum of 10*l.* as the nucleus of a fund for promoting original research; and offered under certain conditions, made with the object of securing the co-operation of others, to contribute a like sum annually. This attempt of Mr. Hills to form a research fund was not, at the time, seconded. The Council have, however, recently received from Dr. G. D. Longstaff, one of the original members, the generous offer to place at the disposal of the society, the sum of one thousand pounds (1,000*l.*) towards establishing a permanent fund for promoting the advancement of Chemical Science, on the condition that not less than an equal amount be subscribed for the same purpose.

As the President and Council feel that such a fund would add much to the usefulness of their Society, and enable them to encourage still further the prosecution of Chemical Science, they are most desirous to secure to the Society the benefit of this munificent offer of Dr. Longstaff; and have therefore instructed me to ask your co-operation towards the attainment of this object.

I remain, Yours obediently,

WILLIAM J. RUSSELL, *Treasurer.*

Considering the use to be made of this fund, and the very large number of persons interested either in the scientific development of chemistry, or else in its many lucrative applications, it is not unreasonable to expect that a sum far larger than this 2,000*l.* will be raised.

The feeling among those most interested and most active in raising this fund, is that there should be, in the

first place, a permanent fund, the dispensers of which should have large discretionary power as to how the income is to be spent, so long as it be strictly used for the advancement of scientific chemistry, and secondly, that this fund should be aided by annual subscriptions. It is hoped that the invested capital may from time to time be largely increased by gifts; possibly as the real character and object of such a fund as this becomes better understood and more widely known, it may receive legacies and bequests such as now are devoted to charitable or religious purposes.

The direct income arising from the money which is to be invested in accordance with Dr. Longstaff's conditions cannot amount to any large sum; it is therefore hoped, and not without reason, that many will aid the fund by annual subscription, and while some may probably limit their subscriptions to a definite number of years, others may be willing to subscribe as long as they are assured that good and useful work is being done with the money thus raised.

A fund of this compound character has certain advantages; the invested capital gives permanency and keeps alive the interest in it, the subscriptions help most materially towards forming an income which will more nearly approach the requirements of the case, and there are many who would rather that what they give should be used for immediate requirements than that it should be funded for the benefit of unknown and possibly never-to-exist requirements in time to come.

One point has been urged against such a fund as this; it is that we should look rather to the State to aid research than to private generosity, and that every private fund of this kind tends to relieve the Government of some of its obligations, whereas all scientific bodies ought rather to increase such obligations, not lessen them. On the other hand the State aid, if it is to be really efficient, must be such that it will at least to some extent open out a career for those willing and able to devote themselves successfully to original investigations; while from this fund no more could be expected than that it should afford a means by which some of the best known chemists of the day, as represented by the governing body of the Chemical Society, should have within their power the means of aiding particular investigations, publishing possibly important scientific tables or other data, and making important acquisitions of books or even instruments if such be specially required by the fellows of their Society in the prosecution of scientific investigation. Undoubtedly it is beyond all question that the sphere of usefulness of the Chemical Society will be much extended by the establishment of this research fund.

W. J. RUSSELL

## TAIT'S "RECENT ADVANCES IN PHYSICAL SCIENCE"

*Recent Advances in Physical Science.* By P. G. Tait, M.A., formerly Fellow of St. Peter's College, Cambridge, Professor of Natural Philosophy in the University of Edinburgh. (London: Macmillan and Co., 1876.)

THESE lectures, we are told in the Preface, were given in the Spring of 1874, at the desire of a number of the friends of the author—mainly professional



men—who wished to obtain in this way a notion of the chief advances made in Natural Philosophy since their student days. The demand, therefore, which these lectures are intended to meet, is that of men who, though they have received a liberal education, in which the element of science has not been neglected, are too deeply engaged in their professional work to keep themselves abreast of contemporary science by regular study, but who are yet able to avoid falling behind by occasionally availing themselves of an hour with a scientific friend.

In lectures of this kind, therefore, we are not to look for the elaborate exposition and reiterated inculcation by which the facts and methods of science are impressed upon the minds of beginners. Still less are we to expect the forcible language and striking illustrations by which those who are past hope of being even beginners may be prevented from becoming conscious of intellectual exhaustion before the hour has elapsed. We are rather to listen to one who has climbed high on the hard and slippery peaks of science as he points out the grand features of the prospect to those who stand on a lower level but yet on the same solid foundation with himself.

In his own words he has “to point out a few of the principal peaks which we have to ascend, and of the more formidable abysses which we have to avoid.”

As safety must come before success, it may be well to observe that the most formidable of all these abysses is that of *à priori* physics. The study of this branch of science as it is to be found in the works of Hegel, Herbart, and others, seems to furnish an unfailling source of recreation to those who are engaged in the less amusing researches of experimental physics. In our modern examinations those candidates who try to conceal their ignorance by sending up what appears to them to be the most plausible answer to a question, often help to relieve by their felicitous absurdities the tedious labours of the examiner. We have only to imagine that instead of the weary examiner we have the vigorous man of science, and instead of the timorous candidate, some great philosopher before whose inner vision the whole world of being and not-being, in its apparent contradiction and fundamental indifference, lies open; and we shall then have some faint idea of the mode in which the writings of these philosophers may be destined to contribute to the merriment, if not to the happiness of the coming race.

We are glad to find, however, that in spite of the contempt which Prof. Tait pours upon the *à priori* physics of non-experimental philosophers, he admits that there is a true science of metaphysics which discusses the fundamental ideas of all science and knowledge, not by shutting out all the facts of experience, but by calling in all the evidence obtainable from the whole circle of the science.

In fact one of the greatest benefits which the advance of science has conferred on the world at large is that words and phrases have been gradually introduced into ordinary language which are consistent with true scientific ideas, and that these have displaced words and phrases which implied false ideas about nature, so that each generation, as it learns its mother tongue, finds it better adapted to express what really exists, and less suggestive of what is not.

We have only to read the expositions of science in the seventeenth century to see that they are addressed to students whose minds were imbued with prejudices and superstitions which are now known only to archæologists. Those who have the good fortune to be born in these latter times can hardly realise the reasons why certain natural phenomena rather than others were dignified or stigmatised with the name of paradoxes.

The man of science, if he confines himself to writing scientific books, can influence only the professed students of science, but if he can find an audience among men of business and men of action, who desire to keep up their scientific knowledge, he will at the same time help them to keep up a scientific habit of thought and expression. In this way a course of lectures like those of Prof. Tait may do something towards infusing a scientific spirit into the affairs and phraseology of business life, and since it is of the essence of science to speak of things as they are, the business phrases which satisfy this condition will gradually but surely displace those which describe things as they are not.

The subjects discussed in these lectures are the conservation, transformation, and dissipation of energy, spectrum analysis, the conduction of heat, and the structure of matter.

The experiments by which the lectures are illustrated are many of them new, and all of them well described. We may take the following as an example of Prof. Tait's method of illustrating the connexion of radiation with absorption:—

“I can show to a few at a time, but not in a marked way at a distance, the same phenomenon [as in Stewart's experiment with pottery], by taking a piece of platinum foil and writing letters upon it with ink. When it is once heated there is a deposit, on the surface of the otherwise polished platinum foil, of oxide of iron which tarnishes the surface and makes it absorb considerably more light than a polished reflecting surface will do. We should expect, then, when this is heated (as I now heat it in a powerful but very slightly luminous flame), and becomes in turn the source of light, to see bright letters on a dark ground. The difference of brightness is not so marked in this case as in the last, but still those who are nearest to me will see the phenomenon distinctly enough.

“But you will see another phenomenon still more startling on looking at the back of the heated foil instead of the front of it. You see faint traces of bright letters on the dark ground when I turn the inked side to you, but when I turn the other side you see dark letters on a bright ground. Now, the reason why on the one side we have bright letters on a dark ground, while the other side of the same piece of metal shows dark letters on a white ground, is still more confirmatory of the result of Balfour Stewart's experiment, which I have just stated, because these letters appear dark while at present cold, because they are absorbing more than the rest of the polished surface. They appear brighter than the polished surface when heated, because they radiate more; but just because they radiate more they must become colder—must be kept permanently colder than the rest of the foil, and therefore the parts at the back of the foil, behind those which are radiating most, remain permanently colder. This is made evident when we look at the side which is without any difference of surface, as we then see, by the relative amounts of brightness, a marked distinction between the parts which are hotter and those which are colder. This is a still more complete proof of Stewart's proposition.”

We may also notice Prof. Tait's exposition of his views



in respect to the nature of comets and the origin of their light. He considers these bodies as consisting of arms of distinct meteorites, which are illuminated partly by the light of the sun, but which also give out a light of their own arising from the numerous and violent collisions which are always taking place, especially near the nucleus where the swarm is densest. The most remarkable fact about this light is that discovered by Huggins, namely, that its spectrum is identical with that of a hydrocarbon.

We are sorry, however, not to find in this volume any exposition of that theory of Prof. Tait's concerning the development and manifestation of the tails of comets to which Sir W. Thomson referred in his presidential address to the British Association in 1871 as "Tait's beautiful sea-bird analogy." A "tactic arrangement" of brickbats extending over millions of miles would perhaps account for what at present appears from a dynamical point of view most paradoxical in the behaviour of comets' tails, but the dynamical explanation of this tactic arrangement itself seems still to remain as a desideratum of the theory.

J. CLERK MAXWELL

DR. BALL ON SCREWS

*The Theory of Screws; a Study in the Dynamics of a Rigid Body.* By R. S. Ball, LL.D., F.R.S., Andrews' Professor of Astronomy in the University of Dublin, and Royal Astronomer of Ireland. (Dublin: Hodges, Foster, and Co., 1876.)

DR. BALL has published several papers of late years on the subject here treated. The present volume contains the substance of these papers re-cast, with additional matter, and with a greatly improved terminology.

It has been shown by the combined labours of Poinsoot, Chasles, and Möbius, that there is a perfect mathematical identity between the composition of forces and couples on the one hand, and of rotations and translations on the other. Every small movement of a rigid body consists of rotation round a definite line combined with sliding along it, in other words, consists of a *twist* on a definite screw, and every system of forces applied to a rigid body is reducible to a force along a definite line, together with a couple round it. The force is the analogue of the rotation, the couple is the analogue of the translation, and the combined action of the force and couple is called by Dr. Ball a *wrench* on a screw. In each case the screw consists of the definite line (fixed in position but unlimited in length), associated with a definite length, called the *pitch*, namely, the quotient of the translation by the rotation, or of the couple by the force. The *amplitude* of a twist is the magnitude of the rotation; the *intensity* of a wrench is the magnitude of the force. A twist, or its analogue a wrench, is defined by six numbers, one of which may be the amplitude or intensity, and the other five will then be common to all twists and wrenches on the same screw. A screw is therefore defined by five numbers.

When a body twists while acted on by a wrench, the work done by the latter is the continued product of the amplitude of the twist, the intensity of the wrench, and a third factor called the *virtual co-efficient* of the two screws. The virtual co-efficient is a symmetrical function of the two screws, and when it vanishes the two screws are called *reciprocal*. In other words two screws

are said to be reciprocal if a wrench on one of them does no work in virtue of a twist on the other.

Taking six screws at random in space, we can express any twist as the resultant of six twists, one on each of these screws, and the amplitudes of the six components are called the *screw co-ordinates* of the resultant. Wrenches can be expressed in the same way, *intensity* being substituted for *amplitude*.

If we take five screws and combine arbitrary twists upon them, we obtain an infinite number of resultant twists on an infinite number of resultant screws. These resultant screws constitute a *screw-complex* of the 5th order; and in like manner we may have complexes of lower orders down to the 2nd.

Given a complex of the 5th order, one definite screw can be found which is reciprocal to it, that is to say, which is reciprocal to every screw contained in the complex. One practical application of this theorem is, that if a rigid body has freedom of the 5th order (or one degree of constraint), one definite screw can be found such that a wrench upon it can do no work on the body. Given any complex of the *n*th order, there is one definite complex of the 6 - *n*th order that is reciprocal to it, in the sense that every screw of the one complex is reciprocal to every screw of the other.

In general problems on the dynamics of a rigid body, it is usually advantageous to select the six screws of reference, so that each of them shall be reciprocal to the other five. Such screws are called *co-reciprocals*.

For example, in discussing the action of wrenches on a body which has freedom of the 4th order (two degrees of constraint), four of the co-reciprocals should be selected from the complex which defines the freedom, and the other two will then of necessity define that other complex of the 2nd order which is reciprocal to it and includes every wrench that can be exerted by the constraints. When an applied wrench is resolved into its components on these six co-reciprocals, the first four components determine the movement of the body, the other two being completely destroyed by the reaction of the constraints.

It is not to be imagined that a wrench applied to a free body tends in general to make it twist on the same screw on which the wrench lies. If, however, we take six screws coinciding two and two with the principal axes at the centre of mass, and having pitches  $\pm a, \pm b, \pm c$ , where *a, b, c* denote the radii of gyration round these axes, these six screws will possess the property in question—an impulsive wrench on any one of them produces an instantaneous twist on the same. Dr. Ball calls these the six *principal screws of inertia* for a free body, and he further shows that a constrained body has a smaller number of such screws, the defect from six being equal to the number of degrees of constraint.

Again, he shows that if a body has freedom of the *n*th order, and has a position of stable equilibrium under the action of forces which have a potential, *n* screws (called *harmonic screws*) can be found possessing the following property, viz., that the body can execute small oscillations on any one of them, and will execute such oscillations if it receive an arbitrary displacement and initial twist-velocity upon it. Also that any possible small oscillations of the body can be resolved into *n* independent oscillations on the harmonic screws.



We have said enough to indicate the richness of the ground which Dr. Ball has broken, and we would commend his treatise to the careful attention of mathematicians.

We could wish that a sharper line had been drawn between real and imaginary solutions, and also between results that are only true for screws of finite pitch and those that are true without this restriction. We also think that the convention which Dr. Ball proposes (foot-note, p. 11) for removing ambiguity from the expression for the virtual coefficient, is defective, partly because he has overlooked the fact that the virtual coefficient of two screws is essentially signless until positive as distinguished from negative directions have been arbitrarily selected along them. When this selection has been made, the virtual coefficient is the value of the quaternion expression  $-pS\alpha\beta + S\alpha\beta\gamma$ , where  $p$  denotes the algebraical sum of the pitches,  $\alpha$  and  $\beta$  unit-vectors parallel to the two selected positive directions, and  $\gamma$  the vector perpendicular from the screw  $\alpha$  to the screw  $\beta$ . To express the same thing unambiguously without quaternions would require such a long specification as would weary the patience of our readers.

The value of Dr. Ball's book is enhanced by an appendix containing a very clear and interesting *résumé* of the literature of the subject, from Poinsot downwards. We may supplement this list by a reference to §§ 200, 201 of Thomson and Tait's "Treatise on Natural Philosophy," where one degree of constraint is shown to be reducible to the condition that "every longitudinal motion of a certain axis must be accompanied by a definite proportion of rotation about it." This comes very near to the indication of the one reciprocal screw by which such constraint may be defined.

J. D. E.

#### OUR BOOK SHELF

*Mittheilungen aus dem k. Zoologischen Museum zu Dresden.* Herausgegeben mit Unterstützung der Generaldirection der k. Sammlungen für Kunst und Wissenschaft. Von Dr. A. B. Meyer, Director des königl. zoologischen Museums. I Heft mit Tafel i.-iv. (Dresden: Verlag von R. v. Zahn, 1875.)

THERE can be no question that the establishment of a journal in connection with a scientific institution is one of the very best methods of promoting the interests of the latter and obtaining for it more extended support. While the institution remains in one place, its journal travels about the world, makes its most recent acquisitions known to its supporters and correspondents, and encourages them to promote its welfare by further donations. Such being the case, Dr. Meyer has acted most wisely in endeavouring to resuscitate the somewhat decayed zoological branch of the Royal Museum of Dresden, by starting the present periodical. Dr. Meyer's recent travels and discoveries in the Eastern Archipelago have brought him much and deserved credit, to which, no doubt, he partly owes his present appointment. They have likewise supplied him with abundant materials for contributing valuable memoirs to his journal. Not unnaturally, therefore, the first number of the new periodical commences with papers containing the results of some of his own researches in the Eastern Islands. The first of them contains an account of a new Bird of Paradise, not actually discovered by Dr. Meyer himself, but by one of his correspondents since his return to Europe. *Diphylodes Gulielmi III.*, as this splendid bird is named, in

honour of the King of Holland, is said to be from the little known Papuan island of Waygiou, and vies in brilliancy of plumage and elaborate excess of feathered ornaments with the finest species of this gorgeous family. Descriptions of other novelties in the class of birds discovered by Dr. Meyer himself, together with additional notes on little known species, complete this interesting memoir. Another paper by Herr Kirsch contains descriptions of new beetles from Malacca, from a large collection sent by Herr Eichhorn to the Royal Museum, and a third, which will be of special interest to our anthropological friends, is devoted to an account of 135 Papuan skulls obtained in New Guinea and Mysore by Dr. Meyer himself. We observe that a second part of the *Mittheilungen* is announced for publication early in the present year, so that we may expect shortly to have an opportunity of bringing further labours of Dr. Meyer and his assistants to the knowledge of our readers.

#### *Table of British Sedimentary and Fossiliferous Strata.*

By Henry William Bristow, F.R.S., F.G.S., Director of the Geological Survey of England and Wales. The Description of Life Groups and Distribution by R. Etheridge, F.R.S. Second Edition, revised. (London: Edward Stanford.)

THIS is an admirable and evidently very carefully prepared table, which is well suited for the use of students, science classes, and schools. In it Mr. Bristow has managed to embody a vast amount of information, which could only be obtained and verified by the consultation and comparison of a great number of maps and documents; and for this service all engaged in teaching the science of geology are greatly indebted to him. The foreign equivalents of the British rocks are only given in such cases as that of the Trias, in which our own series is incomplete. Mr. Etheridge's contribution to the work consists in a very valuable palæontological digest, in which the order of succession of the different forms of plants and animals is clearly described. The only points which seem to call for critical remark in this excellent work is the use of the term *Laurentian* for the so-called "Fundamental Gneiss" of Scotland, and the manner in which the name of Cambrian is employed. There is absolutely no evidence whatever whereby the geologist is able to correlate the azoic rocks on the opposite sides of the Atlantic, and therefore the application of the term *Laurentian* to any British formation would scarcely appear to be justifiable. In the long-vexed question as to the boundary between the Silurian and Cambrian systems, we regret to find Mr. Bristow adopting the extreme views of the late Sir Roderick Murchison, and confining the name of Cambrian to a few almost unfossiliferous rocks quite at the base of the series. The line of division at the top of the Tremadoc slates, which was adopted both by Lyell and Phillips, has the advantage of making the British Cambrian system, as now defined by Hicks, very closely agree with the "Primordial" of Barrande; and we hope that in a future edition of this table, which we doubt not will soon be called for, the author may see his way to the adoption of it.

*Catechism of Chemistry.* New edition by Robert James Mann, M.D., &c. (London: Edward Stanford, 1876.)

PERHAPS no better illustration of the truth of Pope's line—

"For fools rush in where angels fear to tread"—

can be cited than the method employed in the manufacture of many of the so-called scientific elementary textbooks, a series of which *must* be put forth by every publisher. The "Catechism" before us is a typical example of a book constructed on this most pernicious method. The author appears to have learned a little chemistry from works which were in vogue a quarter of a century ago, and to have tacked on to this knowledge a



smattering of the more recent development of the science. Being thus completely furnished, he has entered the arena. The result is altogether what might have been expected. Inaccuracy of statement, meaningless definitions, sins of omission and of commission, abound. If anyone wishes to learn the rudiments of chemistry, let him eschew this catechism as he would poison.

M. M. P. M.

*Summer Holidays in Brittany.* By Thomas J. Hutchinson. With Map and Illustrations. (London: Sampson Low and Co., 1876.)

MR. HUTCHINSON is well known, among other things, for his researches among Peruvian antiquities, and therefore, to his tour in Brittany he brought a trained observation. He has managed to write a very pleasant book on rather a worn subject, a book which is likely to give its readers a desire to follow the author's example. Indeed it might form a very useful guide-book for the district traversed by Mr. Hutchinson, and would have the advantage of being much more pleasant reading than guide-books generally are. Mr. Hutchinson evidently made good use of his time when in Brittany, and to those who have not read much on the subject the book will furnish a great deal of information on the nature of the country, the characteristics and manners and customs of the people, the antiquities, historic and prehistoric, the ecclesiastical and political history, and many other interesting points. A very good map and some fair illustrations add to the value of the book.

#### LETTERS TO THE EDITOR

[The Editor does not hold himself responsible for opinions expressed by his correspondents. Neither can he undertake to return, or to correspond with the writers of, rejected manuscripts. No notice is taken of anonymous communications.]

##### Colour of Flowers Grown in the Dark

IN NATURE, vol. xiii. p. 348, Mr. Thiselton Dyer gives an extract from Sachs's "Text-book of Botany" to the effect that no change is produced in the colour of flowers by growing them in the dark. This led to a letter from Mr. J. C. Costerus (vol. xiii. p. 427), calling attention to the results obtained by Askenasy, published in 1876, who found that some kinds were changed in colour, and some not changed. In the autumn of 1873 I made a number of experiments on this subject, and published a short account of them in the same year in the *Quarterly Journal of Science*, vol. iii. p. 474. I came to the same conclusion as Askenasy has come to, and was also able to establish some important generalisations. I will only mention a few special instances. I was unable to cause any change in the colour of the common Orange Lily (*Lilium aurantiacum*), whereas I found that a very considerable change was produced in the case of *Erysimum Peroffskianum* by only a moderate degree of darkness. This may perhaps be owing to the fact that the orange tint of these two kinds of flowers is due to entirely different substances. That of the lily is due to what I have called orange xanthophyll, whereas that of the other flower is due to a much less stable compound, giving an entirely different spectrum, met with also in the orange marigold, and therefore named by me *Calendula xanthine*. Comparing together the mixed colouring matters found in an equal weight of the petals, I found that the amount of the *Calendula xanthine* was only half as great in the petals grown in the dark, whereas the more yellow constituents were reduced only to three-quarters, so that the general colour was more yellow. I found that a similar change could be produced in the case of the marigold. If shaded when the flowers are somewhat grown, the total colour may be very considerably reduced without there being any material change in the ratios of the different colouring matters, whereas when grown in the dark from a very small bud, the ratios are changed, as in the case of *Erysimum*. Growing flowers in the dark seems to stop the normal development to a greater or less extent according to the nature of the colouring-matters, the effect being the greatest in the case of those substances which are the most easily decomposed. We thus find

what appears at first sight to be a very unlikely result, viz., that those constituents which, when dissolved out from the petals, are the most easily discoloured by exposure to light, are formed in relatively greater amount when the flowers are grown in the light, which is easily explained if we assume that a higher vital power, depending on the presence of light, is necessary to overcome the more powerful chemical affinities of the less stable compounds.

H. C. FORBY

##### The Ash Seed Screw

MR. STEPHEN WILSON remarks, in his note on this subject (NATURE, vol. xiii., p. 428), "Why the seed generally becomes twisted as it dries is a very interesting question. But what seems to me the most remarkable fact about this phenomenon is, that in every case, and in all trees alike, the thread of the screw is in one direction." He also alludes to the uniformity in the direction of torsion in the awns of two species of oat. Torsion of all kinds occurring in plants is usually assumed to be due to unequal longitudinal tension (see Sachs's "Handbook," p. 770). In a paper read before the Linnean Society, March 16, I pointed out that the uniformity in the direction of the torsion cannot be thus accounted for; and a totally different explanation was given of the twisting and untwisting of the awns of certain fruits (*Avena sativa* among the number) when they are dried and moistened. It was shown that the power of torsion resides in the individual cells of which the awn is constructed, and that it is by their combined action that the awn, as a whole, becomes twisted in drying. It appeared to me extremely probable that the same explanation would hold good for the twisted wing of the ash fruit. I therefore boiled one in nitric acid and chlorate of potassium, by which means the woody tissue is separated into its constituent cells. These were then teased out on a slip of glass and thoroughly dried over a lamp, and it was found that many of them had become twisted on their axes; and, which is important, that they were all twisted in the same direction as the fruit itself. This artificial drying represents the natural drying process which occurs during the ripening of the fruit. In both cases contraction and consequent torsion result from the loss of water, but in the natural process the cells not being free to twist independently, are compelled to combine in producing that torsion of the whole fruit which we are considering. It is interesting to find the same principle holding good in the case of the ash screw as in that of the awns of various Gramineæ and Geraniaceæ, and the twisted tails of the achenes in *Anemone montana*. Moreover, I strongly suspect that the principle of the torsion of an organ being dependent on the twisting of its constituent cells is capable of wider extension, so as to embrace the torsion of the stems of twining plants, &c. This subject I hope immediately to investigate.

FRANCIS DARWIN

P.S.—The samara of the sycamore is a more efficient parachute than that of the ash, but the wing has no appreciable twist, and there is no uniformity in the direction of rotation assumed as the fruits fall to the ground.

Down, Beckenham, April 4

##### The Animal of Millepora

IT is a remarkable fact that during all the discussions on the late L. Agassiz's statements regarding the animal of Millepora some very careful drawings of it have been in the possession of Major-General Nelson, R.E. They were done by himself during his residence at Bermuda at the time when he was writing that communication to the Geological Society on the reefs and general structure of the islands which has made *Lieut. Nelson, R.E.*, a name of mark.

In common with most naturalists, I had expected that soon after the *Challenger* reached Bermuda, we should have had a satisfactory description of this very interesting polyp, so that the truth, or the contrary, of Agassiz's description could be tested. But it was not until July in last year that any communication relating to the subject was sent off from the *Challenger*, the paper being read on Nov. 25, 1875, at the Royal Society. Mr. Moseley noticed therein that the examination of Millepora is beset with serious difficulties, he, however, states that there are large and small polyps, and that both kinds have tentacles, and "they appear to be four in number, and compound." He observes: "they are simply retracted by means of muscular fibres which are arranged round the base of the cylindrical stomach



radially, and that no mesenteries have been seen." Mr. Moseley was naturally dissatisfied with these poor results, and hoped to do better things at Hawaii. In the meantime I became aware of the value of the drawings I have already alluded to, and as I am at work on several subjects with Gen. Nelson, I sent a communication and the drawings to the "Annals and Magazine of Natural History" before the evening of April 6, when Mr. Moseley's paper on Millepora was heard by me at the Royal Society. It is a satisfaction for me to be able to state that Gen. Nelson's drawings prove that Agassiz saw a part of a polype, and that Mr. Moseley's beautiful delineations, far in advance of all, testify to the correctness of my fellow-worker. I do not credit the hydroid nature of the polyp now, any more than I did when writing the reports on the British fossil corals, and I believe Millepora to be an Actinozoan.

P. MARTIN DUNCAN

### The Use of the Words "Weight" and "Mass"

THE relations between weight and mass, gravity and acceleration, are so well defined in all good treatises on dynamics, that it appears superfluous to dwell on these questions. But as it has been stated by Prof. Barrett, vol. xiii., p. 385, that the C. G. S. system of units has been introduced into the course of Mechanics in this College, I may be permitted to say that the system actually employed is not that referred to by your correspondent. I generally employ the kilogramme, metre, and second, and sometimes the foot, pound, and second, to measure a dynam or unit of force. The dynamometers alluded to as about to be exhibited at the Loan Exhibition of Scientific Instruments at South Kensington are suitable to the former system, and I use them for the measurement of dynams in kilogrammetres. One of these dynamometers is graduated for every 200 grammes up to 100 kilogrammes, the other for every 100 grammes up to 10 kilogrammes, and they cannot be depended on for results within the tenth of a kilogramme. Spring dynamometers, though suitable for the large units employed in mechanics, are totally unfit for measuring units on the C. G. S. system. I concur with Prof. Everett, in his book on this system, when he says:—"A spring balance, it is true, gives a direct measurement of force, but its indications are too rough for purposes of accuracy" (p. 8). Spring dynamometers are therefore unsuited to a system where the units are measured by  $\frac{1}{1000}$  of a gramme, or about  $\frac{1}{100}$  of a grain, as in the C. G. S. system.

HENRY HENNESSY

Royal College of Science for Ireland, Dublin

### The Physical Constitution of Steam

I BELIEVE the following remarks on the physical constitution of steam are in some degree original, in form at least, though perhaps not in substance.

Dr. Andrews has shown by his experimental researches on carbonic acid, that at a temperature above  $31^{\circ}$  C. or  $88^{\circ}$  F. the difference between the gaseous and the liquid states no longer exists. I quote the following brief statement from an admirable paper on the subject, by Prof. James Thomson, in the "Proceedings of the Belfast Natural History and Philosophical Society," 1872;—he is speaking of the case in which a given quantity of carbonic acid, of which part is in the gaseous and part in the liquid state, is kept at constant volume, while the temperature, and consequently the pressure, are gradually increased:—

"As the temperature and pressure are augmented, the gaseous part is always increasing in density, and the liquid part is diminishing in density, till at last the two come to have the same density with one another, and then they are perfectly alike in every respect, all distinction between them having vanished. At this stage the temperature is  $31^{\circ}$  C., and the pressure is about seventy-five atmospheres. Above this temperature of  $31^{\circ}$  no change of pressure can cause gasification or liquefaction; and above this pressure of about seventy-five atmospheres, no change of temperature can cause gasification or liquefaction."

This temperature of  $31^{\circ}$  C. is called by Dr. Andrews the critical temperature for carbonic acid. Above its critical temperature, although carbonic acid may have the density either of a gas or of a liquid, the two states are not sharply separated from each other as a liquid is from its vapour, but graduate into each other insensibly. It is believed that every gas and vapour has its own critical temperature. Those of the permanent gases are believed to be so low as to be unattainable by any known process. That of water or steam, on the contrary, is probably too high to be observed in a glass tube, and consequently too high to be directly

observed at all: for the only known test of the critical temperature being attained, consists in the disappearance of the visible boundary surface between the liquid and the vapour or gas. My purpose is to show how the critical temperature for steam may be approximately estimated with a great degree of probability.

The fact that the latent heat of steam diminishes as the temperature increases, formerly seemed to me one of the strangest of all facts; but the above-mentioned properties of carbonic acid, and no doubt of all gases and vapours, make it quite intelligible.

The latent heat is defined as the heat given out when steam is condensed into water of its own temperature. The total heat is defined as the heat given out when steam is condensed into water at zero Centigrade, and is the sum of the latent heat and the temperature. According to Regnault, the relation between temperature and total heat is expressed by the formula—

$$\lambda = 606.5 + .305 t.$$

$\lambda$  being the total heat and  $t$  the temperature. This has been ascertained to be true from  $0^{\circ}$  to  $230^{\circ}$ , and if it is true for all temperatures, at a temperature of  $872.7$  the total heat and the temperature would be the same, and the latent heat would vanish:  $872.7$  is consequently the critical temperature which is deducible from the above formula for water.

Old Forge, Dunmurry,  
Co. Antrim

JOSEPH JOHN MURPHY

### Coloured Solar Halos

IN the interesting letters of Drs. Schuster and Frankland I note some remarks on the rarity of the apparition of complete halos about the sun in this country. Had I read these remarks some six years ago I should have passed them by without surprise. It so happened, however, that my attention was drawn to the subject of halos, coronas, &c., by Kämtz's "Lehrbuch der Meteorologie" about the year 1869, and I at once began to examine the sky near the sun every fine day, and note down any appearance of halos, fringes, &c. When I began, my impression was that I should rarely see the solar halo seeing that it had escaped me for several years. However, I soon found out my mistake, and the subjoined list, compiled from the observatory note-books, gives the number seen each month in 1874 and 1875. No doubt, several escaped my vigilance in some months and a few in others. The figures, at any rate, show that the phenomenon is by no means rare.

#### Solar Halos in 1874 and 1875.

1874.			1875.						
Jan.	...	0	...	2	July	...	3	...	4
Feb.	...	1	...	2	Aug. <sup>1</sup>	...	1	...	—
March	...	1	...	2	Sept.	...	2	...	4
April	...	11	...	4	Oct.	...	0	...	2
May	...	8	...	1	Nov.	...	3	...	0
June	...	11	...	2	Dec.	...	1	...	0

1876			1875.				
Jan.	...	1	...	0	March.	...	8

Had I been quite sure that Dr. Schuster's remarks referred to the ordinary solar halo, this letter would have reached you a week ago or more. I will only add that the halos I have observed are nearly always complete (when the sun is high enough), that they are often very bright and most striking phenomena, and that the radius is usually about  $22^{\circ}$ .

Bermerside, Halifax, April 6

JOSEPH GLEDHILL

### "The Effect of the Sun's Rotation and the Moon's Revolution on the Earth's Magnetism"

THE above was the title of an article by J. Allan Brown, published in NATURE, vol. xiii. p. 328.

The establishment of these facts, if they have not already been published, will aid amateur investigators very much in arriving at satisfactory conclusions in regard to the phenomenon above referred to.

First, from the revolutions of the sun, do the positively defined edges of sunspots always reappear at the same moment, and are their relative positions with regard to each other ever the same through a series of years, giving them a fixed and positive character, both as to position and time of revolution?

Second: At what times, with regard to the position and area of the largest and most numerous sunspots, and whether they are hidden by the revolution of the sun, or face the earth, is the

<sup>1</sup> I was from home most of this month in both years.



greatest effect observable in the differences of the earth's magnetism?

Third: Are the sun-spots caused by clouds or curtains outside, and hiding the apparent surface of the sun, or are they deep cavities through the same? STEPHEN W. ALLEN  
Boston, U.S.A., March 27

Metachromism

I REFRAIN from replying to Mr. Petrie's second letter (p. 426) until after the appearance of the article to which Mr. Costerous refers (p. 427) on "Organic Colour Change."  
In defence of Miller, however, I would just add that on p. 298, vol. ii. (fifth edition), occur the following words:—"The sodic dioxide, Na<sub>2</sub>O<sub>2</sub>, obtained by igniting sodium in oxygen is of a pure white colour." WM. ACKROYD  
Royal Coll. of Chemistry, South Kensington, April 3

Dr. Klein on the Small-pox of Sheep

I WRITE this note in order to inform you that, my attention having been directed to some alleged fallacies in some of my observations regarding the small-pox of sheep, I am at present engaged in reinvestigating the subject. E. KLEIN  
The Brown Institution, April 11

OUR ASTRONOMICAL COLUMN

OLBERS' SUPPOSED VARIABLE STAR NEAR 53 VIRGINIS.—The only comet detected in the year 1796 was found by Olbers in Virgo on the night of March 31. On the following evening, at 8h. 55m., apparent time at Bremen, it was over a star of the seventh magnitude south—following 53 Virginis, and the light of the star was remarked to be little affected by the intervention of the comet. On March 1, 1797, desiring to fix more exactly the place of this star, Olbers found in its position one of only the tenth or eleventh magnitude, whereas in April previous, according to Schroeter, who appears to have compared the comet with it early on the morning of April 2, it was the brightest star in the immediate neighbourhood of 53 Virginis, and hence in Olbers' judgment "a seventh magnitude at least." Writing to Bode in March 1797 he directs attention to this star, as perhaps a more remarkable variable star than even  $\chi$  Cygni. The circumstances preclude suspicion of a similar phenomenon to that described by Piazzini when the great comet of 1811 passed over his star XX. 197.

From the positions of the supposed variable, and its neighbours given by Olbers (who also appends a diagram), it is evident that his star, which followed 53 Virginis 30' 55" in R.A., 20' 45" to the south, is No. 12,728 of Oeltzen's Argelander, a star observed 1851, April 24, and noted of the eighth magnitude. For 1876° its place is in R.A. 13h. 7m. 32s., and N.P.D. 105° 53' 7".

Approximate mean places for 1797, March 1, of several stars with which Olbers compared the one in question were:—

	Olbers' Magnitude.	R.A.	N.P.D.
(c)	9	194 40	106 6
(a)	7	194 44	105 24
(d)	11	196 15	105 11

The star (c) is Lalande 24,421, called by him 8½; (d) is L. 24,597, noted 9; but the star (a) is not found either in Lalande or Argelander. Its position in Olbers' diagram corresponds to the place above assigned. What is its present magnitude, or is there some mistake about its position?

On April 1, 1796, the supposed variable was considerably brighter than the star (a), according to Olbers; in March 1797, much fainter than (c) and only slightly brighter than (d); he remarked no change in March, April, and May. Bode says, on April 24 and May 12 and 20 of the same year he saw it as a 9.10. In March 1855 it was fully eighth magnitude or 7.7.

THE APRIL METEORS.—As the moon will be absent during the nights of the 19th and 20th of the present month, a watch may be advantageously kept for meteors which are supposed to move in the path of the first comet of 1861 discovered by Mr. Thatcher, of New York, on April 4. At the descending node this comet makes a remarkably close approach to the earth's annual track, the definitive orbit calculated by Prof. Oppöizer, showing that at this point the distance between the two orbits is only 0.00232 of the earth's mean distance from the sun, or 214,000 miles; less, therefore, than the moon's mean distance from the earth. The elements are elliptical with a revolution of 415 years, and this form of orbit we may assume with much probability to have been occasioned by a near approach of the comet to the earth at some distant epoch. The descending node is passed 22½ days before perihelion passage, and to bring the comet into closest possible proximity to our globe, it is necessary that the perihelion point should be passed on May 12. Had this been the case in 1861, the comet would have occupied the following positions on its descent towards the plane of the ecliptic:—

	R.A.	N.P.D.	Distance from earth.
March 24 <sup>o</sup> ...	269.2	57.4	0.700
April 1 <sup>o</sup> ...	270.3	57.0	0.494
" 9 <sup>o</sup> ...	271.3	57.1	0.281
" 17 <sup>o</sup> ...	285.2	59.4	0.065

The true dimensions of the orbit of this comet will be defined by the following numbers, which are in units of the earth's mean distance from the sun.

Semi-axis major ...	55.676
Semi-axis minor ...	10.083
Semi-parameter ...	1.826
Perihelion distance ...	0.921
Aphelion distance ...	110.430

PROF. HUXLEY'S LECTURES ON THE EVIDENCE AS TO THE ORIGIN OF EXISTING VERTEBRATE ANIMALS<sup>1</sup>

IV.

THE crocodiles form the highest group of existing reptiles; they are higher than lizards as a steam-vessel is higher than a sailing-ship; for, while built essentially on the same lines, and exhibiting altogether the same fundamental structure, they are in some respects peculiarly modified, and that always in the direction of greater complexity.

Besides the characters of the skull mentioned in the last lecture, they are distinguished from lizards by having a four-chambered heart, one in which the separation of the ventricle into two distinct cavities is completed, so that, in the heart itself, the blood from the lungs is kept separate from that returned from the body generally. A mixture, however, takes place subsequently, through an aperture between the two aortæ, one of which springs from each ventricle.

Crocodiles are found in Central America, India, Africa, and Australia. Of the many species, the greater number are short-snouted; the fish-eating Gavial of the Ganges, on the other hand, has an extremely long and narrow snout.

All the existing crocodiles are fresh-water or estuarine animals, but, fortunately, this was not the case with the ancient forms, many of which were exclusively marine, seeming, so to say, to take the place, in the sea of their own epoch, of our porpoises and dolphins.

Besides Tertiary species, crocodiles are found in the Chalk, Oolite, Lias, and Trias often in the best possible state of preservation; they therefore extend back to the very commencement of the Mesozoic epoch.

<sup>1</sup> A course of six lectures to working men, delivered in the theatre of the Royal School of Mines. Lecture IV., March 30. Continued from p. 430.



If we had specimens of all known forms of crocodiles, recent and extinct, and set to work to classify them according to their degrees of likeness and unlikeness, we should find that they naturally fell into three series.

In the first of these it would be found that the skull had all the characters mentioned at the end of the last lecture, the posterior nares being small apertures opening into the cavity of the mouth behind the pterygoid bones; the vertebræ would be concave in front and convex behind; the two bones composing the shoulder-girdle, the shoulder-blade or scapula and the coracoid, would be similar in shape, both being long and narrow; in the hip-girdle, the haunch-bone or ilium would be much cut away in front and excavated below, the ischium and pubis being both long blade-like bones; and there would be seven or eight longitudinal rows of bony plates on the back.

In the second set we should find the posterior nares to be much larger and placed farther forwards, immediately behind the palatine bones, the pterygoids not uniting as in the first group. The vertebræ would be slightly hollowed out at each end. In the shoulder and hip girdles there would be no important difference from the first group, with which also the more minute structure of the limbs would correspond closely. A difference would, however, be found in the fact of there being not more than two rows of plates on the back.

In the third series, we should notice certain very striking changes. The posterior nares would be actually as far forward as in a lizard; neither the palatine nor the pterygoids uniting in the floor of the mouth; the vertebræ would be completely amphicœlous or biconcave; the coracoid no longer long and narrow, but expanded and rounded like that of a lizard; the ilium more elongated and without the notch on its lower edge; and the ischium considerably broadened. As in the preceding group, the rows of bony plates on the back would not exceed two.

Thus we should find that the second group held an exactly intermediate place between the first and third, and that the third set, in every respect in which it differed from the normal crocodilian structure, approached to that of lizards.

It is a very interesting point to see how these three groups appear in time. We should find that in the first are included all the Recent and Tertiary forms, and that there are no indications of the type below the later Cretaceous.

The second group would be found to extend from the older Cretaceous down to the Lias; moreover, a careful examination would show that there were lesser modifications among the individual species of a very instructive nature; those from the Wealden, for instance, would be seen to have the posterior nares farther back (*i.e.*, nearer the typical crocodilian position) than those of the middle Mesozoic, and these again than those of the Lias.

The third group would contain exclusively Triassic forms, such as the dragon-like *Belodon* and the *Stagonolepis* of the Elgin sandstones. In this latter formation the fossils are in a very curious condition; after the sand accumulated round the bodies of the Triassic animals had hardened, water, percolating through the porous rock, completely dissolved out the bones, leaving nothing but cavities. Thus we have only the remains of remains to deal with, but casts taken from the cavities enable us to make out, with perfect certainty, even important characters, although there may be hardly a bone left.

We see then, that our third set of forms is the oldest, our first the youngest, and the study of crocodilian remains seem to show that that has happened in the history of crocodiles, which should have happened, if the theory of evolution be true. Anatomical characters show that crocodiles are a modification of the lacertian type, and to this type the Triassic species, from which we are certainly justified in supposing that existing forms are descended, exhibit a marked approximation.

Still we are very far from knowing the whole story: it is certainly allowable to assume that our third group of crocodilian forms was evolved from a common stock with lizards, but this is as far as the facts of the case will take us at present.

There seems, at first sight, to be something unnatural in speaking of birds and reptiles together, for no two animals can be, to all appearance, more unlike. The wonderfully constructed feathers of the one group, compared with the scutes and scales of the other, the cold blood of the reptile contrasted with the hot fluid which circulates through the vessels of a bird and fraises its body several degrees above our own in temperature; the dumbness and general sluggishness of the reptile as compared with the vocal powers and the rapid flight of birds; all these compel us to say, and justly so, that nothing can be more different than the character of the two classes.

Even when we go more into details, similar differences are apparent. The bird has a small head, set on a long flexible neck, and provided with a horny beak in lieu of teeth; its bones are hollow and full of air; its breast-bone, instead of being a small plate of cartilage, is a huge bony plate, usually provided with a large keel for the attachment of the powerful muscles of flight; the fore-limb is of no use in progression on the ground, and, the body having to be supported entirely by the hind limbs, the femora are placed parallel to the long axis of the body, instead of almost at right angles to it as in a reptile, so that the body is well raised from the ground, and a gait the very opposite of a reptile's sprawling waddle is the result.

The scapula and coracoid are not so very different from the corresponding bones in the lower class; the humerus, ulna, and radius, can also be perfectly well identified, but the modification of the distal division of the limb—the part answering to the reptile's fore-paw or to our own hand—is very great. First come two small bones answering to carpals, then three longer ones all united together, which represent the metacarpus, and are followed by the rudiments of the phalanges of the three corresponding digits. In the ostrich two of these three "fingers" are terminated by claws, the use of which it is rather hard to divine, unless the bird uses them for scratching itself, an operation in which a very large portion of the activity of the lower animals is taken up.

The haunch-bone, or ilium, is of enormous size, and extends a long way in front of, as well as behind, the acetabulum; in correspondence with this, a great number of vertebræ are fused together to form a sacrum of sufficient size for the attachment of the ilia and the support of the weight of the body. The ischium and pubis are long slender bones, and the latter, as well as the former, is bent back, so that they both come to lie nearly parallel with the vertebral column.

To allow of the femur taking up its position parallel with the axis of the body, its well-finished globular head is set on at right-angles to the shaft; moreover, its further end has a characteristic notch for the reception of the upper extremity of the fibula. The shin-bone is provided with a large and very characteristic crest for the attachment of the strong muscles of the anterior part of the thigh; its lower extremity is pulley-shaped, and, in a young bird, the pulley-like end, continued into a tongue of bone running up the back of the tibia, can be separated as a perfectly distinct ossification; its shaft also is so twisted that its two ends come to lie in different planes.

Following upon the tibia comes a bone with an easily separable piece at its upper end, and showing signs of a longitudinal division into three separate bones; this is the tarso-metatarsus, and represents the metatarsals and all the tarsals except one—the astragalus—which is represented by the pulley of the tibia. As a rule there are four toes, three of which are turned forwards and articulate with the tarso-metatarsus, while the fourth, the repre-



sentative of our hallux or great toe, is turned backwards and articulates with a small distinct bone.

The heart has four perfectly distinct chambers, so that the pure blood from the lungs, and the impure blood from the rest of the body, are kept quite separate. There is a single aorta which turns to the right side after leaving the heart.

(To be continued.)

### ON SAFETY MATCHES

THE fact has been known during some years past that the so-called safety matches, which are warranted to ignite "only on the box," can be fired by being rubbed on glass, and as Mr. Preece recently pointed out (*NATURE*, vol. xiii. p. 208), on ebonite. I find that they can be ignited by friction against ivory (I used an ivory paper-knife), steel (a steel spatula, somewhat worn), zinc, copper, marble with the polish worn off, and a freshly-cleaved surface of slate.

The match (or two matches together, for the sake of strength) should be held near the tipped end, and then be rubbed with strong friction, and with a long sweep upon the solid surface. From two to twelve such sweeps may be required before the match ignites, and the result seems to be due to the conversion of mechanical work into heat sufficient to fire the paste at the end of the match, which, I suppose, consists mainly of potassic chlorate and sulphide of antimony.

After a few rubs the match begins to crackle, and then suddenly bursts into flame. A similar result may be obtained by grinding the chlorate in a mortar with a little sulphur or sulphide.

The readiness with which the match ignites by friction depends greatly on the nature of the surface. Lead is too soft, and tin too smooth. The metals produced by rolling have a sort of skin on the surface, over which the match glides without sufficient friction, but if the surface of zinc be rubbed with sand-paper or with a fine file, it becomes active in firing the match. I noticed that the polish of my ivory paper-knife became worn before it acted well. Nor is it very easy to fire the match on glass. A long sweep repeated about a dozen times with considerable pressure seems to be necessary. The two specimens of sheet copper used by me have a sort of grain which is favourable to the success of the experiment. The copper acted equally well whether the surface was dirty or cleaned with dilute sulphuric acid. After rubbing a match ten or twelve times on zinc, without effect, the same match rubbed on copper immediately took fire.

In the case of slate, lead, tin, and some other surfaces, the composition on the match acts as a polish, and thus renders it unfit for ignition. On the other hand, a finely-cut file removes the composition from the end of the match without igniting it.

I have no doubt that many other surfaces might be found on which the safety matches would ignite with greater or less difficulty. Notwithstanding this, the match is still a safety match, although it does not comply with the conditions asserted twice over on the box. It does not ignite readily on any of the surfaces pointed out except copper and marble, but it does ignite with wonderful facility when rubbed against the side of the box, an invention so ingenious that a few words of its history may not be out of place here.

About the year 1850 a gentleman entered the laboratory of King's College, London, and drew from his waistcoat pocket a fragment of a rough-looking red solid, and, placing it in the hands of Prof. Miller, asked him if he knew what it was. It was handed round among those present, but no one had the slightest idea as to its nature, when, to the astonishment of every one, the gentleman said, "It is phosphorus—amorphous phosphorus, discovered by me, Herr Schrötter, of Vienna."

Up to this time, and indeed for some years later, persons engaged in the manufacture of lucifers were subject to a terrible disease, known in the London hospitals as "the jaw disease;" necrosis of the lower jaw induced by constantly inhaling the fumes of phosphorus acid escaping from the phosphorus of the paste with which the matches were tipped.

Ordinary matches made with phosphorus were, during many years, dangerous contrivances. They were luminous in the dark, liable to ignition on a warm mantelpiece, poisonous; children have been killed by using them as playthings; and, moreover, they absorbed moisture, and became useless by age.

But the chief inducement in getting rid of ordinary phosphorus and substituting the new variety was to put an end, as far as possible, to the jaw disease. The red, or amorphous phosphorus, gave off no fumes, had no smell, was not poisonous, and the matches made with it were not luminous in the dark; they did not fire on a warm mantelpiece, did not contract damp, and would keep for any length of time. A manufacturer, in 1851, sent me several samples of matches made with red phosphorus. I found some of these matches the other day, and they were as active, after twenty-five years, as at first.

But here was a difficulty. When the red phosphorus is brought into contact with potassic chlorate a slight touch is sufficient to produce an explosion, in which the red phosphorus reassumes its ordinary condition. Many attempts were made to form a paste, and many accidents and some deaths occurred in consequence. Prizes and rewards were offered by manufacturers and others for a safe paste, or for some means of using the red instead of the ordinary phosphorus, but without success, so that the patent for the manufacture of red phosphorus, which was secured by Mr. Albright, of Birmingham, in 1851, threatened to be of but little value.

At length the happy idea occurred to a Swedish manufacturer not to attempt to make a paste at all with the red phosphorus, but to make the consumer bring the essential ingredients together in the act of igniting the match.

Mr. Preece's suggestion that the ignition of the matches is due to electricity, may be dismissed in the face of the following experiment:—Place a few grains of red phosphorus on a hard surface together with some powder or a crystal of potassic chlorate, when a gentle tap will cause them to burst into a flame.

C. TOMLINSON

### NOTES FROM SIBERIA

THE following Siberian notes are furnished me by a Polish gentleman resident at Irkutsk. The dates mentioned follow the Old System, as in Russia, and are twelve days behind our own dates. The letter is dated the 10th of February. My informant says:—

"Some time ago Mr. Czckanofski returned from his second expedition to the most northern parts of Siberia by the Olensk River. He went as far as its mouth, and the extraordinarily warm autumn gave him the opportunity to make very interesting explorations. Till the month of September there was no frost nor snow, and the sea not frozen. The same is reported by Mr. Neumann, who returned lately from the Behring Strait. It may be that these exceptional climatical conditions allowed also Mr. Nordenskjöld's entering the mouth of the Jenessei. The exploration in the Achinsk country of a cavern situated now some thirty fathoms above the bed of the river gave to Mr. Tskersky<sup>1</sup> a fine collection of well-conserved fossils of extinct species. Mr. Tskersky occupies himself now with the description of the Tunka Alps, which he believes to be the former boundary of Lake Baikal, as he found there the fossils of the crab and

<sup>1</sup> The Curator of the Museum at Irkutsk.—G. F.



seals.<sup>1</sup> Dr. Dybowsky passed a year on the Ussour River, and brought a beautiful collection of birds, fish, and quadruped skeletons. His descriptions are sent to the Berlin Museum. Now he is occupied upon the Baikal with soundings and observations on the Baikal seals. He wishes to write a monograph on this particular species of seals. This is nearly all that was done last year, as far as expeditions are concerned, in this part of the world."

My correspondent refers me to the proceedings of the Siberian Geographical Society for further details. It is much to be regretted that this publication, as well as the excellent Calendar of Eastern Siberia are so little known, out of Asia. I further learn that earthquake shocks have been felt at Irkutsk on the 4th of September last, at 2.55 A.M., and a slight one on the 4th of January. The first one came from the east. A clock which was secured by screws almost an inch long, was left leaning on one side, and both of the screws drawn completely out of the wall. The Baikal district is the spot in Northern Asia which is most visited by earthquakes.

Since I am on the subject of Siberia, I may mention two facts of considerable interest which I learnt last year. I was told by inhabitants of Jenesseisk that in the regions to the north of that town the compass is of no use during an auroral display. It is not at all unlikely that this should be the case in a country where auroral effects are intense, and the horizontal component of the earth's magnetism is small. The other interesting fact is that Mr. Muller had reached Gauss' Siberian magnetic pole, where he found the needle vertical. This was shortly before I reached Irkutsk. His observations were to be published in the Proceedings of the Siberian Geographical Society. I do not know whether a translation has been published.

GEORGE FORBES

Andersonian University, Glasgow, April 4

### THE DUBLIN SOCIETIES

WE have recently referred in several articles to the efforts which are being made to introduce a more satisfactory organisation among the various scientific institutions in Dublin, which have hitherto been independent of each other. It appears now to be proposed not merely to unite museums, but to unite into one body the Royal Irish Academy and the Royal Dublin Society. This project would seem to have originated at a meeting which a deputation from the latter body had with Major Donnelly. It is evident that many difficulties would be removed and many advantages result from the amalgamation of these two societies. Of course the arrangements for such an amalgamation must be carried out entirely by the societies, though it would no doubt tend to forward such a scheme if the societies were assured of the approval of Government, and of such aid towards taking the necessary steps as the Government has in its power to give.

We understand further that there is some possibility of an amalgamation of the Royal Agricultural Society of Ireland with the Royal Dublin Society. It is most desirable that such an amalgamation should be effected, and that the agricultural shows should be removed from the present buildings beside Leinster House to the Phoenix Park.

From a letter which has been published in the Irish papers, it appears that these points have been submitted by Major Donnelly to Lord Sandon, who has informed him that the Government are prepared to aid the amalgamation and to give the necessary space in the Phoenix Park.

Should the amalgamation be effected, it would probably

<sup>1</sup> Lake Baikal is remarkable, among other things, for the presence of these marine animals. The seals are grey, and have a very coarse fur. I took a photograph last summer of one which was in the Museum at Irkutsk. —G. F.

take the form of a new Society with a limited number of Fellows, ordinary members, and an Agricultural Section.

It is possible enough that some of the members of the Royal Irish Academy may object to the proposed change, on the score that they would thus lose caste. We cannot admit the validity of such an objection. The Academy has no doubt done good work, but it has a large number of members on its roll who are no more entitled to any scientific or literary distinction than the general body of the members of the Royal Dublin Society. If, however, the Academy consent to the proposed change, the Fellowship of the new Society would become a high and much-coveted honour, and the reputation of the whole body would be far higher than that of the separate societies is now. As to the objection that the large body of general members are unfit to select Fellows, we think that the Fellows may very well be entrusted with the selection of Fellows; the first Fellows under the new charter might be, say Fellows of Trinity College, Dublin, Professors and ex-Professors of a College or University, and others with similar positions, who should be empowered to choose their successors. There need be no difficulty, while acting with perfect fairness and openness, in choosing for the inner circle and also for the governing body the best men of the new society, men who would make a point of maintaining its honour and dignity. The Royal Irish Academy would thus become, under a new name, a select body of Fellows chosen for their scientific and literary merit; in time, indeed, this fellowship might come to be regarded as an honour little inferior to that of F.R.S.

The union of the societies would remove many difficulties as to ownership of property, and would place at their disposal a much larger amount of funds for scientific and literary work than they at present possess. Indeed, it appears to us that from the union on the proposed basis, nothing but good could result, great benefits to the members, and much greater advantages than at present exist for the promotion of science in Ireland. Since government has promised to aid the United Society as far as possible, we think it would be a pity if any petty spirit of local jealousy should raise obstructions to the accomplishment of a scheme which promises so well for the country.

### GERMANY AND THE LOAN EXHIBITION

THE German Committee for the London Loan Exhibition of Scientific Apparatus has addressed a report to the Crown Prince and Crown Princess of Germany on the success of their efforts. It results from this document that 311 German exhibitors will be represented by 2,492 objects. The 19 classes will be represented as follows:—

1. Arithmetic by ... ..	6 exhibitors and	11 objects.
2. Geometry by ... ..	13 " "	35 "
3. Measurement by ... ..	59 " "	126 "
4. Kinematics by ... ..	10 " "	308 "
5. Molecular Physics by ... ..	23 " "	33 "
6. Sound by ... ..	10 " "	24 "
7. Light by ... ..	35 " "	118 "
8. Heat by ... ..	19 " "	41 "
9. Electricity by ... ..	32 " "	194 "
11. Astronomy by ... ..	25 " "	78 "
12. Applied Mechanics by ... ..	13 " "	64 "
13. Chemistry <sup>1</sup> by ... ..	32 " "	389 "
14. Meteorology by ... ..	18 " "	49 "
15. Geography by ... ..	29 " "	110 "
16. Geology by ... ..	22 " "	118 "
17. Mineralogy by ... ..	19 " "	39 "
18. Biology by ... ..	54 " "	289 "
19. Educational Collections by 5	" "	441 "

The space claimed by the exhibitors will be 109 square metres floor, 442 square metres repositories (tables, &c.), 299 square metres wall. Considering that two months had to suffice for bringing together this collection, that manu-

<sup>1</sup> Exclusive of the collective exhibition of the German Chemical Society, which will represent about 40 exhibitors with 300 objects.



facturers are beginning to feel indifferent with regard to exhibitions, that the Vienna Exhibition in the past and the Philadelphia Exhibition in the present years, have been absorbing their energies, the Committee think that they have reason to be contented with the results obtained. This view is strengthened by comparing the above numbers with those of 127 exhibitors only who represented German science at Vienna. The Committee express themselves greatly obliged for the assistance given by the Lord President of the Council of Education, the Duke of Richmond and Gordon, the Vice-President, Viscount Sandon, the Director of the South Kensington Museum,

Mr. Cunliffe Owen, and to the Government and Officers of the German Empire and of Prussia, notably to the Ministers of Education, Dr. Falk, of Commerce, Dr. Achenbach, of War, General von Kamecke, of Marine, to the head of the General Staff, Count Moltke, to the Postmaster-General, Dr. Stephan, and also to the Royal Library, to the Royal Academy of Science, and to the German Chemical Society. The Committee conclude by claiming the assistance of the German Empire for the production of a systematic and critical report on the scientific treasures of all nations that will be exhibited in London.

ON A MODIFIED CARDIOGRAPH

DR. A. L. GALABIN, whose investigations with the sphygmograph and cardiograph we have had the opportunity of noticing on former occasions (*vide NATURE*, vol. xii. p. 275), has introduced a modification of the cardiograph, a woodcut drawing of which, through the kindness of the Council of the Royal Medico-Chirurgical Society, we are able to reproduce from their "Transactions."

The cardiograph of Marey is too well known to require

description; suffice it to say that it depends for its action on the transmission through air-filled tubes of movements from one stretched elastic membrane to another. In it, therefore, errors originating in the tubes are introduced; and these, from practical experience, are found to be considerable. More than one physiologist has obtained far more satisfactory "cardiograms" by applying the sphygmograph, which was originally constructed by its inventor—M. Marey—for the purpose of recording the movements of the pulse at the wrist, upon the chest-wall, in the intercostal spaces. This instrument, when thus

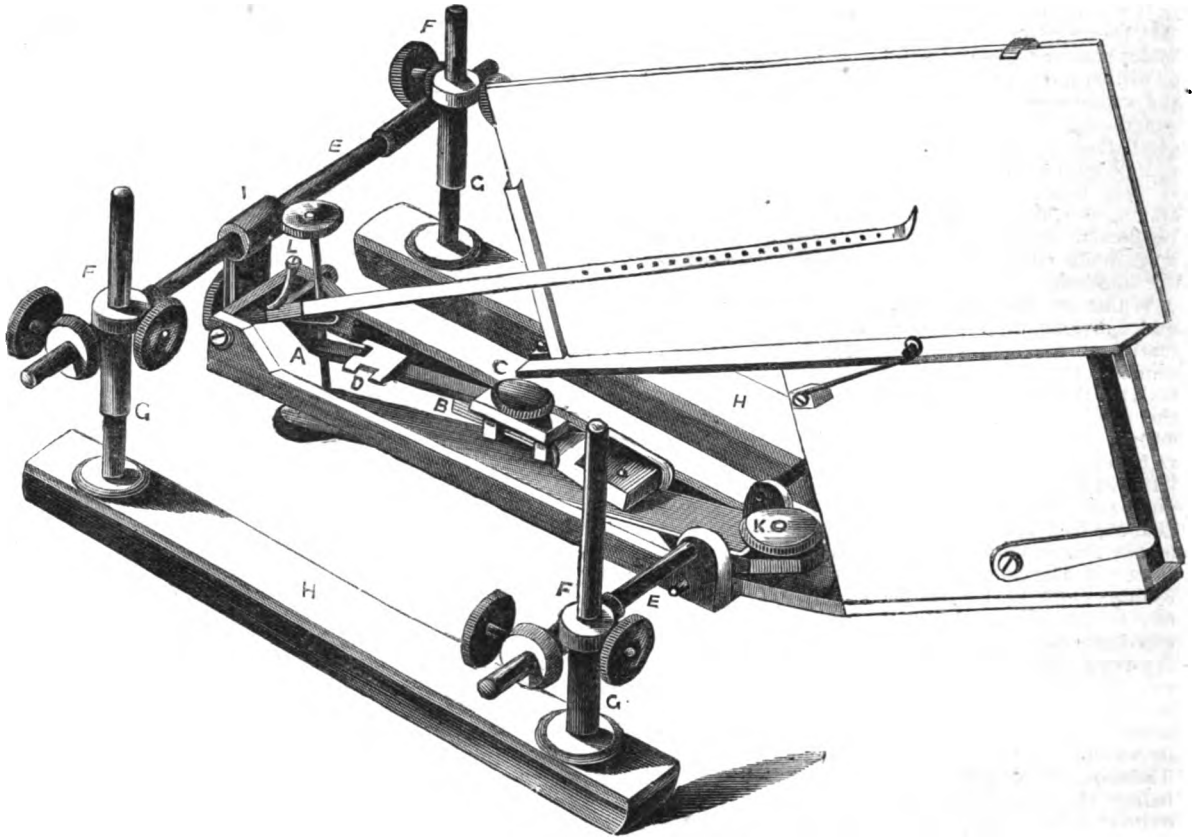

applied, reproduces in a most faithful manner the movements of the chest-walls as there produced by the subjacent heart in action; and in the healthy subject any accessory apparatus is rarely needed for the satisfactory production of the tracings.

In many pathological conditions, and in the healthy subject when the cardiac movements are more than ordinarily powerful, the movements of the heart are transmitted to the neighbouring ribs, on which the sphygmograph has to be supported, as well as to the more yielding intercostal tissues. Under these circumstances it is far better to employ, as supports for the instrument, more

fixed points, which must, from the nature of the chest-wall, be at some distance from the centre of cardiac movement. Dr. Galabin's apparatus supplies us with the means needed. It is an expanded framework constructed in a manner which allows of its being firmly applied to a considerable expanse of the irregularly-shaped chest. From the drawing its principle can be best understood (See Figure).

In the middle of the figure the sphygmograph is seen. It differs from M. Marey's original in one or two minor details, which are decided improvements. The most important of these is that the brass bar A B, on which the



knife-edge by means of which the recording lever is set in motion is fixed, can be varied in length; and this makes it possible to vary the magnifying power of the lever, because the distance of the knife-edge from its axle can be changed. Such an addition has always been a desideratum, even in the wrist sphygmograph. The screw, C, clamps the two component parts in any desired position. A second reserve knife-edge, D, can also be turned up to replace the ordinary one, A, when the cardiac action is extraordinarily forcible. By the screw, K, the compress-spring is fixed. L is the secondary spring, which prevents the recording lever from quitting the knife-edge; it can be thrown out of gear when not required.

The supporting bars are seen at HH; they replacing the side-lappets of the original instrument. On them are fixed uprights, GGG, on which again are attached by screw-clamps two transverse bars for the suspension of the sphygmograph. That to which the clock-work end is joined can only be moved upon the uprights with which it is connected. The other has an additional sliding-piece, I, that allows of the screw-pad portion being independently raised or lowered in a hinged manner.

That this suspending stage will prove of great service in the study of the heart's action there can be no doubt. The presence of the large number of movable centres must, however, render its adjustment somewhat difficult. It will be seen in the figure that the recording plate above the watch-work is of considerable depth. We have found, practically, that it is *never* advantageous to allow the oscillations of the lever to reach nearly so great an amplitude as this will permit; and it is known by all that it is very important that the average level of the lever's tracing should never be far above that line which is perpendicular to the tangent of the circle formed by the lever in its movements, at the point where the two cut one another.

Whilst on the subject of Dr. Galabin's cardiograph and sphygmograph work, we may incidentally draw attention to a point in a paper by him in the January number of the *Journal of Anatomy and Physiology*. Dr. Galabin there comments on Mr. Garrod's law respecting the length of the cardiac systole as it appears in the arterial system—that it is constant for any given pulse-rate, and varies as the cube root of the rate. He remarks, "I have found the length of the systolic portion of the pulse-curve to deviate somewhat considerably from that deduced from the equation. . . . It appears to be approximately true in normal pulses." Would it not have been better if Dr. Galabin had given a larger number of examples—he having confined himself to two, of which one is pathological? In the paper in which the law was announced, the agreement of the measurements with the requirements was very close, and others have been published since, even more satisfactory; it has also been indicated by its author that a pathological condition, like anæmia (the instance taken), is just such an one as that in which a deviation might be expected. Mr. Edgar Thurston, of King's College, has recently read a paper before the Medical Society of that School, which is quite in confirmation of the law as originally stated, from a considerable number of observations on *healthy* subjects.

#### PHYSICAL SCIENCE IN SCHOOLS

DR. WATTS quite puzzles me. I can see no contradiction between the passages from my essay of 1867 and my letter of 1876, which he silently places in juxtaposition. What I said in 1867 was (p. 261) that "science should be introduced into a school, beginning at the top and going downwards gradually to a point which will be indicated by experience." What I say in

1876 is that experience shows, as far as I can judge, that it is not generally wise to go down very far; that one soon comes to a point at which the loss in teaching science counterbalances the gain. I am quite as sure as ever I was of the value of science in schools, in its right place.

I think that those who advocate the teaching of science to young boys scarcely realise the difficulty of establishing their ground. Some, like Prof. Roscoe (p. 387), admit, when pressed, that it is a question which experience alone can decide, and that they have not had that experience. Liebig, to whom Mr. Gerstl refers (p. 431), was speaking of a different class of schools, in which boys must pick up some useful scientific facts early or not at all. Prof. Henslow's experience is of the same kind. Other philosophers, charmed with the bright intelligence of children when talked to by a Faraday or a Frankland, straightway pronounce an opinion on the relative value of science and classics and mathematics in the early part of a liberal education,—on somewhat insufficient grounds.

The question that this discussion began with was the merits or demerits of the Certificate Examination, in so far as it affected science in schools. That seems to be settled. We have drifted now into a different and most useful discussion on the results of experience in the early teaching of science. The question is this. Given that boys are going to remain under a system of liberal education till eighteen or nineteen, at what stages is it shown by experience that it is wise to introduce the different sciences? It is a question of the *comparative* value of different studies at different ages, not only of what may best be learnt, but of what may least injuriously remain unlearned, at different ages; and those teachers speak with real weight who can institute such a comparison; men who have watched the processes by which young boys learn different subjects. A man who teaches science only cannot institute such a comparison. He can only say, "I *do* teach young boys something of chemistry and botany, and they *do* gain something." One who teaches mathematics also is so far better off that he can say, "Young boys are more (or less) attentive, active-minded, diligent, when they are doing arithmetic, than when they are at a lesson on physical geography; and they are more (or less) incapable in later years of recovering from the ill effects of neglected arithmetic than of neglected physical geography." One who teaches classics also (as I do for more hours a week than I teach physical science) has wider grounds still for forming a comparison.

Nothing that I see young boys do is as efficient as Latin in completely occupying their minds with perpetually recurring problems which tax attention, memory, judgment, taste. It is quite interesting enough not to be too tiresome. The problems are easy and varied, and the solutions certain and satisfactory. The same sort of young boys who will work hard and cheerfully over a bit of Cæsar or a Latin exercise seem to be a good deal bored by a lesson on physical geography, think botany rather nonsense, and submit silently to the hopeless unintelligibility of "matter and motion." The very same boys will as a rule enjoy an arithmetic lesson and work happily at their practical geometry, or, when well handled, their Euclid. Hence, if I wanted to train up a boy for a scientific career, I would not begin very early with science, but wait till he was thirteen or fourteen.

I admit that the experience of some others is against me.

Mr. Tuckwell (p. 412) speaks warmly, and pronounces my opinion to mean nothing more than that I myself have failed to teach science to young boys. This is a mistake. It means that I have seen the work of others, here and elsewhere. It means not an absolute failure, but a comparative failure, as explained above. It means a summary of the opinions of a considerable number of other men. Mr. Wyles (p. 455) is against me, although he has "never been satisfied with his science teaching." Mr. West (vol. xiii. p. 48) is against me, and his opinion



is a valuable one. But it must be remembered that it is not a personal question, which admits of the simple solution that Mr. Tuckwell can teach science and that Mr. Wilson cannot, but a general one: can science be taught to young boys by the rank and file of science teachers, who are, or will be when they are numerous, neither more nor less able and enthusiastic than the rank and file of classical teachers, very average sort of people? I do not doubt for a moment that my old pupil West can teach little boys science with great advantage, but I doubt very much whether there exist fifty Wests as schoolmasters at any one time in England; and to justify making his practice universal we want to be certain of finding five thousand or fifty thousand such men as teachers. Let it be remembered that very dry and dull men teach classics, and not very badly, while the same men would teach a science class nothing, or worse than nothing.

I wish Dr. Farrar, of Marlborough, would give us his opinion on this whole question. He has had unusual opportunities for forming an opinion and has, no doubt, used them; and I do not know to what conclusions he has arrived.

Mr. Gerstl's proposal to teach facts only—*facts* in italics—is truly fearful to me. I fancy an honest stupid man, like some I know, teaching conscientiously what he considers the *facts* of chemistry or botany, or mechanics; and selecting a book the counterpart of Page's "Advanced Text-book of Geology," or Nicolay's "Physical Geography," bristling with *facts*. The facts of botany, in the hands of most teachers, would be a dreary list I suspect. Mr. Gerstl may teach facts alone successfully, but could the rank and file of our profession do the same?

I will most willingly admit, on the contrary, and maintain, that there exists an early science teaching that is at once useful and well-timed: the excitement and gratification of disinterested curiosity about nature; it is to do for a class, if possible, what an intelligent and encyclopædic father would do for an intelligent child. But how difficult this is for bored and weary schoolmasters! It is so much easier to tell them to get up  $pp. x$  to  $y$  in Oliver or Ansted.

One and only one English book do I know that might almost make a stupid man teach one science well; and that is Mrs. Kitchener's "A Year's Botany" (Rivington's). That happily does not teach facts only; but is the expression of the method of a first-rate teacher in such a form as to enable any one to follow it. And yet I tremble as I mention it, for fear some class of tinies shall be ordered to get it and learn the first six pages for their first lesson in botany.

To conclude, therefore, for I will write no more on this matter, what I advise is to interest young boys in science by conversation, by informal teaching, by Natural History Societies, by encouraging collections, aquariums, &c., but not, except in the case of having that rare thing, a genius for the science master (by which I mean a genius for being a master, not a genius for science), to make science a regular subject of class teaching in the lower forms; but to teach the other subjects *well*. Then to bring in science as compulsory on all, first as Physical Geography and Astronomy or Botany, then as Chemistry with laboratory work, and Physics; and after two or three years to let boys choose their own lines. Some will drop it, others will pursue it further. This is one opinion, in brief, on the right place of science in liberal education. Now let us hear what others have to say.

Rugby, April 8

JAMES M. WILSON

#### NOTES

As might have been expected, Lieut. Cameron met with an enthusiastic reception from a large and distinguished audience at the meeting of the Royal Geographical Society in St. James's Hall on Tuesday night. The hall was crowded, and the Duke

of Edinburgh occupied the chair, surrounded by many eminent geographers. His Royal Highness introduced Lieut. Cameron in a few appropriate and appreciative words. The distinguished explorer gave a narrative of his journey from Zanzibar to the West Coast of Africa, going over ground which is no doubt already pretty familiar to our readers. Sir Henry Rawlinson gave a very clear summary of the work which Lieut. Cameron has accomplished. "He has not been a mere explorer," Sir Henry said, "one of those travellers who carry their eyes in their pockets. He always kept his eyes well about him, and the observations which he made, both of an astronomical and of a physical character, are of extraordinary value. The register of observations which he has brought home, and which are now being computed at the Observatory at Greenwich, promise to be of a most important character. They are astonishingly numerous, elaborate, and accurate, and I have great expectation that one consequence of computing those observations will be that we shall have a definite line laid down from one sea to the other across 20 degrees of longitude, which will serve as a fixed mathematical basis of all future geographical explorations of Equatorial Africa. Among the minor objects achieved by Lieutenant Cameron must be noticed his circumnavigation of the great lake Tanganyika and his discovery of the outlet whereby that lake discharges its waters into the great river Lualaba. Another very important matter is the identification as nearly as possible, not absolutely proved by mathematical demonstration, that the Lualaba is the Congo. One of the main objects of the expedition was to follow down the course of that river so as to prove or disprove the identity of the Lualaba and the Congo. Lieut. Cameron was not able, as he explained to you, to carry out that scheme in its entirety, but he collected sufficient information on the spot to render it a matter, not of positive certainty, but in the highest degree of probability, that the two rivers are one and the same. Another great discovery of his is the determination of a new river system between the valley which he followed of the Lolame, and the scene of Dr. Livingstone's discoveries. This valley, which consists of a large river running through a series of lakes, forms, as he fully believes, and as I also believe, the course of the true Lualaba. The observations which he has furnished respecting latitude, longitude, and elevation, amount to the extraordinary number of nearly 5,000; and he took as many as 130 or 140 lunar observations on one single spot." The Geographical Society has only done its duty in awarding to Lieut. Cameron "the blue riband of scientific geography," its principal gold medal of the year.

THE rules of the French Geographical Society strictly forbid the presentation of a prize to any explorer who has not published the narrative of his discoveries. For this reason the motion for granting a medal to Lieut. Cameron at the anniversary meeting this year, was lost. But in the report and the addresses delivered on that occasion, the admiration of the Society was emphatically expressed. The great medal for 1877 will be granted to Lieut. Cameron, we believe, if the necessary condition of publication shall have been complied with.

THERE was a large gathering last Wednesday evening at the Royal Society Conversazione, which passed off very successfully. One of the most attractive features of these meetings is the instruments and apparatus exhibited; in this respect last Wednesday's meeting was quite equal to any former one. A large proportion of the objects exhibited were connected with Mr. Crookes's recent experiments on light. Among these were the following:—(1) The Torsion Balance. (2) The Turbine Radiometer: (3) Radiometer with the vanes blacked on both sides, showing rotation in either direction according to the way the light falls on them. (4) Radiometer showing the very small amount of residual air which is present. (5) Radiometer show-



ing rotation of the glass envelope when the vanes are held fixed in space. The radiometer carries a magnet on its arms, and is floated on water so as to be free to move. (6) Radiometer having inside it a platinum spiral. (7) Radiometer with one vane counterpoised by a mirror, showing method of keeping the steel point from falling off the cup. (8) Radiometer constructed of metal, showing reverse movement on cooling. (9) Bar-Photometer, showing the method of balancing one light by another. (10) Heat Engine: A Turbine Radiometer, having ice below and hot air above; working by difference of temperature. Connected with this subject, Prof. Osborne Reynolds and Dr. Schuster exhibited various apparatus:—(1) Dr. Schuster's experiment, showing that the force discovered by Mr. Crookes reacts on the vessel in which the vacuum is. (2) An experiment, showing that apparently no part of the force is referable to radiation. (3) An instrument to show that the force acts in a direction perpendicular to the hot surface. (4) A photometer which measures the heating effect of light. Among other objects exhibited were:—A series of four Rhetomes, constructed and exhibited by Mr. Apps; Fossil Elephant Bones, found near London, exhibited by Prof. Tennant; New method of measuring the position of Absorption-Bands in Spectra, and Specimens of Pigments from Human Hair, illustrated by drawings, exhibited by Mr. H. C. Sorby, F.R.S.; New Form of Wave Apparatus, invented and exhibited by Mr. C. J. Woodward; Micro-Geometric Pen, and Medical Battery, with De La Rue's (modified) Chloride of Silver and Zinc Elements, exhibited by Tisley and Spiller; Dr. Siemens exhibited his Bathometer recently described in *NATURE*, and an Attraction Meter, an Instrument by which the attraction of Masses is demonstrated; Mr. Spottiswoode exhibited the largest pair of Nicol's Prisms yet made, and Prof. Tyndall Infusions exposed to Self-cleansed Air; Mr. J. Browning exhibited a large number of beautifully-constructed apparatus, and Mr. W. F. Stanley a Chronobarometer and Chronothermometer, new instruments for registering Atmospheric Temperature and Pressure; Edison's Electric Pen, exhibited by Mr. T. D. Clare. Altogether the objects exhibited were varied and of great interest.

At a meeting of chairmen of sections for organising the conferences in connection with the approaching Loan Collection of Scientific Apparatus at South Kensington which was held on the 10th inst., it was resolved that the conferences should be held on the following dates:—Physics (including Astronomy), May 16, 19, and 24; Mechanics (including Pure and Applied Mathematics and Measurement), May 17, 22, and 25; Chemistry, May 18 and 23; Biology, May 26 and 29; Physical Geography, Geology, Mineralogy, and Meteorology, May 30, June 1 and 2. It is proposed that addresses should be delivered on special subjects, and that the more important instruments exhibited should be described and discussed.

A MEMORIAL has been forwarded to the Prime Minister on the subject of University reform at Cambridge. It is signed by eighteen out of the thirty-four professors, and the Master of Trinity, eighty-three resident Fellows, twenty-nine University officers, lecturers, &c., have appended their names. The memorialists call the Prime Minister's attention to the following points contained in a memorial addressed to Mr. Gladstone three years ago:—“1. No fellowship should be tenable for life, except only when the original tenure is extended in consideration of services rendered to education, learning, or science, actively and directly, in connection with the University or the Colleges. 2. A permanent professional career should be as far as possible secured to resident educators and students, whether married or no. 3. Provision should be made for the association of the colleges, or of some of them, for educational purposes, so as to secure more efficient teaching, and to allow to the teachers more leisure for private study. 4. The pecuniary and other relations subsisting between the University and the Colleges should be revised, and, if

necessary, a representative Board of University Finance should be organised.” The memorialists then go on to express their conviction that, in the interest of science, learning, and education, the reforms specified are urgently required, and the hope that they will be distinctly recognised in any Bill that may be proposed in reference to this University.

We learn from the *Times* that the following are the names of the fifteen candidates for the Fellowship of the Royal Society selected by the Council to be recommended to the Society for election. The day fixed for the election is June 1:—Captain Abney, H. E. Armstrong, Rev. W. B. Clarke, J. Croll, E. Dunkin, Prof. Ericsson, Dr. Ferrier, Colonel Lane-Fox, A. H. Garrod, R. B. Haward, C. Meldrum, E. J. Reed, Prof. Rutherford, R. Swinhoe, and Prof. Thorpe.

We are much pleased to hear that Lord Walsingham has been appointed a trustee of the British Museum. Lord Walsingham is known to all entomologists as a most zealous collector of and authority upon Microlepidoptera. There being at present but one true biologist among the fifty trustees, the addition of a working naturalist will tend to place the department on a more satisfactory footing.

The Committee of the German African Society has decided upon making another attempt to explore Central Africa from the West Coast, under the direction of the African traveller, Herr Mohr.

We understand that Mr. Henry Whitely, jun., so well known for the natural history collections which he has made in Peru, who has recently returned to England, is again about to visit that country, and proposes on this occasion to explore the more northern portion of the Republic. His agent in this country is his father, who resides at 28, Wellington Street, Woolwich.

We have received the prospectus of “A Monograph of the Cinnyridae, or Family of Sun-birds,” by Capt. G. E. Shelley, F.Z.S., the author of “A Handbook to the Birds of Egypt,” &c. The work is to be issued in quarto-sized guinea parts, about twelve in number, each containing ten plates. The plates will be from the pencil of Mr. Keulemans; and the whole will be published as rapidly as their proper execution will permit. The author has, for some time past, been engaged in collecting Sun-birds, and has taken the opportunity of studying them mostly in a state of nature in both Western and Southern Africa.

It is stated that Prof. Andrews of the Queen's College, Belfast, will probably be President of the British Association in 1877.

DR. JAMES RISDON BENNETT, F.R.S., has been elected President of the Royal College of Physicians, London.

The April number of the *New Quarterly Magazine* contains, among other articles of general interest, a paper by the Hon. W. H. Drummond, author of “The Large Game of South Africa,” on some incidents of African travel.

“ON opening his letters last week,” the *British Medical Journal* states, “Prof. Huxley found in one of them a cheque for one thousand pounds, sent by Mr. Thomson, of Manchester, in the name of his lately deceased father, who was a great admirer of Prof. Huxley, and highly appreciated his great achievements in furtherance of our knowledge of the science of life.”

We have much satisfaction in noting that General Myer, Washington, U.S., has resolved to publish, in the *Bulletin of International Meteorological Observations*, the barometrical observations made at all stations 1,000 feet high and upwards, in two columns, one column giving, along with the height, the results reduced to 32° and corrected for instrumental errors only; and



er column giving the same reduced to sea-level. This of publishing the observations will, it is evident, furnish materials for the discussion of important questions of an in- ous character, which could not be attempted if the obser- s at the higher stations were published only as reduced to vel pressures.

No. 13 of the *Journal d'Hygiène*, Dr. de Pietra Santa with well-timed earnestness the importance to medical of keeping steadily in view the two-fold function of climat- r, which is, in the first place, to collect, by means of accu- instruments and simple methods, regular meteorological rations; and in the second place, to observe and study fully the influence of these phenomena in their physiological pathological relations. In the latter case the attention must directed to types and sequences of weather which meteorolo- s have scarcely yet made subjects of investigation.

M. BALARD, whose death we announced last week, was born Montpellier, Sept. 2, 1802. When quite young he mani- ested a strong passion for reading and study. He was early acted to chemistry and physics, and while still young was ade assistant *préparateur* and then *préparateur* in chemistry to e Faculty of Sciences. At the age of twenty-four years he iscovered the element Bromine, and about 1833 was appointed rofessor of Physics to the Montpellier School of Pharmacy and rofessor of Chemistry to the Faculty of Sciences. He mani- ested great perseverance and energy in his researches on the tilisation of sea-water for obtaining various saline bodies, and t was while at Montpellier as professor that he made his fine xperiments on hypochlorous acid and amylic alcohol. In 1843 he succeeded M. Thénard at the Sorbonne, and in 1846 he was, besides, appointed Superintendent of Lectures at the Upper Normal School. In both positions he acquired a high reputation for his solid instruction and his eminent qualities as a professor. In 1854 he was appointed Professor of General Chemistry at the Collège de France, a post which he held till his death. He shortly after quitted his position at the Sorbonne to become Inspector-General of Superior Education. In this capacity he never lost an opportunity of impressing upon teachers the great importance of introducing experimental science into schools; the want of apparatus he considered no difficulty, as for such simple experiments as are required in a school, the teacher, he thought, might easily devise his own apparatus. In 1846 he was made a member of the Academy of Sciences, and other well- deserved honours were awarded him. M. Balard's efforts and discoveries were mainly directed to the economic applications of science, and in this respect he has done much valuable work; and in the future his researches in the utilisation of sea-water may probably turn out to be of even greater practical value than they have hitherto been. M. Balard was a man who made many friends, was warm-hearted and benevolent, and was loved and respected by all who knew him. He has left no written work behind him, but his personal influence in the advance of science in France has been great.

MR. TORRENS has given notice that on April 24 he will ask the Prime Minister if the Government will give effect to the report of the Civil Service Commissioners recommending an im- ovement in the condition of the staff of the British Museum.

We are glad to know that the idea has been broached in New Zealand and Australia, though in a very quiet way, of a union between the various Australian colonies for the prosecution of Antarctic exploration. The idea seems to have been suggested by the action of the mother-country in sending out the Arctic expedition, and we hope it may grow and take substantial shape. It seems to us that it would be a very proper and creditable thing for the Australian colonies to take up Antarctic explora- tion as their special department.

A CORRESPONDENT, Mr. F. Green, writing from Cannes, France, states that on the 8th instant, for the first time this year, he heard the Cuckoo in a valley amongst mountains sixteen miles to the westward of that place. The first time last year that he heard it in the same neighbourhood was on the 10th of April.

ON April 2 at 5.55 A.M., an earthquake was felt at Berne. Two movements took place from east to west. The dura- tion at was two seconds; doors were opened, and church bells were rung by the shocks. In Neuchâtel a strong de- tonation was heard; the oscillation was very strong in the lowest part of the city, and clocks struck the hour before the appointed time. Persons who were in the streets declared that warm wind was blowing for some seconds. A few hours after- wards a rain-spout occurred near Mainz, in Rhenish Hesse. A number of houses were struck by a thunderbolt and ignited, many others were flooded by the water falling from the moun- tains, and people drowned by an instantaneous flood.

THE additions to the Zoological Society's Gardens during the past week include two Chestnut-backed Colies (*Colinus castano- notus*) from the River Daude, W. Africa, presented by Mr. Henry C. Tait; a Sclater's Muntjac (*Cervulus sclateri*) from China, presented by Mr. W. H. Medhurst; a Mandrill (*Cyno- cephalus mormon*), two Yellow Baboons (*Cynocephalus babouin*), a Sooty Mangabey (*Cercocebus fuliginosus*), a Monteiro's Galago (*Galago monteiri*), an African Civet Cat (*Viverra civetta*), a Servaline Cat (*Felis servalina*), a Banded Ichneumon (*Herpestes fasciatus*), a Senegal Touracou (*Corythaix persa*), an Angolan Vulture (*Gypohierax angolensis*), a Marabou Stork (*Leptoptilus crumeniferus*), three Broad-fronted Crocodiles (*Crocodilus fron- talis*), from W. Africa, presented by Lieut. V. S. Cameron; two Secretary Vultures (*Serpentarius reptiliivorus*), from S. Africa, deposited; three Wild Boars (*Sus scrofa*), born in the Gardens.

#### EXPERIMENTAL RESEARCHES ON THE EFFECTS OF ELECTRICAL INDUCTION, FOR THE PURPOSE OF RECTIFYING THE THEORY COMMONLY ADOPTED<sup>1</sup>

##### II.

THE physicist Munck, of Rosenschöld, in his memoir on electrical induction, and on the dissimulation of electricity,<sup>2</sup> concludes that the opposite electricity of the inductor ought to be regarded as bound, since it is connected with the same inductor and cannot be discharged by the induced body.

M. Riess continues to criticise Lichtenberg.<sup>3</sup> He un- wittingly admits the existence of dissimulated electricity, since he says "that inductive electricity remains in part dissimulated." He afterwards says, "What has been published on the subject of bound, latent, dissimulated electricity has had a pernicious effect upon the science." But if I am not deceived, it is quite the opposite way, as will be seen from my experiments, by which all the objections urged by Riess against the new theory of electrical induction, published by Melloni and verified by me, are over- thrown in the clearest possible manner.

Wullner says,<sup>4</sup> "The principal mistake made by Faraday, and on which his reasonings are based, is the hypothesis that induced electricity of the first kind has not the power of acting in an outward direction. It is true that the illustrious English physicist does not explicitly state this hypothesis; but without it his experiments lose all their value." Then according to Wullner, the absence of tension in induced electricity of the first kind is implicitly admitted by Faraday. We shall see that my experi- ments prove how little evidence there is of tension.

Verdet is not deceived<sup>5</sup> when he adduces the contradiction into which the physicists fall who deny that induced electricity of

<sup>1</sup> An Exposition of the Two Theories of Electrical Induction. By M. Paul Volpicelli. Continued from p. 438.

<sup>2</sup> "Pogg. Ann.," vol. 69, pp. 44 and 293.

<sup>3</sup> "Pogg. Ann.," vol. 73, p. 371.

<sup>4</sup> "Lehrbuch der Experimental Physik," 1st ed., vol. ii., p. 695. (Leipzig, 1863.)

<sup>5</sup> "Ann. de Chem. et de Phys.," 3rd series, t. 45, p. 274, note 20.



the first kind is devoid of tension, when they treat of the experiment known as the induced cylinder. Yet the same physicists, Verdet says, admit this want of tension when they treat of the plate condenser, in the instrument known as Volta's condenser, as if these two experiments were not identical. It is clear, he says, that a similar restriction of the same hypothesis is not established, and that if there be dissimulated electricity upon two conducting discs placed near each other, it ought also to exist, although in a less proportion, on two cylindrical or spherical conductors, such as are ordinarily employed in experiments. All this is confirmed by De la Rive; <sup>1</sup> "the experiments of Melloni," he says, "appear to me to account for these anomalies in a satisfactory manner."

In Gehler's Vocabulary <sup>2</sup> we read that Munck, agreeing with Plaff, did not admit the theory of Riess.

Prof. Tyndall thus expresses himself on the subject under discussion <sup>3</sup> :—"When an insulated conductor is under the influence of an electrified body, its repelled electricity is free; but its attracted electricity is held *captive* by the inducing electrified body. If for a moment we put the induced inductor into communication with the earth, its free electricity is dissipated; and if we remove to a distance the inducing electrified body, the *captive* electricity becomes *free*, and is distributed over the surface of the induced conductor." This manner of conceiving the phenomenon of electrical induction agrees perfectly with the new theory of Melloni, which, we maintain, satisfactorily explains the same phenomenon.

Finally, Melloni communicated to the Paris Academy of Sciences <sup>4</sup> (July 24, 1854) his ideas on electrical induction, and maintained, adducing all his reasons in support, that there was ground for amending the theory of induction commonly adopted, that it must be admitted that induced electricity of the first kind did not possess tension, and that the homonym of the inductor is found on every point of the induced body, including the extreme point nearest to the inductor.

After having given this brief but complete *résumé* of the various opinions which have been enunciated on the question, showing that there have never been wanting eminent physicists to maintain that induced electricity of the first kind is entirely devoid of tension, I shall now recount my own observations and experiments, by which, if I am not mistaken, I have proved the truth of Melloni's theory of electrical induction.

EXPERIMENTS.—The experiments I am about to describe should be made when the air is sufficiently dry, as then only are the results perfectly satisfactory.

*First Experiment.*—Upon the conducting cylinder, induced and insulated, the following five facts are proved:—1. On the same cylinder the two opposite electricities exist without neutralising each other. 2. If the extremity of the cylinder nearest to the inductor is put into communication with the earth, it is *only* the homonym of the inductor which is dissipated and not at all the opposite electricity. 3. Of the two kinds of electricity which are in the cylinder, the homonym of the influent *alone* is dissipated by contact with the air. 4. Points applied to the extremity of the cylinder nearest to the inductor allow only the homonym of the inductor to escape and not at all the opposite electricity. 5. Induced electricity of the first kind is not transferred from the induced body to the inductor, but the electricity of the inductor may certainly be transferred to the induced body.

These five experimental facts cannot be logically explained by the old theory of electrical induction, but only by the new, showing that induced electricity of the first kind does not possess tension, *i.e.*, that it is entirely dissimulated, and that induced electricity of the second kind, *i.e.*, the homonym of the inductor, is entirely free on all points of the induced object.

*Second Experiment.* <sup>5</sup>—In the communication referred to in the note are analysed the phases of divergence produced in the gold-leaf electrometers applied to the extremity of the insulated induced body nearest to the inductor. The same phases were obtained by means of two simultaneous inductions, the one principal, which came from the inductor, the other secondary, which came from the analyser.

On this ground it is concluded that these phases, when they are fairly interpreted, prove that the homonym of the inductor exists also on the extremity indicated, and that on this account the induced electricity has no tension. In the same experiment

it was seen how these phases may be misleading, if we do not examine carefully the simultaneous effects of the two inductions indicated. The explanation of this experiment allows a much greater development than that of Melloni, published by M. Regnault in the "Comptes Rendus," t. 39, p. 177 (July 24, 1854).

*Third Experiment.*—When, into the inductive sphere of an electrified body, *a*, is introduced, <sup>1</sup> with the necessary precautions, another insulated body, *b*, the electricity of the inductor, *a*, always attracts and completely dissimulates the induced body, *b*, the opposite electrical condition, expelling the homologue, and rendering it completely *free*. But this is not all. There is another fact, which has not yet been indicated, *viz.*, that if we bring close to or remove away from the inducing body, *a*, another body, *c*, then part of the dissimulated electricity in the induced *b* becomes *free* in the former case, while in the second case it increases in *b*, at the same time that the opposite condition is developed in it.

In the paper above cited all the experiments confirming this result are given, from which we conclude that the induced electricity of the first kind does not possess tension.

*Fourth Experiment.*—The first experiments made for the purpose of discovering if electrostatic induction can be effected in curved lines, are due to the illustrious Faraday, who, in one of his latest papers, says that by his experiments he believes he has established the possibility of this induction; perhaps the facts which I have discovered, and which are completely verified when the atmosphere is dry, may establish its certainty. These experiments, by which is proved the existence of curvilinear induction, will be found described in "Comptes Rendus," t. 43, p. 719.

*Fifth Experiment.*—This fifth experiment <sup>2</sup> contains an account of six considerations and of five experiments, by means of which it is shown that induced electricity of the first kind does not possess tension, and that the induced insulated cylinder shows at all points the existence of the homonym of the inductor.

*Sixth Experiment.*—In this <sup>3</sup> are described several experiments which show the existence of curvilinear induction, and prove at the same time that the separation of the gold-leaf electrometers, applied to the extremity of the induced body furthest from the inductor, is produced principally by this influence, and to a very small extent by the homonym of the inductor.

*Seventh Experiment.*—In this <sup>4</sup> is shown, in a different manner, that induced electricity of the first kind has no tension, and that on any point of the induced body there is always found the homonym of the inducing, not excepting the extremity nearest to the inductor, provided that the proper means is employed, as described in the communication referred to.

*Eighth Experiment.*—In this <sup>5</sup> are analysed the objections made by M. Riess to some of my experiments on electrical induction, and the doctrine of Melloni on this subject is confirmed by other facts. The conclusion is that the objections of M. Riess are not justifiable, and that if this eminent physicist had repeated the experiments which he criticises, he would have found them to be genuine, and would not have declared them to be inexplicable. It is now more than sixteen years since I made this reply to M. Riess, always communicating other experiments bearing on the same point; but, so far as I know, he has raised no other objections to the theory of Melloni.

*Ninth Experiment.*—In this communication <sup>6</sup> eight reasons are adduced to show that induced electricity has no tension. The same reasons do not hold good on the old theory, while Melloni's new theory of electrical induction explains them completely. This new theory does not entirely overturn the old, as some have mistakenly believed; the former only essentially modifies the latter in some of its parts.

*Tenth Experiment.*—This is a reply to the note of M. Gaugain, in which he observes that, notwithstanding the various experiments adduced by M. Volpicelli, it is still strongly maintained that induced electricity of the first kind possesses tension. <sup>7</sup>

*Eleventh Experiment.*—In this are advanced various observations, some on tension, both electro-static and electro-dynamical, and others on electrical induction. <sup>8</sup>

*Twelfth Experiment.*—In this communication it is observed

<sup>1</sup> "Comptes Rendus," t. 41, p. 553 (Oct. 8, 1855).

<sup>2</sup> *Ibid.*, t. 44, p. 17 (May 4, 1857).

<sup>3</sup> *Ibid.*, t. 47, p. 623 (Oct. 18, 1858).

<sup>4</sup> *Ibid.*, t. 47, p. 664 (Oct. 23, 1858).

<sup>5</sup> *Ibid.*, t. 48, p. 1162 (June 27, 1859).

<sup>6</sup> *Ibid.*, t. 59, p. 570 (Sept. 26, 1864).

<sup>7</sup> *Ibid.*, t. 59, p. 962 (Dec. 5, 1864).

<sup>8</sup> *Ibid.*, t. 61, p. 548 (Oct. 2, 1865).

<sup>1</sup> "Archives des Sciences Phys. et Nat. de Genève," t. 26, p. 323, note 1.

<sup>2</sup> Vol. ii. p. 131. (Leipzig, 1843.)

<sup>3</sup> "Les Mondes," 2nd series, vol. xxiii. p. 566, § 79.

<sup>4</sup> "Comptes Rendus," t. 38, p. 177.

<sup>5</sup> Published in the "Comptes Rendus," t. 40, p. 246 (Jan. 29, 1855).



continuous electrophori furnish, when carefully examined, proof that induced electricity does not possess any tension. In the case of these machines, as in that of frictional ones, the conducting spikes of the prime conductor possess opposite electricities co-existent on the same points; this is shown by means of a very small proof-plane.<sup>1</sup>

*Twelfth Experiment.*—It is shown, by means of Geissler's submitted to the electrical influence, that induced electricity of the first kind has no tension.<sup>2</sup>

*Thirteenth Experiment.*—Here it is observed that the proof-plane, whether submitted or not to electrical induction, always receives by contact a charge greater than that which is free on the element which it has touched. Then the *coibent*, always pensable in the construction of the proof-plane, receives, by induction, a certain quantity of electricity, besides that obtained by communication with the metallic part. This infiltration of electricity varies not only with the nature of the *coibent*, but also with its quantity, within certain limits. This communication contains other observations on electrical induction, and it is concluded that on the extremity of the induced body nearest the inductor, the two opposite electricities coexist, and that the subsequently induced electricity of the first kind has no tension. It is also concluded that the homonym of the inductor is always found on whatever point of the induced body this may be, and that the homonym indicated is the only one to be dissipated, and that it alone is the only one endowed with tension.

*Fifteenth Experiment.*—In this is explained Nicholson's duplicator, which is satisfactory, since it is based on the want of tension in induced electricity of the first kind.<sup>4</sup>

*Sixteenth Experiment.*—In this is shown how we may shield from curvilinear induction the electroscope which hangs from the extremity of the induced body nearest to the inductor. From this experiment it is concluded that the divergence of the straws is due principally to curvilinear induction, and that induced electricity of the first kind does not possess tension.<sup>5</sup>

*Seventeenth Experiment.*—In this is analysed a little known electrostatic phenomenon; and from this analysis it follows that induced electricity of the first kind has no tension.<sup>6</sup>

*Eighteenth Experiment.*—It is shown mathematically that electric induction does not traverse conducting masses. It is afterwards observed that first the Florentine academicians and then Faraday admitted this truth. It is also observed that if we admit that induced electricity of the first kind possesses no tension, we arrive at the conclusion given below by means of experiment.<sup>7</sup>

CONCLUSION.—Upon an insulated conductor submitted to the electric influence—1. Induced electricity of the first kind does not possess tension. 2. It is found in greater quantity at the extremity of the induced body nearest to the inductor, and diminishes always as it approaches the other extremity. 3. Induced electricity of the second kind, *i.e.*, the homonym of the inductor, is found on every point of the induced body, not excepting the extremity nearest to the inductor; it continually increases in proportion as it approaches nearer to the other extremity, and is always free.

### SCIENTIFIC SERIALS

*Mind*—A Quarterly Review of Psychology and Philosophy. Edited by George Croom Robertson, M.A., Professor of Philosophy of Mind and Logic, in University College, London. Jan. 1876.—*Revue Philosophique de la France et de l'Étranger*. Dirigée par Th. Ribot. Première Année. Janvier 1876: Paris.—The growing importance of psychology has been asserted by the simultaneous appearance of a French and an English review, especially devoted to its interest. In scope and character the two publications are identical. One aim of the projectors of *Mind* seems to be to obtain a decision of the question: Is psychology a science? "Nothing less, in fact, is aimed at in the publication of *Mind*." The first number opens with a lecture on "The Comparative Psychology of Man," read before the Anthropological Institute, by Mr. Herbert Spencer. It is one mass of valuable suggestions, and every reader will follow with interest the divisions and sub-divisions under which Mr. Spencer recommends that the subject should be studied.—Next follows

<sup>1</sup> "Comptes Rendus," t. 67, p. 843 (Oct. 26, 1868).

<sup>2</sup> *Ibid.*, t. 69, p. 730 (Sept. 27, 1869).

<sup>3</sup> *Ibid.*, t. 74, p. 860 (March 25, 1872).

<sup>4</sup> *Ibid.*, t. 75, p. 257 (July 29, 1872).

<sup>5</sup> *Ibid.*, t. 76, p. 169 (Jan. 20, 1873).

<sup>6</sup> *Ibid.*, t. 76, p. 1296 (May 26, 1873).

<sup>7</sup> *Ibid.*, t. 78, p. 901 (March 30, 1874).

under the title "Physiological Psychology in Germany," a rather lengthy account, by Mr. James Sully, of a work by Prof. Wundt of Leipzig. The other leading articles are in their order:—"Consistency and Real Inference," by Mr. John Venn; in which the comparative merits and defects of the conceptualist and material views of logic are considered. Towards the end of the article Mr. Venn refers to what he calls an irrelevant difficulty which sometimes puzzles the student of Mill. How, asks the student, can Mr. Mill, while professing to be an idealist, lay it down that logic has to do with the facts or things themselves, rather than with our ideas about them? We do not see that the consistency of Mr. Mill would be very conclusively vindicated even were it the fact that he did not allow his idealism to interfere with his logic more than does an idealistic astronomer allow his metaphysics to affect his astronomy. But does not Mr. Mill fall back on his idealism when in his discussion with Mr. Herbert Spencer as to the number of terms in the syllogism, he maintains that the things named in the premises and conclusion of a syllogism are our sensations or expectations of sensations, while Mr. Spencer holds the things spoken of to be so many separate objective entities? In an able and interesting paper, Mr. Henry Sidgwick discusses "The Theory of Evolution in its Application to Practice," and finds that when guidance is needed in ethics or politics the doctrine of evolution will not help us. A distinction between "Philosophy and Science," is next worked out by Mr. Shadworth H. Hodgson, in which he displays all his remarkable delicacy of thought. He finds the peculiar scope of philosophy to be "ultimate subjective analysis of the notions which to science are themselves ultimate." We doubt if Mr. Lewes would admit that this is not included in his conception of philosophy as embodied in the really great work on which he is now engaged. An excellent article on "Philosophy at Oxford," is contributed by the Rector of Lincoln College, which it is perhaps not too much to hope may bear some practical fruit. Coming last and occupying the place of the novel in the magazine, is "The Early Life of James Mill," to be continued, by Prof. Bain. In addition to being of intense interest to all who care for mental science, it has been eagerly read and discussed by many who have read nothing else in *Mind*. Short Critical Notices and Reports, and neat little Notes by the editor and others, complete the volume. We sincerely hope Prof. Robertson will be able to keep the *Review* up to the standard of this first number. To make it a commercial success will not be an easy task, for though philosophy has of late been a marketable commodity, that has been when distributed among many periodicals.

Of the *Revue Philosophique* we can say only a very few words. The first number opens with a most interesting and suggestive account, by M. Taine, of observations he made on the acquisition of language by a female child. His speculations about words entirely invented by the child and carrying with them natural meanings, as also his reasonings from the childhood of the individual to that of the race, are ingenious and plausible. He concludes with some excellent remarks on Max Müller's view that in *rational* language we find the distinctive characteristic of man. According to M. Taine the use of words, sounds carrying with them a vague general connotation, is, like the use of ornaments and the use of tools, in common with numerous other indications, an evidence that the stage human has been reached. The psychological condition of this superiority, he continues, will be found in a greater aptitude for general ideas, and its physiological condition in a larger and finer development of brain. In the second article the doctrine of final causes is ably discussed by M. P. Janet, from various points of view. He concludes, however, by maintaining a form of the doctrine, which, as far as we can see, without being able to serve any practical end, supposes a theory that lies wholly outside the boundaries of science. Mr. Herbert Spencer's lecture on "The Comparative Psychology of Man," of which we have already spoken, comes next. The remainder of the number is taken up with reviews of books.

THE *Journal of the Chemical Society* for February contains the following papers:—On the presence of liquid carbon dioxide in mineral cavities, by W. N. Hartley. The author's researches have been chiefly confined to quartz, evidence of the nature of the enclosed liquid being furnished by the specific gravity of the liquid as compared with water (which was also contained in the cavities), and by observing the critical temperature. The author is of opinion that the fluid-cavities of sapphires and rubies also contain carbon dioxide.—On certain bismuth compounds, by



M. M. Pattison Muir. The author has examined the trichloride, tribromide, and the so-called bismuthic acid.—On bismuthiferous tesselar pyrites, by W. Ramsay. The formula of this mineral appears to be  $(\text{Ni}, \text{Co}, \text{Fe})(\text{As}, \text{Bi})_3$ .—On the occurrence of native calcium chloride at Guy's Cliffe, Warwickshire, by John Spiller.—The decomposition of alcohol and its homologues by the joint action of aluminium and its halogen compounds, by Dr. J. H. Gladstone and Alfred Tribe. Aluminium and its iodide have no action upon methyl alcohol. Ethyl alcohol is energetically decomposed by a mixture of these substances, hydrogen gas being evolved in large quantities and a pasty residue being left, which the authors consider to be aluminic iodo-ethylate. Heated to  $275^\circ \text{C}$ . this residue fuses and undergoes decomposition thus:—

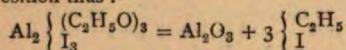

The authors have likewise obtained evidence of the existence of aluminic ethylate. Amylic alcohol is decomposed also by these substances. A mixture of the chloride with the metal has no action upon alcohol; the bromide has a decided action.—Ethyl-phenyl-acetylene, by T. M. Morgan. This substance has been obtained by the action of ethyl iodide upon the sodium compound of phenyl-acetylene the two substances being mixed with ether and heated in sealed tubes.—Narcotine, cotarnine, and hydrocotarnine, by G. H. Beckett and Dr. C. R. A. Wright. The authors have studied the action of water upon narcotine hydrochloride, the action of ethyl iodide on hydrocotarnine, narcotine, and cotarnine, and the action of acetic anhydride on all three of these bodies. Dr. Wright adds an appendix on the structural formulæ of narcotine and its derivatives.—Note on incense resin, by Dr. J. Stenhouse and C. E. Groves. This resin is the produce of *Icica heptaphylla*, Aubl., a native of British Guiana. The essential oil contains a hydrocarbon of the empirical formula  $\text{C}_5\text{H}_8$ , which the authors propose to call conimene. To the crystalline resin the authors assign the formula  $\text{C}_{46}\text{H}_{76}\text{O}$ , and propose the name *icacin*.—On certain sources of error in the ultimate analysis of organic substances containing nitrogen, by G. S. Johnson. These errors are: first, increase of weight by the absorption of oxygen by *nitrite* contained in the solution in the potash bulb owing to the passage of unreduced nitrous anhydride over the ignited copper. Secondly, the presence of occluded hydrogen in the metallic copper reduced in this gas, which is given off on the application of heat and reduces the surface film of oxide, producing water which adds to the weight of the chloride of calcium tube.

## SOCIETIES AND ACADEMIES

### LONDON

Royal Society, March 16.—Preliminary Reports to Prof. Wyville Thomson, F.R.S., Director of the Civilian Scientific Staff. I. On the true Corals dredged by H.M.S. *Challenger* in deep water between the dates Dec. 30, 1870, and Aug. 31, 1875, by H. N. Moseley, Naturalist to the Expedition.

The author gives a list of the corals dredged in a depth of 50 fathoms and upwards, with notes on each. The whole is necessarily preliminary, on account of the impossibility of sufficient comparisons being made, and references obtained. The results embody great additions to our knowledge concerning the bathymetrical range of corals. Only one coral has been obtained from a greater depth than 1,600 fathoms; it is *Fungia symmetrica*. Only three other corals have been obtained at as great a depth as 1,500 fathoms. Only about twenty-seven genera of corals have as yet been proved to exist in a depth of 250 fathoms and upwards; of these a list is given, to which is added those obtained by the U.S. Coast Survey and the *Porcupine*, making forty-two genera in all. Of these twenty occur in the fossil state. No coral in any way allied to the *Rugosa* has been dredged by the *Challenger*.

II. On work done on board the *Challenger*, by Mr. John Murray, Naturalist to the Expedition. This Report includes the preliminary notice on oceanic deposits, describing specimens of the sea-bottoms obtained in the soundings, dredgings, and trawlings, over 300 in number, during the years 1873-1875, between England and Valparaiso. The deposits may be classed as follows:—

#### 1. Shore Deposits—

(a) Blue and green muds.—Met with near the shores of most of the great continents and islands.

(b) Grey muds and sands.—Met with chiefly near oceanic islands of volcanic origin.

(c) Red mud.—Met with on the eastern coast of South America.

(d) Coral mud.—Met with near coral reefs.

2. *Globigerina Ooze*.—An abundant oceanic deposit not met with south of latitude  $50^\circ \text{S}$ .

3. *Radiolarian Ooze*.—An oceanic deposit met with only in the Western and Middle Pacific.

4. *Diatomaceous Ooze*.—An oceanic deposit met with only south of  $50^\circ \text{S}$ . latitude.

5. *Red and Grey Clays*.—The most abundant oceanic deposit.

The deepest sounding (4,475 fathoms) was a *Radiolarian ooze*.

In the early part of the cruise many attempts were made by all of the naturalists to detect the presence of free protoplasm in or on the bottoms from the soundings and dredgings, but with no definite result. It was undoubted, however, that some specimens of the bottom preserved in spirit assumed a very mobile or jelly-like aspect, and also that flocculent matter was often present.

At this point Mr. Buchanan determined that the flocculent matter was simply the amorphous sulphate of lime precipitated by spirit from the sea-water associated with the ooze. Subsequently a number of experiments were made, in conjunction with Mr. Buchanan, upon the behaviour of this amorphous precipitate when precipitated with different quantities of spirit, and when treated with colouring solutions. The precipitate was also examined alone and mixed up with some of the ooze. The ooze was examined at the same time, and in the same manner, but without having been treated with spirit. The results were shortly these:—

“When sea-water is treated with twice its volume of spirit or less, nearly the whole of the amorphous precipitate assumes the crystalline form in a short time.

“When treated with a great excess of spirit the precipitate remains amorphous, and assumes a gelatinous aspect.

“This gelatinous-like sulphate of lime colours with the carmine and iodine solutions, and when mixed with the ooze has, under the microscope, the appearances so minutely described by Haeckel.

“The ooze washed with distilled water, or taken just as it comes up, and treated in the same manner with colouring solution, does not show these appearances.”

When it is remembered that the original describers worked with spirit-preserved specimens of the bottom, the inference seems fair that *Bathypus* and the amorphous sulphate of lime are identical, and that in placing it amongst living things the describers have committed an error.

A preliminary report on vertebrates is then given, containing a list of all the fishes taken in the trawl or dredge. New forms necessitate modifications in the definitions of some families, but it has not been found necessary to establish any new families. The deep-sea and oceanic forms belong to the families—*Stenoptychidae*, *Macruridae*, *Ophidiidae*, *Scopelidae*, *Stomatidae*, *Pediculari*, *Halosauridae*, *Notocanthi*, *Muraenidae*, and *Trochidae*.

Of the Petrels and Penguins very extensive collections have been made, as skins and as spirit specimens. Two or three skeletons of very large specimens of the Sea-elephant have been preserved.

III. On observations made during the earlier part of the voyage, by the late Dr. R. von Willems-Suhm, naturalist to the Expedition. This report is on the Atlantic fauna only. Among the most interesting results obtained may be mentioned briefly the facts that shrimps in great depths are liable to be attacked by considerably large Gordiaceous worms; that a curious intermediate form between Priapulids and Sipunculids has been discovered; that relations of the famous Jurassic Eryonidae are still living in the great depths, where they are (in the Pacific at least) by no means rare.

March 23,—“On the Force caused by the Communication of Heat between a Surface and a Gas; and on a New Photometer,” by Prof. Osborne Reynolds, communicated by E. Stewart, F.R.S., Professor of Natural Philosophy in Owens College, Manchester.

This paper contains an account of an experimental investigation undertaken with a view to support, by absolute measurements, the theoretical arguments by which the author endeavoured to prove the existence of reactionary forces or “heat-



s, whenever heat is communicated from a surface to a *vice versa*, and the connection between these forces and motion caused by heat and light falling on bodies *in vacuo*. The result obtained one of the beautiful little "Light-Mills" erected by Dr. Geissler, of Bonn, the author was in a position to make quantitative measurements of the effects produced and of the force producing them.

In the first place, with regard to the sufficiency of the residual cause the motion. It was found that this air is, with the exception of the friction of the pivot, which is found to be so small as to be inappreciable, the sole cause of the resistance in the mill experiences, of the limit which is imposed on its motion for such intensity of light, and of the rapidity with which it sets to rest when the light is removed. The law of resistance as determined by careful measurements, is found to agree exactly with the resistance which highly rarefied air would offer to its motion; and this law is distinctly special in its character, being proportional to the velocity at low speeds, and normally tending towards the square of the velocity as the speed increases.

Having established the fact that there is sufficient air in the space (and Mr. Crookes's behaves in the same manner as the air) to balance, by its resistance, the force which moves the mill, it is argued that all question as to the sufficiency of the air to cause the forces is removed. What the air can prevent it can prevent.

It regards the possibility of the motion being in any way the direct result of radiation. This supposition the author had previously shown to be directly contradicted by the fundamental law of motion that action and reaction are equal. A cold body is always away from a hot body, while, if free to move, the hot body always runs after the cold body, showing that the force does not act from body to body, but that each body propels itself through the surrounding medium in a direction opposite to its hottest side, the effect of one body on the other being due solely to the disturbance which it causes in the equilibrium of temperature.

Besides proving that the force acts between the vanes of the mill and the medium immediately surrounding them Dr. Schuster's experiments furnish a quantitative measure of the actual force. From this measure it is shown on theoretical grounds that the difference of temperature on the two sides of the vanes necessary to cause heat-reactions of this magnitude could not be less than  $1^{\circ}7$ , while the probability is that it is considerably more.

In order to apply this test and see how far the actual difference of temperature in Dr. Schuster's experiments correspond with that deduced from the theory, a new photometer was devised by the author with an immediate view of measuring the difference of temperature caused by light on a black and a white surface.

Of two thin glass globes,  $2\frac{1}{2}$  inches in diameter, connected by a syphon tube  $\frac{1}{2}$  inch internal diameter, one was blackened with lamp-black on the inside over one hemisphere and the other was whitened with chalk in a similar manner, the two clean faces of the globes being turned in the same direction. Oil was put in the tube and the globes were otherwise sealed up. Any light which enters through the clean faces is received on the black and white surfaces, and the air in the globes expands in accordance with the difference of temperature which they attain, moving the oil in the tube. A motion of  $\frac{1}{2}$  an inch on the part of the oil shows a difference of  $2^{\circ}$ , in the temperature of the air within the globes.

The instrument so constructed is exceedingly delicate, and will show a difference in the intensity of light sufficient to make one revolution per minute difference in the speed of the mill.

Measured with this instrument, the difference of temperature caused by the light necessary to give the mill 240 revolutions per minute does not exceed  $24^{\circ}$ , and is probably less than this, which shows that the theoretical difference of heat necessary to cause the heat-reactions is well within the difference as actually measured, leaving an ample margin for error in the methods of approximation used in the calculation.

In concluding the paper the author claims to have set at rest the only point respecting the explanation of the motion caused by heat, which remained doubtful after he had discovered that, according to the kinetic theory, the communication of heat to a gas must cause a force reactionary on the surface, *viz.*, whether this reaction was adequate in amount to cause the results seen to take place.

He adds a suggestion as to a new form of light-mill to have vanes inclined like the sails of a windmill, and not having one side white and the other black, like the light-mills at present constructed. Arguing that the forces act perpendicularly to the surface, and in a direction independent of that from which the

light comes; so that such a mill would turn like a windmill with the full and not merely the differential effect of the light. Such a mill, he concludes, would furnish another test as to whether or not the force is directly referable to radiation.

Geological Society, March 22.—Prof. P. Martin Duncan, F.R.S., president, in the chair.—Frank Campton, Henry J. Gardiner, Henry Percy Holt, Lord Rosehill, Harold Underhill, Frederick Thomas Whitehead, and Thomas Wrightson were elected Fellows of the Society.—On the Triassic strata which are exposed in the cliff sections near Sidmouth, and a note on the occurrence of an Ossiferous zone containing bones of a *Labyrinthodon*, by H. J. Johnston Lavis. The author described the base of the cliffs east of Sidmouth as composed of the marl which is the uppermost subdivision of the Trias in South Devon, capped in Littlecomb Hill and Dunscomb Hill by greensand and chalk, and in Salcombe Hill by greensand alone. In the valley of the Sid it is largely exposed at the surface. Close to the mouth of the Sid the upper sandstone crops out beneath the marl, forming a cliff overhanging the river. To the west of Sidmouth there is a low projecting cliff, the Chit rock, formed also of the upper sandstone, and at the western end of this is a fault which has given the Chit rock an upthrow of at least 40 and perhaps of 80 feet, since it has no marl capping it, and in its lithological character it resembles the middle part of the Upper Sandstone. To this point the dip is to the east; but westward of the fault the dip is at first to the west for about half a mile, when the sandstone reappears with an easterly dip, having formed a synclinal curve. It is overlain by marl and greensand in Peake and High Peake Hills, which are capped with chalk gravels. West of High Peake Hill the sandstone forms the whole cliff. The author described the general characters presented by the Triassic beds in the section under notice, and mentioned the occurrence at about 10 feet from the top of the sandstone of a peculiar series of beds, composed of coarse sandstone, containing scattered nodules of marl from the size of a pea to that of a hen's egg, together with numerous fragments of bone, some of which, belonging to a species of *Labyrinthodon*, would be described by Prof. Seeley. The author mentioned that he had received from the Rev. S. H. Cooke some fragments of bone obtained by him twenty years ago from this same "Ossiferous zone." Mr. Whitaker's specimen of *Hyperodapedon* was also obtained from the upper sandstone.—On the posterior portion of a lower jaw of *Labyrinthodon* (*L. lavisi*) from the Trias of Sidmouth, by Mr. Harry Govier Seeley, F.L.S., Professor of Physical Geography in Bedford College, London. After referring to the doubtful position of the *Labyrinthodontia* in the system, and expressing his doubts as to the occurrence of the genus *Mastodonsaurus* in Britain, the author proceeded to describe in detail the posterior part of the right ramus of the lower jaw of a *Labyrinthodont*, obtained by Mr. Lavis from the ossiferous zone of the Trias near Sidmouth, the position of which was described by that gentleman in the preceding paper. The specimen, which is 13 inches long, and perfectly free from matrix, shows that the lower jaw in *Labyrinthodonts* not only contains articular, angular, and dentary elements, as hitherto supposed, but also separate sphenial and surangular elements, and probably a distinct coronoid bone. These bones were described in detail, and the author remarked that although they are somewhat reptilian in aspect and arrangement, they are not very suggestive as to the affinities of *Labyrinthodon*. They surround a central hollow space, which no doubt received the primitive cartilage round which the bones were ossified; and the persistence of this character would seem to be a link rather with the lower than with the higher vertebrata. The jaw differs from the Batrachian mandible in possessing well-developed angular and surangular elements, and some reptiles, such as crocodiles and the marine *Chelonia*, present analogies in the perforations, the structure of the jaw, and the sculpture of the bones. In size the specimen is almost identical with that figured by Mr. Miall as belonging to *Labyrinthodon pachygnathus*, but the depths and outlines of the postarticular part of the jaw, and differences in the sculpture of the lateral subarticular ornament, furnish distinctive characters which lead the author to describe the present species as representing a new species, which he names, in honour of its discoverer, *Labyrinthodon Lavisi*. The author briefly noticed several other bones and fragments obtained by Mr. Lavis in the same locality, some of which probably belonged to the same skeleton.—On the discovery of *Melonites* in Britain, by Mr. Walter Keeping, communicated by Prof. T. M'Kenny Hughes. The author described a specimen from the carbo-



niferous limestone of Derbyshire in the museum of the Geological Survey, which displays numerous plates belonging to the test of a large Echinoïd, considered by him to be a new species of the genus *Melonites*, hitherto regarded as peculiar to America. The author proposed to call this species *Melonites Etheridgii*, and he described it as possessing a more or less spheroidal test, about seven inches in diameter, composed of very thick plates, arranged in five ambulacral and five interambulacral areas, all the plates being ornamented with minute tubercles for the support of spines. The interambulacral areas were probably about twice as broad as the ambulacral, and composed (at the equator) of about nine ranges of plates, the marginal ones pentagonal, the rest hexagonal, articulating with each other by faces varying from a right angle to one of 30°. The ambulacral areas were broad, each formed of two convex ribs separated by a meridional depression running from mouth to anus, and each rib (half-area) composed of six or seven ranges of irregular plates, each perforated by a pair of simple pores. The tubercles are minute, imperforate, without boss, and of two orders, the larger surrounded by a smooth areola, bounded by an elevated ring. The spines are small, tapering, coarsely sulcate, with a prominent collar round the articular end. A second specimen exists in the British Museum. The species differs strikingly from the North American *Melonites multiporus* in the characters of the ambulacral areas, which have 12-14 ranges of plates, and are divided by a meridional furrow in the new species, and only eight ranges of plates, with a median ridge formed of plates twice as large as the rest in *M. multiporus*.—Note on the phosphates of the Laurentian and Cambrian rocks of Canada, by Principal Dawson, F.R.S. The author described the mode of occurrence of phosphatic deposits in various localities in Canada. Dark phosphatic nodules, containing fragments of *Lingula*, abound in the Chazy formation at Allumette Island, Grenville, Hawkesbury, and Lochiel. Similar nodules occur in the Graptolite shales of the Quebec group at Point Levis, and in limestones and conglomerates of the Lower Potsdam at Riviere Ouelle, Kamouraska, and elsewhere on the lower St. Laurence; these deposits also contain small phosphatic tubes resembling *Serpulites*. The Acadian or Menevian group near St. John, New Brunswick, contains layers of calcareous sandstone blackened with phosphatic matter, consisting of shells and fragments of *Lingula*. The author described the general character of the phosphatic nodules examined by him at Kamouraska, and gave the results of analyses made of others from various localities, which furnished from 36.38 to 55.65 per cent. of phosphate of lime. A tube from Riviere Ouelle gave 67.53 per cent. The author accepted Dr. Hunt's view of the coprolitic nature of the nodules, and inclined to extend this interpretation to the tubes. The animals producing the coprolites could not be thought to be vegetable feeders; and he remarked that the animals inhabiting the primordial seas employed phosphate of lime in the formation of their hard parts, as had been shown to be the case with *Lingula*, *Conularia*, and the Crustaceans. The shells of the genus *Hyalolithes* also contain a considerable portion of phosphate of lime. Hence the carnivorous animals of the Cambrian seas would probably produce phosphatic coprolites. With regard to the Laurentian apatite deposits, the author stated that they, to a great extent, form beds interstratified with the other members of the series, chiefly in the upper part of the Lower Laurentian above the *Eozoön* limestones. The mineral often forms compact beds with little foreign matter, sometimes several feet thick, but varying in this respect. Thin layers of apatite sometimes occur in the lines of bedding of the rock. Occasionally disseminated crystals are found throughout thick beds of limestone, and even in beds of magnetite. The veins of apatite are found in irregular fissures; and as they are found principally in the same parts of the seams which contain the beds, the author regarded them as of secondary origin. The Laurentian apatite presents a perfectly crystalline texture, and the containing strata are highly metamorphosed. The author's arguments in favour of its organic origin are derived from the supposed organic origin of the iron-ores of the Laurentian, from the existence of *Eozoön*, from the want of organic structure in the Silurian deposit described by Mr. D. C. Davies, and the presence of associated graphite in both cases, from the character of the Acadian linguiferous sandstone, which might by metamorphism furnish a pyroxenite rock with masses of apatite, like those of the Laurentian series, and from the prevalence of animals with phosphatic crusts in the Primordial age, and the probability that this occurred also in the earlier Laurentian. The position of the phosphatic deposits above the horizon of *Eozoön* is also adduced by the

author as adding probability to the existence of organic agencies at the time of their formation.

## PARIS

Academy of Sciences, April 3.—Vice-Admiral Paris in the chair.—The following papers were read:—On the displacement of lines in the spectra of stars, produced by their motion in space, letter from P. Secchi. The author tabulates a number of the observations made by Huggins, Vogel, and himself, and those at Greenwich Observatory, and shows there is considerable contradiction in the results. Might there not, he asked, be some cause of systematic error in the manner of observing or in the instruments? Comparing the dark line F of Sirius with the hydrogen line H $\beta$  from a Geissler tube, he got always the same result—a shortening of the Sirius waves (contrary to Huggins), when the telescope was carried along by the clock-work, and the assistant was at the seeker to keep it on a fixed point, and corresponding to the slit of the spectroscope; but if the clock-work stopped, or the assistant deranged the position of the star, the bright line was displaced and came into coincidence with the star line. Dispensing with clock-work, the line was found to be on one side or the other according as the star was looked at on one side or the other of the axis of the telescope. A change was also had on turning the spectroscope 180° on its axis. P. Secchi merely points out these possible sources of illusion without trying to explain them.—Observations of sun-spots made at the Toulouse Observatory in 1874 and 1875, by M. Tisserand. In 1874, 237 spots were observed; in 1875 there were only 88. Of the 76 spots observed at least three times in 1874, 41 were in the boreal hemisphere, 35 in the austral, with a mean latitude (+ or -) of 10°5'. Of the 29 observed three times in 1875, 17 were in the boreal, 12 in the austral hemisphere; the mean latitude was 11°7'. M. Tisserand tabulates his observations with reference to diurnal rotation.—Testing for vinic alcohol in mixtures, and especially in presence of wood spirit, by MM. Alf. Riche and Ch. Bardy.—On the spermatia of the Ascomycetes, their nature and physiological rôle, by M. Max. Cornu. The spermatia were at first considered by M. Tulasne as fecundating corpuscles; and in support of this was their apparent refusal to germinate in the same conditions as three other sorts of spores. M. Cornu says he has obtained a very complete germination of spermatia in certain cases. Some times the action of pure water will suffice to bring them to vegetation, more often it is necessary to add nutritive elements. The facts observed refute the old theory of fecundation, and the simplification introduced into the number of reproductive organs gives a grand unity to the polymorphism of Ascomycetes.

## CONTENTS

PAGE

A RESEARCH FUND FOR THE CHEMICAL SOCIETY. By Dr. W. J. RUSSELL, F.R.S.	470
TAIT'S "RECENT ADVANCES IN PHYSICAL SCIENCE. By Prof. J. CLERK MAXWELL, F.R.S.	471
DR. BALL ON SCREWS. By J. D. E.	472
OUR BOOK SHELF:—	
Contributions to the Dresden Museum	474
Bristow's "Table of British Sedimentary Strata"	474
Mann's "Catechism of Chemistry"	474
Hutchinson's "Summer Holidays in Brittany"	475
LETTERS TO THE EDITOR:—	
Colour of Flowers Grown in the Dark.—H. C. SOBRY, F.R.S.	475
The Ash Seed Screw.—FRANCIS DARWIN	475
The Animal of Millepora.—Prof. P. MARTIN DUNCAN, F.R.S.	475
The Use of the Words "Weight" and "Mass."—Prof. HENRY HENNESSY	476
The Physical Constitution of Steam.—JOSEPH JOHN MURPHY	476
Coloured Solar Halos.—JOSEPH GLEDHILL	476
"The Effect of the Sun's Rotation and the Moon's Revolution on the Earth's Magnetism."—STEPHEN W. ALLEN	476
Metachromism.—WM. ACKROYD	477
Dr. Klein on the Small-pox of Sheep.—E. KLEIN	477
OUR ASTRONOMICAL COLUMN:—	
Olbers' Supposed Variable Star near 53 Virginis	477
The April Meteors	477
PROF. HUXLEY'S LECTURES ON THE EVIDENCE AS TO THE ORIGIN OF EXISTING VERTEBRATE ANIMALS, IV.	477
ON SAFETY MATCHES. By C. TOMLINSON, F.R.S.	479
NOTES FROM SIBERIA. By Prof. GEORGE FORBES	479
THE DUBLIN SOCIETIES	479
GERMANY AND THE LOAN EXHIBITION	479
ON A MODIFIED CARDIOGRAPH ( <i>With Illustration</i> ).	479
PHYSICAL SCIENCE IN SCHOOLS. By JAMES M. WILSON.	479
NOTES	479
EXPERIMENTAL RESEARCHES ON THE EFFECTS OF ELECTRICAL INDUCTION, FOR THE PURPOSE OF RECTIFYING THE THEORY COMMONLY ADOPTED, II. By Prof. VOLPICELLI	475
SCIENTIFIC SERIALS	477
SOCIETIES AND ACADEMIES	478



THURSDAY, APRIL 20, 1876

## CAMPBELL'S "CIRCULAR NOTES"

*My Circular Notes.* Extracts from Journals, Letters sent home, Geological and other Notes, written while Travelling Westwards round the World, from July 6, 1874, to July 6, 1875. By J. F. Campbell, Author of "Frost and Fire." 2 vols. (London: Macmillan and Co., 1876.)

ALL who are acquainted with the undoubted merits of Mr. Campbell's earlier work—merits to which not even the most serious and glaring defects in style, matter, and arrangement can render us insensible—will hail with pleasure the appearance of this latest production of his ever lively pen and amusing pencil. We cannot but think that in this, his second venture, the author has greatly profited by some of the severe but not unfriendly criticisms which were elicited by the publication of his first work. Mr. Campbell has, in "My Circular Notes," avoided the grave mistake of mingling together in wild confusion humorously-written notes of travel and sober arguments on difficult scientific questions; and he has exercised, as we think, a very wise discretion in relegating to an appendix the discussion of that important geological problem, the hope of solving which seems to have been his main incitement to undertaking this journey round the world. In perusing this scientific portion of his book, with which of course the readers of *NATURE* are principally concerned, we are happy to find far fewer examples of that looseness and inaccuracy of language and to miss that dogmatic tone and redundancy of illustration which were the conspicuous blemishes of the author's earlier work. And all these improvements have we think been effected, without any sacrifice of his really graphic and vigorous style of writing upon scientific questions.

Before proceeding to notice the purely scientific portion of "My Circular Notes," we must remark that, even those who care nothing about the geological problems discussed in it, will find very much to interest them in this most lively and amusing record of travels. Those who would realise the curious scenes which may be witnessed in the Western States of North America, where the most volatile elements of old nationalities are uniting to form a new community—those who take interest in that wonderful social experiment which is now being tried in Japan, no less a one than the transplanting, bodily, of the full-grown civilisation of the West among the most conservative races of the East—and those who desire to learn something of the relics of the ancient nations, languages, folk-lore, and creeds of Ceylon—cannot do better than accept the guidance of Mr. Campbell. In him they will find a most vivacious and ever-amusing companion. Yet, on the other hand, his digressions upon such subjects as emigration and the struggle of races, and his treatment of questions like the relationships of languages and the origin of myths, will sufficiently prove that he has thought earnestly upon many social and philological problems, and has aimed at something higher than merely writing a diverting book of travel.

In adopting the method of loosely stringing together extracts from his journal with private letters, and making

no attempt to weld them into a consecutive narrative, our author certainly trespasses somewhat upon the indulgence of his readers. This disadvantage is perhaps in some degree compensated for, however, by the freshness and vigour of his descriptions and reflections, appearing as they do, just as at first dashed off in the presence of the strange scenes which inspired them.

The problem on which the author of this work has sought to throw light in making this journey round the world is one of considerable interest to geologists at the present time. In 1840 Agassiz brought forward evidence which soon convinced even the most sceptical that, not only did the glaciers of the Alps at one time extend far beyond their present limits, but that many districts—such as parts of our own islands, for example—which are now entirely devoid of glaciers, must once have been subjected to the powerful erosive action of moving ice. The idea was at once taken up by Buckland, Lyell, and other observers in this country, who showed that the new "Glacial theory" afforded a complete solution of what had hitherto constituted some of the most difficult and perplexing problems of geology.

By some later authors, however, the "Glacial theory," which had soon met with all but universal acceptance, was pushed far beyond those limits which geological observation warranted. It was asserted that, not only did the existing rock-surfaces of the more northern regions of the earth owe some of their later touches to the erosive action of glaciers, but that many even of the grandest valleys and the deepest lakes were entirely scooped out by their agency. Some even went farther than this, and declared that the whole region around either of the poles must at one period have been enveloped by continuous sheets of solid ice ("ice-caps") which extended far into temperate and even tropical latitudes. They maintained, in opposition to the arguments of Lyell, that no changes in the distribution of land and water on the earth's surface could possibly account for the former extension of glaciers, and they invoked the aid of some astronomical cause to account for the alleged phenomena. A few waxed even bolder than this, and insisted that they had found evidence, which warranted them in believing in the regular recurrence, during past geological time, of alternating mild and glacial periods; and several rival astronomical theories were even suggested to account for these supposed rhythmical changes in climate.

Among the foremost of the champions of these extreme views appeared the author of the present volumes. In 1873, he read before the Geological Society a paper in which he attributed the production of the whole valley system of Ireland to the erosive action of a polar ice-sheet. The remarks elicited from several geologists during the discussion of this paper appear to have induced Mr. Campbell, who, during his travels in Scotland, Norway, Iceland, North America, &c., had acquired great skill in recognising the peculiar marks produced by glacial action, to extend the limits of his observations by a journey right round the continent of Europe. What he then saw led him so far to distrust his former conclusions concerning the existence of a universal glacial period and a polar ice-sheet, that he determined to put the question to the severest test possible, by a complete tour of the globe.

Mr. Campbell's mode of arguing this question is as



follows :—At the present time glaciers enter the sea, within the northern hemisphere, down to the latitude of 60°; the sea is frozen and ice-marks are produced on the shore as far south as 40°; and icebergs drop their rocky burdens within 37° degrees of the equator. If there ever prevailed a universal glacial period with a general reduction in the temperature of the whole northern hemisphere, we ought to find traces of glacial action everywhere round the whole globe and extending even to more southern latitudes than 37°. If the ice-cap “ever existed, the marks of it ought to be found on all meridians alike. If ever there was a glacial period in our world, glacial marks ought to be found everywhere, in the same latitudes and at the same levels, in the same state of preservation.”

Keeping these premises constantly before his mind, our author found, during his journey of eleven months, quite sufficient evidence to cause him to make a full retraction of his former conclusions on the subject. As far as Chicago he observed everywhere the most striking traces of former glacial action; but in the same latitudes to the westward he found these marks of old glaciers entirely disappearing; and although some signs of glacial action were detected in the Rocky Mountains themselves, yet from this great range onwards to Ceylon they were found to be wholly wanting. Mr. Campbell's previous expedition in eastern Europe had led him to conclusions as to the *local* character of glacial action which were quite in harmony with those obtained in this journey round the globe, and he enunciates the results of his latest observations upon the subject as follows:—“Whether I take marks which can be explained by glacial erosion, such as firths, valleys, lakes, &c., or marks which clearly are not glacial, such as peaks and canons, I find nothing to suggest a general glacial period in America or in Europe;” and he further proceeds to state that he can find no evidence whatever of a recurrence of universal glacial periods such as might result from the action of some astronomical cause.

We have already extended this notice of Mr. Campbell's valuable work to the farthest limits, and must refer to the book itself for the details of the evidence on which his conclusions are founded.

In bringing our remarks to a close, we may add that the author's present views on the influence produced on climate by the changes of level in different districts, resulting in alterations in the direction of ocean currents, &c., appear to be quite in harmony with those so long and firmly maintained by Lyell, in opposition to the cosmical theories of the extreme glacialists. His observations on Western North America are fully confirmed by the more detailed examination of the districts by several of the United States' geologists; and his conclusion that there is no evidence of the former existence of a general “Glacial period” are quite in accordance with those enunciated by Dr. Hector and other observers who have studied the glaciers of the southern hemisphere. Prof. Nordenskjöld has, moreover, shown how completely palæontological evidence of the clearest character disposes of the notion of frequently recurring glacial epochs in past geological times.

We cannot but admire the candour with which Mr. Campbell renounces his previously-expressed opinions; and we may, perhaps, be allowed to express a hope that

the facts and arguments which have led him to so greatly modify his views on glacial phenomena, will not be without effect on the minds of others, who, like him, have certainly pushed their conclusions derived from a study of very limited portions of the earth's surface, to generalisations far beyond what those observations can be legitimately made to support.

J. W. J.

#### SCLATER'S “GEOGRAPHICAL ZOOLOGY”

*On the Present State of our Knowledge of Geographical Zoology.* By P. L. Sclater, M.A., F.R.S. Being the Presidential Address delivered to the Biological Section of the British Association. (London, Printed by Taylor and Francis: 1875.)

WE have received a copy of Mr. Sclater's address as President of the Biological Section of the British Association, at its meeting last year, at Bristol. At the time when it was delivered we had the opportunity of presenting it in full to our readers (*vide* NATURE, vol. xii. p. 374, *et. seq.*). In the independent form now under notice it has added to it a most important appendix, namely, a list of all the works and memoirs referred to in its various sections. When we say that these are more than 420 in number, a fair estimate may be formed of the labour which must have been involved in their collection and classification. Exact references are a most valuable aid to biological research, and prevent the waste of much time during special investigations, and on the subject of the geographical distribution of vertebrated animals, this address of Mr. Sclater supplies all that can be wanted by anyone either reviewing the subject as a whole, or desiring to obtain the best information on the zoology of any special locality.

The arrangement adopted is regional, the basis being the universally accepted divisions proposed by Mr. Sclater himself. They are thus tabulated:—

I.—Palæarctic Region . . .	} <i>Arctogaea.</i>
II.—Ethiopian Region . . .	
IIa.—Lemurian Sub-region . . .	
III.—Indian Region . . .	} <i>Dendrogeaea.</i>
IV.—Nearctic Region . . .	
V.—Neotropical Region . . .	} <i>Antarctogaea.</i>
Va.—Antillean Region . . .	
VI.—Australian Region . . .	
VII.—Pacific Region . . .	} <i>Ornithogaea.</i>

Each of these regions is divided into sub-regions, which are described separately. Perhaps no better idea can be formed of the extent to which the greater divisions of the globe have been studied, than by a comparison of the number of works and memoirs which have appeared with reference to each, or to parts of each. As might be premised, there has been much written on the animals of the Palæarctic region, considering that it includes Europe, together with North Africa, Siberia, and North China. There are 119 references with regard to it, the most recent including Prof. Lilljeborg's work on the Mammals of Sweden and Norway, Mr. Dresser's “Birds of Europe,” Mr. J. Hancock's “Birds of Northumberland and Durham,” Dr. Schreiber's “Herpetologia Europaea,” the German translation of Dr. N. Severzow's work on the Birds of Turkestan, the late Dr. Stoliczka's “Avifauna of Kashgar in Winter,” Lieut.-Colonel Irby's “Ornithology of the Straits of Gibraltar,” and the new edition of Bell's “British Quadrupeds.”



ith respect to the Ethiopian region—the field-work of Andrew Smith, Livingstone, and Du Chaillu—46 are tioned, and 40 on the Indian region, which has been much investigated by those who, from other reasons, e had to take up their residence in our Eastern empire. re are 25 works referred to respecting the Nearctic ion, and as many as 138 on the Neotropical, which onstrates how rich a field South America has proved the students of biology, it being remembered that Mr. rwin himself obtained the bulk of his practical experie- ce of animal life in that continent. Forty-one works e the Australian and nine on the Pacific region include e remainder of the list. Mr. Sharpe's edition of Layard's Birds of South Africa," Mr. Hume's "Stray Feathers," ord Walden's Memoirs on the Birds of Celebes and the hilippines, Mr. Scammon's "Marine Mammals of the orth-Western Coast of North America," Messrs. Baird, ewer, and Ridgway's "History of North American irds," Dr. E. Coues' "Birds of the North-West," Prof. . R. Jones' "Manual of the Natural History, Geology, and Physics of Greenland," Messrs. Sclater and Salvin's "Nomenclator Avium Neotropicalium," Mr. A. W. Scott's "Elementary Treatise on the Mammals of New South Wales," the late Mr. J. Brenchley's "Cruise of the *Curaçoa*," Dr. Buller's "Birds of New Zealand," being the most important works which have appeared during the last two or three years, on the regions other than the Palearctic, above referred to.

That several works have appeared since Mr. Sclater's address was delivered—including, among the most important, the late Mr. Blyth's "Catalogue of the Mammals and Birds of Burmah," edited by Dr. J. Anderson, Dr. Dobson, Lord Walden, and Mr. Grote, a special notice of which we hope very shortly to give—and that Mr. Wallace's important two volumes on the "Geographical Distribution of Animals" may be expected very soon, shows how much stress is now being laid on the fauna of different regions, and adds further to the importance and value of the encyclopædic address, the contents of which we have brought before the notice of our readers on the present occasion.

OUR BOOK SHELF

*An Elementary Treatise on Curve Tracing.* By Percival Frost, M.A. (London : Macmillan and Co., 1872.)

*On the Transcendental Curve whose Equation is—*

$$\sin y \sin my = a \sin x \sin nx + b.$$

By H. A. Newton and A. W. Phillips. (From the *Transactions of the Connecticut Academy*, vol. iii., 1875.)

MR. FROST'S work is an elementary one, inasmuch as no advanced acquaintance with the differential and integral calculus is required; nor do his methods turn upon the higher algebra, nor upon the science of projections. Indeed he is careful to restrict himself for the most part to fairly elementary processes. It is not a complete treatise, as he does not touch upon roulettes or upon curves, given by intrinsic equations. These latter curves have been, as is well known, discussed and fully illustrated in the late Dr. Whewell's two memoirs in the *Cambridge Philosophical Transactions* (vols. viii. and ix.) We miss, too, all account of curves of historical interest. Occasional notices of these have been given by different writers, but we should like a sketch of them drawn up by some competent hand, with an account of their origin and applications.

Reasons have weighed with Mr. Frost in making these omissions, and we do not grumble at his taking his own line in his treatment of the subject as he has given us a full treatise, abundantly illustrated by figures, of curves, ranging from simplicity to considerable complexity of form. The preface is an interesting one (though by the way, the author was rather unwilling to write it), and in it attention is called to the fact, among other reasons, why junior students should devote some little time to curve-tracing, that the subject of graphical calculation is coming more into use, being applied to problems in statics (see Culmann's "Graphische Statik"), engineering, and crystallography.

We cannot here give any detailed sketch of the contents of the work, further than to draw attention to the last chapter, which treats of the inverse problem, viz., given the form of a curve to investigate its equation, or an approximation to it. We do not remember to have seen the attempt made elsewhere. Should the subject be taken up and carried on with success, we may look for the equation to one's name taking the place of the name on an address card.

The majority of the curves discussed and traced in Mr. Frost's book are algebraical ones.

Messrs. Newton and Phillips write that from the form of a transcendental curve it is not easy to state the equation that will represent it. So instead of taking up the inverse problem, they have selected from out of the host of transcendental equations, and exhibit twenty-four pages of plates of the plane curves furnished by assigning different values to the constant quantities *a*, *b*, *m*, and *n* in the equation given above.

These forms, as might be imagined, are all symmetrical, and much resemble carpet patterns. The tract is an interesting evidence of the patience and skill at draughtsmanship of the authors.

*Kurzes Chemisches Handwörterbuch zum Gebrauche für Chemiker, Techniker, Aerzte, Pharmaceuten, Landwirthe, Lehrer, und für Freunde der Naturwissenschaft überhaupt.* Bearbeitet von Dr. Otto Dammer. (Berlin : Robert Oppenheim, 1876.)

To keep pace with the rapid growth of chemical science would be almost a hopeless task, were it not for the literary organisation and classification undertaken from time to time by such writers as the author of Watts's "Dictionary of Chemistry," and Dr. Dammer, the compiler of the present volume. To writers of this class who take upon themselves the laborious drudgery of "stock-taking," workers in the ranks of science owe a debt of gratitude which cannot be too highly estimated.

In coupling together the names of Mr. Watts and Dr. Dammer, it is by no means our intention to imply any similarity between the respective "dictionaries." Dr. Dammer's work is perhaps more truly a dictionary in the proper signification of the term than Mr. Watts's seven volumes, for while the latter contain full, and in many cases, exhaustive information on the various subjects treated of, the whole of the former is comprised in one volume royal octavo, of some eight hundred pages. The justly esteemed "dictionary" of English chemists need fear, therefore, no rival in the present volume, the two works rather bearing to each other the relationship of a chemical encyclopædia to a glossary of chemical terms.

The longest articles in the present volume are those on absorption, equivalents, alum, ammonia, aniline, aromatic bodies, ashes, animal respiration, atmosphere, atom, base, benzoic acid, benzene, succinic acid, beer, blood, soils, bread, chemistry, chromic acid, steam, diffusion, albumin, electricity, petroleum, nutrition of plants and of animals, acetic acid, acetates, colouring matters, fats, flesh, galvanic batteries, gases, tan, glass, coal, hydrocarbons, madder, crystal, copper, illuminating gas, solution, magnetism, metals, metalloids, microscope,



milk, mortar, nickel, photography, analysis (qualitative and quantitative), nitric acid, nitrates, salts, oxygen, gunpowder, sulphur, sulphuric acid, silver, specific gravity, thermometer, porcelain, hyposulphites, water, wine, tartrates, tungstates, sugar, &c. The following subjects are treated of in some detail:—Alcoholometry, aniline dyes, areometer, iron, carbonates, light, mineral waters, common salt, sulphates, heat.

The value of the dictionary as a work of reference is decidedly enhanced by the adoption of thick type for the words heading the articles. In the case of recently discovered compounds we are of opinion that a short bibliographical reference to the paper wherein such compounds are first made known would have greatly increased the value of the articles without materially adding to their length. The author has fallen into an error in treating of thermo- and pyro-electricity under the same heading; the former term is employed by electricians in this country to denote the electricity developed by heat in *conductors*, the latter to denote the electricity produced by heat in *non-conductors*.

Bearing in mind the enormous range of subjects now embraced by the science of chemistry, for a volume of the present size the amount of information conveyed is really very great. With the exception above pointed out, the articles, though necessarily brief, are to be depended on for accuracy, and we can safely recommend Dr. Dammer's dictionary as a useful work of reference.

R. M.

*Clouds in the East. Travels and Adventures on the Perso-Turkoman Frontier.* By Valentine Baker. With Maps and Illustrations. (London: Chatto and Windus, 1876.)

THE author of this interesting volume had special facilities for visiting the Russian outposts in Asia and the Persian frontier; he had powerful recommendations to the highest Russian and Persian authorities. By various causes, however, he was prevented from taking complete advantage of these, so that the main part of his work describes his journeys in the district to the south of the Caspian, and from Teheran towards the north-east Persian frontier. He reached the Caspian by Trebizond and Tiflis, and gives some interesting particulars as to navigation on the inland sea. He was able to visit the mouth of the much-talked-of Attrek, and found that the Gurgan, to the south of the Attrek, is the real Russian frontier in this region. He was unfortunately prevented from visiting Merv and Herat, which he had intended to do. Mr. Baker's main objects were sport and to ascertain the real nature of the advances made by Russia in Central Asia. Of the former he got a fair amount around Teheran, and his work will be of very considerable importance to those who are interested in the movements of Russia. He took considerable pains to ascertain Persian feeling on the question; Persia cannot understand, or rather misunderstands, England's inaction. Mr. Baker gives many valuable notes as to the nature of the country passed over, its productions, antiquities, and inhabitants. Concerning the Turkomans especially, and their wonderful houses, many details will be found. Altogether the work is an intelligent and interesting narrative of travel in an important region, and a substantial contribution to the Asian question. There are three good maps, but the chromolithographs are very poor specimens of their kind.

#### LETTERS TO THE EDITOR

*The Editor does not hold himself responsible for opinions expressed by his correspondents. Neither can he undertake to return, or to correspond with the writers of, rejected manuscripts. No notice is taken of anonymous communications.*

#### The Use of the Words "Weight" and "Mass"

I WILL supplement Mr. Bottomley's authorities for the meaning of *gravity* by others which will be perhaps considered

more relevant. Maupertuis, "Figure de la Terre," Paris, 1738, writes:—"Il faut bien distinguer ici la pesanteur d'un corps d'avec son poids . . . La pesanteur dans un grand corps, n'est pas plus grande que dans un petit. Il n'en est pas ainsi du poids; il dépend non-seulement de la pesanteur, mais encore de la masse des corps . . . il est le produit de la pesanteur par la masse" (p. 155). Subsequently, he lays down the distinction between *pesanteur* and *gravité* which Clairaut adopted; but universally the English *gravity* has been used as synonymous with the French *pesanteur*. Airy, "Gravitation," p. 3: "To take the ordinary force of gravity for an instance, we might measure it by the pressure which is produced on the hand . . . or by the number of inches through which the lump of lead would fall in a second of time . . . But there is this difference between the two measures; if we adopted the first . . . we should find a different measure by the use of every different piece of lead; whereas if we adopt the second . . . we shall get the same measure for gravity whatever body we suppose subject to its influence." Here the broad distinction between "weight" and "gravity" is clearly laid down; the one is the "impressed force" on the falling body, the other its "accelerative effect" (Thomson and Tait, "Treatise on Nat. Phil.," 217-219), or the more familiar "moving force" and "accelerating force." In the "Treatise" the former is called the "force of gravity on the mass of a body," 220; but "gravity" alone seems clearly enough defined as acceleration, by the words "According to this formula, therefore, polar gravity will be

$$g = 32'088 \times 1'005133 = 32'2527."$$

Again, § 226: "The augmentation of gravity per degree . . . is, at most . . . The average . . . differs certainly, but little from 32'2."

I think it evident that *gravity* has not been "lying ready for use, but left almost idle," as Mr. Bottomley supposes.

To the restriction on the use of weight—which I feebly support, but which is certainly not mine—I do not conceive that the "Act of Parliament" offers any bar; as the weights of masses are merely thereby defined in terms of the weight of the standard mass. This restricted sense is clearly recognised in such passages as the following, from Thomson and Tait's "Elements," § 366, "The measurement of force whether in terms of the weight of a stated mass in a stated locality . . ."

As to the compounds "*centivires*," &c., I advisedly adopted the Latin prefixes in their old etymological sense, so as to have wholly Latin names and thereby prevent any confusion with the C. G. S. kinetic measures. The employment in the metric system being quite conventional and contrary to analogy, I feel justified in following older precedents. J. J. WALKER

#### "The Recent Origin of Man"

IN NATURE, vol. xiii. p. 245, a writer over the initials "W. B. D." reviews in no very complimentary terms my book entitled "The Recent Origin of Man." I am charged with inconsistency, inaccuracy, incompetency, &c. When charges of this sort are made they ought not to be made lightly, and the writer making them ought to weigh his statements.

My space is necessarily brief, but I beg permission to comment on a few of the assertions made by "W. B. D." in rendering his judgment on the premises.

1. He remarks: "The statement that no traces of a rude and imperfect civilisation have been met with in the East is refuted by the discovery of enormous quantities of flint implements in Egypt and of neolithic axes in Asia Minor and in India. In the river gravels of both these regions paleolithic *haches* have been found of the same type as those of Amiens and Abbeville."

We all know that paleolithic implements have been found in the river-gravels of India; I refer to this on p. 31 of my book; but I am not aware that paleolithic implements have been found in the river-gravels of Egypt or Asia Minor. As "W. B. D." asserts it, I beg leave to ask for the particulars.

As for the occurrence of flint implements in Egypt, I remark on p. 478: "Flint implements have been found in Egypt but they belong to the Neolithic age, and occur on the surface, or near the surface, or in the tombs." I mention that one implement of paleolithic type had been found. I show that flint arrow heads and flint knives have been frequently found in the Egyptian tombs by the side of the mummies.

That Sir John Lubbock found in the Nile valley a few implements resembling the paleolithic types I am aware; but implements of paleolithic type were found at Cissbury by Col. A.



ice-Fox. No flint implements have been found in Egypt in connection with an extinct fauna, or in beds corresponding in general position to the implement-bearing gravels of the Somme.

"W. B. D." asserts that in every one of the cases cited by me (I cite one or two hundred) to prove "the ages" simultaneous, "there is no proof that the deposit has not been disturbed."

I select by way of reply five examples: the pile-village at Unter Uhldingen (Switzerland); the skeletons found at Cumalà, in Italy; the trenches at Alise; the pile-village near Lubaw, in Pomerania; and the relic-beds at Hissarlik.

3. Solutré is a crucial case. Referring to this, "W. B. D." proposes of it by remarking that a Merovingian cemetery was located here on a palæolithic station, "as he was informed by Dr. Broca at the French Association at Lyons in 1873." "In this case," he proceeds, "which is made the basis of the attack on the high antiquity of palæolithic men, the human skulls are comparatively modern, and the refuse heap of an untold age."

This statement implies both ignorance and a treacherous memory on the part of "W. B. D."

We are all aware that there are Merovingian remains at Solutré. There are also Roman or Gallo-Roman remains. But the argument from Solutré is this: (1) That the bones of the extinct animals found in association with the flint implements have preserved a portion of their gelatine, and that the horns of the reindeer, when cut, yield the odour of fresh horn. (2) That the flint implements found, though unpolished, are of very superior and advanced workmanship, hardly inferior to the beautiful specimens from Denmark. (3) That there are found here the remains of some 40,000 horses, and that the horse was probably domesticated. (4) That there are numerous instruments here of palæolithic date, some of them in carefully closed stone cists or boxes. The remark of "W. B. D." about the Merovingian graves has therefore no application except in connection with (3) and (4); as regards (3), the *horse-deposit*, as it is called (outside of the refuse-heaps), some of which was compacted into a solidified mass—contained the flint implements and the bones of the mammoth, reindeer, &c.; and, in addition, extended beneath the most ancient fire-places, or hearths, containing the palæolithic skeletons and the flints and the bones of the reindeer and mammoth. The horse-remains are not, therefore, Merovingian. As regards (4), and the assertion, on the authority of Dr. Broca, that the graves are Merovingian; this whole subject came up at the French Association at Lyons in 1873; the Association visited Solutré; and by way of reply to what "W. B. D." says he gathered from Dr. Broca, I quote from the report of the Proceedings of the Association in "Matériaux pour l'Histoire de l'Homme," 7<sup>e</sup>, 8<sup>e</sup>, and 9<sup>e</sup> Livraisons, 1873, pp. 324, 325, 342. When M. Cartailhac observed that "the discussion was of the greatest gravity, and would remain celebrated in the history of anthropological science," and that although there may have been some disturbances of the soil, "one thing remained certain, viz., that in more than ten instances, a human skeleton had been found on a quaternary fire-place, and not one fact exists to be opposed to the admission of their contemporaneity"—when M. Cartailhac had expressed himself to this effect, the report proceeds:—

"M. Broca partage cette opinion et déclare ouverte la discussion sur le deuxième problème: *les chevaux*."

Subsequently, participating further in the discussion (p. 342), M. Broca stated that he had examined twenty-five skulls from Solutré, and that of this number seventeen belonged to the epoch of the reindeer—"à la véritable époque paléolithique solutréenne."

I leave "W. B. D." to reconcile these declarations of Dr. Broca made in the public meeting with the private declarations made to him. "W. B. D." closes with the remark that "he has not been able to find [in the book] a single shred of proof of the recent origin of man."

I show that the lake-dwellings in France come down to the eighth century of our era; in Pomerania and Sweden to the eleventh century. I show that great changes of level have occurred in different parts of the earth within a comparatively recent period, as at Uddenalla and Södotalje in Sweden, and in the island of Moen.

I show that in America the remains of the mastodon and mammoth occur in the most superficial deposits—the food sometimes preserved in the stomach; I refer to the preservation of the Mammoth in Siberia; I show that the reindeer and Great Irish Elk lived in Europe down to the Middle Ages; that the

Cave-bear survived to Neolithic times, &c. I show that the hippopotamus is figured in the Trojan bed at Hissarlik; that the lion was found in Europe three centuries before our era; that the rhinoceros is found in the neolithic caverns of Gibraltar; that the elephant was brought to Shalmaneser II. by the *Musri* in the eighth century B.C. I might have added that *the elephant lived in Mauritania (near the Straits of Gibraltar) in the time of Herodotus and Pliny*.

I point out that, owing to the continuance of the ice-sheet, palæolithic man never penetrated into Scotland or Denmark; but that the human period there commences with the Neolithic age, which, interpreted, means that *the Glacial epoch in that region lasted down to the date of the older lake-dwellings*.<sup>1</sup>

JAMES C. SOUTHWALL

Richmond, Virginia, U.S., March 20

"The Unseen Universe"

IN Art. 213 the distinguished authors of "The Unseen Universe" say: "We have already shown (Art. 164) that development without life, that is dead development, does not tend to produce uniformity of structure in the products which it gives rise to."

In the article referred to they say: "There is one peculiarity of the process of development now described which we beg our readers to note. We have supposed the visible universe, after its production, to have been left to its own laws, that is to say, to certain inorganic agencies, which we call forces, in virtue of which its development took place. At the very first there may have been only one kind of primordial atom; or, to use another expression, perfect simplicity of material."

"As, however, the various atoms approached each other in virtue of the forces with which they were endowed, other and more complicated structures took the place of the perfectly simple primordial stuff. Various molecules were produced at various temperatures, and these ultimately came together to produce globes or worlds, some of them comparatively small, others very large. Thus the progress is from the regular to the irregular." Is not this a *non sequiter*? "And we find a similar progress when we consider the inorganic development of our own world. The action of water rounds pebbles, but it rounds them irregularly; it produces soil, but the soil is irregular in the size of its grains, and variable in constitution. Wherever what may be termed the brute forces of nature are left to themselves, this is always the result; not so, however, where organisms are concerned in the development."

"Two living things in the same family are more like each other than two grains of sand or two particles of soil. The eggs of birds of the same family, the similar feathers of similar birds, the ants from the same ant-hill, have all a very strong likeness to each other." It seems to me that the argument here tends to show that the planetary or world development, and what the authors term living development, are based on the same primordial law. If development without life does not tend to produce uniformity of structure in the products it gives rise to, and development with life does tend to the opposite result it would logically follow that the worlds with which we are acquainted are the result of living development.

No two living things of the same family are more alike than are the planets of our solar system; alike in form, alike in their motions, and alike in the material of which they are made; and if the doctrine of their growth, maturity, and final dissolution, which the nebular hypothesis ascribes to them, be a verity, then alike in these respects to living development on the earth. I have long been of the opinion that the same principle underlies all development from the smallest microscopic insect to the largest world in the universe, and I am gratified to find two such profound philosophers as Professors Stewart and Tait virtually advancing the same theory. It may, however, be said that they do not admit this sequence. They suppose the visible universe, after its production, to have been left to its own laws, to certain inorganic agencies or forces in virtue of which its developments took place, that at first there may have been only one kind of primordial atom from which all present development has arisen. This is mere speculation; but admitting its verity, it does not alter the truths enunciated by them that dead development does not tend to produce similarity of structure, that the results of the brute forces of nature left to themselves are accidental forms, and that where there is uniformity of structure there is living development.

<sup>1</sup> Certainly not 10,000 years ago; in my opinion not 3,500.

In a careful examination, however, of the whole argument of the authors of the "Unseen Universe," it looks to me as though they saw clearly to what their course of reasoning, as far as this particular point is concerned, tended, but were willing to stop short of the true logical result, believing that humanity was not yet prepared to admit that we are only a small part of one stupendous whole, a universe of individual life.

Of the main object and scope of their argument I have nothing to say, only this: if the premises assumed—and they are the assumptions of the modern school of science—are correct, there is nothing unreasonable in the conclusions at which the authors have arrived.

NOTE.—Since writing the above I have seen the authors' preface to the second edition of the "Unseen Universe," in which they say: "To reduce matters to order, we may confidently assert that the only reasonable and defensive alternative to our hypothesis (or, at least, something similar to it) is the stupendous pair of assumptions that visible matter is eternal, and that IT IS ALIVE. If anyone can be found to uphold notions like these (from a scientific point of view), we shall be happy to enter the lists with him." If the distinguished authors will confine themselves to this proposition, that "All visible aggregations of matter, such as our earth and its congeners, are living organisations, in other words, ARE ALIVE," I think the affirmative can be successfully maintained.

Whether matter is eternal and each individual particle or atom of matter is alive, is too far in the interior of the unknowable to be discussed with any possibility of successful results, and, too, the idea of an atom being a living organisation is directly opposed to the whole theory of atomicity, and scientifically ludicrous in view of that theory.

JOSIAH EMERY

City of Williamsport, Pa., U.S., March 10

#### Prof. Tait on the Earth's Age

IT is well known that Sir W. Thomson has concluded, from different lines of argument, that the age of the earth, as a body cool enough for habitation, cannot be much greater than a hundred million years.

Prof. Tait, in his "Recent Advances in Physical Science," recapitulates these arguments, but with a different conclusion. He states the limit of age to be about *ten* million years.

As the subject is of immense interest, may I ask Prof. Tait to explain this change of conclusion?

J. D. EVERETT

#### A Relapsed Donkey

SOME years ago on one of the Lucknow roads I met a "Dhobi" (washerman) with some donkeys. I send you a picture of one of them, made by a native artist. It shows, I think, the relationship between the zebra and the donkey better than many which I have seen. Mules and horses often show zebra marks on their legs, but I have never before or since seen the marks so well displayed on the trunk and legs as in this donkey. The stripes on the body are blended together at their base, and so are the stripes on the legs blended into bands. At the time I endeavoured to find out whether in the days of the kings of Oudh there had been any zebra in Lucknow which might have bred with donkeys, but could find nothing about it. Had there been a zebra which bred with donkeys, I think there would have been more of these striped animals; but this is the only one I have seen since 1858. I think it a case of simple *atavism*. Perhaps you may think it worthy of a record in NATURE. All "Dhobis" donkeys are small, wretched creatures, mostly with crooked legs.

E. BONAVIA

Lucknow, Feb. 29

#### OUR ASTRONOMICAL COLUMN

VARIABLE STARS.—Mr. J. E. Gore, M.R.I.A., of Umballa, Punjab, calls attention to a star of the sixth magnitude entered in Harding's Atlas, between  $\epsilon$  Leporis and B.A.C. 1553, and which is underlined. Mr. Gore says: "In February of this year, with a 3-inch refractor, I found Harding's 6 m. star a little brighter than the 9 m. star south of it, but less than several 8 m. stars (Harding) following. It has a small companion  $f$  at about  $1' \pm$ . Harding's 9 m. stars seem about 10 m." Reading off from the Atlas the position of the sixth magnitude for 1800

appears to have been about R.A.  $73^{\circ} 35'$ ,  $111^{\circ} 25'$ , whence for 1876<sup>o</sup> we have R.A.  $4^{\text{h}} 52^{\text{m}}$ , N.P.D.  $111^{\circ} 18'$ . This star does not occur in Arg. Zones, nor in the Washington Zones in the various observations for 1870 and 1871.

Gilliss has this note to No. 543 of his Catalogue of 1248 stars for 1840 (B.A.C. 3815): "Probably very short intervals. Of the seven observations estimations make it 6th magnitude, three 5th, and other 5.6." This star, which was observed by Flaxman, Bradley, Piazz, and Taylor, was also observed by Lande on three nights, viz., 1850, March 15, 1851, 22 and 28, the magnitudes being noted on these occasions 5, 7, 6 respectively. It appears not unlikely that this star is examined at short intervals Gilliss's suspected variability will be confirmed. It is situated in Hydra (1876), 11h. 2m. 45s., N.P.D.  $117^{\circ} 25'$ .

As perhaps connected with the subject of variable stars we may refer to a remark by Piazz, applying to No. XVI. 35. He says: "Fortiter micans, intereademque tranquilla luce splendescit." No. 35 is called 8 m. the star following  $15^{\circ}$ , and south  $18^{\circ}$ , which does exhibit the strong scintillation of its neighbours. Both stars occur in the Washington Zone, 1847, magnitudes 7.8 and 6.7. Also to the remark of Lalande to the star of 8.9 mag. observed on the middle of the star following  $15^{\circ}$ , and south  $18^{\circ}$ , "Beaucoup de scintillation" ("Histoire Céleste," p. 242); this star is 40102 Cygnus, of the reduced catalogue, R.A. 20h. 39m. 23s. N.P.D.  $58^{\circ} 45' 2$ . Several of the stars are well known to exhibit striking scintillations at times, and perhaps more especially when on the point of diminution; this has been particularly the case of  $\gamma$  Virginis (Hind, 1851), in which reddish-yellow stars of a deeper red are occasionally present, producing an impression of unusual scintillation.

The star Lalande 34746 Aquila is of a deep red colour. Its position is erroneously given in the catalogue from the observation 1796, June 25; the N.P.D. should be  $96^{\circ} 43' 28'' 7$ . It does not occur in the *Zones* of Bessel or Santini. Lalande calls it 7 m., and it is of the same magnitude in the charts of Capocci and Flammarion. In September, 1873, it was 7.8, so that at present a claim to be included in the list of variables is not made out; still as so large a proportion of the bright coloured stars do prove to be variable, L. 34746 may be worth watching. Position for 1876<sup>o</sup>. R.A., 18h. 38m. N.P.D.,  $96^{\circ} 39' 5$ .

Several of the variable stars to which attention has been called in this column during the last twelve months are now in favourable positions for observation.

THE SEARCH FOR COMETS.—No new telescopic comets has been detected since that found by M. Borrelly at Marseilles early in December 1874, an interval of more than sixteen months. Perhaps we may attribute this circumstance partly to the very unfavourable weather which has prevailed generally during the last year, but it is pretty certain that if a systematic search for these bodies with suitable instruments, could be instituted by amateurs of the southern hemisphere, cometary astronomy would be greatly the gainer. Such work is not adapted to the routine of the public observatories, nor can they afford in the actual state of what may be termed the *standard* astronomy of the other hemisphere, to devote time to it, but it is an occupation especially within the province of the amateur. If his instrumental means are not equal to the determination of accurate positions, he may content himself with intimating any discovery to the astronomer in charge of the public establishments who, after receiving indication of the approximate position of any new comet, will no doubt secure observations sufficient for the calculation of the orbit. In this way it is highly probable that the number of known comets of short period may be materially increased, since it is only at certain returns







isolated teeth. In the early Miocene a very interesting form occurs, named *Amphicyon*, characterised by the greater development of the tubercular molars, which are not only larger relatively than in modern dogs, but the one missing in them is present, making the typical number complete. In addition to this generalisation in the dental characters, they possessed five toes on each foot, whereas the modern dogs have lost the hallux. They were large heavy-limbed animals, and have been supposed to present affinities to the bears, which, however, they only do inasmuch as they are more generalised carnivora than are the typical dogs. Remains have been found in various Miocene deposits in France, Germany, Italy, and some assigned to the same genus in North America. It is doubtful if the cynoid or dog-like type of carnivore was distinctly recognisable in the Eocene period, for the *Canis parisiensis* of the Paris gypsums was founded on a single tooth.

From the dogs, which hold a very central position in the order, the other existing members deviate in two different directions, one extending through the weasels and martens to the otters and bears, which make the nearest approach to the seals, and the other through the civets and hyænas to the cats, the most highly specialised and characteristic carnivores. The true bears are especially distinguished by the great development of the tubercular and the suppression of the sectorial portion of the molar series. The peculiar dentition of a bear is, for a carnivorous animal, highly specialised, and, as might be expected, appears to be a comparative recent introduction upon the earth, not extending beyond the Pliocene epoch, though several transitional forms occur, as *Arctotherium bonariensis* of South America, and *Hyanarctos sivalensis* of the Siwalik Mountain, and *H. insignis* of the Pliocene of Montpellier. Otters have been traced back to the Pliocene in France, and an allied form *Potamotherium*, to the Miocene. *Enhyriodon* is a large otter-like animal from the Siwalik Hills, with very broad and tuberculated molars. The evidence as to the ancient history of the *Mustelidae* is not very satisfactory, as isolated teeth, by which many of the fossil forms are known, are not sufficient indications as to their general characters.

True *Viverridae* are met with in the European Miocenes, one genus, *Ictitherium*, forming a transition to the Hyænas. The latter first appeared in the Upper Miocenes of Europe in forms intermediate between the extremes of existing species, and continued abundant until the close of the Pleistocene, but are now restricted to Africa and Asia. The species so common in the British caves appears to have been identical with the Spotted Hyæna (*H. crocata*) of Africa, and the Striped Hyæna (*H. striata*), has been found fossil in France. The genus has not been met with in America.

The *Felidae* present the most complete adaptive modification of the carnivorous type for a predatory existence. The jaws are short and wide, the incisors very small, the canines powerful, and the molar series shortened, and its sectorial element developed almost to the complete suppression of the tubercular portion. The limbs and claws have undergone corresponding specialisations. The family has now a very wide distribution, and has existed both in Europe and America since the Miocene period. It acquired one most remarkable modification in the animals known as *Macharodus* and *Drepanodon*, in which the upper canine was developed to an extraordinary degree, projecting down from out of the mouth like huge sabre-like tusks. In other respects the animal was constructed much on the ordinary feline type. They were widely distributed both in time and space, being found in North and South America, in Europe (including Britain), and in India, and ranging from Miocene to Pleistocene epochs, when they became quite extinct.

(To be continued.)

#### UNIVERSITY COLLEGE, BRISTOL

THIS college is now being incorporated under the Board of Trade as a company limited by guarantee, under the Companies' Acts, 1862 and 1867. The Board of Governors is the supreme governing body, and comprises all contributors above 5*l.*, and a large number of honorary members, with various qualifications, resident in various parts of the West of England. The Council is the managing body, consisting of sixteen, one-half of whom are elected by the governors (in the first instance by the contributors of money, about 20,000*l.* having been already promised in Bristol alone), and the other half are nominated by the Vice-Chancellors of the Universities of Oxford, Cambridge, and London, by the two contributing Oxford Colleges, by the Lord-President of the Privy Council, by the faculty of the old-established Bristol Medical School, and by the Principal and professors of the College.

The Council comprises the following names:—

*Elected by the Contributors.*—W. P. Baker, merchant; F. N. Budd, barrister; Rev. J. W. Caldicott, Head Master, Grammar School; Lewis Fry, School Board Chairman, solicitor; Rev. F. W. Gotch, Principal, Baptist College; Rev. J. Percival, Head Master, Clifton College; G. F. Schacht, pharmacist; W. Smith, merchant.

Prof. B. Jowett, nominated by Vice-Chancellor of Oxford; Prof. Stuart, nominated by Vice-Chancellor of Cambridge; W. L. Carpenter, nominated by Vice-Chancellor of London; Prof. Henry Smith, nominated by Balliol College; Rev. H. B. George, nominated by New College; R. W. Coe, nominated by Bristol Medical School.

At their preliminary meeting, held recently, the Council decided to commence operations in October next, and to appoint at first a Professor of Chemistry and a Professor of Modern History and Literature.

A piece of land has already been secured, but, for the first session or more, the lectures will be given in temporary premises. In all except the strictly medical classes of the medical school (which is being affiliated with the New College), the instruction will be open to young people of both sexes. Other courses of occasional lectures will be organised during the session.

In addition to the aid afforded by Balliol and New Colleges, Oxford, the Worshipful Company of Clothworkers in London have spontaneously offered a very handsome subvention to the College, with the view of establishing a department of Textile Industries for the improvement of the technical education of the West of England cloth manufacturing districts, as Stroud, Trowbridge, &c. It is believed that special attention will be given to the chemistry of dyeing and wool scouring, as well as to the mechanical part of the manufacture. The details of the arrangements are under the consideration of the Council and of a committee of cloth manufacturers and others, by whom very great interest is felt in the proposed scheme.

The registered temporary office of the College is Shannon Court, Bristol, and letters sent to the Secretary of University College, Bristol, at that address, will be attended to.

The Council are seeking for a permanent secretary, and offer a salary of 200*l.* per year. They hope to obtain the services of a gentleman who will throw himself with zeal and interest into the establishment of the College.

#### THE USE OF YELLOW GLASS, FOR ZOOLOGICAL COLLECTIONS

AT a recent meeting of the Entomological Society of Belgium, M. Capronnier read a paper giving an account of some experiments which he had made bearing on the question as to how public collections of insects



best be exhibited so as to satisfy all the purposes which they are intended. M. Felix Plateau, at a meeting, proposed to substitute yellow for colour-glass in lighting rooms containing entomological collections. In the discussion which followed it was suggested that experiments should be made by submitting insects to the influence of glasses of various colours. M. Capronnier was entrusted with carrying out these experiments, and the paper referred to contains his report.

Everyone knows that among the Lepidoptera it is the red and carmine colours which are most rapidly destroyed by daylight. M. Capronnier wished to obtain sufficient quantities of *Euchelita Jacobæ*, L. The inferior wings of this insect are of a deep carmine, uniform in colour, an important point in the experiments.

The principal colours of the solar spectrum are the yellow, the red, the blue. M. Capronnier rejected the yellow as giving a tint too dark, and added the mixed colours, violet and green. He had thus four tints chosen, each of the same degree of tone, and of a moderate shade—yellow, violet, green, and blue, besides a colourless glass. He made five small square boxes of 0.8 centimetres square and one centimetre in depth; the whole surface of each was covered with one of the above-mentioned glasses.

Each wing was fixed in the middle of the box and placed in a bath of very bright light, but protected from the rays of the sun. Each of the wings was partly covered by a band of black paper, and their position was so arranged as to leave exposed successively each of the parts during a period of fifteen, thirty, and ninety days. The following are the results:—

**Colourless glass.**—After fifteen days of exposure the carmine tint was visibly attacked. After thirty days the alteration was more sensible, and after ninety days the work of destruction had rapidly advanced, and the carmine had passed into a yellowish tint.

**Blue.**—With this tint the same alterations took place as in the case of colourless glass.

**Green.**—This colour preserved the carmine during the first fifteen days; a change was indicated on the thirtieth day, and on the ninetieth the alteration was marked.

**Yellow.**—During the ninety days the yellow alone left the carmine colour almost intact. M. Capronnier says almost, for a slight alteration in the tint could be noticed at the end of the ninety days. This last observation proves that there is no absolute preservative, and that collections must be kept in darkness, under penalty of seeing them seriously changed at the end of a given time.

Nevertheless, it is evident from the above that the yellow is the best preservative against alterations in the colours of insects. M. Capronnier consequently concludes that a yellowish colour should be preferred and combined in every arrangement of an entomological room. Moreover the cloths that cover the show-cases ought to be yellow rather than green, and what is important and indispensable, the window-blinds ought to be absolutely yellow.

RADIOMETERS<sup>1</sup>

DURING the discussion which followed the reading of Prof. Reynolds's and Dr. Schuster's papers at the last meeting of the Royal Society I mentioned an experiment bearing on the observations of Dr. Schuster. I have since tried this in a form; and as the results are very decided and appear calculated to throw light on many disputed points in the theory of these obscure actions, I venture to bring a description of the experiment, and to show the apparatus at work, before the Society.

I made use of a radiometer described in a paper com-

<sup>1</sup> "On the Movement of the Glass Case of a Radiometer." By William Crookes, F.R.S., &c. Read at the Royal Society.

municated to the Society in January last. I quote the description from paragraph 184. "A large radiometer in a 4-inch bulb was made with ten arms, eight of them being of brass, and the other two being a long watch-spring magnet. The discs were of pith, blackened on one side. The power of the earth on the magnet is too great to allow the arms to be set in rotation unless a candle is brought near, but once started it will continue to revolve with the light some distance off."

This radiometer was floated in a vessel of water and four candles were placed round it, so as to set the arms in rotation. A mark was put on the glass envelope so as to enable a slight movement of rotation to be seen. The envelope turned very slowly a few degrees in one direction, then stopped and turned a few degrees the opposite way; finally it took up a uniform but excessively slow movement in the direction of the arms, but so slow that more than an hour would be occupied in one revolution.

A powerful magnet was now brought near the moving arms. They immediately stopped, and at the same time the glass envelope commenced to revolve in the opposite direction to that in which the arms had been revolving. The movement kept up as long as the candles were burning, and the speed was one revolution in two minutes.

The magnet was removed, the arms obeyed the force of radiation from the candles, and revolved rapidly, whilst the glass envelope quickly came to rest and then rotated very slowly the same way as the arms went.

The candles were blown out; and as soon as the whole instrument had come to rest, a bar-magnet was moved alternately from one side to the other of the radiometer, so as to cause the vanes to rotate as if they had been under the influence of a candle. The glass envelope moved with some rapidity (about one revolution in three minutes) in the direction the arms were moving. On reversing the direction of movement of the arms the glass envelope changed direction also.

These experiments show that the internal friction, either of the steel point on the glass socket, of the vanes against the residual air, or of both these causes combined, is considerable. Moving the vanes round by the exterior magnet carries the whole envelope round in opposition to the friction of the water against the glass.

As there is much discussion at present respecting the cause of these movements, and as some misunderstanding seems to prevail as to my own views on the theory of the repulsion resulting from radiation, I wish to take this opportunity of removing the impression that I hold opinions which are in antagonism to some strongly urged explanations of these actions. I have on five or six occasions specially stated that I wish to keep free from theories. During my four years' work on this subject I have accumulated a large fund of experimental observations, and these often enable me to see difficulties which could not be expected to occur to an investigator who has had but a limited experience with the working of one or two instruments.

COMPRESSED AIR LOCOMOTIVE USED IN THE ST. GOTHARD TUNNEL WORKS<sup>1</sup>

THE boring of a tunnel of any importance presents difficulties of various kinds, among which may be mentioned the clearing away of the rubbish arising from the excavation of the gallery, whenever that reaches any considerable length, and the work is carried on with activity. Such were the conditions under which the boring of the Mont Cenis tunnel was carried on, and M. Fabre, the able contractor, has met with similar difficulties in the boring of the St. Gothard tunnel, now being carried out.

<sup>1</sup> From an article in *La Nature*, by M. C. M. Gariel.

The work was begun from two points, Airolo and Göschenen, the two extremities of the future tunnel. The advance of the gallery, which is pushed on with activity, produces about 400 cubic metres of rubbish a day at each of the two faces of attack. To carry away this mass of rubbish, which is thrown regularly into trucks running on rails, it is impossible to employ locomotives, as the *cul de sac* nature of the galleries prevents

these machines would allow only pure air to escape; then these motors would be more powerful than steam and effect more rapidly the clearing away of the rubbish.

A first attempt was made in which two ordinary locomotives were employed, one at each side of the tunnel, the boilers, in which, of course, there was no steam, filled with condensed air under a pressure of five atmospheres. This air played the part usually done by steam; it passed into slide valves, entered the cylinders, and alternately on each face of the piston it set in motion, and then escaped to the atmosphere.

It is easily seen that if compressed air were to be employed, it would be indispensable to have a very considerable quantity of a boiler of a locomotive, sufficient to work by means of steam condensed under the action of heat, was not to contain a quantity of air sufficient to last without being filled. This led to the use of each locomotive a special reservoir of compressed air; each locomotive was accompanied, as a kind of tender, by a long

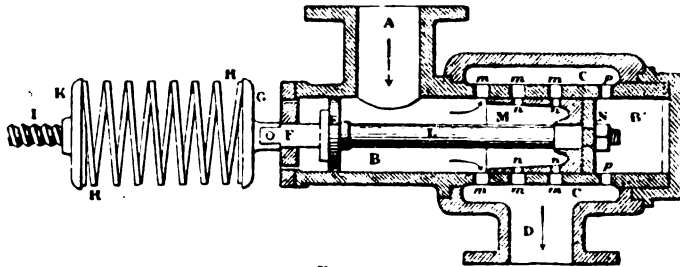

FIG. 1.

effectual ventilation. The high price of horses and the large number required prevent their use. The idea suggested itself of making use for St. Gothard of machines moved by compressed air, which would have many advantages. First, it is well known that compressed air is used to work the perforating machines used in boring the tunnel; then by the employment of compressed air locomotives ventilation of the galleries would be produced, as

cylinder, 8 metres long and 1½ metres diameter, supported towards its extremities by two trucks, which, on their turn, were filled with condensed air, and which communicated by a tube with the distributing apparatus of the cylinder. The locomotive then worked as before, except that the compressed air came from the reservoirs instead of from the boiler. The two locomotives, the *Reuss* and the *Gotthard*, worked economically for about two years, in spite of

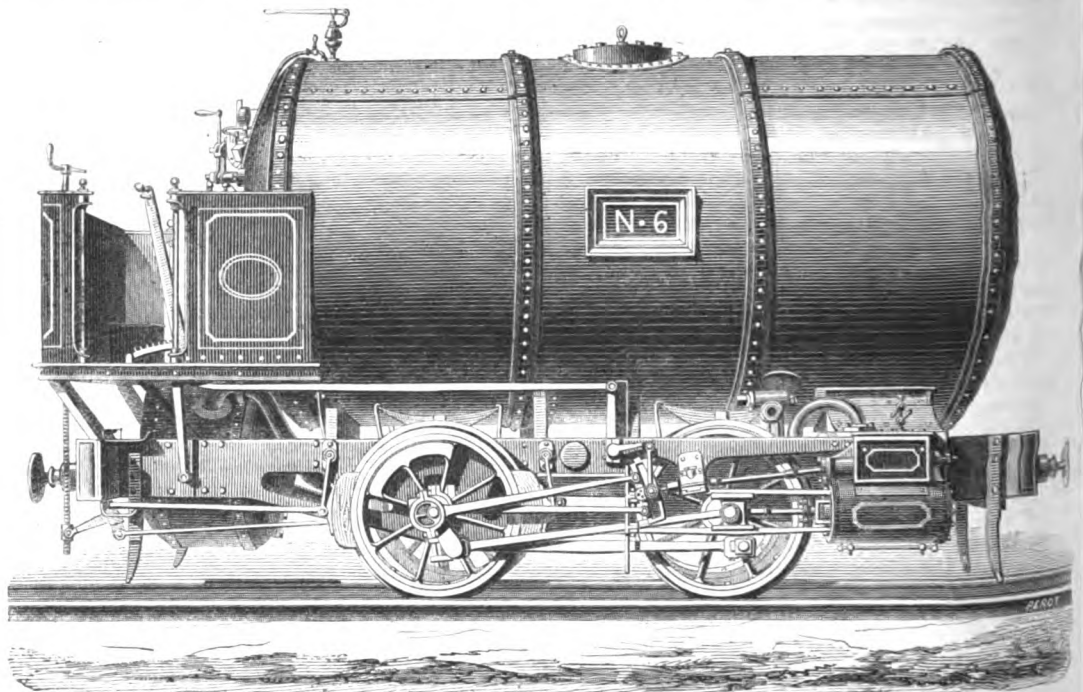

FIG. 2.—Compressed Air Locomotive used at the St. Gothard Tunnel Works.

awkwardness of the long cylinders that accompanied them. We can give some interesting figures resulting from the mean of a certain number of observations. At departure the pressure in the reservoir was about 7 kilogrammes per square centimetre; the locomotive having drawn a train of twelve loaded waggons along a course of about 600 metres, the pressure was found to fall to 4½ kilogrammes; the train then returned empty to the point of departure, and the final pressure was found to be 2½ kilogrammes.

In spite of the relatively advantageous results which were obtained, the employment of compressed air in a steam locomotive presented a certain number of drawbacks. It is expedient that the air should issue from the cylinder under the least possible pressure, in order that refrigeration may be reduced to a minimum; but it is known that the expansion of gas is accompanied by a loss of heat which increases with the pressure. This condition was satisfied by causing the air to act under restraint; that is, by allowing the compressed air coming

from the reservoir to enter during only a part of the course of the piston. But the admission of the air ought to vary if it is desired to obtain the same final effect, since the pressure in the reservoir diminishes continuously; and as the apparatus which regulates the admission was arranged to correspond only to determined fractions, but not to vary in a continuous manner, it followed that there was a greater expenditure of air than was necessary, and consequently a diminution in the length of the course over which the locomotive could run.

On the other hand it is necessary that the air should arrive in the distributing apparatus with the least possible pressure, for it is in this apparatus, in the slide-valve, that the greatest losses take place, and these losses increase in proportion to the pressure. No means could, however, be thought of for diminishing the pressure in the reservoirs, which would have reduced considerably the work which the machines were capable of doing, unless by augmenting considerably the volume of the reservoirs, the dimensions of which were already unusually large.

At this stage M. Ribourt, the engineer of the tunnel, devised an arrangement which allows the compressed gas to flow at a fixed pressure whatever may be the pressure in the reservoir. The gas in escaping from the reservoir enters a cylinder B (Fig. 1), over a certain extent of the walls of which are openings *m m*, that communicate with another cylinder C, which surrounds it to the same extent, and which is connected with the slide-valve by which the air is distributed, or, more generally, with the space in which this air is to be utilised. On one side moves a piston E, which shuts the cylinder and hinders the escape of the air. This piston carries externally a shaft F, which supports externally a spiral spring H, the force of which is regulated by means of a screw. Internally it is connected by another shaft L with a second piston N, which bears a cylinder M, movable in the interior of the principal pump, and forming thus a sort of internal sheath. This sheath presents openings *nn*, which may coincide exactly with those already referred to, and in that case the gas passes without difficulty from the reservoir at the point where it is to be employed. But if the sheath is displaced, the openings no longer correspond, there is resistance to the passage, and consequently diminution of the quantity of gas which flows out, and hence lowering of pressure in the exterior cylinder. By making the position of the sheath to vary continuously we may make the pressure of exit constant, notwithstanding the continuous variation at entry. But the apparatus is automatic. In fact the part of the cylinder B comprised between the bottom and the piston N communicates by openings *p* (which are never covered with the escape-tube of the gas), in such a manner that upon its posterior face the piston N receives the pressure of the gas at the moment when it flows, a pressure which it is sought to render constant. The piston E receives on its anterior face the action of the spring which can be regulated at pleasure. As to the other faces of the two pistons, they are subjected to equal actions proceeding from the pressure of the gas at its entry, actions which thus counteract each other; so that the forces which determine the position of the movable system are on the one hand the tension of the spring, a constant and determined force, and on the other hand, the pressure of the flowing gas; and thus equilibrium cannot occur unless the two forces are equal. If the gas should flow in too great quantity, the pressure increases on the posterior face of the piston N, the spring is overcome, and the movable system advances a little towards the left; but then the orifices are partly covered and the flow diminishes. If the pressure then becomes too weak at the exit, the spring in its turn prevails, pushes the sheath towards the right, uncovers the orifices, and consequently a greater quantity of air may enter.

The machines which are now used at the St. Gothard tunnel, genuine compressed air locomotives, are furnished with M. Ribourt's apparatus. They consist of the following parts:—A sheet-iron reservoir to contain the compressed air is mounted on a framework quite like that of steam locomotives, and carrying glasses, cylinders, distributing apparatus, &c. The tube for receiving the air possesses, within reach of the driver, the automatic valve of M. Ribourt. The screw being easily regulated, the air can with certainty be made to issue from the apparatus at a determined pressure. This air then passes into a small reservoir (about one-third metre cube) intended to deaden the shocks, which are always produced when the machine is set agoing or stopped. Lastly, this small reservoir communicates with the cylinders, and the air which reaches them acts in the same manner as steam in ordinary locomotives.

The pressure in the principal reservoir at the point of exit depends on the power of the compressing apparatus; at St. Gothard it may attain 14 kilogrammes per square centimetre, but is ordinarily about 7.35 kilogrammes. The pressure in the small reservoir is arbitrary, depending on the regulation of the screw; at St. Gothard it has a mean of 4.20 kilogrammes. The entire machine weighs about 7 tons.

#### PHYSICAL SCIENCE IN SCHOOLS

THE passages from Mr. Wilson's essay of 1867 and his letter of 1876 appealed to me in contradiction on the value of science in developing the power of reasoning and of language, since in his letter Mr. Wilson says that science should not be taught to boys till they have attained a certain power of reasoning and language as shown by their attainments in geometry and Latin; and in his Essay he speaks of science as supplying the want of clearness and certitude *better* than arithmetic or geometry, and again, as of all processes of reasoning the exhaustive illustration; and I wished to know whether Mr. Wilson had altered his opinion in the last ten years on this point.

The question at issue is as stated: "Given that boys are going to remain under a system of liberal education till eighteen or nineteen, at what stages is it shown by experience that it is wise to introduce the different sciences?" Certainly my experience has not been so extensive as Mr. Wilson's, but I possess the qualification he demands for forming an opinion, that while (during eight years) I have taught science I have also at various times been occupied with mathematics and with language.

The extent to which science should be introduced into the curriculum of a particular school, and the order in which the various subjects should be taken up, cannot, I think, be practically determined without taking into account various points of mere expediency. If, for example, expense were no consideration, I should prefer certain branches of physics, for example, magnetism and electricity, as the subjects for *the first practical work* to be undertaken rather than chemistry. But practically there is this difference, that a class of twenty or thirty boys in practical chemistry can be handled by one master with fair success; whereas the attempt to carry a *class* through any such course of physics as that sketched in Weinhold (translated by Foster) could, I think, only end in failure. Two or three boys to whom one master could give his whole attention might use the book with advantage, but a *class* could not be so handled, except at the additional cost of two or three assistants and considerable time for preparation.

Without, then, asserting that this is the plan theoretically best, we have been led by circumstances at Giggleswick into the following course:—

The school is divided into the upper school, and the lower (or preparatory) school; the upper school consists



of five classes. No science work (at present) is done in the preparatory school, but all boys in the upper school do some. With the lowest class the subjects are physical geography, and in the summer, botany.

The two reasons why science should be taught in schools are (to quote from Mr. Wilson) that it "is the best teacher of accurate, acute, and exhaustive observation of what is," and that "of all processes of reasoning it stands alone as the exhaustive illustration." And the teaching of physical geography and botany I regard as fulfilling the first of these purposes. We enjoy unusual advantages for the study of these two subjects in the nature of the surrounding country. We are upon the millstone grit, but only a few hundred yards from the great Craven Fault, where the mountain limestone is elevated some 800 feet above the grit into the Giggleswick Scar.

At the distance of a few miles we have the limestone and Yoredale rocks resting unconformably upon the vertical Silurian rocks. Traces of glacial action are numerous—the new line from Settle to Carlisle cuts through moraines, where scratched pebbles may be picked up by the dozen. Erratic blocks are scattered thickly over the whole country. At hand we have the Victoria Cave, and the remains it has yielded are preserved in the school museum, and we are within an afternoon's ramble of the summits of Ingleborough and Pen-y-ghent, and of Clapham Cave, and numerous others. We are equally well off in the matter of botany; a radius of six miles round the school probably includes a greater variety of plants than any equal area in England.

Supposing a boy to enter the upper school at the age of twelve, he would perhaps remain in the class for a year, and at the age of thirteen would enter upon the *systematic* study of science; and his first subject would be chemistry, which he would attack at once *practically*. Four hours a week are given in this class to the study of chemistry—a practical lesson of two hours and two oral lessons of an hour each. In the class of perhaps twenty-five, all the boys are making the same experiments at the same time, and the work consists mainly in the study of the properties of the salts of particular metals. The boys are led to infer for themselves from their own experiments the solubility or insolubility of the salts of the metals in water, acids, &c., and from that to advance to simple analysis. No text-book is used.

In the oral lessons we advance very slowly; one term suffices probably to get through not more than oxygen, hydrogen, and water, and perhaps to begin air. It seems to me that a boy learns much more by understanding thoroughly the experimental evidence that nine pounds of water contain eight pounds of oxygen, than in learning the "mode of preparation and properties" of the oxides of nitrogen and a dozen other substances. In the next class in which the average age is perhaps fourteen to fifteen, we get through nitrogen, carbon, chlorine, bromine, iodine, fluorine, and perhaps sulphur, practical work being continued at the same rate as before. In the second class we have two hours a week for chemistry, two hours for practical work, and two hours for physics. In physics we take the various branches in succession, and get through the subjects of Balfour Stewart's "Physics" in about two years, which is the time many boys remain in the class, the ages being fifteen to seventeen. In the first class we have eight hours a week. The subjects we are taking at present are:—Inorganic and Organic Chemistry, two hours; Analysis, two hours; Electricity and Magnetism, two hours; Astronomy, two hours.

We shall shortly be able, in consequence of the extension of the buildings, to add some practical work in physics. But this will be only for the highest class.

Will you allow me, in conclusion, to quote some of the conclusions of the British Association Committee on Scientific Education in Schools, which appear to me to

be still as important as when they were first written. The Committee included Mr. Farrar, Prof. Huxley, Prof. Tyndall, and Mr. Wilson:—

"There is an important distinction between scientific *information* and scientific training; in other words, between general literary acquaintance with scientific facts, and the knowledge of methods that may be gained by studying the facts at first hand under the guidance of a competent teacher." Both of these are valuable; it is very desirable, for example, that boys should have some general information about the ordinary phenomena of nature, such as the simple facts of astronomy, of geology, of physical geography, and of elementary physiology. On the other hand, the scientific habit of mind, which is the principal benefit resulting from scientific training, and which is of incalculable value, whatever be the pursuits of after-life, can better be attained by a thorough knowledge of the facts and principles of one science than by a general acquaintance with what has been said and written about many.

"The subjects we recommend for scientific *information* should comprehend a general description of the solar system, of the form and physical geography of the earth, and of such natural phenomena as tides, currents, winds, and the causes that influence climate, of the broad facts of geology, of elementary natural history with especial reference to the useful plants and animals. And for scientific *training* we are decidedly of opinion that the subjects which have paramount claims are experimental physics, elementary chemistry, and botany. The science of experimental physics deals with subjects which come within the range of every boy's experience. It embraces the phenomena and laws of light, heat, sound, electricity, and magnetism, the elements of mechanics, and the mechanical properties of liquids and gases. The thorough knowledge of these subjects includes the practical mastery of the apparatus employed in their investigation. The study of experimental physics involves the observation and colligation of facts, and the discovery and application of principles. It is both inductive and deductive. It exercises the attention and the memory, but makes both of them subservient to an intellectual discipline higher than either. The teacher can so present his facts as to make them suggest the principles which underlie them and which once in possession of the principle, the learner may be stimulated to deduce from it results which lie beyond the bounds of his experience. The subsequent verification of his deduction by experiment never fails to excite his interest and awaken his delight.

"Chemistry is remarkable for the comprehensive character of the training which it affords. Not only does it exercise the memory and the reasoning powers, but it also teaches the student to gather by his own experiments and observations the facts upon which to reason.

"Of the value of the elementary teaching in chemistry (at Rugby) there can be only one opinion. It is felt to be a new era in a boy's mental progress when he has realised the laws that regulate chemical combination and sees traces of order among the seeming endless variety. But the number of boys who get real hold of chemistry *from lectures alone* is small, as might be expected from the nature of the subject." W. MARSHALL WATTS

Giggleswick, April 15

We teachers must keep clear in our minds the two sides of the question: the relative educational value of the subject to be taught, and the age or capacity of the pupil. We may roughly classify sciences into those which cultivate the observing, and those which benefit the reasoning powers, though of course all sciences do both to some extent. Of the former, the only one which should be adopted systematically, in my opinion, is botany. Zoology cannot be as practically taught, though the *habits* of all kinds of animals afford infinite opportunity



for training the observing powers of pupils in the country ; which should be judiciously directed by the teacher so as to render the observations continuous and systematic as far as they go ; they should be always duly recorded, dated, and correctly described. But the encouragement of making collections must be done cautiously, as boys are too prone to be thoughtlessly cruel. Of course information on animals may be given informally. With regard to botany nearly twenty years' experience of teaching boys and girls of all ages and of nearly all classes, has convinced me that it may be commenced as soon as one likes. The plan pursued by my father at Hitcham (of which an account will be found in the *Leisure Hour* for 1862, p. 676) clearly proved the advantage to be derived by village school children, and I can corroborate it by my own attempts in another village ; for there was a marked increase in the general intelligence, to say nothing of botany giving the children an amusing and instructive employment in the fields instead of their idling in the street—a fact noticed and strongly approved of by their parents. This subject, whatever may be the objections to others, can be taught to almost infants.

With regard to electricity, magnetism, and the elements of chemistry, beyond the last of these, I have no experience, but should fancy that the manipulation required would be unattainable before the ages of eleven or twelve, and the abstract nature of force would scarcely commend itself to the understanding before that age.

Physical geography, however, is another subject which, although affording less scope for the observing powers as botany, is by no means absolutely wanting in this respect. I cannot say that my "young boys [were] more (or less) attentive, active-minded, diligent when they [were] doing arithmetic than when they [were] at a lesson on physical geography." One principle I would insist upon is to appeal to the eye, as well as or rather more than the imagination, of young people. Hence in teaching this science, where no direct observation of the facts is possible (as of glaciers, in Warwickshire), my plan was to procure abundant and good illustrations, while the chief facts connected with their motions and formations would be illustrated by diagrams on the black board. Yet the effects of river and atmospheric action may be actually seen, often to a considerable extent, everywhere ; and marine action having been learnt and understood at school, has been eagerly looked for when a visit to the sea-side was forthcoming. Here, however, not only facts should be taught, but their causes, or forces in action which have produced them and the study will then never be dry. Physical geography has its value in realising in the pupil's mind the true nature of sequences between cause and effect, and he thus begins to grasp the fundamental principle of philosophy or "continuity" of action. I have found boys of eight thoroughly able to appreciate the elements of the subject ; of course by adapting the facts and reasoning to their capacities.

Physical geography, being simply "modern geology," should invariably precede geology, which above all subjects cultivates inductive reasoning, and I have found boys from about twelve well able to grasp the main facts and reasonings. If they happen to be near any fossiliferous strata or where a variety of rock specimens may be procured, the encouragement to collect as many as possible should be given at any preceding age, for the most fascinating pursuit in science is undoubtedly collecting. (I have to this day crag shells collected at the age of eight, when I was first initiated into geological mysteries.) Collecting, however, is of course only the preliminary stage, and one's scientific lore must not be allowed to rest there.

Before twelve I agree with Mr. Wilson that practical chemistry should not begin for reasons already mentioned. But, however, Mr. Wilson says, "Science should be introduced into a school, beginning at the top

and going downwards gradually to a point which will be indicated by experience," surely this is inverting a fundamental principle of education, and we may ask why should science be thus singled out? Why not begin at the top with Latin and arithmetic, and work downwards? Science, however, has its "elements" and its "advanced" stages like everything else. The soundest method seems to me to select the science for each age or capacity of pupils, and for the teacher himself to adapt the branch selected to them. Let him begin with botany—with children of the age of six, if he pleases—and by using the schedule he will find it almost self-adapting to the child's powers, as I have more fully explained elsewhere (see a paper "On the Practical Teaching of Natural Science in Schools," *Educational Times*, March 1, 1876). Physical geography might come next with pupils from eight to twelve, then the experimental sciences or geology from twelve upwards. The observing of the habits of animals might go along with any other science as an out-door instructive amusement, and be limited to no age.

Mr. Wilson talks of the difficulty of a "bored and weary schoolmaster teaching science informally." Passing by the fact that if he be bored and weary, it is largely due to his own want of interest in teaching or in engaging that of his pupils ; I would maintain just the opposite opinion, that assuming a teacher to be such, informal teaching in natural history has a wonderful invigorating effect and re-awakens the attention which may have become dull by monotony. Thus I have often found during a lesson in Latin, e.g., Virgil's "Georgics," passages to be constantly occurring when "collateral science" can be invoked. And what is a proof of its value is, that it becomes suggestive to the pupils themselves, so that I have been obliged to check the superabundance of questions lest a Latin lesson should resolve itself into one on natural history.

Beyond such informal teaching as this I would never encourage it as a principle for teachers solely to act upon, with young children, though, of course there need be no restrictions in giving it them ; but if science is to be taught at all—and all such informal methods are not really teaching—let it be thorough as far as it goes, lest it should lapse into a slipshod informality. It is the charm of the schedule system of botany that it demands close and accurate observation in the dissections, and the writing compels accuracy in the result as well as impresses the facts firmly upon the memory. Mr. Wilson is doubtless right in laying stress upon the necessity of securing abundance of capable teachers, which will probably ever be one of the chief difficulties to contend against.

GEORGE HENLOW

#### NOTES

M. LEVERRIER has sent to M. Waddington, the French Minister of Public Instruction, a proposal for the immediate construction of the great refractor for the Paris Observatory, which is to be finished in two years and five months. A tender has been sent to M. Leverrier by M. Eichens, the constructor of the great reflector, for that purpose ; M. Leverrier proposes the acceptance of M. Eichens' offer.

M. LEVERRIER has been appointed president of the Scientific Committee of the Assemblée des Sociétés Savantes, which is to be held at the Sorbonne next week.

AN Academy of Science has been established at Kansas City, Mo., United States, with appropriate sections for geology, zoology, botany, local history, numismatics, &c. One of the chief objects of the association is to form a museum of specimens which will represent the minerals and fossils, and the fauna and flora of Missouri, Kansas, and the territories.

FROM a communication received by the Scottish Meteorological Society from their observer at Stykkisholm, Iceland, dated



March 11, we learn that the past winter has been particularly mild, the cold having been at no time either persistent or severe. The rainfall has been considerable, and little snow has fallen, and what did fall quickly disappeared. The absence of snow allowed cattle and horses almost always to get good pasturing, and in many places the young sheep were not put under shelter till the end of January, a circumstance almost unprecedented. At the date of writing, the Greenland ice had not made its appearance in the north-west of the island, to which, and to the unusual prevalence of southerly winds, the mildness of the winter in Iceland has been due. The volcano in the Northland has recently shown signs of disturbance by emitting volumes of smoke at intervals, but no ashes or lava has been reported.

SOME time ago an experimental inquiry was undertaken by M. J. J. Müller on a point of considerable importance in reference to our knowledge of the luminiferous ether, viz., whether in light as in the case of sound, the wave-length is dependent on the intensity, or (the same thing) the amplitude of the vibrations. He gave an affirmative answer, and said that the wave-length increases with the intensity. In view of the important issues involved, M. Lippich has recently been led to repeat the experiments, and with arrangements of greater accuracy (about 2,000 times, as he estimates, more accurate than Müller's). From this investigation, of which an account appears in the *Sitzungsberichte* of the Vienna Academy, he concludes, in opposition to Müller, that the wave-length of light, whether in free ether, or in any ponderable media, is independent of the intensity of the light vibrations, and so, the duration of vibration being given, a constant depending only on the nature of the medium considered at rest.

THE time elapsing between the action of an external stimulus on some part of the body, and the giving of a signal (previously agreed upon) in reply, has been determined in the case of several senses, by various experiments. A short time ago M. M. Vintschgau and Hönigschmied sought to determine this "reaction-time" for sensations of taste on the point of the tongue; and in the subject experimented on, this was found to be, for ordinary salt, 0.1598", for sugar 0.1639", for acid 0.1676", and for quinine 0.2351". It is interesting to compare the results which the same observers have recently obtained in further experiments as to the reaction-time for sensations of touch on the tongue. This, in the same individual, was found to be 0.1507" in the case of the tongue being touched with a pencil; a smaller value, therefore, than that of the shortest interval in the former case of taste. In the middle of the tongue the reaction-time, on touching with a pencil, was 0.1527". A weak electric stimulation of the tongue-point was answered after 0.1813", whereas with a stronger electric stimulus the answer came in 0.1452". These numbers represent, in all cases, the averages of all the experiments. It will be seen, then, that the point of the tongue is most sensitive for strong electric stimuli, and the order of sensibility for the remaining stimuli, was (for this individual): Contact, saltiness, sweetness, sourness, weak electric stimulation, and bitterness. Other persons on whom similar measurements were made, gave values that were different both relatively and absolutely, and the results for different persons appear to be not comparable together. Various secondary influences play an important part, among which may be cited the thickness of the mucous membrane at the particular part experimented on; this may considerably increase the reaction-time. An estimate of the comparative sensibility of the separate organ of sense can best be had from comparisons in one and the same individual.

MR. W. SAVILLE-KENT, F.L.S., F.G.S., &c., formerly of the British Museum, and more recently of the Brighton, Manchester, and Yarmouth Aquaria, has been appointed Managing Naturalist to the Royal Aquarium, Westminster. Some of the

fresh-water tanks are already stocked with fish; the sea-water is being rapidly imported, and it is anticipated that a fine collection of both salt and fresh-water species will be on view in the course of a few weeks.

M. AMÉDÉE GUILLEMIN announces a new edition of his well-known work "Le Ciel," to be published in fifty-five weekly parts. For the new edition the work has been to a great extent recast, in order that account might be taken of all the important recent discoveries and advances in astronomy. The results which have been obtained by means of the spectroscope in relation to the sun and the stars will especially occupy a prominent place in the new edition, which will be larger by one-half than any of its predecessors; the number of plates and woodcuts will also be increased in a like proportion.

M. MARIÉ DAVY has asked the Municipal Council of Paris to grant the necessary funds for the construction of an experimental lightning conductor. The apparatus is to be placed on a pole erected at a distance from buildings, and to have a key, so that continuity may be interrupted for scientific purposes.

M. BERTHELOT, the well-known French chemist, has been appointed Inspector of Public Instruction, in place of M. Balard.

MESSRS. COLLINS AND CO. have sent us a volume containing "Tables, Nautical and Mathematical, for the use of Seamen, Students, Mathematicians, &c., arranged, corrected, and some re-calculated," by Henry Evers, LL.D. The author has mainly followed the best English authorities, and we believe the collection will be found very useful by those for whom it is intended. There are in all twenty-one different tables, and prefixed is an introduction to the Logarithmic Tables, showing how they are used.

IN the last issued part of the *Transactions* of the Manchester Geological Society (Part ii., vol. xiv.) there are papers by Mr. J. Dickenson, on Measuring Air in Mines, and by Mr. Aitken, on Drift Deposits on the Western Pennine Slopes of the upper drainage of the rivers Calder and Irwell, with suggestions as to the cause of the partial absence of drifts on the Eastern Slopes. Mr. Plant gives some interesting details on a submerged forest near Holmfirth, and Prof. Boyd Dawkins states his belief, from a critical examination of the coal-fields of New South Wales that there is not much doubt of their being palæozoic.

AT the recent annual meeting of the Asiatic Society of Bengal Mr. Blochmann read extracts from an account of the Meywar Bheels, by Dr. T. H. Hendley, Residency Surgeon, Jeypore, Rajpootana, who gives description of those members of the Bheel race who reside in the Hill Tracts of Meywar (Oodeypore), where they have perhaps best preserved their individuality. In the chapter on the religion of the Bheels, Dr. Hendley notices the cairns or sthans, which are erected on the summits of high hills, and the curious reverence of the people for the horse, which, as Sir J. Malcolm says, the Bheels worship, and do not mount. Then follows a description of the customs observed at births, marriages, and deaths, of the government and the agriculture of the tribe, and statistical tables containing race measurements. The Bheel skull is slightly dolichocephalic, and differs very much from the long thin-walled cranium of the pure Hindoo. Mr. Blochmann also read extracts from a paper by Mr. J. A. Smith on the popular songs of the Humeerpoore District, N. W. P. This paper contains specimens of songs sung in Bundelkhand in honour of Hurdaul, a son of the notorious Bir Singh Deo Bundila, Rajah of Urcha, who was poisoned by his brother Jhajhar Sing. His ghost is worshipped in every village, and chiefly at weddings in Baisakh. Hurdaul is also propitiated with songs when storms appear.



MR. GILES, with the camels belonging to Mr. Elder, was to leave Champion Bay, West Australia, early last month. He was to examine the tributaries of the Murchison and other rivers on the North Coast, and then push across to South Australia, hoping to reach Adelaide in December.

MR. CAMPBELL DE MORGAN, F.R.S., died on the 11th inst. Mr. de Morgan had contributed some valuable papers to the *Philosophical Transactions* and to the medical journals.

SIR WILLIAM JENNER, BART., will deliver the Harveian Oration on Midsummer Day.

THE Rhind Lectures on Archæology, in connection with the Society of Antiquaries of Scotland, will be given by Dr. Arthur Mitchell, commencing on Tuesday last, and continued on the following Fridays and Tuesdays. There will be six in all, and the subject is, "Do we possess the means of determining scientifically the condition of Primæval Man and his Age on the Earth?"

A BOTANIC GARDEN about twenty acres in extent has been just opened at Southport. In connection with it a museum has been erected containing collections in the various branches of natural history, the entomology of the neighbourhood being well represented in this branch of the museum. Geology has a department assigned to it, and the usual local curiosities, with coins, medals, &c., have a place. The whole of the collections have been well arranged and classified.

It is proposed to erect an aquarium and winter garden at Clifton, and a committee has been appointed with a view of obtaining a proper site.

MR. JOHN MURRAY announces a new work by Mr. Charles Darwin, F.R.S., on the results of cross and self-fertilisation in the vegetable kingdom.

THE *Journal Officiel* of the French Republic has published an official document estimating the expenses of the International Exhibition of 1878 at 1,200,000*l.*

AN interesting notice has appeared by MM. Becqueral and Edm. Becqueral of the temperatures observed at the Museum, Paris, during 1875, with electric thermometers placed at depths varying from 33 feet to 118 feet. The mean temperature increases with the depth from 50.3 at 3½ feet, to 54.4 at 118 feet. The seasonal range diminishes with the depth, the difference between the two extreme seasons at 3½ feet being 13.5; at 19½ feet 3.0; at 36 feet 0.5; at 101 feet only 0.07, and at 118 feet the temperature is constant through the year. An interesting point is the disturbing influence on the varying annual and seasonal results according to depth, arising from the different geological strata met with, but particularly from two layers at depths of 49 and 79 feet, through which a constant flow of water percolates to the Seine. In these layers the minimum occurs towards the end of winter, and the maximum in summer, being thus assimilated as regards these annual phases of their temperature to the surface layers.

M. CROVA, professor in the Montpellier Academy, has instituted experiments to determine by calculation what is the value of solar radiation at the limits of the atmosphere. The professor found that for a normal plane exposed to the sun's rays it amounts to two calories per minute on each square centimetre, so that almost every hour a cubic centimetre of water could be heated to 100°C. if no heat were lost by evaporation. Pouillet found the number greater by half, and equal to 2,31,000 calories per year for each square centimetre.

ON April 1, at 5 o'clock in the afternoon, a partial solar halo (46°) was observed at Paris. The arc (12°) was vertical in the orient of the sun, and at the same distance from the

horizon, and the colours were as vivid as an ordinary rainbow. The partial halo was accompanied by a parheliion or triangular mass of light. The interior part of the halo was obscure. The phenomenon lasted for three-quarters of an hour. At 5h. 30m. a vertical column of light going upwards to the zenith was observed.

THE French Minister of Public Instruction, M. Waddington, has visited officially the several establishments of public instruction in Paris, as well as the site of the building to be constructed for the use of the Academy of Medicine. It may be interesting to state that the money required for the building, which we referred to in a recent note, was extorted from the Bank of France during the Commune, under threat of pillage and assassination. The government assented to restore it to the city of Paris, to which it belonged, on condition that it should be devoted to works of public usefulness. The Municipal Council accepting the condition granted it for improving and extending the buildings of the Faculty.

M. LARGEAU and his staff have returned from Rhadames to Constantine after a successful journey. A lecture has been delivered at the Salle Herz, in Paris, by M. Foucher de Careil, a senator, and a concert given on behalf of future explorations by M. Largeau and his colleagues.

MANY persons are under the impression that white cats with blue eyes are deaf; it can by no means, however, be deemed to be so commonly the case as to be an evidence of much consequence in building a theory upon. A New Zealand correspondent sends us some curious facts bearing on the point. "At Taranaki, N. Z.," he says, "I saw a white cat with blue eyes which was not at all deaf, and a good many of its kittens were white and had light blue eyes. As many of these had perfect hearing as were afflicted with deafness. This cat had a grown-up kitten perfectly black which had sometimes also white young ones with blue eyes; it showed, as did the old cat, a singular partiality for them. On one occasion it happened that the old white cat and her black daughter had litters at the same time; amongst them there was only one white kitten with blue eyes—the black cat's. The two fought fiercely for possession of the coveted beauty, and the old cat frequently took it away and placed it amongst her own. One morning the unfortunate object of quarrel was found divided by the recommendation of some feline Solomon, and each cat quite contentedly in possession of half. Both of these litters had some light tortoiseshell-coloured kittens among them, of which a moiety appeared to have their hearing imperfect."

"RAILWAY Appliances, a Description of Details of Railway Construction subsequent to the Completion of the Earthworks and Structures, including a Short Notice of Railway Rolling Stock," is the title of a little work by Mr. John Wolfe Barry, published by Longmans and Co. The work, we believe, will be found of value not only to railway officials of all kinds who desire to have an intelligent knowledge of their duties and of the details of the elaborate system whose efficient working depends on them, but also to the general, and especially the stock-holding, public, who have but a vague idea of the multitude of details which are wrapped up in the little word "railway." Mr. Barry treats in successive chapters of Acts of Parliament and other regulations affecting railways, permanent way, points and crossings, signals, the block system, stations, and rolling stock. The book is plentifully illustrated.

THOSE who are familiar with Dr. J. W. Draper's "History of the Intellectual Development of Europe," will be glad to know that Messrs. George Bell and Sons have published an edition, revised by the author, in Bohn's "Philosophical Library" series.

MESSRS. LONGMANS AND CO. have published as an Appendix to the seventh edition of Gamot's *Treatise on Physics*,—



"Problems and Examples in Physics." We believe this collection will be found useful by the student of other text-books of Physical Science. There are 217 examples with answers.

MR. F. GREEN, writing from Cannes, April 16, states that he had just seen, for the first time this year, a flight of about half-a-dozen swallows. They were passing over his garden coming from the sea, and going to the N. W. The nearest land to the S. E. from Cannes is Corsica, 110 miles away. Last year the first flight of swallows which he observed at Cannes was on April 11, and on the same day he heard the nightingale for the first time of the season. This season he has not yet heard the nightingale.

THE additions to the Zoological Society's Gardens during the past week include an Indian Wild Dog (*Canis primæus*), a Common Paradoxure (*Paradoxurus typus*) from the Deccan, presented by Col. A. C. McMaster; a Small Hill Mynah (*Gracula religiosa*) from India, presented by Mrs. A. E. Smithers; a Yellow-faced Amazon (*Chrysotis xanthops*) from S.E. Brazil, presented by Mrs. Geo. B. Crawley; two Common Boas (*Boa constrictor*) from St. Lucia, presented by Mr. G. W. Des Vœux; four Trout (*Salmo fario*), a Golden Tench (*Tinca vulgaris*) from British Fresh Waters, presented by Mr. D. Banks.

#### ABNORMAL MULTIPLICATION AND ABORTION OF PARTS IN MEDUSÆ<sup>1</sup>

PROF. L. AGASSIZ describes as of very rare occurrence upon the American coast, a peculiar variety of *Sarsia*, presenting six radial tubes, six oulli, and six tentacles. It therefore becomes the more interesting to state that I met with a precisely similar variety on the east coast of Scotland. Moreover, the occurrence of this variety appears to be as rare in the one locality as in the other; for of all the many thousands of *Sarsia* which fell within my observation last summer, I only met with one specimen of the variety in question.

In nearly all the species of naked and covered-eyed Medusæ which I had the opportunity of examining, there was a remarkable absence of monstrous or mis-shapen forms. In the case of one species, however, such forms were of frequent occurrence. This species was *Aurelia aurita*, and the monstrosities showed themselves both as abnormal multiplications and abortions of parts. In all the cases of asymmetrical multiplication which I observed, the peculiarity was confined to the lithocysts, and always showed itself in the same manner. That is to say, I have several times observed, in otherwise normal specimens of *Aurelia aurita*, the presence of nine instead of eight lithocysts, and in all these cases the supernumerary lithocyst—which was always fully formed and provided with the usual hood—was placed beside and in close contact with one of the normal lithocysts. This latter fact appears to me important when considered in relation to the theory of Pangenesis; for upon this theory it would follow that if a supernumerary lithocyst is to be developed at all, we should expect it to be so in apposition with one of the normal lithocysts rather than in any other position. Our ground for expecting this, of course, is that the theory of Pangenesis supposes similar gemmules to have a mutual affinity for one another; and as lithocyst gemmules would naturally be plentiful in the region of any normal lithocysts during the process of its development, or of its repair if injured, if anything went slightly wrong in either of these processes, facilities would be offered for the adhesions of improper gemmules at the point where the disturbing cause acted, and these improper adhesions having once taken place, and being then followed by normal adhesions of proper gemmules, the result would probably be a duplex organ.

I have said that in all the cases of asymmetrical multiplication of parts which fell under my notice, it was the lithocysts alone that were affected. But besides these cases of asymmetrical multiplication of parts in *Aurelia*, I saw several instances of strictly symmetrical multiplication, and in all these instances every part of the organism was equally—or rather proportionally—affected. That is to say, as in the single instance of multipli-

cation of parts which I observed in *Sarsia*, all the organs of the nectocalyx—eye-specks, tentacles, and nutritive tubes—were similarly affected; so in the several instances of multiplication of parts which I observed in *Aurelia*, all the organs of the umbrella were similarly affected. If anyone will turn to the admirable plates contained in Prof. L. Agassiz's third contribution to the Academy of Arts and Sciences, and representing a normal specimen of the genus *Aurelia*, he will see that the nutritive canals bear a very definite and symmetrical arrangement with reference to one another, and also with reference to the ovaries and lithocysts. In particular, there are sixteen principal radial tubes that proceed in straight lines and without branching from the centre to the circumference of the umbrella. Of the sixteen tubes, one passes directly to each of the eight lithocysts, while the remaining eight tubes alternate with these. Thus the sixteen radial tubes together mark out, as it were, the whole umbrella into sixteen equal segments. Well, in all the examples which fell under my notice of abnormal multiplication of parts in *Aurelia* (other than those of mere duplication of lithocysts), the precise and peculiar symmetry just described was strictly adhered to; in all these examples the undue multiplication extended proportionally to ovaries, nutritive tubes, lithocysts, and tentacles; so that its effect was to increase the number while adhering to the type of the natural segments above described. It is further remarkable that in all the instances I met with, the degree of abnormal multiplication was the same; for in all the instances the ovaries were six, the principal or unbranched radial tubes twenty-four, and the lithocysts twelve. All the parts, and therefore all the natural segments, were thus in all the observed instances increased by one-third of their normal number. It is curious to note that we have here the same proportional increase as has already been described in the case of *Sarsia*. This, of course, may be a mere accident; but whether or not it is so, I think that, as there is certainly no reason either in the case of *Sarsia* or of *Aurelia* to regard the forms in question as distinct species, it becomes worth while to draw attention to the very definite manner in which the abnormal multiplication of parts seems always to occur in these the only genera of Medusæ in which such multiplication has as yet been observed. It is perhaps worth while to add that in all the cases where I noticed this undue multiplication of parts, both in *Sarsia* and in *Aurelia*, the animals were remarkable for the unusual amount of nervous energy which they displayed. There can be no doubt that this fact is to be attributed to the unusually large supply of nervous matter that was secured to the organism by the multiplication of its marginal bodies.

As regards abortion of parts in *Aurelia aurita*, I cannot say that I have ever observed this to occur in any organs other than the ovaries. In these, however, suppression to a greater or less extent is of pretty frequent occurrence. Most usual is the case where one of the four ovaries is of smaller size than the other three. Often the abnormal diminution extends to two alternate or adjacent ovaries, and occasionally to three. More rare is the case of total suppression of one ovary. Only on about a dozen occasions have I seen total suppression of two ovaries, and in these it was sometimes the adjacent, but more frequently the opposite organs that were missing. Lastly, on one occasion I observed, in an otherwise well-grown specimen, a total absence of three out of the four ovigerous pouches. In no case, it may be added, did I observe that a deficiency or absence of ovigerous pouches entailed any corresponding deficiency or absence of any other organs.

I have said that, so far as my experience extends, neither reduction nor complete suppression of parts appears to occur in any organs of *Aurelia aurita*, other than the ovaries. It therefore becomes necessary to add that one or more of the lithocysts with their hoods are frequently to be seen of smaller size than the others. As these variations, however, are usually attended with a deficiency of the general tissue of the umbrella in the neighbourhood of the affected lithocyst, I am inclined to believe that in these cases the small lithocyst is one that has been reproduced to repair the loss of the original organ, which I suppose to have been removed by mechanical violence of some kind—a mutilation which seems well indicated both by the deficiency just alluded to of umbrella tissue in the parts concerned, and also by the cicatrix-like appearance which is presented at the confines of these parts by such tissues as remain. In conclusion, I may state that towards the end of August all the individuals of this species began to undergo a marked diminution in size. Concurrently with this diminution in size, the intensity of the pink colour—which in this species is characteristic of the ovaries, nutritive

<sup>1</sup> Extract from a paper on some new species and varieties of Medusæ, read before the Linnean Society on April 6th, by George J. Romanes, M.A.



system, and tentacles—underwent a marked decrease; so that at last I was only able to obtain specimens one half or one quarter the ordinary size of *Aurelia aurita*, and having nearly all their natural rose-pink colour discharged. I believe that these two phenomena—the loss of colour and the diminution in size—are related to one another in a very intimate manner. Just at the time of year when these two phenomena began to manifest themselves, I observed that all the specimens of *Aurelia* I met with were infested by a species of crustacean, which lodged chiefly in the ovaries and nutritive canals. These crustaceans appeared to devour with avidity all the coloured parts of their hosts, and I think it was probably due to the ever-increasing numbers of these parasites that the size of the individuals composing the incoming generations of *Aurelia* continued to become more and more diminutive. I shall, however, attend to all these points more closely next year, after which I shall doubtless be able to speak with more certainty regarding them.

### SCIENTIFIC SERIALS

*American Journal of Science and Arts*, March.—In this number Mr. Trouvelot directs attention to the phenomenon of what he calls "veiled solar spots." During last year, the chromosphere has been notably thinner than usual, and the granulations smaller and less numerous, rendering more conspicuous the light-grey coloured back-ground between the granules. The veiled spots are seen through the chromosphere that is spread over them like a veil; they are, like ordinary spots, true openings of the photosphere; they are scattered throughout all latitudes, though more complicated in regions where the ordinary spots make their appearance. Mr. Trouvelot has observed spots at least within 10 degrees of the north pole of the sun (very few of the ordinary spots have hitherto been observed beyond 40).—Prof. Kimball describes an ingenious arrangement by which he demonstrates that the law affirming the coefficient of friction on an inclined plane to be constant for all velocities, is not strictly true. The sliding box had a cover 6 feet long, with strips of smoked glass upon it, on which a tuning fork, fixed above to an independent support, traced a wave-line as the box slid down, thus giving a perfect autographic register of the experiment.—A new method of measuring the velocity of electricity is described by Prof. Lovering. He avails himself of Lissajous' method of compounding the rectangular vibrations of two tuning forks, the reflected beam entering a telescope. The forks being maintained in vibration by electro-magnets and brought into unison, the resultant orbit seen in the telescope is invariable. A length of resistance coil is introduced sufficient to change the orbit to some other in the series, and this change reveals the amount of retardation of the one fork's vibrations, due to the inserted resistance.—Prof. Mallet discusses the constitutional formulæ of urea, uric acid, and their derivatives.—A new trilobite, *Dalmanitis dentata* is described by Dr. Barrett, and Prof. Marsh gives (in an appendix) the principal characters of *Tillodontia*, a new order of extinct mammals found in the Eocene deposits of North America.—Mr. Wallace gives an account of some flint implements found in the stratified drift in the vicinity of Richmond, Virginia, and there are one or two notes on points in American geology.

*Foggendorff's Annalen der Physik und Chemie*, No. 12, 1875.—A few years ago, separate researches were published by Narr and Stefan, on the conduction of heat in gases. M. Winkelmann here extends the inquiry, his object having been to ascertain how far production of currents and radiation affected the velocity of cooling, to study the behaviour of more gases, in order to a fuller comparison with theory, and to determine the dependence of heat-conduction of gases on temperature (the last is reserved for another paper). His apparatus was substantially like Stefan's, and he examined ten gases. The numbers obtained differ considerably from those of Narr, in whose experiments, he thinks, currents had not been avoided, and had contributed not a little to the velocity of cooling. Stefan's value for air is 6 per cent. greater than the author's, and this difference is explained by radiation, which Stefan had not taken into account.—M. Weber studies the coloured products obtained through the action of sulphur and selenium on sulphuric acid anhydride. He has got from this action a new oxygen compound of sulphur and a corresponding substitution product of selenium. The former contains twice as much sulphur as sulphuric acid (57.14 per cent.), and the formula assigned is  $S_2O_3$ . M. Weber proposes for it the name of *sesquioxide of sulphur*, or *dithionoxide*. In the dry state it forms bluish-green crystals, and is like malachite in structure.

Liquid only in the moment of production, it soon solidifies and cannot be fused again without decomposition. In a cool chamber, decomposition occurs but slowly. The selenium compound is denoted by the formula  $SeSO_3$  (it requires 49.68 per cent. selenium, 20.12 per cent. sulphur.) The crystallised solid is of a dirty green colour, and it is much more stable than *dithionoxide*.—Before his death, Prof. J. J. Müller was engaged in experimenting on the influence of insulators on induction; and he communicated to Dr. Fiedler the following results. (1) Insulating media exercise, on the strength of induction, the opposite influence to the induced magnetism of the conductors. (2) Static electricity accumulated on insulators, exerts an influence on the strength of induction. Dr. Kleiner here gives details of the experiments, from which these conclusions were formed.—In a paper on thermo-electricity, M. Kohlrausch considers that for a theory of the phenomena, we do not need an immediate action of the contact surfaces, but can arrive at full agreement with the facts by assuming electromotive forces in the interior of the conductors, the places of contact having only a secondary influence. In every thermopile, when in action, there necessarily is, with the difference of temperature, a streaming over of heat from the hotter to the colder junction. The difference of temperature of the soldered parts has hitherto been thought the cause of the electromotive force; but with equal right we may take as basis the other inseparable circumstance, and suppose that with a heat current in a determinate mass, dependent on the nature of the conductor, an electric current is connected (provided that other electromotive forces are first excluded). These ideas are developed in the paper.—M. Holtz communicates the results of various attempts to improve the simple "influence" machines; and Prof. Lommel furnishes an elementary treatment of some optical problems, the smallest deflection in the prism, the achromatic prism, and the elementary theory of the rainbow.—M. Edlund deals with two objections to his unitarian theory of electricity; one by Prof. Newman, that to explain unipolar induction, the presence of at least two electric fluids is necessary; the other by M. Baumgartner, that the unitarian theory seems to contradict the supposition that vacant space has no conductivity for the galvanic current.—M. Sadebeck contributes some mineralogical studies from Kiel University; and among other subjects treated in this number are, the behaviour of electricity in electrolytes (Budde) and the alteration of the velocity of light in quartz through pressure (Mach and Merten).

*Memorie Della Societa degli Spettroscopisti Italiani*, Sept. 1875.—Prof. Tacchini continues his detailed remarks on sun-spots and faculæ observed by him at Palermo in 1873. The spectral lines of the prominences in the neighbourhood of faculæ are also fully given, the lines which appear to have been seen in nearly every eruption are D,  $\delta^1 \delta^2 \delta^3 \delta^4$ , 4,943, 5,031, and 5,316; the other lines less frequently seen are 5,203, 5,272, 5,282, 5,226, 5,232, 5,234, and 5,195.

Oct. 1875.—Prof. Tacchini gives a note on his observations in the previous number, and remarks the greater number of eruptions of magnesium on the western limb than on the eastern; the numbers on the former being more than double those on the eastern. The actual numbers for each month in 1873 are given. The number of eruptions in the northern and southern hemispheres are equal to each other. The zones of maximum eruptions appear to be between N. lat.  $10^\circ$  and  $20^\circ$ , and S. lat.  $0^\circ$  and  $10^\circ$ .—Communications from Father Secchi, Prof. Dorna, and Prof. Tacchini on the partial solar eclipse of Sept. 29, 1875. It is remarkable that the first contact was observed by the spectroscopic method some seconds later than by the simple telescopes, and the last contact several seconds earlier.—Drawings of the solar prominences during the months of May and June 1874 by Secchi and Tacchini accompany this number.

*Zeitschrift der Oesterreichischen Gesellschaft für Meteorologie*, Dec. 1, 1875.—The concluding part of Herr Wild's paper on the late congresses appears in this number. Against what has been said of these gatherings, that their sole result would be the accumulation of millions of useless observations upon the millions that have already been published, he contends that in his opinion observations are useless only when they are faulty and inaccessible; and that he has found himself hampered, not by their great quantity, but by their deficiencies, inconvenience of form, or variety of arrangement. It is true that out of millions of figures perhaps only some thousands prove of value to the investigator; but who can decide which will and which will not eventually be used? Registers intended for publication are submitted to a more careful revision than those preserved only



in manuscript. Indeed, Dr. Wild would almost lay it down as a rule that unpublished observations should be deemed scientifically useless. As to congresses, he does not think that they should be occupied with discussions on the laws of meteorology. The derivation of laws from observations should be looked for in the undisturbed thoughtfulness of individuals. Experience shows, however, that private persons do not employ themselves as much as formerly in working out observations, and it seems to be absolutely necessary for the advancement of meteorology that every official observer should be given sufficient time, beyond that required for mechanical work, for developing the science as far as his powers will permit, and that the central institutions should be adequately endowed for this purpose.—The next paper is a review, by Dr. Hann, of the publications of Messrs. Fjord and Paul la Cour on the climate of Denmark, which contain very valuable statistics in the decennial means of fourteen stations. As in other similarly situated countries, both the heat of summer and the cold of winter are more intense inland than on the coasts, and in July the most easterly stations are the warmest. The mild weather of spring seems to advance from S.W. to N.E., and the cool weather of October from N.W. to S.E. Thus the mean temperature of 8° is reached in N.W. Jütland on the 11th, in Bornholm and the northern extremity of Rügen between the 23rd and 24th of October. The mean monthly range of temperature is greatest in May, least in January; from April to August the maxima rise higher above the monthly mean than the minima sink below it; from September to March the relation is converse. The absolute maximum range was registered in July, the absolute minimum in November. The average number of days on which frost occurs is ninety-two; time of maximum rainfall the latter end of August and beginning of September; of minimum, the beginning of April. Yearly mean rainfall—in Denmark, 604 mm.; on the west coast of Jütland, 670 mm.; at Copenhagen, 587 mm.; Bornholm, 580 mm.. A small table inserted here by Dr. Hann gives a great deal of information as to days on which rain fell, and on which thunderstorms, hailstorms, fog, and cloud occurred. January is the cloudiest, May and July are the least cloudy of months. Tables showing the frequency per cent. of the different winds and the monthly barometric pressure close Dr. Hann's summary of the valuable work under review.—In the *Kleinere Mittheilungen*, Dr. Gustav Hellmann states the chief results of his inquiries into the distribution of thunderstorms in Northern Germany. In general the annual mean number of thunderstorms in Germany increases from N.E. to S.W. It is least on the coasts of the Baltic, particularly in East Prussia greatest in the district of the Upper Rhine. On the eastern coast of the Baltic about twelve are observed in the year; on the western coast of the Baltic, sixteen; and on the coast of the North Sea, fifteen. Inland, the number averages twenty. They increase in number with increasing altitude, up to about 1,400 m., then decrease rapidly. Winter thunderstorms are much more common in Northern Germany than in Austria and Hungary.

## SOCIETIES AND ACADEMIES

### LONDON

Royal Society, March 30.—“An Experiment on Electro-Magnetic Rotation.” By W. Spottiswoode, M.A., Treas. and V.P.R.S.

The phenomena of the rotation of movable conductors, carrying currents, about lines of magnetic force, are well known. One form of experiment, commonly called the rotating spark, presents, beside the actual rotation, some peculiar features which do not appear to have been noticed in detail.

The spark, when carefully observed, is seen to assume a spiral form; and the spiral is right-handed or left-handed according to both the direction of the current and the magnetic polarity. This effect is particularly noticeable if the magnetic pole be inserted only a short distance beyond the ring. The discharge is then seen to spread itself out sheetwise on the ring in the direction in which rotation would take place. The edge of the sheet is in the form of a helix.

The object of the following observations is to bring out the character of this phenomenon by making it a principal instead of a secondary feature of the experiment.

The arrangement here described consisted in using the poles of an electro-magnet as the terminals of a discharge from an induction-coil, and in observing the effect on the form of the discharge caused by exciting the electro-magnet. For this purpose the movable poles were insulated from the main body of

the magnet by interposing a sheet of ebonite thick enough to prevent the passage of the discharge. The discharge was then effected either in the open air or in a closed chamber. The latter was constructed of a short cylinder of glass, say 3 inches in length and 2 in diameter, having conical ends pointed inwards, so as to receive the poles of the magnet. The chamber was also furnished with a pipe and stop-cock for the purposes of exhaustion.

The discharge from an induction-coil taken in air or other gas at atmospheric pressure, consists, as is well known, primarily of the spark proper or bright line, irregular in form and instantaneous in duration. But beside this, when the primary wire is thick and the battery-current strong, the spark is enveloped in a bright cloud, or rather flame, which is capable of being thrown on one side, although not entirely detached from the spark by a current of air. This, when examined in a revolving mirror, is found to be subsequent in time to the spark proper, and may be considered to be due to the gas in the neighbourhood of the spark becoming sufficiently heated to conduct part of the discharge, and to the consequent combustion of any extraneous matter floating in the medium. Such a view is supported by the fact that the colour of this flame depends partly upon the nature of the gas in which the discharge takes place, and partly upon that of any volatilisable matter which may be introduced near the poles.

The exciting of the magnet produces upon the spark proper no appreciable effect; but as soon as the flame is submitted to its action it is spread out into a sheet, which arranges itself in a helicoid right-handed or left-handed according to the direction of the current and of the magnetic polarity in obedience to Ampère's law.

Effects substantially the same are produced whether the discharge be taken in gas at atmospheric or at a less pressure. But in the former case the helix has a lower, in the latter a steeper gradient; that is to say, in the former case it presents a greater, in the latter a less number of turns, for a given interval between the poles.

Various gases were tried—atmospheric air, carbonic acid, ether, chloroform, coal-gas, hydrogen. Of these the first two succeeded best. With air the illumination of the flame-sheet was rather greater; but with carbonic acid greater steadiness of position was obtained. With both ether and chloroform, occasional flashes, brilliantly illuminated, were seen; but some chemical action appeared to take place militating against the steady development of the flame-sheet. With coal-gas there was an inconvenient deposit of carbon upon the sides of the chamber. With hydrogen the cloud was not sufficiently developed.

The success which attended the experiment with air may possibly be partly due, as suggested above, to the combustion of the extraneous matter floating therein; and in fact the brilliancy and extent of the sheet may be increased by attaching a piece of metallic sodium to the negative terminal, or by causing a stream of any of the chlorides in powder, e.g., of strontium, lithium, &c., to flow across the field of action.

When a piece of sodium (or better still of soda) is attached to one of the terminals, two effects may be noticed. When that terminal is negative the whole of the flame is bright yellow, showing that the sodium is not only detached but even carried across the field and deposited on the positive terminal. When, however, the terminal, to which the sodium is attached is positive, it is found that the flame, when observed through a red glass, appears yellow to a certain distance from the (positive) terminal to which the sodium is attached, but red beyond; and also that the pitch of the helix is less near the position than near the negative terminal. These effects may be attributed to the presence of metallic vapour evolved by the heat at the positive terminal, but not carried across the field as when the terminal in question is negative.

The following explanation of the phenomenon, from which the mathematical part is omitted, is due to Prof. Stokes. Supposing the magnetic field to be uniform, the lines of force will be straight lines from pole to pole. In such a condition everything being symmetrical no rotation would take place. But if through any local circumstance the path of the current be distorted and displaced, then each element will be subject to two forces, one tending to turn the current round the axis, the other tending to make it follow the shortest path so as to diminish the resistance.

The general nature of the phenomenon may be described as follows:—“First, we have the bright spark of no sensible



duration which strikes nearly in a straight line between the terminals. This opens a path for a continuous discharge, which being nearly in a condition of equilibrium, though an untranslatable one, remains a short time without much change of place. Then it moves rapidly to its position of equilibrium, the surface which is its locus forming the sheet. Then it remains in its position of equilibrium during the greater part of the discharge, approaching the axis again as the discharge falls, so that its equilibrium position is not so far from the axis. Thus we see two bright curves corresponding to the two positions of approximate rest united by a less bright sheet, the first curve being nearly a straight line, and the second nearly a helix traced on a cylinder of which the former line is a generating line.

"It was noticed that the sheet projected a little beyond the helix. This may be explained by considering that at first the discharge is more powerful than can be maintained, so that the curve reaches a little beyond the distance that can be maintained."

The appearance of the discharge when viewed in a revolving mirror (except the projection beyond the sheet, the illumination of which was too feeble to be observed) confirmed the above remarks.

Linnean Society, April 6.—Prof. G. Busk, vice-president, in the chair.—S. P. Agar, the Rev. R. F. Clarke, W. R. Guilfoile, Prof. H. A. Nicholson, J. Scully, and W. Waterfield were elected Fellows of the Society.—Dr. Day exhibited a Kingfisher and Unio, the former having been drowned by closing of the valves of the latter.—Mr. E. M. Holmes laid before the Society some rare mosses obtained in Kent. The localities, &c., of *Anacalypta caespitosa*, *Seligeria paucifolia*, *Hypnum silesiacum*, *Dicranum montanum*, and *D. flagellare* were specially commented on.—Mr. Holmes also showed the root of *Thapsia garganica* var. *siphium*, which is said to possess a remarkable power of healing wounds; though a fatal root to horses and camels.—G. J. Romanes read an account of some new species, varieties, and monstrous forms of Medusæ (see p. 496).—Dr. Francis Day read a paper on some of the fishes of the Deccan, more particularly describing and critically treating of between fifty and sixty species, a few of which are new. Besides geographical range, questions of physiological import are touched on. He strongly recommends the "Masheer" (*Barbus tor*), to English pisciculturists as worthy of introduction into our rivers. This fish is well known, not only for the sport it affords the angler, but also for the excellence of the flavour of its flesh. It equals or even surpasses the salmon in size, but unlike the latter never enters salt water. It deposits its ova in the hill-streams. For these and other reasons he believes it well adapted for acclimatization.—A second paper of Dr. Day's referred to the introduction of Trout and Tench into India. He stated it may now be concluded that the Loch Leven Trout (*Salmo leuensis*), and the Tench (*Tinca vulgaris*), have bred there, and may prove an eventual success. A specimen of the Loch Leven trout reared in the Neigherry waters was exhibited at the meeting. Its weight out of spirit 1½ oz.; its greatest length 6½ inches. Mr. Thomas, of the Madras Civil Service, in 1863, and Dr. Day in 1866, each attempted but unsuccessfully to carry out and hatch Trout ova in India; it was reserved for Mr. McIvor a few years later to succeed. The latter, in 1873, wrote, "all our fish are breeding rapidly," &c. The above specimen was caught January 1876. Dr. Day moreover remarks "whether trout will permanently succeed in Hindostan has yet to be solved."—Mr. C. H. Wade read some notes on the venous system of birds. These contained observations relating to abnormalities in their distribution in certain of our British songsters.—Dr. G. E. Dobson communicated a paper of Dr. J. D. McDonald's, on a new genus of trematoda, and some new or little known parasitic hirudinae. Resemblances between these groups are traced, though these are merely indicative of a representative relationship or one of analogy.—A paper entitled notes on Lowe's MS. list of Webb's type shells from the Canaries (1829), and on the annotations thereon of D'Orbigny (1839), and Lowe (1860), by the Rev. R. B. Watson, was briefly noticed by the secretary.—The following technical contribution was taken as read: A list of marine shells (ninety-five in all) chiefly from the Solomon Islands, with descriptions of several new species, by E. A. Smith.

Chemical Society, April 6.—Prof. Abel, F.R.S., president, in the chair.—The first paper read was a preliminary notice on the action of sulphuric acid on naphthalene, by Dr. J. Stenhouse and Mr. C. E. Groves. From amongst the products of the

reaction the authors have succeeded in isolating two new isomeric compounds, which they call naphthalene sulphones.—Three notes from the Laboratory of the Yorkshire College of Science were then communicated by Prof. T. E. Thorpe, namely, On the action of the copper zinc couple on potassium chlorate and perchlorate, by Mr. H. Eccles; On thallium chlorate, by Mr. J. Muir; and On the isometric relations of thallium, by Mr. Thorpe himself.—Finally, Dr. H. E. Armstrong read a paper on the nomenclature of the carbon compounds, the discussion of which was adjourned until the next ordinary meeting, which will be on Thursday, April 20.

Zoological Society, April 4.—Prof. Newton, F.R.S., vice-president, in the chair.—Mr. H. E. Dresser exhibited and made remarks on a specimen of a hybrid between the Black Grouse and Hazel Grouse, belonging to Mr. J. Flower, and supposed to have been obtained in Norway. It had been purchased in the flesh in the London market.—Prof. Newton exhibited and remarked upon a copy of a Dutch translation of Pliny, containing a figure of the Dodo (*Didus ineptus*) and belonging to the Rev. Richard Hooper, which seemed to be an earlier edition of the same work which was formerly in the possession of the late Mr. Broderip, and was described by him in the Society's "Transactions" (vol. iv., p. 183).—Mr. R. Bowdler Sharpe exhibited a specimen of the true Swedish *Surnia ulula*, obtained many years ago at Amesbury, in Wiltshire, being the first recorded British-killed example of this species.—M. A. H. Garrod read a paper in which he gave a description of the organs and some of the most important muscles of the Darter (*Plotus ankinga*), from specimens which were recently living in the Society's collection.—Mr. Edward R. Alston read a paper on the genus *Dasyprocta*, and gave a description of a new species from Central America, for which the name *Dasyprocta isthmica* was proposed. The geographical range and synonymy of the other Agoutis were reviewed; *D. punctata* of Central America was regarded as distinct from *D. azarae* of South Brazil, and *D. variegata* was shown to extend into New Grenada. In all ten species of Agouti were recognised as distinct.—A paper by Mr. P. L. Sclater and Mr. O. Salvin was read, in which they gave descriptions of fifteen new species of birds from Bolivia. Amongst these was a singular new form belonging to the Tanagridæ proposed to be called *Malacothraupis dentata*.—A second paper by the same authors contained a revised list of the Neotropical Anatidæ.

Royal Microscopical Society, April 5.—Mr. H. C. Sorby, F.R.S., president, in the chair.—A paper by M. Rénard, of Louvain, "On some results from a microscopical study of the plutonic and stratified rocks of Belgium," was read and illustrated by some beautiful chromo-lithographs. The paper chiefly dealt with the question of temperature at which these rocks had been formed, and the conclusions deduced from the presence of crystals and fluid in the cavities assigned 307° Centigrade as the probable heat at that period. The chairman expressed his great satisfaction that by a totally different process of reasoning M. Rénard had arrived at results so near to those which he had himself reached some years ago.—A paper by M. Brock, "On a new slip for mounting opaque objects," was communicated to the meeting by Prof. Rupert Jones.—A paper by Dr. J. J. Woodward, "On the markings of *Navicula rhomboides*," was read to the meeting by the Secretary. It was illustrated by a series of photo-micrographs, which deservedly called forth the admiration of all who examined them.

Anthropological Institute, March 28.—Col. A. Lane-Fox in the chair.—Mr. R. B. Swinton, was elected a member.—Capt. H. Dillon exhibited a collection of flint implements and arrow-heads recently made by him in the neighbourhood of Dytchley, Oxon.—Mr. E. B. Tylor, F.R.S., read a paper on Japanese mythology. The legends current in Japan are derived from three sources. Part belong to imported Buddhism, part are taken from Chinese mythology, and the remainder, to the ethnological interest of which the present paper called attention, are of native Japanese origin. It contains nature-myths of remarkable clearness, but distinct in their features from those of India, Greece, &c. Thus the episode of the Land-forming-god, who springs from the *asi* or flag which binds together the new-found marshy coast-land of Japan, belongs to what is, in fact, geology expressed in mythic language. Again, the birth of the Sun-goddess, and her transference to the sky as Ruler of Heaven, is followed by a graphic story of the visit paid to her by her brother, who is no doubt the personified Wind or Tempest, as



he is described as mild and gentle when unprovoked, and always with tears in his eyes (*i.e.*, rain), but when resisted he bursts into uncontrollable fury, uprooting trees and devastating the world. Frightened with his violence, his sister, the Sun-goddess, retires into a cave in the sky, closing the entrance with a rock, and leaving the world in darkness. By the advice of the god of Thought, a fire is kindled and dances performed outside, and the sacred mirrors and pieces of cut paper (*go-hei*) which still form the furniture of a *Sin-to* temple, are displayed. The Sun peeps forth, and is then pulled out altogether, and the cave closed. The whole episode is evidently a mythic picture of the Sun hidden in tempest in the clouds as in a cavern, till she comes forth again to enlighten the world.—A paper on the term "Religion" was read by Mr. Distant. He said that the possession or non-possession of religion, and the nature of the religion possessed were usually made by our leading anthropologists tests of development in civilisation and culture. But accounts are often untrustworthy, and depend upon the bias of the inquirer. Also, "Religion" is an undefined term; scarcely two writers on culture agreeing on the subject. Indeed, some of the religious ideas of savages are found to be held by eminent men. A term required to be used, that was alike capable of being conceived and incapable of being misunderstood.—In the discussions Mr. Tatui Babo, Mr. Conway, Mr. Moggridge, Mr. Bouverie Pusey, Mr. Jeremiah, and others, took part.

Institution of Civil Engineers, March 28.—Mr. Geo. Rob. Stephenson, president, in the chair.—The first paper read was on sewage interception systems, or dry-sewage processes, by Mr. Gilbert R. Redgrave.—The second paper read was on the treatment of sewage by precipitation, by Mr. W. Shelford.

PARIS

Academy of Sciences, April 10.—Vice-Admiral Paris in the chair.—The following papers were read:—Experimental critique on the formation of sugar in the blood, or the function of physiological glycaemia, by M. Cl. Bernard.—Analytical solution of the problem of distribution in a magnet, by M. Jamin.—Vegetation of maize commenced in an atmosphere without carbonic acid, by M. Boussingault. The grain, germinating, produces a fertile atmosphere (*i.e.*, one containing carbon), in which, with aid of light, the leaves organise chlorophyll, and then amylaceous and saccharine matters.—Verbal observations on the same subject, by M. Pasteur.—Seventeenth note on the electric conductivity of substances that are mediocre conductors, by M. Du Moncel. The substances here studied are the stems of certain shrubs, and the human body. The conductivity of the former varies with the mode of application of the electrodes, the nature and thickness of the bark, and the season. The resistance of the human body between the wrists is estimated at 350 to 220 kilometres. But when the skin is dry, and at the commencement of an experiment, it may exceed 2,000 kilometres.—Experiments on the schistosity of rocks; geological consequences that may be deduced, by M. Daubrée. The geometrical arrangement of the leaves of crystalline masses and Jurassic layers above them in various central formations of the Alps (Mont Blanc), are explained, through experiment, as the effect of flow of a mass which was not completely solid.—Discussion of barometric curves continued from March 7 to 14, 1876; best process for comparing the course of the temperature and the pressure, by M. Sainte-Claire-Deville.—On the *trombe* of Heiltz-le-Maurupt (Marne), Feb. 20, 1876. Two persons witness that the *trombe* descended; the windows of the town-hall were broken inwards, which is against the suction-hypothesis, as is also the fact that the circle of mechanical action was very distinctly circumscribed.—On the displacement of lines in the spectra of stars, produced by their movement in space (continued), by P. Secchi.—M. Borchardt was elected correspondent of the Academy in the section of geometry, in place of M. le Besgue.—Velocity of thermal flow in a bar of iron (second part), by M. Decharme.—On the solar spots and the physical constitution of the sun, by M. Planté. A horizontal sheet of filter paper, moistened with salt water, is connected above with the negative pole of the secondary battery; on bringing up towards it from below the positive electrode, a crater-like cavity is formed with torn edges projecting towards the + electrode (light and vapour also being emitted); and the aspect is very much that of sun-spots. M. Planté also studied the incandescent globules obtained in fusing thick metallic wires with a strong electric current of quantity, and draws a parallel between their structure and that of the sun.—Influence of the asparagine contained in saccharine juices (of beet and cane) on the saccharimetric test;

destruction of the rotatory power of asparagine; method of determination, by MM. Champion and Pellet.—The elephants of Mount Dol; attempt at organogeny of the system of molat teeth of the mammoth (second communication), by M. Sirodot.—On the optical effects of lamellar snows floating horizontally, by M. De Fonvielle.—On the catastrophe of Grand Sable (district of Salazie) in the Isle of Reunion; second note by M. Vinson. He endeavours to show it was the work of subterranean fire, which prepared a normal eruption that followed.—Letter from M. Cassien on the same subject; he rejects the idea of volcanic action.—On the catastrophe of the Jabin pits (Feb. 4, 1876), by M. Riembault. Fine coal-powder, suspended in air, is explosive. In the Jabin pits a little fire-damp was probably first inflamed at a point, and this ignited the coal-powder, which, under high temperature, liberates its explosive gases. The galleries were found incrustated with coke, evidently the result of combustion of coal. The air of the miner's lungs, forming part of the explosive atmosphere, is inflamed with it.—On the hatching of the winter egg of *Phylloxera*; note by M. Balbiani. He succeeded in observing a young *Phylloxera* (April 9) immediately after hatching. He regards it as a fourth specific form of the animal.—On a compensating balance wheel for marine and other watches, by M. Winnerl.—On the theory of the proof plane, by M. Bouty.—Note on the coloured rings produced by pressure in gypsum, and on their connections with the coefficients of elasticity, by M. Janetaz.—On the employment of Gramme's magneto-electric machines for lighting the large halls of railway stations, by M. Sartiaux.—Simple apparatus for the analysis of gaseous mixtures by means of absorbent liquids, by M. Raoult.—On exchange of ammonia between natural waters and the atmosphere, by M. Schloesing.—On the products of reduction of anethol, and on the probable constitution of this substance, by M. Landolph.—On change of the volume of organs in its relations to circulation of the blood, by M. Franck.—Researches on the functions of the spleen, by MM. Malassez and Picard. Iron appears to be, in the spleen, purely and simply in the state of hæmoglobin the same as that of the blood.—The physiological relations between the acoustic nerve and the motor apparatus of the eye, by M. Cyon.—On the embryology of *Nemertina*, by M. Barrois.—Osteological characters; observations on the persistence of the intermaxillary in man, by M. Roujou.—Action of sulphide of carbon on an insect which attacks the plants of herbaria, by M. Schnetzler.

BOOKS RECEIVED

BRITISH.—Geological Sketches: L. Agassiz (Trübner and Co.)—The Secret of the Circle, its Area ascertained: Alick Carrick (Henry Sotheran and Co.)—The Intellectual Development of Europe: J. W. Draper, 2 vols. (George Bell and Sons).—Sport in Abyssinia: Earl of Mayo (John Murray).—The Year-Book of Facts, 1876: C. Vincent (Ward, Lock, and Tyler).—Animals and Plants under Domestication, 2nd edition: Charles Darwin, 2 vols. (John Murray).—Vital Motion as a Mode of Physical Motion: Dr. Radcliffe (Macmillan and Co.)—Philosophy without Assumptions: T. P. Kirkman, F.R.S. (Longmans).—Diseases of the Nose: Spencer Watson, F.R.C.S. (H. K. Lewis).—Discoveries in New Guinea: Capt. John Moresby (John Murray).—Problems and Examples in Physics, an Appendix to Gauss's Elementary Physics (Longmans).

CONTENTS

CAMPBELL'S "CIRCULAR NOTES." By J. W. J.	431
SCLETZER'S "GEOGRAPHICAL ZOOLOGY"	432
OUR BOOK SHELF:—	
Works on Curve-tracing	433
Dammer's "Chemical Dictionary"	434
Baker's "Clouds in the East"	435
LETTERS TO THE EDITOR:—	
The Use of the Words "Weight" and "Mass."—J. J. WALKER	436
"The Recent Origin of Man"—JAMES C. SOUTHALL	437
"The Unseen Universe."—JOSIAH EMERY	438
Prof. Tait on the Earth's Age.—Prof. J. D. EVERETT	439
A Relapsed Donkey.—Dr. E. BONAVIA	440
OUR ASTRONOMICAL COLUMN:—	
Variable Stars	441
The Search for Comets	442
TO FIND EASTER	443
HUNTERIAN LECTURES ON THE RELATION OF EXTINCT TO EXISTING MAMMALIA, VII. By Prof. FLOWER, F.R.S.	444
UNIVERSITY COLLEGE, BRISTOL	445
THE USE OF YELLOW GLASS FOR ZOOLOGICAL COLLECTIONS	446
RADIOMETERS. By W. CROOKER, F.R.S.	447
COMPRESSED AIR LOCOMOTIVE USED IN THE ST. GOTHARD TUNNEL	448
WORKS (With Illustrations)	
PHYSICAL SCIENCE IN SCHOOLS. By Dr. WATTS; Rev. GEORGE HENSLOW	449
NOTES	
ABNORMAL MULTIPLICATION AND ABORTION OF PARTS IN MEDUSÆ.	
B. J. G. ROMANES	450
SCIENTIFIC SERIALS	451
SOCIETIES AND ACADEMIES	452
BOOKS RECEIVED	453







Nature April 1871



*Portrait of Mr. Thomas*

*as drawn from a photograph by G. S. ...*

*London published by Cassell & Co.*

THURSDAY, APRIL 27, 1876

## "SCIENTIFIC WORTHIES"

VII.—SIR CHARLES WHEATSTONE, BORN FEBRUARY  
1802, DIED OCTOBER 19, 1875

CHARLES WHEATSTONE was the son of a music-seller at Gloucester, where he was born in February 1802, and was educated at a private school in that city. His father afterwards came to London, where he became a teacher of the flute. He had, we believe, some share in the musical education of the Princess Charlotte, a fact of which he was never tired of boasting. In 1823 young Wheatstone removed to London and commenced business as a musical instrument maker, and in the same year made what was probably his first contribution to scientific literature in a paper entitled "New Experiments on Sound," contributed to Thomson's "Annals of Philosophy." In 1827 he contributed to the *Quarterly Journal of Science* an account of "Experiments on Audition," and a description of the beautiful toy known as the Kaleidophone. In 1832 he read an important paper to the Royal Society, "On the Acoustic Figures of Vibrating Surfaces." In this memoir the author gave for the first time the laws of formation of the varied and beautiful figures discovered by Chladni. He continued for several years to devote his attention to Sound, and subsequently to Light. He was appointed Professor of Natural Philosophy in King's College, London, in 1834, and in the same year made his celebrated experiments on the velocity of an electric discharge by the aid of revolving mirrors. Wheatstone does not seem to have lectured regularly at King's College, and many of his discoveries were described to the world by Faraday at the Royal Institution. Indeed he was not well adapted for public lecturing; he was so nervous that even in a very small company he usually sat silent. Though his discoveries have become of such immense practical importance, Wheatstone himself was far from being a practical business man; on this account he often failed to reap the substantial fruit of his discoveries. Wheatstone was married on Feb. 12, 1847.

Wheatstone's name is intimately connected with the early history of Spectrum Analysis. In a paper read in 1835, "On the Prismatic Analysis of Electric Light" at the Dublin meeting of the British Association, he announced the existence of rays of definite refrangibility, emitted in the volatilisation of metals by the electric spark. He showed that the spectrum of the electric spark from different metals presented each a definite series of lines differing in colour and position from each other, and that these appearances afforded the means of distinguishing the smallest fragment of one metal from that of another. "We have here," he wrote, "a mode of discriminating metallic bodies more readily than that of chemical examination, and which may hereafter be employed for useful purposes." These last words furnish the keynote to all Wheatstone's work; however valuable may be the services he has rendered to pure science, his great ultimate aim was the useful and practical. It was at

the meeting of the British Association in 1838 that he described and exhibited the newly-invented stereoscope, and at the 1848 meeting he described his "polar clock," an instrument for ascertaining the time by means of the change in the plane of polarisation of the light of the sky in the direction of the pole. One of these instruments, we believe, has been sent out with the Arctic Expedition. Wheatstone's description of the rheostat, and of the well-known "bridge" which bears his name, is printed in the *Transactions of the Royal Society* for 1843. Indeed, it is a popular error to suppose that Wheatstone's scientific fame rests solely on his connection with the electric telegraph; he would have deserved an honourable place in the annals of science had this practical application of electricity been yet undiscovered. In the Catalogue of the Royal Society alone will be found the titles of upwards of thirty papers by him, not to mention many others scattered about in various publications.

The President of the Italian Society of Science, of which he was made an honorary member in 1867, said, in conferring the honour, that the applications of the principle of the rotating mirror are so important and so various that this discovery must be considered as one of those which have most contributed in these latter times to the progress of experimental physics. "The memoir on the measure of electric currents and all questions which relate thereto and to the laws of Ohm has powerfully contributed to spread among physicists the knowledge of these facts and the mode of measuring them with an accuracy and simplicity which before we did not possess. All physicists know how many researches have since been undertaken with your rheostat and with the so-called 'Wheatstone Bridge,' and how usefully these instruments have been applied to the measurement of electric currents, of the resistance of circuits, and of electro-motive forces."

With regard to the scientific value of the revolving mirrors, M. Dumas spoke as follows in the address which he gave at the obsequies of Wheatstone in Paris:—"This admirable method enabled Arago to trace with a certain hand the plan of the fundamental experiment which should decide whether light is a body emanating from the sun and stars or an undulating movement excited by them. Executed by an accomplished experimenter, it proved that the theory of emission was wrong. This method has then furnished to the philosophy of the sciences the certain basis on which rest our ideas of the nature of the forces, and especially of that of light. By means of this or some other analogous artifice, we can even measure the speed of light by experiments purely terrestrial, which, pursued by an able physicist, have guided the measure of the distance between the earth and the sun."

As to Wheatstone's connection with the electric telegraph, it is unnecessary for us here to speak, as this was so fully gone into in the series of articles on "The Progress of the Telegraph," in vols. xi. and xii. of NATURE. De la Rive, in his "Treatise on Electricity," (Part VII., Chap. I.), states so fairly Wheatstone's connection with telegraphy, that we quote here what he says:—

"The philosopher who was the first to contribute by his labours, as ingenious as they were persevering, in giving to electric telegraphy the practical character that it now



possesses, is, without any doubt, Mr. Wheatstone. This illustrious philosopher was led to this beautiful result by the researches that he had made in 1834 upon the velocity of electricity—researches in which he had employed insulated wires of several miles in length, and which had demonstrated to him the possibility of making voltaic and magneto-electric currents pass through circuits of this length. It was in 1837, in the month of June, that Mr. Wheatstone took out his first patent. He first employed five conducting-wires, between two distant stations, acting upon five magnetised needles, the movements of which, being combined two and two, were enabled to produce several different signs. Mr. Wheatstone, at this time, entered into partnership with Mr. Cooke, who had likewise devised an ingenious telegraphic apparatus founded upon the same principles. The English philosophers, from the very first, had added to the telegraph—properly so called—an apparatus intended to call the attention of the observers, and designated under the name of *Alarm*. . . . The principle upon which this alarm is founded includes an immense number of applications, for it enables man to put in action—at any distance whatever—all the forces of mechanics, in an instantaneous manner. Indeed, more recently, Mr. Wheatstone applied it to the construction of his dial telegraph; and it is the same principle which serves as the basis of Morse's telegraph, invented at nearly the same period."—*De la Rive*, Part VII. Chap. I.

We may repeat here a fact which does not appear to be generally known or recognised, that Wheatstone was the first suggester and worker at submarine telegraphy. From documents before us we learn that so early as 1837 he was thinking much on and was greatly interested in the subject; and in February, 1840, he stated his opinion before a Select Committee of the House of Commons as to the practicability of establishing electric communication by means of a cable between Dover and Calais.

Wheatstone's applications of electricity were almost innumerable. His electric clocks are well known; various electric registers were invented by him, one especially for recording a variety of meteorological data, and another, which acts as a chronoscope to register the velocity of a bullet. Indeed, his ingenuity was marvellous, and, as we have already hinted, there are doubtless many useful inventions due to him, of which he has reaped neither the profit nor the credit.

Wheatstone received many "honours" during his lifetime. He was made a Fellow of the Royal Society in 1836, in 1868 he was knighted, in 1873 he was elected a foreign member of the Paris Academy, and had altogether upwards of thirty foreign distinctions. The following estimate of Wheatstone and of his contributions to science is from the pen of Signor Paul Volpicelli, the distinguished Italian electrician.

The Academy of Sciences of the Institute of France, at its *séance* of October 18, 1875, was informed by the perpetual secretary, M. Dumas, that the illustrious English physicist, Charles Wheatstone, was seriously ill in Paris at the Hôtel du Louvre. By the 17th of the month, however, fears for the safety of that *savant* were well nigh vanished, and it was believed that he would

soon be completely restored to health. The hope unhappily proved fallacious; an aggravation having occurred in the pneumonitis, which was thought to have been overcome, carried off that distinguished physicist on the 19th of the month from his friends and from science.

Our Reale Academia dei Lincei was profoundly afflicted at this irreparable loss, which deprived it for ever of one of the most celebrated of its foreign correspondents, who was and will continue to be one of the proudest and most pure scientific glories, not only of England, but of the whole civilised world, since science does not know nationalities, but belongs to all countries.

The brilliant Wheatstone inevitably became possessed of all those honours which science is wont to confer on her eminent votaries, and in 1875 he obtained from the Academy of Sciences of the Institute of France a title of the highest distinction, that, viz., of one of the eight Foreign Associates. Among the cultivators of physics the name of Wheatstone will never be forgotten; neither the present nor the future can forget his rare penetration, the inventiveness of his genius, his discoveries, and the uncommon ability with which he reproduced in machines the phenomena of nature.

His name will be as that of a star to whose light will turn the minds of those who desire to comprehend the progress of physical doctrine. In doing honour to the memory of this our illustrious foreign correspondent, it will be best to record his scientific labours, which are all of the highest interest.

In the present short obituary notice we shall merely give a rapid sketch of the principal physical researches of the illustrious deceased.

Our countryman, Leonardo da Vinci, in 1500, or thereabouts, conceived and was the first to affirm, that from a picture it was not possible to obtain the effect of relief. But Wheatstone, reflecting profoundly in 1838, on the physiology of vision, invented the catoptric stereoscope, with which he philosophically solved the problem of the optical and virtual production of relief.

This instrument was a converted *dioptric* of the father of modern optics, the distinguished Brewster, and at the same time was more simple, more popular, and more elegant. Continuing to study the physiology of vision, Wheatstone succeeded in constructing the diaphragmatic stereoscope, *i.e.* without mirror and without lenses, but merely with a diaphragm. With this instrument there could be received coexistently on the retina three images, two, viz., one photographic, and one in relief, produced from the first two.

The diaphragmatic stereoscope manifested, better than the two others, the physiology of vision; it was published in the "Atti dell. Accademia Pontificia dei Nuovi Lincei," t. vii. p. 219, and in the work entitled "Monographie du Stereoscope," by H. De la Blanchère (Paris, 1861), as also in the *Cosmos*.

The use of the stereoscope, whether catoptric, dioptric, or diaphragmatic, would have remained pretty restricted, if photography had not come in to greatly extend that use, in its application to industries, arts, and sciences.

When one undertakes to study the hyperoptics, it often happens that the vibrations of the molecules of ether, constituting a luminous wave, are found difficult to conceive.



To remove this difficulty, Wheatstone invented a very ingenious apparatus, by which the vibratory motions of the luminiferous ether could be represented with considerable fidelity, and especially the phenomena of polarisation, whether rectilinear, circular, or elliptic.

Many were the achievements realised by Wheatstone in applying himself to optics: we owe to him the invention of a kaleidoscope, in which the persistence of impressions on the retina was utilised in demonstrating the transversal vibrations of an elastic rod fixed at one of its extremities; we owe to him one of the most sensitive photometers, as also the way of estimating the duration of lamps, the movements of the sea, and the ramifications of the retina; the difference between the solar and the electric light, and the lines of the light obtained from combustion of bodies brought to the poles of the voltaic battery. He was, further, the inventor of the polar clock, an instrument designed to indicate the hours through observation of the plane of polarisation of light of the blue sky in the region of the North Pole. That instrument, improved by Soleil, was marvellously adapted for finding the neutral points of Arago, Babinet, and Brewster.

The science of acoustics also profited by the valuable researches of our Lincean correspondent, for he experimented on sound and on hearing, devised his kaleidophone, occupied himself with resonance or reciprocal vibrations produced by a column of air; he also studied the transmission of musical sounds, and the figures obtained with sand on a vibrating surface, or acoustic figures.

Moreover, he cultivated, with great advantage to science, electro-dynamics; and devised two rheostats, one for great, the other for small resistances.

We are indebted to the illustrious deceased for many other scientific contributions, which have realised a notable progress in various branches of modern physics, and especially in telegraphy. Among these contributions, which time would fail fully to enumerate, we must not omit to speak of the method, so fruitful of valuable consequences, by which Wheatstone determined the velocity of the electric discharge in a metallic wire.

He was likewise skilled and practised in ballistics; and he employed the uniform rotation of two pasteboard discs, fixed on a common horizontal axis passing through their centres, to ascertain the initial velocity of a projectile fired from a gun. The projectile, traversing with uniform velocity these rotating discs, produced within two holes, the different situations of which afforded a means of determining the initial velocity of the ball.

Wheatstone was the first to employ the rapid rotation of a reflecting disc for measuring the velocity of propagation of an imponderable agent, without resorting to great distances, such as the planetary. After having in vain turned the spark-exciting organ round an axis, hoping to be able to increase the extent of sparks, and also to alter their direction, according to the direction of turning, he conceived the idea of communicating to a reflecting disc or plane mirror a very rapid rotatory action, by which the electric spark produced at a certain distance from the disc might be reflected.

The interesting consequences derived from these experiments are—(1) that electricity takes an appreciable time in traversing a distance, whence may be inferred approxi-

mately the velocity of the electric current; (2) that this velocity does not depend on the direction of the electric current; (3) that of three sparks, reflected by this means, in the same horizontal direction, the two lateral ones appear contemporaneously, but the middle appears retarded with respect to the first, which fact is not reconcilable with the hypothesis of Franklin on the nature of electricity; (4) that the same method was adopted by the celebrated Arago, whose experiments lead to a decisive judgment which of the two theories on the nature of light, that based on emanation, or that based on ethereal vibration, must prevail.

The fact that we now possess methods of determining the velocity of light so practical, elegant, and speedy as those of the distinguished physicists Fizeau and Foucault, is due to the method of rotating mirrors, which was introduced through this order of researches of the English physicist, of whom we deplore being for ever bereaved; the fame of whose discoveries is everywhere—

“And with the world itself shall still endure.”

Dante, *Inf.*, ii. v. 60.

P. VOLPICELLI

#### THE PROGRESS OF THE LOAN COLLECTION

VARIOUS are the trains of thought suggested by a visit to those galleries in which the science of the past and the present is being represented by so goodly an array of its working implements. If one has been at all in sympathy with the movement which is now so near its goal (and who that has in the least appreciated the progress and benefits of science can be out of sympathy with it?), it will, first of all, be truly gratifying to him to observe on every hand such manifest tokens of hearty co-operation in the movement. Even those who are engaged in marshalling the various treasures of the departments which have been entrusted to their charge seem to be animated with an unusual zeal (a zeal promising the best results), and, at first sight even, it is evident that the various museums and private collections in this country and on the Continent have been ransacked for some of their choicest contents to be sent to these South Kensington galleries, aiding the completion of an ideal which is true in its comprehensiveness. The nations of the Continent who were appealed to for their support of the scheme, have shown, many of them, by an activity which is beyond all praise, how warmly the proposal has been entertained. This is especially true of Germany. The Berlin Committee appointed a short time ago, and including some of the foremost names in science, while it gained also the useful accession of Imperial influence, promptly made application (the time was short) to the various Universities and Polytechnic Schools throughout the country, and they were met as promptly; so that soon quite a network of subordinate committees came into being, all working harmoniously towards the common end. The German contributions form a very considerable proportion of the whole; and they, in common with contributions from the Continent generally, are indeed surprising in their extent, if we consider the shortness of time allowed and the unique character of the exhibition. Both Germans and French have been doing all that they



can up to the latest moment, and this has somewhat retarded the arrangements. The Russian contributions have not yet been received. The collection of instruments from Italy is, in many respects, of a peculiarly interesting character.

A catalogue and a series of handbooks are in course of preparation. Some idea of the extent of the collections may be obtained from the fact that in the former there will be somewhere about 6,000 entries. The nature and value of the handbooks for the various departments may be learned from the fact that they are prepared by such men as Huxley, Henry Smith, Clifford, Maskelyne, Carey Foster, Guthrie, Clements Markham, Lockyer, and others. The entire work, extending to some 300 pages, in which the history and functions of the several instruments are dealt with, will be expounded in a clear and succinct manner.

It would be impossible, we imagine, to walk through those corridors and inspect the various objects encased on either hand, without soon beginning to marvel at the multiplicity and complexity of the tools which science has come to construct for herself in the progress of her inquiries; and at the degree of precision and skill to which she has at length attained, after many a tentative and faltering step towards the end in view. Yet it may truly be said, that as the branches and divisions of science multiply in increasing ratio, and therewith also the apparatuses become more and more complicated, the investigator, acquiring a deeper insight and wider range, ere long perceives a unity where he had not previously imagined it, and finds that many things which had seemed to be so many *dissecta membra* are knit together in the closest interrelations. It is perhaps not among the least benefits accruing from an exhibition like the present, that scientific men are enabled to survey, in close juxtaposition with their own line of research, other lines which they may have given little heed to, or but imperfectly comprehended. To an outsider also, who appreciates the keen enjoyment of scientific tastes, and is not hopelessly devoted to a hobby, the comparison cannot fail to be pleasant and instructive.

Again, that progress of science just referred to, from the less perfect to the more perfect, from the rough and clumsy to the finished and refined, in the construction of her instruments, affords a retrospect that is fascinatingly instructive. In the inspection of the collection one comes ever and anon upon some antiquated-looking instrument of plain proportions and great simplicity, which almost seems as though it had stumbled by mistake into the company of its elegant and brightly furbished conquerors—had come among a generation that knew it not. Yet these ancient relics have a deeply interesting history, and they will doubtless attract to themselves no small share of attention from the visitors who will take advantage, we trust, in large numbers, of the unique opportunities this exhibition affords. Nor would any contempt which might momentarily arise for the unpretentious and uncouth figure of these instruments be long in giving place to a sort of veneration and awe, for the story they have to tell that they took shape under the hand or at least under the thoughtful direction of a Galileo or a Herschel.

The general arrangement of the exhibition, which, as already mentioned, is by no means complete yet, may here be briefly indicated. The space occupied is in the West and South Courts. After passing through the South Court, in which stand the South Kensington Museum instruments, the Educational apparatus, and those relating to Applied Mechanics, the visitor enters the West Court, the northern portion of which contains the greater bulk of the present collection. Here in succession are arranged the departments of Magnetism and Electricity, Mathematics, Meteorology, and Astronomy. On proceeding upstairs and returning, the rooms devoted to Geography and Geology, Biology, Chemistry, and Physics, are successively passed through. This will indicate the general arrangement of the whole; but the classification of the various instruments in the catalogue now being prepared is considerably more detailed.

It is not our intention here to attempt anything like an exhaustive account of the various objects of interest which line these courts. In the Astronomical department will be seen several of Galileo's instruments, including two telescopes made by himself, one of which served for his most important discoveries and experiments. The object-glass is shown by which he discovered Jupiter's satellites, and first saw spots on the sun. The Reale Institute of Florence, to which the Exhibition is indebted for these instruments, has sent sundry other relics of the great astronomer, including a natural magnet, which he armed, and an air thermometer and microscope, which were his. Nor should we fail to be interested in such instruments as a quadrant of Tycho Brahé, some object-glasses and eye-pieces, which were mostly polished by Christian and Constantine Huyghens, and a telescope of Huyghens. A venerable wooden object near the wall is Sir W. Herschel's 7-foot telescope, both mirrors of which were finished by Sir William's own hands, and there is also shown a 10-foot reflecting Newtonian telescope also made by him. Several of Gravesande's instruments are shown; also the apparatus used by Baily in repeating Cavendish's experiments, Foucault's pendulum apparatus, Gauss's pendulum for demonstrating the rotation of the earth, &c. The more modern aids of astronomical observation are largely represented, and, among others, there is a beautiful transit instrument, of novel construction, from Germany.

Among the instruments of a mathematical order are Babbage's celebrated calculating machine, also two calculating machines constructed in 1775 and 1777 by James Black for Viscount Mahon. We might also note the integrating machine of Sir W. Thomson. The laws of combination of harmonic motions have been illustrated by some ingenious apparatus of Messrs. Tisley and Spiller, and by a machine invented by Mr. Donkin; but the most important application of these laws is to be found in Sir W. Thomson's tidal clock, and in a more elaborate machine which draws curves predicting the height of the tide at a given part for all times of the day and night, with as much skill as can be obtained by direct observation. Then there are the "Napier bones" of the inventor of logarithms, used for performing multiplication and division. Among measur-



ing instruments the gauges lent by Sir Joseph Whitworth are remarkable for their delicacy. With one of these, for measuring the bore of guns, differences of one-ten-thousandth of an inch can be measured. There is another, moreover, by means of which a quantity so minute as one-millionth can be grasped. The apparatuses which Joule employed in ascertaining the mechanical equivalent of heat, are among the collection.

The field of magnetism and electricity is now a very vast one, and in the exhibition it is represented by a correspondingly large variety of apparatus. A peculiar halo of interest gathers round the instruments, many of them so simple and homely, with which Faraday worked out his fruitful ideas. Among old electric machines is one with two glass cylinders, one of which is covered with sealing-wax, so as to obtain both positive and negative electricity; there is also Nairne's early electric machine with glass globe, Armstrong's hydro-electric machine, &c. Volta's electric lamp is exhibited for lighting gas by means of the electric spark. There is an endless variety of batteries, and the numerous Holz and other electric machines exhibited will afford material for careful study, as also the novel forms of magneto-electric and other machines which have of late years multiplied so fast. Here may be found apparatus for regulating the time and place of an electric discharge; apparatus for accumulating electricity; apparatus for observing the effects of discharge of accumulated electricity; apparatus for producing, and apparatus for observing, effects of continuous electric currents; apparatus for measuring the strength of electric currents, and apparatus for measuring resistance, and so on. In the telegraphic department there is a complete historical collection which must be of great interest not only to electricians and telegraphists, but to the general public, illustrating the progress of the electric telegraph from the time when the first idea of it was crudely embodied, down to the present time. This collection includes, of course, all the classical apparatus which belonged to Wheatstone and Cooke, among which is the original Wheatstone Bridge. Many will be interested in seeing the instruments that were used on board the *Great Eastern* in laying the Atlantic Cable. There are copies of the first German telegraphic apparatus (Goemmering's), and the first needle telegraph (Schelling's); the electro-magnetic telegraph apparatus used by Gauss and Weber in Göttingen, from 1833 to 1838, &c., &c.

We must here desist for the present, though the majority of the sections are still unvisited. It may be understood, even from these hasty and imperfect notes—but in any case, the reader may soon convince himself by personal inspection—how rich and varied is the collection now in course of completion, and how ample is the feast therein provided for those who feel in any measure drawn to the "beautiful and true" in science.

The date of opening of the exhibition is still uncertain. It is hoped that her Majesty will grace the occasion with her presence, and conduct the opening ceremony. Some of the galleries of the exhibition will probably be lighted in the evenings with the electric light, and a considerable portion of the apparatus, it is intended, will be kept in motion.

### GREEN'S GEOLOGY

*Geology for Students and General Readers.* Part I. Physical Geology. By A. H. Green, M.A., F.G.S., Professor of Geology in the Yorkshire College of Science, &c. (London: Daldy, Isbister, and Co., 1876.)

THE progress of geological research in every quarter of the globe is exceedingly rapid, and discoveries of new processes of investigation, leading to the opening up of fresh lines of thought in connection with the science, are constantly taking place. Hence, in spite of the acknowledged excellence of some of the existing manuals of geology, such as those of Lyell and Jukes, we cannot but hail with pleasure the appearance of a new text-book of the science—especially of one which, like the present work, is not a mere epitome of one or other of the standard treatises just referred to, but which aims at some originality in its arrangement and mode of treatment of the subject. Prof. Green may be congratulated on having written a work embodying a vast amount of valuable information, which is presented in a very clear and readable form.

Of the two classes for whom Prof. Green writes, we think the "general readers" are those for whom his work is best adapted. Some of the chapters, such as the ninth, which is entitled, "How the rocks came into the positions in which we now find them," and the tenth, of which the heading is, "How the present surface of the ground has been produced," are models of clear and accurate description, and of logical and forcible reasoning; they are evidently written by a man with a thorough acquaintance with his subject, and no little enthusiasm for it to boot. We may, perhaps, demur to the confident tone and the sometimes off-hand manner with which our author disposes of the objections of those who differ from himself on some of the questions discussed; yet we cannot but feel that the conclusions at which he has arrived and which he so clearly states, are the result of independent observation and personal conviction, and are not merely adopted at second-hand. While reading many parts of this work, it is impossible to avoid the consciousness that we are following the pleadings of an advocate, and not the expositions of a judge; yet the arguments are brought forward with such lucidity and earnestness, that we accept the work as embodying the ablest exposition yet offered to us, of the views of that school of geologists to which Prof. Green belongs. Occasionally, however, the author is so carried away by his enthusiasm in behalf of favourite doctrines, that his confidence becomes something very like arrogance, as in the following passage, with which he concludes his chapter on Denudation:—

"The reader will do well to compare with the theory of surface-sculpture upheld in the preceding memoirs, chapter xix. of the late Prof. Phillips' 'Geology of the Valley of the Thames.' Elegant and ingenious as is the explanation there put forward, there is about it an unsatisfactory vagueness and want of definition, which contrasts strongly with the sharp precision and logical coherence of the views on the subject of which a sketch has been attempted in the preceding pages, and which are steadily gaining ground among modern geologists."

In keeping apart from the other portion of his work purely speculative questions, and treating of them in two chapters at the end of the volume, we think the author



has exercised a very wise discretion. In these final chapters the reader will find an excellent summary of the latest contributions to Cosmogony, and a generally fair and impartial discussion of the bearing and value of recent geological theories.

Of the suitability of Prof. Green's work as a text-book for "students," we regret to say that we cannot speak so favourably. The ability and enthusiasm with which our author writes on certain portions of his subject, fail to reconcile us to his inadequate treatment and sometimes total neglect of others of equal importance; and, in perusing the book, it is impossible to avoid the feeling that the space devoted to the several subdivisions of the science must have been determined, not as the result of a judicial consideration of their respective claims, but almost entirely by the author's peculiar predilections. For example, it is rather startling to find in a work on Physical Geology, extending to 540 pages, no discussion whatever of the phenomena and origin of mineral veins, and only, indeed, an incidental mention of their existence!

A still more serious blemish of the work, considered as a student's manual, is the looseness of description and inaccuracy of language in certain parts of it. This defect is most conspicuous in the second chapter, which treats of the characters and classification of rocks, and which offers a painful contrast to those later chapters of which we have already spoken. Among the numerous grave errors which every petrologist will remark in this chapter, we may call attention to the following. In the enumeration of the principal crystallographic forms the author omits such commonly occurring ones as the pentagonal-dodecahedron, the icositetrahedron, the scalenohedron, and the tetrahedron, although some of these have to be referred to in subsequent pages of the work; of the *hemiheiral* forms, indeed, Prof. Green makes no mention whatever. We are told that when a piece of calc-spar is broken up, "the shape of the fragments will be identically that of the block we started with." Again, we read, in reference to the subject of Polymorphism, "This is spoken of as Dimorphism, when the different *crystalline shapes* are two in number; Trimorphism when they are three in number, and so on." The italics are our own. In speaking of the constituents of a rock, the author places side by side metals and oxides in the loosest manner, and while the formula of soda is written  $\text{Na}_2\text{O}$ , that of potash stands as KO. Olivine is classed as a mineral of the augite group, and we read, "It is said that augite has never yet been found with quartz or orthoclase." "Perlite" is confounded with "sphaerulite," certain rocks are spoken of as *acidic*, trachytes are classified as *quartzless* and *quartzose*, and no mention is made of the fact that nepheline is a usual and highly important, if not an invariable, constituent of phonolites. These and many similar errors convince us that Prof. Green has hardly taken that amount of care in mastering those principles of chemistry, mineralogy, and petrology which are indispensable to the presentation of this part of his subject in a manner that will be of real service to the student. And this conclusion is confirmed when we examine the classification of rocks adopted by the author, and many of his definitions, such as those of rhyolite, hypersthene rock, and leucite-rock; or again, when we mark the want of judgment so frequently shown by him, as, for example, in rejecting the

name of "porphyrite," while he retains that of "aphanite." Of the little care that has been taken to bring this part of the work "up to date," we have proofs in the circumstance that the dimorphism of silicic acid is not mentioned, and that leucite is spoken of, without hesitation, as belonging to the *cubic* system.

It is only fair, however, to point out that this very great want of accuracy is far more conspicuous in the earlier portions of the book than in its later chapters. This is a most unfortunate circumstance, inasmuch as we fear that many teachers who examine the work with a view to determine its fitness for the wants of students will be tempted to lay it down with feelings of disappointment and despair before they arrive at its really valuable portions.

We cannot but remark that Prof. Green's partial failure in a work which in many respects presents so much of promise, seems to us to have arisen from the attempt, which he boldly avows in his preface, that of making the teaching of physical geology take precedence of that of petrology and palæontology. While the petrological division of his work is treated so much more feebly, as we have already seen, than the other portions of the subject, the palæontological is omitted altogether. We do not think this can be safely done in any work on physical geology, and the danger of attempting it is well illustrated in Prof. Green's endeavour to explain the manner in which the conditions under which different deposits must have been formed is determined by geologists; in this explanation he almost entirely ignores the important evidence afforded by the characters of the animals or plants embedded in the sediments.

Rocks and fossils are the objects with which the geologist is called upon to deal at every step of his inquiries, and an accurate, if not an extensive, knowledge of them, is indispensable to the student, before he can hope to grapple successfully with those "broader questions" for which our author shows so much partiality. We cannot but regard the attempt to teach physical geology without the aid of petrology and palæontology, as bearing a suspicious resemblance to the specious promises which are made by those who profess to be able to impart a knowledge of a language without instruction in its grammar. We are sure that if such an experiment could have been successful it would have been so in the hands of so experienced a field geologist, so earnest a teacher, and so lucid a writer as Prof. Green; and, if he has to some extent failed, it is only because a more complete success, under the conditions accepted by him, was impossible. Had our author shown more deference towards the results attained by petrologists, we feel convinced that he would have written with far less boldness on such open questions as that of the "metamorphic origin of granite;" and had he admitted the importance of palæontological evidence, he would have recognised the difficulties which stand in the way of the acceptance of the theory of alternations of universal hot and cold climates during the earth's past history dependent on astronomical causes.

The views of scenery in the book are admirably selected, but unfortunately their value as illustrations of the text is greatly detracted from by the inferior style in which, in too many cases, the wood-engraving has been executed.



## DITTMAR'S CHEMICAL ANALYSIS

*A Manual of Qualitative Chemical Analysis.* By William Dittmar, Professor of Chemistry in Anderson's University, Glasgow. (Edinburgh: Edmonston and Douglas, 1876.)

WITH the numerous works on chemical analysis already in existence we are justified in asking what special advantages Prof. Dittmar has to offer to chemical students in bringing out another book on the same subject. It will be found, in answer to this question, that the present work contrasts favourably with many of our standard books on the subject both as regards completeness, originality of treatment, and the introduction of a large amount of important matter which has not hitherto found its way into our manuals of analysis.

In giving our readers a brief sketch of Prof. Dittmar's mode of treatment, we shall point out what appear to us to be the special features in the new analysis deserving commendation.

To quote from the "Introduction":—"The book is intended for the use of students who, after they have mastered the first rudiments of chemistry, enter a laboratory to work *under the direction of a teacher*, while, at the same time, they *continue their study of theoretical chemistry*."

Following the Introduction, we have a series of exercises calculated to make the student practically acquainted with most of the operations and processes employed in analysis. Among the readable matter interspersed between the exercises, we notice with satisfaction a clear elucidation of the meaning of the term *equivalent*—a term which appears to have dropped out of most of the modern text-books, leading students to believe (we speak from actual experience) either that the idea is altogether obsolete or is covered in some mysterious way by the word "atomicity."

We are of opinion that the meaning of "equivalent," or "equivalent weight" of an element, should be laid before all students of the science and the relationship of these numbers to the "atomic weights" clearly pointed out. In this same portion of the book will be found also an excellent exposition of the general theory of double decomposition.

The next division treats of the metals, these being divided into six groups, viz., the copper group, comprising silver, mercury, lead, copper, bismuth, cadmium (and palladium); the arsenic group, comprising this metal, antimony, tin (molybdenum, tungsten, gold, platinum, and the platinum metals other than palladium); the iron group comprising chromium, aluminium, iron (uranium), cobalt, nickel, manganese, zinc (thallium), &c.; the barium group comprising this metal, strontium, and calcium; the magnesium group consisting of this metal and lithium; and the potassium group comprising sodium, potassium (rubidium and cesium). The method here adopted does not much differ from that in general use, excepting that the groups are considered in the same order as that followed in the systematic course of analysis instead of in the inverse order. After the reactions of each of the metals in the group have been considered, their separation from each other and from the other groups is entered upon. We are glad to see that in many

cases the author does not limit himself to one particular method of separation, but gives the most effective methods known, and points out under what particular conditions each process is applicable. The reactions of the rarer metals are given in appendices to the main groups. We observe also that Bunsen's flame reactions are sometimes resorted to, this being, so far as we know, the first work since the last edition of the English translation of Fresenius' "Qualitative Analysis," in which these valuable film-tests are introduced to the notice of students in this country. This portion of the book concludes with a general scheme to be followed in performing a systematic analytical search for metals.

The third division of the work treats of the non-metallic elements. In each case the properties of the free element are first considered, then its reactions and the reactions of its acid compounds, and finally the discrimination of the element and its acid compounds in complex mixtures. The order in which the various groups are treated of is as follows:—The halogens, sulphur, selenium, and tellurium, nitrogen, phosphorus, boron, silicon, fluorine, carbon, hydrogen, and oxygen. This list of course gives no idea of the complete manner in which the author has treated the subject. That our readers may form a more just estimate of the contents of the work, we propose to point out a few selected details. Thus the chapter on the halogens includes a description of the oxygen acids of these elements and the organic halogenides; under the sulphur group we have, in addition to the reactions of the sulphides, sulphites, and sulphates, a discussion of the characters of the dithionates, polythionates, and organic sulphur compounds; under nitrogen we find ammonia, the oxides and acids, and organic nitrogen compounds (ammonium compounds are treated of as an appendix to the potassium group of metals); the acids of phosphorus are considered in great detail, and a section devoted to organic phosphorus compounds. The chapter on carbon includes the analytical characters of a large number of organic bodies, *e.g.*, cyanogen and its compounds, the fatty acids, the acids of the lactic and oxalic series; also a section on the ultimate analysis of carbon compounds. Under hydrogen the author treats of water, and under oxygen we find remarks on ozone, hydrogen peroxide, and a very complete section on the detection of this element in a combined state. This division concludes with a "Summary of operations available for the detection of the *non-metallic* constituents of substance in general, and of the *inorganic acids* in a mixture of metallic salts in particular."

Having mastered the analytical reactions of the metals and non-metals the student is, in the concluding division of the work, introduced to the analysis of substances of unknown composition. The preliminary chemical examination is conducted in the usual manner—some of the substance is first heated *per se*, then in a current of air, with "bisulphate of potash," with soda-lime, a mixture of caustic soda, nitre, &c. Then follows an account of the well-known flame and blowpipe reactions and of Bunsen's "film tests." The preliminary examination in the wet way is next undertaken, and this is followed by a section on "methods of disintegration for some of the more frequently occurring classes of substances." With regard to the exhaustive analysis of complex mixtures,



the author contents himself with a few general remarks, leaving it to the student to apply the methods acquired in working through the foregoing portions of the book, instead of guiding him, or, we should rather say, binding him down to the usual "tables."

It would be invidious on our part to institute comparisons between the present and any existing work on the same subject; but, considering the volume as the expression of the method taught by Prof. Dittmar, we are of opinion that it stands on a decidedly higher level than the generality of such works.

Although the author's accuracy is throughout unimpeachable, there are some few questionable, or at least debateable points, which demand a passing notice.

In the first place, we regret to see the occasional appearance of what we must consider badly-constructed phrases such as the following (p. 44):—"To students who have not yet got far enough advanced to invent their own methods." Then, again, we hardly know whether to admire or to condemn the frequent inconsistencies of formulation. To give a few examples:—Phosphoric acid is written in different parts of the book in no less than four different ways: thus, at p. 11,  $\text{HHHPO}_4$ ; p. 253,  $\text{PO}(\text{OH})_3$ ; p. 244,  $\text{P}_2\text{O}_5 \cdot 3\text{H}_2\text{O} = 2\text{PH}_3\text{O}_4$ ; at pp. 244-245, the metallic phosphates are written  $\text{PO}_4\text{HR}'_2$ ,  $\text{PO}_4\text{H}_2\text{R}'$ , and  $\text{PO}_4\text{R}'_3$ , and on the same page metaphosphoric acid is written  $\text{HPO}_3$ . Then on the same page (41) we find two nitrates thus formulated:  $\text{HgON}_2\text{O}_5$  and  $\text{Bi}(\text{NO}_3)_3$ . Now, although we admire the spirit which leads a writer to adopt these different modes of formulation as being a spirit of independence, which in the *original worker* shows that he is not the slave of any hypothesis, we think that the case is entirely altered when we have to deal with *students* of the science, nothing shaking the faith of a learner so much as an apparent want of consistency.

We cannot conceive why the author has gone back to the old nomenclature—"nitrate of potash," "bisulphate of potash," "phosphate of soda," &c. Although consistency is displayed throughout the book in this matter we cannot sanction the use of a system of nomenclature which, if not entirely obsolete, is rapidly becoming so among the scientific chemists in this country. Be it understood that our protest is here again entered solely from a student's point of view. It must perplex the learner to find out that the substances he has been employing in Prof. Dittmar's laboratory under the names of "bisulphate of potash," "phosphate of soda," &c., are known elsewhere as "potassic disulphate," "hydric potassic sulphate," or "hydrogen potassium sulphate," "hydric disodic phosphate," or "hydrogen disodium phosphate," &c.

With these remarks we may conclude our notice of what we venture to look upon as a valuable addition to our literature of the important subject of chemical analysis. We are confident that Prof. Dittmar's work will stand, by virtue of its own merits, as a scheme for instructing in this branch of the science.

We have in these columns (vol. xi. p. 107) formerly expressed the opinion that the systems of analysis in general use in our schools of chemistry need reforming in certain particulars. Thus in the article referred to we found occasion to complain of the want of chemical science displayed by the majority of students practising analysis

according to certain cut and dried systems of "tables." It must be conceded that the student who is thoroughly well grounded in the *scientific principles* involved in chemical analysis must take a higher position than he who works blindly from a given set of rules. That some such idea is entertained by the author of the present work is shown by the fact that the three first divisions of the book are considered enough to furnish a sufficient groundwork of scientific principles to enable the use of tables to be dispensed with altogether when the analysis of complex mixtures presents itself so that both teachers and students may now congratulate themselves on possessing a work in which a step has been taken in the right direction—a system which brings into exercise the thought, knowledge, and judgment of the analyst, instead of leaving him a mere helpless machine forced to proceed in the fixed direction laid down in this or that set of "tables."

R. M.

#### RICHARDSON'S "DISEASES OF MODERN LIFE"

*Induced Diseases of Modern Life.* By B. W. Richardson, M.D., M.A., F.R.S. 8vo. Pp. 520. (London: Macmillan and Co., 1876.)

HEALTH is proverbially one of the greatest blessings man can enjoy, and yet in this hardworking, hurrying, struggling age, many a one deliberately sacrifices it in the endeavour to succeed in his pursuits, commercial, literary, or scientific. Success is the object of their desires, and they are quite willing to pay for it the price of broken health and shortened life. This is even more the case with literary and scientific than with commercial men, for the latter generally look forward to several years of retirement and ease as a reward for their labours, while the former are rather anxious that their work itself shall be such as to secure them a certain place among the world's great ones, than concerned whether their fame be posthumous or not. In struggling to accomplish it they too often forget that "the race is not to the swift," but rather to the long enduring, and that if Cuvier or Darwin had died before reaching middle age, not only would their names have remained comparatively unknown, but science would have sustained an irreparable loss. Sometimes the worn-out body reminds them only too forcibly of the dependence of the mind upon it, work becomes impossible, every occupation must be renounced for a time, and the vantage ground which has been gained by unremitting toil is entirely lost. Nay more, the exhausted energies require a long time to recover; when work is resumed it can rarely be carried on with the same vigour as before, and meanwhile some slower but steadier competitor steps in front and wins the longed-for prize, or makes the eagerly-desired discovery. Several years ago we began to ascend the long flights of steps which lead to the higher part of the island of Capri, at the same time with another party. They ran briskly up while we went slowly on, and they reached the top of the first flight while we were only half way up. But here they were out of breath and stopped to rest. We, on the contrary, never stopped; if breath began to fail we went more slowly, but we never stood still. The consequence was that we passed the other party about the middle of the second flight, and



by the time they had reached its top, we had mounted the third. In such a competition as this the increasing difficulty of respiration soon warns a man to stop, but in the life-long struggle for existence it is not so easy for one to know when he is getting out of breath and to relax his exertions in time. As a help to do this Dr. Richardson's work is most valuable, for he paints in vivid colours the symptoms of disease from worry and mental strain, beginning with the slighter ones of restlessness, irritability, and "an overweening desire to do more and yet more work," and ending with dementia, diabetes, &c. He gives a most salutary warning to those who strive to counteract the effects of mental overwork by adding to it hard bodily exercise, and his remarks on physical strain should be carefully perused by all young athletes. If his cautions were constantly attended to, we would have fewer instances of break-down either mental or physical. The effects of the passions on the body are next taken up, and then the action of alcohol and tobacco discussed at length.

Dr. Richardson seems to regard alcohol as an unmitigated evil, and although he acknowledges that sometimes tobacco may be useful in soothing the excited brain, he omits this beneficial action from the summary which he gives of the effects of smoking, and includes only the baneful effects which follow the abuse of the weed. This part of his book recalls to our mind a lecture in which the late Prof. Hughes Bennett denounced pastry as one of the chief causes of consumption. No one can doubt that pastry, alcohol, and tobacco are all capable of abuse, but whether their use is to be entirely prohibited on that account is an entirely different question.

The chapters on disease from the use of narcotics, and from late hours and broken sleep are especially interesting and instructive; and that on disease from food contains some most useful remarks on the injurious effects of too much tea, coffee, soda-water, seltzer, and sweets, as well as on the consequences of over-eating.

In treating of diseases from impurity of air the author mentions the bad effects of stoves, but he might also with advantage have drawn attention to the languor and inability to work which may be induced by burning much gas in the room where one is thinking or writing. He might have mentioned the Italian proverb, that when you have built a house you should make your enemy live in it for the first year, your friend for the second, and should inhabit it yourself in the third; but his observation of the occurrence of eight cases of consumption and fourteen of rheumatic fever in one row of pretty houses during the first two years after they were built may perhaps convince people of the danger of inhabiting damp dwellings, without any additional testimony.

Other chapters deal with diseases incident to some occupations, disease from sloth and idleness, from errors of dress, from imitation and moral contagion, automatic disease and hypochondriasis, and intermarriage of disease. The book concludes with a summary of practical applications or short directions how to avoid or counteract the sources of disease already discussed.

The work is of great value as a practical guide to enable the readers to detect and avoid various sources of disease, and it contains in addition several introductory chapters on natural life and natural death, the phenomena of disease, disease antecedent to birth, and on the effects of the sea-

sons, of atmospheric temperature, of atmospheric pressure, of moisture, winds, and atmospheric chemical changes, which are of great general interest. In several points we do not agree with Dr. Richardson; we would like him sometimes to give fuller reasons for his dogmatic statements; we think he has perhaps pictured the effects of overwork in too glaring colours, and we think he has been somewhat unfair to alcohol and tobacco. But his book is most suggestive; it is written in a most attractive style, and it may assist the work and prolong the days of some who are unwittingly destroying their health, if they will only learn and attend to its warnings and counsels.

#### OUR BOOK SHELF

*Over the Sea and Far Away, being a Narrative of Wanderings Round the World.* By Thomas Woodbine Hinchliff, M.A., F.R.G.S., President of the Alpine Club. With Fourteen Illustrations. (London: Longmans and Co., 1876.)

Mr. HINCHLIFF, who is already known as the author of one or two pleasant narratives of travel, managed, in one year, to do 36,000 miles of ocean, besides spending a considerable time in exploring various regions of America and Asia. His reasons for writing this considerable book on his tour of the world are to induce other tourists to follow his example, not in writing a book, but in leaving the beaten paths and learning something about and enjoying the many beauties of South America especially, and also because he believes there is abundant room for a further and more detailed account of the natural aspect of many of the countries visited, "especially with regard to their scenery, their flowers, ferns, and fruits." We are bound to say that Mr. Hinchliff, from these points of view, has fairly justified the publication of the present work. He writes in excellent spirits, tells clearly what he saw, keeps up the interest from beginning to end, and the general reader, at all events, will find many things in the book quite new to him. Mr. Hinchliff spent most of his time in Western North America, in California, and the Yosemite Valley especially, in Brazil, Peru, and Japan. He is a good and enthusiastic botanist, a shrewd observer, and a clear narrator. He managed to see a great deal that was well worth seeing of the countries visited, their products, and their inhabitants, and although he opened up no new ground, he has been able to suggest aspects and describe phases that, we daresay, even those familiar with the literature of travel will recognise as original. The illustrations are good and appropriate, and altogether we can recommend the work as a really interesting and instructive record of a long tour.

*Une Réforme Géométrique. Introduction à la Géométrie descriptive des Cristalloïdes.* Par le C<sup>o</sup> Léopold Hugo. (Paris, 1874.)

*Géométrie Hugodomoidale, anhellénique, mais Philosophique et Architectonique.*

*La Question de l'Équidomoïde et des Cristalloïdes Géométriques.* Par le C<sup>o</sup> Léopold Hugo. (Paris, 1875.)

ÉQUIDOMOÏDE : Sphère :: Prisme : Cylindre. "Équidomoïde, c'est en effet le nom que j'ai proposé pour la figure polygonale qui se place *avant* la sphère, comme le prisme et la pyramide se placent *avant* le cylindre et le cône en vraie philosophie. Il y a donc des équidomoïdes trigonaux, tétraonaux, pentagonaux, et ainsi de suite jusqu'à ce qu'on arrive à la sphère, leur sœur cadette . . . mon nouveau système, envisageant toutes les figures polygonales qui sont les aînées de famille de tes (the extract is taken from a hypothetical address to Archimedes), sphéroïdes et conoïdes, leur donne le nom générique de *domoïdes*; puis j'y fais adjonction, comme préfixe, des



syllabes caractérisant les trois sections coniques ; d'où régulièrement ellipsoïde, parabolicoïde et hyperbolicoïde. D'autres figures, moins chargées, au contraire, que la pyramide, sont dites *trémoides*. Ce seront toujours, domoïdes et trémoides, des corps ou solides polygonaux, ou du moins considérés comme tels, et les rapports caractéristiques  $\frac{2}{3}$ ,  $\frac{1}{2}$ , se constitueront le lien commun dans chacune des diverses familles. Ce sont choses que les curieux peuvent étudier dans mon ouvrage : *Théorie des Cristalloïdes*."

"Geometria renovata. Création d'une géométrie nouvelle, d'une morphologie architectonique. Geometria philosophica. Doctrine préexcellente ; de même que le polygone engendre le cercle, de même les cristalloïdomoïdes engendrent les sphéroïdes ; geometria Hugodomoidica sive Hugodomoidalis ! geometria aspheristica ! de même l'équidomoïde engendre la sphère !"

"Circulaire à messieurs les mathématiciens (on est très-poli dans cette géométrie-là) :—'L'équidomoïde pré-archimédien a l'honneur d'informer votre seigneurie que par arrêté de S. E. le Commandeur Léopold Hugo, Président de la Géométrie Architectoni-primordiale, il a été nommé au poste occupé précédemment par la sphère, et qu'il s'y maintiendra envers et contre tous. L'équidomoïde espère que votre seigneurie voudra bien, ainsi que LL. AA. les Académies scientifiques, accueillir favorablement sa nomination et lui donner aide et appui contre les retours offensifs de la titulaire dépossédée. Il saisit cette occasion pour exprimer à votre seigneurie toutes les assurances de sa très-respectueuse considération.

"'Equidopolis, le

The motto is "Devise anti-archimédienne. L'équidomoïde va bien : le rebelle gagne du terrain ! . . . suppression de la sphère !"

We have, in a recent number of NATURE, given a sketch of a work by the same author. Now we let him speak for himself. When we say that there are "Placards singuliers," "Placards plus ou moins singuliers destinés à MM. les Elèves de Mathématiques (Pamphlet fantasia)," "Objurgation Hugodomoidale," "Inauguration Transatlantique,

"Yankee doodle went to town  
Upon th' equidomody,  
Cocked a feather to his hat  
And called it crystallody !"

&c., &c., in many languages, we have furnished our readers with some idea of the two works before us. *Spec-tatum admissi, risum teneatis ?*

Count Hugo is the author of at least six pamphlets ; two more are in the press, and more in preparation, "and still they come."

Our latest acquisition is a sheet on "the Pan-imaginary theory. (not the frying-pan)." "Here the space with  $\frac{1}{m}$  dimensions gives birth, by its successive phases, to the *real space*, with  $n$  dimensions, and specially to the *natural space* with three dimensions, and to the *sub-natural space* with two dimensions, &c."

#### LETTERS TO THE EDITOR

The Editor does not hold himself responsible for opinions expressed by his correspondents. Neither can he undertake to return, or to correspond with the writers of, rejected manuscripts. No notice is taken of anonymous communications.]

##### "The Recent Origin of Man"

THE letter of the author of the above work in NATURE, vol. xiii. p. 484, presents two points which demand an answer. I. The reviewer is asked for his authority for the statement that palæolithic implements have been met with in Asia Minor. It is to be found in Evans' "Ancient Stone Implements," p. 571, and in Dawkins' "Cave-Hunting," p. 429. The discovery was made by the Abbé Richard between Mount Tabor and the Sea

of Tiberias. 2. My opinion, which is also shared by some of the leading archæologists of Britain, that the interments at Solutré have not been proved to be palæolithic, has unfortunately evoked a charge of "ignorance and treacherous memory" from the author. I would merely remark that I am not ignorant of the account of Solutré in the "Matériaux," and in the "Archives du Muséum de Lyon," the latter of which is apparently unknown to the author, nor has my memory failed me concerning the debate on Solutré at the French Association, and the human skulls and implements which I then saw. Mr. Southall's argument as to the modern date of some of the reindeer, based on the percentage of gelatine in their bones, may be left to the tender mercies of Mr. Evans, and the comparison of the finely-chipped implements, with the Danish Neolithic finds, to those of M. de Mortillet, who takes them to be typical of one of the stages of the palæolithic period.

The discussion of the other questions raised in the letter, such as the Neolithic age of the *Rhinoceros hemitachus* of the Gibraltar caves, or the reiterated assertion that the Irish Elk lived in Europe in the middle ages, is unnecessary in the present state of scientific inquiry. How an appeal to the mound at Hissarlik, to the discoveries at Alise, to the pile dwellings, to the food in the stomachs of fossil elephants and Mastodons, or to the recent elevation of Uddevalla can prove the "recent origin of man," may safely be reserved for decision to the judgment of the reader, without any comment from  
THE REVIEWER

#### On the Formation of Coral Sand

IN the best books on geology one finds that the formation of coral sand is attributed to trituration by the force of the surf, the waste of shells and minute globigerinæ, and even to the droppings of those fishes which are said to browse upon the living coral.

While residing at Santa Cruz in the West Indies about this time last year, my friend Mr. Quin, inspector of schools there, first pointed out to me the great importance of a certain seaweed in the formation of coral sand, and I had ample opportunity for verifying his observation while I stayed there.

A Coralline limestone is formed of coral blocks, consolidated coral-sand, and mud, shells, and myriad calcareous cases of minute organisms. Of these, next perhaps to the coral itself (of which I have seen great masses whose features were not quite effaced by percolation, &c., in the upheaved limestone of Santa Cruz), the bulkiest ingredient is the coral sand and mud, especially the sand, the shells and cases being of minor importance.

We are invariably taught, as far as I have seen, that coral sand is mainly formed of the trituration of the coral skeletons among each other, but it is difficult to see how this can be when one has seen both the sand and the skeletons, and the action of the surf which is mostly among the coral yet alive and cushioned with a vegetable matter. The coral skeleton is extremely hard and crystalline, and when two pieces of dead coral are rasped together by the action of the wave breaking over the reef they will triturate themselves into very fine grains. One can understand how the coral mud can be formed in this manner ; but not so easily how the coral sand is formed. A glance at coral sand as it is seen forming the curving beaches in the pretty coves of the West Indian Islands shows that it is formed of *coarse* calcareous grains smoothed and rounded by the water, and of rather a soft friable nature, more like water-washed fragments of stucco or shell than crisp coral. On examining it more closely one sees that it is mainly composed of fragments and scales of soft calcareous matter of a mellow whiteness, and easily broken between the fingers. The larger of these scales have a peculiar shape, roughly like a half moon, whilst others are plainly only broken pieces of the larger.

Nor is the source of these far to seek. One finds everywhere strewn over the surface of the sand white bunches of a dead sea-weed, or rather of its calcareous skeleton, bleaching in the sunshine, every perfect leaf of which is one of these half-moon shaped scales, and all connected together by flax-like fibres. They have been cast ashore, by high tides from the fringing reef. (See fig.)

In the reef itself, while sailing over it, one sees among the dark coral masses white sheets of coral sand, and when these are scrutinised more closely they prove to be almost entirely formed of these broken scales or leaf-skeletons.

One day I went with Mr. Quin to the outer edge of the reef at low water, and landed on its shoaling crest. Mr. Quin was provided with a very useful lens, wherewith to view the



"wonders of the deep," in the shape of a square wooden box with a glass bottom, which on being set on the water and looked through, obviated the surface ripple, and permitted a clear view into the coral caverns, some of which, by the way, were of great beauty, natural aquarium tanks, hoary with mosses and sea-blooms, floored with coral sand and shells, and tenanted by curious fishes of the most brilliant and varied hues.

The huge rounded bosses of green growing coral among which the surf-breaks resembled much the moss-covered granite-boulders of a boggy Scotch glen. Here we found banks and beds of the coral sand where it is formed at our very hands.

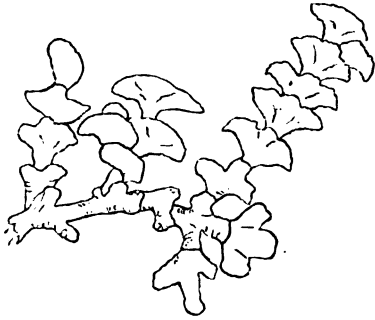

The scales and half scales were here in a most perfect state, and seemed to make up almost the entire mass of sand. It was easy now to see the principal source of coral sand—at least at Santa Cruz—and that what is seen on the beach is merely what is found out here in a more finely divided state.

Over all the reef about us, growing plentifully, was the living weed which supplies these scales—the vegetable tissue covering the calcareous interior being of a dull-green like the living coral itself. I procured a specimen of the growing weed, and also of the sand from these beds where it is first formed and from the beach; but unfortunately I have lost these. I can only send you some of the dried skeleton, and append a rough sketch of it for the benefit of readers.

JOHN MUNRO

West Crozier

Floating Radiometers

In Mr. Crookes' paper reported in NATURE, vol. xiii. p. 489, occur the following words: "The envelope turned very slowly a few degrees in one direction, then stopped and turned a few degrees the opposite way." Assuming that this is rightly reported, it is inexplicable to me how Mr. Crookes could have written it. For, as the lawyers say, it is "void from ambiguity." The whole question between Mr. Crookes and Dr. Schuster appears to me to turn on the one point ignored by the former. When the rotation of the envelope began, in which direction was the first oscillation? To say that the envelope first turned in one direction and then in the other is simply to say that it oscillated, which, while it is a shorter mode of expressing the same thing, is an equally useless expression. The very nerve of the problem lies in the point omitted. If the first oscillation of the envelope was in the direction opposite to that of the mill, it is surely incontestable that the kick, which caused it, could not be the effect of any external force acting on the discs only.

Valentines, Ilford

C. M. INGLEBY

Preece and Sivewright's "Telegraphy"

It is neither usual nor becoming for authors to question the judgment of a reviewer in dealing with their works, and although I think that in your number (vol. xiii. p. 441) you have treated the little work by Mr. Preece and myself with some severity, I do not propose to depart from this wholesome rule. Nevertheless, I think it but right to point out that the reason why the scientific part of the subject was so far left out was because this had been already dealt with in another work of the same series. Prof. Fleeming Jenkin's text-book on "Electricity and Magnetism" had appeared before that on "Telegraphy" was undertaken. In the former "the part of science" had been so ably treated that it became unnecessary and would have been out of place to go over the same ground in a practical text-book which was to appear in the same series.

J. SIVEWRIGHT

On the Nature of Musical Pipes having a Propulsive Mode of Action

IN the concluding paragraph of my last paper (NATURE, vol. xii., p. 146), I brought under notice the remarkable difference in the effect of increased diameter upon the two great classes of pipes, regarded by me as referable to the fact of the mass of air in the pipe being in the one class (that of pipes with reeds of wood or metal) under the influence of a propulsive current, and in the other class (that of pipes with reeds of air, or flue-pipes), under the influence of an abstracting current; the distinction thus manifested on the mode of action will, if clearly apprehended, enable us to reconcile many apparent anomalies in the behaviour of pipes perplexing to inquirers.

Considering a current simply as flowing, that is to say without the energy which the word propulsive implies, the nature of a tube or conduit is to cause friction between the walls of the tube and the particles of the substance flowing through the tube whether of air or of water. The friction of air upon air is also a calculable effect. In organ-pipes of the class now in question we have to recognise that we are dealing primarily with a current, with a true transport of air through a tube, a current propelled, abruptly arrested, and in a secondary stage converted into vibration; therefore all the conclusions arrived at concerning the propagation of waves of vibration in tubes are suggestively applicable here, and in practice we find these conclusions verified.

As regards ordinary tubes or conduits, Seebeck, following Regnault and Kundt, has shown (NATURE, vol. i. p. 456) that the effect of friction in retarding the velocity of a wave in propagation is not so insignificant as might be supposed; it is greatest upon those of tones of highest pitch, and it increases according as the diameters of the tubes are less. In musical pipes of the propulsive class exactly the same relations are preserved, and if two pipes of different diameters give the same pitch-note, then the pipe of larger diameter will prove to be of greater length, in fact the opposite of the law obtaining in pipes of the abstracting class. In a narrow pipe the friction is in excess, with an increased diameter the current gains greater freedom, and coincidentally, that inner motion vibration is less impeded. Pipes of this class, for brevity here called propulsive in action, the trumpets, posannes, bassoons, oboes, have this characteristic that the whole of the wind used passes through the body of the pipe and makes its exit at the upper orifice. In flue-pipes on the contrary the amount of wind actually passing up the interior of the pipe is scarcely noticeable. The form of trumpets and the like is conical, but the oboe has a special feature, its tube is very slender, slightly enlarging upward, until at the top it suddenly expands into a terminal shape called a bell. An actual comparison will afford the clearest illustration of the effect of form.

Two pipes of the standard pitch 256 vibrations per second:—

TRUMPET.	
Sounding Mid C.	
Diameter at root of reed ... ..	1 1/2 in.
Diameter at upper orifice... ..	3 "
Length from tip of reed ... ..	23 1/2 "
OBOE.	
Sounding Mid C.	
Diameter at root of reed ... ..	1 1/2 in.
Diameter at upper orifice... ..	3 "
Length from tip of reed ... ..	21 1/2 "
	(including bell)

The oboe bell is not ordinarily reckoned in the effective length, yet it is not altogether to be disregarded; from its juncture at the tube and up to the rim 3 inches, with diameter expanding from 3/4 to 1 1/4 inches. The influence of narrow bore will be best exhibited by comparing with these the orchestral oboe where the bore commences at 1/2 and the note C is given by that portion without the bell, and which will measure from the finger hole to the tip of the reed only 19 1/4 inches. In the Chinese organ, or "Little Shang," which, when in proper condition is most perfect in relation of tube to pitch, the pipe sounding C octave above oboe measures 9 3/4 in length, including the beak, and the bore of the tube is barely 1/2 inch, being cylindrical, not conical. The reed tongue is so very small that a larger bore would be disproportionate, the column of air seems well suited to the strength of the reed, the pitch does not quite accord with our organ or our concert pitch, but that will not affect the argument. What I am anxious to point out is that these varying relations of pipes result from a natural standard, which underlies all empirical changes. The true standard for all instruments of the propulsive



class is *three-fourths of the half-wave length*, and then in accordance with varying diameters above stated all larger diameters demand length to be increased in ratio, and more allowance to be made for the diverging than for the uniform bore; greater or less amount of wind, and greater or less degree of pressure also enter into calculation, and practically are convertible in effect, the one doing duty for the other.

In the distinctive mode of action of this class we may find reasons for the varying relations of the pipes to each other, and for the contrasts shown in comparison with the other class acting under its own peculiar mode. In these propulsive pipes in both the wide and narrow scales, the wind-current, after entering the foot of the pipe or boot, passes into the body of the pipe by a very contracted inlet formed by a hollow plug usually of metal called "the beak," or more commonly "the reed," to the confusion of inquirers; properly named, as we see it in old authors, it is "the shallot," from its resemblance in shape to the once favourite esculent the eschallot; ordinarily we speak of "the tongue" the elastic strip of metal covering it, as "the reed," for in the clarinet this part is really a reed. The main impulse of the current passes into the cone of the pipe through the mass of air in a central direction, and thus in a wide pipe, as compared with its course in a narrow pipe, the current has exchanged the friction upon the sides for the lesser friction of air upon air, still restricted, but less so in degree as the cone expands, as of a swift river escaping the confinement of banks, flooding the quiet expanding delta, agitating its waters with gradually-decreasing strength, and then becoming diffused in surrounding ocean.

Utmost exactness in length is quite as important for pitch and tone in these as in flue-pipes. Although the reed tongue has a determinate pitch of itself, yet a proper length of tube to reciprocate its action is indispensable, any inaccuracy only "upsets the tone," as the technical phrase says, and gives rise to curious freaks of behaviour. The slim tapering oboe is so sensitive that if we make it a quarter of an inch too long, or if we merely pat the top of its bell whilst sounding, the tone will immediately leap to its third above—not to a harmonic—a problem as puzzling as that of some echoes falling successively by thirds.

The action of the air-reed as causing suction by the velocity of passage of wind over the mouth was illustrated by me in a previous paper by reference to the abstracting power of a current of air, as shown in the spray-diffuser where globules of liquid are lifted and withdrawn by its agency. The action in these beating reeds is also susceptible of as simple an illustration. Take six or eight feet of india-rubber tubing of  $\frac{1}{8}$ -inch bore, for this length defines action more clearly—coil the length round your hand, and placing one end in the mouth blow through the tube sharply, at the same time allow the tip of your tongue freedom of play near the orifice, and you will find it drawn suddenly to the tube by the suction of the current passing down it, and released only on the exit of the current into the atmosphere. Lightly pressing the coil in your hand you may likewise feel the throb of the passing air-pulse. The trombone-player is conscious of his lip being forcibly drawn into the cup by a like cause. A stream of air suddenly cut off cannot pass down a tube without leaving a vacuum behind it. Organ and orchestral trumpets and oboes, and all of like propulsive action, are subject to this power, and only through it are able to generate tones. Suction is thus seen to be the final cause of vibration, the vacuum exists until the initial pulse of the vibration has made exit at the outer orifice, or in the second and succeeding courses until the pulses reach the colliding point or place of the prime node. Always thus in every musical pipe the current is essential to the suction, but with the striking difference that in the flue-pipe there is continuity of stream, and the continuity of flow is made available by conversion in reciprocating motion, but in the propulsive class the action is effective through discontinuity, by abrupt cessations and sequences of stream.

Here also in the beating-reed pipes we come upon distinct evidence of the interval of rest lengthening the period of vibration. The pitch of beating-reeds is regulated to consort with the pipe by means of a tuning-wire altering the vibrating length of the tongue; thus regulated, the pitch may, however, within limited degree be altered by changing the force of wind, or by cutting off rim of pipe, or by adding thereto. Let it be observed that whether the tongue is pressed to the beak slowly or quickly, it will spring back in recoil in just the same time. By additional weight of wind, pitch may be raised, and in this case the tongue flies to more rapidly, but possibly any gain of speed in the advance may be counteracted by the recoil being impeded in the more compressed medium in which the tongue moves;

the only remaining effect otherwise is that of an increased swiftness of the current of air more vigorously propelled in its course, and this in itself would account for the acceleration of pitch. On the other hand, leaving the force of wind constant, we may by temporary addition to the rim of upper orifice sensibly flatten the pitch, for the current takes longer time to pass this extra boundary, hence the tongue is in consequence held longer upon the beak by the suction, its recoil delayed, or in other words recognising the physical result, its interval of rest is lengthened.

Many indications that come before me in my experiments lead directly to the inference that in all wind instruments this interval of rest is an important influence both on the pitch we regulate and in the quality we perceive; and in the estimate I shall have to give of the interior process of working in the flue organ-pipe, I shall draw upon this inference that vibration is an activity tempered by rests.

One point has been unnoticed. It would be easy to find a diapason-pipe of the same pitch showing precise agreement in length with the trumpet above specified, and similarly for other various kinds. The recognition of numerous like correspondences has led to the supposition that in relation to wave-length these two classes of pipes exhibit a parallelism. I hope to have made it clear that on the contrary, never parallel, the two classes proceed on two distinct systems of relation to wave-length, and are governed by a law, simply expressed as a law of divergent variation; they meet, it is true, but only at one point, where they cross in divergent lines, and they develop in opposite phases both in the ascending and descending extents of their range, the pitch of the one rising under an enlarging, and the other under a diminishing diameter.

Beyond the particular effects of friction already stated, the agency of the friction of air in the sound of wind instruments appears to me inadmissible. Reasons for this conclusion will occupy another paper in connection with details of my experiments bearing thereon under a simple device somewhat on the principle of the siren, and which may be named a "displacement siren."

HERMANN SMITH

#### Solar Halo

ON Saturday last at Penruddock station, between Penrith and Keswick, about one o'clock, I observed a solar halo which at first was not perfect, but showed a reddish tint in the arc below the sun. Afterwards the circle became complete and continued so with small intervals until about half-past four, when I went indoors. At five o'clock the halo had disappeared in the haze. The day was thick, so lazy indeed that I could hardly distinguish the outline of Saddleback from Penruddock. The colour disappeared when the circle was complete, but occasionally I thought I could distinguish a reddish tinge on the inner side of the arc. I had no means of accurately measuring the radius, but with two pieces of stick which I picked up I estimated the tangent at  $\frac{1}{4}$ , which would give nearly  $24^\circ$ . This is more than your correspondent Mr. Gledhill found in his observations, but my measurement is confessedly rough.

JAMES HEELIS

April 21

#### Safety Matches

MR. TOMLINSON'S remarks on safety-matches in NATURE, vol. xiii., p. 469, reminded me that, not long ago I accidentally kindled one of those matches by rubbing it on the edge of a Wedgwood-ware mortar. This material appears even better adapted than those mentioned by Mr. Tomlinson for igniting such matches, and I found that a common earthenware dish (glazed inside) answered the same purpose admirably. I tried to ascertain the degree of certainty with which a safety-match could be kindled by friction against these two materials, and was surprised to find that they are little inferior in this respect to amorphous phosphorus itself. After a little practice in the manner of striking, it is easy to kindle nearly every match. Thus I have lighted forty matches out of forty-four (most of them at the first or second stroke), using the glazed portion of the basin referred to. I should add that the surface becomes improved by use, which can hardly be said of the composition on the sides of the safety-match boxes.

Manchester, April 18

FRANCIS JONES

#### "The Ash Seed Screw"

THE delicate twist in the samara of the ash is clearly not that best calculated to retard descent. The more decided the twist,



the greater number of revolutions will the samara perform ere reaching the ground, and the longer consequently will be the path through which its friction is exercised.

In seeking a model for a screw-propeller, we must remember that the pitch should vary with the velocity of propulsion.

London, April 15

WM MCLAURIN

### OUR ASTRONOMICAL COLUMN

THE ROTATION OF VENUS.—It was Jean Dominique Cassini (Cassini I. as he has frequently been designated) who during his residence in Italy, made the first serious attempt to ascertain the time of rotation of this planet and the position of the axis. His observations with one of Campani's long telescopes appear to have been commenced about the middle of the seventeenth century, as related in the *Journal des Savans*, 1667, Dec. 12, but it was not until the evening of Oct. 14, 1666, that he perceived any spot of sufficiently definite aspect to be of service for the purpose in view. It is described as "Une partie claire située proche de la section, et fort éloignée du centre de cette planète vers le septentrion." At the same time several dusky spots were noted. These observations were continued till June 1667, but Cassini expressed himself very cautiously with regard to the inferences to be drawn from them. They appeared to indicate a return of the bright spots to the same position upon the disc at intervals of about twenty-three hours, but from the short time that the spots could be followed Cassini was unable to decide whether the appearances were to be attributed to an axial rotation or to a libration. "De dire maintenant," he says, "supposé que ce soit toujours la même partie luisante, si ce mouvement se fait par une libration, c'est ce que je n'oserais encore assurer, parce que je n'ai pas pu voir la continuité de ce mouvement dans une grande partie de l'arc, comme dans les autres planètes, et par cette même raison cela sera toujours très-difficile à déterminer."

In 1726 Bianchini, domestic prelate of the Pope, observing at Rome, with glasses, also by Campani, of 70 to 100 Roman palms in focus, remarked on Feb. 9 several spots which he continued to observe with the view to determine the time of rotation. His observations were published in "Hesperii et Phosphorini nova Phenomena," 1728, and he considered them to show a period of rotation of 24 days 8 hours, the North pole of Venus being directed to longitude 320°, with an inclination of 15° only to the plane of the ecliptic. Bianchini's observations appear to have been made under very unfavourable conditions, whereby he was prevented from following the spots in a continuous manner. They were discussed at length by Jacques Cassini, the son of Jean Dominique, in "Elemens d'Astronomie" (1740), who arrived at the conclusion that a rotation of 23 hours 20 minutes would represent equally well his father's observations and those of Bianchini, while if the rotation assigned by the latter was admitted, it would be necessary to reject entirely the observations of the elder Cassini, "comme n'étant qu'une apparence trompeuse."

Jacques Cassini mentions that after Bianchini had communicated to him the observations at Rome, he made attempts to discern the spots upon Venus at Paris. He examined the planet on a great number of occasions with a glass of 114 feet focus, one of the best produced by Hartsoëker, and also with one of Campani's, of 120 Roman palms' focus, which had been tried by Bianchini and considered excellent, but with all the precautions taken neither he nor Maraldi could perceive any distinct spot upon the planet's disc.

Schroeter, in 1789, examining Venus with a 7-feet reflector, discerned a bright spot in the dark hemisphere, and by following the appearance of this object, inferred that the planet rotated in 23h. 21m. 19s., thus supporting the result obtained by Jacques Cassini from his father's

observations. Schroeter's observations appear in D. J. H. Schroeter, "Cythereographische Fragmente, oder Beobachtungen über sehr Betrachtlichen geberge und rotation der Venus," Erfurt, 1792; and in "Aphroditographische Fragmente, &c.," Helmstadt, 1796. In an appendix to the latter work, noticed by Zach in "Monatliche Correspondenz," xxv. p. 366, it is stated that observations of "atmospheric spots," and of the horns, with eight determinations of "a definite point upon the surface," give for the final value of the rotation-period of Venus, 23h. 21m. 7.98s.

De Vico's observations and investigations bearing upon the time of rotation and the position of the axis are published in "Memoria della Specola . . . in Collegio Romano," 1840-41, p. 32, and in the succeeding part of the same for 1842, p. 29. The period of rotation assigned from these observations, which were made with the Cauchoix refractor of the Roman College, is 23h. 21m. 21.93s. (sidereal time). The longitude of the ascending node of the equator of Venus upon her orbit is fixed to 56° 30', and the inclination thereto 53° 11', while for the same elements referred to the ecliptic we have 57° 19' and 49° 57'. There is some error of the press or of calculation here which it is not easy to rectify. In a note to Secchi's Life of De Vico, "Memorie dell'Osservatorio . . . in Collegio Romano," Anno 1850, p. 140, the inclination of the equator of Venus to the ecliptic is given, 53° 11' 26', and the longitude of the ascending node of the equator upon the ecliptic for 1841, 57° 19' 18".

Notwithstanding the near agreement of De Vico's period of rotation with that assigned by Schroeter, it must be admitted that further investigation is very essential before we can consider the period established. There are so many negative observations upon record and these made under circumstances at least as favourable as those upon which the rotation of the planet has been supposed to be fixed, that there is ample justification for doubt in the matter.

We hear from more than one correspondent that dusky spots have been suspected upon the disc of Venus, within the last few weeks; if there be no illusion, the present may prove a favourable opportunity for attempting a new determination of the rotation-period, and this consideration has suggested the above outline of the actual state of our knowledge upon the subject.

MINOR PLANETS.—By a note from Herr Palisa it would appear that the small planet observed at Pola on November 22 and 23 was not, as supposed at the time, identical with the one he had detected on November 8. No. 155 is therefore lost or in similar predicament to the planet observed by Watson, 1873, July 29.

M. Leverrier's *Bulletin International*, of April 22, announces the discovery of another small planet at Paris, by M. Prosper Henry, during the previous night, in R.A. 14h. 9m. 58s., N.P.D., 102° 18'.

### PROF. FLOWER'S HUNTERIAN LECTURES ON THE RELATION OF EXTINCT TO EXISTING MAMMALIA<sup>1</sup>

#### VIII.

THE existing families of the Carnivora, spoken of in the last lecture, do not appear to have been distinctly differentiated in the Eocene period, at all events not till towards its close, but the order was represented by other and very singular forms, the systematic position of which is not easy to determine. The earliest in point of time is *Arctocyon primævus*, from the lowest Eocene of La Fère, Aisne, France, an animal nearly as large as a wolf, with a long tail, and heavy, strong limb bones, and

<sup>1</sup> Abstract of a course of lectures delivered at the Royal College of Surgeons "On the Relation of Extinct to Existing Mammalia, with Special Reference to the Derivative Hypothesis," in conclusion of the course of 1873. (See Reports in NATURE for that year.) Continued from p. 488.



remarkable for the exceedingly small size of the brain cavity, compared with the arches and ridges of the skull developed for muscular attachments. This character has been supposed to indicate marsupial affinities, but the rest of the osteology, as far as known, does not favour this view. The lower jaw has not been found, but the cranium shows the full complement of teeth so frequent in Eocene mammals. There are three broad tubercular molars behind the trihedral sectorial, which indicate that the animal was rather omnivorous than truly carnivorous in its habits. Another genus which includes many species of various size, and having a wide geographical range, being found in late Eocene and early Miocene deposits in France, Germany, England, and North America, is called *Hyænodon*. It also has been by many naturalists placed among the marsupials on account of the peculiarities of its dentition, which is certainly without parallel among placental Carnivores. It possesses the primitive or typical dental formula of the Eocene mammals, and the incisors, canines, and premolars, are not unlike those of a dog, but the three true molars, both above and below, are shaped like the sectorial teeth of a cat or hyæna, and increase in size from the first to the last, and thus there are no teeth formed like the "tuberculars" of ordinary Carnivores. This repetition of the sectorial character in the true molars occurs in the carnivorous marsupials, though the general structure of the skull, and limb bones as far as they are known, including the position of the lachrymal canal within the orbit, will not permit our placing *Hyænodon* in that group. Many of the lately discovered American Eocene carnivores presented the same peculiarity of several successive molars having sectorial characters. One of these from Wyoming, apparently allied to *Hyænodon*, has been described by Cope, under the name of *Mesonyx*, and another still more aberrant form, as *Synoplotherium*. The inferior canines project forwards, and are closely approximated, the incisors (at all events in the aged specimen on which the genus was founded) being absent. The molar teeth were so much worn that their characters cannot be satisfactorily made out. The most interesting features of these animals are in the structure of the feet, the unguinal phalanges being flatter and broader than in any existing Carnivora, and grooved above, and the scaphoid and lunar bones of the carpus not being united as in all existing Carnivores.

These naturally lead to the consideration of some animals, the remains of which have been discovered in the same locality and formation, of such anomalous construction, that they cannot be placed in any of the known groups, and for which Prof. Marsh has constituted the order *Tillodontia*. The type of the order *Tillotherium*, Marsh, is described as having a skull with the same general shape as in the bears, but in its structure resembling that of Ungulates. The molar teeth are of the Ungulate type, the canines are small, and in each jaw there is a pair of large scalpriform incisors faced with enamel, and growing from persistent pulps, as in Rodents.

The adult dentition is  $i \frac{2}{2} c \frac{1}{1} p \frac{3}{2} m \frac{3}{3}$ . The articulation

of the lower jaw with the skull corresponds to that in Ungulates. The brain was small and somewhat convoluted. The skeleton most resembles that of Carnivores, especially the *Ursida*, but the scaphoid and lunar bones are not united, and there is a third trochanter on the femur. The radius and ulna, and the tibia and fibula, are distinct. The feet are plantigrade, and each had five digits, all terminated by long, compressed and pointed unguinal phalanges, somewhat similar to those in the bears. Judging from the figures and description, this animal is the same as that of which a lower jaw was previously described by Leidy as *Trogosus castoridens*, and which is perhaps identical with *Anchippodus riparius*, described by the same naturalist at a still earlier date, from a single tooth from New Jersey. If this identity can be satisfac-

torily established, the latter name must be adopted, but as the lower molars of so many very different animals bear a close resemblance to each other, it is not very easy to do so, and the whole history is a good illustration of the inconvenience that often arises from the practice of giving names to minute and isolated fragments.

In some of its dental and osteological characters, *Tillotherium* or *Anchippodus* bears some resemblance to the *Rodentia*, but the definition of that order would have to be widened considerably before it could be admitted within its bounds. *Mesotherium*, spoken of in the third lecture, has better claims to be considered a Rodent, though certainly a very aberrant one. Leaving this animal aside, palæontology tells us nothing of connecting, or even of more greatly generalised forms of Rodents, or affords any better indications of the affinities of the order than can be derived from the study of its living members. Nearly all the existing families have been well represented throughout the Pliocene and Miocene epochs, and the earliest known Rodents, those of the Upper Eocene, do not appear to have been more generalised than the existing species.

Numerous species of extinct *Insectivora* have been described from various formations from the Upper Eocene to the present time, both in Europe and America, but their characters and affinities have not been thoroughly worked. The European species mostly belong or are allied to genera now existing. It has been suggested that some of the generalised American Eocene Carnivores may possibly be gigantic *Insectivora*, though in the actual fauna of the world there are no connecting links between these orders. It is also not certain whether some of the mammals of the Mesozoic strata may not be placental *Insectivores*.

The *Chiroptera*, or bats, differ strikingly from all other mammals in the adaptation of the fore-limbs as organs of true flight. Their origin is an extremely interesting question to the evolutionist. No existing forms throw any light upon it, and what little is known of the past history of the order shows that its general characters and geographical distribution have not changed materially during the Tertiary period. All the bats found fossil in the Brazilian caves resemble those now inhabiting the same country, though it is true these only go back as far as Pleistocene ages. In France, however, remains of bats have been found in the Miocene and Upper Eocene (Paris gypsum), but all belonging to the *Vespertilionia* and *Rhinolophida*, families now existing in Europe, and in the earliest known forms no signs of generalisation have been detected, nor have any of the intermediate stages between the ordinary mammal and the bat, if they ever existed, yet been discovered. No fossil remains of the large fruit-eating bats, or *Pteropi* have been found.

(To be continued.)

PROF. HUXLEY'S LECTURES ON THE EVIDENCE AS TO THE ORIGIN OF EXISTING VERTEBRATE ANIMALS<sup>1</sup>

V.

WE saw in the last lecture that the differences between birds and reptiles were very great; nevertheless, many of them tend to disappear on a closer examination. For instance, the extremely avian character of the absence of teeth, and the presence of a horny beak, is found in turtles and tortoises; that of the penetration of the bones by air cavities exists in the skull of crocodiles; and, although no existing reptile possesses the power of flight, or a fore-limb in any way approaching in structure to a bird's wing, yet, in the crocodiles, the fourth and fifth digits—those we found to be wholly absent in the bird—are much smaller than the others, and have no claws.

<sup>1</sup> A course of six lectures to working men, delivered in the theatre of the Royal School of Mines. Lecture V., March 27. Continued from p. 459



On passing to the internal organs, and the mode of development, we find far greater points of resemblance; as to the latter, in fact, the correspondence is wonderful, the account given of the development of a reptile (NATURE, vol. xiii., p. 429), applying in every respect to that of a bird.

On the whole it is certain, from anatomical characters alone, that birds are modifications of the same type as that on which reptiles are formed, and if this similarity of structure is the result of community of descent, we should expect to find, in the older formations, birds more like reptiles than any existing bird, and reptiles more like birds than any existing reptile. If the Geological record were sufficiently extensive, and the conditions of preservation favourable, we ought to find an exact series of links, but this, of course, is hardly to be expected, and it will be a great step if we can show that certain forms tend to bridge over the gulf between the two groups.

Let us see, then, what the facts of Palæontology tell us in this matter: and first, as to birds.

It is a curious fact that, just as in the case of Crocodiles, all the birds found in the Tertiary deposits differ in no essential respects from those of the present day. Great numbers of remains have been found in beds of Miocene age—beds found at the bottoms of great lakes—and the very perfectly preserved specimens show, beyond any doubt, that the Miocene birds are referable to precisely the same groups as those of our own time. Our knowledge of the Eocene forms is less perfect, but enough is known to show that the same fact held good at the commencement of the Tertiary epoch.

Throughout the secondary period remains of birds are very rare; until lately, in fact, there were none at all. But within the last ten or fifteen years some remarkable discoveries have been made—one or two in Europe, and a whole series in America, which give us some very precise information as to the nature of the Mesozoic birds.

Two of the most interesting of these—the genera *Hesperornis* and *Ichthyornis*—occur in certain beds in the United States, corresponding in age to our later Cretaceous. *Hesperornis* is stated, by its describer, to have had nearly the organisation of our Northern Diver (*Colymbus*); it was five or six feet in length, of swimming habits, had small wings, like those of the Penguin or Auk, and a long beak like the Diver. But—and this is the interesting feature in its organisation—both jaws were beset with teeth: not mere serrations of the jaw, such as many existing birds have, but true teeth like those of a reptile. Here then we have the appearance of a true reptilian character.

*Ichthyornis* was, in some respects, even more curious. It was about as large as a good-sized pigeon, had large wings adapted for powerful flight, and teeth in both jaws, like *Hesperornis*. In another character it showed a still greater approximation to the lower reptilian type: the bodies of its vertebrae, instead of having the cylindrical or saddle-shaped form so characteristic of nearly all birds,<sup>1</sup> were bi-concave. Thus, in tracing birds back in time, we find a parallel series of modifications to those described in the Crocodilia.

Beyond this point, the history of birds is almost a blank, the only other remains being—curiously enough—one or two feathers, and the *Archæopteryx* of the Solenhofen slates, a formation which has been of great service in the preservation of organic remains, the same qualities which make it so useful for purposes of lithography having fitted it for the preservation of even such perishable structures as jelly-fish.

*Archæopteryx*, known only by a single specimen now in the British Museum, was a bird about the size of a

crow. Its head is unfortunately wanting; its tail is quite unlike that of any existing bird, being long, composed of a great number of vertebrae, and having two rows of feathers attached, one to each side of it. The leg is quite like that of any ordinary perching bird. Unluckily, the bones of the wing are detached, so that the exact structure of the manus is not known, but it is quite certain that the metacarpal bones were not united together, but were separate and terminated by distinct claws; there was thus an approximation in structure to a true fore-paw. Long quills were attached to the wings, and both they and the tail-feathers are in an exquisite state of preservation.

With *Archæopteryx* we come to the end of all precise information as to the history of birds, and the only possible trace of the group in earlier formations are certain footprints found in the Trias of Connecticut, and referred to the genus *Brontosomum*. These were prints of some gigantic three-toed animal, which certainly walked on its hind legs, and was always supposed to be an ostrich-like bird until some recent discoveries, presently to be mentioned, have shown that *Brontosomum* may have been a reptile.

It would at first seem easy to show an equally striking approximation of reptiles to birds, for we have, throughout the greater part of the secondary rocks, and notably in the Solenhofen slates, remains of a group of reptiles known as *Pterodactyles*. These remarkable creatures had teeth set in distinct sockets, sometimes extending to the end of the long snout, sometimes stopping short, and having their place taken by a horny beak. The neck was long; the sacrum consisted of from three to six vertebrae; the tail was short in some, long in other genera. The breast-bone had a great keel, like that of a bird, the shoulder-girdle was also quite birdlike, as also were the humerus and the bones of the fore-arm. The manus, on the other hand, was quite different to anything found in birds; the first, second, and third digits were of the usual reptilian character and bore claws, but the fourth was immensely prolonged, produced downwards, and clawless. The pelvis was, in some respects, birdlike, in others quite peculiar: the hind-limb was reptilian.

It is certain that the *Pterodactyles* were animals of flight, and that there was a membrane, like a bat's wing, stretched between the fourth finger and the sides of the body; it is also certain that it was unable to walk, though it may have used its hind-limbs, as bats do, for hanging itself head downwards from branches.

Although these creatures are, in many respects, very birdlike, yet it can hardly be said that they give us any direct help, or that they connect reptiles and birds any more than bats connect birds and mammals. Their avian characters seem to have been purely adaptive, or produced in relation to their peculiar mode of life, and we must therefore try some other line of reptiles for the origin of birds.

In the rocks from the Trias to the later Cretaceous there are, in many places, abundant remains of a group of wholly extinct terrestrial reptiles known as *Dinosauria*. Most of these are of great size, the genus *Iguanodon*, for instance, must have attained a length of fully thirty feet. Our knowledge of most of them is imperfect, but many points of the greatest possible interest are perfectly well known.

Some genera have the snout turned downwards like a turtle's beak, and both it and the large lower jaw were ensheathed in horn. In some the vertebrae are slightly excavated on both faces, and are penetrated with air cavities. The shoulder-girdle consists of a long blade-bone and a short coracoid like that of many lizards. Of the fore-limb nothing is known for certain in the larger species. The sacrum is composed of as many as six vertebrae, which often take on a remarkably birdlike character. More curious still, the ilium has a great forward process,

<sup>1</sup> In this peculiarly avian form of vertebra, the front face of the centrum is convex from above downwards, and concave from side to side, the hinder face being concave from above downwards, and convex from side to side. The Penguins have the dorsal vertebrae opisthocœlous, i.e., with a ball in front and a cup behind.



and the ischium and pubis are both turned backwards, parallel with one another, so as to have almost exactly the same position as in birds. There can be no doubt about this most remarkable point now, as the parts have been found in place in the genus *Hypsilophodon*. The femur was evidently brought parallel to the long axis of the body, and it has the characteristic ridge between the places of articulation of the tibia and fibula. The tibia has a great crest on its front surface, the fibula is quite small, and the flattened end of the tibia fits on to a pulley-shaped bone exactly like the ankylosed astragalus of a bird. The middle or third toe is the largest, and the outer and inner toes small; the metatarsals, although separate from one another, have their faces so modelled that they must have been quite incapable of movement. Substitute ankylosis for ligamentous union, and a bird's metatarsus is produced; in fact the whole structure of the Dinosaurian hind-limb is exactly that of an embryonic bird.

In the very remarkable genus *Compsognathus* of the Solenhofen slates, which is nearly allied to the Dinosauria, and included, with them, in the order *Ornithoscelida*, the head is small, the neck extremely long, and the peculiarities of the hind-limb are entirely bird-like; it also seems that the tibia and astragalus were actually united. The fore-limb, moreover, was very small, and it is certain that *Compsognathus* must have walked on its hind-legs.

The question, then, naturally arises, did the gigantic Dinosauria, such as *Iguanodon* and *Megalosaurus*, have the same mode of progression? This seems, at first sight, hard to believe, but there is considerable reason for thinking that it may have been the case, for, in the case mentioned above of the great three-toed footprints of the Connecticut valley and others found in the Wealden formation, no impression of a fore-foot has ever been found; so that, even if we suppose that the impressions of the fore-feet were entirely obliterated, as the animal walked, by those of the hind-feet, the former must, at any rate, have been very small.

When we consider what a very strong piece of evidence this is, we are forced to the conclusion that the evolution of birds from reptiles, by some such process as these facts indicate, is by no means such a wild speculation as it might, from *à priori* considerations, have been supposed to be.

(To be continued.)

#### THE UNEQUAL DISTRIBUTION OF RARE PLANTS IN THE ALPS<sup>1</sup>

M. DE CANDOLLE has recently distributed copies of a paper communicated by him to the Botanical Congress held at Florence in 1874, in which he explains in a very convincing manner a fact which all botanists have noticed in Switzerland, but the causes of which have not hitherto been properly understood. No one is better acquainted with the plants of the Alps than Mr. Ball, and M. De Candolle prints as a text to his paper a remark made by the well-known author of the Alpine Guide, that it is matter of curious inquiry to ascertain why the vegetation of certain districts of the Alps is more varied than that of others.

Two instances to illustrate this will be sufficient. The mountain chain situated between Italy and the Valais is rich in rare and local plants, while that between the Valais and Canton Bern is very poor; again, after tabulating the species found in Switzerland in single cantons only, while sixty-three are peculiar to the Valais, the Canton Bern has but one.

The explanations which have been given hitherto have

<sup>1</sup> Sur les Causes de l'Inégale Distribution des Plantes rares dans la Chaîne des Alpes, par Alphonse De Candolle. (Florence, 1875)

mainly rested on existing physical causes. Wahlenberg, at the beginning of the century, insisted upon the action of soil and climate. Perrier and Sonjeon have endeavoured to correlate the distribution of plants with that of different geological formations. Grisebach, more recently, cuts the knot by supposing that the Alps have been a centre of vegetation, and that their present distribution is an ultimate fact.

De Candolle has sought the true reason in the circumstances which accompanied the retirement of the glaciers at the close of the glacial period. "The valleys and groups of mountains which have at present a maximum of rare species and the most varied flora, belong to districts in which the glaciers disappeared soonest. On the other hand, where the duration of snows and glaciers has been most prolonged, the existing flora is poor."

The objection which may be made that a cause so remote can hardly influence the present distribution, is met by pointing out the extreme slowness with which a vegetation establishes itself, and the persistence with which it maintains its *status quo* when so established. Thus the rare plants for which the botanists of the sixteenth century were accustomed to visit particular localities may still be gathered there. Again, the Rhone valley is intersected by numerous moraines; the lower and more ancient are covered with chestnuts, while the higher are more and more barren and still covered only with pines.

From a variety of causes which De Candolle enumerates, it seems probable that the southern and eastern glaciers of the Alps were of smaller extent than the northern, and would consequently be the soonest to retreat. They also probably furnished a refuge amongst their ramifications on smaller mountains which even in the Glacial period would be without snow in the summer, to some of the ancient Alpine and sub-alpine plants which were driven southwards as the glaciers increased.

We have therefore the curious fact that some of the most ancient fragments of the Alpine flora are now only to be found on the southern slopes of the Alps. This is the case with species of *Primula*, *Pedicularis*, and *Oxytropis*, which exist neither in the interior of Switzerland nor in the north of Europe. But it is easy to see that, like the other members of this flora, they were driven south during the Glacial period, returning as the mountains reappeared from underneath their snowy covering; while on the northern side they were in great measure exterminated. De Candolle points out as a fact in further confirmation that the Alpine species of *Campanula*, peculiar to Mont Cenis and the Simplon and neighbouring valleys, are not related to the Arctic species, but find their nearest allies in Greece, Asia Minor, and the Himalaya.

The Valais was freed from glaciers while the Mont Blanc district and the interior of Switzerland was still in the condition of Greenland. It was gradually stocked by means of species which arrived from France. The first plants to arrive must have been those which are found at the present time on the Jura and the mountains between Geneva and Chamouni. Established at first in the lower part of the valley, they would ascend as the snow diminished. The remarkable plants of the Grande Chartreuse and of Mounts Vergy and Brezon in Savoy, of the higher parts of the Western Jura, and even of the neighbourhood of Bex in Switzerland, probably belong to this period. When the perpetual snow and glaciers had disappeared from these mountains, the neighbourhood of the Lake of Geneva, the base of the Jura, and even the commencement of the Valais were more favourably circumstanced. Plants of still more southern origin could then arrive from France. This is probably the date at which the box and many *Cistaceæ* and *Labiatae*, characteristic of dry southern districts, established themselves at the foot of the Jura. Seeds carried from Italy by winds or birds introduced some of the rare



species into the Lower Valais, while others of later origin were principally introduced by human agency.

During these changes the Mont Blanc district and the country between the Alps and the Jura were still ice-bound, and seeds carried by the wind from the south and west would fall on snow or sterile moraines. And when in their turn these districts were released, their opportunity of being stocked by the flora fast disappearing from the lower levels had gone. The asylums which were earliest opened were most richly supplied and have remained so.

M. De Candolle considers that a potent cause of the extermination of this flora has been the destruction of the forests which has rendered the climate south of the Alps hotter and drier in summer, and colder in winter.

The rare plants of the Italian Alps are the remains therefore of an ancient flora like that of St. Helena on its last legs. The climate of Europe tends to become drier, and M. De Candolle thinks it probable that in the course of centuries the centre of Switzerland may in turn become relatively rich in rare species, while the southern slopes of the Alps become poor. In the Lebanon and the Pyrenees this reversal of conditions has actually taken place, and their southern face—once rich probably in species remigrating northwards—is now actually poorer than the northern. The Caucasus and the Himalaya are, however, at present comparable with the Alps. T. D.

#### DEEP-SEA TELEGRAPH CABLES: HOW THEY ARE TESTED

THE "testing" of a telegraph cable, whether long or short, proceeds upon the principle that the materials offer to the electrical current a certain resistance: the testing of a cable is the measurement of this resistance. In any cable there are two kinds of these resistance measurements; one of the resistance which opposes the current in its progress along the conducting wire, the other of that which opposes its lateral dispersion. The conductor-resistance is technically termed the copper-resistance, and is extremely small compared with the other resistance. The lateral resistance to the escape of the current opposed by the insulating substance which surrounds the copper-conductor is technically termed the insulation-resistance. Where the resistance to the direct propagation of the electric current through a conducting wire is represented in units, the resistance to lateral dispersion through the insulator will be represented by hundreds, or even thousands of millions, of these units. A third property is that known as the electro-static, or inductive capacity, or simply "charge" of the cable; in other words, that measured quantity of electricity which the given cable will take up in a given time. So much for the necessary explanation of technical terms.

The copper-resistance (1), the insulation-resistance (2), and the "capacity" (3) are the three points to be ascertained in the testing of a cable; and it is useful to inquire why these are the points to be ascertained.

The chief commercial requisite in any cable, and upon which depends its value to its owners, is the speed with which signals can be transmitted. Speed depends directly upon two of the foregoing points (that is upon the copper resistance and "capacity"), and indirectly upon the insulation-resistance. Popular assumption is very much given to the idea that the electrical worth of a cable increases with its insulation-resistance; as usual with popular notions this is only half-truth. That the cost of a cable follows the ratio may or may not be, but it is certain that above a definite limit the thickness of the insulating coating has no effect upon the practical working condition of the

<sup>1</sup> "Capacity" and "charge" are not equivalent terms, although they are so considered in this article to prevent confusion, by the general reader, with the ordinary meaning of the word "capacity." The capacity of a cable remains constant, while the charge varies with the battery power employed.

cable. It may be that minor indirect benefits arise, but with these, under the present consideration of the practical testing of a cable, we have nothing to do. A certain standard of insulation-resistance attained, there remain the two points, first, of the resistance offered by the copper wire; secondly, of the charge. Now it is collaterally to be understood that, as there can be obtained through a pipe a greater flow of liquid when the pipe offers little resistance to the flow, so through the conductor of a cable can a greater flow be obtained when the conductor has low resistance. With most of the Atlantic cables each nautical mile of the conductor has a resistance equal to that of three to four of the arbitrary units selected by the profession for comparison. There are in use two units of electrical resistance, namely, that determined by a committee of the British Association and the Siemens unit. These units are very nearly of the same value, one Siemens' mercury unit (the resistance offered by a column of pure mercury of one metre length and one square millimetre section at 0° C.) being equal to 0.9536 of an Ohm, the technical term for a British Association unit. There is, then, to be considered an electrical length as well as an absolute (or ordinary) length; the proportion that one bears to the other being known, the measures are convertible. Vague as may appear to the reader this idea of electrical resistance, when he knows that of a copper wire of given diameter or weight two lengths offer twice the resistance of one, he is as learned as the most skilled electrician who virtually knows no more.

The consideration of the electrical capacity of a cable is more difficult. While the two other points relate to mass, the question of capacity involves that of surface, and of a property of the insulating material of the cable known as its "specific inductive capacity." The material with which long telegraph cables are insulated is gutta-percha. Two different cables may be insulated with this material to precisely the same dimensions, both as regards the thickness of the insulator and the thickness of the copper wire, but the "charge" taken by these cables may be very different, and the difference will be due to difference in the specific facilities offered by the two gutta-perchas to induction. This difference between various kinds of gutta-percha is as inherent as is the difference between resistances to conduction offered by different metallic alloys, and is probably very often due to want of homogeneity of the substance. It is by judicious selection and careful manipulation that the cable manufacturer is enabled to maintain a certain standard for any particular cable in question. Capacity, however, not only varies with the insulating material, but it also varies with the amount of surface of the conductor. It is different with different thicknesses of insulating material, but in this respect, after a certain limit has been passed, the decrease in capacity is very small for very large increase in the thickness of the insulating material.

High charge is incompatible with high speed. That cable will, other conditions the same, have the greatest speed in which the charge, or the fraction of the charge to be altered at each signal, is least. Professional necessity has given rise to a unit of quantity of electricity termed a "farad," of which the "micro-farad" is the millionth part. The capacity of a telegraph-cable generally ranges from three to four-tenths of a micro-farad per nautical mile.

The object of testing a cable is, then, to ascertain whether the insulation reaches the amount specified, and whether the conductor-resistance and the charge are of the required minimum. As these tests are each applied separately to the cable, their consideration will fall under the several heads. It would clearly be impossible within the limits of this paper to describe the many methods which have from time to time been proposed and in use for the testing of telegraph cables. The first methods of testing submarine lines are undoubtedly due to Dr. Werner



Siemens and Dr. C. William Siemens, who early in the history of submarine telegraphy communicated their researches on the subject to the British Association at the Oxford meeting of 1860. The principle of these early methods still remains the principle of the methods employed by Sir W. Thomson in his testing of the Direct United States Cable at Ballinskelligs Bay Station in September, 1875, and upon which he has reported to the manufacturers of the cable, Messrs. Siemens Brothers. It is the purport of this paper to describe these tests and the results obtained.

To those who may be unacquainted with the route of the Direct United States cable, it will be necessary to explain that the course taken is from Ballinskelligs Bay, on the west coast of Ireland, to Torbay, in Nova Scotia, whence it again passes to Rye Beach, in New Hampshire, America.

The construction of the cable, which was decided upon by the company acting under the advice of Dr. William Siemens, their scientific consultant, is as follows:—The cable from Ireland to Nova Scotia consists of a conductor formed of a strand of twelve copper wires weighing 400 lbs. per nautical mile. This conductor is surrounded with four coatings of gutta-percha and gutta-percha-compound weighing 360 lbs. per nautical mile, so that the total weight of the "core," as it is technically termed, is 760 lbs. per knot. It was specified that the core should have an insulation resistance per nautical mile equal to 160 millions of mercury units; tests, however, checked and taken under the direction of Mr. von Chauvin, the manager and electrician to the Company, show that no length of core was passed that did not insulate to nearly double this extent, or to 300 million units per knot, the tests being taken after twenty-four hours' immersion of the core in water at 75° F. The "core" is "served" or enveloped in jute yarn, and is then sheathed or covered with iron wires of a diameter best suited to the position of the cable. Thus for the deep-sea, 1,630 knots of the cable are sheathed with ten strands of wire and hemp, each strand consisting of a homogeneous iron wire surrounded with five strands of Manila hemp, each strand being passed through a compound of pitch, tar, and india-rubber. Each of the iron wires has an average breaking strain of 53 tons per square inch, and is of 0.099 inch diameter. The cable termed medium cable is sheathed with fifteen wires of 0.148 inch diameter with proper sewings of yarn, while for the shore ends, where there is considered to be more friction or wear, this medium cable is again surrounded with iron sheathings of twelve strands of iron wires, each strand consisting of three iron wires of 0.230 of an inch diameter.

The cable from Nova Scotia to New Hampshire consists of a strand conductor of seven copper wires weighing 107 lbs. per knot, covered with three coatings of gutta-percha and compound weighing 150 lbs. per knot, and is also sheathed with iron wires.

The non-electrical reader who may choose to wade through detail that must be somewhat technical will perhaps find help in considering the conducting wire as representing a line of flow or force, such that if two of these lines be directed into a galvanometer or current-measurer in opposite directions, that having the greatest head or greatest force will preponderate, while no indication will be found on the instrument when the forces are equal; also that from a known force giving through a known resistance a certain instrumental measure, any unknown resistance may be reduced when its instrumental measure is ascertained.

*Testing the Resistance of the Copper Conductor.*—Electrical measurements upon a long submerged cable differ from measurements made in the laboratory as described in text-books in one very important particular—that of earth-currents. Earth-currents are the *bête-noir* of the electrician, who not infrequently finds them so far

masters of the field that his chance of obtaining accurate measures is a poor one. Fortunately, earth-currents do not have so much influence upon the working of a cable as they have upon the testing, and more fortunately still these currents do not always exist, so it is possible to obtain measures during a tranquil period. On the Direct United States' Cable, Sir William Thomson found these currents to be equal in value at a period of greatest strength to that from about eighteen cells of the testing-battery—the Irish end being positive generally to the Nova Scotian end. Under such conditions, Sir W. Thomson employed the simple deflection-method of measuring the conductor-resistance, which he takes to be "the only proper method for measuring copper-resistance in a submerged cable." In the following description of the method and its results, it will be seen that the method consists in applying together with a measuring instrument an electric force which yields a certain measure through the unknown resistance of the cable; a known resistance (7,300 units) is then substituted for the resistance of the cable, and the latter determined by proportion. The principle of this method is applicable not only to the measurement of the copper-resistance, but is that also of the ordinary method of measuring insulation-resistance, a higher known resistance being used in order more readily to effect comparison with the unknown and much greater insulation-resistance. The actual operation during the period of testing is thus described:—

"The insulation-galvanometer quickened three- or four-fold by a magnetic adjustment, and, with a shunt of twenty Siemens' units on its coil, was put in circuit between line, battery, and earth, and the deflection was observed and recorded every ten seconds. As was to be expected, large and rapid variations of the deflections were continually taking place on account of earth-currents. The direction of the earth-current was from east to west the whole time, as was shown by the 'copper' current being always greater, and the 'zinc' current less, than the true mean concluded from the observations. It increased gradually (but with some slight backward pulsation) from the beginning—when its amount was that due to a difference of potentials between the Ballinskelligs and Torbay earths equal to 1.7 of a cell—till the end, when it was more than five times as strong, and corresponded to nine cells; the Irish earth positive relatively to the Nova Scotian earth the whole time. To measure the copper-resistance a time of comparative tranquillity was chosen, a reading taken, and then as quickly as possible the galvanometer short-circuited, the battery reversed, the galvanometer circuit reopened, and a fresh reading taken. Half the space travelled by the spot of light from the first reading to the second is taken, as being the deflection which would be produced by the battery applied in either direction were there no earth-currents. This was done seven times, and the half ranges were as follows:—235, 231, 229½, 234½, 231, 235, 230—mean 232.3. I found that the same battery applied in the two directions through the galvanometer, and 7,300 Siemens' units gave 232 divisions on one side of zero, and 233 on the other—mean 232.5. Hence the copper-resistance to be inferred from the observations is—

$$7300 \times \frac{232.5}{232.3}, \text{ or } 7306 \text{ Siemens' units.}''$$

As the cable in question is 2,420 nautical miles in length, we have  $\frac{7306}{2420} = 3.02$  Siemens' units per knot.

*Insulation Test.*—The ordinary method of testing the insulation-resistance of a cable consists, as has been said, in obtaining upon the galvanometer or measuring instrument a certain measure with a known resistance, and a measure with the unknown resistance, the electric force being constant during the two measurements. From these two measures the unknown resistance is determined.



If, for instance, it is known that with a certain battery power and a resistance of 100,000 units we have a deflection-measure of 100, it is deduced, when with an unknown resistance and the same battery power the deflection of 50 is obtained, that the resistance must be twice as great (namely, 200,000), since the observed effect is halved. This system is that generally pursued, but, like the other measurements upon submerged cables, comes under the effect of earth-currents; and to meet this contingency Sir William Thomson has arranged a new method, bearing upon the principle that the insulation of a cable may be determined from the proportion of loss (during a given time) of electric power that has been imparted to it. In the following description it will be seen that this loss is measured by the deflection due to the current entering the cable to make up the loss, and this deflection is compared with another deflection obtained by altering suddenly by a small quantity the battery power employed. The latter deflection being a measure of a known force or potential, the other measure for lost potential is determined, and consequently the loss of potential known.

"The cable being offered to me again from midnight till 2 A.M. on the 17th, I made," says Sir W. Thomson, "another series of tests at that time for the main object of measuring the insulation-resistance. I found the line in a much less disturbed state, and was able to make a perfectly satisfactory insulation test by the ordinary galvanometer method. I applied, however, also a new method which (no electrometer being available) I had planned to meet the contingency of the line being disturbed by earth-currents so much as to render the ordinary test unsatisfactory, but not so much as to vitiate an electrometer-test. This method, which I think may be found generally useful for testing submerged cables when an electrometer is not available, is as follows:—1. Apply the ordinary test by battery and galvanometer for a certain time. 2. Insulate the cable for a certain time and then shunt the galvanometer to prepare for No. 3 (unless you have conveniently available a second galvanometer suitable for discharges). 3. Instantaneously reapply the battery, through the insulation galvanometer properly shunted (or a special discharge galvanometer), to the cable, and observe the maximum of the sudden deflection produced. 4. Go on repeating Nos. 1, 2, and 3 as long as you think proper, according to circumstances. 5. To determine the proper ballistic constant of the galvanometer for utilising the observed result of No. 3, find the maximum of the sudden deflection which takes place when a sudden change of electrification is produced by instantaneously changing by a small measured difference the potential of one electrode of the galvanometer, the other electrode being in connection with the cable. 6. The change of potential which, in the operation of No. 5, would give the same deflection as that observed in No. 3, is equal to the change of potential which the conductor of the cable has experienced during the time when it was left insulated according to No. 2. Hence calculate the insulation-resistance in ohms or megohms as in the ordinary electrometer method when the electrostatic capacity of the cable is known."

In carrying out this test, the 20-cell insulation battery (with its poles joined through 20,000 Siemens' units) was applied, zinc to cable, through the insulation galvanometer with a shunt of 5,000 Siemens' units on it. Then, the galvanometer indication was read and recorded every ten seconds for three and a half minutes, when the cable was insulated during a minute according to No. 2 of the directions above, and a shunt of 30 substituted for the 5,000. At the end of the minute the battery was instantaneously reapplied, the throw of the galvanometer observed according to No. 3 and the shunt of 30 removed, and 5,000 reapplied. The cable was again insulated for a minute, the galvanometer shunted with 50 (instead of

30 used the first time), and the operation of No. 3 repeated. The proper ballistic constant of the galvanometer was determined by applying alternately full power and  $\frac{1}{10}$  of full power of the insulation battery; the change from one power to the other being made in each case as instantaneously as possible. Twelve galvanometer readings taken at ten seconds' intervals during the second and third minutes of the electrification gave for mean deflection 127, and the readings taken from the fourth to the twenty-fourth minutes gave for mean deflection 82.1. The sensibility of the galvanometer in the condition in which it was used for these readings was such that a deflection of 290 would have been given by the actual battery, with a resistance of 1,000,000 Siemens' units. Hence the insulation-resistances proved by the mean observed deflections were for the deflection, 127 from the second and third minutes 2,280,000 Siemens' units, and for the mean deflection 82.1 from the fourth to twenty-fourth minutes 3,540,000 units. The new method described gave, as the mean of the observed ballistic deflections or "throws," the number 89.8, or say 90. The ballistic deflection due to instantaneously changing the potential by  $\frac{1}{10}$  of that of the insulation battery, in accordance with the rule of one to five above, was found to be 112 divisions. This is  $1\frac{1}{4}$  time the preceding mean throw (90), which therefore showed a change of potential equal to  $\frac{1}{10}$  of that of the battery. Hence the mean fall of potential was  $\frac{1}{10}$  during the minute, or at the rate of  $\frac{1}{3000}$  per second. The capacity of the cable (measured in the way presently described) had been found to be 991 microfarads. Hence the insulation-resistance is  $\frac{3000}{991}$ , or 3.027 megohms, or 3,170,000 Siemens' units, corresponding to the 3,540,000 units given by the ordinary method. With copper to line, a fresh series of tests gave 3,520,000 megohms, or 3,690,000 Siemens' units.

In the reduction of the insulation-resistance of the whole cable to its insulation-resistance per knot, it has to be observed that as the insulation of the cable is inversely as its length, one knot of the cable will give an insulation resistance equal to that of the whole cable multiplied by the number of knots' length in the whole cable.

*Measurement of "Capacity."*—Just as the chemist has his vessels for measuring out quantities of liquid, so has the electrician his special arrangements for measuring out quantities of electricity; but there the analogy ends, for while the measure of the liquid is direct and visible, the electrician infers his measured quantity generally by the mechanical work effected on the index of the measuring instrument, or by the absence of such work. The apparatus used in practice for measuring quantities of electricity is termed a "condenser." "Condensers" are constructed having any required capacity, and if such a condenser of which the capacity is known is charged from a battery, then discharged through the measuring instrument, and the deflection produced noted, it is only required to charge from the same battery the cable or any other condenser of which the capacity is to be measured, then to note this discharge deflection, and by proportion to deduce the unknown capacity. On short lengths of cable this procedure is actually adopted, but on long lengths it becomes liable to error, chiefly from the fact that as with long lengths some perceptible time is required to discharge the cable, the ballistic throw or sudden deflection produced upon the measuring instrument by the rush of electricity from the cable does not measure all that passes out. It is consequently necessary to devise some method like the following used by Sir W. Thomson, in which the charge from the cable (communicated thereto by a different battery power to that charging the condenser, but the relative powers being known) is neutralised by a charge of opposite electricity from the condenser, and the neutralisation declared by the non-production of movement in the measuring instrument.



The following diagram, which is not, however, taken from the report, will explain the method:—

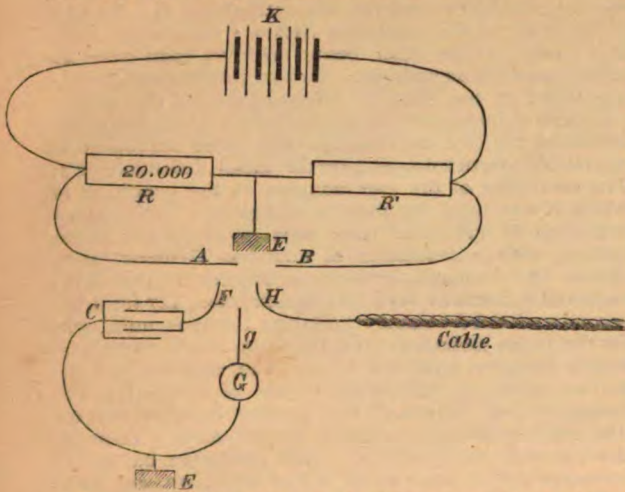

**K**, battery of 80 cells, well insulated; **R** resistance of 20,000 units; **R'**, variable resistance; **C**, condenser of 80 microfarads' capacity; **G**, shunted galvanometer; **x**, earth.

The condenser is electrified by bringing **F** and **A** into contact, and the cable by making contact between **H** and **B**, for sufficiently long time to fully charge the cable. These contacts are then broken, and instantly after contact made between **F** and **H**. This contact is maintained for five to ten seconds, when the additional contact with **g** is made. The variable resistance is adjusted till this last contact produces no movement on the measuring instrument.

It was found that when the cable and condenser were charged to opposite potentials in the proportion of 1,615 to 20,000 no throw occurred, whence the deduction that the capacity of the cable was

$$\frac{20000}{1615} \times 80 \text{ microfarads, or}$$

991 microfarads, and the length of the cable being 2,420 knots, this was equal to 0.409 of a microfarad per knot.

In concluding the report upon the electrical conditions of the Direct United States Cable, Sir William Thomson remarks: "I am glad to be able to say that my tests proved the cable to be in perfect condition as to insulation, and showed its electrostatic capacity and copper resistance to be so small as to give it a power of transmitting messages, which, for a transatlantic cable of so great a length, is a very remarkable as well as valuable achievement." This article would be exceeding its purpose if it were to include inquiry into the present position of Atlantic Telegraphy; but it is a mark of great progress in electrical engineering and cable manufacture that a cable of such length as 2,420 miles can be delivered up to the company working it in a perfect electrical condition. This has not been the case in earlier transatlantic attempts; and some idea may be formed by the general reader of the care required to bring about this end, when it is known that a small hole, smaller in size than the finest pin-hole, in any portion of the two thousand miles length of gutta-percha covering would render the electrical conditions of the cable imperfect.

#### THE CLIMATIC CHARACTERISTICS OF WINDS AS DEPENDENT ON THEIR ORIGIN<sup>1</sup>

OF the climatic characteristics of winds the most important are, primarily, their temperature, and, secondarily, their moisture. The general occurrence of

<sup>1</sup> Ueber die Abhängigkeit des Klimatischen Charakters der Winde von ihrem Ursprunge. Von Dr. W. Köppen. (St. Petersburg, 1874.)

certain characteristics, especially when more strongly marked, with particular directions of the wind, experience soon forces on our attention, and much labour has been bestowed, particularly by Dove, in grouping the winds simply according to their directions, and calculating the mean atmospheric pressure, temperature, humidity, cloud, and rainfall, for each of the directions. Interesting and to some extent valuable results have been obtained from these inquiries; results, it must, however, be added, far from being commensurate with the enormous labour expended in arriving at them. But in extending this line of research into such regions as Western Norway, Faiö, Iceland, Newfoundland, and the Azores, its unsatisfactoriness soon becomes evident; and the further consideration that the climatic qualities of a particular wind repeatedly differ widely from its general character, makes it evident that a climatic inquiry which groups the winds merely according to their direction does not proceed from a scientific basis.

A striking case, showing a great deviation from the general qualities of a wind, occurred during the great Edinburgh hurricane of the 24th of January, 1868, on which occasion the wind remained persistently in the south for several hours, and possessed a coldness and a dryness which were truly polar. The qualities of this south wind are readily explained by the limited area of high pressure, which lay immediately to the south-eastward of Scotland at the time, out of which this wind blew. As the barometer continued to fall, the wind ultimately veered to S.W. and W., and the temperature presented the unusual phenomenon of rapidly rising with a change of the wind into westward. The point to be noted here is, that as long as the wind was connected immediately with the circumscribed area of high pressure it was cold and dry, but when it was involved in the area of low pressure it became mild and moist. This relation between the climatic qualities of a wind and the state of the pressure is a vital point in atmospheric physics, and to Dr. Köppen belongs the merit of applying the principle in inaugurating a new method of inquiring into the climatic characteristics of the different winds by referring each wind-observation to the system of atmospheric pressure with which it is at the moment immediately connected.

If we examine weather-charts representing a large portion of the earth's surface, such as those published in the *Journal of the Scottish Meteorological Society*, vol. ii. p. 198, two distinct systems of pressure are seen, which change their position and form from day to day, one indicated by isobars inclosing spaces of low pressure, into which the winds all round blow vorticosely in the northern hemisphere in a direction contrary to that of the hands of a watch, and the other by isobars inclosing areas of high pressure, out of which the winds blow on all sides, but in opposite directions to those assumed in blowing inwards upon a space of low pressure. The former are usually called cyclones, and the latter anticyclones. Not only do the direction of the winds within the areas of cyclones and anticyclones respectively differ from each other, but the temperature and humidity of the winds connected with each have certain well-marked characteristics. A south-east wind at St. Petersburg, for instance, blowing in immediate connection with a cyclone, comes from the south and south-west, that is, from the south-west of Russia or from Germany; whereas a south-east wind in immediate connection with an anticyclone comes from the east, that is, either from the east of Russia or from the White Sea, and consequently these two south-east winds are markedly different in their climatic qualities from each other.

Dr. Köppen has compared the temperature, humidity, and other weather conditions at St. Petersburg each day for 1872 and 1873 with daily weather-charts constructed for the whole of Europe, and separated each of the eight winds (N., N.E., E., &c.) and calms into the following



four classes:—1. Those which occur when the isobar, passing through St. Petersburg, bounds a space of low pressure, or when St. Petersburg is included within the area of a cyclone; 2. When the isobar bounds the space of high pressure, or is within the area of an anticyclone; 3. When it is in the calm centre of an anticyclone; and 4. When the isobar does not, at least on the map of Europe, inclose a space, but stretches away in a line which is either straight or irregularly waved. This division is carried out as regards the two great divisions of the year, viz., the cold half, extending from October to March, and the warm half from April to September.

The following will indicate the importance of the results arrived at:—1. *During the cold half of the year*, northerly winds (N.E. and N.) when connected with a cyclone have the pressure 0.370 inch below the average, the temperature 2°3 above the average, the relative humidity 90, and the sky all but completely covered with cloud; with an anticyclone, pressure is 0.271 inch above the average, temperature 8°6 below the average, humidity 84, and sky only three-fourths covered; and with a straight indeterminate isobar, pressure is 0.201 inch above the average, temperature 5°8 below the average, humidity 89, and sky less than three-fourths covered. 2. *During the warm half of the year*, northerly winds connected with a cyclone have pressure 0.192 inch, and temperature 5°4 below the average, humidity 87, and cloud 8; with an anticyclone pressure is 0.206 inch, and temperature 0°5 above the average, humidity 75, and cloud 4; and with straight indeterminate isobars, pressure is 0.104 inch above, and temperature 3°4 below the average, humidity 76, and cloud 5.

As regards the S.E. wind, with a cyclone the temperature is 7°2 above the average in winter, but only 1°8 in summer; and with an anticyclone, 4°0 below the average in winter, but 2°5 above it in summer. Again, with straight isobars, S.E., S., and S.W. winds have in winter a temperature 7°7 above the average, humidity 93, and cloud 9; but in summer the figures are 5°2, 82, and 6 respectively. One of the most suggestive results is that obtained from the examination of the anticyclone in summer, particularly as regards its calm central space. In the periphery of the anticyclone where winds prevail, the cloud accompanying the different winds varies from 3 with S.W. to 5 with E. winds, but in the calm central space the amount is only 2; in other words, the space covered by the anticyclone is remarkable for the clearness of its sky, and the central portion is the clearest. Owing to the strong insolation which takes place under these circumstances, the temperature of the whole space covered by the anticyclone is raised 2°1 above the average; with northerly winds (N.E., N., and N.W.) the excess is, as might be expected, small, being only 0°5, but with S. and S.W. winds the average excess is 4°1. The excess in the calm centre is only 1°3, which is smaller than the excess which accompanies winds from the E., S.E., S., S.W., and W. points of the compass.

In a review of the weather of Europe during 1868,\* Mr. Buchan drew attention to the anticyclone which overspread a considerable portion of Europe from the 2nd to 4th August, as the immediate cause of the hot weather experienced in Great Britain at the time, and which he regarded as the simple result of the widespread high pressure, the comparatively calm atmosphere, the clear sky, the dry air, and the strong insolation which accompanied these conditions. At the same time, to the west, north, and south-east, pressures were low, the sky clouded, and much rain fell. Since the wind blew out from the anticyclone in all directions,—E. and S.E. winds in Great Britain and France, W. in Austria, and S.W. in Sweden and W. in Russia,—without diminishing the high pressure of the anticyclone, it was suggested that

the high pressure was maintained by air-currents ascending from the regions of low pressure to the west, north, and south-east, and thence flowing as upper currents towards and then down upon the region of the anticyclone. In connection with this point Clement Ley has made some valuable observations on the upper currents of the atmosphere, showing that they flow outwards from the centre of the cyclone, and inwards towards the anticyclone. If this view be correct, the centre of the anticyclone must necessarily be filled with a slowly descending current.

Now, it will be observed from Dr. Köppen's inquiry that the centre of the anticyclone is the clearest, on leaving which and entering the regions in which winds blow, the sky becomes more clouded—a result strictly in accordance with a descending current over the calm region of the centre. Again, in the calm centre the temperature is lower than round the periphery (except where N.E., N., and N.W. winds prevail, bringing air currents from colder regions, and therefore of a lower temperature), a result admitting of explanation only on the supposition of a descending current within the central space, since, were there no descending current, the temperature would be hottest in the centre where the atmosphere is clearest and the air stillest.

We are now, thanks to Dr. Köppen, put in possession of a truly scientific method of discussing wind-observations in their climatic relations, the value of which will be the more apparent when the observations of places in different parts of Europe have been discussed in accordance with it. What is now wanted, as regards the difficult but vital question of the observation of the wind, is that truly comparable anemometers be procurable, and that they be placed in situations and positions so that they may fairly record the direction, velocity, and pressure of the air-currents which pass over the district where they are placed.

### SCIENCE IN GERMANY

(From a German Correspondent)

M. VON JOLLY, in Munich, has recently constructed an apparatus for gas-determination by absorption. Its arrangement is, in general, similar to that of Frankland's apparatus, but it is distinguished from this, as from all other apparatus hitherto used for gas analysis, by the principle of measurement that is peculiar to it. Measurement is made, not of the changes of volume, which, for example, the air undergoes through absorption of carbonic acid and of oxygen, but of *changes of pressure, the volume remaining the same*. All the air-quantities to be measured are brought to the same volume, through corresponding change of pressure, in a measuring vessel, the contents of which must not be known; while a temperature of 0° is produced by surrounding the measuring vessel with snow or ice. Thus, each time the tension is measured under which the air-quantity to be considered assumes that constant volume, before and after absorption of a portion of the mixture. This process has various advantages over those hitherto in use. The calculation of the gas-volumes at normal pressure and temperature is rendered superfluous; the number of separate observations required is diminished.

M. Jolly's apparatus is represented in the annexed figure. A is the absorption bell-jar; it is of nearly 100 c.c. capacity. It is open below, and stands in a pneumatic trough. B is the cylindrical measuring vessel of equal capacity with the absorption jar. By means of a T-shaped perforated glass cock *h*, the vessels A and B can be connected; they can also be put in communication with the atmosphere by the capillary tube *g*. B is connected by means of a capillary tube, with a wide glass tube E. At *f* there is, within the curve, where the capillary tube opens, a small tongue of dark glass, 1 to 2 mm. long, with

\* Atlas Météorologique de l'Observatoire Impérial, Année 1868, D. 39, Paris, 1869.



the point directed downwards. (This point serves the purpose of fixing with certainty the surface of the mercury contained in E, for the point is reflected in the surface of the meniscus.) E is connected by means of caoutchouc tubing with a wide vessel D, which is fixed to a moveable carrier, and can be easily moved up and down. The tube C, which forms the vertical prolongation of the vessel D upwards, moves before a scale with millimetre divisions.

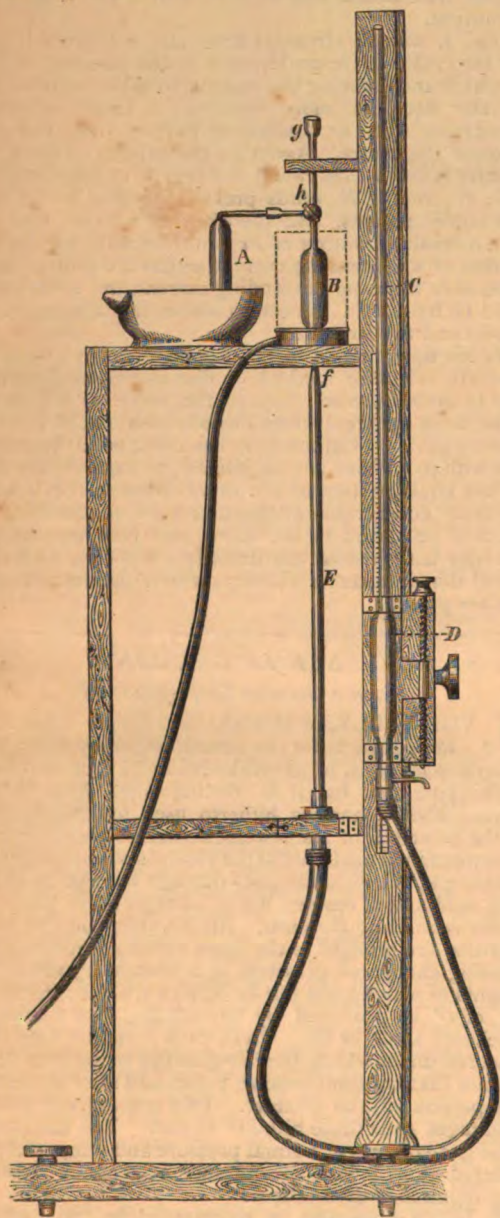

When the apparatus is to be used, a portion of D and E is first filled with mercury. Then the cock *h* above is opened and D pushed up to the height of the cock; whereupon the rising mercury fills the measuring vessel B, while the vessel D gets emptied. When the rising mercury comes into view in the small funnel *g*, you shut the cock and bring the vessel D down again, whereupon the mercury runs out of the measuring vessel and leaves there an empty space. If B be now connected with A the air is sucked over from the absorption jar into the measuring vessel, while the mercury of the pneumatic trough rises

in the absorption jar. This air is also removed from the apparatus in the way above described. The air-specimen to be examined is now brought into the absorption jar, and allowed to pass over into the measuring vessel, which is surrounded with snow or pounded ice.<sup>1</sup> When the gas is cooled, the mercury in E is so placed that the tongue point touches the meniscus. Since the scale numbers begin at the height of the tongue point, by reading off the position of the mercury in D, the height of the mercury column is obtained, which taken together with the tension of the included air-specimen, makes equilibrium with the external air-pressure. On deducting from the immediately observed barometer height the observed column of mercury, the pressure of the enclosed air at 0° is obtained. Next, by suitable position of the vessel D and turning of the cock, the measured air-specimen is allowed to flow over again into the absorption jar. Afterwards, some small pieces of fused pyrogallic acid are introduced with a pincette under the mercury into the absorption jar. When the resulting absorption of the oxygen is finished, you measure, in the same way, in the measuring vessel, the tension of the remaining nitrogen. (The tension of the saturated water vapour at 0° = 4.6 mm. is deducted in each calculation from the tension obtained in the measuring vessel.)

Let *V* be the volume of the measuring vessel, *P* the pressure of the air-quantity contained in it, then, according to Mariotte's law—

$$VP = 760y,$$

if *y* denotes the volume of this air-quantity at 0° C and 760 mm. Let *P'* be the pressure of the remaining nitrogen, then—

$$VP' = 760x,$$

where *x* denotes the volume of this quantity of nitrogen at 0° C and 760 mm. Consequently—

$$x = y \frac{P'}{P} = 100 \frac{P'}{P}$$

if *y* = 100.

When it is wished to analyse breathed air with this apparatus, the carbonic acid is first removed with potash lye, and the oxygen with pyrogallic acid. The oxygen may also be removed with a piece of phosphorus, by inflaming it with an induction-spark in the absorption jar.

It is known that the experiments which have been made by Maxwell, O. E. Meyer, Obermeyer, and Puluj, on the dependence of friction of gases on temperature, have not led to concordant results. M. Puluj has therefore lately made a large number of experiments with air, hydrogen, and carbonic acid, in order definitely to determine the relation between friction of gases and the temperature. This investigation was carried out in the laboratory of Prof. Kundt, in Strassburg. The apparatus used for the purpose was the friction apparatus of Kundt and Warburg, which is essentially not very different from Maxwell's, and consists of a glass disc oscillating between two fixed discs.

According to the dynamical theory of gases, the constant of friction should be proportional to the square root of the absolute temperature, *i.e.*—

$$n = n_0 (1 + a \theta)^{\frac{1}{2}}$$

where *n*<sub>0</sub> denotes the constant of friction of the gas at temperature  $\theta = 0^\circ \text{C.}$ , and *a* the coefficient of expansion of the gas. If we make, generally,

$$n = n_0 (1 + a \theta)^n$$

we have from the experiments of Puluj—

For air,  $n = 0.72196 \pm 0.01825$  between  $-3^\circ \text{C.}$  and  $+25.6^\circ \text{C.}$   
 For H,  $n = 0.69312 \pm 0.01088$  "  $-1.5^\circ \text{C.}$  and  $+30^\circ \text{C.}$   
 For CO<sub>2</sub>,  $n = 0.91654 \pm 0.01394$  "  $+1^\circ \text{C.}$  and  $+29^\circ \text{C.}$

The exponent for air is smaller than Meyer's (2).

<sup>1</sup> To apply the ice a vertical sheet-iron cylinder is used, separable into halves; it surrounds the measuring vessel at an interval of about 3 cm. In the figure the outline of the cylinder is shown by dotted lines.



and larger than that formerly obtained by Puluj from transpiration-experiments with capillary tubes ( $\frac{3}{8}$ ). The exponent for hydrogen is somewhat smaller than that for air. Not a little interesting is the remarkably large exponent for carbonic acid, in which the friction appears nearly to follow the law of temperature, to which Maxwell's new theory of gases leads (which, as is known, proceeds from the supposition of a repulsive action at a distance, inversely proportional to the fifth power of the distance of the molecules).

From these experiments it clearly appears that *the friction does not, in all gases, vary with the temperature in the same way*. The theory of gases must still undergo modification, in order to afford us a satisfactory explanation of this molecular process. S. W.

### THE EARLY HISTORY OF MAGNETISM

THE earliest references to the properties of the magnet occur in the annals of the Chinese nation, who used it as a means of guiding the wayfarer over the vast and trackless plains of Eastern Asia, long before it was applied to maritime purposes. To the Emperor Hoang-Ti, who lived 2,000 years before our era, is attributed the invention of a chariot, upon which stood an elevated figure pointing to the south, independently of any position of the chariot. Nearly ten centuries later, we find the learned Tchéou-Koung presenting and teaching the use of the tchi-nán-kiu, or chariot indicating the south, to some envoys from Youé-tchang, a southern maritime province. The compass, or, as it is even now called in Chinese, *tchi-nán*, appears to have been first used at sea by this remarkable nation about the third century of our era, during the Tsin dynasty.

When the compass became known in Europe is disputed; Gilbert refers its introduction to Marco Polo about 1260,\* but it is probable that earlier accounts of it were brought from the East by the Crusaders, an accurate description of it occurring in a poem entitled "La Bible," written by the minstrel Guiot de Provence about the year 1190. A Latin letter ascribed to Peter Adsigier, 1269, preserved among the manuscripts of the university of Leyden, contains the following remark on the declination of the needle:—"Take notice that the magnet, as well as the needle that has been touched by it, does not point exactly to the poles, but that part of it which is reckoned to point to the south declines a little to the west; and that part which looks towards the north inclines as much to the east. The exact quantity of this declination I have found, after numerous experiments, to be five degrees."

The discovery of the dip of the needle is due to Robert Norman, a nautical instrument maker at Wapping, near London, who is described by Gilbert as "a skilful sailor and ingenious artificer." He found that after being touched by a magnet the needle always appeared heavier at its northern end, and making an instrument to determine the greatest angle formed with the horizon, he observed the inclination in 1576 to be  $71^{\circ} 50'$ .

In the early part of the following century, the variation of the declination was clearly ascertained, and was attributed by Bond, a teacher of navigation in London, to the motion of two magnetic poles.

In the year 1600 was published the celebrated treatise "De Magnete," by Gilbert of Colchester, who was pronounced by his great contemporary Galileo, to be "great to a degree that might be envied." Gilbert regarded our globe as a great magnet, and its centre as the centre of the magnetic motions of the earth. Variation he defines to be the arc intersected between the point where the meridian of the place cuts the horizon, and that point to

which the magnetic needle looks; the length of this arc varying with the place of observation. He states that from the coast of Guinea to the Canary Islands, and thence throughout Spain, Gaul, England, Germany, and Norway, the magnetic needle turns towards the east, that on the opposite shores of North America it turns to the west, whilst near to the Azores it points exactly north and south; nor does he fail to observe that from the north of Brazil, along the coast of South America to the Straits of Magellan, the southern end of the needle points west of the true meridian. He rejects the vulgar opinions of variation depending upon magnetic mountains or magnetic rocks, upon the poles of the zodiac, or the positions of certain fixed stars, but ascribes it in some measure to the configuration of sea and land on the surface of the earth; chiefly, however, to irregularities in what he terms the magnetic globe and true earth, which he conceives to be more considerable under the continents than below the depths of the ocean. He devotes the fifth book of his work to a full account of the dip of the needle, termed by him declination, with a minute description of the instruments used in its measurement.

Descartes attributes variation to the irregularities of the earth's surface, considering magnetic attraction strongest wherever iron and loadstone are most abundant. To account for the variation of the compass, he asserts that the amount of iron in certain localities constantly changes, partly because man draws it from one place to transport it to another, and partly because new iron is formed in some districts where there was none before, whilst in others old iron becomes corrupted and disappears entirely. To explain his theory of magnetism it is necessary to state briefly the hypothesis he formed respecting matter in general, an hypothesis for which he does not claim absolute truth, but one from which deductions may be made in conformity with experience. The universe he supposed was formed originally of one uniform material, divided into equal parts having equal movements. These movements he considered to be twofold, each part revolving on its own axis, and several together revolving round fixed centres, and thus forming distinct vortices. As he deemed no void possible, it followed that these parts being equal, could not at first have been round, but might eventually become so, their angles as they met together being rubbed off and the intervening spaces filled with the dust or *débris*.

Descartes considered these two forms of matter as two elements of the universe, the first consisting of the *débris* and the second of the little spheres. The less agitated parts of the first move chiefly in straight lines from the poles to the centre of each vortex, and in passing through the triangular spaces often left between contiguous balls of the second element, they assume the form of fluted, spiral columns. On the disposition of their channels the force of the magnet principally depends. His third element is formed by the union of the less subtle matter of the first, including the fluted columns. From the centrifugal force of the round parts a central space is left within each vortex, composed purely of matter of the first element; this Descartes supposed to form an extremely subtle body, such as he conceived the fixed stars to be, and even considered that the earth formerly occupied such a centre till the less subtle matter collecting on its surface changed into that of the third element, and thus formed clouds and other obscure bodies. As each new layer was added, the force of the containing vortex diminished, and more matter escaped into the surrounding vortices than returned to occupy its place; finally, the earth, enveloped in its atmosphere, descended to the position it now occupies in the powerful vortex around the sun. He divides it into three regions, the lowest consisting entirely of matter of the first element; the middle, of an opaque solid body containing passages sufficiently large to admit the fluted columns of the first, but not the spheres of the second element,

\* "Scientia Neutica (pyxidula traducta videtur in Italian per Paulum Venetum, qui circa annum M.CCLX. apud Chinas artem pyxidus didicet. De Magnete, p. 4.



whilst the upper is formed of a confused mass of matter which belongs chiefly to the third element, but is interspersed with the round balls of the second. The passages in the intermediate region he conceives to be so grooved that the fluted columns entering from one side cannot return again by the same passages, but when opposed in their straight course are forced back through the air or upper portions of the earth to those openings by which they entered, whilst those from the other side make similar circuits. He considers that magnets contain passages the same as those first mentioned, and such is the inclination of the fluted columns to enter these passages, that even if the poles are not turned to receive them they will push aside all opposing particles, till, if not restrained by still stronger bodies, the magnets are forced to assume those positions in which their poles point oppositely to those of the earth.\* Such is the hypothesis of Descartes, ingenious rather than plausible, and interesting chiefly as exhibiting the speculative mind of its author.

In 1683 the celebrated Halley presented a paper of great importance to the Royal Society of London, entitled "A Theory of the Variation of the Magnetical Compass." In this communication he states that the "deflection of the magnetical needle from the true meridian is of that great concernment in the art of navigation, that the neglect thereof does little less than render useless one of the noblest inventions mankind ever yet attained to," and gives as the result of "many close thoughts" the following explanation of the variation of the compass. "The whole globe of the earth is one great magnet, having four magnetical poles or points of attraction, near each pole of the equator two; and in those parts of the world which lie near adjacent to any one of those magnetical poles, the needle is governed thereby, the nearest pole being always predominant over the more remote." He remarks that the positions of these poles cannot as yet be exactly determined from want of sufficient data, but conjectures that the magnetic pole which principally governs the variations in Europe, Tartary, and the North Sea is about  $7^\circ$  from the north pole of the earth, and in the meridian of the Land's End, whilst the magnetic pole which influences the needle in North America, and in the Atlantic and Pacific Oceans, from the Azores westward to Japan, is  $15^\circ$  from the north pole, and in a meridian passing through the middle of California. The variation in the south of Africa, in Arabia, Persia, India, and from the Cape of Good Hope, over the Indian Ocean to the middle of the South Pacific, is ruled by the most powerful of all these magnetic poles, which is situated  $20^\circ$  from the south pole of the earth, and in a meridian passing through the island of Celebes; in the remainder of the South Pacific Ocean, in South America and the greater part of the South Atlantic Ocean, it is governed by a magnetic pole  $16^\circ$  from the south pole, in a meridian  $20^\circ$  west of the Straits of Magellan. On this hypothesis Halley explains the variation observed in different places, and among others cites the two following instances. On the coast of America, about Virginia, New England, and Newfoundland, the variation was found to be west, being above  $20^\circ$  in Newfoundland,  $30^\circ$  in Hudson Strait, and  $57^\circ$  in Baffin's Bay. On the coast of Brazil, on the contrary, it was found to be east, being  $12^\circ$  at Cape Frio, and increasing to  $20\frac{1}{2}^\circ$  at the Rio de la Plata, thence decreasing towards the Straits of Magellan. Thus, almost in the same geographical meridian, we find the needle at one place pointing nearly  $30^\circ$  west, at another  $20\frac{1}{2}^\circ$  east; this is explained by the north end of the needle in Hudson Strait being chiefly attracted by the North American magnetic pole, whilst at the mouth of the Rio de la Plata the south end is attracted by the south magnetic pole, situated west of the Straits of Magellan.

\* Descartes designates the south pole of the magnet that which turns to the north pole of the earth, and the north pole of the magnet that which turns to the south pole of the earth.

Sailing north-west from St. Helena to the equator, the variation is always in the same direction, and slightly east. Here the South American is the chief governing pole, but its power is opposed by the attraction of the North American and Asian south poles; the balance as you recede from the latter being maintained by approach to the former.

Nine years later Halley made another communication to the Royal Society, in which he endeavoured to meet two difficulties he had always felt in his former explanation; one, that no magnet he had ever seen or heard of had more than two opposite poles; the other, that these poles were not, at least all of them, fixed in the earth, but slowly changed their positions. The following observations are cited by Halley in proof of the motion of the magnetic system. At London, in 1580, the variation was  $11^\circ 15'$ , east; in 1622 it was  $6^\circ$  east, in 1634 it was  $4^\circ 5'$  east, and in 1657 there was no variation; whilst in 1672, it was  $2^\circ 30'$  west; and in 1692,  $6^\circ$  west. At Paris the variation was  $8^\circ$  or  $9^\circ$  east in 1550,  $3^\circ$  east in 1640,  $0^\circ$  in 1666, and  $2^\circ 30'$  west in 1681. At Cape Comorin it was  $14^\circ 20'$  west in 1620,  $8^\circ 48'$  west in 1680, and  $7^\circ 30'$  west in 1688. Halley considered the external parts of our earth as a shell, separated by a fluid medium from a nucleus or inner globe, which had its centre of gravity fixed and immovable in the common centre of the earth, but which rotated round its axis a little slower than the superficial portions of the earth. The nucleus and exterior shell he regarded as two distinct magnets, having magnetic poles not coincident with the geographical poles of the earth. The change observed in Hudson's Bay being much less than that observed in Europe, Halley concluded that the North American pole was fixed, while the European one was movable; and, from a similar observation on the coast of Java, he considered the Asian south pole as fixed, and the pole west of the Straits of Magellan to be in motion. The fixed poles he regarded as those of the external shell, and the movable those of the inner nucleus. Of these latter, the one placed by him in the meridian of the Land's End was ascertained, in the present century, to have moved to Siberia, in  $120^\circ$  east long., and that placed by him  $20^\circ$  from the Straits of Magellan to have moved between  $30^\circ$  and  $40^\circ$  west of this position; while those poles regarded by Halley as fixed were found but slightly altered in position since his time. It is extremely interesting to find that not only modern observations of declination, but also those of dip and magnetic intensity, have received their best explanation on the assumption of four magnetic poles. Much, however, that is mysterious remains unsolved, and Halley's remarkable words may even now with truth be quoted: "Whether these magnetical poles move altogether with one motion or with several; whether equally or unequally; whether circular or libratory; if circular about what centre, if libratory after what manner, are secrets as yet utterly unknown to mankind, and are reserved for the industry of future ages." K.

#### THE POTATO DISEASE

IN the *Journal of the Royal Agricultural Society of England*, Second Series, vol. xii., Part I., No. xxiii., 1876, Prof. A. De Bary of the University of Strasburg has published a paper entitled "Researches into the Nature of the Potato Fungus."

De Bary's essay treats of the Peronosporæ, Artotrogus (in its plain and echinulate forms) and Pythium. These fungi are described by De Bary as four distinct plants, whilst I, in common with several other observers, believe the first three (if indeed not all four) to be mere conditions of one and the same fungus, viz., the *Peronospora infestans* of Dr. Montagne. In replying to De Bary's remarks it will be convenient (especially as the potato-fungus appears to be somewhat imperfectly understood),



refer to each of the above forms separately, and to strate each to a uniform scale. Therefore in the sent paper I will confine myself to the description the two forms of Artotrogus, and leave the considera- n of Peronospora and Pythium with De Bary's critims of my observations for another paper.

I.—ARTOTROGUS, Mont.

To make my description of Artotrogus quite plain, it necessary to briefly recapitulate the early history the potato-fungus. Mdle. Libert was one of the first describe this in 1844. In the same year Mr. Berkeley rites he first saw diseased potatoes.

In 1845 Dr. Montagne described and illustrated the potato fungus. In his illustrations he included certain spherical bodies found in spent potatoes by Dr. Rayer ; these bodies were attached to threads, some of the bodies eing terminal (Fig. 1, A), and others within the threads

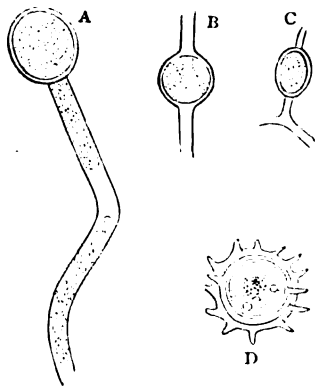

FIG. 1.—*Artotrogus hydnosporus*, Mont. A, B, C. Oogonia from Montagne's original camera-lucida drawing. D. Echinulate oogonium from De Bary ("Resear. lies." p. 256, Fig. 3), x 400 dia.

(Fig. 1, BC), just as true oogonia are now known to occur in *Cystopus* and other of the Peronosporæ. A third form (Fig. 1, D), was more or less echinulate, and this was assumed to be the mature spore. Dr. Montagne, in 1845, did not thoroughly comprehend the meaning of these bodies, so he named them provisionally Artotrogus.

From 1845 till 1875, when I rediscovered the entire series of these bodies in direct connection with *Peronospora infestans*, in the Chiswick tubers, no record of their rediscovery had ever been published. Botanists had sought for Artotrogus in vain.

In 1846, in the first vol. of the *Journal of the Royal Horticultural Society*, the Rev. M. J. Berkeley published his famous paper on the potato-murrain (the essay is dated Nov. 22, 1845), and in this paper Mr. Berkeley reproduces the description and illustration of Montagne's Artotrogus. Mr. Berkeley's published belief has for many years been that the spherical and echinulate forms of Artotrogus belong to no other than the secondary condition of the potato fungus.

In 1849, Mr. C. Edmund Broome, of Batheaston, discovered a second species of Artotrogus; this was found in decayed turnip. A copy of the original camera-lucida drawing made by Montagne is here reproduced. It shows the mycelial threads and the mature resting-spore at E.

Fourteen years afterwards (1863), Prof. A. De Bary published a paper on the development of parasitic fungi in the *Annales des Sciences Naturelles*, vol. xx. In this paper the author illustrated, amongst other things, the resting-spore of *Peronospora parasitica*, Corda, a plant common upon turnips, &c. Part of De Bary's illustration is here reproduced to show the probability of the second described species of Artotrogus being identical with the Peronospora. Some allowance must of course

be made for the sketch of the turnip Artotrogus (Fig. 2), as it was made in 1849 when resting-spores were little understood, but it is clear that Mr. Broome detected

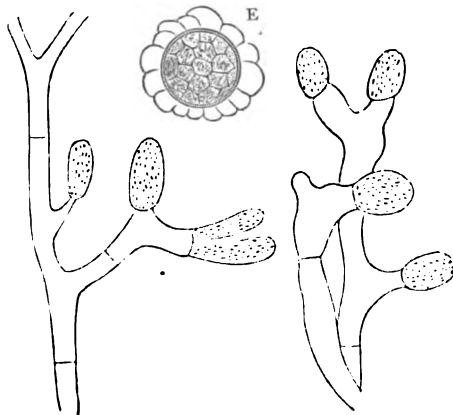

FIG. 2.—Artotrogus on decayed turnip = *Peronospora parasitica*, Corda. x 400 dia.

not only the resting-spore with its collapsed oogonium, but probably also a group of antheridia (see the detached antheridium in De Bary's illustration, Fig. 3).

This probable identity of the Artotrogus and Peronospora of the turnip, points in the direction of the probable correctness of Mr. Berkeley's views as to the Artotrogus of the potato. The oogonia of the turnip parasite are similar in size and form with the oogonia found in potatoes, and to these latter I shall now return.

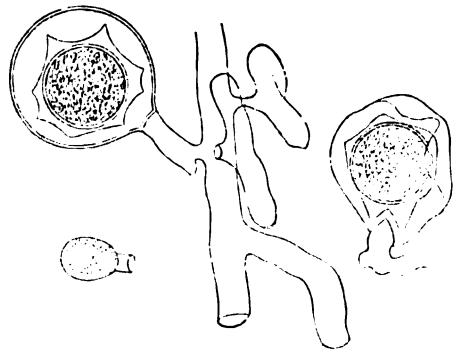

FIG. 3.—*Peronospora parasitica*, Corda. Resting-spores and detached antheridium (De Bary, "Ann. des Sc. Nat.," 4th series, vol. xx., Pl. X., Fig. 5-7), x 400 dia.

The bodies found by me in the Chiswick tubers I have from the first identified with Montagne's Artotrogus, though De Bary in his criticisms has found it convenient to omit all mention of this fact. But De Bary himself now illustrates the same bodies "from Montagne's original specimen;" this illustration is here reproduced (Fig. 4), and I can certify as to its general correctness with the reservations (1) that the oogonia shown are larger than any I have seen in the "original specimens;" (2) larger than any Montagne has figured; and (3) that De Bary has omitted all the terminal oogonia. In Montagne's original camera lucida drawing there are three terminal oogonia, one is reproduced at A (Fig. 1), with two similar bodies intercalated at B C.

De Bary (as well as Montagne, Berkeley, and myself) has also met with the more or less echinulate bodies, and one of De Bary's illustrations is reproduced, at D (Fig. 1). I agree as to its general accuracy.

Now whilst De Bary contends that all these forms are distinct species of fungi, and not belonging to the potato fungus, I maintain with Berkeley, and other competent



observers, that they are *one*, including *Peronospora*. I have seen them all growing from the same threads, and I will now review the grounds on which De Bary refers them to *different* fungi.

First, from De Bary's own words, I will show how extremely near the connection was, even with him. The italics are mine. He says ("Researches," p. 256), "In the tissues of potatoes *penetrated with the mycelium of Phytophthora* (De Bary's new name for the potato fungus) there sometimes appear other bodies which might be regarded as oogonia or oospores of the potato fungus. I have several times found them with *Pythium vexans* in old collapsed tubers which had sprouted in the ground, and *once without Pythium* in a living stalk which



6. 4.—*Artotrogus hydnosporus*, Mont. De Bary's illustration ("Researches," p. 258, Fig. 8),  $\times 400$  dia.

had been on the ground. But they were *always restricted to those regions which were occupied by the Phytophthora mycelium*." And again, "It was certainly remarkable that they were *often situated close to the inner surface of the cell-walls in places where externally the mycelium of Phytophthora undoubtedly ran in the intercellular spaces, or even where a short branch of it penetrated the interior of the cell*."

In his desire, however, to dissociate these bodies from *Peronospora*, De Bary (p. 257) first says they were found by Montagne in a "sprouted but *not diseased potato*." But this statement becomes of no value when De Bary himself confesses (as he does) that with him the oogonia were always restricted to those regions which "were occupied" by the *Peronospora mycelium*. I, too, have found them in similar "regions" and upon the *Pero-*

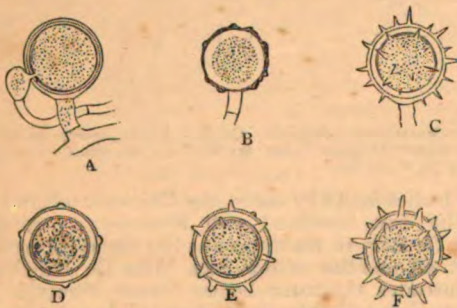

FIG. 5.—Oogonia of *Peronospora infestans*, Mont. A, B, C. Different forms from Chiswick potatoes. D. From De Bary's slide, No. IX. (common in Montagne's preparations). E. From De Bary's slide, No. XI. F. From De Bary's slide, No. X, as sent to the Royal Agricultural Society.

*nospora mycelium*. De Bary says (p. 256), "In most cases I found these bodies complete, mature, and without any distinct indication of their being attached to mycelium," and he says the same of Montagne's material and afterwards of mine. But this statement (like the former one) becomes of no value when we find the author writing on the very next page that after "long searching in vain he found them to grow on the extremities of the branches of a mycelium which is very like that of *Pythium vexans*." And now what is the mycelium in *P. vexans* like? De Bary tells us, on page 253, that it is "scarcely

possible to draw a positive distinction" between it and the mycelium of *Peronospora infestans*! The conclusion is obvious.

It is, perhaps, difficult to explain why a smooth oospore should become a rough or echinulate one, but the fact remains that the phenomenon is perfectly well known in fungi, notably in the spores of some of the Gasteromycetes. Plain and echinulate oospores are also produced on the same plant in some *Saprolegniae*. Max Cornu also maintains that *Saprolegnia asterophora* of De Bary is the same as the warted form of *Achlya racemosa* of Hildebrand. *Dictyuchus* also occurs with warted oogons. The three upper figures on the accompanying illustration (Fig. 5) are exact reproductions from different forms of oogonia found by me growing on the same threads with *Peronospora infestans*. The lower three are from De Bary's own specimens sent to the Royal Agricultural Society; D is from slide ix. (this is also very common on Montagne's preparations); E is from De Bary's slide xi., and F is from slide x. A glance at the actual preparations will show that every intermediate form is to be found.

But De Bary will not see the association, and in his concluding paragraph on *Artotrogus* (p. 258), he criticises Montagne and Berkeley, and says these authors "have explained the globular cells of both kinds as exhibiting progressive steps in their development, the smooth ones being the younger. For this *no reason is given*," says De Bary, "nor have I found any in the renewed examination of the specimens. Anyone can scarcely conceive, from the known phenomena of development how the smooth



FIG. 6.—Resting-spores of *Peronospora Holostei*, Caspary.  $\times 400$  dia. From De Bary's preparation sent to the Royal Agricultural Society.

thick walled cells (the cell-walls are exactly the same in both) could become the smaller star-shaped ones."

Now, the accompanying illustrations (especially Fig. 1) show De Bary to be quite wrong. The three upper oogonia on Fig. 1 are from Montagne's own camera-lucida tracing, the left-hand figure, A, is the *largest* oogonium he has shown, and the right hand oogonium, B, is the smallest. I can testify as to their correctness from an examination of the original material. The starchy figure at D is one of the (presumably) mature bodies, and is reproduced from *De Bary's own figure* ("Researches," p. 256, Fig. 3). I reproduce this figure because De Bary calls it the "common form." Now, instead of being smaller, a glance will show this echinulate body to be *larger than the largest plain oogonium found by Montagne*. On turning now to Fig. 5 it will be seen there is no "getting smaller" in the case, for all the bodies are as a rule very uniform in size, and if they vary at all they get somewhat larger instead of smaller at maturity. This is the rule, but all botanists know well that the oogonia of the *Peronosporae* are liable to vary. A good illustration of this is afforded by De Bary's own preparation of *P. Holostei*, as furnished by him to the Royal Agricultural Society. The accompanying illustration (Fig. 6) is a camera-lucida reproduction of two oogonia belonging to this species from his own slide, and it shows well how oogonia may vary in size.

Thus De Bary's notes and criticisms (taken in connection with the observations of other competent observers) on this, the *first point* (*Artotrogus*), completely fall to the ground. De Bary confesses to having found both forms of *Artotrogus* in those restricted regions *only* of diseased potatoes where *Peronospora mycelium* was *undoubtedly and always present*. He moreover found the bodies attached to a mycelium so like that of *Peronospora*



it was almost impossible to distinguish it from Peronospora. As regards the unfortunate criticism of Montagne and Deley as to the size of the oospores De Bary effectually rebuts himself.

WORTHINGTON G. SMITH

SCIENCE IN LEEDS

THE Annual Meeting of donors and subscribers to the Yorkshire College of Science was held in Leeds last day. Financially the College seems to be fairly prosperous. The subscriptions promised prior to the inauguration amounted to 28,000*l.*, and of the special fund of 1000*l.* started by Sir Andrew Fairbairn's conditional offer of a second donation of 1,000*l.*, about 8,000*l.* have been raised. The Council are most anxious that this could be completed without delay. The College will also participate yearly in the proceeds of William Croft's Foundation. Of the present condition of the Yorkshire College as regards efficiency, the following communication from Mr. G. T. Bettany will afford a fair idea:—

A recent visit to Leeds enabled me to inquire into the working of the Yorkshire College of Science, which has now been in existence for nearly two years. In the building which has been temporarily adapted to the purposes of the College, I found abundant evidence of labour and industry on the part of both professors and students. The attendance of seventy-five day and more than two hundred afternoon and evening students during the present session shows that the advantages offered by the College are becoming widely appreciated. Although youths are admitted at the age of fourteen, most of the students are much older; I was informed that the average age was a year and a half greater than at Owens College. The chemical department has the lion's share of accommodation; the lecture-room is large and good, and the laboratory would allow of forty students working at the same time. There have been few vacant benches during the last term. Prof. Thorpe has a room fitted up as a museum and reference library, and has also a private laboratory. A considerable amount of work is done in the department of mathematics and physics, but physical teaching suffers from want of space. Practical work can only be carried on in Prof. Rücker's private room. Geology has been fairly attended, though the day class is but small at present. Prof. Green is forming most instructive series of rock-specimens, illustrating stratigraphical geology, volcanic phenomena, and transitions in metamorphism. Mr. Miall's biological lectures have resulted in some very good work. He has prepared a large number of dissections for demonstration, including a series illustrating Prof. Rolleston's "Forms of Animal Life;" practical work has been undertaken by several students, including ladies, one of whom gained the highest place in an examination at the end of last term. Finally, the instruction on textile industries, under Mr. Beaumont, has been made scientific in many respects, especially in relation to the theory of colouring.

It can hardly be considered a misfortune that the College has been started in temporary buildings; for by means of its present effort science will become more widely appreciated, and much larger donations will come to hand than those already received; and the construction of the permanent college buildings cannot fail to be advantaged by the experience now being gained by the professors. It is to be hoped that many wealthy Yorkshire manufacturers who have at present given little or nothing to the College will be induced to follow the example of men in other localities, and liberally support a system of teaching which will be of great intellectual and material benefit to Yorkshire. I was struck with the large amount of work undertaken by the professors. When more prosperous times come, it will be for the

good of the College not to exact so much work from them as their zeal is now leading them to perform.

The Leeds Philosophical Museum is becoming yet more interesting under the care of Mr. Miall, who has worthily succeeded the late Mr. Denny. The whole of the Museum is gradually being arranged in the most educative manner, and very great progress has been made. The casual visitor cannot fail to be instructed as well as interested, which can hardly be said of many more pretentious museums. Brief and clear printed descriptions or explanations abound, showing the particular interest of a specimen, or giving the general characters of a class of animals or of a geological formation. If an additional skilled curator could be appointed, who should relieve Mr. Miall from the care of several departments, the Leeds Museum would advance still more rapidly than at present, and would soon be worthy of any provincial college.

THE LATE SIR WILLIAM WILDE

SIR WILLIAM ROBERT WILLS WILDE, M.D., &c., was born in Castlereagh, county of Roscommon in Ireland, in the year 1814, and he died at his residence in Dublin on the 19th instant. He was educated at the Royal School at Banagher and at the Diocesan School at Elphin; when scarcely eighteen years of age he was bound apprentice, according to the practice of those days, to the well-known surgeon, Abraham Colles, and he acquired his professional knowledge from such men as the Cramptons, Marsh, Wilmot, and Cusack. Early in 1837 he became a Licentiate of the Royal College of Surgeons in Ireland, and shortly after he resolved to devote himself to ophthalmic surgery, in which he attained a position of the highest eminence.

However distinguished as an oculist, however renowned as a writer on statistics, in these columns we lament in his decease the departure from among us of one who, as an earnest, devoted, and painstaking student of the early history of the Irish races, has left in his writings on this subject a great and an enduring monument.

Sir W. Wilde was elected a member of the Royal Irish Academy in June, 1839, having previously read two papers before the Academy, which were published in abstract in their *Proceedings*, and exhibited a collection of ancient spear-heads found in his native country. At this time the Academy had no museum (the Underwood purchase was not arranged), but in the same month that Wilde was elected, Prof. M'Cullagh munificently presented them with the Cross of Cong, "in order that he might contribute to the formation of a national collection, the want of which was regarded by Sir Walter Scott as a disgrace to a country which, like Ireland, so abounded in valuable remains." This noble gift bore speedy fruit, and meeting after meeting witnessed the presentation of donations, many of which were from time to time described by Wilde.

In 1855 Wilde was elected member of the Council of the Academy, and Secretary of Foreign Correspondence in 1857. In 1852 the Academy had moved to the premises that they at present occupy, and the Council took steps to have a catalogue of their museum made. The task was entrusted to Dr. Petrie. The resolution of the Council would seem not to have been carried into effect, and after some years of anxiety the Council and the Academy were but too happy, in March, 1857, to accept Wilde's liberal proposal to arrange and catalogue their museum. The energy that he brought to bear on this task may be judged from the fact that Part I. was ready in the month of August in the same year, when the British Association met for a second time in Dublin. Part II. was published in 1860. Part III., concluding Vol. I., in 1863. Part I. of Vol. II. had been published in the previous year. Part II. of this volume, although in great part ready, was never printed; let us add that the best



tribute of respect that the Academy could pay to Wilde's memory would be to complete this work. Few know the hours that were stolen from professional work, from the enjoyment of social life, and from much-needed rest, during the years that were engaged in this work. Despite the criticisms of some who knew little of what they criticised, this catalogue will always remain as a testimony to the author's energy and ability; already has it proclaimed far and wide what a storehouse of treasure exists under the Academy's roof. Sir William Wilde's many good qualities will keep his memory alive in the hearts of those who knew him, and when these are dead and gone it will still and for ever hover around the collection of the antiquities of the Royal Irish Academy.

#### MIDDLE-CLASS EDUCATION IN HOLLAND

THE following article on this subject, "from a Correspondent," appeared in the *Times* of Tuesday:—

It is not infrequently the case that great nations search laboriously for the solution of problems which smaller peoples have completely solved, as one may say, without effort. We old-fashioned English are at present devoting much pains to discover a good system of education for our middle classes, and yet we have only to cross the Channel in order to see in actual work one altogether satisfactory in a country whose manners, traditions, and laws are almost those of our own.

According to the constitution of Holland there are three degrees of education—Primary, Middle, and Superior. As the Primary Education comprehends all schools intended for children from six to twelve years of age, and as the Universities, the Gymnasias, and other establishments where the study of the ancient languages occupies the first place, are considered as belonging to the Superior class, it follows that all educational establishments not included in one or other of these categories are regarded as establishments for middle-class education.

It appears that until the year 1862 the Dutch were no further advanced in respect of this kind of education than we are now. Wishing to put an end to this state of things, the Minister of the Interior (the Home Secretary) of the time, M. Thorbecke, formerly Professor in Leyden University, presented to Parliament a bill, which was passed into law at the beginning of the following year. From the discussions which preceded the adoption of this law, we learn that its object is to insure a suitable education to young people who are not obliged to learn a business before the age of from fourteen to seventeen years, and for whom, although they are not intended to take up University studies, a deeper and wider instruction is necessary than that which can be obtained at the primary school.

Setting out from the principle that youths who quit the primary schools may be divided into two classes—those who are able to devote only two years, and those who can afford to give five years to further study, it was decided that there should be two kinds of middle-class schools, the one to have a two years' course, and the other a course of five years.

The programme of study in the establishments in which the course is one of two years, and which are called Lower Middle-Class Schools, includes, in the first place, the elements of Mathematics, Mechanics, Physics, Chemistry, Natural History, Geography, History, and the Dutch Language, and in addition, Drawing, Gymnastics, and some idea of Political Economy and of Technology for towns, and of Agriculture for the country. The teachers in these establishments are moreover required to devote the evenings to courses for young artisans or agriculturalists who are prevented from taking the courses which are given during the day.

As to the number of these schools, the law requires that each commune whose population exceeds 10,000 shall

establish at its own expense at least one Lower Middle-Class School.

The programme for those schools in which the course is one of five years, and which we may designate Upper Middle Class Schools is of course more extensive. It embraces first the branches included in the Lower Schools, but, as might be expected, this education in the Upper Schools goes much deeper. Then come three foreign languages—French, English, and German. The law requires, moreover, that the pupils should receive some notion of the political institutions of the country and of its statistics, including those of the Colonies. Needless to add, that in a country like Holland the tenure of land must form an integral part of education.

The Higher Schools are naturally those from which the most important results are to be expected, and which, from the English point of view, are best worth careful study. It is simply the truth to say that I have been amazed at what I have seen. It is a very remarkable thing that although no commune is obliged to establish a Higher School—only the State is obliged to maintain five—yet at the present time there is no town having a population of above 15,000 which has not its Higher School in full work. A still more remarkable thing is, that nowhere do the school fees exceed 5*l.* a year. As an Englishman, I was very curious to learn how they were able to give at the rate of 5*l.* a year an education which, in our happier England, can scarcely be obtained at all. This is what I learned. The expenses of a Higher School (not including the maintenance of the building) amount to about 1,750*l.* per annum. Supposing the school to be attended by 100 pupils (a medium estimate), the receipts, under the head of school fees, do not exceed 500*l.* There thus remains a deficit of 1,250*l.*; but the State generally provides a subsidy of 7,000 florins (about 583*l.*), and the town has therefore only to make up the difference by contributing 667*l.* We have supposed the school to be attended by 100 pupils, it is evident that when this number is exceeded, the receipts rise in proportion. This, however, is not always to the advantage of the Communal budget, for it should be known that in Holland a class is not allowed to contain more than thirty pupils, the result being that a greater number necessitates the creation of a double class, and this may require an increase in the number of teachers. Let us note, also, in passing, that the communes which are not able to bear the expense of a complete Higher School are authorised to establish schools of three classes corresponding to the three lower classes of a complete school.

The Communal Councils (town councils) may appoint such teachers as appear to them efficient. It is only necessary that these present certificates of competency and character, and that they have consequently passed the examinations required by the law. There are exempted from these examinations the bearers of certain academic degrees; thus for the mathematical and physical sciences the greater part of the candidates are former students of the Universities. These are generally young doctors of science who have taken a high place. Holland is not slow in showing her gratitude to them.

I have said that in the Higher Schools the school fees, although the law has not fixed a maximum, do not exceed 5*l.* For the Lower Schools the maximum is 1*l.* per annum, but this figure is rarely reached.

It is evident from the above that when a boy of twelve years of age leaves the Primary School and is not immediately obliged to earn money, his father, called in to decide whether or not he shall be sent to a Middle School, has no obstacle to face in the matter of school fees. A foreman or superior workman in a position to keep his son till he is fourteen years of age, can easily pay a shilling a month for school fees; 5*l.* would be an almost insuper-



able obstacle, though it is none to a father who is able to provide for the other wants of his son until the latter reaches the age of seventeen or eighteen years.

A Dutchman who boasted greatly of the system which his country has adopted, and to whom I remarked that it might be objected that in virtue of the system it was not himself but the taxpayers who paid for the education of his children, replied eagerly: "But am I not myself a taxpayer? Does not the system which we have adopted come simply to this, that instead of my being compelled to pay for the education of my children in a few years under the form of very heavy school-fees, the law allows me thirty or forty years in which to pay it under the form of a tax? As for myself personally, it matters very little, but look at my neighbour, whose three sons are being educated at the Higher School. Change the system; his taxes would perhaps be lessened by twenty florins, but, on the other hand, the school fees would reach so high a figure that he could not meet them. The case of my neighbour is not an exceptional one; it is the case of at least one-half of the parents who send their children to the Higher Schools. Of 100 pupils who are now attending these establishments there would remain scarcely one-half, and it would consequently be necessary to raise to 35% the fees to be paid by each of them; this figure speaks more than all the arguments put together."

If in defence of a new order of things it is only necessary to urge the argument of success, it must be confessed that the advocates of the Higher Middle Schools of Holland do not require to urge any others. By universal consent the success has surpassed all expectation; it has been complete. Yet whoever knows human nature will not be astonished to find that these schools, simply because of their success, are still the object of much criticism particularly among the Clergymen and Scholars of the country. I should have wished to learn from M. Thorbecke, himself a very distinguished scholar, what he thought of these criticisms. That statesman, however, being dead, I applied to one of his former colleagues in Leyden University, whose advice M. Thorbecke to a large extent followed at the time when he was occupied in drawing up his scheme of superior education. I will give you a summary of our conversation. Having asked if it was not a mistake to found a system of education which had not Greek and Latin as its basis, he replied as follows:—

"Allow me to observe to you that our Middle Schools are not intended to produce scholars, orators, statesmen. For these there are the Gymnasium and the University. Has it moreover been thoroughly proved that the profound study of a modern foreign language cannot, as mental gymnastics, take the place of the study of a dead language? I could name to you members of our parliament who have never given any attention to Greek and Latin, and yet who, as orators, are on a par with the most eloquent of their colleagues. The Greeks are represented as having left to us in literature and in philosophy monuments of a perfection such as modern writers can never equal. Yet the Greeks studied no dead language that I know of. Besides what would it serve, in the matter of education, to make a theoretically perfect law, when the mass of the public would condemn it? If there [is] one idea strongly rooted in the mind of our middle classes, it is the conviction that Greek and Latin are perfectly useless to anyone who has not to pass through the University. It was daring enough to give so large a place in our new schools to the mathematical and physical sciences, to which our *bourgeoisie* had hitherto given so little attention. To go further and compel this class of people to study in addition Greek and Latin, would have been wantonly to court an inevitable defeat."

I next ventured to point out that the programme is overloaded.

"Overloaded?" replied he. "From whom have you got

this accusation? From men who pass their time in their study? Speak a little with our manufacturers and our merchants, and they will give you quite another version of the matter."

"It is not said that useless subjects are taught," I went on to add; "it is urged only that too many things are taught at once, that the mind of the pupil cannot take them in, and that in the end his intellect will be enervated."

"I understand how this objection could have been urged in 1862 and 1863, during the discussion of the law, when experience had not yet pronounced; but now!—at the present time our merchants, who formerly maintained that a man of business has nothing to do with science, that it was rather an embarrassment than otherwise, now receive with open arms any young man having no other recommendation than that of having studied in one of our schools; they will tell you, moreover, that at the end of five or six weeks the new-comer is more useful to them than the majority of their old *employés*, grown gray in harness. There is more to come; it happens that some pupils of the Middle Schools, having acquired a taste for the mathematical and physical sciences, wish to complete their education at the University. Well, they almost always surpass those of their companions who come from the Gymnasia. Confess that all this is very difficult to explain if it be true that in the new schools the mind of the pupil is enervated and atrophied."

Our conversation then went on as follows:—

"You maintain then, that in your new schools, everything is for the best?"

"Pardon! I believe, on the contrary, that there is room for reform. It cannot be denied that the mediocre pupils have great difficulty in learning all that is taught them in the first three forms. Instead of three years, they would require four. The entire course ought to be six years."

"But why at the first did you not fix the course at six years?"

"Because we old-fashioned Dutch, like all the rest of the world, have our characteristic faults. We are a people essentially economical, but unfortunately we are too anxious that our children should begin early to earn money. It was a great point gained, even, to fix the course at five years. What an outcry would there have been had we taken a year more. Besides we had not then the experience that we have now."

"It will then be necessary to modify the law?"

"Yes, but gradually. There are some members of our Chambers who think it will suffice to cut out from the programme the subjects which are called superfluous. I believe it will be well not to oppose this opinion. Let us commence by setting these members to work. That which will be superfluous in the eyes of some will be quite indispensable in the estimation of others. Moreover, they cannot touch either the mathematical and physical sciences or language, and if they end by cutting out anything, a thing which appears to me very problematical, it will be of so little importance as to make scarcely any difference. It will only be when the insufficiency of all these palliatives has been well established that the time will have arrived to apply the remedy that I have indicated to you."

"You believe, then, that if we should decide in England to establish schools of a kind similar to your Higher Middle Schools, it would be necessary to have a course of six years?"

"I do not venture to assert this. You are under better conditions than we are. Our children must, beside their mother tongue, learn three foreign languages—English, French, and German; yours have only to learn French and German. This is a very important point."

"Allow me to ask you one more question. It is urged



that your Lower Middle Schools have not succeeded. To what is this ascribed?"

"It would be more correct to say that they have not succeeded throughout. Moreover, M. Thorbecke was never under any delusion on this point. He considered the Lower Middle Schools as placed for the future. The proof is that he got inserted in the law a clause which enacts that the Government may for a certain number of years exempt a communal council from the obligation of erecting a Lower Middle School if it is probable that a sufficient number of pupils could not be obtained to attend it. It is necessary first that the economical condition of the country should be improved. Remember that in Holland wages are in general lower than in all the surrounding countries. We cannot blame our poor artisans for requiring their children to earn some money at the age when these would enter the Middle School."

Such is a *résumé* of what I have seen and heard in Holland.

### NOTES

At the meeting last week of the delegates of the French Learned Societies at the Sorbonne, the Science Section was divided into three committees—Mathematical, Physico-chemical, and Natural History. The general meetings of the three sections were presided over by M. Leverrier, who developed at full length the organisation of agricultural warnings which have been established in Puy de Dome, Vienne, and Haute Vienne, and will be in operation from May 1 to October 15, when agriculturists have practically nothing to lose in the fields. About thirty stations have been established in each of these departments and connected by telegraph with the chief towns of the district. Each local observatory will receive telegraphic warnings through the préfet of the department, to whom will be sent daily the telegrams of the International Service. All these warnings will be posted at the stations and special warnings for the vicinity deduced by local meteorologists. All the observations taken on these stations will be sent to the observatory and tabulated under the supervision of M. Leverrier. The system will very likely be extended to other departments. The distribution of prizes was held on the 22nd in the large hall of the Sorbonne. The Minister of Public Instruction, M. Waddington, gave an address, in which he promised to create new libraries, new faculties, and to group new faculties in order to establish Universities. It is inferred thence that M. Waddington, who, as is well known, is a Cambridge man belonging to Trinity College, will try to remodel the French high schools according to the English method. The old Université de France is, perhaps, to be divided into the Universities of Paris, Lyons, Lille, Marseilles, and Toulouse. M. Waddington's address has created quite a sensation amongst French University men. Five gold medals were awarded—to MM. Abria (Bordeaux), for physics; Clos (Toulouse), for botany; Dumartier (Lyons), palæontology; Filhol (Toulouse), geology; Lortet (Lyons), zoology and palæontology. Ten silver medals were also awarded in botany, zoology, and natural philosophy. In connection with this meeting, M. Lecoq de Boisbandran has been made a Chevalier de la Legion d'Honneur. Several other scientific men have been appointed *officiers* of the University and *officiers* of the Paris Academy, which are special honorary degrees in acknowledgment of some special services either in the prosecution of scientific researches, or in carrying out the results of the scientific investigations of other people.

A TREASURY COMMISSION has just been appointed by Government for the purpose of inquiring into and reporting on the Queen's Colleges in Ireland. The Commissioners are the Rev. Osborne Gordon, of Christchurch, Oxford; Prof. Allman,

F.R.S., M.R.I.A.; and Mr. Herbert Murray, Treasury-Remembrancer in Ireland; with Mr. B. Leech as Secretary.

SIR ROBERT CHRISTISON has resigned the position of President-elect of the forthcoming Glasgow meeting of the British Association. Dr. Andrews, of Queen's College, Belfast, has been nominated by the Council in his stead.

THE French Geographical Society are to invite Lieut. Cameron to Paris to a special meeting of the society, to be held for the purpose of marking the appreciation of his merits felt in France.

THE freedom and livery of the Turner's Company were presented at the Guildhall, on Saturday, to Lieut. Cameron and Dr. Atherstone, to whose labours as a geologist the discovery of the value of the South African diamond fields is principally due.

ADMIRAL LA RONCIÈRE LE NOURRY has been reappointed by a large majority the President of the French Geographical Society.

THE French Minister of Public Instruction has given instructions for a series of observations to be made on all the streams of oceanic France, in order to determine the formation of the bar. Stations will also be established on the French coasts for observations of the tides. The previous French observations were made at Brest as far back as 1770, and on them the calculations in Laplace's "Mécanique Celeste" were based.

THE conversazione given last Friday evening at King's College by Mr. H. C. Sorby, F.R.S., to the Fellows of the Microscopical Society (of which Mr. Sorby is president) and their friends, was a brilliant and successful one. One of the greatest novelties exhibited was a new binocular spectroscope, illustrating Mr. Sorby's important discovery of a new method of measuring the position of the bands in spectra.

WE would remind our readers that the afternoon lectures at the Zoological Gardens commence to-day at 5 P.M., the first being by Mr. Sclater, F.R.S., "On the Society's Gardens and its Inhabitants." They will be continued on Thursdays for the next nine weeks.

THE first annual meeting of the Cumberland Association for the Advancement of Literature and Science, will be held at Whitehaven on May 1st and 2nd.

IN Guido Cora's *Cosmos* for April the valuable information on recent expeditions to New Guinea is continued. There is a paper by Major Wood on the Oxus in the time of Alexander, an account of Cameron's work, the continuation of G. Bove's narrative of his visit to Borneo, besides other matters of geographical interest.

PETERMANN'S *Mittheilungen* for April contains an account of the results obtained by Lieut. Cameron to accompany the excellent map of the country explored, which we have already referred to. There is an interesting account of the ascent of the two Norwegian summits, Galdhøpig and Sneehätta, by Hauptmann M. Riith. Along with a map of New Zealand there is a long article by J. I. Kettler, showing the recent progress of that colony. Drs. Radde and Sievers furnish an interesting preliminary account of their recent travels in Caucasia and the Armenian highlands.

IN the *Bulletin* of the French Geographical Society for March, Dr. Nachtigal's account of his journey in Central Africa (1869-74) is concluded, as is also the account of Abbé David's travels in Western China in 1868-70, and M. J. Codine's paper on early Portuguese discoveries on the West African Coast. There is an itinerary from Tangier to Mogador, by M. Auguste Beaumier.



THE Physical Society of Paris held its Anniversary Meeting last Thursday.

On Saturday, the *Times* states, there was exhibited in Wolverhampton a meteorolite weighing 8 lbs. It is believed to have fallen on Thursday afternoon in a turf field in a meadow near the Wellington and Market Drayton Railway, about a mile north of the Gradginton Station. It is stated that about ten minutes to four, within a seven miles' radius of the Wrekin, the villagers were alarmed by an unusual rumbling noise in the atmosphere, followed immediately by an explosion resembling the discharge of heavy artillery. Rain was falling heavily throughout the afternoon, but there was neither lightning nor thunder. About an hour after the report what proved to be a mass of meteoric iron was found in the meadow referred to at a depth of 18 inches, having passed through 4 inches of soil and 14 inches of clay. It rested upon the gravel underneath these. The hole is almost perpendicular, and the meteorolite is assumed to have fallen in a south-easterly direction. It is stated that the meteoric stone when found was quite hot, although nearly an hour had elapsed from the time of the explosion being heard.

THE more important articles in the *Quarterly Journal of the Meteorological Society* (London), April, 1876, are the President's Address, the Report of the Council for 1875, a paper by the Hon. Ralph Abercrombie on an improvement in aneroid barometers, and another by Colonel Puckle on Meteorology in India in relation to Cholera. The work of establishing stations begun by the Society in 1874 proceeds satisfactorily, and the Council deserve all praise for the ample details given regarding the twenty-two stations they have now established, and particularly for the lithographed ground-plans of the individual stations, which show the positions and surroundings of the different instruments. We regret, however, to see that the mistake in science regarding the height of the thermometers above the ground, pointed out by us (vol. xi. p. 446) still remains to be rectified, for while exact and minute directions are given respecting the various instruments, each observer is apparently left to his own discretion as to the height at which he places his thermometers. The president's remarks on lightning-rods will be read with interest; and Mr. Abercrombie's improvement on aneroids may be noticed as likely to lead to a more satisfactory observation of small barometrical fluctuations, on a correct knowledge of which so much depends.

We have received the Programme for Easter, 1876, of the Realschule of Lippstadt. Besides a carefully arranged prospectus of the studies of the school, from the lowest to the highest class, which, in the number and nature of the subjects taught, would make most English teachers stare with wonder, there is an admirable paper by our contributor, Dr. Hermann Müller, who is a master in this school, on the system of teaching Natural History at Lippstadt.

In a four-page monthly journal published at Laurence, Kansas, U.S., called *The Observer of Nature*, the first five numbers of vol. iii. of which have been sent us, Prof. F. H. Snow gives a catalogue of the Lepidoptera of Eastern Kansas. It is published by the Natural History Society of the Kansas State University, the Vice-President, Secretary, and Treasurer of which are ladies, and which has on its list an officer known as "Critic."

WHAT seems to have been an interesting and successful conversation was given by the University School Naturalists' Field Club, Hastings, on Saturday week. A number of papers on subjects connected with natural history were read by the boys.

PROFESSORS JORDAN and Copeland, of Indianapolis, Indiana, U.S., are organising a scientific excursion for next summer for the benefit of those wishing to study practically the botany and

zoology of the United States. They think that possibly some young Englishmen visiting the American continent during the Centennial, might wish to join such an expedition.

THE degree of LL.D. has been conferred upon Prof. Stanley Jevons, F.R.S., by the University of Edinburgh.

TO-MORROW evening, at the Royal Institution, the discourse will be given by Mr. G. J. Romanes (on the Physiology of the Nervous System of the Medusæ) instead of Prof. Gladstone, who will give the discourse on May 5th.

THE time-honoured New York Lyceum of Natural History has lately changed its title to that of the New York Academy of Sciences, and has published a circular explanatory of its object in so doing, referring to the fact of having published eleven volumes of its Annals. The circular proceeds to state that the limitation of the Society to the subject of natural history is at present unwise, and that if it desires to take a position among the first institutions of the kind at home and abroad, its scope should be greatly enlarged and its title altered to correspond. Although for many years past attention has been paid to chemistry and physics, this is not indicated in its name, and misapprehensions are likely to arise in consequence. Under the new constitution, the direction of the affairs of the Academy is placed in the hands of a body of Fellows chosen for their attainments in science, and four sections have been established, into one or the other of which all members are to be placed. These are first, zoology, botany, and microscopy; second, chemistry and technology; third, geology and mineralogy; fourth, physics, astronomy, and mathematics. Each of these has its own special administration, and is charged with the scientific work of its department. The Annals will be continued under the title of Annals of the New York Academy of Sciences, four numbers being issued every year.

A NEW ZEALAND correspondent states that he met with a curious instance of tenacity of life in the eel lately in Tasmania. Seven years ago a man placed an eel which had been slightly injured along with others in a tank from which he was in the habit of removing them for use constantly as required. The box in which they were kept was perfectly tight and fitted with finely perforated zinc at each end, through which nothing but the most minute organisms could pass. A few days afterwards, when the others were all taken out, the injured eel was left, and so again, when the next supply was put in and removed. It had got very thin, and so he left it, he said, "just to see how long it would live on nothing." It is still in the tank, perfectly transparent and quite white, and is to all appearances healthy and lively enough.

PARTS 3 and 4 of Mr. J. Clifton Ward's paper on the Granitic, Granitoid, and Associated Metamorphic Rocks of the Lake District, has been reprinted separately for the *Quarterly Journal of the Geological Society*.

A FOSSIL cockroach and earwig (*Labiidura*) from South Park, Colorado, is described by Mr. S. H. Scudder in the Sixth Bulletin of the United States Geological Survey of the Territories.

A "SCHOOL of Science Philosophical Society" has been for some time established at Gloucester. The members seem bent on real work, and have already formed the nucleus of a good scientific library.

THE Fifteenth Annual Report of the Manchester Scientific Students' Association for 1875 is a very satisfactory one. It contains an account of the excursions made during the year, and also reports of several very good papers read by the members.



THE additions to the Zoological Society's Gardens during the past week include a Weeper Capuchin (*Cebus capucinus*) from Brazil, presented by Major F. J. Ricarde Seaver; a Common Otter (*Lutra vulgaris*), European, presented by Mr. J. Herbert; a Grey Squirrel (*Sciurus cinereus*) from North America, presented by Mrs. M. E. Symons; a Yarell's Curassow (*Crax carunculata*) from South-east Brazil, presented by Mr. Aug. Ceiyoto; a Scaup Duck (*Fuligula marila*), European, presented by Mr. H. Colliver; two Common Thickknees (*Edicnemus crepitans*), European, presented by Mr. J. E. Harting; a Coati (*Nasua nasica*) from South America, two Silky Marmosets (*Midas rosalia*) from Rio Janeiro, Brazil; five Graceful Pigeons (*Columba speciosa*) from South America, purchased; a Molucca Deer (*Cervus moluccensis*), born in the Gardens.

### SCIENTIFIC SERIALS

THE current number of the *Journal of Anatomy and Physiology* commences with a paper by Dr. A. Ransome on the relative powers of fresh and previously used pepsine in the digestion of albumen, in which it is demonstrated that pepsine has greater activity after it has been used than when fresh, in which respect it is shown to agree with ptyalin, as shown by Dr. Foster, and with pancreatin according to Thiersch.—Following is a contribution on the anatomy of the cutis of the dog, by Dr. Stirling, with two plates, republished from the *Berichte d. Math. Phys. Classe der Königl. Sächs. Gesel. d. Wiss.*, 1875.—Mr. R. H. A. Schofield makes observations on taste-goblets in the epiglottis of the dog and cat, closely resembling the same structure in the tongue.—Dr. J. Blake, of San Francisco, describes the physiological action of the salts of beryllium, aluminium, yttrium, and cerium, by injecting them into the blood.—Dr. Brunton shows that Condurango is physiologically inert.—Mr. J. C. Ewart has a note on the abdominal pores and urogenital sinus of the lamprey, in which he demonstrates that the ureters and internal abdominal pores open into a urogenital sinus which opens behind the rectum on a papilla.—Mr. E. Thurston determines the length of the systole of the heart, as estimated from sphygmograph tracings, in which, from a series of measurements, he verifies Mr. A. H. Garrod's law that in health the systole, as indicated in the radial artery, is constant for any pulse-rate, and varies as the cube root of the rapidity.—Mr. A. M. Marshall explains the mode of oviposition of *Amphioxus*, verifying Kowalevsky's observation that the ova escape by the mouth.—Mr. F. Darwin describes the structure of the snail's heart histologically. No nervous mechanism was found. The contractile tissue is striated, and the fibres of the auricle and ventricle are continuous.—Dr. Stirling notes the effects of division of the sympathetic nerve in the neck of young animals.—Prof. Turner describes the structure of the non-gravid uterine mucous membrane in the kangaroo, and makes a note on the dentition of the narwhal.—Mr. F. M. Balfour continues his valuable account of the development of the Elasmobranch fishes, with five excellent plates and many woodcuts.—Mr. P. H. Carpenter makes remarks on the anatomy of the arms of Crinoids, his results being arrived at from sections of decalcified specimens.—Dr. Foster describes some effects of *Upas Antiar* on the frog's heart, demonstrating that the resulting tetanus is brought about by an extraordinary prolongation of the diastole, and not by a too rapid sequence of beats. The arguments for and against the existence of both accelerator and inhibitory fibres in the heart are discussed, in relation with the influence of *antiar*; and the assumption of the existence of specific accelerator fibres is shown to be unnecessary.—Dr. Curnow notes variations in the arrangement of the extensor muscles of the fore-arm.—Dr. Brunton explains a simple method of demonstrating the effect of heat and poisons upon the heart of the frog.—Mr. G. A. Berry and Prof. Rutherford note with reference to Pflüger's law of contraction, that the excitability and length of the portion of nerve traversed by the voltaic stream must be taken into account in studying the changes of the electrotonic state.—Prof. Rutherford notes with regard to the action of the internal intercostal muscles, their elevating action, as rendered evident by binding similarly situated elastic bands to the ribs themselves.—Mr. Reoch has a paper on the oxidation of urea.—Mr. R. Hughes describes an improved freezing microtome, in which ether spray is the cold-producer.—Dr. S. Coupland records an example of Meckel's diverticulum in man.—The Report on Physiology, by Dr. Stirling, concludes the number.

*Poggendorff's Annalen der Physik und Chemie*. Ergänzung, Band vii. Stück 2.—In this number is concluded M. Voigt's paper on determination of the constants of elasticity of rock salt; the case of torsion being here dealt with. Comparing his general results with Navier and Poisson's theory, he finds they contradict it in some points, e.g. the crystals of the regular system do not behave, in reference to elasticity, like uncrystalline media; for the bending and torsion coefficients are *not* independent of the direction; the constants also have different relative values.—M. Obach describes some interesting experiments on the behaviour of amalgams and metallic alloys under the galvanic current. He finds (1) that the current does not produce in either electrolytic separation of the constituents; (2) that sodium amalgam, after being traversed by the current, decomposes water at both poles as before; (3) that action of the current alters neither the hardness nor malleability of tin-lead alloys, nor the liquid state of potassium-sodium alloy. It works in the chemical composition of the alloy near the electrodes no changes exceeding errors of experiment and analysis. In all these points the author opposes M. Gerardin, who, a short time ago, published experiments on the subject. As to the electric currents occurring in amalgamation of metals, M. Obach regards them as thermo-electric currents due to the temperature changes produced by amalgamation.—M. Clausius contributes a lengthy memoir on the proposition of the mean ergal and its application to the mechanical motions of gases; and a paper by M. Weinberg treats of the application of the mechanical equivalent of heat to molecular forces, size, and distance.

*Zeitschrift der Oesterröichischen Gesellschaft für Meteorologie*, Jan. 1.—An article extracted from the Proceedings of the Vienna Academy, containing the results of Prof. Kerner's studies and observations, in the neighbourhood of Innsbrück, on the abnormal rise of temperature with increasing elevation in the valleys of the Alps in late autumn and in winter, occupies nearly the whole of this number. The phenomenon occurs every year without fail in this district, and has been observed in Carinthia, Upper Austria, the Tyrol, and Switzerland. The number of lam-houses upon the mountain sides at an inconvenient distance from the pastures below shows that the inhabitants are well aware of the milder climate to be found at moderate altitudes. While frost reigns in the valleys and trees are leafless, the grass and trees upon the heights frequently keep beautifully green, and flowers that bloom elsewhere in autumn and even in spring bloom in the genial air. The valley folk say at such times that the south wind blows aloft and will soon descend to them. Prof. Kerner acknowledges the plausibility of this notion, but gives good reasons for believing it to be ill-founded. It is true that the equatorial current does descend upon the valleys, gradually displacing the polar, but in the first half, at least, of the period of reversed temperature, none of the signs of a south wind appear in the atmosphere, barometric pressure keeps very high, and the sky clear. The latest uncommonly long spell of seventeen days with reversed temperatures, from Oct. 25 to Nov. 10, 1874, enabled Herr Kerner to ascertain the real cause of the strange and hitherto perplexing phenomenon. From an ascent of the Unnutz (2,111 metres), he learnt that the warm region in every valley lies between two cold regions, whose borders differ in position in every valley. The situation of the nether border of the warm region certainly depends on the height of the bottom of the valley. He reached this border at about 200 metres above the level of the Inn, or 700 metres above the sea, and passed out of the warm region into an atmosphere colder than that of the valley at 1,890 metres above the sea. In crossing the Achmenthal at 950 metres, there was a fall of the thermometer, which was soon succeeded by a rise as he continued to climb. In descending the favoured slopes of the mountain he observed several kinds of flowers, some of which generally come out in spring; but a little lower all vegetation was sprinkled with hoar frost. In making his ascent on the sunny side an upward current accompanied him. On the summit a very slight air came from N.E. as long as the sun kept high. Late in the afternoon it had risen to a fresh breeze, and after sunset the N.E. wind was violent. He then made a short descent on the N.E. slope to about 30 or 40 metres from the top. Here he found a calm, and a little lower a breeze blowing down towards the valley. It appeared accordingly that the polar wind divided itself near the top into two streams, one of which turned down into the valley, while the other flowed over the top and then down into the other valley at the foot of the southern slope. This distribution of



currents seemed to him to point to a reason for the existence of a warm region, like that which Herr Hann found for the high temperature of the Föhn wind, namely, that in descending the cold air becomes condensed, and by condensation raised in temperature. From 4 P.M. on the 4th to 5 P.M. on the 5th of November, 1874, readings of the temperature were taken by four observers at Innsbrück (575 metres), Rumer Alpe (southern slope, 1,227 metres), Heiligwasser (northern slope, 1,239 metres), and at the summit of the Blaser (2,240 metres). The mean temperatures for the twenty-four hours at these stations were respectively, 2.16, 7.06, 4.26, and - 64. The lowest night temperature at Innsbrück was - 2.8; on the Rumer Alpe, + 2.4. The minimum was reached at Innsbrück, just before sunrise, but on the Rumer Alpe at 3.30 A.M.; at sunrise at this elevation the thermometer marked 4.4. At Heiligwasser the same kind of relation was noted, and temperature rose after 4 A.M.; but the maximum by day was much lower than at Innsbrück. The high temperature at this station was not due to heating of the ground by sunshine, for a thermometer fixed on the surface of the soil never rose above 1° C. The wind blew uninterruptedly towards the valley, down the mountain side. There remains but one explanation, namely, that the increasing pressure raises the temperature of the air as it descends. Prof. Kerner proceeds to a more detailed analysis of the distribution of currents over hill and valley both by day and by night, illustrating his theory by diagrams. After sunset the ground of the valley and the air above it cool rapidly by radiation. The air thus made specifically heavy cannot flow off, but rests like a lake at the bottom of the valley. The current which has flowed down the mountain sides being raised in temperature, glides over this stratum, and rises about the middle of the valley, to rejoin the polar wind aloft. By day the air ascends from the valley up the southern slope, and is replaced by a current descending the opposite mountain face. Obviously, the phenomenon of increasing temperature with increasing height must be most striking where the ridges and valleys stretch from west to east, and during periods of polar wind, when the sky is clear and radiation strong.

*Der Naturforscher*, January.—This number contains an account of observations by M. von Schleinitz, on board the *Gazelle*, when on the transit expedition to Kerguelen's Land, of changes of temperature and specific gravity of water in the southern Indian Ocean. His conclusions are briefly these:—1. Ocean currents, with the exception of the currents caused by regular winds, are due to differences in absolute specific gravity of different parts of oceans, and a small difference produces a strong current. 2. The differences in saltness of tropical and cold seas (in relation to absolute specific gravity), acting oppositely to the temperature differences, moderates ocean currents, which would otherwise be so strong in meridional directions that navigation would be impossible. 3. There is probably a zone where the differences in saltness compensate the differences in temperature, so that waters of different temperature and different saltness may be near each other in equilibrium, *i.e.*, without perceptible current. In the western part of the Indian Ocean this zone is between 40° and 45° S. lat.—There is a notice of two recent series of researches by M. Voigt and M. Groth (conducted by quite different methods), on the elasticity of rock salt; it is shown that in regular crystals the co-efficient of elasticity, and therewith the velocity of sound, is a function of the direction; and that both vary, in accordance with Neumann's theory, symmetrically with reference to the planes of symmetry of the crystal.—M. Frank calls attention to the action of light on the opening of some catkin-like blossoms.—From experiments by M. Luchsinger, it appears that glycerine injected under the skin of animals has an arresting action on the fermentative formation of sugar from the glycogen of the liver.—The remaining papers do not call for notice here.

*Jahrbücher für Wissenschaftliche Botanik*. Herausgegeben von Dr. N. Pringsheim. Zehnter Band, Drittes Heft, Mit. 11, Tafeln (Leipzig: Verlag von Wilh. Engelmann, 1876).—The present number of Pringsheim's well-known "Year-book" contains three papers, all of great value. The first is by Dr. George Winter, on the genus *Sphaeromphale* and its allies (with three plates). Körber in criticising the Schwendener-Bornet theory of lichens, stated that *Sphaeromphale* had only greenish-brown microgonidia, and that the spores did not produce hyphæ. Both these statements are shown to be erroneous, and after a careful anatomical and morphological examination of numerous original specimens, dried and recent, of *Sphaeromphale* and its allies, he

groups them together under a single species, *Polyblastia umbrina* (Whlnbg.), Winter, and adds nearly three pages of synonyms!—an eloquent tribute to the species-making capabilities of modern Lichenographers.—The second paper is by Dr. A. Engler, Contributions to the knowledge of the formation of the anther in Metasperms. This paper, which is illustrated with five plates, describes the following subjects: (1) the anthers and pollen of the Mimoseæ; (2) the anthers of Orchidaceæ; (3) the anthers of Asclepiadaceæ; (4) on the so-called introrse and extrorse anthers; (5) on certain apparent departures from the type in the formation of stamens; and (6) on the homologies between stamen and carpel.—The third paper is by Dr. J. Reinke, Contributions to the knowledge of Fucaceæ and Laminariæ (with three plates). The anatomy and external construction of several genera and species are detailed, the most interesting portion of the paper being the paragraphs devoted to secondary circumferential growth in Fucaceæ, and to the formation of adventitious buds.—The illustrations are excellent as usual, and the high character of the *Jahrbücher* well sustained.

*Bulletin de l'Académie Royal des Sciences*, Nos. 9 and 10, contains an article by Van Beneden on the *Pachyacanthus* in the Museum at Vienna. The description of other marine mamifers in other museums is to follow, and the whole are to form an introduction to the descriptions of the allied fossil forms discovered in excavations near Antwerp.

## SOCIETIES AND ACADEMIES

### LONDON

Royal Society, April 6.—"Experiments on the Friction between Water and Air." By Dr. Ritter von Lang. Communicated by N. Story Maskelyne, F.R.S., Keeper of the Mineral Department, British Museum.

The method adopted for estimating the mutual friction of water and air consisted in connecting a glass tube of 8 centims. in length and 0.72 internal diameter with the pipes which supply Vienna with water at a pressure of four atmospheres. Arrangements for securing a vertical position for the tube ensure a perfectly continuous jet, devoid of any broken surface; and a tube surrounding this jet, with its axis coinciding with that of the jet, acts as an aspirator into and along which air is drawn through a lateral feeding-tube. The amount of this in-drawn air corresponding to the fall of a given amount of water was determined by observing the rate at which a film of soap was borne along the feeding-tube; and the velocity of the water causing the in-draught was calculated from the diameter of the water-column and the quantity of water discharged along it in a given time; but after having once determined the form of the slightly conical water column, the amount of water discharged was the only datum required for the calculation.

The influence of a greater or less section of the air feeding-tube on the volume of the aspirated air was carefully determined, while also the absence of any appreciable retardation due to the soap-film was established.

Neglecting the slightly conical character of the surface of the water-column, and assuming (as the result of experiments in which the motion of a smoke-cloud was observed) that the movement of the air was throughout in lines parallel to the axis of the tube along which it flowed, and showing that the pressure does not vary along the length of the tube, the author proceeds to discuss the hydrodynamic equations expressing the conditions of the problem (the motion of the air being uniform and independent of time), and represents the volume of air A passing through the tube in a second as

$$A = W \left[ 2r^2(\log R - \log r) - 1 \right],$$

W being the weight of water, in grammes, discharged in a second,  $r$  the radius of the jet in turns of the micrometer-screw (6.8 turns of which correspond to 1 centim.), R being the radius of the aspirating tube.

The results obtained by observation accorded well with those given by this equation, so long as the value of R did not exceed the limit within which the suppositions regarding the motion of the air hold good.

The question whether the results might not be brought into even closer accord with theory by the assumption that a slipping action takes place between the air and the water-jet on the one hand, and between the air and the tube on the other, instead of the assumption previously made that the air adhered



alike to the water and to the tube in its passage. The result of the calculation, however, led to no nearer approximation; and finally, experiments with other materials for the tube and other gases (namely, coal-gas and carbonic anhydride) were made without resulting in any marked difference from the results obtained with air and glass.

Mathematical Society, April 13.—Prof. H. J. S. Smith, F.R.S., president, in the chair.—Prof. Henrici, F.R.S., having taken the chair, the President gave an account of a note—"Sur un théorème d'Eisenstein"—by M. Charles Hermite. This is the celebrated theorem, considered by M. Heine, on the development in a series of the roots of an algebraic equation  $f(y, x) = 0$ . M. Heine has added the very important remark that we can make all the coefficients of such a development, supposed commensurable, integers, with the exception of the first by changing  $x$  into  $kx$  (Crelle, Band 48, p. 267). M. Hermite's communication gives a simplified proof of this.—Prof. Smith then spoke on the aspects of circles on a plane or on a sphere. He pointed out the connection between his results and those obtained by Prof. Cayley in his researches on trees. He next made some remarks on a problem in crystallography.—Mr. Tucker read part of an abstract (drawn up by Dr. Hirst, F.R.S.) of a paper on correlation in space, by Prof. Rudolf Sturm, of Darmstadt. The paper is connected on the one hand with Sturm's previous one on projectivity in space (*Math. Ann.*, vol. vi.), and on the other with Dr. Hirst's papers on the correlation of two planes, and two space. (*Proc. of Math. Soc.*, vols. v. and vi.)

Chemical Society, Prof. Andrews, F.R.S., in the chair.—A paper on the manufacture of sulphuric anhydride, by Dr. R. Messel and Dr. W. Squire was read by the latter. The authors prepare the anhydride by decomposing ordinary sulphuric acid at a white heat into water, oxygen, and sulphurous anhydride, removing the water by suitable means and then passing the mixed gases over platinised pumice heated to low redness; the oxygen and sulphurous anhydride then reunite to form sulphuric anhydride.—After this paper there was an adjourned discussion on Dr. H. E. Armstrong's paper on systematic nomenclature read at the last meeting, in which Prof. Odling replied at length to the criticisms on the article recently published by him on the same subject in the *Philosophical Magazine*.

Royal Astronomical Society, April 12.—Mr. Wm. Huggins, D.C.L., president, in the chair.—J. Bagnold Smith, Sir David Solomons, W. T. Smedley, Wm. Durrad, Wm. Allsup, and the Rev. Joseph Ferguson were elected Fellows of the society.—Mr. Penrose described an instrument for calculating the sides and angles of spherical triangles. It consisted of two wooden semicircles which could be fixed at any angle, and a graduated arm moving on a universal joint which slid along one of the semicircular arcs. The graduated arm was made use of to measure the cord of the third side of the triangle. Mr. Penrose showed how the instrument might be made use of for roughly checking calculations in spherical trigonometry. He thought that it would also be of use in expeditiously reducing observations in which no great degree of accuracy was required. The instrument was very portable and might be made still more so if the graduated semicircles were divided on brass instead of on wood, as in the instrument he showed. A paper by the Rev. T. W. Webb was read describing some observations of the two exterior satellites of Uranus which had been made by Mr. Isaac Ward of Belfast. Mr. Ward's instrument is a refractor of only 4.3 inches aperture, but he had apparently succeeded on some dozen evenings during the months of January, February, and March, in picking up both the outer satellites Titania and Oberon. A table was given comparing the position angles and distances as estimated by Mr. Ward with those taken from Mr. Marth's ephemeris of the satellites. It was stated that the estimates of Mr. Ward had been made without any previous reference to the ephemeris, the coincidences were such that there seemed little room left for doubt that Mr. Ward had in each instance been successful in picking up the satellites. Mr. Lassell said that he had not seen the satellites with his own nine-inch. It was quite possible that the extraordinary sharpness of Mr. Ward's eye might have enabled him to pick up the satellites; there were records which could not be doubted of persons who had observed the satellites of Jupiter with the naked eye. He thought that if any one else made use of the same telescope they would certainly not be able to detect the satellites.—Mr. Green drew the attention of observers to the visibility of the dark limb

of Venus during the coming quadrature; he had concluded that he perceived the dark limb of the planet against a dark background, but on placing the bright limb of the planet against a dark bar in his eye-piece, he had entirely lost sight of the dark limb. He wished that other observers would try the experiment during the coming quadrature. The meeting adjourned till May 12.

Geological Society, April 5.—Prof. P. Murray, F.R.S., president, in the chair.—James Mansergh, M.A., was elected a Fellow of the Society.—On the basis of the paper by Creswell Crags (second paper), by the Rev. J. Mager, this paper the author gives an account of the contents of the researches upon the contents of the caves in Creswell Crags, Derbyshire. The further exploration of the Pin Hole, described in his former paper, furnish a few bones of *Rhinoceros tichorhinus*, and other animals, but no remains of the Arctic Fox, which were particularly sought for. The remains in this cave were stopped because the red sand in which the bones were found towards the entrance became so hard that the limestone fragments, and almost barren of organic remains. The author then commenced the examination of a chamber called Robin Hood's cave, situated a little lower down the hill on the same side. The section of the contents of the cave showed a small thickness of dark surface-soil, containing fragments of Roman and medieval pottery, a human incisor, bones of sheep and other recent animals; over a greater portion a hard limestone breccia, varying in thickness from a few inches to about 3 feet; beneath this a deposit of a reddish-brown coloured cave-earth, varying in thickness inversely to the thickness of the overlying a dark-red sand about 3 feet thick, like that of the Pin Hole, but with patches of laminated red clay near the surface and containing scattered nodules of black oxide of manganese and some quartzite and other pebbles, which rested upon a layer of lighter-coloured sands containing blocks of limestone, probably forming part of the original floor of the cavern. The hard stalagmitic breccia contained a great many bones, chiefly of small animals, but with some of reindeer, and teeth of *Rhinoceros tichorhinus*, hyæna, horse, water vole, and numerous flint implements and chips, and a few cores. Some of the flakes were of excellent workmanship. A few quartzite implements were also found in the breccia. The cave-earth contained a few flint implements, but most of the human relics found in it were of quartzite and of decidedly palæolithic aspect. There was also an impure mass of clay-ironstone. The animal remains chiefly found in the cave-earth were teeth of horse, *Rhinoceros tichorhinus*, *Equus caballus*, hyæna, and fragments of both jaws of the last-mentioned animal. Bones and teeth of reindeer and teeth of cave-lion were also found. The red sand underlying the cave-earth contained but few bones, except in one place, where antlers, bones of reindeer and bones of bison and hyæna occurred. In another part a small molar of *Elephas primigenius* was found. A large proportion of the bones had been gnawed by hyænas, whose agency the author ascribed the presence of most of the animal remains found; but he remarked that no coprolites of hyænas had been met with. The following is a list of the animals whose remains occurred in this cavern:—*Felis leo* (var. *spelæa*), *Hyæna crocuta* (var. *spelæa*), *Ursus arctos*, *U. spelæus*, *Canis familiaris*, *C. lupus*, *C. vulpes*, *Elephas primigenius*, *Equus caballus*, *Rhinoceros tichorhinus*, *Bos bison*, var. *primigenius*, *Bos longirostris*, *Capra hircus*, *Sus scrofa*, *domestica*, and *ferus*, *Cervus megaceros*, *C. tarandus*, *Arvicola amphibius*, and *Lepus timidus*.—On the mammalia and traces of man found in the Robin Hood Cave, by Prof. W. Boyd Dawkins, F.R.S. The author noticed the various species of animals discovered by Mr. Mello during the researches, the results of which are given in the preceding paper, and drew certain conclusions from their mode of occurrence as to the history of Robin Hood's Cave. He considered that the cave was occupied by hyænas during the formation of the lowest and middle deposits, and that the great majority of the other animals whose remains occur in the cave were dragged into it by the hyænas. That they served as food for the latter is shown by the condition of many of the bones. During this period the red sand and clay of the lowest stratum was deposited by occasional floods. The red loam or cave-earth forming the middle stratum was probably introduced during heavy rains. The occupation of the cave by hyænas still continued, but it was disturbed by the visits of palæolithic hunters. The remains found in the breccia indicate that the cave was inhabited by man, and less frequently visited by hyænas than

<sup>1</sup> See Quart. Journ. Geol. Soc., vol. xxii. p. 679.

The presence of vertebræ of the bœre in the breccia imply that the hunters who occupied the cave had not the a domestic animal. After a discussion of the relations of mammals forming the fauna of the cave, the author proceeded to describe the traces of man found in it, which consist of fragments of charcoal, and implements made of antler and mammoth quartzite, ironstone, greenstone, and flint. The distribution of these implements in the cave represents three distinct series. In the cave-earth the existence of man is indicated by quartzite implements, which are far ruder than those generally formed of the more easily fashioned flint. Out of 94 red quartzite pebbles only three occurred in the breccia, and of 267 worked flints only 8 were met with in the cave-earth. The ruder implements were thus evidently the older, corresponding in general form with those assigned by De Mortillet to "the age of Moustier and St. Acheul," represented in England by the ruder implements of the lower breccia in Kent's Weald. The newer or flint series includes some highly-finished implements, such as are referred by De Mortillet to "the age of Solignac," and are found in England in the cave-earth of the Hole and Wookey Hole. The discovery of these implements considerably extends the range of the palæolithic hunters to the north and west, and at the same time establishes a direct relation in point of time between the ruder types of implements now and the more highly-finished ones above.—Notes on the gravels, sands, and other superficial deposits in the neighbourhood of Newton-Abbot, by Horace B. Woodward, F.G.S. The author pointed out that most of the deposits termed Upper Greensand in the immediate neighbourhood of Newton-Abbot, are in reality intercalated with coarse gravel-beds, containing, among others, fragments of greensand, chert, and chalk-flint. He considered that the only traces of greensand *in situ* were probably on the summit of Milber Down and east of Combe arm, deposits which were identified by Mr. Godwin-Austen. But he could not agree in the identification of greensand at other localities in the Bovey Valley, considering the few fossils found to have been derived from, and with much other material to have been evidently due to, the denudation of chalk and greensand. He pointed out the geographical distribution of these beds of sand and gravel, which extend from the hill-tops bordering the Bovey Valley to near the bottom of the valley, but do not descend into any outlying valleys. He likewise alluded to the peculiar dip into the valley which affects these beds in several places, and observed that sometimes they rested on the Bovey clays and lignites. He thought some connection in their method of formation might be traced with somewhat similar deposits on the Haldon and Black Down Hills. He pointed out the "Head" at the bottom of the valley was sometimes not to be distinguished from the older gravels, from which, however, it was largely derived. He alluded to the discovery of bones, a bronze spear-head, and a wooden doll or idol in this deposit; observing that they indicated the rapid accumulation of gravel, and that this indication was one out of many that might be given, that our modern river-gravels are to a great extent made up of older gravels. In conclusion the writer alluded to some of the deposits now forming on the margin of the Teign estuary, and which are identical in character with the Triassic breccia.—On certain alluvial deposits associated with the Plymouth limestone, by R. N. Worth, F.G.S. The author adduced certain deposits found in fissures and caverns of the Plymouth limestone, as furnishing evidence in opposition to the views advocated by Mr. Belt in his paper on the drifts of Devon and Cornwall.<sup>1</sup> The best examples occur at Plymouth Hoe, where the chief deposit fills a large "pocket" in the limestone, and consists (beneath the turf) of a bed of clayey soil, containing pebbles and small boulders, beneath which are patches of white and red clay, containing a few pebbles, and overlying a large quantity of siliceous sand. Similar, but slightly varying deposits, not unfrequently occur in association with the limestone; and these are regarded by the author as the remains of considerable deposits which once occupied large areas in the valleys of South Devon; and if they are not the lowland gravels of Mr. Belt, the latter are not represented in the district. The author states that there is evidence of the contemporaneity of these deposits with those of the Oreston caves; and he adds that they furnish no proof of cataclysmal action, but of orderly deposition, the bulk of the pebbles and gravels being inland nearer the source of the debris, and further off the sands and clays in fairly regular succession. The author further explains the presence in Cornwall of stanniferous gravels

only in valleys opening to the south, by reference to the position of the watershed in that county, which has only two rivers running to the north, whilst on the south-east rivers abound.

Physical Society, April 8.—Mr. W. Spottiswoode, vice-president, in the chair.—Mr. H. M. Klaassen was elected a member of the Society.—Prof. Foster exhibited and described an instrument for illustrating the law of refraction. It is founded on the well-known method of determining the direction of the ray after refraction by means of two circles described from the point of incidence as centre, the ratio of whose radii is the index of refraction. If the incident ray be projected to meet the inner circle, and through the point of intersection a vertical line be drawn, the line drawn from the point of incidence to the point where this meets the outer circle is the direction after refraction. This principle is applied in making a self-adjusting apparatus as follows:—A rod representing the incident ray is pivoted at the point of incidence, and projects to a point about 4 inches beyond. To this extremity is attached a vertical rod which slides through a nut in another rod also pivoted at the point of incidence. The lower extremity of the vertical rod is attached to a link, so fixed as to constrain it to remain vertical. By this means the two rods always represent respectively the incident and refracted rays, and the index of refraction can be varied by altering the position of the nut, through which the vertical rod passes, on the rod to which it is attached.—Prof. Foster then exhibited a simple arrangement for showing the interference of waves. It consists of two glass plates placed one in front of the other, on each of which is drawn the ordinary sine wave. They are supported in a frame, and behind them is a paper screen bearing lines to indicate the points of maximum and minimum displacement. The plates can be made to slide in opposite directions, and all the phenomena of wave motion generally, and the state of the air in open and closed tubes can be shown. Lastly he exhibited a method, which has been suggested by Prof. Kundt, for showing in a simple manner that the air in an organ pipe is in a constant state of alternate condensation and rarefaction. At the upper end of a closed pipe are placed two valves opening inwards and outwards respectively, and the chambers behind these are connected by india-rubber tubes with small water-gauges which, for the sake of exhibition, were projected on the screen. The gauges were to the eye permanently set, showing at the same time condensation and rarefaction, an appearance which was of course due to the rapidity of change. It was shown that beats cause the air to approximate to its normal density.—Prof. Guthrie exhibited and described an arrangement which he thought might be useful for determining the rate at which machinery is revolving. The instrument is analogous to one which he devised some years ago for rendering a galvanic current constant. The chamber of a manometer is connected with a small force-pump, which makes one complete stroke for every revolution of the engine. A capillary glass tube affords a means of escape for the air introduced by the pump into the manometer. If now the pump be worked uniformly, that is if the engine rotates uniformly, the pressure in the manometer will shortly attain a position of equilibrium, so that the mercury will remain stationary. But if the velocity of the engine increase, the mercury will immediately ascend, and so indicate this increase of speed. The main objection to the instrument, as exhibited, was the oscillation of the mercury, but this might be avoided in several ways which were pointed out.—Mr. Coffin referred to some works in America where he had seen a similar principle applied. The engine was connected with an air chamber, to which was applied a Bourdon's gauge, the indications of which gave an approximate measure of the revolutions of the engine.—Prof. Unwin thought there would be some difficulty in keeping the capillary orifice perfect for any length of time. He referred to a proposal made by Prof. Thomson in about 1852 to use a centrifugal pump for a similar purpose.

Anthropological Institute, April 11.—Col. A. Lane Fox, president, in the chair.—Five new members were announced.—A note on some suggested archaeological symbols for maps, by Mr. Joass, was read by Capt. Dillon.—Dr. Comrie, R.N., read a paper entitled "Anthropological Notes on the Natives of New Guinea," being the result of his observations while attached to H. M. S. *Basilisk*, engaged surveying there. The physical, social, and religious character of the Papuans were discussed, and the probable Polynesian intermixture and origin of the natives of New Guinea considered, the author inclining to the opinion that the Papuan was a pure type of race, the most characteristic fea-

<sup>1</sup> See "Quart. Journ. Geol. Soc.," vol. xxxii., p. 80.

ture next to language being the tape-like flattening of their hair noticeable in an ordinary lens. The paper was accompanied with a comprehensive exhibition of Papuan weapons, works of art, utensils, and articles of dress, which will remain at the Institute till their next meeting, April 25, when the discussion, in which Col. Fox, Lieut. Armit, R.N., Mr. Franks, Mr. Hyde Clarke, the Rev. A. H. Sayce, and others took part, will be continued.—Mr. Brabrook, the Director, then read a paper by Mr. B. Walker entitled "Religion, Politics, and Commerce of Old Calabar," which contained an account of the singular institution of Egbo, the principal object of which is to secure mutual protection amongst the freemen. Admission to the various grades, nine in number, is by purchase. As regards religion each district has a separate but subordinate divinity. Their commerce consists of palm oil, ebony, ivory, and barwood. The inhabitants appear to be advancing in civilisation.

Entomological Society, April 5.—Prof. Westwood, president, in the chair.—Messrs. J. W. Douglas, E. C. Rye, G. Lewis, C. Fenn, J. Dunning Kay, and W. C. Copperthwaite were elected Ordinary Members; and Mr. B. A. Bower, jun., was elected a Subscriber.—Mr. F. Bond exhibited a specimen of *Xylina lambda* taken near Erith in September last by Mr. W. Marshall, being the fifth instance of its having been taken in Britain. He also exhibited *Ebulea stachydalis*, taken by himself at Kingsbury, Middlesex, in June 1862.—Mr. Champion exhibited specimens of *Egialia rufa*, taken by Mr. Sidebotham near Southport, and he brought examples of *Psammotidius sulcicollis* for distribution.—The President made some observations respecting the habits of the common gnat, in continuation of his remarks at the meeting of Nov. 4, 1872. Large numbers of females had again appeared in his house at Oxford, not a single male having been observed, and he believed they had hibernated in the house, appearing the first warm days of spring. He also remarked that Dr. Leconte's valuable collection of *Coloptera* had been presented to the University of Cambridge, Mass.—Sir Sidney S. Saunders exhibited living specimens of *Stylops Kirbyi* taken by himself at Hampstead; altogether he had found eighteen males. Mr. Enock also exhibited a row of eleven males taken on the wing at the same place and about the same time.—The Rev. A. E. Eaton stated that he was preparing a supplement to his monograph of the *Ephemeride* (*Trans. Ent. Soc.*, 1871), chiefly from materials in the collections of Mr. McLachlan and Mr. Albarda, and that he would be glad of any assistance that could be given him by entomologists possessing insects belonging to that group. It appeared that the deficiency in legs in *Campsurus* and some of its allies was due to their being shed with the pupa skin when the insect obtains well-developed wings, and that in some forms all the legs were thus cast off by the female.—Mr. Smith made remarks on the distribution of some genera of Hymenopterous insects from New Zealand, of which a collection had been placed in his hands by Mr. C. M. Wakefield; and was followed by Mr. McLachlan, who remarked on the gradual extinction of the endemic fauna of New Zealand, although introduced forms thrive wonderfully.—The Rev. R. P. Murray stated that he was preparing a list of the species of Japanese butterflies, and that he would be grateful to any entomologist who could assist him with the loan of specimens.—Mr. McLachlan exhibited a series of *Anomalopteryx Chauvini*, Stein., from Silesia, given to him by the discoverer of the species, Fraulein Marie von Chauvin, of Freiburg. This singular Trichopterous insect pertained to the family *Limnophilidae*, and was remarkable for the lanceolate anterior, and abbreviated posterior wings of the male; those of the female being normal, excepting that the posterior wings were smaller than usual. Also apterous females of *Acentropus niveus* received from Mr. Ritsema, of Leyden; and a microscopic slide with a full-grown female example of *Phylloxera vastatrix* of the root form. This he had recently obtained, with many others, from a viney near London, which was terribly infested with the insect.

Meteorological Society, April 19.—Mr. H. S. Eaton, president, in the chair.—T. H. G. Berrey, Assoc. Inst. C.E., H. G. Bolan, J. Bravender, J. Holden, G. A. Hutchins, F. Jackson, J. L. Johnson, B. Latham, A. G. McBeath, W. R. Maguire, A. S. Moss, C. Pink, J. R. Rogers, E. Toller, S. Tomlinson, W. A. Mc I. Valon, H. Walker, W. E. Woolley, were elected Fellows of the Society. The following papers were then read:—Velocity of the wind at Liverpool, tabulation of anemometric records, by W. W. Rundell; on the aspiration of the dry and wet bulb thermometers, by Samuel H. Miller,

F.R.A.S.; on the storm which passed over the sea England on March 12, 1876, by Robert H. Scott, F.R.S.—members of the Permanent Committee of the Vienna Meteorological Congress were present and took part in the discussion.

Victoria (Philosophical) Institute, April 3.—Mr. H. F. R. S., read a paper on the history of Egypt in connection with the Bible.

ROME

R. Academia dei Lincei, Dec. 5, 1875.—M. Moricgia: communicated the results of experiments on the natural poison the body, bile and amygdaline.—M. Volpicelli gave a neurological memoir of Wheatstone.

Jan. 2.—M. Volpicelli described the construction, properties and applications of a constant inductor.—M. Sella gave composition of various salt springs in Italy.—M. Capellini presented a paper on Tuscan fossil whales.—M. Castaldi communicated a note on fossils from the dolomitic limestone of Chaberton, studied by M. Michelotti.—M. Cossa described periclasiferous predazite of Monte Somma.—M. Canziani reported on a memoir by MM. de Negri on the purple of ancients; also on a memoir by M. Paterno, on uric acid: on two new principles accompanying it in *seora sordida*; also one by M. Selmi, on toxicological chemical studies relating atropine and its detection.—M. Struver communicated a memoir on the minerals of Lazio.

BOOKS RECEIVED

COLONIAL AND FOREIGN.—Verhandlungen der Naturhistorischen Gesellschaft für Natur-und Heilkunde, a parts (Boon, Coben and Socini).—Tranfusione del Sangue, pel Dott. Malachia de-Christoforus (Milan).—Fungus Disease of India: T. R. Lewis, M.B., and D. D. Cunningham, V (Calcutta).—The Soil and its Relation to Disease: Same Author's (Calcutta).—Kurze's Chemicches Handwörterbuch: Dr. O. Dammmer (Berlin, K. G. Heim).—Check List of North American Ferns: J. Robinson (Saleen).—Freshwater Shell Mounds of the St. John's River (Florida, Jeffries W. Peabody Academy).—Nephrin und Jadem: Heinrich Fischer (E. Stuttgart).—Adolf Stieler's Hand-Atlas (Gotha, Justus Perthes).—Hemiptera of the Mississippi: P. K. Uhler.—Algebra for Beginners: James Loudon (Toronto, Copp, Clark and Co.).—Le Positivisme: A. P. Gernier Bailliére.—Annual Report of the Smithsonian Institution (Washington, U.S.A.).—The Vertebrata of the Cretaceous Formation of West: E. D. Cope (Washington, U.S.A.—Daily Bulletins of Weather Reports for March 1873 (Washington, U.S.A.)

CONTENTS

"SCIENTIFIC WORTHIES," VII.—SIR CHARLES WHEATSTONE. By Prof. P. VOLPICELLI ( <i>With Steel Engraving</i> )	P.
THE PROGRESS OF THE LOAN COLLECTION	
GREEN'S GEOLOGY	
DIETMAR'S CHEMICAL ANALYSIS. By R. M.	
RICHARD-ON'S "DISEASES OF MODERN LIFE."	
OUR BOOK SHELF:—	
Hinchliff's "Over the Sea and Far Away"	
Some French Geometrical Works	
LETTERS TO THE EDITOR:—	
"The Recent Origin of Man"—THE REVIEWER	
On the Formation of Coral Sand.—JOHN MUNRO ( <i>With Illustration</i> )	
Floating Radiometers.—C. M. INGLEBY	
Preece and Sivewright's "Telegraphy."—J. SIVEWRIGHT	
On the Nature of Musical Pipes having a Propulsive Mode of Action.—HELMANN SMITH	
Solar Halo.—JAMES HERLIS	
Safety Matches.—FRANCIS JONES	
"The Ash Seed Screw."—Dr. WM. McLAURIN.	
OUR ASTRONOMICAL COLUMN:—	
The Rotation of Venus	
Minor Planets	
HUNTERIAN LECTURES ON THE RELATION OF EXTINCT TO EXISTING MAMMALIA, VIII. By Prof. FLOWER, F.R.S.	
PROF. HUXLEY'S LECTURES ON THE EVIDENCE AS TO THE ORIGIN OF EXISTING VERTEBRATE ANIMALS	
THE UNEQUAL DISTRIBUTION OF RARE PLANTS IN THE ALPS. By T. D.	
DEEP-SEA TELEGRAPH CABLES: HOW THEY ARE TESTED ( <i>With Illustration</i> ).	
THE CLIMATIC CHARACTERISTICS OF WINDS AS DEPENDENT ON THEIR ORIGIN	
SCIENCE IN GERMANY. By S. W. ( <i>With Illustration</i> )	
THE EARLY HISTORY OF MAGNETISM. By K.	
THE POTATO DISEASE. By WORTHINGTON G. SMITH ( <i>With Illustrations</i> )	
SCIENCE IN LEEDS	
THE LATE SIR WILLIAM WILDE	
MIDDLE-CLASS EDUCATION IN HOLLAND	
NOTES	
SCIENTIFIC SERIALS	
SOCIETIES AND ACADEMIES	
BOOKS RECEIVED	





~~USE FOR  
ONLY LIBRARY  
DO NOT REMOVE  
FROM LIBRARY~~

Stanford University Libraries



3 6105 007 821 635

FOR DEPT ONLY

