

THE MANUFACTURE  
OF  
ICE CREAMS AND ICES

FRANZSEN and MARRHAM

TX 795

F7

1916

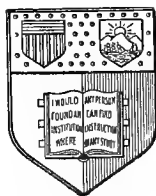

New York  
State College of Agriculture  
At Cornell University  
Ithaca, N. Y.

---

Library

Brill Memorial Collection  
Class 1888

RETURN TO  
ALBERT R. MANN LIBRARY  
ITHACA, N. Y.

Cornell University Library  
TX 795.F7 1916

The manufacture of ice creams and ices,



3 1924 003 592 296

mann

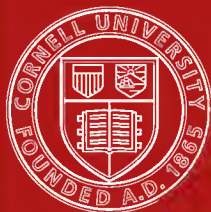

# Cornell University Library

The original of this book is in  
the Cornell University Library.

There are no known copyright restrictions in  
the United States on the use of the text.

<http://www.archive.org/details/cu31924003592296>

# THE MANUFACTURE OF ICE CREAMS AND ICES

By

*J. H. Frandsen, M. S. A.*

HEAD PROFESSOR OF DAIRY HUSBANDRY, UNIVERSITY OF NEBRASKA

AND

*E. A. Markham*

FORMERLY INSTRUCTOR IN DAIRY MANUFACTURES, UNIVERSITY  
OF NEBRASKA



NEW YORK,

ORANGE JUDD COMPANY

LONDON

KEGAN PAUL, TRENCH, TRÜBNER & CO., LIMITED

1916.

@  
TX 795  
F7  
1916

Copyright, 1915, by  
ORANGE JUDD COMPANY

*All rights reserved*

---

Entered at Stationers' Hall, London, England

@ 71084

Printed in U. S. A.

## ACKNOWLEDGMENTS

The authors wish to acknowledge their indebtedness to Prof. F. W. Bouska for valuable assistance in the preparation of the chapter on bacteriology; to Prof. J. D. Hoffman, Professor of Mechanical Engineering in the University of Nebraska, for his helpful criticisms on the chapters dealing with refrigeration and to Mrs. J. H. Frandsen for help and encouragement in the preparation of the manuscript.

The authors are also indebted to the following parties for the illustrations in this book: Wheats' Ice Cream Co., Buffalo, N. Y.; Hendler Creamery Co., Baltimore, Md.; American Creamery Machinery Co., Oakland, Calif.; Dairy Machinery and Construction Co., Derby, Conn.; Creamery Package Mfg. Co., Chicago; B. Riley Hauk Supply Co., St. Louis; N. A. Kennedy Supply Co., Kansas City; U. S. Department of Agriculture; North Bros. Mfg. Co., Philadelphia; The Madison Cooper Co., Calcium, N. Y.; The Vilter Mfg. Co., Milwaukee; The Remington Machine Co., Wilmington, Del.; The York Mfg. Co., York, Pa.; The Armstrong Cork Co., Pittsburg; The Jamison Cold Storage Door Co., Hagerstown, Md.; *The Ice Cream Trade Journal*, New York; The Duke-Doyle Co., Baltimore; The D. H. Burrell Co., Little Falls, N. Y.; The J. G. Cherry Co., Cedar Rapids, Ia.; John C. Raum & Son, Baltimore; The Trumbull Mfg. Co., Columbus, O.; The Confectioners' & Bakers' Supply Co., Chicago; The DeLaval Separator Co., Chicago; DeWitt & Co., Denver; Fairbanks Morse Co., Omaha; The Torsion Balance Co., New York; Russ Bros., Harrisburg, Pa.

J. H. F.  
E. A. M.





## PREFACE

The development of ice cream making into one of the very important branches of the dairy industry, together with the introduction of this subject into the course of study in many schools and colleges, has created a demand for a suitable text on "The Manufacture of Ice Creams and Ices."

The authors have attempted to present in this volume, material which has been gathered during several years of teaching and of actual commercial experience. Ice cream factories in various parts of the country have been visited and studied for the purpose of gaining the most up-to-date information on the subject. They have aimed to bring together all available scientific information relating to the subject of ice cream making and to present it in a scientific and a practical manner and have tried to avoid the mistake of making their work simply a collection of recipes.

They realize that there is need of much experimental work along this line and that future research may modify considerably, views now generally accepted as correct regarding the manufacture of ice cream. In the light of present day information, however, it is hoped this book will be found of value in the class room as well as to the practical ice cream maker.

J. H. FRANDSEN,  
E. A. MARKHAM.

LINCOLN, NEBRASKA.



# CONTENTS

	PAGE
Origin of frozen desserts—Development of the factory system—Manufacture of ice cream in the West—Rapid development in recent years—Present status of the industry—Ice cream making taught in schools—The future of the ice cream industry . . . . .	xiii

## CHAPTER I

THE CREAM SUPPLY—Difficulties in buying cream for an ice cream factory—Kind of cream required—Acidity—Free from odors—Fat content—How to secure high grade cream—Education of patrons—Inspection and supervision of the source of supply—Cream grading—Method of testing the acidity of milk and cream—Mann's acid test—Farrington's acid test—Special acid test in cream grading—Payment according to quality—Methods of testing the purity of milk—Sediment tests—Fermentation test—Test for preservatives . . . . .	I
--	---

## CHAPTER II

THE BACTERIOLOGY OF ICE CREAM—Bacteria—What they are—Conditions of life—Source of bacteria in ice cream . . .	19
---	----

## CHAPTER III

THE CARE OF MILK AND CREAM AT THE FACTORY—Receiving, sampling and grading—Test each patron's shipment—Methods of keeping cream in good condition after it has been received—Cooling without pasteurizing—Pasteurization and cooling—Effects upon the body and swell of the ice cream . . . . .	33
--	----

## CHAPTER IV

CONDENSED MILK, MILK POWDER, AND HOMOGENIZED CREAM—Relation to the ice cream industry—The manufacturing process of condensed milk—The quality of the milk used—Evaporating—Bulk condensed milk—Milk powder—Method of manufacture—Use of milk powder—To supplement the milk supply—Use in ice cream mixture—Homogenized cream—Objects of homogenizing—Process of	vii
---	-----

	PAGE
homogenization — Condensed milk and homogenized cream in the ice cream mixture — Reasons for using — Amount to use . . . . .	48
CHAPTER V	
STABILIZERS — Definition — Kinds of stabilizers used — Starchy stabilizers — Egg albumen — Milk solids — Gums — Gelatin — Prepared ice cream powders — The objects of using stabilizers — Not an adulterant — To give a better body and texture to the ice cream . . . . .	58
CHAPTER VI	
FLAVORING — The importance of good flavor — Kinds of flavoring material used — Spices — Sugars and syrup — Crushed fruits and fruit juices — Extract flavors — Lemon extract — Orange extract — Mint and wintergreen — Nut flavors — Fruit extracts — Vanilla extract . . . . .	65
CHAPTER VII	
STANDARDIZING THE ICE CREAM MIXTURE — Definition of the term — Importance of standardizing — Methods of standardizing — By diagram — Rule for standardizing — The Babcock test for fat in ice cream — Use of special acids . . . . .	79
CHAPTER VIII	
PREPARING THE ICE CREAM MIXTURE — Selecting and mixing the various ingredients — For uncooked mixtures — For cooked mixtures — How they differ from the uncooked mixtures — Preparing and mixing the ingredients — Water ices and sherbets . . . . .	86
CHAPTER IX	
CLASSIFICATION OF ICE CREAM — Ice creams as defined in the pure food law — Classification of ice creams and ices — Mortensen's classification — Washburn's classification — Larsen and White's classification — The need of a simple system of classification . . . . .	92
CHAPTER X	
ICE CREAM FORMULAS — Philadelphia ice cream — Plain vanilla — Other flavors made according to this formula (Bisque, etc.) — Plain vanilla ice cream, containing condensed milk — Several ways of making chocolate ice cream — Directions for	

# CONTENTS

ix

PAGE

using caramel and maple syrup—Nut ice cream made according to the formula for Philadelphia ice cream—How and when to add the nuts—Almond and pistachio ice cream—Fruit ice cream made according to the formula for Philadelphia ice cream—Selecting and preparing the fruit—How and when to add the fruit—The use of preserved fruits—The use of lemons and oranges—A formula which may be taken as the basis for all Neapolitan ice creams—Preparing the eggs—Directions for cooking—Kinds of flavors which may be used—How and when to add the flavor—Cooling and freezing—French cooked cream—Tutti frutti ice cream—Nesselrode pudding—Manhattan pudding—Frozen custard—Other Neapolitan formulas—Almond pistachio—Burnt almond—Butter—Chestnut—Coffee—Filbert—Royal—Fancy molded ice creams and ices—How they differ from ordinary ice cream—Kinds of molds—Use of special formulas—Importance of the trade—Preparing the ingredients for mousse—The cream—Flavoring—Freezing—Formulas . . . . . 99

## CHAPTER XI

WATER ICES AND SHERBETS—General directions—Water ices—Sherbets—Fruit granite—Roman Punch—Milk sherbets—Lactos . . . . . 122

## CHAPTER XII

FANCY MOLDED ICE CREAMS AND ICES—Difference between bulk ice cream and molded ice cream—Difference in formula—Difference in package—For a different class of trade—Importance of flavor and color—Different colors must harmonize—Colors and flavors must harmonize—Kinds of fancy molds—Brick molds—Special molds—Preparing and freezing fancy bricks—Kinds of ice cream used—Ice cream and sherbet—Preparing and filling the molds . . 134

## CHAPTER XIII

THE FREEZING PROCESS—Freezing the mix—In the freezer—After removal from the freezer—Texture and swell of ice cream as affected by the freezing process—Time to freeze—Speed of dasher—Controlling the freezing process—The kind of freezer—The freezing medium . . . . . 148

## CHAPTER XIV

REFRIGERATION—Ice cream making and refrigeration—Refrigeration: a transfer of heat—By ice—By other means—Mechanical refrigeration—Its development and application to

	PAGE
the ice cream industry—The ammonia system—The compressor—The condenser—The expansion coils—Ice cream refrigeration—Brine and direct expansion—The brine system—Direct expansion . . . . .	160
CHAPTER XV	
ECONOMICAL OPERATION OF THE REFRIGERATING PLANT—Introduction—Refrigeration for ice cream factories—Operation of the plant—Operation of the compressor—Importance of proper insulation—Ice making in the ice cream factory—The brine tank—Expansion coils—Ice cans . . . . .	177
CHAPTER XVI	
SCORING ICE CREAMS AND ICES—Difficulties in scoring ice creams and ices—Variable flavor—Kinds of flavors—Flavors imparted by the materials—The qualities of flavor imparted by extracts—Fruit flavors—Nut flavors—Syrups and sugars—Flavors imparted by cream or milk—Body and texture—Definition of body and texture—Appearance—The importance of appearance—Package—Relation of package to appearance—Score cards—Mortensen's—Washburn's—University of Nebraska's . . . . .	191
CHAPTER XVII	
THE ICE CREAM FACTORY; ITS LOCATION AND EQUIPMENT—Importance of good location—Essentials of sanitary construction and arrangement—Light and ventilation—Floors—Walls and ceilings—Facilities for cleaning up—Convenience—Location of storage rooms and machinery—Factory equipment—Simple equipment for a small plant—Ice cream machinery—Essentials of a good freezer—Batch mixers—Ice crusher—Can washer—Sterilizer and drier—Kettle for Neapolitan ice cream—The homogenizer—Cream whipper—Miscellaneous and special equipment . . . . .	202
CHAPTER XVIII	
FACTORY MANAGEMENT—The relation of machinery to factory efficiency—Business methods—The use of records—Forms of records—Cost of conducting the business—Keeping track of packing tubs—Increasing sales—The value of advertising—Methods of advertising—The winter trade . . . . .	239
CHAPTER XIX	
BY-PRODUCTS AND SIDE LINES—Importance of carrying a side line—To utilize surplus milk and cream—Employment to a steady crew—Side lines—Butter—Sweet cream—Fer-	

# CONTENTS

xi

	PAGE
mented milk — Buttermilk — Yoghurt — Cottage cheese —	
Methods of manufacture — Fancy soft cheese . . . . .	255

## CHAPTER XX

<b>ICE CREAM AS A SIDE LINE IN THE LOCAL CREAMERY</b> — Extent to which ice cream is manufactured in small creameries — Condition under which such a venture will prove profitable — Population — Competition — Advantages which a creamery possesses — Difficulties to be overcome — Equipment — Simple equipment for a small plant — Location of the machinery — Profits that may be expected — Cost of material — Value of fat if sold as butter — Value of fat if sold as ice cream . . . . .	270
---	-----

## APPENDIX

Standardizing tables . . . . .	276
Viscogen . . . . .	290
Rules for calculating speed of pulleys . . . . .	291
Sanitary codes . . . . .	293
Mixtures for emulsers . . . . .	298
Standards for dairy products . . . . .	300
Test for swell . . . . .	303





# ICE CREAMS AND ICES

## CHAPTER I

### THE CREAM SUPPLY

**Buying cream for an ice cream factory** presents many problems with which the manufacturer of butter, of condensed milk, or even the whole milk dealer does not have to contend. In the first place, ice cream is a product that cannot be stored for any length of time. No very great surplus can be carried in storage to meet future demands. This in itself would not be such a serious difficulty were it not for the fact that the demand for ice cream is variable. The problem, then, is to be able to secure a sufficient supply of the raw material to meet all demands and yet have as little surplus cream as possible to be disposed of in some other manner.

**The surplus sweet cream** may be disposed of in various ways so that the factory will not have to sustain a loss on the surplus and may, in some cases, realize a profit. In view of these facts and owing to the importance of a sufficient supply at all times, it is better to have a small surplus rather than a shortage of sweet cream.

**The quality of the cream** is of utmost importance. When received at the factory the cream should have an acidity of not more than 0.25 of 1 per cent. It is not suf-

ficient that the cream be sweet, but it must also be free from foreign odors and flavors. Any abnormal odor or flavor in the cream will be imparted to the ice cream and will lower the quality of that product. This is not the only objection that may be raised against off flavored cream. Off flavors are usually associated with a high bacterial content. A high bacterial content indicates that the cream is old, or has been contaminated with filth, or improperly cared for on the farm or in transit.

**The cost of transportation** and the labor of handling will be greatly reduced if the farmers producing the cream can be induced to skim a fairly rich cream. When received at the factory the cream should contain at least 25 per cent. of butter fat. The advantages of shipping a rich cream are very apparent. Since the cream is bought according to the per cent. of butter fat which it contains, it is certainly an advantage to have the fat concentrated into a small volume, as the transportation charges for a pound of fat are less. It is also much easier to ship, and will stand transportation better, because a rich cream does not show the effects of bacterial action as quickly as thin cream since it contains a smaller amount of milk constituents upon which bacteria feed. On account of the waste and greater cost involved in handling thin cream, every effort should be made to secure a cream that is fairly rich in butter fat.

**The means employed to secure cream of the desired quality** will depend somewhat upon local conditions; but the education of patrons to a higher standard, the inspection of the source of supply, the grading of cream, and the payment on the quality basis will be found most effective. The condensed milk factories may be pointed out as illustrations of what a consistent policy of education, inspection, and

grading will accomplish in the way of securing a good, clean raw material.

**Regulating the production of cream.** The manufacturer of ice cream should lay down certain rules and regulations regarding the production and handling of the milk and cream purchased and adopt these as a part of the policy of the concern. To make such a policy effective, however, it will be necessary to get into closer touch with the farmer. This is a point that is too often neglected. But why build a sanitary plant and make all necessary arrangements for manufacturing and delivering the finished product in a cleanly manner if the source of supply is left unguarded? It will be necessary to educate the patrons to a higher standard, otherwise such a policy will meet with considerable opposition.

**Education of patrons.** Notwithstanding all that has been published in dairy papers regarding the care of dairy products, many farmers do not realize that a few degrees in temperature may have a very marked influence upon the quality of the milk and cream, or that a very little dirt can carry enough bacteria to lower the quality of a large quantity of milk or cream. For this reason the factory manager must see to it that his agents give the necessary instructions to the patrons in regard to the proper care of milk and cream on the farm.

As a further incentive to the proper care of milk and cream on the farm, a system of grading should be adopted. Each can of cream should be carefully inspected when it reaches the factory. A knowledge of cream grading should be one of the essential qualifications of the man on the receiving platform.

✕ **Cream grading** has met with considerable opposition not

only from the cream producers but from many cream buyers as well. This opposition is due largely to the lack of a suitable standard. It is not difficult for the average person to distinguish between very good and very poor cream, but when it comes to sorting out the intermediate grades there will be considerable difference of opinion because there is no known method of determining the quality of milk or cream by means of rapid and accurate tests. The senses and judgment of the person doing the grading must be relied upon almost entirely. It is best, however, to supplement these with a test for acidity.

**Grading according to acidity.** In many places cream is graded according to acidity only. This method is very simple but is open to criticism, as cream may be sweet according to the test and still be a second grade cream because of an undesirable odor or flavor. Such odors and flavors may be more objectionable than acidity, and if the acid test alone is used, cream that is off flavor may be passed as a first grade cream. Cream grading on the acidity basis is undoubtedly very imperfect but it is far better than no system at all. Indiscriminate buying fosters carelessness; therefore, some system of grading cream should be employed. Until some better method is found the acid test is to be recommended as an aid in that work.

There are a number of different methods of testing milk for acidity, some of which are quite sensitive but require too much time in operating to be of the greatest value in cream grading.

**Mann's acid test** is to be recommended where quite accurate tests are desired. The test is given here because it is one of the most sensitive and reliable acid tests now in use. The apparatus needed consists of a burette and stand, a 50

c.c. pipette, a white cup, a glass stirring rod, an alkaline solution of known strength, and an indicator.

The burette should be graduated to 0.1 c.c. and should be provided with a pinch cock which is reliable in its operation. The pipette used should be accurately calibrated but should not be drawn to a very fine point. A white dish is used so that a very slight change in color may be easily noticed. The alkali solution used in this test is usually tenth normal solution of sodium hydroxide (NaOH).<sup>1</sup> The indicator is a substance that is colorless in an acid solution but red in an alkaline solution. The purpose of the indicator is to show whether the substance in which it is placed is acid, alkaline, or neutral.

**To test the acidity of milk or cream by Mann's method, proceed as follows:** Mix the sample carefully and then measure out 50 c.c. by means of the pipette. Place the milk or cream to be tested in the white cup and add a few

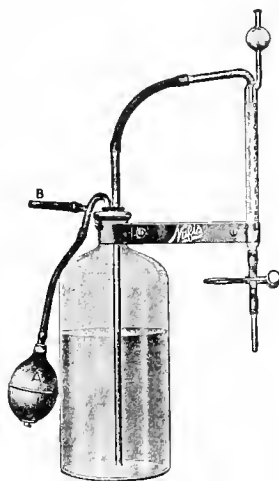

Fig. 1. Nafis apparatus for the rapid determination of the acidity of milk and cream.

<sup>1</sup> A normal solution is a solution that contains one gram equivalent of the active reagent in 1000 c.c. Thus a normal solution of NaOH will contain (Na)<sub>23</sub> plus (O)<sub>16</sub> plus (H)<sub>1</sub> = 40 grams. A tenth normal solution will contain 4 gms. in 1000 c.c. or 0.004 gm in each cubic centimeter and will neutralize 0.009 gm. of lactic acid (C<sub>3</sub>H<sub>5</sub>O<sub>3</sub>). The molecular weight of lactic acid is 90, therefore a tenth normal solution will contain 9 gms. in 1000 c.c. or 0.009 gm. in one cubic centimeter.

drops of the indicator. Fill the burette exactly to the zero mark with the alkaline solution. Add the solution to the sample a little at a time and stir thoroughly. Continue adding the neutralizer until a permanent, but very light, pink color appears. The number of cubic centimeters required to neutralize the acid in the sample is found by reading the scale on the burette. This gives what is called *degrees* of acidity according to Mann's test. Calculation must be made to convert Mann's degrees into terms of per cent.

**To find the per cent. of acid.** Each cubic centimeter of the alkali solution is equivalent to 0.009 of a gram of lactic acid. Each cubic centimeter of the neutralizer used in a 50 c.c. sample will therefore represent  $\frac{0.009}{50}$  or 0.018 per cent. of acid. The total acidity of the sample is determined by multiplying the number of cubic centimeters of alkali used by 0.018. For example, if it requires 8.5 c.c. of the neutralizer to neutralize the acid in 50 c.c. of cream, the acidity of the sample is:

$$0.018 \times 8.5 = 0.153 \text{ per cent.}$$

The factor 0.009 represents the weight of lactic acid neutralized by each cubic centimeter of a tenth normal solution of sodium hydroxide. This test when properly carried out will be found very accurate, but it requires so much time in the various manipulations that one of the following tests will be found more satisfactory for use in cream grading. Of these Farrington's Alkali Tablets offer one of the most rapid and fairly accurate means of testing acidity which may be used in cream grading.

**Farrington's alkali tablets** contain a weighed amount of alkali and an indicator. These tablets must first be dissolved in a definite amount of distilled or soft water. To

prepare the solution, place five tablets in 97 c.c. of distilled water and allow them to dissolve. This solution will be red because it is alkaline. The strength of this solution is such that each cubic centimeter will neutralize 0.01 of 1 per

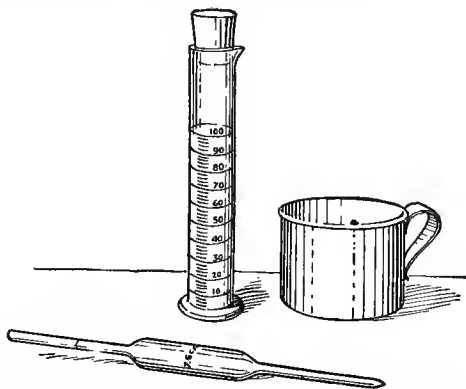

Fig. 2. Apparatus used in Farrington's acid test.

cent. of acid in 17.6 c.c. of milk or cream. The test is not difficult to operate and no calculation is necessary to interpret the results.

**To make the test,** measure into a white cup 17.6 c.c. of the milk or cream to be tested. Rinse the pipette with clear water and add the rinsings to the sample in the cup. Place the alkali solution in a burette or graduated glass cylinder so the amount used may be quickly determined. Add the solution to the milk or cream a little at a time until a permanent pink color appears. When a very light pink color appears it indicates that all of the acid in the milk has been neutralized by the alkali in solution. Find the number of cubic centimeters used. As each cubic centimeter of the

solution neutralizes 0.01 of 1 per cent. of acid, the acidity may be read in per cent. direct. For example, there were 97 c.c. of the solution in the cylinder at the beginning. If, after adding enough of this to the sample to neutralize the acid, there are 77 c.c. left, it required  $97 - 77$  or 20 c.c. of alkali. As each cubic centimeter neutralizes .01 of 1 per cent. of acid, 20 c.c. are equivalent to 0.20 of 1 per cent. of acid in the sample.

It takes a little time for the tablets to dissolve, so a quantity sufficient for one day's work should be prepared each day. In this way there is no delay and the testing for acidity can be done very quickly. These alkaline tablets may be used in another and more rapid test for acidity which is used especially for cream grading.

**The apparatus required in this rapid test** consists of a white cup and two small dippers of equal volume. The dippers should hold about 20 c.c. and must be of exactly the same capacity.

In making the test an alkali solution is first prepared by dissolving eight Farrington tablets in eight ounces of distilled water. This gives a solution of such strength that a given volume of it will neutralize 0.1 of 1 per cent. of acid in an equal volume of milk or cream. That is, if, when we measure out 20 c.c. of milk or cream in the white cup and add to it 20 c.c. of the tablet solution, the mixture remains pink, it indicates 0.1 of 1 per cent. of acid or less. As these operations may be carried out very quickly this test is particularly adapted to cream grading.

As each lot of cream is received, take out a dipperful and pour it into the white cup. With the other dipper add an equal quantity of the alkali solution and mix the two by giving the cup a rotary motion. If the color disappears, it



indicates that there is more than 0.1 of 1 per cent. of acid in the sample. Add another dipperful of alkali, and if the color remains, it indicates that the acidity is below 0.2 of 1

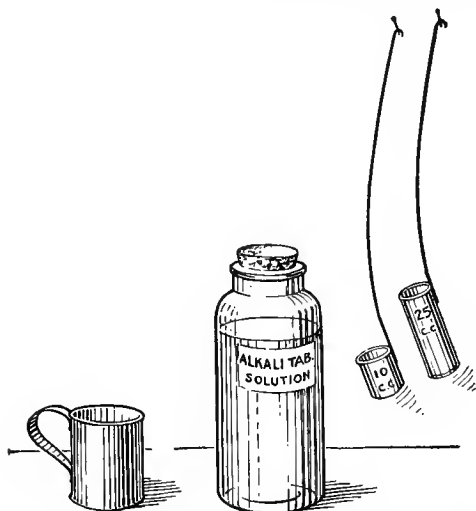

Fig. 3. Apparatus used for rapid estimation of the acidity of milk and cream.

per cent.; but if it disappears, it indicates that the acidity is over 0.2 per cent. and more alkali solution must be added.

**The acid standard.** Where a standard of say 0.25 per cent. acid is adopted as the maximum amount for a first grade cream, the operations can be simplified by making the dipper used in measuring the alkali solution two and one-half times as large as the dipper used for the cream. That is, if the cream dipper holds 20 c.c., the dipper used in measuring the alkali solution should hold 50 c.c. If, upon mixing the cream and alkali solution in these proportions, the

color disappears, it indicates an acidity in excess of the maximum for first grade cream. If the person receiving the cream understands these tests, they will prove quite valuable aids in determining the quality of the various lots of cream.

**Prices paid.** To obtain the best results from a proper system of cream grading, however, there must be a graduated scale of prices paid for cream. A first grade cream should command a better price because of the greater care which the farmer must exercise in its production. Ice cream factories, as a rule, do pay a higher price for the cream which they buy. In view of this fact they should demand a product that meets all their requirements and that will enable the ice cream manufacturer to comply with the stringent regulations of the board of health. Where this system of personal supervision of the source of supply with a system of grading and payment according to quality has been adopted, the results, as a rule, have been highly satisfactory. The experience of some manufacturers shows that however difficult the problem of securing better cream may appear to be, the ice cream maker can secure the grade of cream desired by adopting the proper means to obtain it.

**Testing the purity of milk and cream.** Another method of regulating and controlling the quality of the raw material is by means of tests for purity. The purity of a sample of milk or cream may be determined by a sediment test or by a fermentation test. The sediment tests show approximately the amount of insoluble or suspended impurity in a sample. The fermentation test will give some idea as to the kinds of bacteria that are most active in the sample. It requires much more time to complete a fermentation test; so for rapid determinations the sediment tests are usually employed,

**Sediment tests.** There are two methods of determining the amount of sediment that a given sample may contain. The first method is by placing a sample of milk or cream in a special form of test tube and centrifuging at high speed for ten minutes. The sediment which is a heavy material will be deposited in the bottom of the tube where it may be examined and the quantity and nature of the impurity determined. A more rapid but somewhat less accurate method is by means of filtering.

**The filter test.** In this test a measured quantity of milk or cream is filtered through cotton or filter paper. The sediment which the milk or cream contains is deposited upon the filter. The quantity and nature of the impurity may be determined with

fair accuracy by a careful examination of the filter. It must be remembered, however, that a large part of the dirt that finds its way into milk is soluble and therefore will not be caught upon the filter. Such filth is just as objectionable as the insoluble dirt. It is the fact that filth carries large

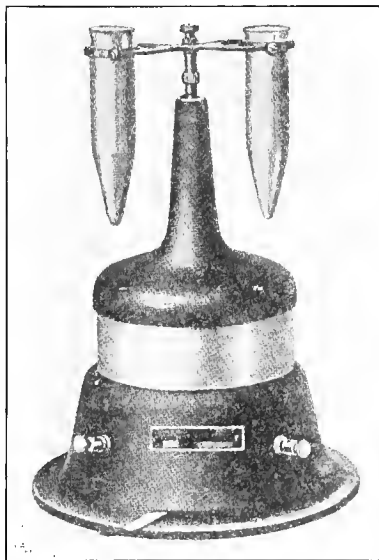

Fig. 4. An Electric Centrifuge for determining the amount of suspended impurity in milk and cream.

numbers of bacteria into the milk that makes it so dangerous. The presence or absence of these bacteria may, for practical purposes, be determined by means of a fermentation test.

**The Gerber fermentation test** furnishes a convenient method for

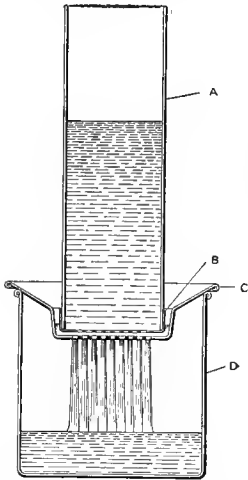

Fig. 5. The Progress Dirt Tester, showing method of operation.

The milk is poured into cylinder (a), on the bottom of which is a perforated cap (b); between this and the dish (c) a disc of cotton batting is placed through which the milk passes into the receptacle (d).

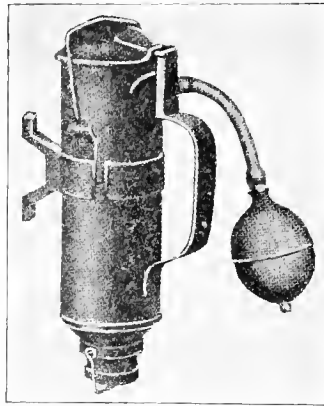

Fig. 6. The Wisconsin milk sediment test.

examining the purity of milk or cream by determining the nature of the change brought about by fermentation. The test requires considerable time for its completion but is very simple and requires but little apparatus.

The apparatus needed consists of a number of glass tubes and stoppers, a rack for holding the test tubes, a water bath, and a thermometer. The apparatus may be purchased especially

for fermentation tests, or ordinary sample tubes and other apparatus found in almost any factory will answer the purpose.

**To make the test**, fill each tube about two-thirds full of the different samples of milk or cream and place them in a rack in an upright position. The tubes and rack are then placed in a water bath. The vessel should be about two-thirds full of water at a temperature of 100° F. to 104° F. This temperature must be maintained all the while. At the end of six hours the tubes are removed one at a time, shaken gently and the appearance, odor and flavor of each sample noted. By keeping the tubes tightly stoppered during fermentation, the odor of the sample will be easily detected when the stopper is first removed. Any objectionable odor in the cream is sure to cause trouble if that cream is used in the manufacture of ice cream. The samples are returned to the water bath and fermented for six hours longer and again examined. The tainted and impure samples may be easily detected by their abnormal coagulation and odor.

Fresh milk or cream that has been properly handled should not coagulate in less than 12 hours when kept under these conditions, nor should it show any indications of abnormal fermentation. If a sample is found which undergoes no change when subjected to these conditions for a day or two, it should be tested for preservatives.

**The most common preservatives** used in milk are formaldehyde or solutions containing formaldehyde. These solutions are sometimes known as "freezine" or "iceline" and by various other trade names.

**A test for these preservatives** which is fairly good and commendable for its simplicity is made by placing 10 c.c. of

milk and 5 c.c. of water in a test tube and mixing thoroughly. Next add 5 c.c. of commercial sulphuric acid, pouring the acid into the tube in such a way that it does not mix with the milk but forms a distinct layer under the diluted milk. If formaldehyde is present, a violet color will appear at the junction of the milk and the acid. This test will show the presence of formaldehyde only when the preservative is present in quite large amounts.

**A test that will show the presence of only a trace of formaldehyde** is made by placing 5 c.c. of milk and 5 c.c. of water in a porcelain dish. To this mixture add 10 c.c. of hydrochloric acid and a few drops of ferric chloride solution ( $\text{FeCl}_3$ ). Heat the mixture slowly and if formaldehyde is present a violet color will appear.

These tests with the sediment and fermentation tests will be found useful in controlling the quality of the milk and cream received. To fully understand the fermentation test, however, a knowledge of the elements of bacteriology will be of considerable value.

**United States Department of Agriculture**  
 BUREAU OF ANIMAL INDUSTRY,  
 DAIRY DIVISION

**SCORE CARD FOR MARKET CREAM**

*Exhibitor* .....

*Address* .....

NUMERICAL SCORE

Flavor, 40.	Composition, 25.	Bacteria, 20.	Acidity, 5.	Appearance of package and contents, 10.	Perfect score, 100.
					Judge's score.

DESCRIPTIVE SCORE

Flavor	Composition	Bacteria	Acidity	Package and contents
Excellent.	Perfect.	Perfect.	Perfect.	Perfect.
Good.	Fat. ...per cent.	Total ..... Liquefiers ..	...per cent.	Foreign matter. Metal parts. Unattractive. Lumpy. Frothy.
Fair.				
Bad.				
.....				
Flat.				
Bitter.				
Weedy.				
Garlic.				
Silage.				
Smothered.				
Manure.				
Other taints.				
.....				

*Remarks* .....

.....

*Date* .....

*(Signature)* .....

*Judge.*

## DIRECTIONS FOR SCORING

## FLAVOR

If rich, sweet, clean, and pleasant flavor and odor, score perfect (40). Deduct for objectionable flavors and odors according to conditions found.

## COMPOSITION

If 20 per cent. fat or above, score perfect (25). Deduct 1 point for each one-half per cent. fat below 20.

## BACTERIA

Less than 10,000 per cubic centimeter . . . . . 20 (perfect).  
 Over 10,000 and less than 25,000 per cubic centimeter. . . 19  
 Over 25,000 and less than 50,000 per cubic centimeter. . . 18  
 Over 50,000 and less than 75,000 per cubic centimeter. . . 17  
 Over 75,000 and less than 100,000 per cubic centimeter. . 16  
 Deduct 1 point for each 25,000 above 100,000.

When an unusually large number of liquefying bacteria are present, further deduction should be made according to conditions found.

## ACIDITY

If 0.2 per cent. or below, score perfect (5). Deduct 1 point for each 0.01 per cent. above 0.2. (If Mann's test is used, discontinue adding indicator on first appearance of a pink color.)

## APPEARANCE OF PACKAGE AND CONTENTS

If package is clean, free from metal parts, and no foreign matter can be detected in the contents, and physical condition of product is good, score perfect (10). Make deductions according to conditions.



# United States Department of Agriculture

## BUREAU OF ANIMAL INDUSTRY

### DAIRY DIVISION

#### SCORE CARD FOR MARKET MILK

*Exhibitor* .....

*Address* .....

NUMERICAL SCORE

Flavor. 40.	Composition 25.	Bacteria, 20.	Acidity, 5.	Appearance of package and contents, 10.	Perfect score, 100.
					Judge's score

DESCRIPTIVE SCORE

Flavor	Composition	Bacteria	Acidity	Package and contents
Excellent.	Perfect.	Perfect.	Perfect.	Perfect.
Good.				
Fair.	Fat	Total .....	...per cent.	Foreign
Bad.	... per cent.	Liquefiers ..		matter.
.....	Solids not			Metal parts.
Flat.	fat.			Unattractive.
Bitter.	... per cent.			
Weedy.				
Garlic.				
Silage.				
Manure.				
Smothered.				
Other taints				
.....				
.....				

*Remarks* .....

.....

*Date* .....

(*Signature*) .....

*Judge.*

## DIRECTIONS FOR SCORING

## FLAVOR

If rich, sweet, clean, and pleasant flavor and odor, score perfect (40). Deduct for objectionable flavors and odors according to conditions found.

## COMPOSITION

If 4 per cent. fat or above and 8.5 per cent. solids not fat or above, score perfect (25). Deduct 1 point for each one-fourth per cent. fat below 4 and 1 point for each one-fourth per cent. solids not fat below 8.5.

## BACTERIA

Less than 10,000 per cubic centimeter . . . . .	20 (perfect).
Over 10,000 and less than 25,000 per cubic centimeter . . .	19
Over 25,000 and less than 50,000 per cubic centimeter . . .	18
Over 50,000 and less than 75,000 per cubic centimeter . . .	17
Over 75,000 and less than 100,000 per cubic centimeter . .	16
Deduct 1 point for each 25,000 above 100,000.	

When an unusually large number of liquefying bacteria are present, further deduction should be made according to conditions found.

## ACIDITY

If 0.2 per cent. or below, score perfect (5). Deduct 1 point for each 0.01 per cent. above 0.2 per cent. (If Mann's test is used, discontinue adding indicator on first appearance of a pink color.)

## APPEARANCE OF PACKAGE AND CONTENTS

If package is clean, free from metal parts, and no foreign matter can be detected in the contents, score perfect (10). Make deductions according to conditions found.

## CHAPTER II

### THE BACTERIOLOGY OF ICE CREAM

**Bacteria** are the lowest and simplest forms of plant life, each organism consisting of a single cell. There are three groups into which bacteria may be divided according to form. These are the *bacilli* or rod-shaped bacteria, the *cocci* or ball-shaped bacteria, and the *spirilla* or spiral-shaped bacteria. These names apply to the form of the individual cells. The individual cells may grow in clusters, in chains, or in some other definite form. These characteristics aid in identifying the organism.

**Growth of bacteria.** In their growth the cells first increase in size. A new cell wall is formed, dividing the original cell into two new organisms which are called daughter cells. Where the division of the cells takes place in one plane continually, the bacteria will form chains. The individual cells are so small that the organism cannot be definitely identified by its general form. Its food habits must be taken into consideration also.

**Saprophytic bacteria.** Bacteria feed upon a great variety of materials. In most cases, however, their food is confined to organic substances, such as sugars, proteids, fats and other inert material, but some forms may feed upon either living or dead tissues. Most bacteria, however, are unable to feed on the living tissues because the living organ-

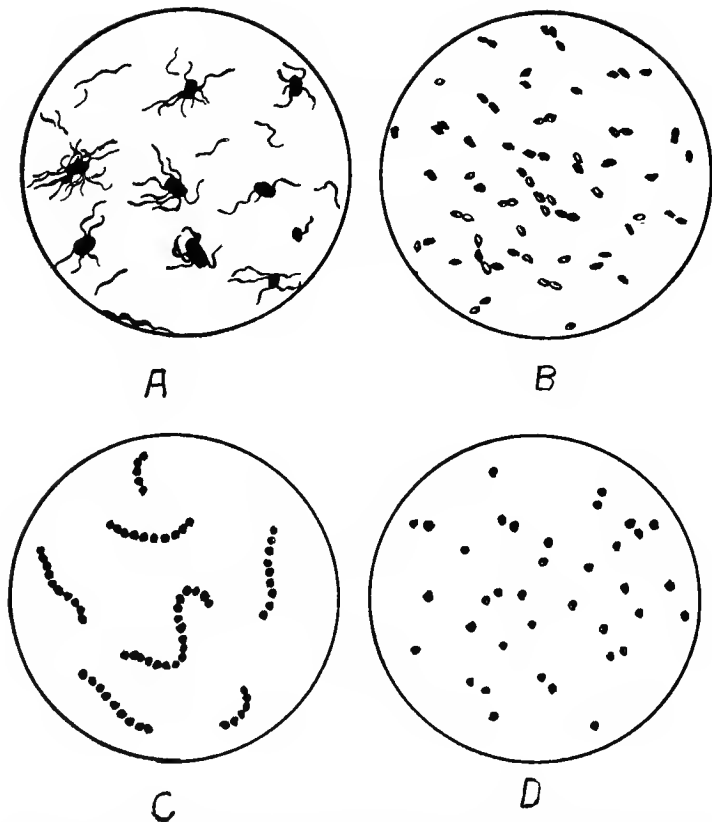

Fig. 7. Forms of Bacteria. (a) Bacteria with hairlike appendages which enable them to swim about in water or milk. (b) Typical lactic acid bacteria. (c) Bacteria of the coccus type, hanging together in chains. (d) Bacteria of the coccus type. (From *Farmers' Bulletin* 490.)

ism has the power to resist bacteria. If placed on the same tissue after it is dead, they will feed upon it very readily. Bacteria of this type are known as *saprophytes*.

**Parasitic bacteria.** The bacteria that feed upon the living tissue of plants or animals are known as *parasites*. To this class belong the disease producing bacteria. Both the parasitic and saprophytic forms may be carried in milk but very small numbers of parasitic bacteria are far more objectionable than large numbers of bacteria of the saprophytic type.

**The food habits of bacteria** are varied, but certain specific organisms are responsible for peculiar changes which take place in the fermenting substance. For the person handling dairy products, a knowledge of the food habits of the most common forms of bacteria is of considerable importance in bacterial control. The action of a particular class of bacteria will manifest itself by the formation of certain products in the fermenting mass. For example, the bacteria that feed on milk sugar will produce acids, other forms feeding on proteid material will cause putrefaction. A general idea of the nature of the active organism can be obtained by observing the products formed in the process of their growth and multiplication. For convenience, bacteria may be classified according to their food habits into fermentative and putrefactive organisms.

**Fermentative bacteria** are those that bring about the less complex changes, such as acid production from a splitting up of the milk sugar. The acid producers are normal milk bacteria that are sure to be present even under the most sanitary conditions. It is only when they have increased enormously that their presence is objectionable. The production of acid renders the milk and cream unfit for

use in ice cream; consequently, the proper means must be employed to hold the acid producers in check.

**The gas producing bacteria** are usually associated with filth. The presence of these organisms is therefore much more objectionable than the acid producers. Acid fermentation frequently accompanies the gassy fermentation but there is no mistaking the work of the gas producing organisms. The milk and cream may become entirely unfit for food.

**The fat-splitting bacteria** are not so well understood but it is known that some bacteria have the power of splitting up fat into glycerin and free fatty acid. This cleavage of fats is due to an enzyme secreted by the bacteria and is probably hydrolytic in nature. The rancidity of butter, milk, and allied substances is thought to be due to the action of bacteria belonging to this class.

**Putrefactive bacteria** belong to that class of organisms that feed on proteid matter. Substances such as meat, eggs, casein, and albumen are subject to putrefactive changes when acted upon by bacteria. The action of these organisms when carried to a point where the results of their growth are noticeable renders the substance unfit for food. Under some circumstances the products of the decomposition of proteids are poisonous. Ptomaines are substances of this sort. The toxic substances sometimes developed in dairy products may be of this class also.

**Ice cream poisoning.** The so-called ice cream poisons may be metallic compounds formed in milk or cream that has been shipped in improperly tinned or rusty cans. The formation of poisonous chemical substances from metals was at one time the popular explanation for food poisoning. Later investigations, however, show that where poisons are

found in food substances they are usually the cleavage products of bacterial action upon proteid matter. Ptomaines, the poisonous substance formed in meat, and tyrotoxinon, a poisonous substance sometimes found in stale cheese, are of this class of degenerate proteids. Other proteid substances are subject to this same decomposition. Such products as bakery cream puffs, which sometimes contain large amounts of egg albumen or gelatine, are regarded as dangerous by some people because of the fear that these products may not be fresh and the proteids which they contain are subject to decomposition. The so-called ice cream poisons belong to a class of protein compounds allied to ptomaines and tyrotoxinon but are by no means confined to ice cream.

The bad results that sometimes follow the consumption of large quantities of ice cream when a person is in an overheated condition have been mistaken for ice cream poisoning. Cases of true ice cream poisoning are not as common as many people think. However, as ice cream is a dairy product containing large amounts of proteid substance, which under insanitary conditions may break down and form toxic compounds, the utmost cleanliness should be practiced at all times.

The ptomaines and allied substances must not be confused with the bacterial toxins, which are secreted by certain bacteria irrespective of the medium in which they grow. The ptomaines are cleavage products of the substance upon which bacteria feed, whereas the bacterial toxins, in the specialized meaning which the term has acquired, are soluble, secretory products of the bacterial cells.<sup>1</sup> The formation of ptomaines takes place in dead proteid matter but many

<sup>1</sup> "A Text Book of Bacteriology," Hiss and Zinsser, page 185.

of the bacteria that secrete toxins or that contain poisonous bodies in the bacterial cell are able to attack living tissues. These are the disease producing bacteria.

**Disease bacteria.** It is a well known fact that disease can be spread by infected milk. The disease organisms that find their way into milk may come from the cows producing the milk or they may be introduced from diseased attendants handling the milk or cream. The possibilities of contamination from these two sources and also the contamination from improper sewage disposal and polluted water must be carefully guarded against. Such diseases as tuberculosis, typhoid fever, scarlet fever, and diphtheria may be spread over a wide territory by milk and cream. According to Conn, the tubercle bacillus does not multiply in milk but typhoid bacteria are able to increase in milk under favorable conditions.<sup>2</sup>

**Conditions that affect the growth of bacteria.** Since milk and other dairy products may furnish food for many different kinds of bacteria, the subject of bacterial control is of considerable importance to all who are engaged in any branch of dairying. The fact that milk sometimes contains toxic substances or disease germs must not be construed to mean that the presence of poisons and disease germs is the rule or even a common occurrence. Particular bacteria appear when the conditions under which the substance is handled are such that a particular organism finds access to that substance. But after the organisms have been introduced they may flourish or die, increase or decrease in numbers and activity according as the conditions are favorable or unfavorable to their growth and multiplication. The conditions which affect the life and activity of bacteria are food,

<sup>2</sup> "Dairy Bacteriology," Conn, pp. 91 and 101.



moisture, light, chemicals and heat. The growth of bacteria can be controlled by varying these conditions upon which their multiplication depends.

**Food** for bacteria must be in solution before it can be absorbed or made use of by the cell. When the food is not in perfect solution, such as the casein in milk, the bacteria secrete a digestive substance, known as an enzyme, which breaks down the complex and insoluble substance into a simpler and soluble form. Milk sugar, being in solution, is readily attacked by bacteria and converted into lactic acid, hence souring is one of the most common fermentations that takes place in milk and cream. In addition to being soluble, the material must be in the proper degree of dilution.

**Moisture.** Soluble substances that undergo rapid fermentation in dilute solutions are not attacked by bacteria when the substance is in concentrated form. For example, dilute sugar solutions undergo fermentations very readily, but concentrated sirups are not readily acted upon by bacteria. A study of the composition of milk shows that it contains an abundance of food in about the proper dilution for bacterial growth.

**Light.** Even where other conditions are favorable, bacterial growth will be checked or even destroyed by light. Direct sunlight is fatal to bacteria. The organisms make their best growth in moist, dark places; hence, the factory should be light and as dry as possible. In controlling the growth of bacteria in dairy products, however, exposure to light would have little or no effect upon the bacteria; consequently, other measures must be adopted. Except in the manufacture of condensed milk and milk powder, it is impractical to in any wise affect the bacterial growth by alter-

ing the concentration of the milk or cream. The other means that may be employed are the use of chemical substances and heat.

**Chemicals.** Certain chemical substances such as formaldehyde, corrosive sublimate, carbolic acid, etc., are fatal to bacteria. Substances which do not destroy the bacterial cell or completely check their growth are known as *antiseptics*. Stronger chemicals which destroy the bacterial cell are called *disinfectants*. The strong chemicals such as corrosive sublimate, formaldehyde, etc., are also antiseptics when very dilute. Chemicals cannot be used in controlling the growth of bacteria in milk and cream for the reason that these substances are injurious to the health of the consumer. Antiseptics and disinfectants may be applied as washes or sprays to floors, sewers, waste cans, etc., should the plant become infected with bacteria which cause some abnormal fermentation.

**Heat.** The only safe and satisfactory means of controlling the growth of bacteria in milk or cream is by regulating the temperature. The rate at which bacteria multiply in milk and cream varies with the temperature. It is therefore possible to control the growth of bacteria in milk without altering its normal composition and without the addition of any dangerous chemical substances.

**Effects of low temperatures.** Most forms of bacteria grow most rapidly at a temperature of about 90° F to 98° F. As the temperature decreases the growth of the bacteria is retarded until at very low temperatures all growth may cease. The cell life is not destroyed at low temperatures. The organism lies dormant until conditions again become favorable for its growth.

**Effects of high temperatures,** An increase in tempera-

ture, on the other hand, may at first increase the activity of the organisms. As the temperature continues to increase, the growth of the cells will be checked until a point is reached where all growth stops. A further increase in temperature will destroy the life of the cell. The *thermal death point*, the temperature at which the cell life is destroyed, varies somewhat with different bacteria. Some forms are more resistant to high temperature than others. The thermal death point will also vary with the length of time the organism is exposed to the temperature. Under most conditions a temperature of 140° F. for 20 minutes is sufficient to destroy the life of the cell. At higher temperatures the time of exposure decreases, until at very high temperatures an exposure of one minute or less will be sufficient to destroy vegetative cells.

**Pasteurization.** The effects of high temperatures on bacterial life are made use of in the process known as pasteurization. In the pasteurizing process, the aim is not to sterilize the milk or cream but to destroy most of the bacteria present without imparting a cooked flavor or otherwise altering the flavor, appearance, and properties of the substance. Pasteurized milk is not sterile and unless it is properly taken care of after pasteurization, will undergo fermentation in the course of a very short time.

**Spores.** The fermentations that take place in the pasteurized milk are due largely to the bacterial spores which are quite difficult to destroy.

The following extract from Bulletin 134 of the Iowa station shows the effect of pasteurization and low temperatures upon the bacterial content of cream:

“After pasteurization, however, the practical ice cream maker considers it necessary to store the cream so that it

will regain its viscosity and give a suitable yield. This introduces the question of whether or not there is an increase in bacteria during this period. A two-day period is considered suitable for holding the pasteurized cream. If the

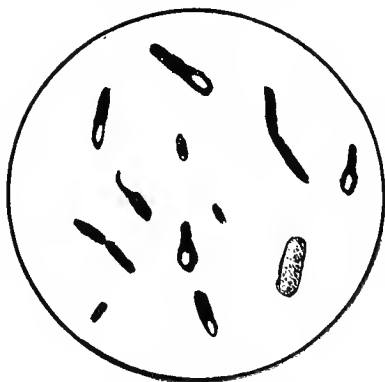

Fig. 8. Typical rod-shaped Bacteria. In some of these the spores are shown as clear areas. (From *Farmers' Bulletin* 490.)

number of days without an increase in the number of bacteria which develop on plain agar at 98° F. It may be objected that holding cream in bottles differs considerably from holding it in quantities as is done under practical conditions, but the data given later show that up to four days, at least, there was no increase of any importance in cream stored in ten-gallon cans and in the work reported the cream was at times at a temperature as high as 37° F."

**Sources of bacteria in ice cream.** Under ordinary conditions the most of the bacteria in ice cream will be those introduced with the cream and milk. If these substances are

results obtained by Conn and Esten with milk are applicable to cream, no increase would be expected during this time, inasmuch as cream is usually stored at a temperature close to 32° F. by immersing in ice water. Bacterial counts were made from time to time and the results obtained are shown in the table on page 29.

" This table shows that cream can be held at about 32° F. for a number

## BACTERIAL CONTENT OF PASTEURIZED CREAM AT DIFFERENT AGES

Time of Test After Pasteurization	Sample 1	Sample 2	Sample 3	Sample 4	Sample 5
Immediately ..	6,000	6,300	2,100	2,000	68,000
Days, 1.....	6,600	5,900	2,900	1,700	68,000
2.....	4,500	5,800	....	....	47,000
4.....	....	....	....	....	49,000
5.....	....	....	3,900	3,000	68,000
6.....	4,300	5,400	3,200	2,000	....
7.....	4,100	4,100	....	....	....
8.....	....	....	2,800	2,900	....
9.....	3,800	4,200	....	....	....
10.....	....	....	2,300	....	....
11.....	5,200	3,800	....	....	2,400,000
12.....	....	....	1,800	1,400,000	....
13.....	3,800	3,700	....	....	....
14.....	....	....	2,100	....	....
15.....	....	....	....	....	....
24.....	....	....	....	....	....

pure, the bacteria will be the normal milk organisms which are not particularly objectionable. Thorough pasteurization of the milk and cream will reduce the number of bacteria from this source to a negligible quantity.

**Fruits.** The bacteria introduced into the ice cream mixture with such materials as fresh fruits need not be very great if proper care is taken to select and prepare the fruit. The bacteria in ice cream that are introduced with the fruit or fruit juice are not necessarily injurious but they swell the total number.

**Gelatin** is used quite extensively as a stabilizer for ice

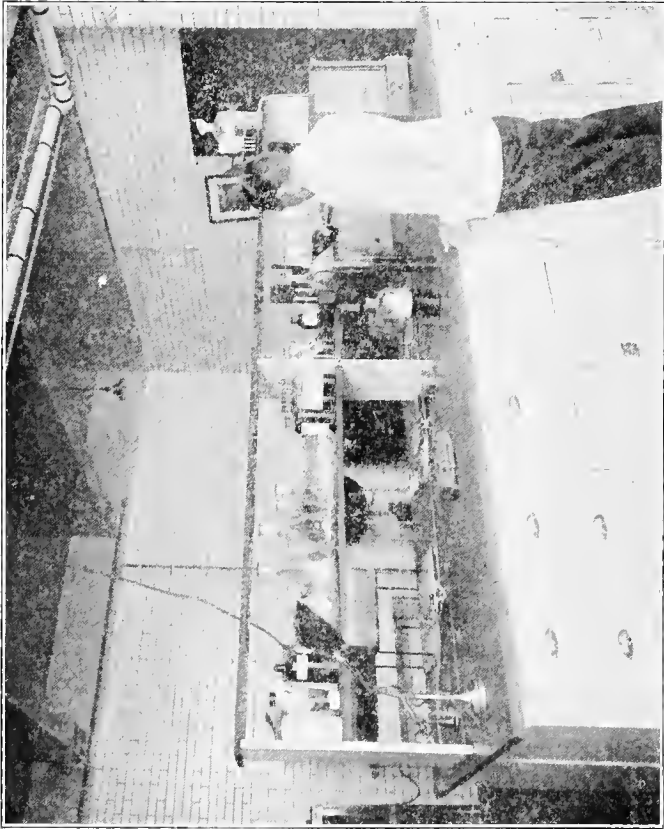

Fig. 9. Bacteriological Laboratory in an ice cream factory.

cream. Great care should be used to select gelatin of known purity. The importance of this is shown in the following table taken from Bulletin 134 of the Iowa station.

Sample Number	Bacteria per gram	Bacteria in 1 c.c. of ice cream due to gelatin
1	113,000,000	565,000
2	14,000,000	70,000
3	35	0.2
4	4,200	21
5	85,000	42.5

This shows to what extent gelatin may increase the bacterial content of ice cream. It is for this reason that the use of gelatin in ice cream is frequently condemned. The same is true of condensed milk. The greatest care should be exercised in selecting these materials.

**The condensed milk** most generally used in the manufacture of ice cream is known as condensed bulk milk. This milk is not sterilized, as a rule, and consequently may carry a varying number of bacteria, depending upon its age and original purity. The canned goods turned out by the condensories are sterilized and tested before being placed upon the market, but the bulk milk is not treated in this way. It is usually shipped in ten-gallon milk cans or in barrels. Care should be taken to select nothing but clean, fresh stock. It should not be held for any length of time before it is used.

**Old ice cream** which has been returned to the factory to be refrozen is one of the most dangerous sources of contamination. The practice of permitting retailers to return unsold ice cream to the factory for credit should be discouraged. The retailer should be able to judge his needs with sufficient accuracy and should be prepared to keep the

ice cream well packed so that it will not be necessary to return unsold ice cream. The ice cream when returned to the factory is usually very soft or even in a melted condition. In this melted ice cream the bacteria grow rapidly. If the cream used in its manufacture has been pasteurized, the fermentations taking place in the melted ice cream are not likely to be of an acid nature, because of the destruction of the lactic acid bacteria in the pasteurizing process. The bacteria present in the old ice cream are more apt to be of the type that feed upon proteids. It has been pointed out that the cleavage products of proteids are sometimes poisonous. Hence, the proteolytic fermentations taking place in the old ice cream may be of a dangerous nature, particularly if the ice cream contains a poor grade of gelatin.

**Unclean utensils** introduce into the ice cream large numbers of bacteria of the most undesirable sort. Every precaution should be taken to have all utensils properly cleansed and sterilized. Shipping cans having deep crevices along the seams or roughened places, due to improper tinning on the inside, are very difficult to keep clean. Such cans should be retinned and the seams flushed with solder. The cans will then be easy to clean. Hot and cold water for washing and rinsing must be available at all times. Sterilizing may be done with hot water but a steam jet is more satisfactory. With the proper facilities for cleaning and sterilizing utensils, the number of bacteria in ice cream, coming from the utensils, should be very small.



## CHAPTER III

### THE CARE OF MILK AND CREAM AT THE FACTORY

The proper handling of milk and cream as soon as it reaches the factory is of utmost importance in the ice cream business. Each can of inferior cream received, or allowed to spoil after reaching the factory, means a cut in the profits of the business. In order to prevent losses of this sort and to insure the keeping qualities of the cream as well as the purity of the ice cream made from it, some provision must be made for receiving, sampling, and grading the raw material as it comes to the factory. The sampling and grading must be followed by thorough pasteurization and cooling to insure the best results.

**Receiving.** As each shipment of milk or cream reaches the factory it should be weighed, sampled, and graded. Each patron's shipment should be weighed separately and tested for butter fat by the Babcock method, so that payment may be made on the butter fat basis. Payment on this basis is more businesslike than the old method of buying cream at so much per gallon. It also prevents losses to the factory and at the same time does exact justice to each patron, provided the sampling and testing are properly done.

**Sampling.** Each can of milk or cream should be thoroughly stirred before the sample is taken. The sample may

be taken with a long-handled sample dipper, with a milk thief, or a McKay sampler, if a composite sample is to be taken. For milk tests a composite sample may be taken, and the test made two or three times a week. A composite sample is a sample made up of small amounts of milk taken

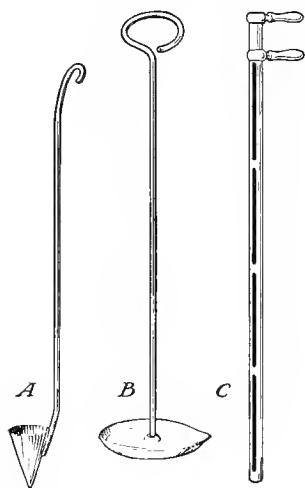

Fig. 10. Types of Milk Samplers. (a) Sample dipper; (b) Combined dipper and stirrer; (c) McKay Sampler.

from a number of shipments. Such a sample should represent the average quality and proportionate amount of the whole. This system of sampling is quite satisfactory for milk. For cream, it is much more difficult to get even a fairly accurate composite sample, because the viscosity of the cream makes it difficult to measure out an exact amount. A slight variation in the amount taken from one shipment may introduce quite an error on account of the high percentage of butter fat in cream. For this reason each patron's cream shipment should be tested separately.

**Testing.** The method of testing cream for fat involves no great variation from the method followed in testing milk. The only precautions that need be mentioned here are the weighing of the samples, manner of reading the test, and the temperature at which the test is read. It is necessary to weigh into the test bottle the exact amount of cream necessary for testing, because a pipette will not deliver an

exact amount. In the first place, the fat content of cream is variable, and the specific gravity of the cream varies with the fat content. More or less air is also incorporated with the cream in passing through the separator and cannot escape on account of the viscosity of the cream. On account

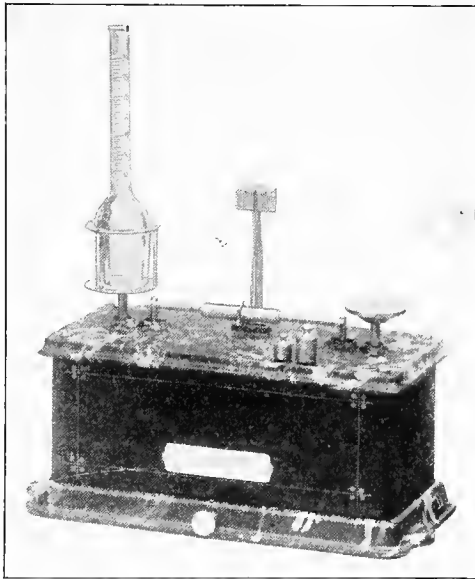

Fig. 11. The Torsion Balance.

of this viscosity more cream adheres to the inside of the pipette also. For these reasons a fair test cannot be made without weighing the exact amount of cream. For this purpose quite a sensitive balance must be used. All the other operations of the test are the same, except in the reading of the fat column.

The proper points from which to read cream tests are illustrated in Fig. 13. It will be noticed that the milk tests are read from the extreme bottom of the fat column to the extreme top, whereas the cream test is read from the bottom of the fat column to the bottom of the meniscus. The reason for this difference is that in a whole milk sample there are some fat globules too small to be separated

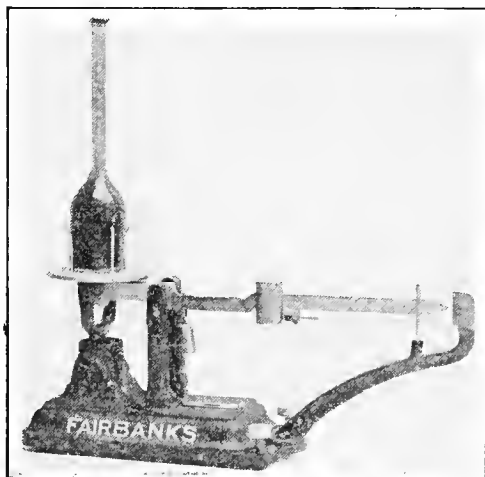

Fig. 12. The new Fairbanks scale.

by centrifugal force; therefore, the fat which is not separated is compensated for by giving the fat column a more liberal reading. In reading either milk or cream tests care must be exercised to have the tests at the correct temperature.

The temperature at which these tests should be read is  $140^{\circ}$  F. Since the fat column will contract or expand

with a change in temperature, correct readings will not be obtained if the temperature is much above or below 140° F. This is particularly true of cream because of the greater volume of fat which it contains. For more detailed

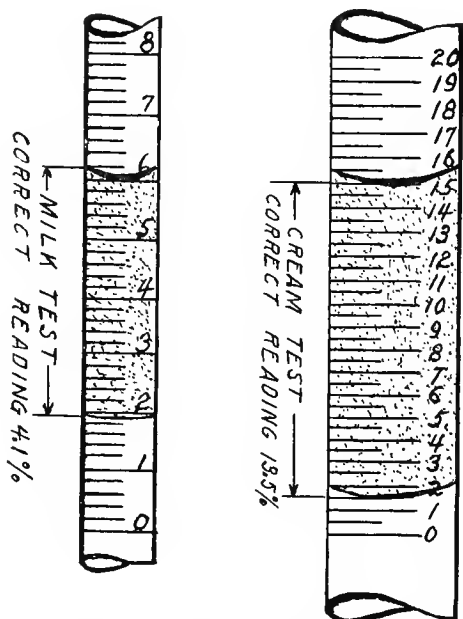

Fig. 13. Showing the points from which milk and cream tests should be measured.

information on testing milk and cream the reader is referred to some special work on that subject.<sup>1</sup>

After receiving, sampling, and grading the milk and

<sup>1</sup> Farrington and Woll's "Testing Milk and Its Products."



Fig. 14. The Testing Room in an Ice Cream Factory.

cream, the next consideration is to prevent as far as possible the increase of bacteria in the milk or cream before it is used. As ice cream factories usually pay a price somewhat in advance of the regular butter fat price, every can of cream that sours means quite a loss to the factory. To be prepared for any increased demand for ice cream, the manufacturer must carry a supply of sweet cream on hand.

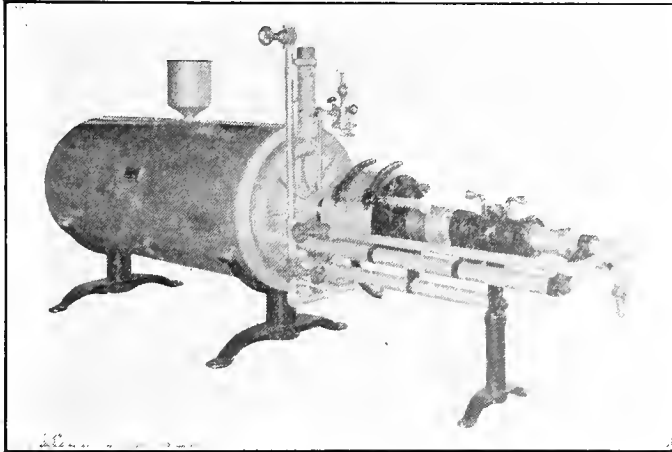

Fig. 15. A Continuous Pasteurizer.

How large this supply should be will depend upon the size of the regular trade, the capacity of the plant, and the facilities for handling and storage.

**Where facilities for pasteurization are wanting and storage facilities are limited the reserve cream supply can not be very large. Under such conditions the cream must be cooled as quickly and as thoroughly as possible and held at a low temperature. The better method, however, is to**

pasteurize and cool the cream before placing it in the storage rooms. In the smaller establishments, which cannot afford to install a pasteurizer, the cream may be pasteurized in ordinary milk cans by placing them in hot water. The cream should be stirred to insure uniform heating. A temperature of  $140^{\circ}$  F. to  $145^{\circ}$  F must be maintained for about 20 minutes.

**The process of pasteurization** consists in heating the milk

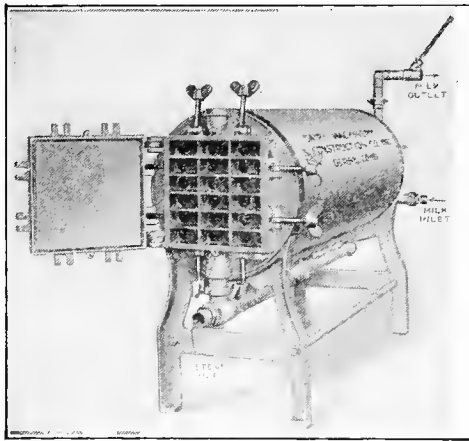

Fig. 16. The Progress Barrel Heater.

or cream to a temperature sufficiently high to destroy all the vegetative cells of bacteria, yeasts, and molds, and then cooling quickly to a very low temperature to inhibit the growth of spores which are not destroyed at the temperatures employed in pasteurization. There are two methods of pasteurization, known as the continuous method and the intermittent method.



**The continuous method.** In this method there is a constant inflow and discharge of the milk or cream. In these machines the milk or cream is subjected to a very high temperature for a very brief period of time. This system is therefore known as "flash heat." Rapid heating is accomplished by passing the milk or cream over the heated inner wall of the pasteurizer in a very thin sheet. The time during which the milk or cream is subjected to the high temperature is very brief. In most cases a temperature between 170° F. and 180° F. for from one to 1½ minutes is employed. The advantages claimed for the continuous method are greater capacity and greater efficiency.

**Greater capacity** is claimed for these machines because there is a continuous inflow and discharge of the milk or cream. This continuous operation makes it necessary to heat higher because the milk or cream is exposed to the heat for a very short time. The advantage claimed for rapid and high heating or "flash heat" is that a very sudden increase in temperature is more effective in destroying bacteria. It is also claimed that many more of the spore bacteria are destroyed by this system, because the heat is raised so rapidly that the organism is destroyed before it is able to pass into the spore state. When properly handled and so regulated that all of the milk or cream passing through the machine is heated to the desired point, these machines are very efficient. The machine is not automatic, however, and must be regulated from time to time. Even in the hands of a careful workman there will be considerable variation in the temperature at which the milk or cream is pasteurized. This difficulty may be overcome and all the advantages of rapid heating and continuous operation retained by holding the milk or cream for a short time before cooling.

**The Retarder.** At the rate cream passes through a continuous pasteurizer, a temperature of 140° F. to 145° F. would accomplish nothing. To permit the use of a lower temperature in operating a continuous pasteurizer and to secure greater efficiency, a device known as a retarder is used in connection with the pasteurizer. The purpose of the retarder is to retard or delay the flow of cream from

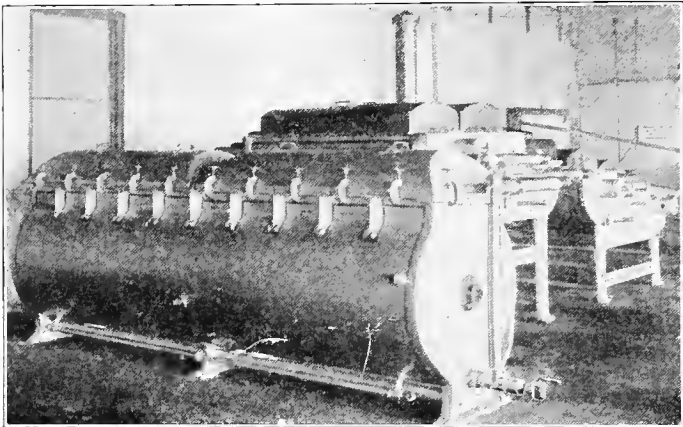

Fig. 17. A Retarder.

the pasteurizer to the cooler. By this process the cream may be held for any desired length of time at the pasteurizing temperature without any intermission in the flow of cream, and a more thorough pasteurization is secured without the attendant ills of pasteurization at higher temperatures. In other words, the use of a retarder combines the advantages of the continuous and the intermittent methods of pasteurization.

**The intermittent process.** The milk or cream is heated

to 140° F. or 150° F. in a large vat and held at that temperature for the desired length of time, usually 20 to 30 minutes. It is claimed that this insures a more thorough pasteurization because the temperature is applied for a definite length of time and is uniform throughout the mass. Another ad-

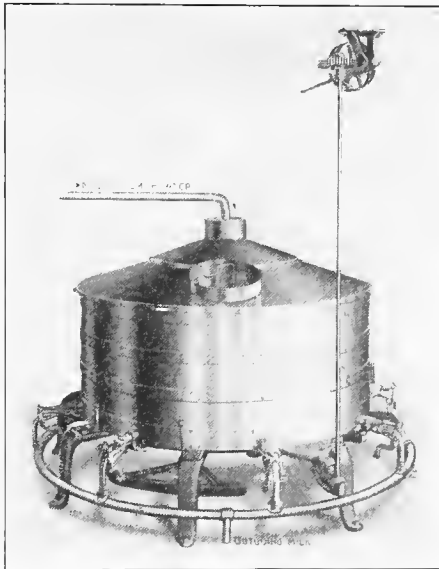

Fig. 18. Progress Holding Machine.

vantage claimed for this system is that the pasteurization is accomplished at a lower temperature, which does not impart a cooked flavor or otherwise affect the properties of milk or cream to the same extent as the continuous method where high temperatures are employed. The objections raised against this system are that larger machines are required in

handling the large batches of milk and cream, and it is slower because of the intermittent action.

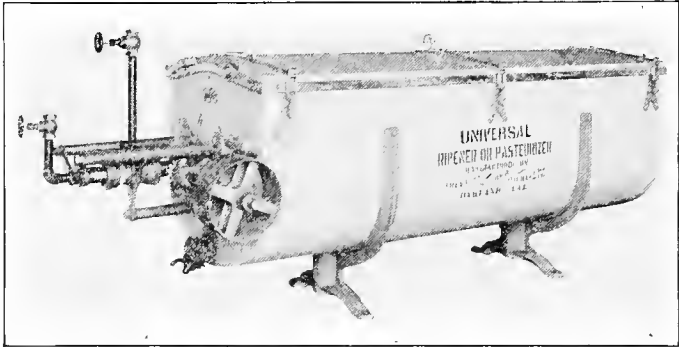

Fig. 19. Universal Vat Pasteurizer.

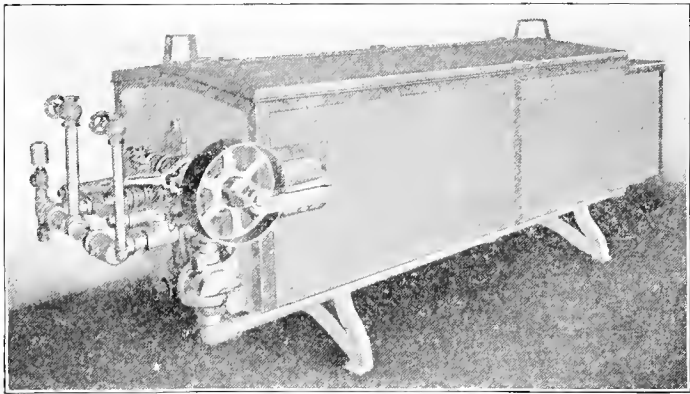

Fig. 20. Wizard Pasteurizer.

After the milk or cream has been heated to the proper point for the desired length of time it should be cooled as

quickly and thoroughly as possible. This is accomplished by running the milk or cream over a cooler having a double water-way. In these coolers the coils are in two sections, the upper one being cooled with ordinary water, and the lower one cooled with ice water or cold brine. By means of such a cooler the pasteurized cream or milk may be reduced to a very low temperature.

**Cooling** should be done as quickly and thoroughly as possible to prevent the germination of spores which have not been destroyed by heat. The pasteurized cream should then be placed in the cream storage room and held at a temperature of about 33° F. to 34° F. for 36 to 48 hours before it is used. In case the plant is not equipped with cold storage facilities, the cans of pasteurized cream should be placed in a tank and packed in a mixture of ice and salt. Frequent stirring will hasten the uniform cooling of the cream. Pasteurized cream that has been cooled and held in this way will keep better and the ice cream made from it will have a good body and a smooth texture.

**Effects of pasteurization upon the body and swell of ice cream.** Pasteurization partially destroys the viscosity of the cream but this viscosity can be regained to some extent by holding the cream for some time at a low temperature. If the cream is not handled in this way, the ice cream made from it will not swell properly and will have a rather weak body. The success attained in using pasteurized cream will, therefore, depend upon the proper care of the cream after pasteurization.

**Storage.** As soon as the cream has gone over the cooler it should be transferred to a refrigerated storage room. The cans should be kept covered to protect the cream from exposure to the air. Owing to the fact that the cooling

rooms must be kept tightly closed in order to maintain a low temperature, there is very little change of air; consequently, the rooms will in time become foul and musty. Such a condition should be guarded against and an effort made to keep the cream storage rooms sweet and clean and the air dry. A temperature very near the freezing point should be maintained at all times.

**Pasteurized cream is not sterile**, and if the temperature is at all favorable for the growth of bacteria, the number of bacteria in the milk and cream will increase quite rapidly from the spores which were not destroyed in pasteurization. There are, therefore, two reasons for holding the cream and milk at a low temperature; namely, to restore viscosity and to prevent the growth of bacteria. The sweet cream in the storage rooms must not be allowed to freeze, however, because there is a tendency for the cream to become buttery when it is again melted.

**The advantages of pasteurization** are a slight improvement in the body and texture of the ice cream, provided of course, that the cream is properly aged before being used, and a reduction in the number of bacteria in the ice cream. The disadvantages are an increase in manufacturing costs, due to the extra machinery needed and extra time required, and more fuel consumed. There is also the liability of producing a weak bodied ice cream and of obtaining a smaller yield, unless there are good facilities for cooling and storing the cream. Another quite important point is the fact that the lactic acid bacteria are destroyed; consequently, if the temperature in the storage room should happen to go up, the bacteria that develop in the cream will be of the more undesirable type.

**The cost of pasteurization**<sup>2</sup> is estimated at a little over 0.3 of a cent a gallon for milk and a little over 0.6 of a cent a gallon for cream. The tests conducted by the U. S. Department of Agriculture also show that the "flash heat" process is more expensive than the "holder" or intermittent process. The cost of pasteurization may in many cases be still further reduced by utilizing the heat contained in the exhaust steam from the engine. This heat would be sufficient, in many cases, for all the pasteurizing done in the plant, if it were properly utilized instead of being permitted to go to waste.

<sup>2</sup> Office of Information, U. S. Department of Agriculture.

## CHAPTER IV

### CONDENSED MILK, MILK POWDER, AND HOMOGENIZED CREAM

Condensed milk and milk powder are very frequently used in the ice cream mixture, where they serve the double purpose of making up a part of the batch and have a stabilizing effect as well. Because of the high percentage of milk solids which they contain, their chief value in ice cream making, aside from their food value, is in giving better body and texture to the frozen product. In the manufacture of condensed milk and milk powder, the water or a large part of it is driven off, leaving the solids in a highly concentrated form. Because of this high concentration it is very important that the milk used in the manufacture of these substances be of good quality.

**The quality of the milk** used in the manufacture of condensed milk must be of the best obtainable. The condensers learned, early in their experience, that when the milk is brought into a concentrated form, the acids that developed, and any undesirable odors or contaminations which the milk may contain are also concentrated. To make good condensed milk it is necessary first of all to secure a supply of milk that is pure, fresh, and as free from contamination as possible. The process of condensing this milk consists in removing from it a considerable portion of the water by evaporation. According to the pure food



standard, "Condensed milk, evaporated milk, is milk from which a considerable portion of water has been evaporated and which contains not less than 28 per cent. of milk solids of which not less than 27.5 per cent. is milk fat."<sup>1</sup>

**The process of evaporating** and condensing the water contained in the milk is accomplished by heating it under reduced pressure. The purpose of evaporating under reduced pressure is to avoid giving the milk a cooked flavor and also to avoid, as far as possible, all those changes ordinarily brought about in milk by high heating. Since the boiling point of milk is a little higher than that of water, it would be impossible to condense the milk at that temperature without caramelizing part of the sugar and imparting a pronounced cooked flavor to the finished product. To avoid these and other changes in the milk it becomes necessary to condense it at a lower temperature. Since the boiling point varies with the atmospheric pressure, it is possible to bring milk to a boil at a temperature of 130° F. to 135° F. by reducing the pressure. The apparatus used for this purpose is known as a vacuum pan.

**The vacuum pan** is a large kettle containing a steam coil or steam jacket to supply the necessary heat. The pressure within the pan is reduced by means of a vacuum pump and a 26-inch vacuum maintained until the milk has reached the proper degree of concentration. Under these conditions the water is evaporated quite rapidly and passes into the condenser in the form of vapor.

**The condenser** is located at the top of the vacuum pan and is directly connected with it. As the milk boils the vapor rises and passes out of the vacuum pan into the condenser, which is simply a horizontal extension of the vacuum

<sup>1</sup> Bulletin 143, Indiana station, page 484.



Fig. 21. Vacuum Pan in the Elkhorn Valley Condensory.

pan. In the condenser the vapor comes into contact with a spray of cold water which causes it to condense. The condensed vapor and the condensing water are carried off by means of a pump. This process goes on until the milk is concentrated to the proper density. From this point the process is somewhat different for canned condensed milk and the condensed bulk milk.

**Condensed bulk milk.** The condensed milk used in ice cream making is made in much the same way, except that it is not usually put up in cans and is not sterilized. The first part of the process is the same. When condensed to the desired point, the steam is shut off and the vacuum broken but the milk is allowed to stand in the pan, receiving the heat only from the jacket or by blowing steam directly into the milk in the pan. This is called *super-heating* and is done to prevent the precipitation of the sugar. In the super-heating the milk becomes very thick and heavy. It is then drawn and cooled as quickly as possible and put up in ordinary milk cans. The sterilizing is omitted because the milk is intended for immediate use and should not be held for any length of time. It is used quite extensively in ice cream making both as a part of the batch and as a means of improving the body of the ice cream. Its effect upon the body of ice cream is due to the high percentage of milk solids which it contains.

**Milk powder** is also used as a stabilizer and as a part of the batch. It consists of the solids of milk reduced to a dry state by evaporation of the moisture contained in the milk. Milk powder is a comparatively recent product but has been steadily growing in favor on account of its convenient form and the various uses to which it may be put. It is used in various ways in the manufacture of ice cream.

The manufacture of milk powder, therefore, bears quite an important relation to the ice cream industry, particularly in those localities where an abundant supply of raw milk and cream is difficult to obtain. The process of manufacturing milk powder is not as simple as it might, at first thought, seem.

The same precautions that must be observed in selecting milk for the manufacture of condensed milk apply also to milk that is to be used in the manufacture of milk powder. The milk used must be fresh and of good quality. Whole milk, skim milk, or partly skim milk may be used. The problem of eliminating all of the water from this milk, simple as it may seem, was solved only after much experimentation and repeated failures.

In the manufacturing process the milk must be reduced to a dry powder which is easily soluble in water and will give a solution possessing all of the properties of normal milk. The problem which confronted the pioneers in this field was to discover a process by which milk could be reduced to a powdered form without breaking down some of the complex constituents of milk or rendering them insoluble. The methods now employed may for convenience be divided into two general groups.<sup>2</sup> One may be termed the *atomizing process* and the other the *hot cylinder or roller process*. A partial vacuum is also sometimes employed in either of these processes to reduce the temperature at which complete evaporation takes place.

**In the atomizing process** the milk is first pasteurized and then condensed in a vacuum pan. The condensed milk is forced through an atomizer into a chamber through which heated currents of filtered air are circulated. The

<sup>2</sup> F. B. Fulmer in *Butter, Cheese & Egg Journal*, April 16, 1913.

milk being in the form of a very fine spray, loses its moisture almost as soon as it enters the chamber. The vapor is carried off by the air currents and the solids fall to the floor in the form of powder.

In the hot cylinder process the milk is sprayed continuously upon a hot cylinder which revolves at a slow speed. The water evaporates very quickly and is carried off by means of a ventilator. The milk solids are deposited upon the polished surface of the cylinder and are removed as fast as deposited by means of stripping knives. One hundred pounds of skim milk are reduced to about  $8\frac{1}{2}$  or 9 pounds of milk powder.

This powder is sometimes used in the ice cream industry as a stabilizer. Its value as a stabilizer is due to the fact that it increases the per cent. of milk solids in the ice cream mixture giving the ice cream a somewhat better body. One-half to  $1\frac{1}{2}$  pounds of milk powder may be used in a five-gallon batch. The powder should be mixed with sugar and then added to the cream. The milk solids in the milk powder increase the density of the mix and give a better texture and flavor to the ice cream. Its greatest value, however, is in supplementing the cream supply by a process known as homogenization.

The objects of homogenizing normal milk and cream,

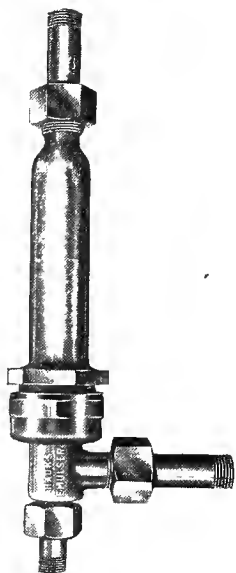

Fig. 22. Hauk's Emulsifier.

which are to be used in the manufacture of ice cream, are to obtain a mixture from which the fat will not separate readily and to increase the viscosity of the cream. Owing to the fact that the fat globules are split up into more minute

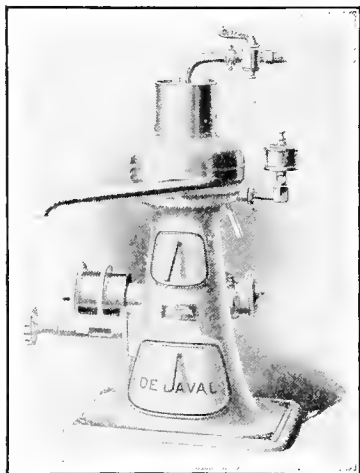

Fig. 23. The DeLaval Centrifugal Emulsifier.

globules, there is less danger of the mixture churning when it is agitated in the freezer. Natural cream which has been passed through the homogenizer is much more viscous than untreated cream of the same richness. When used in the ice cream mixture, the effect of this increased viscosity is an increased swell and a better body and texture in the ice cream. The homogenizer will also aid in solving the problem of obtaining a sufficient amount of cream, because a mixture

of milk powder, water, and unsalted butter when passed through the machine gives a cream of good quality which may be used to supplement the regular cream supply.

**The process of homogenization.** In making homogenized cream, a mixture of skim milk and unsalted butter or a mixture of milk powder, water, and unsalted butter is heated to a temperature of 150° F. or 160° F. At this temperature the fat is in a liquid condition which is very necessary to successful homogenization. This emulsion of fat and skim milk is then forced through

a very small aperture. In this process the fat globules are split up and mixed with the skim milk in a perfectly homogenous condition. The cream thus obtained is much more viscous than ordinary cream of the same richness and is therefore of particular value for ice cream making.<sup>3</sup>

From the foregoing brief discussion it is evident that there are several reasons for using condensed milk, milk

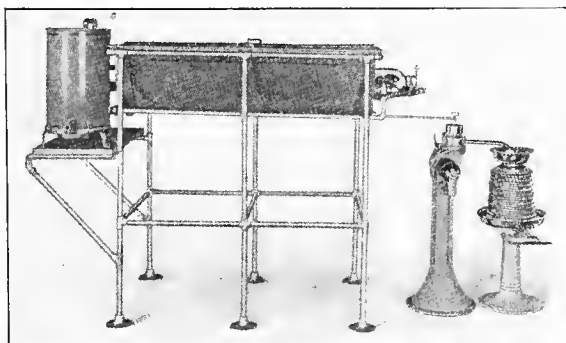

Fig. 24. The Cooksley Creamer.

powder, and homogenized cream in the manufacture of ice cream. In the first place, the food value, body, and texture of the ice cream are greatly improved by the use of any of these substances or a mixture of them. The improvement in body where condensed milk or milk powder is used is due largely to the increase in milk solids which increases the viscosity of the ice cream mixture. As a result of the increased viscosity it is much easier to get the cream to swell properly in freezing. The milk solids other than fat which

<sup>3</sup> For a more detailed discussion of homogenizing machines see Chapter XVII.

these substances contain, modify the natural cream flavor to some extent, giving the ice cream a somewhat more pleasing flavor. These solids also have a high food value which should not be overlooked. The proportions in which these and other ingredients should be used is discussed in an-

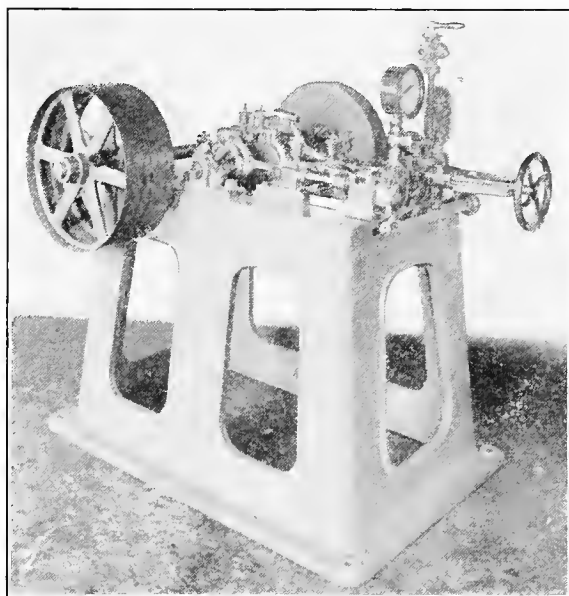

Fig. 25. The Gaulin Homogenizer.

other chapter, but it may be well to point out here that a combination of homogenized cream and condensed milk may give too heavy a body. This condition should be avoided and may easily be overcome by altering the proportion of homogenized cream and condensed milk used in the mixture.



Note: This brief synopsis of the manufacturing process for condensed milk and milk powder is given here in order that ice cream makers may have some idea of the nature of these substances and their function in the ice cream mixture. Those who are interested in the manufacture of these substances will find more detailed information in a new book entitled "Condensed Milk and Milk Powder," recently published by Prof. O. F. Hunziker.

## CHAPTER V

### STABILIZERS

Stabilizers <sup>1</sup> are substances added to ice cream for the purpose of improving the body and texture of the ice cream by preventing the formation of ice crystals in the finished product. In some cases a substance which is added to give the ice cream a better body is termed a *binder*, and a substance added to give a smooth texture and prevent the formation of ice crystals is termed a *filler*. As a matter of fact a substance that will act as a binder will act as a filler also. These terms, however, are somewhat misleading. The term "stabilizer" comes nearer suggesting the true function of these substances in ice cream. Body and texture are so intimately related that the two usually go together and in many places these terms are used interchangeably. On this point Washburn says,<sup>2</sup> "The words *body* and *texture* are used in ice cream making to mean two quite different things. *Body* is synonymous with structure or substance. It refers to the entire mass as a unit. *Texture*, on the other hand, has to do with the finer make-up of the article. . . . The one has to do with the mass characteristics; the other with the arrangement of the particles."

There are numerous substances which may be used as

<sup>1</sup> Sometimes referred to as "holders," "colloids," "binders," and "fillers."

<sup>2</sup> Bulletin 155, Vermont station.

stabilizers. The most common ones are starch, egg albumen, milk solids, gums, gelatin, and prepared powders made from a mixture of two or more of these.

**The starchy stabilizers** are still used quite extensively in ice cream making. Corn starch, wheat flour, rice flour, and arrow starch are the most common of these. Rice flour meets with considerable favor on account of the small size of the starch grains. All starchy substances, however, should be cooked before being used in ice cream because the starch grains break down in the cooking process and are more evenly and thoroughly incorporated with the cream. If the starch is not cooked the coarse grains will very likely be apparent in the finished product. These starchy stabilizers are sometimes used in the plain ice cream and in the cheaper grades. They are rarely used in the fancy cooked mixtures containing eggs.

**Eggs**, when used in ice cream, act both as a stabilizer and as a flavor. Ice cream which contains many eggs has a very smooth texture, a heavy body, and a pronounced custard flavor. Ice cream mixtures of this class must always be cooked before the mixture is frozen.

**Milk solids**, however, do not require cooking and serve a double purpose in the ice cream mixture. These substances are added to the mixture either as milk powder, condensed milk, or in the form of homogenized cream. Where these substances are used in the mixture the ice cream has a better body and texture and also a higher food value on account of the higher percentage of milk solids which it contains. In addition to the substances already mentioned, there are certain gums which are sometimes used in ice cream.

**Indian gum** is the name given to a class of gums which

are nearly alike in origin and composition. According to Circular 94 of the Bureau of Chemistry, "it appears reasonably certain that two gums at least are justly characterized by this term . . . both of which find local application as substitutes for tragacanth."

**Tragacanth** is the name of a gum obtained from plants found in the mountains of Asia Minor.<sup>3</sup> The gum exudes through natural fissures and through incisions, appearing as ribbon and leaf or flake tragacanth. Indian gum, on the other hand, occurs as irregularly shaped lumps, so it is quite different in appearance. It is used in the powdered forms to adulterate the more expensive gum tragacanth. When placed in water, gum tragacanth does not dissolve, but swells and becomes so distended as to occupy all of the water in which it is placed, forming an adhesive, viscous mass. When used as a stabilizer for ice cream the required amount of gum is soaked in warm water before being added to the ice cream mixture, or a "gum tragacanth stock" may be prepared by placing one ounce of gum tragacanth in a quart of water and heating gently until the entire mass becomes thick and tenacious. About three pounds of sugar are then added and in this condition will keep for several weeks.<sup>4</sup>

Gum tragacanth possesses some advantages over many of the other substances used in the ice cream mixture in that it is tasteless, odorless, and easy to use. It is a very satisfactory stabilizer and is frequently used in place of gelatin, particularly where public sentiment is against the use of the gelatinoid stabilizers.

**Gelatin** is obtained from bones, cartilages, and fibrils

<sup>3</sup> Circular 94, Bureau of Chemistry.

<sup>4</sup> Bulletin 155, Vermont station.

of connective tissue. It is extracted from these by boiling with water and forms into a thick jelly-like mass upon cooling. Although gelatin is an albuminous substance, it differs from other albumins in that it does not contain such proteid substances as tyrosine and tryptophane,<sup>5</sup> and therefore is almost odorless and tasteless. When properly used and in moderate amounts its presence cannot be detected by the odor or flavor of the ice cream.

**The use of gelatin** in the ice cream mixture need not give the ice cream maker any difficulty if care is taken to have the gelatin thoroughly melted before it is added to the cream. This is accomplished by melting it in hot water or in a part of the milk used in standardizing the cream. It must be remembered that gelatin is slightly acid. If it is melted in a small amount of milk, there may be enough acid present to cause the milk to curdle. The difficulty may be easily avoided by melting the gelatin in a larger quantity of milk. In some factories an ordinary steam kettle, such as the kettle used for cooking Neapolitan ice cream, is used for melting gelatin. When the gelatin is all melted and free from lumps it should be strained and stirred into the ice cream mixture.

**The advantages of gelatin** as a stabilizer over some of the other substances are very apparent. In the first place, it is more effective in preventing the formation of ice crystals and as a result ice cream containing gelatin will stand shipment much better. The texture of the ice cream is superior to that obtained by the use of starches. It should be pointed out, however, that nothing but pure, wholesome gelatin should be used. It is a false economy and dangerous practice to use the lower and cheaper grades of gelatin.

<sup>5</sup> "Text Book of Physiological Chemistry."

**Prepared powders**, known as ice cream powders or by some special trade name, are made up for the most part from some of the substances described above. The value of these substances depends upon the presence of finely powdered gum tragacanth or gelatin or a mixture of these in rice flour, powdered arrow root, and sugar. The results obtained from the use of these is sometimes quite satisfactory but on the whole it would seem more desirable for the ice cream maker to know the exact nature and composition of the stabilizer used. City ordinances and state laws are not uniform in regard to the use of stabilizers in ice cream; hence, the importance of knowing the composition of prepared substances such as ice cream powders.

**The object of using stabilizers.** It seems that the opinion quite commonly held by those unfamiliar with the process of ice cream making is that these stabilizers are adulterants. This, however, is not the case, as these substances are almost analogous to the baking powders or cream of tartar and soda, eggs, and other substances used in cakes to give lightness. In other words, stabilizers are essential to the production of good body and texture in ice cream made under practical commercial conditions. Instead of being adulterants or substitutes for other food products, many of these have a high food value. The food value of eggs is well known to all. The milk solids which are added in the form of milk powder or condensed milk have a high food value also and at the same time improve the flavor of the ice cream.

**The effect of stabilizers upon swell** has apparently been somewhat overestimated. The opinion held by some is that a stabilizer is used to increase the swell of the ice cream. This opinion is shared by many ice cream makers also, but,

according to all data on this subject available at the present time, stabilizers apparently have just the opposite effect.<sup>6</sup> It has been pointed out that as a rule where varying amounts of these substances are used there is a very noticeable reduction in the average swell of the ice cream during the freezing process.

**The use of gelatin** in ice cream is frequently denounced not only because some consider it an adulterant but because of the fact that it may become contaminated in the manufacturing process. Since this is quite true of the lower grades, great care should be exercised in selecting the gelatin used in ice cream making. When the proper precautions have been taken to select gelatin of known purity, there can be no reasonable grounds for objecting to its use in the ice cream mixture. The amount used is quite insignificant and instead of being a harmful substance, it is a food of no little value. Although gelatin is not a tissue builder, it is said to have a heat and energy value about equal to that of proteids and is very easily digested. Owing to the fact that gelatin melts very readily in warm water and solidifies again upon cooling, it makes an excellent stabilizer for ice creams and sherbets.

The use of stabilizers in ice creams and sherbets is a matter of considerable importance to the ice cream maker where the product must be shipped or hauled some distance before it reaches the consumer. In the hot summer weather it is difficult to ice a tub thoroughly enough so it will stand a very long shipment unless a stabilizer of some sort has been used. The temperature of the ice cream need rise only a few degrees to bring about a condition in which ice crystals will form when the ice cream is repacked. If the

<sup>6</sup> Bulletin 155, Vermont station.

ice cream becomes even slightly softened in transit and is then iced down and frozen, it will be found that the texture has become more or less granular. The difficulties in handling rail shipments of ice cream in hot weather must be encountered to be fully appreciated. These difficulties are overcome, in part at least, by the judicious use of stabilizers.

Just how a stabilizer prevents the formation of ice crystals in ice cream is not definitely known. According to Washburn, gelatin prevents the formation of sharp spines of ice by forming a film around the small ice crystals, and in this way prevents them from increasing in size. He also asserts that gum tragacanth does not form such a film or capsule around the ice crystal but when used in connection with gelatin serves to hold the gelatin capsules together.<sup>7</sup>

The truth of this theory remains to be demonstrated; nevertheless, these substances, which are sometimes called *colloids*, when properly used, enhance the value of ice cream considerably by giving a better body and finer texture which will not become granular after the ice cream stands for a time.

In nearly all the formulas given in chapters X and XI gelatin only is mentioned as a stabilizer. In these and other formulas other stabilizers or a combination of them may be substituted if so desired.

<sup>7</sup> Washburn before the National Association of Ice Cream Manufacturers, Chicago, October 1913.



## CHAPTER VI

### FLAVORING

Frozen desserts are valued mainly because of their pleasing flavor and their cooling and refreshing effects. This being the case, the commercial value of ice cream depends largely upon the care exercised in selecting suitable flavoring material and upon proper freezing rather than the food value of the products. There are so many kinds of flavoring material which may be used and so many brands and grades that it is necessary to select flavoring substances with great care.

Spices, sugars, syrups, crushed fruits, fruit juices, extracts and nuts are the flavoring substances used in one way or another in the manufacture of ice creams and ices. Many of these, such as the spices, find but occasional use in the ice cream mixture.

**The spices.** Cloves, nutmeg, ginger, cinnamon and coffee are the ones most frequently used. Some of these are used only to modify other flavors as in the case of cinnamon, which is often combined with chocolate. Coffee, however, is frequently used as the principal flavoring agent in ice cream and is a popular flavor with some people.

**Sugars and syrups** serve both as sweetening and flavoring agents. The most important flavoring substances of this class are vanilla sugar, maple sugar and chocolate, maple and caramel syrups.

**Vanilla sugar** is employed only in the manufacture of certain fancy and cooked creams. The sugar is prepared by pulverizing ten ounces of sugar with an ounce of finely cut vanilla beans and then sifting the mixture to remove the coarse pulp. The seeds of the vanilla bean should be allowed to pass through the sieve with the pulverized sugar.

**Maple sugar** is one source of maple flavor but is not used to the same extent as maple syrup or maple extract.

**Chocolate syrup** may be prepared by boiling a pound of bitter chocolate, a pound of cocoa and four pounds of sugar with enough water to give a thick syrup. One quart of this syrup is sufficient for ten gallons of ice cream.

**Maple syrup** is used more frequently than maple sugar as a source of maple flavor. This material is too well known to need discussion here.

**Caramel syrup** may be obtained ready prepared, or it may be made by melting one pound of refined sugar in a stew pan or frying pan over a moderate fire, gradually increasing the temperature to about 400° F. or until the syrup has a very dark brown color and a bitter taste. When it is in this condition, a pint of water should be added very slowly and boiled until the syrup is as thick as molasses. Care should be taken not to get the syrup too thick or it will crystallize upon cooling. In that case more water must be added and the syrup boiled again.

Fruit flavors may be obtained in the form of a syrup also. These syrups, however, are more for soda fountain purposes and are therefore little used in the ice cream mixture. Crushed fruits and fruit juices are more satisfactory than the fruit syrups as flavoring for ice cream.

**Crushed fruits and fruit juices.** As a flavoring for ice cream, ices, and sherbets the fresh fruit gives the most sat-

isfactory results. Only sound, mature fruit should be used. If fresh fruit cannot be obtained, canned and preserved fruits may be used to good advantage. To obtain the best results in the use of canned, dried or preserved fruit it is very important that fruit of good quality be selected, because the drying and preserving alters the natural fruit somewhat. This is particularly noticeable in the lower and cheaper grades of fruit.

**The fruit flavors** most frequently called for are orange, lemon, raspberry, apricot, cherry, pineapple and strawberry. Orange and lemon flavor may be obtained in the form of an extract, but for ices and in making the finest quality of ice cream, the flavor should be obtained directly from the fruit.

**Orange.** Owing to its pleasant, mildly acid flavor, orange juice is used in a great many formulas for ices and sherbets, as it blends nicely with almost any fruit flavor. In preparing the orange juice, unless it is used in orange sherbet or ice, the fruit must be peeled to prevent any of the essential oil which is in the rind from getting into the juice.

**Lemon flavor** is not used so extensively in ice cream as in water ices and sherbets. In the ice cream trade both the juice and the extract are employed. The fruit juice is used not only to produce a lemon flavor but to supply the desired fruit acid and to modify the flavor of other fruits. The best lemons to select are the large, smooth ones with thin rinds. They should be stored in a cool, dry place until used. A very fine lemon flavor may be obtained by grating the outer part of the rinds of several lemons and mixing with the sugar. In fact, in many formulas where lemon juice is added solely to increase the acidity, the lemons must be carefully pared before being squeezed to prevent any of the essential oil from getting into the mixture, as it will

impart a distinct lemon flavor when it is not desired. The inner white rind as well as the outer rind must be removed and the lemons cut in halves and all the seeds removed before the fruit is pressed. *Strain the juice before using.*

The other fruit flavors, except pineapple and strawberry, are less frequently used. Many of these are most popular when the fresh fruits are in season. Since the desired flavor is easily obtained from the fresh fruit no great difficulty is encountered in supplying the demand for fruit ice creams. Canned or preserved fruits, however, may be used with very satisfactory results, especially for the pineapple and strawberry ice creams.

**Pineapple flavor.** It is impossible to prepare an extract of pineapple from the fruit; hence, the extracts of that flavor are always synthetic products. The flavor of this fruit, however, is sufficiently pronounced that a good pineapple flavor may be imparted to ice creams and ices from the fruit alone and without the addition of extracts. If fresh fruits are used, care should be taken to select mature, well-ripened fruit. The fruit should be pared and the cores removed before the pulp is mashed and strained. Only as much fruit as can be used at once should be prepared at a time. Canned pineapples may be obtained from any supply house dealing in ice cream flavors and supplies. The high grade canned fruit is of excellent flavor and gives very good results as a flavoring for ice creams and ices.

**Strawberry flavor.** This flavor, like the pineapple, is best obtained by using the fruit. Select well ripened fruit of good color. Clean them carefully and discard all poor berries. They should then be crushed and strained through a fine wire strainer. Add a little sugar to the crushed fruit and mix thoroughly. Even when fresh fruit is used it is

sometimes desirable to add a small quantity of good strawberry extract to bring out the flavor and enough fruit red color to give a light pink color to the cream.

Many factories put up their own strawberries during the season of the year when berries are cheap. The berries are cleaned, crushed, and mixed with an equal part of cane sugar. The fruit thus prepared will keep well if stored in a cool place. If the factory does not have a cold storage room for supplies of this kind, it will be necessary to pasteurize the fruit after the sugar is added. The fruit is usually stored in barrels until needed. The flavor of the strawberries prepared in this way is nearly equal to that of the fresh fruit.

When fresh strawberries can not be obtained it will be necessary to use preserved fruits. In such cases an extract should also be used to bring out a good strawberry flavor. Lemon juice should also be used to increase the acidity and give a fresh fruit flavor.

**Other fruit flavors** such as raspberry, peach, apricot and cherry are very mild and it may be necessary to strengthen the flavor by using an artificial flavoring substance. When canned fruit is used, fruit acid must be supplied by the addition of lemon juice.

**Fruit extracts.** There are some flavors that cannot be obtained in extract form except as artificial or synthetic products. Most fruit flavors belong to this class. These artificial flavors correspond very nearly to the genuine flavor which is in most cases due to a class of chemical bodies known as esters or ethers,<sup>1</sup> which are produced in the growth of the plant. These same substances may be obtained from other sources, such as the higher alcohols,

<sup>1</sup> "Year Book of U. S. Department of Agriculture, 1908."

and are used in the production of synthetic or artificial flavors. The synthetic flavors are usually colored with coal tar products and, according to the Federal and some State laws, must be labeled "Imitation" or "Artificial."

**The extract flavors.** Lemon, orange and vanilla are the most important of the extract flavors. There are some others, however, such as mint, wintergreen and certain nut



Fig. 26. Expressing lemon oil, Mascali, Sicily. (U. S. Department of Agriculture.)

flavors which are sometimes used in extract form. According to the standards adopted by the Department of Agriculture, a flavoring extract "is a solution, in ethyl alcohol of proper strength, of the sapid and odorous principles derived from an aromatic plant or parts of the plant, with or without its coloring matter, and conforms in name to the plant used in its preparation." This definition at

once excludes all preparations which are not solutions in alcohol and eliminates the various forms of prepared flavored sugars used abroad.

**Lemon and orange extracts** are used only to a very limited extent in the manufacture of ice creams, largely because the flavor is easily obtained from the fresh fruit. These extracts are made from the essential oil derived from the rind of the fruit.

**High grade extracts** are made by dissolving this oil in strong alcohol. The alcoholic solution is filtered and is then ready for use. The alcohol is the most costly constituent of such an extract because it requires a very strong alcohol to hold five per cent. of the oil in solution.

**Low grade extracts** are made by repeatedly shaking the oil with dilute alcohol. These extracts have the odor of the higher extracts but the flavor will cook or freeze out quite easily. Citronella and lemon grass citral are sometimes used to strengthen the flavor, and glycerin, sugar, and other substances are added to improve the body of these cheaper extracts.<sup>2</sup>

**Terpenless extract.** The cost of producing lemon or orange extract may be reduced considerably by producing *terpenless* extract. This is accomplished by making a solution of the oil in alcohol and then diluting the solution. The oil separates out and may be removed. Another method is to wash the lemon or orange oil with dilute alcohol. By either of these methods the citral, which is the principal flavoring substance of the oil, is removed, the terpenes remaining undissolved.

**Peppermint and wintergreen** are sometimes used either as the principal flavoring agent or to modify some other

<sup>2</sup> "Year Book of U. S. Department of Agriculture, 1908,"



Fig. -7. Interior of a lemon oil factory, near Messina, Sicily. (U. S. Department of Agriculture.)



flavor. These flavors are made from the essential oil which is obtained directly from the plant by distillation.

**The nut flavors** may be obtained in extract form. There is a limited demand for certain of these extracts in the manufacture of ice creams. The most important nut extracts are pistachio and almond.

**Almond extract** is useful in the manufacture of ice cream either as the principal flavor or to strengthen natural nut flavors and to blend with other flavoring substances. It is prepared by making a solution of oil of bitter almonds in strong alcohol. In order to comply with the food standards this extract must contain not less than one per cent. of the flavoring material. Seeds of apricots are the principal source of almond oil, although considerable quantities are obtained from almonds and peach kernels. The oils from these various sources are all very similar and are known as oil of bitter almonds. In preparing oil of bitter almonds the kernels are ground and pressed by hydraulic pressure to free them from the fatty oils which they contain. The residue is then reground, fermented and finally distilled with steam. The resulting product contains hydrocyanic acid, which is very poisonous and must be removed before the product can be used in the manufacture of extract. The distillate is treated with lime and copperas, which reagents remove the last traces of impurity. Artificial extracts are made from synthetic benzaldehyde, a coal tar product.<sup>3</sup>

Nut flavors are not obtained exclusively from extracts, however, the nuts themselves being used quite extensively in combination with some flavoring extract.

**Selecting and preparing nuts.** Considerable care must be exercised in selecting and preparing the nuts to be used

<sup>3</sup> "Year Book of U. S. Department of Agriculture, 1908,"

in ice cream making. Nothing but sound, non-rancid nuts should be used and in many cases these may require special treatment such as roasting or boiling, as in the case of chestnuts. Nut flavors may sometimes be obtained from some preparation containing the nut as in the case of peanut butter.

**Blanching.** Pistachios, almonds and filberts should have the dark outer skin removed before being used in ice cream. This is known as blanching. In blanching nuts, first throw the shelled nuts into boiling water and let them remain there until the outer skin is easily removed by rubbing them between the finger and thumb. The nuts will have to remain in the boiling water for about one minute before the skins can be easily removed. They should then be drained and thrown into cold water and the skins removed immediately.

**Vanilla** is without an exception the most popular flavor of all. This flavor is usually obtained in extract form, but a preparation of vanilla and sugar is sometimes used in certain cooked creams.

The source of the flavor is the bean or seed pod of a plant which is indigenous to southern Mexico where it was first used by the natives to flavor cocoa. The plant has since been introduced into other tropical countries where it is now cultivated quite extensively, but in no case does the transplanted bean develop the fine flavor of the Mexican bean.

**Cultivation.**<sup>4</sup> The flowers, which open in the night and close early in the day, are usually pollinated by hand. Originally natural pollenization by insects was depended upon entirely, but, owing to the irregularity of the crop, the

<sup>4</sup> "Year Book of U. S. Department of Agriculture, 1908,"

hand pollenization has practically superseded the old method. The operation is quite simple and is similar to the methods employed in plant breeding. A small amount of pollen is removed from the male blossoms and transferred to the female blossoms by means of a small splinter of wood. In

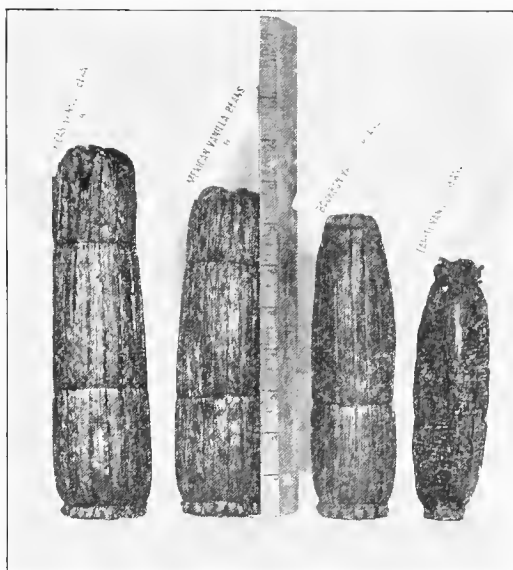

Fig. 28. Mexican, Bourbon, and Tahiti vanilla bean. (U. S. Department of Agriculture.)

this way the number of pods each vine is to mature is easily regulated according to the size and strength of the plant. It requires about six months from the flowering period for the pods to grow to that state of maturity in which they are in the best condition for curing.

**Curing.** The pods are not allowed to dry upon the vine as the flavor and aroma developed in this way is very inferior to the aroma and flavor developed in pods that have been picked at the proper stage and then cured. Considerable experience is required to determine the proper stage of maturity in the pods. If the pods are picked too green, the best flavor will not be developed in the curing process and the pods are more likely to mold when put into storage. On the other hand, an over-ripe pod is likely to split while curing and will therefore sell at a lower price.

**The aroma and flavor** are developed in the pods during the curing process, the pods having neither an agreeable odor nor flavor when first gathered. It is claimed by some that the aroma and flavor developed in curing is due to a change brought about simply by drying, while others claim that it is due to a fermentation which takes place in the bean. The exact nature of the change which brings out the flavor of the bean is not well understood, but there are numerous methods by which the desired results may be attained. The most common and simplest method is to allow the pods to lie in the sun for several hours until thoroughly heated. They are then wrapped in blankets and left until the following day. These operations of heating and storage are repeated for several days. Sometimes the pods are treated with a special preparation of vegetable oil to promote the sweating which takes place while the beans are wrapped in blankets. Various other devices, such as manipulation by hand or by subjecting to a scalding bath are resorted to, in order to develop the desired flavor. A more uniform article is produced by artificial drying which has in many places superseded the old sun drying method.

**Grading.** The cured pods are graded according to lengths

and all split or otherwise defective pods removed. The former are sold as "splits" and the latter after being trimmed are sold as "cuts," both of which bring a lower price than the whole bean. After the pods have been stored for a time they become covered with a white coating of vanillin crystals. Although the Mexican beans are gener-



Fig. 29. Bourbon Splits and Beans, showing frosting. (U. S. Dept. of Agriculture.)

ally conceded to be of very superior flavor, they contain a smaller amount of vanillin and frost to a much less extent than some of the other varieties. This would indicate that the fine aroma and flavor of the Mexican bean are due to compounds other than vanillin.

**Vanilla extract** is manufactured from the bean by soaking one part of finely cut vanilla beans in ten parts of an alcoholic solution made up of equal parts of ethyl alcohol and

water. After a few days the alcoholic solution, carrying the flavor which has been dissolved out of the beans, is poured off and is then ready for use. Some manufacturers, however, make it a practice to age the extract for months in large casks.

**Low grade extracts** are made from lower grade beans and less alcohol is used in their preparation. As a result the body and flavor of the extract is not so good. Small quantities of essential oils are sometimes added to improve the flavor, and glycerin or sugar is added to improve the body.

**Artificial vanilla** is made of various products, such as artificial vanillin, artificial cumarin and extract of tonka. Prune juice, caramel coloring, sugar, glycerin and other substances are employed to modify the flavor and give the desired body. The flavor of these extracts is very pronounced but lacks the fine qualities of the genuine product. Federal and some State laws require that such products be labeled "Artificial" or "Imitation."

## CHAPTER VII

### STANDARDIZING THE ICE CREAM MIXTURE

Standardizing is a means of altering the test of milk or cream by the addition of other milk, cream, or skim milk in such proportions that the mixture will contain a certain per cent. of butter fat.

Standardizing the cream to be used in the ice cream mixture is of considerable importance because in most places the pure food laws require a certain per cent. of fat in the ice cream. The per cent. of fat in the mixture must be varied according to the kind of ice cream to be made. It is only by accurate standardization that a uniform product can be secured from day to day.

**The butter fat standard.** The amount of butter fat ice cream must contain in order to comply with the pure food standards is not the same in all States. The United States Pure Food Law defines ice cream as "a frozen product made from cream and sugar, with or without a natural flavoring, and containing not less than 14 per cent. of milk fat." "Fruit ice cream is a frozen product made from cream, sugar and sound, clean, mature fruits, and containing not less than 12 per cent. of milk fat." "Nut ice cream is a product made from cream, sugar and sound, non-rancid nuts, and containing not less than 12 per cent. of milk fat." Some States have no fat standard at all and in other States the standard is as high as 14 per cent. Where these high standards are in effect, standardization is especially impor-

tant. The high standards admit of but very little variation in the various formulas for ice cream, but where special and fancy ice cream is to be made the richness of the cream will, in many instances, have to be varied to produce the desired results. It is only by careful standardization of the mixture that uniform results can be obtained.

**The standardizing of milk and cream** should be based upon actual tests. The practice of mixing milk and cream in certain proportions without any regard to the test of either, will not produce a uniform grade of ice cream. Uniformity is of great importance in securing and holding trade and in preventing leaks and losses.

**There are several methods of standardizing** which are very satisfactory. To find the proportions of milk and cream to use either of the following methods may be employed.

Draw a rectangle with two diagonals. At the upper left hand corner place the test of the cream to be standardized. At the lower left hand corner place the test of the milk to be used in standardizing. In the center of the rectangle place the desired test. At the right hand corners place the differences between the numbers at the left hand corner and the number in the center. The number at the upper right hand corner represents the number of pounds of cream of the richness indicated by the number at the upper left hand corner. The number at the lower right hand corner indicates the number of pounds of milk of the richness indicated by the number at the lower left hand corner. By mixing milk and cream in these proportions the desired test will be obtained. For example, if 35 per cent. cream is to be standardized to 20 per cent. using 4 per cent. milk proceed as follows:



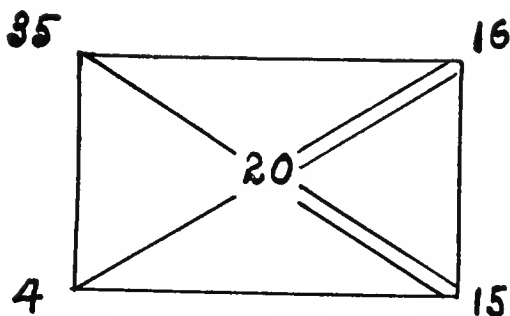

Sixteen, which is the difference between 4 and 20, represents the pounds of 35 per cent. cream that must be mixed with 15 pounds of 4 per cent. milk to make 31 pounds of 20 per cent. cream. When the proportions of milk and cream have been found any amount of 35 per cent. cream may be standardized to 20 per cent. by mixing with 4 per cent. milk in the proportions of  $16/31$  of cream to  $15/31$  of milk.

If skim milk is used instead of whole milk the figures would be:

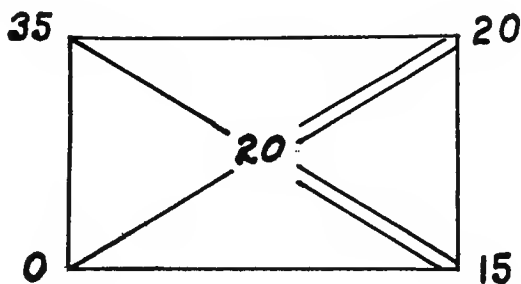

In this case a mixture composed of 20/35 cream and 15/35 skim milk will test 20 per cent.

Another method of standardizing that is quite simple and accurate and involves but little figuring is as follows: Multiply the amount of cream by the difference between its test and the required test, and divide the product by the difference between the required test and the test of the milk to be added. Example: Standardize 120 pounds of 30 per cent. cream to 20 per cent., using 4.2 per cent. milk.  $30 - 20 = 10$ , which is the difference between the test of the cream and the required test.  $20 - 4.2 = 15.8$ , which is the difference between the required test and the test of the milk to be added. Using these figures we have  $120 \times 10 \div 15.8$  or  $\frac{120 \times 10}{15.8} = 75.95$ . Therefore, 75.95 pounds of 4.2 per cent. milk are required to reduce the test of 120 pounds of 30 per cent. cream to 20 per cent. The accuracy of this method is shown by the following figures:

75.95 lbs. 4.2% milk contain	3.1899 lbs. fat
120. lbs. 30% cream contain	36. lbs. fat
Total 195.95 lbs.	Total 39.1899 lbs.

Therefore 195.95 lbs. 20% cream contain 39.19 lbs. fat.

Either of these methods will be found valuable as aids in regulating the quality of the ice cream produced.

**Standardizing the ice cream mixture.** It is also very important that the ice cream maker should know how to calculate the per cent. of butter fat a given mixture will contain. In addition to that it is necessary to know the amount of butter fat in the mixture in order to find the cost of a gallon of ice cream. In making these calculations it must be remembered that the sugar, flavoring, gelatin and other in-

Ingredients reduce the test just the same as skim milk would. The following example will make this clear.

20 lbs. 17% cream
4 lbs. sugar
2 oz. flavoring
2 oz. gelatin
24¼ lbs. of mixture

The 20 pounds of 17 per cent. cream contain 3.4 pounds of butter fat, which represents the total fat content of the ice cream mixture. To determine the per cent. of fat in the mixture, divide the pounds of butter fat by the total weight of the mixture and point off two places for per cent.

$$3.4 \div 24.25 = 14.02\% \text{ butter fat.}$$

In the following mixture the cream is not the only source of fat; but the method of procedure is the same.

12 lbs. 24% cream
4 lbs. condensed milk testing 8% fat
4 lbs. whole milk testing 4% fat
4 lbs. sugar
2 oz. flavor
24 lbs. 2 oz. of mixture

12 lbs. 24% cream contain	2.88 lbs. fat
4 lbs. 8% condensed milk contain	.32 lbs. fat
4 lbs. 4% milk contain	.16 lbs. fat
	3.36 lbs. fat in the mixture

$$3.36 \div 24.125 = 13.93\% \text{ of fat in the mixture.}$$

To find how rich cream must be used to give a mixture of a certain test, multiply the pounds of ice cream mixture by the desired test of the mixture, divide the product by the weight of the cream to be used, and point off two places for per cent.

Example: What per cent. of butter fat must the cream contain to give a mixture testing 9 per cent.?

Calculating on the basis of a mixture for ten gallons of ice cream we would need 44 pounds of cream, eight pounds of sugar, four ounces of flavor and four ounces of gelatin, giving a total weight of  $52\frac{1}{2}$  pounds.

$$52.5 \times .09 = 4.725 \text{ lbs. of fat.}$$

Since none of the ingredients except the cream contain butter fat, the entire 4.725 pounds will be contained in 44 pounds of cream; therefore,  $4.725 \div 44 = 10.74\%$ , which represents the per cent. of butter fat which the cream must contain. The accuracy with which the work is carried out should be checked up from time to time by testing the mixture for fat.

**Testing for fat in ice cream** by the Babcock method presents some difficulties owing to the presence of the sugar. A fair test may be obtained by following the same directions as for cream, except that a little less acid should be used and it must be added a little at a time. Even with the utmost care there is usually a larger or smaller amount of black material below or distributed through the fat which makes an accurate reading very difficult.

**The use of special acids.** By using a mixture of equal parts of glacial acetic and hydrochloric acids instead of sulphuric acid, there is less danger of charring the sugar. In making the test mix the sample of ice cream thoroughly

and weigh nine grams of the sample into a cream test bottle. Fill the bottle almost to the neck with the acid mixture and shake it until the ice cream and acid are well mixed. Place the bottles in hot water until the mixture turns black. The bottles are then whirled in the Babcock centrifuge and the test completed as for cream.

NOTE: For complete standardizing tables see Appendix.

## CHAPTER VIII

### PREPARING THE ICE CREAM MIXTURE

The method of procedure in preparing the ice cream mixture will vary more or less with the different kinds and flavors of ice cream. The ice cream maker should therefore have a clearly defined idea as to the results desired and then select and put together such ingredients as will give these results. The various ingredients should be weighed or measured very exactly, as it is only in this way that uniform results can be obtained.

**Selecting the cream** is one of the first considerations. In order to make a high grade ice cream, it is very important that the cream and milk used be of good quality. This implies a freedom from foreign odors and flavors, a sufficiently high per cent. of fat, and an acidity of not over 0.25 per cent. The objections to foreign odors have already been mentioned.<sup>1</sup> It has been pointed out that there is but one way to look at such defects, and that is to consider them very objectionable.

**The acidity of the cream**, however, is not always such a serious defect. In fact, if the fermentation taking place in the cream is purely of an acid nature and has developed to a point where it is just noticeable to the taste, the excess acid can be neutralized by the addition of viscogen or sodium hydroxide, and an equal amount of fresh sweet cream

<sup>1</sup> See page 2.

added. The mixture can then be used in making ice cream of fair quality. This practice, although sometimes followed, is not to be recommended, because of the fact that a partly soured cream contains enormous numbers of lactic acid bacteria. It is mentioned here to show that a slight acidity is less objectionable than other taints and defects in the cream.<sup>2</sup>

**The richness of the cream** is such a variable factor that it can be discussed here only in very general terms. In the first place, there are pure food laws in most States which regulate the amount of butter fat which the ice cream must contain; consequently, the fat content of the cream must be sufficiently high so that when sugar, flavoring, and other ingredients have been added, the mixture will contain sufficient butter fat to satisfy the pure food authorities.

Since butter fat is one of the most expensive constituents of the ice cream, the price for which the product must sell should be carefully considered. The keen business man, however, will take the popular demand as the safest criterion upon which to base the amount of butter fat to put into the ice cream mixture.

**The sugar** is also a variable constituent. The popular demand is the only guide as to the amount of sugar which the mixture should contain. Under average conditions it will require about 15 or 16 per cent. of sugar to sweeten an ice cream mixture which does not contain eggs, and somewhat more for sherbets and for ice creams containing eggs.

**The kind of sugar** used in ordinary ice creams and sherbets may be either granulated beet or granulated cane sugar. In some formulas, however, better results are obtained by

<sup>2</sup> Bulletin 136, Maryland station. (See page 268.)

using some pulverized sugar. This kind of sugar is also preferable for making meringue; i. e., the sweetened white of eggs beaten to a froth.

**Preparation of the sugar.** In most cases the sugar will need little or no preparation before being used. Care

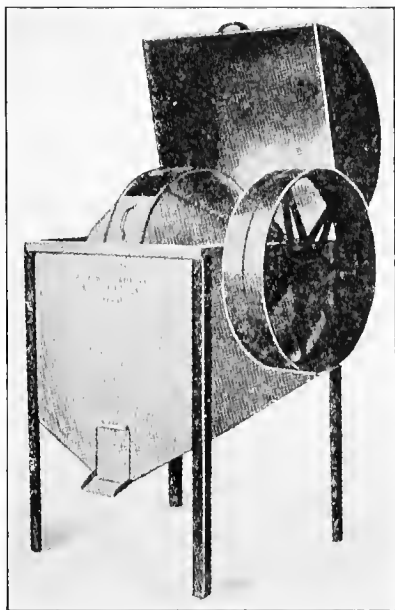

Fig. 30. The Daly Sugar and Powder Mixer.

must always be taken, however, to see that all of the sugar is dissolved before the mixture is run into the freezer. If ice cream powders are used, they should first be uniformly mixed with the sugar. For sherbets and ices, however, it is best to boil the sugar in a part of the water to form a simple syrup.

**The flavoring material**, if it be an extract, can be added at any time if the mixture is not to be cooked, but if fruits or fruit juices are to be used for flavoring, special precautions must be observed in adding them.

**Fruits and fruit juices** which are very sour must not be added to the ice cream or to the milk sherbet mixture until it is partly frozen. This precaution is necessary to prevent the acid in the fruit from curdling the milk or cream and



also to prevent the heavy fruit from settling to the bottom of the freezer. Ice cream containing fruit is usually colored with some appropriate color, care being taken not to add too much of the coloring matter.

**The stabilizers** must be weighed out carefully. It must not be supposed that the more used the better the results. Too much stabilizer gives a heavy, pasty body which is very objectionable. It must also be remembered that when such substances as condensed milk, milk powder, or homogenized cream are used in the ice cream mixture, these substances themselves serve as stabilizers to a certain extent. Under such circumstances little or no other stabilizer need be added. In ice cream containing eggs such substances as starch, gums, gelatins or powders are rarely used, because the eggs in the mixture act as a stabilizer. When properly cooked, these mixtures are usually sufficiently heavy so that they do not require any other substance to give body to the product.

**The cooked mixtures** differ from the ordinary or plain mixture, chiefly in that they contain eggs and therefore have a distinct custard flavor and a heavier body than ordinary ice cream. These mixtures require more sugar than do the plain mixtures, because of the eggs they contain, the amount of sugar varying from 15 to 22 per cent.

**In preparing the eggs and sugar** for these mixtures, beat the whites to a froth and the yolks to a cream. Add the sugar to the yolks and mix thoroughly. This mixture and the whites are then added to the cream and cooked.

**The cooking** should be done very carefully, and must be carried to a point where the raw egg flavor is no longer apparent. This will require a temperature of 175° F. to 180° F. for 10 or 15 minutes. One way to tell when the

mixture is cooked sufficiently is by dipping a knife into it. When the mixture is thick enough to coat the knife blade, it has been cooked sufficiently. The mixture must not be cooked too long nor at too high temperature. If the cooking is not properly done the mixture will curdle, owing to the action of heat upon the egg albumen. The cooking process is not difficult and if the necessary utensils are available is easily accomplished.

**The flavoring**, however, sometimes causes difficulty because many flavoring substances are very volatile. If such flavoring material is added to the mix while it is hot, the flavor will be driven off or very much modified by the heat. Some flavors, on the other hand, should be added to the mixture while it is quite hot. Vanilla sugar may be taken as an example of this class of flavoring substance.

From the foregoing discussion it will be noticed that the difference between the two classes of ice cream which have been considered is that one contains eggs and the other does not. The same holds true of ices and sherbets; consequently, these products are also separated into two classes on account of this difference in composition.

**Ices and sherbets** differ from ice creams in that they do not, as a rule, contain milk or cream. They differ from each other in that the ices do not contain egg albumen or any other form of stabilizer, while the sherbets contain the beaten whites of eggs and sometimes some other substances such as gelatin. As a result of this difference in composition, sherbets usually have a better body and a somewhat less granular texture.

**The amount of sugar required** for ices and sherbets is somewhat greater than for ice cream, because these products always contain fruit juices and therefore require more

sweetening. The amount needed varies from 25 to 30 per cent.

**The flavoring** used in ices and sherbets consists of fruit or fruit juices. In fact, these are the only satisfactory flavors that may be used in such mixtures. Where the mixture does not contain milk, all of the ingredients may be mixed at once and placed in the freezer together, but better results will be obtained by cooking the mixture before freezing.

**The objects in cooking** a mixture for sherbets or ices are to get a better blended flavor, better body and texture, and a more complete solution of the sugar. Where it is desirable to make a sherbet with a granular body, such as the granites, the cooking should either be omitted entirely or limited to cooking the sugar in a small part of the water to form a simple syrup. In all sherbets and ices, whether cooked or not, the mixture should be standardized by means of a syrup gauge.

**The syrup gauge** is an instrument for testing the density of syrups. More uniform and satisfactory results are obtained by standardizing all ice and sherbet mixtures by means of this gauge. On the average, the proper concentration is about 22 degrees on the syrup gauge with the temperature at 60° F., but in some cases a lower degree of concentration may be found more satisfactory,

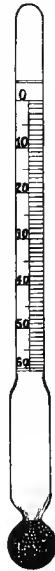

Fig. 31. A  
Syrup  
Gauge.

## CHAPTER IX

### CLASSIFICATION OF ICE CREAM

There is as yet no universally accepted classification of ice cream, ices, and sherbets, although several have been suggested and will be given here for comparison.

**The United States pure food law** defines and classifies ice cream as follows:

1. **Ice cream** is a frozen product made from cream and sugar, with or without a natural flavoring, and contains not less than 14 per cent. of milk fat.

2. **Fruit ice cream** is a frozen product made from cream, sugar, and sound, clean, mature fruits, and contains not less than 12 per cent. of milk fat.

3. **Nut ice cream** is a frozen product made from cream, sugar and sound, non-rancid nuts, and contains not less than 12 per cent. of milk fat.

This system of classification has been enlarged upon by Professor Mortensen and a classification has been worked out to cover all kinds of ice creams and ices.

**Mortensen's classification** as given in Bulletin 123 of the Iowa station, published May, 1911, divides ice creams and ices into ten classes as follows:

“**I. Plain ice cream** is a frozen product made from cream and sugar, with or without a natural flavoring.

“**II. Nut ice cream** is a frozen product made from cream and sugar and sound, non-rancid nuts.

“**III. Fruit ice cream** is a frozen product made from cream, sugar, and sound, clean, mature fruits.

“**IV. Bisque ice cream** is a frozen product made from cream, sugar and bread products, marshmallows or other confections, with or without other natural flavoring.

“**V. Parfait** is a frozen product made from cream, sugar and egg yolks, with or without nuts, fruits and other flavoring.

“**VI. Mousse** is a frozen whipped cream to which sugar and natural flavoring have been added.

“**VII. Pudding** is a product made from cream or milk, with sugar, eggs, nuts and fruits, highly flavored.

“**VIII. Aufait** is a brick cream consisting of layers of one or more kinds of cream, with solid layers of frozen fruits.

“**IX. Lacto** is a product manufactured from skimmed or whole sour milk, eggs and sugar, with or without natural flavoring.

“**X. Ices** are frozen products made from water or sweet skimmed or whole milk and sugar, with or without eggs, fruit juices or other natural flavoring.

“Ices may for convenience be divided into sherbets, milk sherbets, frappés, punches and soufflés.

“**1. A sherbet** is an ice made from water, sugar, egg albumen and natural flavoring, and frozen to the consistency of ice cream.

“**2. Milk sherbert** is an ice made from sweet skimmed or whole milk, with egg albumen, sugar and natural flavoring, frozen to the consistency of ice cream.

“**3. Frappé** is an ice consisting of water, sugar and natural flavoring and frozen to a soft, semi-frozen consist-

ency. The same formulas as are given for sherbets will answer for frappé by omitting the egg albumen.

“4. **Punch** is a sherbet flavored with liquors or highly flavored with fruit juices and spice.

“5. **Soufflé** is an ice made from water, eggs, sugar and flavoring material. It differs from sherbets mainly in that it contains the whole egg.”

It will be noticed that Mortensen's classification is on the same plan as the pure food classification of ice cream but is more complete. Since the pure food law recognizes the first three classes of ice cream, there may be some advantages in this system of classification. But in classifying according to flavors the whole system tends to become very complicated. The present need is for a simpler system of classification. The system may be simplified by classifying according to certain fundamental differences in composition and method of manufacture rather than the kind of flavoring material used.

This difference in composition is recognized by Washburn in Bulletin 155 of the Vermont station. Although a full classification is not attempted, his comment on the different kinds of ice cream is quoted here because he views the subject from a different angle.

**Washburn's classification** is as follows:

“1. **Plain ice cream**, frequently known as Philadelphia and, occasionally, as the New York ice cream; a plain and *raw article, rarely or never containing eggs*, being composed simply of cream of variable butter fat content, sugar in uniform quantities, and almost always containing gelatin or some other gelatinoid binder (stabilizer).

“2. **The French or Neapolitan ice cream**, which contains eggs in addition to the cream and sugar, is virtually

a frozen custard and as such admitting of great variation.”

Washburn's classification is obviously simpler and more logical because it recognizes a real and fundamental difference in the composition and method of manufacture. A classification worked out by Larsen and White,<sup>1</sup> following this same idea, is given below with some modification in wording, but essentially the same as given by them.

**Larsen and White's classification** of ice cream and ices:

“**I. Philadelphia ice cream** is an ice cream made from cream, sugar and flavoring, and usually contains a binder (stabilizer). This class includes not only plain ice cream and chocolate, coffee and macaroon flavors, but nut and fruit ice cream as well.

“**II. Neapolitan ice cream** is an ice cream made from cream, sugar, flavoring, and eggs. This kind of ice cream may resemble a frozen pudding in composition and consistency.

“**III. Fancy ice cream** differs from the Philadelphia ice cream chiefly in the manner of molding, printing and coloring.

“**1. Brick ice cream** is usually made up in pint, quart and two quart sizes, and in two or more layers. Any of the ice creams may be used for this purpose.

“**2. Individual molds** are shaped to imitate some object (fruit or animal) and may be colored in imitation of the object it represents.

“**IV. Ices** are made from fruit juices diluted, sweetened and frozen.

“**1. Water ices** are made from fruit juices diluted to the proper degree, sweetened and frozen the same as ice cream, but are more or less grainy in texture.

<sup>1</sup>“Milk Technology.”

“**2. Sherbets** are composed of fruit juices, water, sugar, white of eggs and sometimes a binder (stabilizer). They sometimes resemble ice cream in appearance, body and texture.

“**3. Sorbet** is a name sometimes applied to sherbets of fine, smooth texture.

“**4. Granites** are water ices only half frozen without much stirring.

“**5. Frozen punches** are made by adding one or more liquors or cordials like champagne, maraschino or Jamaica rum to a water ice or sherbet, usually after the freezing is nearly or entirely completed.”

Aside from its other advantages such a system of classification makes it easier for the beginner to form a general idea of the nature and composition of the different kinds of ice creams and ices, because they are confined to a few groups. The ice creams and ices of any one group being similar in composition, it is easier to remember certain formulas or to look up any formula wanted by referring to a certain class.

Since the classification just given very nearly meets our present needs, it will be followed in this work with only such modification as may be necessary to make it uniform throughout. This modification will consist of the addition of one more class and the rearrangement of the classification of ices and sherbets.

**Mousse** is the name of the class to be added. The reason for adding this product is because of its difference in composition and method of manufacture.

**The difference between ices and sherbets** is that the former do not contain egg albumen or a stabilizer but the latter do. In addition to this the sherbets are sometimes



made with sweet or sour milk instead of water. In order that the system of classification may be uniform throughout, a slight alteration is suggested for the classification of ices and sherbets. With these alterations included the system of classification adopted by the dairy department of the University of Nebraska is as follows:

**Suggested classification** of ice creams and ices.

“**I. Philadelphia ice cream** is ice cream made from cream, sugar and flavoring, with or without a stabilizer.

“**II. Neapolitan ice cream** is ice cream made from cream, sugar, flavoring and eggs. These may resemble frozen custards or pudding in flavor, composition and consistency.

“**III. Fancy molded ice cream** differs from the above classes chiefly in the method of molding, printing and coloring. For convenience the class may be subdivided as follows:

“**1. Brick ice cream** is molded in brick molds of pint, quart or two quart sizes and usually consists of two or more layers of different flavors and colors.

“**2. Individual pieces** are molded in the form of some object, such as fruits or animals, and are usually colored to imitate the objects which they represent.

“**IV. Mousse** is a rich cream, sweetened, flavored, whipped to a stiff froth and frozen, usually in a mold but sometimes in an ordinary ice cream can.

“**V. Water ices** are fruit juices diluted with water, sweetened and frozen without a stabilizer of any sort. In this class may be included *granites*, which are water ices frozen with but little agitation; *frappé*, a partly frozen ice having a slushy consistency.

“**VI. Sherbet** is a frozen product made of fruit juices,

water or milk, sugar and eggs. It sometimes contains gelatin or some other stabilizer. Sherbets may be subdivided as follows:

“**1. Plain sherbets** made from fruit juices, water, sugar and eggs, with or without a stabilizer. When the whole egg is used, these sherbets are sometimes called *soufflés*.

When liquor or spice is added to a sherbet it is known as *punch*.

“**2. Milk sherbets** made from fruit juices, milk, sugar and eggs, with or without a stabilizer. The milk used may be either whole or skimmed.

“**3. Lactos** are milk sherbets made from sour milk or buttermilk instead of sweet milk but otherwise resembling the milk sherbets.”

In the next chapter will be given ice cream formulas that may be taken as representative of these different classes. By keeping the above system of nomenclature in mind it will be easier by association to remember the more important formulas or to find the others by referring to the proper group in the book.

## CHAPTER X

### ICE CREAM FORMULAS

#### Philadelphia Ice Cream

The following formula may be taken as a basis for all ice creams of this class. In this, as in most of the other formulas given here, the quantities specified will make approximately ten gallons of ice cream, if properly frozen.

#### Vanilla Ice Cream

40 lbs. 17% cream  
8 lbs. sugar  
4 oz. vanilla extract  
4 oz. gelatin (if desired)

This mixture tests 14% and if properly frozen will give an ice cream of good body and texture. The above formula may be used with such flavors as chocolate, caramel, nuts and fruits or fruit juices.

**Bisque ice cream.** This is a Philadelphia ice cream to which finely chopped bread products, marshmallows or some similar substance has been added. It will be necessary to use a richer cream if the mixture is to test 14 per cent. The formula would then be as follows:

40 lbs. 19% cream  
8 lbs. sugar  
4 oz. vanilla extract  
4 oz. gelatin (if desired)  
5 lbs. of some bread product or confection

This formula admits of quite a wide variety of flavors. The bread products used may be macaroons, crumbs of lady finger cake, sponge cake, Nabisco wafers or similar cakes. By adding about four ounces of vanilla sugar instead of the extract, and scalding the cream, a very mild but rich and pleasing flavor will be obtained.

**Blended flavors.** It is sometimes desirable to add one or more secondary flavors to modify the principal flavoring agent in order to obtain the best results.

**Chocolate ice cream.** The process of blending flavors is well illustrated in the following formula for chocolate ice cream, in which vanilla or cinnamon may be used to bring out a more pleasing chocolate flavor.

40 lbs. 18% cream  
8 lbs. sugar  
1½ lbs. bitter chocolate<sup>1</sup>  
2 oz. vanilla extract or 1½ oz. cinnamon  
4 oz. gelatin (if desired)

This gives an excellent chocolate flavor and should meet with favor wherever quality is appreciated. If the cinnamon is used instead of the vanilla, it should be prepared as follows: Pour a half pint of boiling water over the cinnamon, cover, and let it stand for half an hour in a warm place. Strain off the clear, hot liquid and work it into the chocolate to form a smooth paste. Scald the cream and work the chocolate paste in while hot. Strain and cool to a very low temperature and let it stand for several hours before freezing.

<sup>1</sup> A quart of chocolate syrup or a mixture of equal parts of bitter chocolate and cocoa may be used instead of the bitter chocolate. See page 66.

**Prepared chocolate flavor** may be obtained from manufacturers of ice cream flavors, in the form of a paste or as a syrup which can be worked into the cream while cold, thus avoiding the necessity of scalding the cream in order to incorporate the flavor.

**Cocoa.** A cheaper and fairly satisfactory chocolate flavor may be produced by using cocoa and caramel syrup. For ten gallons of ice cream take a half pound of good cocoa and four ounces of caramel syrup. Mix the cocoa with the sugar and add the caramel syrup and about a quart of simple syrup. Mix all together and bring to a boil. Strain and cool the mixture before adding it to the cream.

**Caramel ice cream** is flavored with caramel syrup blended with vanilla. The color of this ice cream should be a very light brown and sufficient caramel syrup should be added to give the desired result. For ten gallons of ice cream it will require approximately 12 ounces of syrup and three ounces of vanilla extract. The caramel flavor blends nicely with various other flavors and is also used for coloring ice creams which require a light brown color, such as maple ice cream.

**Maple ice cream** may be made by using maple extract and enough caramel syrup to give the desired color, but this ice cream lacks the fine quality of the ice cream flavored with maple sugar or maple syrup. The best quality of maple is made by substituting two pounds of maple sugar or a quart of maple syrup for two pounds of the granulated sugar. Two ounces of vanilla and two or three ounces of caramel should also be used to bring out the flavor and a light brown color.

All of the formulas given above are calculated on the basis of 14 per cent. fat, because the pure food law in

many places calls for that amount of fat. There are some places, however, where it is permissible to manufacture ice cream containing less than 14 per cent. fat. Where it is desired to make such ice cream, the following formula may be used as a basis for ice creams of the Philadelphia class.

**A mix containing condensed milk.** An ice cream of excellent flavor, having a good body and a very smooth texture, may be made by using condensed milk and some whole milk in the mixture. The cream, condensed milk, and whole milk are mixed in the proportion of six parts cream, five parts bulk condensed milk and four parts whole milk. On this basis a mixture for ten gallons may be prepared as follows:

16 lbs. 20% cream  
14 lbs. condensed milk (8 to 10% fat)  
11 lbs. 4% milk  
8 lbs. sugar  
4 oz. vanilla extract  
4 oz. gelatin

This mixture will test 9.5 per cent. to 10 per cent. butter fat. Owing to the presence of the condensed milk, which is rich in solids not fat, this ice cream has considerable food value, and theoretically at least, would have a more cooling effect because of the lower fat content.

**Nut ice cream** may be made from any of the formulas given above with very little alteration. The nuts must be prepared carefully to obtain the best results. Nuts, such as Brazils, which are very oily, should not be used. In all cases it is well to add a little salt to the nut ice creams. A half teaspoonful of salt to a gallon of mix is sufficient.

Certain kinds of nuts must be blanched by dropping them first into boiling water and then into cold water, after which the dark outer skin of the nut is easily removed.

### Walnut Ice Cream

- 40 lbs. 18% cream
- 8 lbs. sugar
- 2 oz. vanilla extract
- 4 lbs. walnut meats
- 4 oz. gelatin (if desired)

**Preparing the nuts.** Use only sound, non-rancid nuts. They should be run through a meat mincing machine and added to the ice cream when it is partly frozen. If the ice cream is not partly frozen the nuts will settle to the bottom of the freezer and will not be evenly distributed through the mixture.

An equal amount of any other nuts may be substituted for the walnut meats, but if filberts, hazelnuts, almonds or pistachio nuts are used they should first be blanched. (See page 74.)

### Pistachio Ice Cream

- 40 lbs. 18% cream
- 8 lbs. sugar
- 3 lbs. pistachio nuts
- 4 oz. gelatin
- 1 oz. almond extract

Color the mixture a pale green.

**Almond and pistachio** flavored ice creams may be made without the use of nuts by adding the required amount of

almond or pistachio extract, but to make the best quality of ice cream, nuts should be added. A small amount of the extract may be added to the ice cream, however, to strengthen the flavor. The almond ice cream is white. The color of pistachio is a very light green.

**Fruit ice cream.** The following formula, which is a good example of fruit ice cream, will serve as a guide to the preparation of all Philadelphia ice creams containing fruit.

### Strawberry Ice Cream

- 40 lbs. 18% cream
- 8 lbs. sugar
- 4 qts. crushed berries
- 4 oz. true strawberry extract
- 4 oz. gelatin (if desired)

Select sound, mature fruit of a deep red color. Clean, add part of the sugar to the berries and mash thoroughly. Mix the other ingredients, and when partly frozen add the crushed fruit and complete the freezing.

Pineapple, peach, apricot, cranberry, etc., may be used instead of strawberry, adding sugar as needed.

**Use of preserved fruit.** During that season of the year when fresh fruit cannot be obtained, preserved fruit may be used, but the flavor should be strengthened by the addition of flavoring extracts, and the acidity increased by adding the juice of two lemons to each gallon of fruit used. Care must be exercised in preparing the lemon juice not to get any of the oil from the rind into the juice. To avoid this, peel the lemons carefully, removing all of the white inner portion of the rind before pressing out the juice. The reason for this precaution is that a very little of the lemon



oil in the juice will impart a lemon flavor. Even a small amount of the white, inner rind is likely to give the juice a bitter flavor. The lemon juice is used, not to impart a lemon flavor, but to increase the amount of fruit acid in the preserved fruit. Ice cream made in this way closely resembles that made from the fresh fruit.

**Lemon and orange** ice cream may be made by flavoring with the extract only, but the finest ice cream of these flavors should be made from the fruit without any extract at all.

**For lemon ice cream** grate the rinds from a few of the lemons, add a little of the sugar, and mix together thoroughly so that the sugar will absorb the oil from the rind. Only the very outer part of the rind should be used. Squeeze enough lemons to give the desired amount of juice, dissolve the sugar in it, and strain before using. Orange juice is sweeter and milder in flavor and blends nicely with the lemon so that a more pleasing flavor is obtained if a small quantity of orange juice is used to modify the sharp lemon flavor. The oranges should be peeled before being pressed. The other ingredients are mixed in the proportions given in the following formula for five gallons of ice cream.

20 lbs. 18% cream  
5 lbs. sugar  
1 pt. lemon juice  
½ pt. orange juice  
2 oz. gelatin (if desired)

**Orange ice cream** may be made by following the same formula, but the sugar should be reduced to four pounds. Use one quart of orange juice and about four ounces of lemon juice. Peel the *lemons* carefully before squeezing, but grate the *orange* peel and mix it with a part of the sugar;

add the juice, mix thoroughly, and strain. Mix the rest of the sugar with the cream and when it is partly frozen add the fruit juices and complete the freezing as for any other ice cream. The amount of fruit juices may be reduced somewhat by strengthening the flavor with an extract. If made with fruit juices only, this ice cream should come under the head of fruit ice cream and need contain only 12 per cent. fat, but if flavored with an extract it must contain 14 per cent. fat.<sup>2</sup>

**Other Philadelphia ice creams** (for five gallons of ice cream).

#### **Banana**

20 lbs. 18% cream  
4½ lbs. sugar  
5 lbs. banana pulp  
Juice of 5 lemons  
2 oz. gelatin (if desired)

Cook the cream and half of the sugar and cool thoroughly before freezing. Mix the rest of the sugar with the banana pulp and lemon juice and add it to the cream when the mixture is partly frozen.

#### **Raspberry**

20 lbs. 18% cream  
5 lbs. sugar  
5 qts. raspberry juice  
2 oz. gelatin (if desired)

**First method.** Dissolve the gelatin in a little warm milk and stir it into the cream; add the sugar and freeze. When this mixture is partly frozen add the fruit juice. A better

<sup>2</sup> In States where fat standards are in effect. See Appendix.

texture may be obtained, however, by the method given below.

**Second method.** Cook half the sugar, the cream and the gelatin. Cool thoroughly and freeze this mixture. Press the juice out of the fruit, add the rest of the sugar, and cook to a clear syrup; strain, and when cooled beat it into the partly frozen cream. Either of these methods may be applied to the following mixtures.

### Cherry

20 lbs. 18% cream  
5 lbs. sugar  
5 qts. cherry juice  
2 oz. gelatin

If the cherries are very sweet, reduce the amount of sugar slightly. A little cherry extract may be added if necessary to strengthen the flavor.

### Apple

20 lbs. 18% cream  
5 lbs. sugar  
5 qts. apple juice  
2 oz. gelatin (if desired)

If the fruit juice used in the above formula is cooked, the gelatin may be omitted.

### Currant

20 lbs. 18% cream  
5 lbs. sugar  
4 qts. currant juice

1 qt. raspberry juice or orange juice  
2 oz. gelatin (if desired)

### Grape

20 lbs. 18% cream  
4 lbs. sugar  
3 qts. grape juice  
2 oz. gelatin (if desired)

### Rose

20 lbs. 18% cream  
4 lbs. sugar  
1 oz. extract of rose

Color pale pink, cook, cool and freeze.

**Peppermint and wintergreen** ice creams are flavored with the extract of peppermint or wintergreen. The peppermint ice cream is usually colored a very light green and wintergreen a very light pink.

**Coffee ice cream** may be made by adding three pints of very strong coffee to the mixture for ten gallons, and enough caramel syrup to give it a light brown color. Another method which gives better results when properly carried out is as follows. For 5 gallons:

20 lbs. 18% cream  
4 lbs. sugar  
½ lb. Mocha coffee  
2 oz. gelatin

Heat about half the cream and when it is very hot add the coarsely ground coffee. Cover the mixture and let it stand for 15 minutes. Then strain it; add the flavored cream

to the rest of the cream. Cool the mixture thoroughly before freezing it.

### Neapolitan Ice Cream

The following formula may be taken as a basis for all Neapolitan ice creams. For 10 gallons:

40 lbs. 20% cream  
8 lbs. sugar  
7 doz. eggs  
5 oz. vanilla

**Preparing and cooking the mix.** Beat the yolks of the eggs to a smooth cream, add the sugar and beat again. Beat the whites to a stiff froth and stir them into the yolks and sugar. Mix this with the cream and stir constantly while cooking. Cook for 15 to 20 minutes or until the mixture will just slightly coat a knife blade dipped into it, and does not run. It will require a temperature of 180° F. for about 15 to 20 minutes to accomplish this. If cooked too long, or at too high temperature, the mixture is likely to curdle. When the mixture is cooked, strain and cool it thoroughly before freezing.

**Kinds of flavors to use.** Such flavors as vanilla, coffee, chocolate, caramel and the various nut flavors are best adapted to the Neapolitan ice creams, as the fruit flavors do not harmonize so well with the eggs. If so desired, however, the fruit flavors may be used in Neapolitan ice creams. It will only be necessary to slightly increase the amount of fruit juice used in Philadelphia ice cream and then follow the instructions given above for Neapolitan ice cream.

**French cooked cream.** The following formula for French cooked cream is used in some factories as a basis for various

kinds of special ice creams, all of which would be classified as Neapolitan ice cream.

40 lbs. 20% cream  
7 doz. eggs  
12 lbs. sugar

(This mixture will test about 15½% to 16% fat.)

Beat the yolks to a cream, add the sugar, and beat a little to get a smooth texture. Whip the whites to a froth and mix with the yolks. Heat the cream, stir in the eggs and sugar, and cook as for Neapolitan cream; strain the mixture and cool it at once.

### **Tutti Frutti Ice Cream**

5 gal. French cooked cream  
8 oz. vanilla extract  
2 lbs. ground nuts  
2 lbs. cherries  
2 lbs. assorted candied fruit

Colored pineapple cubes are now used to a considerable extent commercially as a substitute for cherries.

### **Nesselrode Pudding**

4 gal. French cooked cream  
6 oz. vanilla  
2 lbs. candied cherries  
2 lbs. raisins  
½ lb. citron  
2 lbs. walnut meats  
2 lbs. blanched almonds  
2 lbs. filberts

Chop the fruit fine and boil in simple syrup until tender. Grind the nuts in a meat mincing machine and add all to the partly frozen cream.

**Manhattan Pudding**<sup>3</sup>

3 gals. 30% cream  
7 doz. eggs  
12 lbs. sugar  
2 qts. orange juice  
1 pt. lemon juice  
2 lbs. walnut meats  
2 lbs. pecan meats  
2 lbs. assorted fruits

**Plum Pudding**<sup>3</sup>

3 gals. 30% cream  
7 doz. eggs  
10 lbs. sugar  
1½ lbs. chocolate  
2 lbs. assorted fruits  
1 lb. raisins  
1 lb. figs  
1 lb. walnut meats  
2 tablespoonfuls of ground cinnamon  
½ teaspoonful ground cloves

**Frozen Custard**

(For five gallons)

20 lbs. 20% cream  
5 doz. eggs  
7½ lbs. sugar  
½ lb. vanilla sugar

<sup>3</sup> Bul. 123 Iowa station.

Put two-thirds of the cream into a double boiler over a quick fire. Beat the eggs and sugar to a smooth cream and add them to the hot cream; cook the mixture until it will coat a spoon. Take it from the fire, add the rest of the cream, and stir until cold. Strain and chill the mixture thoroughly before freezing it.

### Almond Pistachio Ice Cream

(For five gallons)

- 20 lbs. 18% cream
- 2½ doz. eggs
- 5 lbs. sugar
- 2 lbs. blanched almonds
- 1 oz. pistachio extract
- 3 oz. vanilla sugar

Prepare the eggs, sugar, vanilla sugar, and cream, and cook as for Neapolitan. (See page 109.)

### Burnt Almond Ice Cream

(For five gallons)

- 20 lbs. 18% cream
- 2½ doz. eggs
- 5 lbs. sugar
- 1 lb. almonds

Prepare the almonds according to either of the two following methods: Blanch the almonds. Place them on a baking tin and set into a quick oven to roast until they are a golden brown. Pound the roasted nuts in a mortar with an equal weight of sugar and enough cream to form a smooth paste. The other method is to put the blanched almonds with an equal weight of sugar into a porcelain



lined kettle or earthenware bowl, and set over a hot fire, stirring until the sugar is melted and coats the nuts all over. Pour them on a buttered dish to cool. When the nuts and sugar are cold and hard, grind in a mortar and sift through a wire sieve. Repeat the operation till the nuts are all finely powdered. Mix the paste or the powder with the cream before cooking the mixture.

### Butter Ice Cream

(For five gallons)

20 lbs. 18% cream

Yolks of 36 eggs

Whites of 6 eggs

1 grated lemon rind

6 lbs. sugar

1 lb. unsalted butter

$\frac{1}{2}$  lb. blanched almonds

Select fresh, unsalted butter. If this cannot be obtained, take freshly made butter of good flavor, washing it in very cold water to remove the salt. Pound the nuts with an equal amount of cream and sugar to a smooth paste, and mix with the butter. Grate the rind of the lemon and mix with a little sugar; dissolve this in a part of the cream and strain it into the rest of the cream; add the sugar and eggs, cook and cool the mixture as directed. When the mixture is nearly cold pour it in a fine stream into the butter and stir well until a smooth, well-blended mixture is obtained. If the cream is more than luke warm it will melt the butter, making it impossible to get a good mixture. Color it pale yellow.

**Chestnut Ice Cream**

(For five gallons)

- 20 lbs. 18% cream
- 2½ doz. eggs
- 5 lbs. sugar
- 1 lb. chestnut pulp
- 3 oz. vanilla sugar
- 2 oz. gelatin (if desired)

Peel and boil enough chestnuts to yield one pound of pulp. Grind them in a mortar with enough sugar and cream to make a smooth paste. Cook the mixture as directed.

**Coffee Ice Cream**

(For five gallons)

- 20 lbs. 18% cream
- 2½ doz. eggs
- 5 lbs. sugar
- 1 lb. Mocha coffee
- 2 oz. gelatin (if desired)

Grind the coffee very fine and cook for ten minutes with half the cream; strain and add to the other half of the cream. Prepare the eggs and sugar, add to the cream, and cook as directed.

**Filbert Ice Cream**

(For five gallons)

- 20 lbs. 20% cream
- 2½ doz. eggs
- 5 lbs. sugar
- 2 lbs. shelled filberts

3 oz. vanilla sugar  
2 oz. gelatin (if desired)

Blanch the nuts and roast to a rich brown color. Grind the nuts in a mortar with a little sugar and cream to form a smooth paste. Color it a light buff.

### Royal Ice Cream

(For five gallons)

20 lbs. 20% cream  
5 lbs. sugar  
60 egg yolks  
12 egg whites  
2 lbs. dry crumbs of Lady Finger cake  
 $\frac{1}{2}$  lb. vanilla sugar  
2 oz. gelatin (if desired)

Place the yolks in a bowl on ice and beat to a cream; add all but one pound of the sugar and beat them again vigorously. Grind the remaining sugar to a fine powder and sift it. Beat the whites to a froth, add the powdered sugar and whip until stiff and smooth. Pound the cake very fine, and sift. Cook the cream, sugar, yolks and vanilla sugar, and strain into the freezing can. When thoroughly chilled, add the sifted cake, and freeze. Open the can and beat in the egg whites, working the batch until smooth.

**Hokey Pokey** is a frozen product made from milk, cream, condensed milk, gelatin, sugar and flavoring. Two formulas are given here to show the general characteristics of "hokey pokey," "frozen dainties" and allied products.

**Hokey Pokey I**

(For about eight gallons)

- 40 lbs. 4% milk
- 2 doz. eggs
- $\frac{1}{2}$  lb. corn starch
- 1 gal. condensed milk
- 6 oz. gelatin
- 9 lbs. sugar
- 6 oz. vanilla extract

Boil the corn starch and add it to the mixture of milk and condensed milk. Beat the eggs to a cream and add them to the milk. Cook the mix until it will coat a spoon. Strain and cool the mixture and freeze it at once.

**Hokey Pokey II**

(For about eight gallons)

- $3\frac{1}{2}$  gal. 4% milk
- $1\frac{1}{2}$  gal. 20% cream
- 2 lbs. milk powder
- 8 lbs. sugar
- 6 oz. gelatin
- 6 oz. vanilla extract

Mix the milk powder with the sugar and dissolve it in the milk. Add the melted gelatin, strain, and freeze the mixture at once.

For picnics and similar occasions, hokey pokey is put up in quart molds. These quart bricks are then cut in six or eight slices. Each slice is wrapped in waxed paper or parchment and packed in a brick tank.

Goods of this sort should be sold for just what they are—a less expensive grade of ice cream. The poor materials used in the hokey pokey sold by many street vend-

ers has given rise to considerable prejudice against frozen products of this kind. .

### Fancy Ice Creams

Fancy ice creams differ from those already mentioned, in the method of manufacture rather than in composition. If there is any difference at all in composition, it is usually in the amount of stabilizer or the richness of the cream used. It is very important in making fancy ice cream that it be so made and frozen that the molded cream will retain its shape after it is removed from the mold. For this reason more stabilizer or a richer cream is sometimes used. The principal difference between fancy ice cream and ordinary bulk ice cream, however, is in the manner of packing. Brick molds of various capacity, large fancy molds for molding ice cream in the form of a statue or some other object, and small individual molds holding enough ice cream for one service are the usual forms in which the fancy ice cream is put up.

**Special formulas** are sometimes used for fancy ice creams and ices, largely because this kind of ice cream is often made to order. The ice cream maker who has some originality and a little artistic talent can easily work up a large and very profitable trade by preparing a specially molded, flavored, and colored ice cream or ice for special occasions. This, however, is a subject of sufficient importance to warrant its treatment in a separate chapter. (See Chapter XII.)

### Mousse

This is a frozen whipped cream. It is given here as a special class because of its difference in composition and method of manufacture.

The cream to be used in making mousse must be of such richness that it will whip to a stiff froth. The richness of the cream as well as the method of making may have to be varied somewhat with different flavors.

The flavors which may be used are vanilla, coffee, caramel, almond, pistachio, maple and various fruit flavors. When the extract flavors are used, the directions for whipped cream may be followed until the mousse is ready to pack.

The freezing is accomplished without agitation by packing the whipped cream in a mold or a can surrounded by equal parts of ice and salt. To obtain good results it will be necessary in many cases to use gelatin, particularly where fruit is used quite liberally. The following formulas may be taken as representative of this class of frozen products.

### **Peach Mousse**

(For about five gallons)

- 2 gals. 35% cream
- 1 gal. sifted peach pulp
- 4 oz. lemon juice
- 4 to 5 lbs. sugar
- 4 oz. gelatin

Soften and then dissolve the gelatin by heating over boiling water and add it to the fruit juice. Dissolve the sugar in the fruit juice; chill and stir the mixture as it begins to thicken. Whip the cream until stiff and fold it into the fruit mixture very carefully. Pack it in ordinary ice cream cans or molds to harden. By following these same directions any other fruit flavor may be used.

Where fruit juice of slight acidity is used instead of the pulp, the following method may be substituted.

**Strawberry Mousse**

(For about five gallons)

2 gals. 40% cream

 $\frac{3}{4}$  gal. strawberry juice.

4 lbs. sugar

2 oz. gelatin

Press the fruit, heating if necessary to start the juice, strain, and add the sugar and the melted gelatin. Chill both the fruit and cream before mixing and whip until stiff. Pack in molds or freezing cans surrounded with equal parts of ice and salt.

**Pineapple Cream Soufflé**

(For about five gallons)

2 gals. 40% cream

6 qts. pineapple juice

8 lbs. sugar

Yolks of 5 doz. eggs

4 oz. gelatin

Beat the yolks and part of the sugar to a cream. Add the rest of the sugar to the fruit juice and cook to a clear syrup. Add the hot syrup to the beaten egg yolks. Strain the melted gelatin and add it to the mixture. Whip the mixture until it is stiff and well swollen. Set it in a refrigerator or ice cave until well chilled. Then add the whipped cream, which should be lightly stirred in but not beaten. The mixture is packed and frozen the same as ordinary mousse.

It sometimes happens that a customer desires to serve these desserts with a sauce. In that case the sauce should correspond in flavor with the frozen dessert. The follow-

ing sauce may be served with the pineapple cream soufflé described above.

### Sauce for Soufflés

½ gal. 20% cream  
10 oz. sugar  
Yolks of 1½ doz. eggs  
1 pt. pineapple juice  
Juice of one lemon  
Color yellow, if desired

Beat the egg yolks and sugar until smooth and cook with the cream to form a soft custard. Chill the mixture and stir in the fruit juices; then pack in ice without salt until needed.

### Vanilla Biscuits

10 qts. whipping cream  
60 egg yolks  
7½ lbs. sugar  
2 pts. water  
3 oz. vanilla sugar

Cook the sugar and water to a clear syrup; add the beaten egg yolks and the vanilla sugar. Strain the mixture and beat it until it is cold and quite stiff. Whip the cream to a stiff froth and stir it into the cold mixture. Place the mixture in molds or paper cases and set them in an ice cave to harden.

### Almond Biscuits

10 qts. whipping cream  
60 egg yolks



6 lbs. sugar  
2 pts. water  
1 oz. almond extract  
2 lbs. blanched almonds

Cook the sugar and water to a clear syrup. Pound the almonds and almond extract to a smooth paste. Beat the egg yolks to a smooth cream. Add the nut paste and the eggs to the hot syrup and stir it until the mixture begins to thicken. From this point on the process is the same as for vanilla biscuit.

### Cherry Biscuits

10 qts. whipping cream  
60 egg yolks  
5 qts. cherry juice  
10 lbs. sugar  
3 oz. gelatin

Beat the egg yolks and the sugar to a smooth cream; add the cherry juice and cook the mixture until it coats a spoon. Dissolve the gelatin in the smallest possible amount of warm water and add it to the cooked fruit juice. Strain and cool the mixture. Whip the cream to a stiff froth and stir it lightly into the fruit custard.

Any of the above mixtures may be frozen up as directed, or the biscuits may be glazed with meringue and served in that way.

## CHAPTER XI

### WATER ICES AND SHERBETS

#### Water Ices

Water ices and sherbets are not strictly dairy products as they do not always contain milk. The water ices are made from fruit juices diluted with water, sweetened, and frozen. Sherbets have practically the same composition but contain in addition egg albumen and sometimes gelatin.

Water ices are of variable composition and richness, some being made almost entirely of fruit juices highly sweetened and frozen, while others are very much diluted and lightly flavored and sweetened. As a rule these ices have a more or less granular texture. The following formulas are given as characteristic ices of the simplest kind.

#### Lemon Ice

3 gals. water  
10 lbs. sugar  
3 pts. lemon juice

Mix all the ingredients. When the sugar is well dissolved, freeze the mixture until fairly firm before removing from the freezer. It will be seen that this is nothing but a frozen lemonade. A pint of orange juice would improve the mixture.

**Orange ice** is made by using three pints of orange juice and a half pint of lemon juice with the other constituents as given above.

### Pineapple Ice

3 gals. water  
10-12 lbs. sugar  
1 pt. lemon juice  
 $\frac{1}{2}$  gal. grated pineapple

**Preparing the fruit.** In preparing the lemon juice for this mixture peel the lemons carefully, cut them in halves, and remove the seeds before squeezing.

The pineapples must be thoroughly ripe and juicy. Pare them and remove the cores, crush or grate them, and strain the pulp. The juice should be used as soon after it has been prepared as possible.

**Preserved fruits,** dried fruits, jellies and prepared fruit juices may be used if fresh fruits are not available, but the results as a rule are not so satisfactory.

As ordinarily made, ices are more or less granular in texture, but by a little extra work in preparing and freezing the mixture it is possible to make an ice with a very smooth texture.

**To make ices of very smooth texture** the sugar and water should be cooked to a clear syrup, strained, and cooled. The prepared fruit juice is then added and the mixture frozen by packing with a slow freezing mixture (1 to 15) and running the freezer at high speed for 15 to 20 minutes.

**Freezing and packing.** The texture a given batch of ice will have when finished will depend to a considerable extent upon the manner of freezing and packing. Rapid freezing and freezing with but little agitation, tend to produce a coarse, granular texture. Cooking, as described

above, with slower freezing and thorough agitation, tend to produce a finer texture.

It will be noticed that ices contain no stabilizer of any sort; consequently, they melt very rapidly and it will be found much more difficult to keep them packed in good condition. The ice used in packing should be finely crushed and should contain somewhat more salt than is used in packing ice cream.

### Sherbets

**Sherbets**, as usually made, are very similar to the ices, both in flavor and appearance, but differ from them in composition. The sherbets always contain eggs and frequently a stabilizer also, but the ices do not.

By careful freezing and proper packing sherbets may be made to resemble ice cream in appearance and texture. The fine texture of sherbets is due to the egg albumen and other stabilizers used in the mix.

**Lemon and orange sherbet** may be made by following the formula given for ices with the addition of the whites of one dozen eggs. The formula should therefore be as follows:

#### Lemon Sherbet

(For about five gallons)

- 3 gals. water
- 10 lbs. sugar
- 3 pts. lemon juice
- 1 pt. orange juice
- Whites of 1 doz. eggs
- 2 oz. gelatin (if desired)

Grate the rinds of about six of the lemons, add it to a part of the sugar, mix well and add this mixture to the fruit juices. The water and the rest of the sugar should be cooked to form a clear syrup and cooled. The fruit juices should then be added and the mixture strained and standardized to a density of 20 degrees on the syrup gauge. The egg whites should be beaten to a stiff froth and may be added to the mixture when it is placed in the freezer.

**A second method of making sherbets**, which gives splendid results but requires more time, is as follows:

Cook the sugar and water to a clear syrup, strain while hot, and set away to cool. Add the prepared fruit juices and the other constituents, except the whites of the eggs, and freeze for about 15 minutes. Add 12 teaspoonfuls of finely powdered sugar to the whites of the eggs and beat to a stiff froth. Open the freezer, scrape down the can, and add the beaten eggs; stir them in thoroughly until smooth. Repack the freezer and set away to harden.

### Pineapple Sherbet

(For five gallons)

3 gals. water  
Whites of 12 eggs  
12 lbs. sugar  
1 pt. lemon juice  
 $\frac{1}{2}$  gal. grated pineapple  
2 oz. gelatin (if desired)

Follow the directions given for lemon and orange sherbet, but be sure to *remove the peel of the lemons before squeezing them*.

**Thanksgiving Day special.** A sherbet for which there is considerable demand on certain occasions, such as Thanksgiving, is made as follows:

(For about five gallons)

3 qts. cranberries  
12 lbs. sugar  
3 gals. water  
Whites of 12 eggs  
2 oz. gelatin

Boil the cranberries, sugar, and water. When the berries are cooked strain out the juice; add the melted gelatin, cool, adjust the density of the mix to 20 degrees on the syrup gauge, and freeze. When the mixture is partly frozen, work in the beaten whites and stir until the whole batch is smooth and uniform throughout.

**Other sherbets** may be made according to this formula by substituting the proper fruit juice. Some of the fruits that are only mildly acid must be used in larger amounts. As a rule such fruits as strawberry, peach, cherry and any other fruits of mild acidity may be used at the rate of one quart of crushed fruit or fruit juice to the gallon of water. In connection with these, lemon juice should be added at the rate of  $2\frac{1}{2}$  ounces to the gallon of water, sugar at the rate of three to four pounds to the gallon of water, and the whites of four eggs for each gallon of water. Except in lemon sherbets and where otherwise noted, the peel of the lemon and the seeds should be removed before squeezing.

**Freezing.** It requires more time to freeze a sherbet properly than to freeze ice cream, but when properly frozen the two will be very much alike in appearance and texture.

Sherbets will not stand up well unless packed very carefully in very finely crushed ice containing somewhat more salt than is used for ice cream.

**A general formula** which may be used as a base for all sherbets is as follows :

(For about five gallons)

3 gals. water or milk  
10 lbs. sugar  
1 pt. lemon juice  
3 oz. gelatin  
3 egg whites well beaten

Freeze the mixture rather slowly. When it is nearly ready to remove from the freezer add the beaten egg whites.

By adding the proper flavoring material to this general formula, lemon, orange, grape, cherry, pineapple or any other desired sherbet may be made.

**Lemon sherbet.** To the general formula add one *quart* of lemon juice and one *pint* of orange juice.

**Orange sherbet.** Add two quarts of orange juice to the general formula.<sup>1</sup>

**Grape sherbet.** Add two quarts of grape juice to the general formula.

**Cherry sherbet.** Use three quarts of pitted cherries in addition to the ingredients given in the general formula.

**Pineapple sherbet.** Add three quarts of grated pineapple to the general formula.

**Milk sherbets** are made by substituting whole or skim milk for the water called for in the ordinary recipe. To

<sup>1</sup> For directions for preparing lemon and orange juice see pages 104 and 105.

prevent the fruit acid from curdling the milk, mix and freeze all the ingredients except the fruit. When the mixture is partly frozen stir in the fruit and complete the freezing process. This gives a sherbet of much richer flavor and of finer texture than those made with water.

### **Lemon Sherbet (Milk)**

(For about five gallons)

- 3 gals. milk
- 10 lbs. sugar
- 3 pts. lemon juice
- 1 pt. orange juice
- Whites of 1 doz. eggs
- 2 oz. gelatin (if desired)

### **Grape Sherbet (Milk)**

- 3 gals. milk
- 10 lbs. sugar
- 2 qts. grape juice
- 1 pt. lemon juice
- Whites of 1 doz. eggs
- 2 oz. gelatin (if desired)

### **Fruit Granite**

- 1 pineapple
- 1 doz. bananas
- 1 doz. lemons
- $\frac{1}{2}$  doz. ripe peaches
- $\frac{1}{2}$  doz. apples
- 1 doz. oranges



6 lbs. sugar  
3 qts. water  
2 oz. seeded raisins  
2 oz. blanched nuts  
Spice, if desired

Pare the pineapple and pick it into bits ; cut the berries into small even sized pieces. Carefully remove the pulp from the oranges, rejecting the coarser part and the seeds. Peel the lemons carefully before squeezing them. Cook the sugar and water to a clear syrup. Cool the syrup, pour it into the fruit mixture and freeze it at once. When the mixture is partly frozen remove the dasher, pack smoothly and allow it to freeze up without further agitation.

This formula may be modified to suit conditions. For example, the peaches, raisins and nuts may be omitted, or strawberries may be substituted either for the peaches or for the pineapple. The characteristic texture of granites is rough and granular.

**Punch.** A characteristic punch is a sherbet to which some kind of spirits have been added, but mixtures containing several kinds of fruit juice highly flavored and spiced are also known as punches.

### **Roman Punch I**

(For about five gallons)

3 gals. water  
8 to 10 lbs. sugar  
 $\frac{1}{2}$  pt. lemon juice  
5 qts. fruit juice  
1 qt. rum  
2 oz. gelatin

Mix this and freeze as for sherbets and ices. The following is sometimes used also.

### Roman Punch II

(For about five gallons)

3 gals. water  
10 lbs. sugar  
2 doz. oranges  
2 doz. lemons  
2 oz. gelatin  
1 qt. liquor

**Ordinary punches** do not contain liquor but consist of a mixture of fruit juices seasoned with spices of various kinds according to taste.

### Fruit Punch

(For about five gallons)

3 gals. water  
10 lbs. sugar  
2 qts. orange juice  
2 qts. pineapple juice  
1 pt. lemon juice  
2 oz. gelatin  
Spices to taste

The spices used in this formula may consist of cloves, cinnamon, nutmeg or any other spices to suit the taste. The mixing and freezing is practically the same as for sherbets.

### Lacto

Lacto is a milk sherbet made from sour milk, buttermilk, or fermented milk. A description of this product with formulas and direction for making were first published in bulletin form in January, 1911, by the Iowa station. The following extract is taken from a revised edition of the original bulletin now published by that station as Bulletin 140.

**Origin.** "When the writer (Professor Mortensen) undertook to overcome popular dislike for sour milk he experimented in flavoring sour milk drinks with fruit juices. At one time such products were placed upon the market, but on account of the lack of time for advertising no great demand for them was created.

**"Preparation of milk used for manufacture of lacto.** The milk for lacto is prepared in a similar manner to the starter which is used for cream ripening. A commercial lactic acid culture is used. This is added to a pint of skimmed milk which has been pasteurized at a temperature of 185° F. for 20 minutes, and after pasteurization, cooled to from 68° to 72° F. The lactic acid culture is mixed thoroughly with the milk and left at 68° F. until the milk has coagulated. Then another bottle of skimmed milk is pasteurized and cooled in the same manner; but instead of a culture, a part of the coagulated milk is added to insure the souring of the milk inside of 18 hours. This operation is repeated until the final batch of soured milk obtained has lost the undesirable flavor due to the substance in which the commercial culture was preserved. After this point has been reached, which requires from four to six days, the last sample of soured milk obtained is added to a larger amount

of pasteurized skimmed milk. This is then treated the same as the former lots. In this way an amount of milk sufficient to work with is obtained.

“Where lacto is to be made in the household on a small scale it may prove too expensive to buy commercial lactic cultures. A family recipe then would be as follows:

“Take a bottle of good, clean, fresh milk which has not been heated, set it away at a temperature of from 68° to 70° F. until it coagulates. If it coagulates as a smooth, solid curd without pin holes, if the aroma is clean and pleasant, and the flavor nice and creamy, it can be used as a starter for a larger amount of pasteurized whole or skimmed milk.

“The milk when ready to be used for lacto has an acidity of 0.7 to 0.8 of 1 per cent. expressed in terms of lactic acid. It must be of a mild and clean acid flavor. The curd must be thoroughly broken up. This is accomplished by pouring it from one pail to another until it is as smooth and velvety as rich cream. From this milk, which in this connection will be called ‘lacto milk,’ the various lactos are prepared.

“**Preparing the mixture.** The sugar is first dissolved in the lacto milk. The eggs are then prepared. The whites and yolks are kept in separate containers and each lot is beaten with an egg beater. Both the yolks and whites are then added to the milk. The mixture is thoroughly stirred and strained through a fine wire gauze. The fruit juices are added last. The freezer is now run until it turns with difficulty, when the paddle is removed. The brine is removed and the freezer repacked with ice and salt and left for an hour before the contents are served.

“In the previous report, bacteriological analyses of lacto

were published which showed that large numbers of the lactic acid producing bacteria survive the freezing process. A decrease in their number begins, however, soon after this and continues slowly until eventually but few of these organisms are living. There is apparently no change in the amount of contained acid during the storage of lacto."

### **Pineapple Lacto**

(For about five gallons)

3 gals. lacto milk  
9 lbs. sugar  
12 eggs  
1½ gals. grated pineapple  
1½ pts. lemon juice

### **Raspberry Lacto**

3 gals. lacto milk  
9 lbs. sugar  
12 eggs  
1 qt. red raspberry juice or concentrated syrup  
1½ pts. lemon juice

Other lactos such as grape, cherry, lemon, orange, etc., may be made by substituting the proper fruit juice in the above formula.

## CHAPTER XII

### FANCY MOLDED ICE CREAMS

Ice cream belonging to the class known as the fancy molded ice creams, differs from plain bulk ice cream chiefly in the form in which it is put up for market. In some cases there may be a slight difference in formula but the principal difference is in the manner of coloring and in the size and form of package.

**The difference in formula** consists usually in the addition of a little more of some kind of stabilizer or the addition of more milk solids to obtain a better body.

**The difference in package** is one of the distinguishing features of fancy ice creams. The most common package or form of molded ice cream is the quart brick. Considerable ice cream is molded in the form of some object, such as an animal or a statue and may contain a number of quarts of ice cream. The individual pieces are also molded in imitation of some object but of such size that each piece contains enough ice cream to serve one person.

**For a different class of trade.** The fancy molded ice cream is intended for a special trade. The plain bulk products are for the ordinary retail trade and are made up in standard flavors and packed in the large five to ten gallon packers. The fancy molded ice creams, on the other hand, are for special occasions such as parties, balls, ban-

quets, and similar entertainments. The quantity in which any one kind of molded ice cream may be made will depend upon local conditions. In the larger cities there is always a demand for plain bricks of ice cream or for bricks containing two or more flavors and colors. These are usually made up in quite large quantities daily. There is sure to be a demand also for special forms, flavors and colors of ice cream for special functions.



Fig. 32. Cutting and wrapping brick ice cream in the Hendler Creamery Co.

By timely suggestions and careful advertising, the wide awake and progressive ice cream manufacturer will endeavor to stimulate a demand for special kinds of ice cream. Success in this line requires no small amount of ingenuity, originality and an artistic taste.

**Original ideas** and designs will always command a pre-

mium where there is any market for fancy ice creams. A person who wishes to entertain will welcome any suggestions in regard to appropriate form or flavor of the ice cream or ice to be served and will be willing to pay a special price for something new and appropriate for the occasion. The ice cream maker who can give these little suggestions is sure of success, but it requires the exercise of good taste to do so.

**Harmony of color and flavor** is of great importance. The colors and flavors should be selected with much care. That is to say, the color must be suggestive and must harmonize with the flavor. For example, a vanilla ice cream is always white, but a strawberry ice cream is pink because that is the color naturally imparted by the fresh fruits. Preserved fruits do not color the mix sufficiently, so it is customary to add pink coloring matter. It would most certainly be a bad combination of colors and flavors if one were to color a vanilla ice cream pink or a strawberry ice cream brown. Not that coloring adds or detracts from the flavor, but unless the two harmonize, there is nothing suggestive in the color.

**Coloring matter** should be used sparingly. The colors should not be too deep, for in that case there is a suggestion of artificiality and cheapness. Light and dainty tints are the most attractive and pleasing to the eye. The amount of color used in any case is small, but it must be free from odor or flavor and absolutely harmless. The color is one of the important features of fancy ice creams. Any desired shade may be obtained by blending various colors. For example, yellow and blue when mixed in the proper proportions give a green color; red and blue make purple; yellow and white make a cream color; pale blue and red



give a violet tint; pale red and white give a very dainty pink. The colors must not only harmonize with the flavors, but where two or more colors are used in the same mold they should harmonize with one another.

**Layer bricks** are made in the ordinary brick molds but contain two or more kinds of ice cream in uniform layers. The different layers should be of uniform thickness and clearly defined. These bricks when carefully made and in colors and flavors that harmonize are very pleasing in ap-

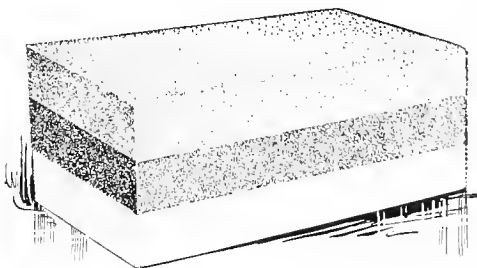

Fig. 33. A Three-layer Brick.

pearance. Striking contrasts in color, as a rule, are not pleasing, but there may be occasions when fantastic colors are permissible or even desirable, as for example, when it is necessary to match some general color scheme for a special occasion.

**Special designs** also require special colors. A heart center, for example, should be pink in a white or cream colored field; a shamrock should be colored a light green in a white or very pale green field.

**Individual pieces** and the large molded forms of ice cream should be colored to correspond with the objects they represent. The same precaution should be observed

in regard to the kind and amount of color to use and the flavor of the ice cream in these special forms.

**Brick molds.** The most common form of molded ice cream is that which is put up in bricks. These are usually of one quart capacity and measure  $2\frac{3}{4} \times 3\frac{1}{4} \times 6\frac{1}{4}$  inches, but there are other molds of different capacities and different dimensions. For example, the four and eight quart sizes, known as sectional molds are about  $6\frac{1}{4}$  inches wide,  $2\frac{3}{4}$  inches deep, and  $12\frac{3}{4}$  or  $25\frac{1}{2}$  inches long.

**Sectional molds** are used in making up ordinary quart bricks in large quantities. The width of these equals the length of the ordinary quart bricks. Extending across the bottom of the mold is an indentation every  $3\frac{1}{4}$  inches.

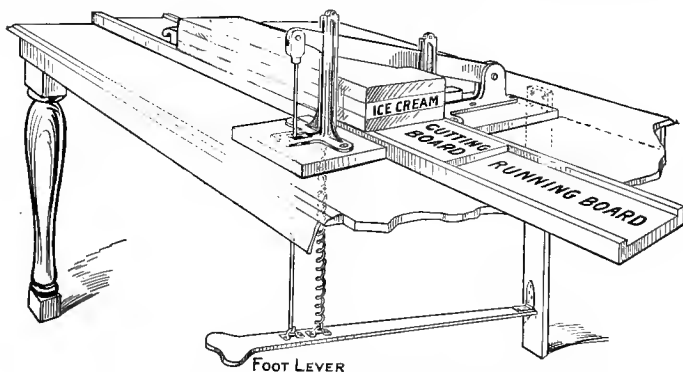

Fig. 34. Hauk's Brick Cutter. For cutting sectional bricks into one quart bricks.

These indentations mark the places where the large brick must be cut to make up quart bricks. The sectional molds are usually of the single lid type, but the one and two quart molds may be obtained in either single or double lid

type. The double lid molds have a number of advantages over the single lid molds. The principal advantage is the facility with which the frozen cream can be removed from the molds. The single lid molds, however, are tight at the bottom and there is therefore less danger of brine getting into the mold and spoiling the ice cream.

The molds should be made of quite heavy material and should be well tinned so that they may be kept clean and bright. The lids should fit well, but it will always be necessary to place parchment paper under the covers to prevent the brine from working in.

**Fancy center bricks** may be made in a specially constructed brick mold or the centers may be frozen separately in a special mold and afterward inserted in the ice cream in a plain brick mold.

In the special fancy center molds the outer portion or background is frozen first. The mold in which the freezing is done is in two parts. The outer part is the size of an ordinary quart brick and is provided with lids at the ends instead of top and bottom. Attached to one of the lids and running lengthwise through the mold is the second or inner part which is made in the shape of the desired central design. To use these molds one lid is made tight with parchment paper and the mold filled to within one and a half inches of the top with soft ice cream. The center piece is thrust down into the ice cream until the cover to which it is attached comes into place. The cover keeps the center piece exactly centered. The mold is then packed away to freeze, but should be kept in an upright position until the ice cream is well hardened. The center piece is hollow, so that cold water can be poured into it to thaw off the ice cream. The center piece is then removed, leaving a hole

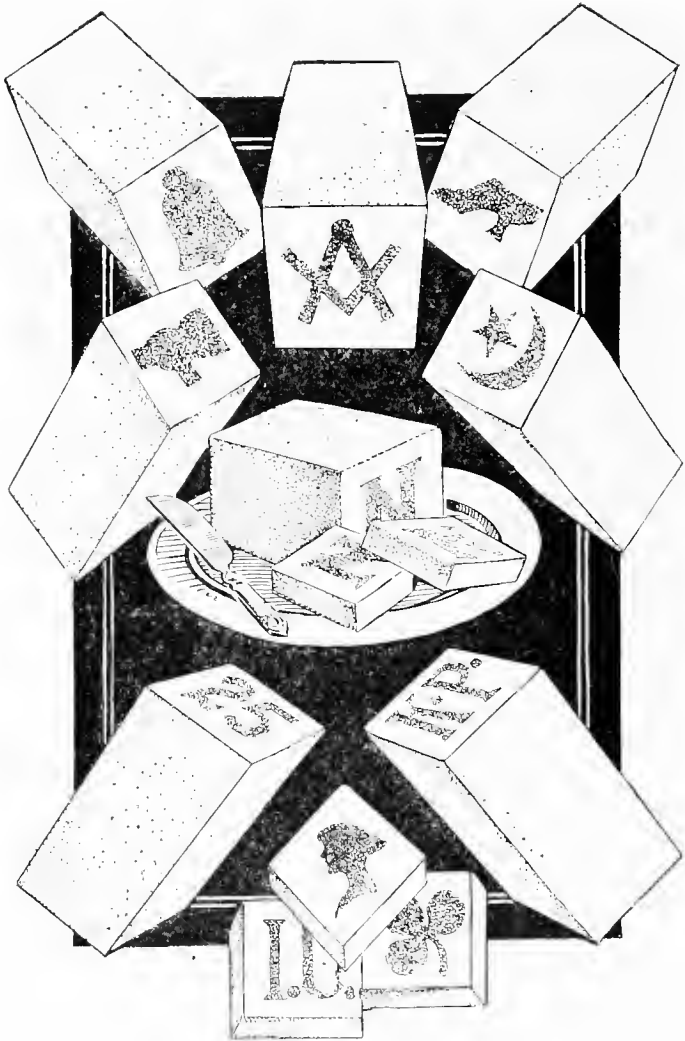

Fig. 35. Showing some of the Fancy Center Designs for brick ice cream.

through the brick just the shape of the desired center design. The space is then filled with ice cream or sherbet of some other color and a plain lid put on the mold which is again packed away until the ice cream in the center is thoroughly hardened.

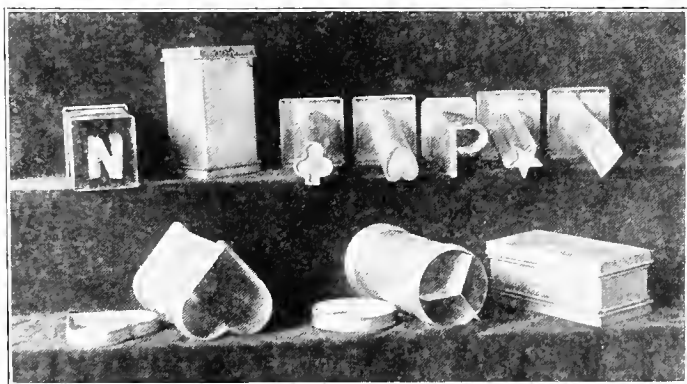

Fig. 36. Showing a few of the different types of Ice Cream Molds.

There is another type of fancy center mold in which the center is frozen first in a separate mold and is afterward imbedded in soft ice cream in the ordinary quart molds. These are known as Cassell fancy centers.

**Cassell fancy center molds** consist of a number of detachable sections which may be taken apart to remove the molded object or center without marring or thawing the ice cream. The great advantage of molds of this type is that the ordinary quart and sectional mold may be used for freezing the outer portion of the brick. The cost of the molds is therefore greatly reduced. Another advantage is that the mold comes apart so that more complicated designs may

be frozen. It is somewhat more difficult to get the center pieces properly centered in the mold, but when one becomes accustomed to this type of mold, very neat and rapid work may be done.

Fancy center bricks are made by this method by first "freezing up" the desired number of centers. These should be kept in the hardening room until they are to be put into the bricks. A sectional mold is then filled about half full of fresh ice cream. The frozen centers are laid in the mold crosswise and just far enough apart so that when the large brick is cut up into quarts each quart brick will contain a center piece. When the center pieces are in place the mold is finished by filling with the soft ice cream. The filled mold is then frozen in the same way as any other brick. Practically all brick ice cream is put out in the one quart size, but ice cream which is molded in special molds in the form of some object may contain anywhere from one-tenth of a quart to several quarts of ice cream.

**Individual molds** are of such size that each mold will hold just enough ice cream to serve one person. These

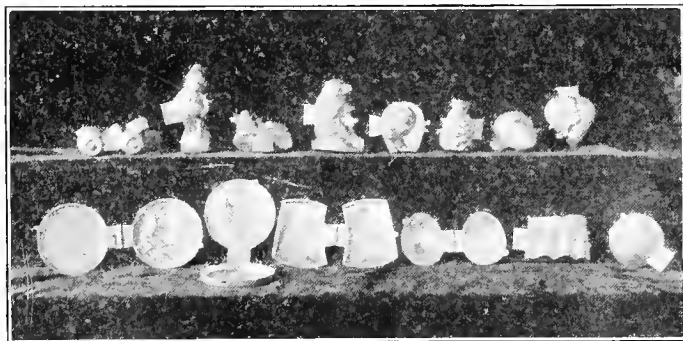

Fig. 37. Individual Molds.

individual pieces are very popular for festive occasions where some appropriate form can be selected.

The method of preparing these various kinds of molded ice cream, although apparently very simple, requires much practice and patience to turn them out rapidly and neatly. The molds should be clean and well chilled before the ice cream is placed in them. Each half of the mold is then filled with ice cream and the mold pressed together tightly and packed away to freeze.

**The ice cream** which is put up in these various molds does not always differ in composition from plain bulk ice cream. It is very essential, however, that the molded ice cream should retain its form and the impression of the mold. Under some circumstances it is advisable to make up a special batch of ice cream having a heavier body for the molded ice cream. The ice cream should not be very firm when molded. For brick ice cream it is best to mold it as soon after it is taken from the freezer as conditions will permit. In addition to the heavier loss in handling a firm ice cream, it is also more difficult to fill a mold properly. There is a device on the market now which can be attached

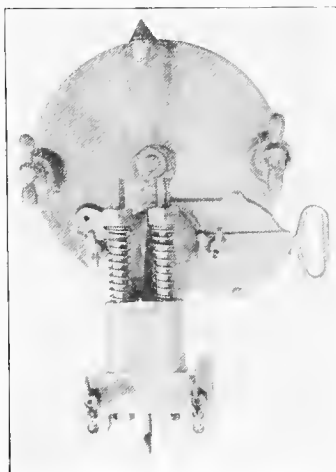

Fig. 38. Hawk's Mold Filler. The mold filler is attached to the delivery spout of the freezer and the molds filled directly from the machine without further handling or transferring.

to the delivery spout of the freezer to enable one to fill brick molds directly from the freezer and in this way eliminate the loss of time and of ice cream incident to handling a second time. What has been said regarding ice cream for molding, applies also to sherbets which are frequently used in connection with ice cream for making fancy bricks.

**Sherbets and ice cream.** Bricks containing a layer of sherbet and one or more layers of ice cream are very popular. The molds are prepared the same as for ice cream, but as a rule it will require a lower temperature to freeze the brick up properly. A brick containing one layer of sherbet or ice and two layers of ice cream is best made up by placing the layer of sherbet between the two layers of ice cream, particularly if there is likely to be any difficulty in keeping the brick well refrigerated before it reaches the consumer.

A little practice will soon enable one to turn out brick ice cream easily and rapidly. The difficulties most frequently encountered in making brick ice cream, especially in small factories where the freezing is done in a mixture of ice and salt, are insufficient freezing and the presence of salt in the ice cream. These difficulties may be overcome by proper packing and proper preparation of the molds in which the ice cream is frozen.

**Preparation of molds.** Ordinarily a brick mold is prepared by making the covers tight with several layers of parchment paper. This is sufficient preparation where the molds do not stand in brine. If, for any reason, it is necessary to freeze the ice cream very quickly, the seams of the mold can be made tight by pasting a strip of buttered paper over them. A part of the brine can then remain on



the freezing mixture without danger of spoiling the ice cream, and the freezing will be much more rapid.

**Freezing molded ice cream.** In the factories which are equipped with a dry air hardening system the manufacture of molded ice cream is greatly simplified. In most small factories, and in many large ones too, the bricks and other forms are still frozen in a mixture of ice and salt. The ice



Fig. 39. Mono-service Ice Cream Container.

should be crushed quite fine and salt added in the proportion of about one part salt to five or six parts of ice. The box in which the molds are packed must be so arranged that the brine can drain away. The object of allowing the brine to drain off is to minimize the possibilities of any of the brine getting under the covers and spoiling the ice cream.

**Removing the ice cream.** It is not a very difficult matter to remove the ice cream from the mold, provided it has

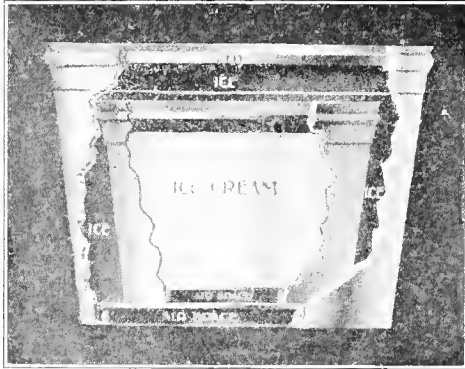

Fig. 40. Section through a Mono-service container, showing insulation and space for ice.

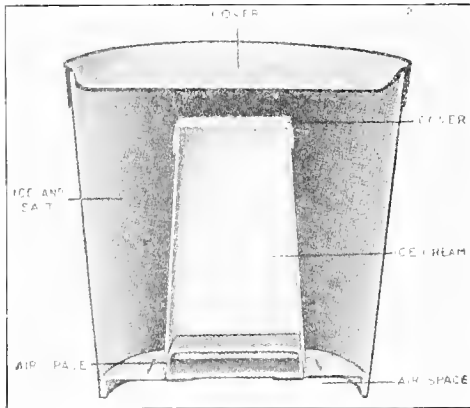

Fig. 41. Section through Week's Carrier.

been well frozen. The larger molds may be dipped into *cold* water once or twice, which will be sufficient to thaw the ice cream from the side of the mold without softening more than the very outside of the brick. Small molds, such as the individuals, and centers for the fancy center bricks, may be exposed to room temperature for a moment or two or simply wiped with a wet towel to loosen the ice cream from the mold. Much thawing must by all means be avoided.

**Packing for market.** When the bricks are removed from the mold they should be wrapped in waxed papers and placed in cartons. This work should be done in a special room in which the temperature can be kept moderately low. The bricks are packed in brick tank packers which are square and into which the bricks will fit nicely. Special packing cans, containing a series of removable shelves, must be used for individual pieces and other special forms to prevent injuring the impression on the molded ice cream in transit.

## CHAPTER XIII

### THE FREEZING PROCESS

The freezing process may, for convenience, be divided into two parts. In the first part of the process, the mix is agitated while it is freezing. When frozen to a certain consistency, it is transferred to a packing can and the freezing or hardening completed without agitation. The quantity and quality of ice cream obtained will depend upon the proper manipulation of temperature and the speed of the dasher in the freezer.

**In the freezer.** That part of the process which is done in the ice cream freezer has for its object the lowering of the temperature in such a way that ice crystals will not form in the ice cream after it becomes hard. This is accomplished by agitating or beating the cream vigorously while the temperature is being reduced. The result of this agitation is the incorporation of a certain amount of air in the mix. The increased viscosity of the cream at the freezing point is sufficient to prevent the escape of the air; consequently, the ice cream mixture increases in volume 50 to 100 per cent. This increase is spoken of as the *swell* and is essential to good quality in the ice cream. The mix should be frozen just hard enough to retain this swell. No attempt should be made to carry the freezing any farther than this in the freezer, because the agitation, if continued

very long after the ice cream has reached the freezing point, will cause it to beat down, resulting in a loss both in quantity and quality.

**The purpose of the freezing process** as carried out in the freezer is to beat the cream up to a light creamy consistency and reduce the temperature to a point where the

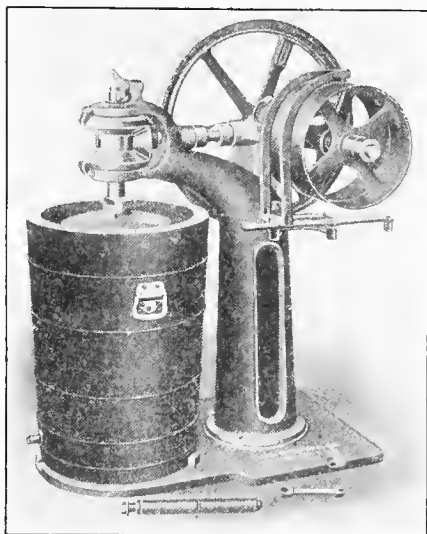

Fig. 42. A North Freezer.

viscosity will be great enough to retain the swell obtained in the freezing process. When ready to remove from the freezer, the ice cream should be viscous enough to retain the swell but thin enough so that it may be poured from one vessel to another. The rapidity with which the mix is frozen will therefore have a great influence upon the quan-

tity and quality of the ice cream obtained from a given batch. According to Washburn, the maximum swell is obtained when the mix has been cooled to a temperature of 28° F. or 29° F. in ten to fourteen minutes.

**Transferring.** When the cream has been frozen to the proper consistency it should be transferred at once to packing cans and the freezing process completed without agitation. The ice cream should be handled carefully, so as not to expel the air which has been incorporated during the agitation in the freezer. It is for this reason that ice cream

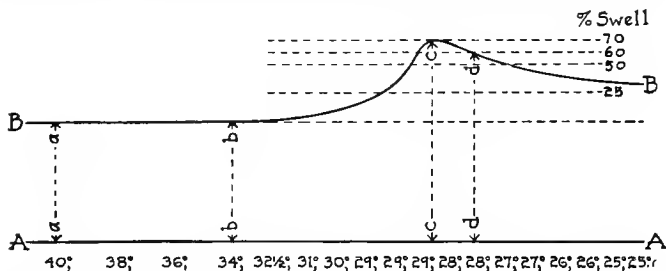

Fig. 43. Chart showing the effect of temperature on the swell of ice cream. The figures below line AA represent the temperature of the mix taken at intervals of one minute. BB represents the space occupied by the mix, before, during and after freezing. (From *Bulletin* 155, Vermont Agricultural Experiment Station.)

should be in a soft condition when transferred. The ice cream should not be transferred from one receptacle to another any oftener than is necessary.

**The packing cans** should be chilled before the ice cream is placed in them so that the first ice cream will not be melted by coming in contact with the warm can. The chilling may be done by placing the can in a mixture of ice and salt in a packer, by placing them in the hardening room

for a short time before they are used, or the can storage room may be refrigerated to keep the cans cool. Where such a system can be installed it will be found highly satisfactory, because the room may be kept free of flies and the cans are always in condition for immediate use and may be taken from the store room as needed. As the cans are filled, a piece of parchment paper should be placed under the cover. The cans of ice cream are then packed in ice or placed in a brine tank or hardening room to freeze.

**Hardening.** The final freezing, which is done after the cream is removed from the freezer, is known as the *hardening* process and may be accomplished in several ways. The final result is the same in all cases, but the method adopted will be governed largely by the capacity of the plant and the amount of capital to be invested in a hardening system.

**A slush box** is generally used in the small plants for hardening the ice cream. Where this system is used the cans of ice cream are packed in a mixture of ice and salt to harden. The slush box is simply a large water-tight box, usually of wood. The box should be insulated to insure greater efficiency.

**The dry air hardening** system is rapidly gaining in favor. In the larger factories, and in many of the smaller ones also, this system has replaced the others which have been mentioned. In this system the air in a well insulated room is kept at a very low temperature by means of expansion coils, and the ice cream is frozen in perfectly dry surroundings. This is unquestionably the cleanest and most satisfactory method of hardening, but as has been pointed out, the advantages and disadvantages are largely matters of economic efficiency rather than effects upon the quality of

the finished product so far as texture and swell are concerned. The control of texture and swell depends largely upon the proper control of temperatures and agitation in the freezer.

**The time required** for proper freezing will be governed by several factors. In the first place, the different kinds of mixtures to be frozen will affect the time somewhat. For example, sherbets and ices require more time and a somewhat lower temperature than ice creams, but if the sherbet is to be sold as a *granite*, the freezing must be done more rapidly and with less agitation because rapid freezing and little agitation are the conditions that give the rough texture characteristic of granites. If it is to be sold as *frappé*, however, it must not be frozen so quickly and must be agitated vigorously while in the freezer to produce a smooth and uniform texture.

The time required for freezing ice cream mixtures will depend somewhat upon the composition, but more upon the temperature of the mix when put into the freezer.

**The temperature of the mix.** It has been pointed out that cream should be held in storage at a very low temperature for the purpose of inhibiting bacterial growth. There is another reason for this, however, and that is to *ripen* the cream. By ripening, as applied to cream for ice cream making, is meant the process of cooling, and holding, particularly after pasteurization, to restore the body and viscosity to the cream. If for any reason it is necessary to scald the cream or to cook the mix, great care must be taken to cool it thoroughly before it is placed in the freezer. Thorough cooling is essential not only to reduce the time required for freezing, but to reduce the danger of the cream churning in the freezer and to secure a better swell. The



time required for proper freezing, under normal conditions, will be from about 10 to 14 minutes.<sup>1</sup>

**Rapid freezing.** If the freezing is carried on too rapidly, the mix is not subjected to sufficient agitation to secure a good swell, because the temperature drops so quickly that the freezing point is reached before the maximum swell has been obtained. In addition to the loss of swell, too rapid freezing does not produce ice cream of the best texture.

**Granular texture** is, in many instances, due to too rapid freezing. The production of a smooth and pleasing texture requires a certain amount of agitation during the first part of the freezing. To illustrate the necessity of proper agitation, take a small quantity of the mix and pack it in ice and salt to freeze without agitation. It will be found that the increase in volume due to freezing is very insignificant and that the texture, instead of being smooth and velvety, is coarse and granular.

**Prolonged freezing**, on the other hand, may also result in a loss of swell, but from a different cause. In this case it would be due to the fact that the agitation, if carried on after the maximum swell has been obtained, will cause the ice cream to *beat down*; that is, it will become so stiff that the agitation will break the cream and allow the air incorporated in the ice cream to escape.

In addition to this, the prolonged agitation may cause the cream to churn. Should this happen, small granules of butter will be found distributed through the ice cream, or the ice cream may have a greasy body. This difficulty is frequently encountered in freezing a mixture containing a high percentage of fat, particularly if the mix has not been properly chilled.

<sup>1</sup> Bulletin 155, Vermont station.

**Low speed.** The mechanical part of the process must also be taken into consideration. The speed of the dasher must be sufficient to give good agitation. If the agitation

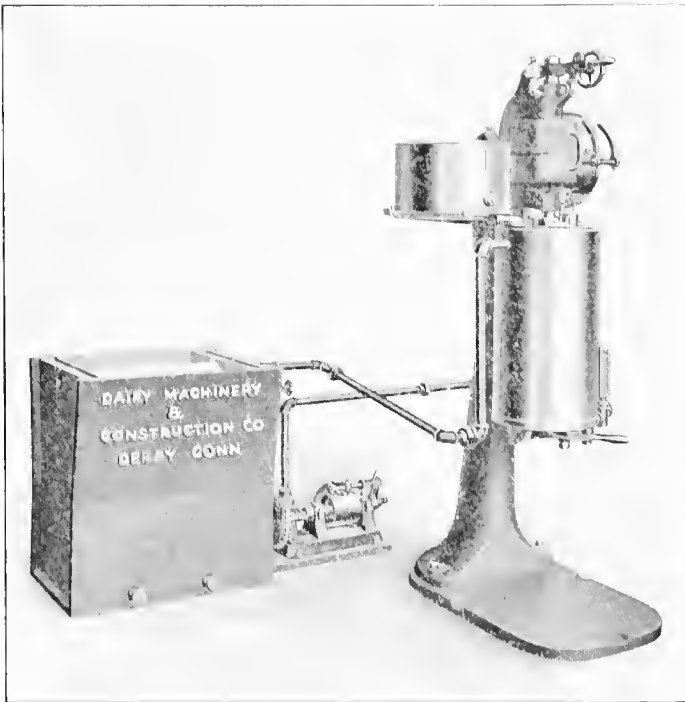

Fig. 44. A Progress Freezer with brine box and circulating pump.

is not vigorous enough the cooling will not be so uniform throughout nor will the swell be so large.

**Too high speed,** on the other hand, will have an effect similar to that produced by too prolonged freezing; namely,

loss of swell due to beating down and churning, or production of a greasy body.

**The control of the various conditions** which may affect the proper freezing must be left largely to the judgment and close observation of the ice cream maker, but the means of control will depend to a very considerable extent upon the kind of freezer used.

**Types of ice cream freezers.** There are various types of ice cream freezers in use in the factories, the oldest type being the upright tub freezer in which the ice cream is frozen by packing ice and salt around the can, the mixture

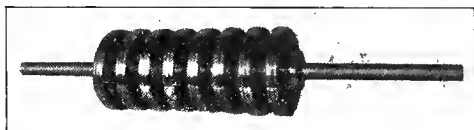

Fig. 45. The discs of a Disc Continuous Freezer.

in the can being agitated by means of a rotating dasher. In the other type of freezer the freezing is done by means of cold brine.

**Brine freezer.** In the brine freezers cold brine is circulated around the freezing can or through the rotating discs. The brine may be cooled by means of ammonia coils in a brine tank, or the ice and salt in the proper proportion may be mixed in a separate receptacle and the cold brine circulated by means of a pump. The brine system admits of a much more complete control of the freezing, as the rate of flow and the temperature of the brine can be regulated to suit conditions. There are still many of the old type freezers in use in which the freezing must be controlled by the proportion of ice and salt used in the freezing mixture.

The proportion of ice and salt. In the ordinary tub freezer the rate at which a given batch of cream will freeze is regulated to a very considerable extent by the proportions of ice and salt used. The very low temperature obtained by mixing salt and ice is due to the fact that when a substance changes from a solid to a liquid form it must absorb a certain amount of heat. With ice, this process of lique-

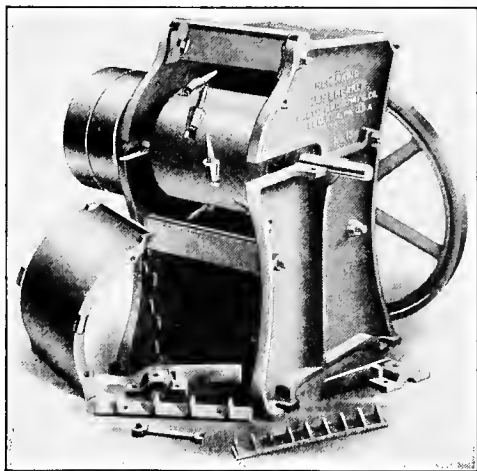

Fig. 46. The New Rapid Ice Breaker, showing the arrangement of crusher teeth.

faction is hastened by the addition of salt, resulting in a very sudden absorption of heat from the substances near the ice and salt mixture. The temperature reached will therefore depend upon how rapidly the ice melts, and may be governed to suit conditions by altering the proportions of ice and salt and to a certain extent by the size of the ice

particles. Under most conditions a mixture of one part of salt to ten or eleven parts of ice will be sufficient, but if the mix is very cold the proportion of salt should be reduced to avoid too rapid freezing.

**The ice should be crushed** in such a way that the pieces will be of fairly uniform size, small enough to pack well in the tub. Large chunks not only do not pack well and leave large air spaces, but melt too slowly. This fact should be kept in mind, because it is sometimes necessary to produce a very low temperature, in which case the ice must be finely crushed and more salt used. This holds true whether the ice and salt mixture is packed around the freezing can or made in a separate container and the cold brine which runs from the melting ice used as the freezing agent.

**Brine freezing** has many advantages over the old method. In the first place, it is possible to keep the floor cleaner around the freezer, because a new charge of ice and salt may be added to the brine at any time without interfering with operations in any way. Furthermore, the cold brine comes in contact with all parts of the freezing can, resulting in greater efficiency. Probably the greatest advantage is in the more perfect control over the freezing by regulating the temperature and rate of flow of the brine. This method of freezing may be employed with the ordinary tub freezer by providing a tank in which the cold brine may be made. A rotary pump must also be provided to circulate the cold brine around the freezing can. With this system of brine freezing the temperature of the brine is regulated by the proportion of ice and salt in the mixture.

**The temperature of brine** cooled by mechanical means,

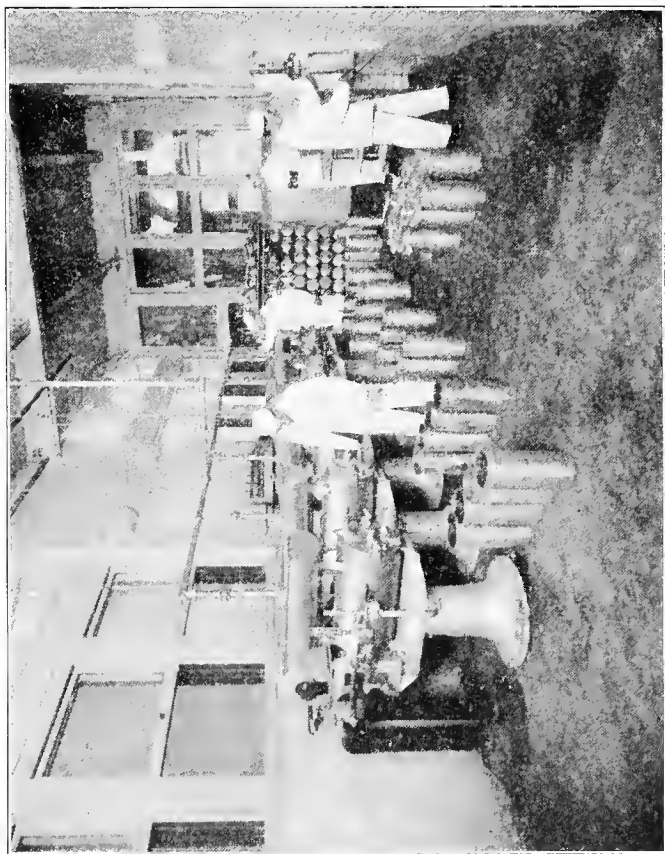

Fig. 47. The Freezing Room in the Hendler Creamery Company.

however, is regulated by the amount of ammonia gas allowed to expand in coils of pipe submerged in the brine. Where the brine is cooled in this way the temperature may be regulated more accurately and as a result the freezing process will be under more complete control.

## CHAPTER XIV

### REFRIGERATION

Ice cream making is largely a refrigeration process. Natural ice was originally used as the refrigerating agent, but mechanical refrigeration has developed so rapidly in recent years that it has been adopted by many factories because of its greater efficiency and cleanliness. Mechanical refrigeration is no longer confined to large plants exclusively. In fact its use in ice cream factories is becoming so general that a book of this sort would hardly be complete without a brief discussion of this process and its application to ice cream making.

**Refrigeration is an interchange of heat** between substances of different temperature. This interchange of heat may be accomplished in various ways, but the process is known as refrigeration regardless of the means employed.

**Natural ice** was originally the only refrigerating agent that could be put into general use. The unit for measuring refrigeration is therefore based upon the refrigerating capacity of ice. When we speak of so many tons of refrigerating capacity we simply mean the equivalent of so many tons of ice melting in 24 hours.

**The British thermal unit.** Just what is meant by a ton of refrigeration will be better understood by determining the actual absorbing capacity of a ton of ice. Heat is measured by what is known as the British Thermal Unit



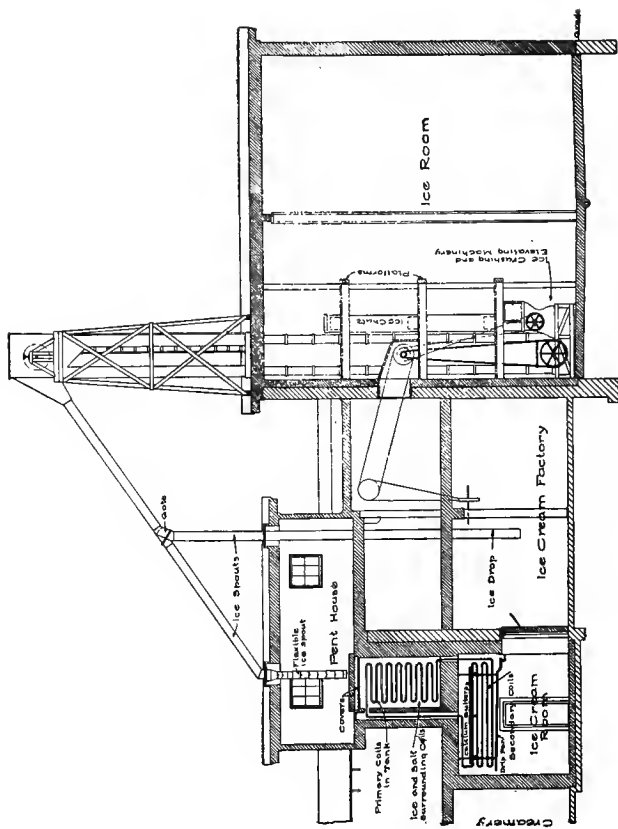

LONGITUDINAL SECTION

Fig. 48. An Ice Cream Factory equipped with Madison Cooper system of refrigeration.

(B. T. U.). A British Thermal Unit is the amount of heat required to raise the temperature of one pound of water through  $1^{\circ}$  F. of temperature, or the amount of heat that must be withdrawn from one pound of water to lower its temperature  $1^{\circ}$  F. To convert a pound of water at  $32^{\circ}$  F. into ice at  $32^{\circ}$  F., it will be necessary to take from it 142 B. T. U. Before this pound of ice can pass into a liquid state again it must take up 142 B. T. U.

**A ton of refrigeration** represents the amount of heat absorbed by 2000 pounds of ice at  $32^{\circ}$  F. in melting into 2000 pounds of water at  $32^{\circ}$  F., or 284,000 B. T. U.

**Kinds of heat.** Heat may be said to be of two kinds: *sensible* and *latent*. Sensible heat is that which may be felt or may be determined by means of a thermometer. Latent heat is the heat required to change the state of a substance without increasing its temperature. For example, if we take a pound of ice and, by means of a thermometer, find its temperature to be 32 degrees, that would be 32 degrees of sensible heat. If this ice be allowed to melt into water at 32 degrees, it will be necessary to supply it with 142 B. T. U. Since the water has the same temperature as the ice, the heat required for liquefaction can not be measured with a thermometer although it has been taken up by the ice in passing into a liquid state. These 142 heat units are therefore called the *latent heat of liquefaction of ice*.

**Latent heat of liquefaction** is made use of when salt is mixed with ice in the freezing process. The salt has such an affinity for water that it causes the ice to melt more rapidly. The ice, in order to change its form, absorbs the necessary heat from its surroundings. The result of the rapid liquefaction is a sudden lowering of the temperature.

**Endothermal actions.** Other substances than ice and

salt may be used for the production of low temperatures. Certain chemical substances when mixed will produce low temperatures. Chemical changes in connection with which heat is absorbed are known as *endothermal* actions. This method is not used in practical réfrigeration, however, on account of the cost of the necessary chemicals.

**Compressed air** was also used at one time as a refrigerating agent. "In this development inventors in Australia took a leading part, being stimulated by the demand for a process for preserving, in a fresh condition, the cheap mutton of that country until landed on the shores of England. For use on shipboard, compressed air machines were originally employed, but they are now going out of use, having been supplanted by simpler machines which can be operated more economically."<sup>1</sup> Quite low temperatures may be produced by compressing and cooling air and then allowing it to expand in the area to be cooled. These machines, however, require too much power to a ton of refrigeration and are therefore less satisfactory and less economical than those machines which use some other gas, such as sulphur-dioxide, carbon-dioxide, or ammonia. The process of producing low temperatures by the use of any of these substances, with the aid of the necessary mechanical appliances, is spoken of as artificial refrigeration or mechanical refrigeration.

**Mechanical refrigeration** is a comparatively recent development, and it is only within the last few years that this process has been used to any extent in the ice cream industry. On account of the greater efficiency and for sanitary reasons, mechanical refrigeration is rapidly gaining in favor among ice cream manufacturers.

Of the various gaseous substances which may be em-

<sup>1</sup> Bulletin III, West Virginia station.

ployed in mechanical refrigeration, ammonia is the one most generally used. The principle upon which all of these machines operate is the same whether the refrigerating agent be carbon-dioxide, sulphur-dioxide, or ammonia. The difference in the chemical and physical properties of these substances, however, may necessitate some slight differences in the construction of the machinery. Since ammonia is the most common refrigerating agent used in

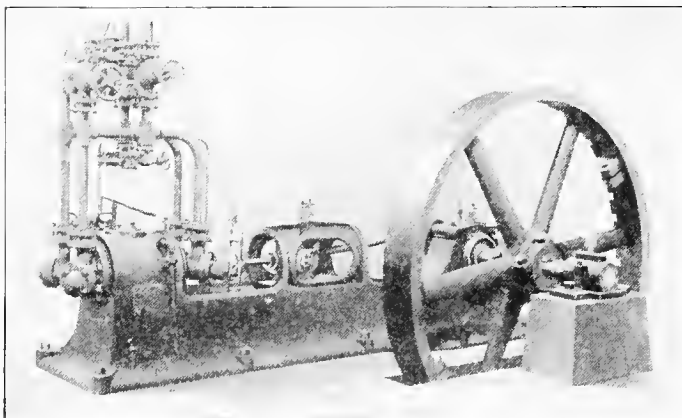

Fig. 49. A Vilter Compressor.

mechanical refrigeration, this brief discussion will be limited to ammonia machines.

**Ammonia** is obtained commercially from sal-ammoniac. The pure liquid ammonia is a colorless fluid with a very pungent odor and an alkali reaction. The liquid ammonia, at atmospheric pressure, boils at a temperature of 28.5 degrees below zero Fahrenheit. It is, therefore, a gas under ordinary conditions. A cubic foot of the liquid weighs 39.73

pounds. Its value as a refrigerating agent is due to the low pressure and comparatively high temperature at which it will liquefy, making it easy to condense the gas to a liquid form.

There are two methods by which ammonia may be used in refrigeration. One is known as the *absorption* method

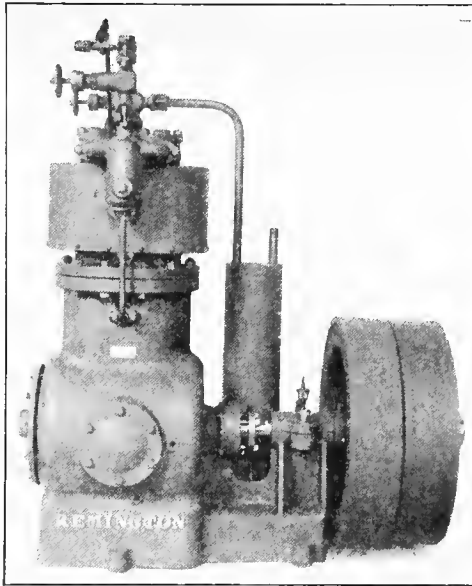

Fig. 50. A Remington Compressor.

and the other is the *compression* system. In the former the gas, instead of being compressed by mechanical means, is obtained from a solution of ammonia in water which is heated in a still to drive off the ammonia gas, which is later condensed. The ammonia then passes through the expansion valve and back to the absorber. In the absorber the

gas is brought into contact with the water, called the mother liquid, from which it was originally extracted, the water in the meantime having gone through a cooling process. The cool mother liquid rapidly absorbs the gas and forms a strong solution of ammonia, which is returned to the still by means of a pump and is again ready to go through the

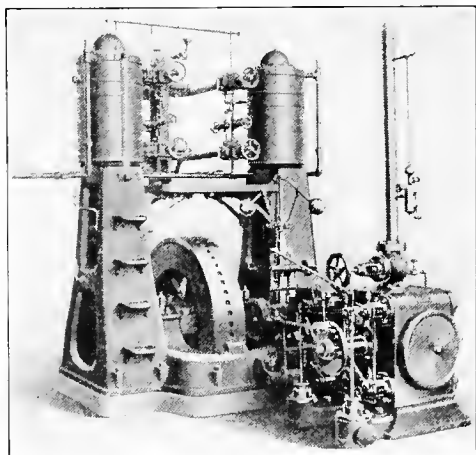

Fig. 51. A York Compressor.

same cycle of operations. This system has been abandoned almost entirely in favor of the compression system.

**The compression system** is so named because the gas is alternately compressed by mechanical means and then expanded. There are three distinct operations in the compression system; viz., compression, condensation, and expansion.

The gas is compressed by means of a compressor to a pressure varying from 125 to 175 pounds to the square inch.

In this compressed condition the gas is cooled by means of water, which causes it to condense; it then collects in a liquid form in a receiver. The liquid is piped from the receiver to the expansion coils. In order to reach the expansion coils the liquid is allowed to escape through the expansion valve, whereupon it passes into a gaseous state. After the gas has expanded it is pumped back to the compressor, thus completing the cycle of operations. As the pressure on the condenser is from 125 to 175 pounds and the pressure on the expansion coils is only 15 to 20 pounds, it will be seen that the system may be divided into two parts known as the high pressure side and the low pressure side. All that portion of the system from the discharge valve on the compressor to the expansion valve is on the high pressure side, and all from the expansion valve to the induction valve on the compressor is included in the low pressure side of the system.

In a refrigerating plant, using the compression system, the compressor is a vital part of the equipment. The efficiency and capacity of the plant depends largely upon the efficiency and capacity of the ammonia compressor. The ammonia compressor is used to pump the expanded gas from the expansion coils and deliver it to the condenser.

**Ice cream refrigeration** differs from ice making and ordinary cold storage in that the freezing must be accomplished in a few hours instead of days. This must be kept in mind in installing refrigerating machinery. The mistake must not be made of installing a machine of too small capacity. A ton of refrigerating capacity is based upon a 24-hour run, so that where machines are run for less than 24 hours a greater capacity is required. That is, if one ton of refrigeration is required and the machine is to

be run only 12 hours, it will be necessary to use a two-ton machine.

**Requirements of a good ammonia pump.** The stroke of the piston must be accurately gauged in order that the clearance between the follower and the cylinder head may be as small as is consistent with safe operation and to insure complete expulsion of the gas at each stroke. If there is much clearance between the follower and the cylinder head, the capacity of the pump will be reduced, because the compressed gas in the space between the follower and the cylinder head will not permit the suction valve to open until the piston has started on the return stroke and allowed the gas to expand until the pressure in the cylinder is below the pressure on the opposite side of the suction valve.

**The capacity of the compressor** depends upon the number of *pounds* of gas which it can handle in a day; consequently, the size of the rooms to be cooled and the temperatures to be maintained must be taken into consideration and a compressor of ample size selected so that the desired temperature may be maintained as economically as possible.

**The stuffing boxes.** The leakage of ammonia, even if so slight as to cause but little expense, is always an annoyance. The most of the leakage occurs around the stuffing boxes; hence, they must be watched very carefully. The stuffing boxes should be of unusual length, but with whatever care they are designed, they will require frequent attention in all machines to keep the packing set up enough to prevent leakage.

The packing must be kept sufficiently tight to prevent leakage but not so tight as to cause the box to heat. This is a point that must be watched constantly. The stuffing



box should be so designed that the packing may be adjusted while the machine is in operation.

**The valves** must be of sufficient area to allow a free passage of the gas through them. They must be durable in construction and reliable in action so that there is little danger of their getting out of order. As the ammonia system must be as free from air as possible, the fewer times any part of the system is opened for repairs the better. In refrigerating machinery, as in every other kind of machinery, repairs will be needed from time to time. To prevent any great loss of gas or the introduction of air into the system, the compressor should be provided with bye-pass valves.

**The bye-pass valves** are simply a system of valves and cross connections between the suction and discharge pipes, so arranged that the ammonia may be pumped from one part of the system and temporarily stored in another part while repairs or examinations are made.

**The purging valves** are special valves located at the top

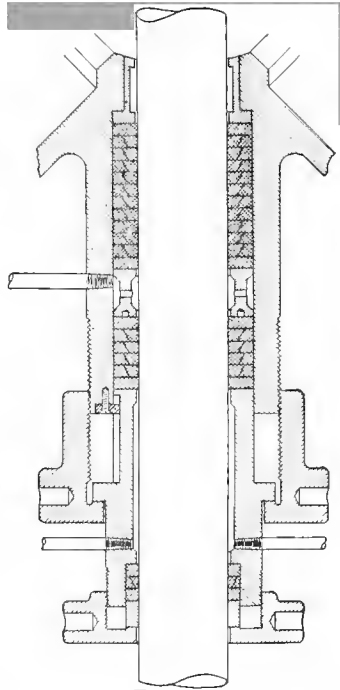

Fig. 52. Vertical section through the Vilter Stuffing Box.

of the cylinder or on the highest part of the condenser and are used to free the system of air.

**The condenser.** From the oil trap the ammonia gas passes to the condenser, where the hot gas is cooled to a temperature sufficiently low to cause it to condense. If an abundance of cool water can be obtained cheaply, the matter of condensing is very simple. In some of the large

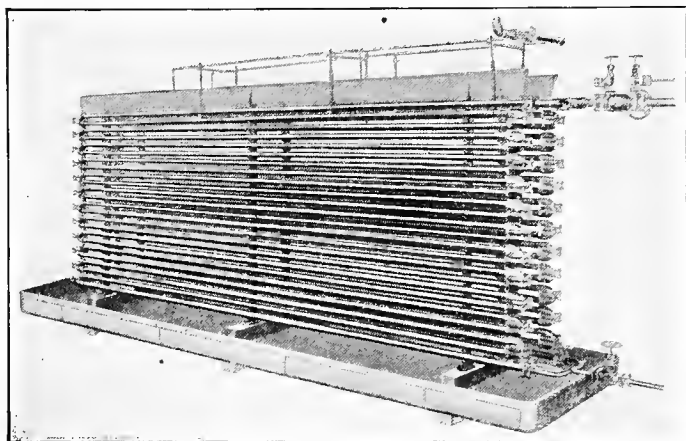

Fig. 53. The Vilter Atmospheric Condenser.

plants where very large compressors are used, the expense of water for cooling is sometimes very great. Probably the cheapest and most economical type of condenser to use under such circumstances is the open air type, which should for convenience be located on the roof of the building. This condenser consists of two parts, the first part being a preliminary cooler which is located below the liquefier. In the preliminary cooler the gas is partly cooled before reaching

the liquefier, which consists of a series of coils of pipe. These are cooled by water which is sprayed over the outside of the coils and drops down into the preliminary cooler. In this way the warmer water comes in contact with the warmest gas, but as the water is much cooler than the gas coming directly from the compressor, it is cooled considerably in the preliminary cooler.

**The submerged cooler.** In another cooling system the condensing pipes are entirely submerged, the water flowing in at the bottom of the tank and running out at the top. This is but little used, as it requires too large a volume of water.

**The double pipe system** is now used quite extensively, especially on the smaller types of machines. This type consists of a series of small pipes within larger pipes. The ammonia gas flows through the larger pipes. In this way it is exposed in a very thin layer to the cold surface of the small pipe. The hot gas enters the coil of pipes at the top and flows downward until it is condensed and runs to the receiver in a liquid condition. The cooling water enters the small pipes at the bottom and flows upward and is discharged at the top.

**The oil trap** is used to free the ammonia from oil and other impurities taken up while passing through the compressor. If but one trap is used, it is placed in the high pressure side between the discharge valve and the condenser. Except in the very small plants two oil

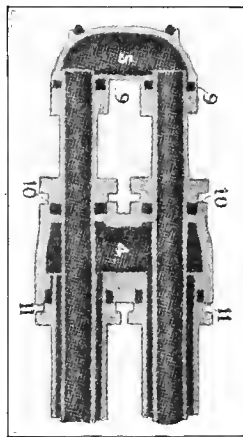

Fig. 54. The Remington Double Pipe Condenser.

traps are usually placed in the system, the second trap being located in the low pressure side of the system somewhere between the expansion coils and the induction valve.

**The receiver** is a strong iron tank into which the liquid ammonia flows as fast as it condenses. The liquid am-

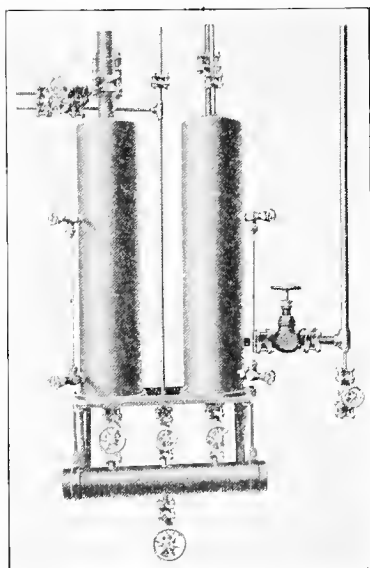

Fig. 55. The Vilter Oil Trap and Liquid Receiver.

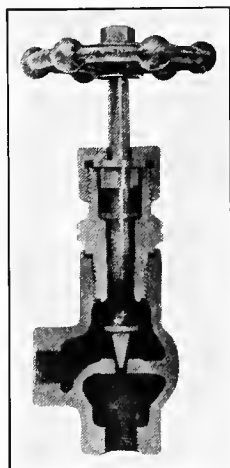

Fig. 56. The York Expansion Valve.

monia is piped from the receiver to the expansion coils where the actual work of refrigeration is accomplished.

**The expansion valve.** Between the receiver and the expansion coils is a valve known as the *expansion valve*, which is so constructed as to admit of a very fine adjustment. The flow of ammonia is controlled by means of this valve,

**The expansion coils.** It is in the expansion coils that the work of refrigeration is accomplished by allowing the liquid ammonia to enter the coils through the expansion valve. Since the pressure in the expansion coils is quite low, the liquid ammonia changes into a gaseous condition very rapidly after it passes the expansion valve. This change from a liquid to a gaseous condition entails the absorption of a certain amount of heat from the surroundings and results in a rapid lowering of the temperature in the vicinity of the expansion coils.

The refrigeration produced by the expansion of ammonia may be utilized either by the brine system or by direct expansion. In the brine system the expansion coils are submerged in a tank of brine. After being cooled the brine is pumped through pipes in the cooling room, to the brine freezers in the ice cream factory, or cans of water may be placed in the tanks of cold brine and frozen into ice. In the direct expansion system the gas is allowed to expand in coils placed in the room to be cooled. This system is used where very low temperatures are desired.

**The brine and direct expansion systems.** There are advantages in both systems; hence, the one to use will depend upon local conditions. For hardening rooms the direct expansion system must be used, but as the work of refrigeration ceases as soon as the compressor stops, it will be necessary to operate continuously. Where the compressor is to be run intermittently, the brine system has some advantages over the direct expansion system, as a large body of brine can be cooled in a comparatively short time, the compressor stopped, and the store room kept cool by circulating the cold brine. This system is well adapted to cooling rooms which must be kept at a moderately low but uniform temperature.

The brine system may be installed in the cream storage, but direct expansion would probably be found equally satisfactory. The fruit storage, can storage, and other rooms of that sort may be refrigerated by the brine system with excellent results.

**The bricking and molding rooms** should be kept at a fairly low and uniform temperature. The brine system will be found a very satisfactory method of maintaining the proper conditions in these rooms.

**Brine hardening.** Another and probably more important application of the brine system in the ice cream factory is for hardening ice creams and ices. There are two methods by which cold brine may be employed for hardening ice cream. One method is to set the cans of ice cream in a tank of cold brine and allow them to remain for 12 to 24 hours. In this method a well insulated tank is partitioned off into squares just large enough to hold a single can of ice cream. Expansion coils are located in the tank between the rows of cans. The brine is cooled by ammonia to a temperature of about zero. An agitator or a pump keeps the brine circulating around the cans to secure uniform freezing in all parts of the tank. The large cumbersome tank needed in this method of hardening may be dispensed with by using what is known as the *drip method*.

**The drip method.** In this method of hardening, the brine is cooled in a brine cooler and piped from there to the hardening room where it is sprayed over the cans of ice cream. The cans are placed on draining shelves, one above the other, and so arranged that the brine will drain away as fast as it is sprayed on the cans. This system of hardening requires less space than the brine tank method and in the opinion of many ice cream makers is one of the most effi-

cient and economical systems of hardening ice creams. For various reasons, however, these systems of hardening are gradually being replaced, particularly in the large plants, by the direct expansion or dry air hardening systems.

**The dry air hardening systems** have several advantages over the brine tank or the drip systems. In the first place, the refrigerating effect of the expanding ammonia is used in coils placed in the area to be cooled, thus avoiding a loss of efficiency due to the absorption of heat, as is likely to be the case with a large body of brine. Another advantage of the system is that it is more economical in the use of space. Where the dry air hardening system is used a large quantity of ice cream can be stored in a rather small area. Probably one of the greatest advantages of the dry air system is the fact that the storage rooms are kept perfectly dry, making it much easier to keep the air pure and sweet.

There are two dry air hardening systems. One system is known as the still air system and the other as the cold blast circulating air system.

**The still air system**, as the name implies, is operated without any circulation of air in the hardening rooms, other than that circulation due to a difference in temperature. It is claimed by some that still air is just as efficient as circulating air and does not require any kind of mechanism for circulating the air currents; nevertheless, the circulating air system seems to be the most popular and is gaining in favor.

**The circulating air system** is similar to the still air system in most respects, but the air is kept in constant circulation around the cans by means of a large fan. In this system the cold air is forced downward in a strong draft from the bunker rooms overhead, in which the expansion

coils are located. The advantage of this system is that more uniform hardening is obtained. There is little chance for the dead air to stand in the spaces between the cans. The consensus of opinion among practical ice cream men is that this system is more economical than the still air system.



## CHAPTER XV

### THE ECONOMICAL OPERATION OF THE REFRIGERATING PLANT

The economical operation of a refrigerating plant requires some knowledge of the principles of refrigeration and the properties of the refrigerating agent. It has been pointed out that mechanical refrigeration may be applied in the ice cream factory to harden ice cream, either by the brine or by the dry air process, and to cool brine for the freezers. In addition, many factories now make their own ice by artificial refrigeration. Considering the extent to which this system is employed in ice cream factories, the subject of its economical operation becomes worthy of serious consideration on the part of the ice cream manufacturer.

**Ammonia.** The whole discussion of the economical operation of a refrigerating plant centers upon the peculiar properties of ammonia. Under ordinary conditions, ammonia is a gas. It may be liquefied quite easily by compressing and cooling. The value of ammonia as a refrigerating agent is due largely to the fact that it can be liquefied at comparatively low pressures and ordinary temperatures.

**The refrigerating capacity** of a plant depends upon the number of pounds of ammonia evaporated in a given length of time. The weight of a cubic foot of ammonia gas varies with the temperature and pressure. (See Table I.) The weight to a cubic foot increases with an increase in the

pressure and temperature, and decreases as the pressure and temperature decrease. This difference in the density of the gas under different conditions should be kept in mind in operating a refrigerating plant, to avoid a loss in efficiency due to carrying too low gauge pressure on the suction side or too high gauge pressure on the compression side.

For example, if the temperature of the gas is zero degrees and 16 pounds pressure on the suction side, and is compressed to 115 pounds at 70 degrees in the condenser, it will be necessary to have sufficient cylinder capacity to handle 3.63 cubic feet of gas each minute to produce the effect of one ton of refrigeration in 24 hours. (See Table II.) If the temperature and pressure are reduced to — 10 degrees and 9 pounds respectively, it will require the discharge of 4.73 cubic feet of gas each minute to produce the effect of one ton of refrigeration in 24 hours.

**A loss in capacity** will therefore be the result of a lowering of the temperature and pressure of the gas on the low

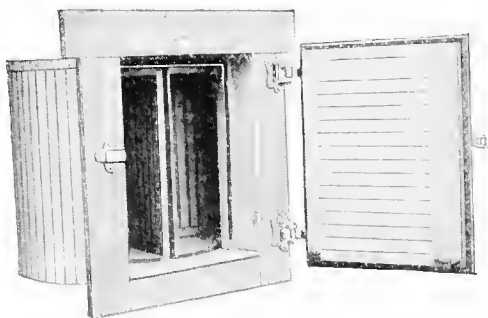

Fig. 57. The Jamison Revolving Door for hardening rooms.

pressure side. A machine with sufficient cylinder capacity to discharge 3.63 pounds of gas each minute will produce

the effect of one ton of refrigeration only when the gas is at zero degrees Fahrenheit and 16 pounds pressure on the low side and 115 pounds pressure at 70 degrees on the high side. There would be a loss of about 20 per cent. in the refrigerating capacity of the machine if the pressure on the low side were reduced to 9 pounds, because at zero degrees and 16 pounds pressure a cubic foot of the saturated gas weighs .1108 pounds, while at -10 degrees and 9 pounds pressure a cubic foot of gas weighs only .0878 pounds. It might be well to mention that the figures given in Table II

TABLE I  
PROPERTIES OF SATURATED AMMONIA  
(From Wood's Table)

Temperature	Pressure	Latent Heat	Volume of 1 Lb. of Vapor	Weight of 1 Cu. Ft. of Vapor
Degrees F.	Lbs. Sq. In. Gauge		Cubic Feet	Pounds
- 40	- 4.01	579.67	24.372	0.0410
- 35	- 2.39	576.69	21.319	0.0468
- 30	- 0.57	573.69	18.697	0.0535
- 25	+ 1.47	570.68	16.445	0.0608
- 20	+ 3.75	567.67	14.507	0.0689
- 15	+ 6.29	564.64	12.834	0.0779
- 10	+ 9.10	561.61	11.384	0.0878
- 5	+ 12.22	558.56	10.125	0.0988
± 0	+ 15.67	555.50	9.027	0.1108
+ 5	+ 19.46	552.43	8.069	0.1239
+ 10	+ 23.64	549.35	7.229	0.1383
+ 15	+ 28.24	546.26	6.492	0.1544
+ 20	+ 33.25	543.15	5.842	0.1712
+ 25	+ 38.73	540.03	5.269	0.1898
+ 30	+ 44.72	536.92	4.763	0.2100



represent the theoretical refrigerating capacity. Allowance must be made for certain losses in the transfer of heat from one substance to another, so that actual capacity of a machine will be 20 to 25 per cent. lower than the estimated capacity.

**The pressure on the low side** will depend upon the temperature that must be maintained in the brine tank or in the cooling rooms. The pressure on the low side should be carried as high as conditions will permit, because the higher the pressure carried on the suction side of the system, the more economically will the plant be operated. The pressure on the low side should be such that the boiling point of the ammonia will be 7 to 10 degrees below the temperature to be maintained in the brine tank, cooling rooms, and other places to be refrigerated. The lower the pressure on the suction side, the lower will be the boiling point of the ammonia, and the less will be the weight of each cubic foot of ammonia gas. Since the refrigerating capacity of a plant depends upon the number of pounds of ammonia handled in a given length of time, this data is of considerable importance to the operator of a refrigerating plant.

**The pressure on the high side**, however, should be carried as low as conditions will permit. The reason for this is that it will require less power to drive the compressor if the gas can be condensed at a low pressure. The pressure required will depend upon the amount and temperature of the cooling water used in the condenser. This being the case, the *cost* of water and power must be taken into consideration. Where the cost of water is very great it may be more economical to condense the ammonia at a higher pressure and use less water, even though it requires more power to operate a compressor in that way. To ascertain



the conditions under which the plant can be operated most economically, the cost of power must be checked against the cost of water.

**The type of condenser** used may have some effect upon the pressure which must be carried on the high or compression side of the system. The atmospheric condensers usually show a higher pressure than do the submerged condensers, even with the same initial and final temperatures, but the quantity of water used is small compared with that used in the other type of condenser. Another advantage of the atmospheric condenser is that where there is a tendency for the water to deposit mineral salts, the coils can be cleaned more easily because they are exposed. The disadvantage of this type of condenser, aside from the higher pressure which, as a rule, must be carried, is that they are not uniform in action, but depend to a greater or less extent upon weather conditions. That is, they work best when the air is dry, because of the rapid evaporation of water from the surface of the coils. Of course, this evaporation will not take place when the air is saturated with water vapor.

**The double pipe condenser** has displaced the atmospheric condenser in many places because it is independent of atmospheric conditions and therefore more uniform in action. The most striking advantage of the double pipe system, however, is that the ammonia gas is brought into very intimate contact with the cold surface of the condensing coils. The result is that this type of condenser is very efficient in its operation, provided the cooling water is not too warm when it reaches the condenser. The flow of water through the coils may also be adjusted to any condition of temperature and pressure.

The proper use and regulation of power and cooling water

will do much to reduce operating costs, but unless provision is made to prevent the absorption of heat at other points than those areas which it is intended to cool, the gains made in the engine room may be lost in the cooling rooms because of poor or insufficient insulation.

**The insulation** is one of the most costly and important items in the construction of cooling and hardening rooms. The greater the difference between the temperature inside the cooling room and the external temperature, the greater will be the need of sufficient insulation of the best sort.

To be a good insulator a material must, of course, be a first-class non-conductor of heat. It should also be fire and moisture-proof and non-odorous.

**The insulating materials** commonly employed are mineral wool, hair-felt, mill shavings, cork and certain special cork preparations. Dead air spaces were originally used quite extensively and are still used to a certain extent in refrigerator construction as a means of insulating. It is so difficult, however, to build in such a way as to prevent a certain amount of air circulation in what should be the dead air spaces, that the tendency now is towards solid construction. A wall so built simply consists of layers of various materials, using mineral wool, saw-dust, or cork for insulating, and pitch, asphaltum, or water-proof paint to protect the insulation from moisture. The proper protection from moisture is very important. Many substances are good insulators when dry but take up moisture readily and become wasteful because of the fact that they are not good insulators when in a moist condition.

**Cork** is one of the best materials to use because it comes very near having all of the qualities of a good insulator. It is a first-class non-conductor, is not affected by moisture,



and although it is not fire-proof, it is a very slow burning substance.

**The insulation of hardening rooms** requires special attention. In the dry air hardening rooms a temperature of about zero is maintained constantly. It requires the best of insulation, properly protected from moisture, to maintain such a low temperature economically. Eight to ten inches

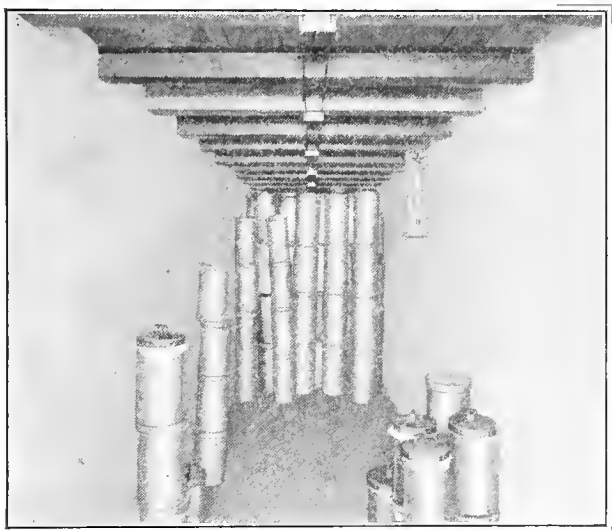

Fig. 59. Interior of a Dry Air Hardening Room.

of ground cork, cork board, or some similar insulator furnish the necessary insulation for the dry air hardening rooms. In some cases one or more dead air spaces are provided also. Water-proof paint, special kinds of paper, prepared roofing, and pitch are the substances frequently used to protect the insulation from dampness.

**Slush boxes and brine tanks** should be insulated with equal care and special precautions must be taken to protect the insulation from dampness. In all cases insulation will be found quite expensive, but economy of operation should not be sacrificed in order to reduce the cost of construction.

What has already been said regarding the operation of a compressor for cooling rooms and other ice cream refrigeration, applies also to the manufacture of ice. Since many

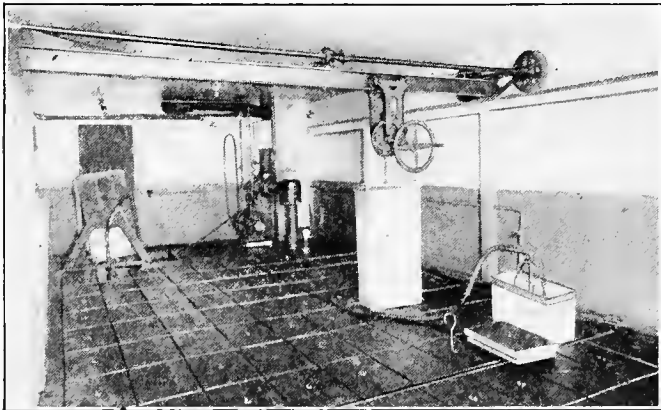

Fig. 60. Freezing Tank, Can Filler, Hoist, and Dump in an ice cream factory.

factories, both large and small, aim to make all or a large part of the ice which they use, the subject of ice making is one of no little importance to ice cream manufacturers.

**The ice making capacity of a compressor** is rated at one-half its refrigerating capacity. Theoretically, a one ton machine should make one ton of ice in 24 hours after the water has been cooled to  $32^{\circ}$  F., but in actual practice the ice making capacity of a machine is about half its re-

refrigerating capacity, because of the many unavoidable losses due to exposure of the freezing tank, loss of ice in thawing off and in handling.

**Ice cans.** The ice is frozen in metal cans which are placed in a tank of strong brine. The brine is kept cold by expansion coils connected with the ammonia compressor.

**The time required for freezing ice** will depend upon the size of the ice cans and the temperature of the brine. The following table shows the approximate time required for freezing various sizes of ice cakes at different temperatures:

TABLE III

Size of Ice Cans	Hours to Freeze 16-Degree Brine	Hours to Freeze 8-Degree Brine
4 in. x 16 in. x 32 in.	12 hours	10 hours
6 in. x 12 in. x 32 in.	20 "	16 "
8 in. x 16 in. x 36 in.	40 "	36 "
8 in. x 18 in. x 32 in.	40 "	36 "
10 in. x 10 in. x 36 in.	48 "	40 "
10 in. x 20 in. x 36 in.	54 "	48 "
11 in. x 22 in. x 36 in.	58 "	50 "
11 in. x 22 in. x 44 in.	60 "	50 "

It will be noticed that there is an appreciable difference in the time required for freezing with the brine at 8° F. instead of 16° F., but it is more economical to freeze at the higher temperature because of the greater refrigerating capacity of a machine when operated at the higher suction temperature and pressure.

**The brine solution** may be made from sodium chloride (NaCl) or from calcium chloride (CaCl<sub>2</sub>). The latter is to be preferred, especially where very low temperatures are

to be maintained. The freezing point of brine at different degrees of concentration is shown in the following table:<sup>1</sup>

TABLE IV

Pounds of salt to each gallon of water	Sodium Chloride (NaCl)	Calcium Chloride (CaCl <sub>2</sub> )
0.5	25.2 Deg.	27.5 Deg.
1.0	18.7 "	22.0 "
1.2	16.0 "	19.5 "
1.5	12.2 "	14.8 "
2.0	6.0 "	5.4 "
2.5	0.2 "	-7.8 "
3.0	-4.7 "	

For the manufacture of germ-free ice or for the manufacture of very clear ice the water to be frozen is first distilled and filtered, to remove all impurities. The time for freezing is somewhat prolonged, as this gives a clearer ice than rapid freezing. In the manufacture of ice in ice cream factories, however, these precautions are not observed, for the reason that the ice is used only for packing purposes so that its appearance and germ content are of secondary importance. Water that is pure enough for drinking purposes will do for the manufacture of ice of the quality required for packing ice cream.

**The equipment.** The most important part of the additional equipment needed for the manufacture of ice in the ice cream factory consists of a properly insulated brine tank which is divided into compartments for the freezing cans, heavy sheet metal cans in which the ice is frozen, and an

<sup>1</sup> "Modern Refrigerating Machinery."

agitator to keep the brine in constant circulation. In addition to these there must, of course, be a certain amount of other apparatus, such as an ice hoist, thawing apparatus, can filler, etc.

The brine tank is provided with necessary expansion coils of ample area. It will require approximately 100 to 125 square feet of pipe surface to each ton of ice capacity.

The agitator. The brine in the tank must be kept in constant circulation by an agitator of some sort. In small tanks a propeller-like agitator of 12 or 18 inches diameter running at about 200 revolutions a minute, or a small centrifugal pump, will insure a sufficient circulation of the cold brine around the freezing cans.

The freezing cans are made a little smaller at the bottom than at the top and hold from 50 to 400 pounds of ice, the size and dimensions of the can being varied to suit conditions. The cans are usually made of about No. 16 gauge material. The following table<sup>2</sup> shows the dimensions of different sizes of ice cans and the weight of the cakes of ice from each.

TABLE V

Weight of ice in cake	Dimensions of Can, Inside		
	Top	Bottom	Length
50 lbs.	8 in. x 8 in.	7½ in. x 7½ in.	31 in.
100 lbs.	8 in. x 16 in.	7¼ in. x 15½ in.	31 in.
200 lbs.	11½ in. x 22½ in.	10½ in. x 21½ in.	31 in.
300 lbs.	11½ in. x 22½ in.	10½ in. x 21½ in.	44 in.
400 lbs.	11½ in. x 22½ in.	10½ in. x 21½ in.	57 in.

<sup>2</sup> Haven and Dennis, "American Practice in Refrigeration."

NOTE: The brief discussion given in this chapter is intended to give the beginner a general idea of the subject. Those who desire more detailed information on mechanical refrigeration should consult some standard work. Siebel's "Compend of Mechanical Refrigeration and Engineering," published by Nickerson & Collins Co., Chicago, and "Modern Refrigeration Machinery," published by Wiley & Sons, are suggested as suitable references for students. Steven's "Mechanical Catechism," published by Laird & Lee, Chicago, and Levey's "Refrigeration Memoranda," published by Nickerson & Collins Co., Chicago, are suggested as helpful references for those who are particularly interested in engine room practice.

## CHAPTER XVI

### SCORING ICE CREAMS AND ICES

The problem of scoring ice creams and ices is a new one and presents some difficulties which are not encountered in scoring other dairy products. In the first place, the ideal flavor for ice cream is far more variable than the ideal flavor of other dairy products and depends upon the kind and amount of flavoring used and the presence or absence of other substances which blend with and modify the added flavoring material. Such a blend or combination, even if it be unintentional, is not always displeasing. Our ideal or our standard for comparison will have to be varied somewhat to make it apply in individual cases. For example, if we are scoring vanilla ice cream, its flavor must be judged according to the quality of the vanilla flavor which has been imparted to the ice cream.

**The flavor** of ice cream is so variable that it will be necessary to discuss it under several heads in order to view the subject from every angle. We shall first consider the flavors imparted by the extracts or other added flavoring material.

**The qualities of flavor** imparted by the flavoring material may be designated as *high, low, mild, harsh* or *sharp*, and *foreign*. The flavoring material itself may be of excellent quality, but if used in insufficient amounts or in too large amounts, the results will be far from satisfactory.

**High flavor** is characterized by the presence of large

amounts of the flavoring material. In some cases an excess of flavoring material will impart a sharp or a bitter flavor to the ice cream. A poor quality of flavoring may have the same effect; hence, it is quite important to determine, if possible, whether the bitter flavor is due to poor quality or large amounts of flavoring material. Poor quality of flavoring is, of course, just as undesirable as an excess of flavoring, and a reduction in score should be made accordingly.

**Low flavor**, on the other hand, may be due to insufficient or weak flavoring material and also to the flavor's being obscured by some other substance or flavoring. Certain flavors must not be heated, because of their volatile nature. Such flavoring substances, if cooked, give the ice cream a very low flavor which is difficult to classify. Low flavor, however, must not be confounded with mild flavor.

**Mild flavors** are as a rule the most pleasing and desirable. Natural flavors, such as the fruit and nut flavors, are mild and not very pronounced. If the flavor can be recognized, the ice cream should not be scored off on account of low flavor.

**Harsh or sharp flavors** are usually due to the use of inferior flavoring substances, but may in some cases result from the use of too much flavoring extract. A good illustration of this defect is the flavor obtained when quite large quantities of lemon or orange extract are used, giving a lemon or orange flavor which is due to the lemon oil entirely. Inferior and artificial extracts lack the fine, mild qualities of the high grade extracts and frequently give a very pronounced, but not pleasing, flavor to the ice cream.

**Foreign flavors** are to be considered as defects, but the extent to which ice cream should be scored off for foreign flavor will depend upon the source of that flavor. For ex-



ample, lemon juice is sometimes added to other fruit to increase the acidity. Should any of the oil from the rind of the lemon find access to the mixture it is likely to impart a lemon flavor where it is not wanted. The flavor of lemon in such a case would be a foreign flavor but not of a particularly undesirable sort. Bad flavors due to bad cream, poor gelatin, fermented syrups, overripe or unsound fruit, and rancid nuts are foreign flavors for which a larger reduction should be made in scoring ice cream.

**Fruit and fruit juices** may impart undesirable flavors to the ice cream if the fruit is unsound or the juice fermented. The naturally mild flavor imparted by sound fruit may be distinguished quite easily from the artificial flavors. An artificial flavor is not entitled to as high score as a natural flavor.

**Nut flavors** are to be judged in the same way as fruit flavors. The way in which the nuts have been prepared should also receive attention. It should be noted whether or not the nuts have been blanched, finely chopped, and evenly distributed through the ice cream.

**Syrups and sugar** may be used in excess, making the mixture too sweet, or an insufficient amount may be used, in which case the ice cream would have a flat flavor. Sometimes a sour or yeasty flavor may be imparted by the use of a syrup which has begun to ferment.

**The flavors imparted by the cream** are the most important from a hygienic standpoint. The flavor given to ice cream by good, pure cream, milk, and condensed milk is rich and creamy. Defects in the flavor of ice cream due to the use of tainted cream or milk are as a rule easily detected. These flavors are usually described as "bitter," "cowey" or "barn odors," "weedy," "sour," "musty,"

and "cheesy." These terms are in such common use in scoring other dairy products as to need but little description here. All of these flavors are easily recognized, except possibly the bitter flavor which may come also from flavoring material, nuts, or fruit. It has been pointed out elsewhere, that off flavors in milk and cream are usually associated with a high bacterial content. For this reason a large reduction should be made for these unclean flavors.

Next in importance to the flavor is the body and texture of the ice cream. There is some difference of opinion as to whether the body and texture should be judged together or be considered as two separate characters. The claim is made that the conditions which produce good body must necessarily produce a good texture.

**Body and texture**, whether considered together or separately, are of no little importance, but they are characters which are difficult to describe. In very general terms, body may be said to be that quality which gives weight and substance to the product and enables it to stand up well. Almost any one will recognize the difference in the holding qualities of different batches of ice cream at the same temperature. The ideal body is that which is produced by milk solids. Ice cream containing the proper proportion of milk solids has a certain permanence or holding quality and is firm but not sticky or pasty at low temperatures. The absence of that sticky or pasty condition is due partly to the presence of the milk solids and partly to proper swell. Ice cream which is over frozen, if it does not churn, has a heavy, pasty consistency. Such ice cream may have the permanence and holding qualities without the lightness which is characteristic of good ice cream. It is for this reason that some prefer to consider body and texture separately.

**Texture** refers to the grain or to the finer qualities of the product. A well frozen ice cream will be very smooth and light. This is the proper *texture* for ice cream.

The conditions affecting the body and texture of ice cream are the amounts of milk solids present, the presence or absence of a stabilizer, and the way in which the cream is frozen.

**The term milk solids** does not mean fat alone but all milk solids, including casein, milk sugar, and albumen. The milk solids other than fat give the ice cream a good body, a pleasing flavor, and a high food value. When properly frozen, ice cream containing a sufficient amount of milk solids will also have a very smooth texture.

**Stabilizers** are used chiefly to prevent the formation of ice crystals that give the ice cream a coarse or granular texture. Except in *granites* and *frappés*, a granular texture is very undesirable. If there is an excess of stabilizer present or if the ice cream has been frozen too long in the freezer, it will have a close, sticky texture, for which a reduction in score should be made.

**The manner of freezing** will affect the swell and therefore the texture of the ice cream. Distinction should be made, wherever possible, between a granular texture due to the absence of a stabilizer and a granular texture due to insufficient freezing or to refreezing soft or melted ice cream without agitation.

**The appearance** of the finished product will also be affected by the manner of freezing, but the term refers more to the coloring and finish of the product. Since ice creams and ices are used as a dessert, a tempting appearance is very essential. The appearance is therefore more important than its place on the score card would indicate. The points to

take into consideration under this heading are indications of good or poor workmanship, appropriate colors, uniformity in colors; and in the molded ice creams, the uniformity of layers and the clearness of outline in the molded object. The last place on the score card is given to package, but to a certain extent *appearance* and *package* must be considered together.

The **package** refers to the way in which the ice cream is packed for market. The cans should be well filled and should have a piece of parchment paper under the cover. Any indications of brine or salt under the cover, dirty parchment paper, or other indications of careless packing will detract from the score.

### Score Cards for Ice Cream

**Mortensen's** score card as given in Bulletin 123 of the Iowa station is given below.

" Flavor .....	45
Texture .....	25
Richness .....	15
Appearance .....	10
Color .....	5
	—
Total .....	100

#### " I. Flavor.

##### " Definition of Good Ice Cream Flavor

" The cream flavor must be clean and creamy, and combined with flavoring material which blends with the cream to a full and delicious flavor.

## “ Defects in Flavor

“ 1. Defects due to the use of flavors which will not blend with the other ingredients.

“ 2. Defects due to cream used:

Sour cream flavor

Old cream flavor

Bitter cream flavor

Metallic cream flavor

Oily cream flavor

Weedy cream flavor

Barn flavor

Unclean flavor

Burned or overheated flavor

“ 3. Defects in flavor due to filler used:

Condensed milk flavor

Starch flavor

Gum flavor

Gelatin flavor

“ 4. Defects in flavor due to other ingredients:

Too sweet

Lack of sweetness

Coarse flavor due to flavoring material

Stale fruit flavor

Rancid nut flavor

Moldy nut flavor

## “ II. Texture.

## “ Definition of Good Texture

“ The cream must be firmly frozen and be smooth and velvety.

### “ Defects in Texture

“ Icy. This defect is most noticeable toward the bottom of the container and may be due to improper packing or by holding too long, ice cream which was manufactured without filler.

“ Coarse. This defect may be due to the use of too thin cream, or to packing while too soft.

“ Sticky. This is due to fillers such as gelatin, sweetened condensed milk, glucose, etc.

“ Buttery. This defect is due to the use of cream which has been partially churned before freezing, or to cream which enters the freezer at too high a temperature. It may also be due to operating the freezer at too high speed or to some defect in the construction of the freezer.

“ Too Soft. Due to improper packing after freezing.

“ When judging cream containing nuts, fruits, etc., due allowance should be given for the presence of such ingredients.

### “ III. Richness.

“ Ice cream containing the amount of butter fat required by the State pure food law should be considered perfect in richness.

“ The richness is determined by making chemical analysis for fat.

### “ IV. Appearance.

“ Ice cream scoring perfect in appearance should be clean and neatly put up, and in a clean container.

“ Defects: Cream of unclean appearance; lack of parchment circle over ice cream; dirty container; rusty con-

tainer; dirty ice cream tub; old tag strings attached to handle of tub.

“ When judging brick ice creams special attention should be given to the uniformity of the layers, to the neat folding of the parchment wrapper, and to cleanliness and general appearance of the package.

“ V. Color.

“ Ice cream of perfect color is such as contains only the natural color imparted to it by the flavoring material used. If color is added it should harmonize with the particular flavoring used.

“ Defects in Color: Too high color; unnatural color such as colors different from the color of the natural flavoring material used.

“ Individual molds, if colored, should be as nearly as possible the same color as the object they represent.”

**Washburn's score card** as given in Bulletin 155 of the Vermont station is as follows;

“ Flavor .....	45
Body .....	20
Texture .....	20
Permanency .....	10
Package .....	5
	—
Total .....	100

“ *Flavor:* To be that of clean, sweet cream sweetened to taste with cane sugar; the score to be cut for any flavor of sour cream, and cut severely for any dirty flavor, and

but little if too sweet or not sweet enough, or if the added flavor is too high or low, for these are largely regulated by trade demands.

*“Body:* To be firm, mellow and slightly elastic under pressure of the finger at a temperature of 18° F. or less. It must not be rubbery or too weak.

*“Texture:* To be smooth, creamy, and free from coarse water crystals; the score to be cut moderately if too coarse, and severely if inclined to be sticky or doughy.

*“Permanency:* To have a reasonable standing-up power on an ordinary cool dish, and to offer some resistance in the mouth instead of melting and disappearing as liquid almost immediately upon being tasted.

*“Package:* To be clean, tidy, and free from evidence of slovenly workmanship.”

In both of these score cards 45 points are given to flavor, which is about a correct estimate of the importance of good flavor. Upon the other points there seems to be some difference of opinion. It seems to the authors that a compromise could be made between these two score cards which would give a more satisfactory score card.

In the first place, in judging the quality of ice cream there is little need of considering “richness” by itself nor does it follow that the ice cream which contains the amount of fat required by law is ideal. Upon this point there is a wide difference of opinion among authorities. The preference of the consumer is not unanimously in favor of rich ice cream nor are the pure food laws of the various States uniform in regard to the per cent. of butter fat which ice cream must contain.

Permanency is a quality which may well be considered



under body. Color could be considered under "appearance." By making these alterations and substitutions the score card would be as follows:

**The University of Nebraska's Score Card**

Flavor .....	45
Body .....	20
Texture .....	20
Appearance .....	10
Package .....	5
	—
Perfect Score .....	100

## CHAPTER XVII

### THE ICE CREAM FACTORY; ITS LOCATION AND EQUIPMENT

A good location for the factory is one of the first problems that confronts the person who contemplates entering the ice cream business in any locality. It is a problem which must be solved for each case separately, because no general rules will apply in all cases. The location of the factory will depend upon various local conditions such as the size of the town, class of trade to be served, location of the customers, prospects of future growth, transportation facilities, and the cost of property. A careful consideration of these and various other local problems will aid greatly in selecting an advantageous location. The next problem is the erection of a suitable building, or what is more difficult and perplexing, the remodeling of an old one to meet the needs of the proposed business.

**The interior arrangement** of the factory should be carefully planned. In a building which is specially constructed for factory purposes, the matter of interior arrangement is much simpler. It is often necessary, however, for those who are just starting in the ice cream business to make use of a building which was not constructed for factory purposes. Under such circumstances the adaptability of the building to ice cream factory purposes as well as its advantageous location must be taken into consideration.

One can find buildings of every sort and description used

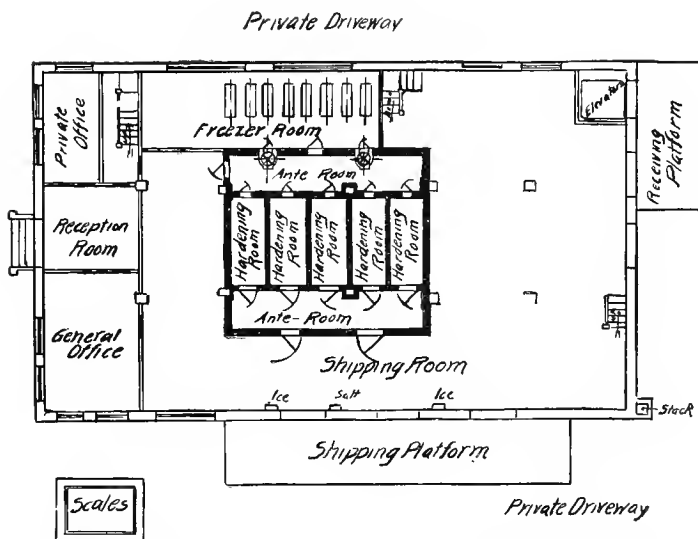

Fig. 61. First-floor Plan of a well-arranged factory.

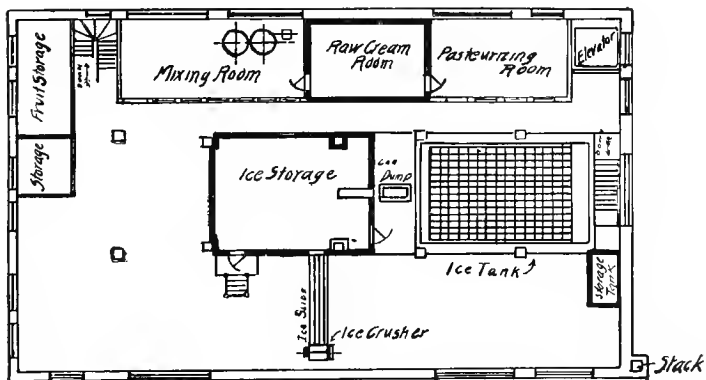

Fig. 62. Second-floor Plan of the same factory.

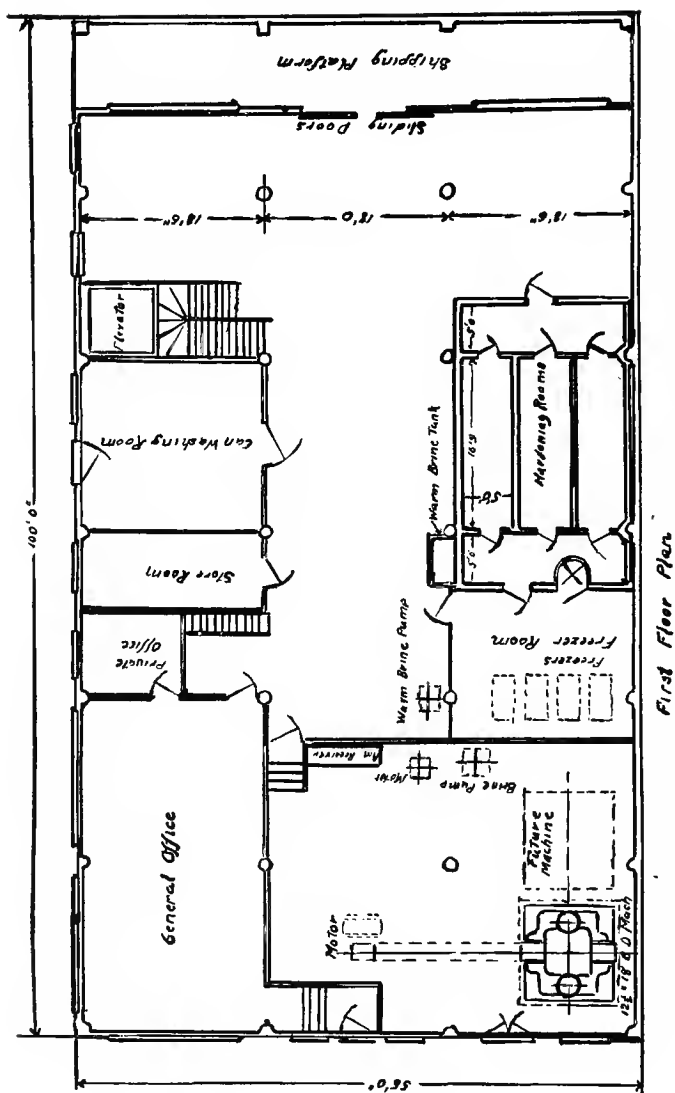

Fig. 63. First-floor Plan of a factory in which there is ample provision for future growth.

for ice cream factories, some of which are well adapted to the purpose for which they are used, while others are decidedly inconvenient and must result in a lowering of factory efficiency. To avoid such inefficiency wherever possible, the general dimensions of the building, amount of light, facilities for ventilation, and the character of the walls, floors, and the ceilings should be taken into consideration.

**The dimensions** of the building should be sufficiently

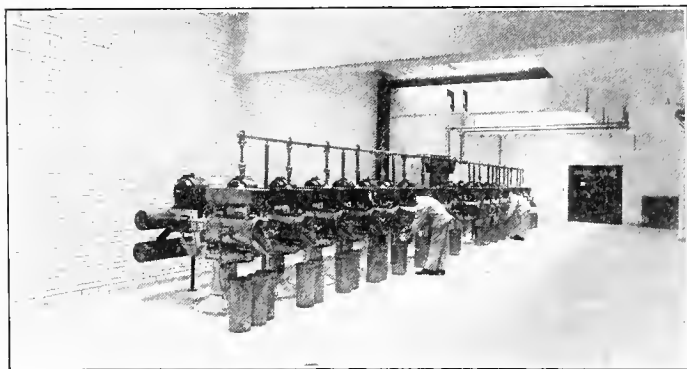

Fig. 64. Freezing Room in an ice cream factory. Note the abundance of light, good ventilation, and sanitary construction throughout.

large to accommodate all the necessary machinery with some allowance for the future growth and development of the business. As a rule it seems that a more economical use of floor space is obtained where there is not too great difference between the length and breadth of the building.

**Sanitation**, however, is one of the primary considerations in the arrangement of the factory. This necessary sanitation may be secured without making the factory a "show

plant." The sanitary measures to be observed are such as are required anywhere to facilitate the task of keeping the factory in a cleanly condition, to prevent contamination of the ice cream, and to protect the health of the employees.

**Light and ventilation** are of greater importance than some factorymen suppose. Light, and particularly sunlight, is detrimental to germ life, while darkness and dampness are favorable to the growth of bacteria and molds. A proper system of ventilation and plenty of light will do much towards keeping the factory dry and free from musty odors. Aside from the greater danger of contaminating the ice cream in a dark, damp factory, these conditions are detrimental to the health of the employees. A dry factory is a more healthful and agreeable place in which to work. In addition to light and ventilation, the construction of the floor is quite important.

**Floors** of cement are the easiest to keep clean and will not absorb odors. The floor should have a uniform slope toward a gutter or sewer trap so that water will drain off readily. Some prefer having the floors slope uniformly towards a sewer trap in the center of the room, others prefer to have the floors slope towards a gutter running lengthwise of the room. Another plan which is sometimes followed is to have the floor highest in the center with a uniform slope to all sides. The advantage claimed for such a plan is that the center of the floor where much of the work is done is kept dry. Other material than concrete may be used for floors, but the aim should be to have the floors smoothly finished and as free from cracks as possible.

**The walls and ceilings** should also be smooth and of some water-proof material so that they may be washed down

without injury or deterioration. Cracks and ledges on which dirt can accumulate should be reduced to a minimum. Walls plastered with a special cement plaster will come very near meeting all of these requirements, and if given a smooth, white finish, look neat and are durable. Enameled brick and vitrified glass may be used in place of the cement plaster. Walls constructed of these materials are very neat in appearance and easy to keep clean.

**The facilities for cleaning up** the factory after the day's run should be convenient, otherwise the work is likely to be neglected. Steam and water connections can be so arranged that all machines as well as every part of the floor can be easily cleaned.

**Simplicity** in the arrangement of storage rooms and machinery is highly desirable. Narrow passages and dark corners increase the difficulty in keeping the factory sweet and clean.

**Convenient placing of machinery** must be considered with a view to reducing the amount of labor. Improved machinery has done much to reduce labor costs, to increase the efficiency of help, to affect a saving in time and material. The advantages accruing from the use of modern machinery may be lost or greatly impaired by an inconvenient arrangement of the machinery and storage rooms. Such practices as carrying cans from one end of the factory where they are stored, to the freezer which may happen to be at the other end of the factory, or locating the freezers at a needless distance from the hardening rooms, entail an unnecessary waste of time and energy which can be saved by a little forethought. On the other hand, the machinery must not be crowded together so closely as to hamper the workmen or to make the work of cleaning up more difficult.

**The storage rooms** for sweet cream, fruit, and other materials used in the mix should be so arranged that the batch mixers can be located near the place where these substances are stored. Such an arrangement greatly reduces the labor involved in getting the various ingredients into the mixers. The aim should be to have every article kept convenient to the place where that article is to be used.

The importance of the proper location of storage and hardening rooms is patent to any practical ice cream maker, but when it comes to the location of the wash room there is evidence of a tendency to overlook the importance of a well equipped and properly located wash room. Of course, circumstances differ in the different factories and must therefore govern the choice of location under various conditions.

**The importance of thorough cleansing and sterilizing** of utensils must not be ignored. The practice of placing the washing and sterilizing apparatus in any odd corner in order to economize in the use of floor space is not desirable. More or less water is sure to be spilled over the floor around the vats in which the cans are washed. To keep such a place from becoming foul there should be an abundance of light and good ventilation. A visit to a number of different factories will reveal the fact that there is no uniformity of practice in regard to the proper location for the wash room. In many factories it will be found on the main floor or even on an upper floor in a well lighted, drained, and ventilated room. In other factories it will be found in a dark corner of the basement with but little light and ventilation. While the ideal location for the wash room is not necessarily the second floor of the factory, still it is easy to see that utensils washed in a dark, sloppy room



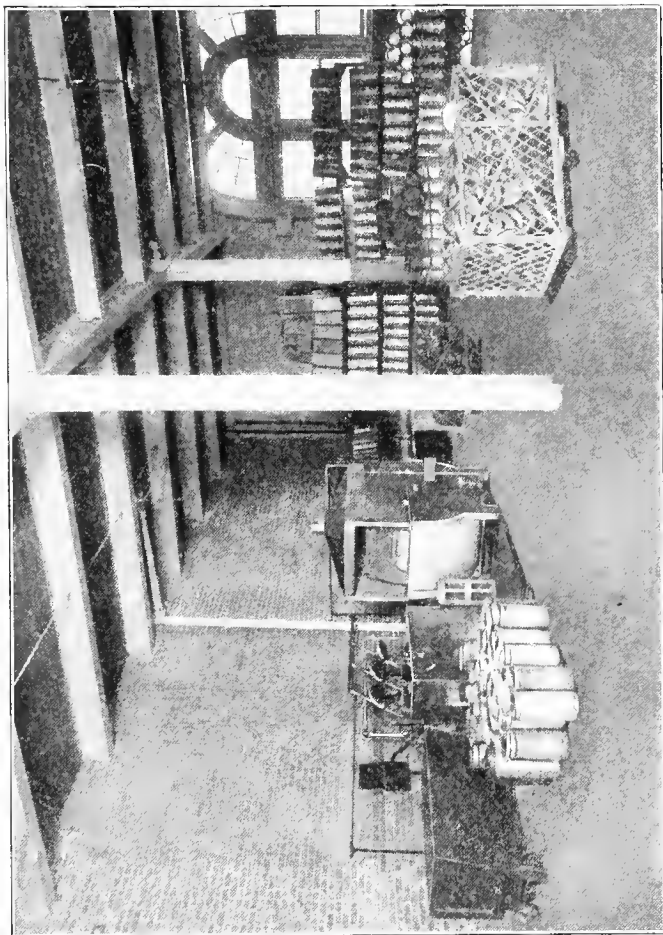

Fig. 65. Spacious Can Washing and Sterilizing Room.

are not likely to receive as thorough cleansing as would be the case if the wash room were located in a more cleanly and healthful location.

The object to be kept in mind throughout should be to so arrange one part or department in relation to all others that the product will be passed through the various departments by the shortest possible route. In other words, the process from the receipt of the raw material to the delivery of the finished product should be carried out without crossing operations. To this end certain operations are best carried out in a certain part of the factory. For example, the weigh can, sample jars, sample dippers, and other apparatus needed in sampling and grading milk and cream are usually found convenient to the place where the milk and cream are taken into the factory.

**The weigh can** or the scales upon which milk and cream are weighed are usually on the receiving platform, but where the scales cannot be so located without causing confusion or interference with some other operation, the weighing may be done elsewhere. In some factories the milk and cream are put on an elevator and taken to the upper floor at once where they can be weighed, sampled, and graded without interfering with any other operations. Under such circumstances, the pasteurizers, coolers, homogenizers, cream storage, and other equipment for the care and handling of the cream will be found on the second floor also.

In some factories the testing apparatus will be found near the place where the receiving, sampling, and grading are done. Such an arrangement does away with the necessity of carrying samples and sample jars from one part of the factory to another.

For some pieces of machinery there may be several locations, any one of which may be selected. For example, the use of conveyors, cream pumps, and similar apparatus gives one some latitude in placing such machines as pasteurizers and homogenizers.

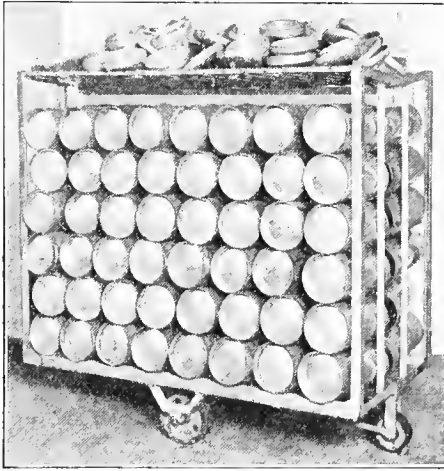

Fig. 66. A Duke-Doyle Can and Top Truck. A labor-saving device for ice cream factories.

**The pasteurizer and cooler** may be located convenient to the receiving platform so that the milk or cream as it is received is dumped in a large receiving vat from which it flows to the pasteurizer. From the pasteurizer the milk or cream runs over a cooler and from thence into holding vats in the cream storage rooms. Where these different machines can be so located that the cream flows from one to the other by gravity, there is but little piping to keep clean.

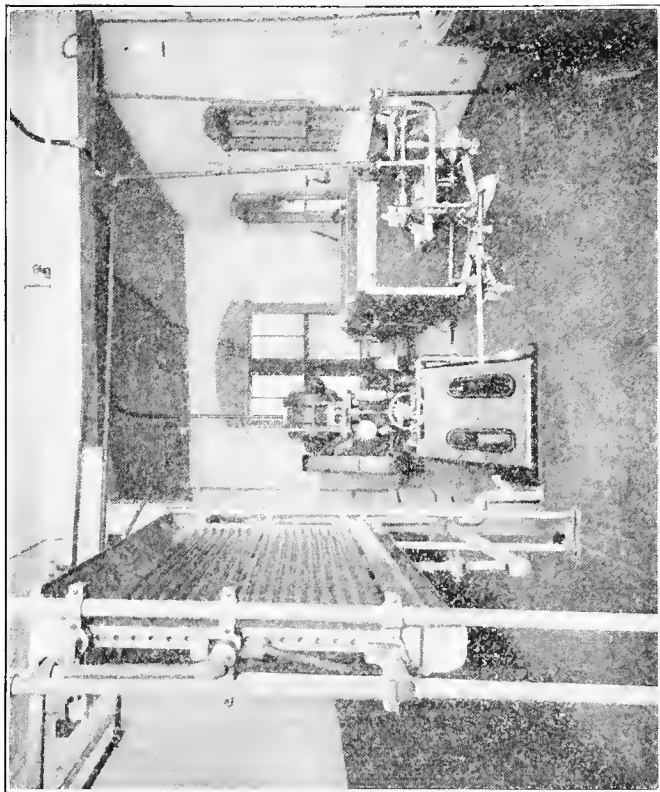

Fig. 67. Vat Pasteurizer, a Homogenizer, and Cooler in place.

This is an advantage which should not be overlooked. In many factories, however, the pasteurizer and cooler must be used for other purposes than pasteurizing cream for

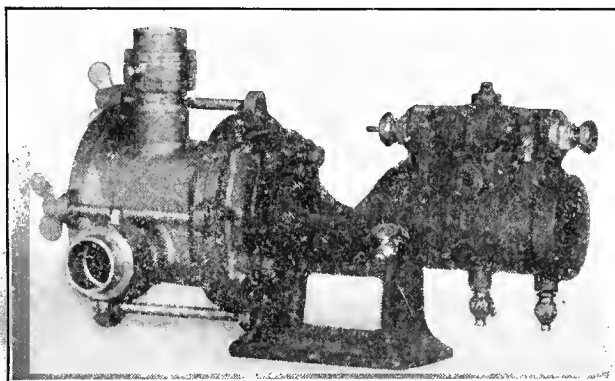

Fig. 68. The Burrell Sanitary Milk Pump.

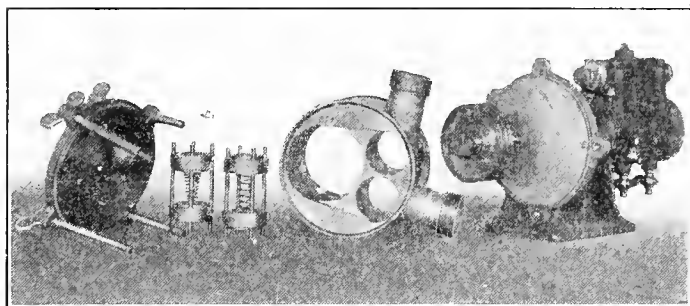

Fig. 69. The Burrell Sanitary Milk Pump taken apart for cleaning.

ice cream. In such factories the location of the pasteurizer and cooler will depend upon the importance of the other line of business which requires the use of these machines.

Where it becomes necessary to elevate cream to a floor above, the cans may be placed on a conveyor or on an elevator and taken up in that way, or the milk or cream may be emptied into a vat on the main floor and then elevated by means of a pump. There are advantages in both methods. In the first method the pump and piping are dispensed with, but it often requires more lifting and transferring of the cans of cream. If it is necessary to have the wash room on the second floor, also, there is an added advantage to this method since the cans must be brought up any way. The use of a pump and piping makes it possible to do the receiving, sampling, and grading of cream on the main floor with but little handling of the heavy cans of cream. It is also a more rapid method of handling milk and cream. The results obtained by this method are very satisfactory so long as the pump and piping are kept clean by regular washing and sterilizing. The only kind of piping to use for such purposes is the seamless, sanitary piping. This piping should be in such lengths that it will be easy to handle and to keep clean.

**The batch mixers** are best located near the rooms in which the sweet cream is stored. They are frequently located on the floor above the freezers. This is a very convenient arrangement, since it permits the mix to flow to the freezer by gravity. Pumps or compressed air may be used to transfer the mix from the mixers to the freezers. Some such method must be adopted where the mixers and freezers are on the same level. The kettles for preparing the cooked mixtures and for melting gelatin should be somewhere near the batch mixers.

**The freezers** are best arranged in batteries convenient to the hardening rooms so that the work of transferring



Fig. 70. Convenient arrangement of Batch Mixers, Kettles and a Drip Saver in the mixing room.

from the freezers to the hardening rooms can be done rapidly.

**The hardening rooms** may be built with a double vestibule, in order that the ice cream from the freezers can be introduced at one end and the hardened ice cream removed for shipment from the opposite end. Where the hardening rooms are arranged in this way the shipping department is best located at or near the hardening rooms opposite the freezers.

**The shipping department** should be located in such a way that it will be convenient to load the delivery wagons. In connection with this department there must be ample space for the storage of ice, and an ice crusher, and storage space for empty tubs.

Beyond these general considerations, the interior arrangement of the factory must be planned according to the local conditions. Improper and inconvenient arrangement of machinery and equipment increase operating expenses. In many instances a slight rearrangement will make it possible to do the same amount of work with less help. Another very important point to keep in mind in planning an ice cream factory is the prospect of future growth. It is not a wise policy to build and equip an up-to-date factory without making some provision for an increase in the volume of business at a future date.

**The kind and amount of machinery** needed for an ice cream factory will depend upon the size of the factory and its location. In ice cream making as in all other manufacturing, improvement in machinery and methods has gone hand in hand with the development and expansion of the industry. Except in the very small plants, the machinery installed should be of the most modern type. Such ma-





Fig. 71. The Shipping Department in a large ice cream factory.

chinery is expensive, of course, but a properly constructed factory, equipped with the necessary machinery of modern type, properly placed, will account for fully 50 per cent. of the factory efficiency.

For a factory capable of producing about 500 gallons of ice cream a day, the machinery needed would be about as follows:

1 Continuous freezer, capacity 150 gal. an hour, or two batch freezers.

1 10 gal. tub freezer with extra can and tub.

1 100 gal. mixing vat.

1 Ice crusher.

1 4 to 6 H. P. motor.

1 10 H. P. steam boiler.

1 Cream separator.

1 Babcock testing outfit.

1 Platform scale.

1 Pasteurizer.

1 Cooler.

1 30 qt. double boiler.

2 Insulated storage boxes for ice cream (500 to 800 gal. capacity).

1 Insulated storage box for cream and milk (500 gal. capacity).

350 5 gal. tubs.

100 3 gal. tubs.

50 2 gal. tubs.

40 1 gal. tubs.

30  $\frac{1}{2}$  gal. tubs.

450 5 gal. cans.

125 3 gal. cans.

75 2 gal. cans.

50 1 gal. cans.

40½ gal. cans.

Brick tanks and individual mold cans according to the demands of the trade.

75 to 100 individual molds.

6 2 gal. sectional molds.

24 1 qt. brick molds.

Miscellaneous apparatus, including such articles as a fruit press, food chopper, mortar and pestle, measures and graduates, egg beater, syrup gauge, mold filler, etc.

The list given above is intended as an aid to those who are not familiar with the equipment of a modern ice cream factory. It will have to be modified somewhat in order to meet the needs of different localities. In some cases such things as the separator, pasteurizer, and cooler will not be required. Some may not like the continuous freezer, and others, in very small factories, may feel that the small volume of business done will not warrant the installation of anything but a tub freezer. All things, including present demands and future prospects, must be taken into consideration in selecting the equipment for an ice cream factory.

**The ice cream freezer**, which is one of the most important pieces of equipment, is now manufactured in several types. The oldest and most familiar type is the upright tub freezer. These freezers are well adapted to the needs of small ice cream factories or to the manufacture of ice cream in connection with some other line of dairy manufacturing. For a plant making over 150 gallons a day it will be found more economical as a rule to use one of the more modern freezers.

**Brine freezers** are so called because cold brine instead of an ice and salt mixture is the refrigerating agent used.

These freezers are of several types, some of which are continuous in their operation, and others are known as intermittent or batch freezers.

The **continuous freezer** is so constructed that the unfrozen mixture is introduced at the same time that the

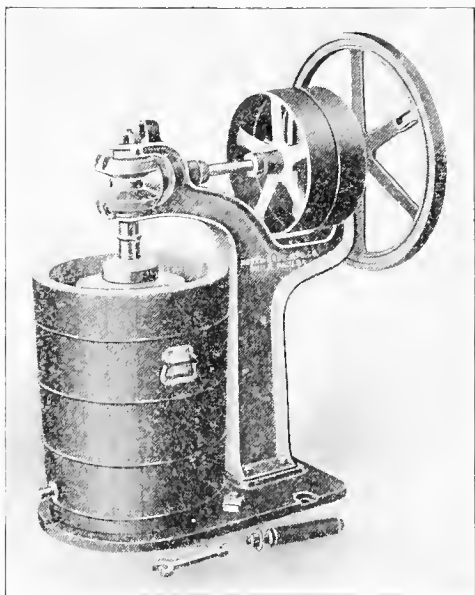

Fig. 72. One of the larger Tub Freezers.

frozen ice cream is being discharged. One of the most common types of continuous ice cream freezer is the disc type in which the necessary agitation is given by a series of rapidly rotating discs. These discs are hollow and the cold brine is kept circulating through them. A series of scrapers remove the ice cream as fast as it freezes on the

discs. Above the discs and at one end of the freezer is a worm which works out the frozen ice cream. The mix is introduced at the opposite end of the freezing chamber and is frozen as it passes through the machine.

The batch freezers using cold brine as a refrigerating agent are made in several sizes and with considerable modi-

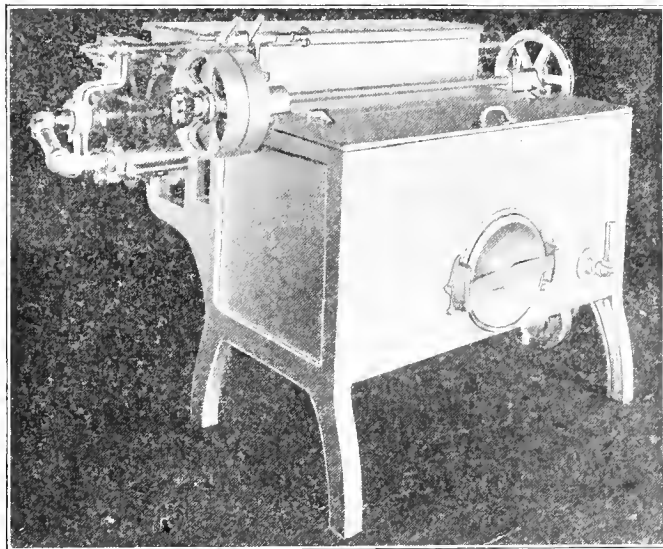

Fig. 73. The Disc Continuous Freezer.

fication of structure. These machines are made in both the horizontal and vertical type. The horizontal machines are used very extensively. They have a large freezing surface for their capacity, a fact which makes it possible to operate them satisfactorily with brine at a slightly higher temperature.

In selecting an ice cream freezer it should be remembered that they all work for and aim to accomplish the same thing. The points to be considered particularly are durability, capacity, and efficiency.

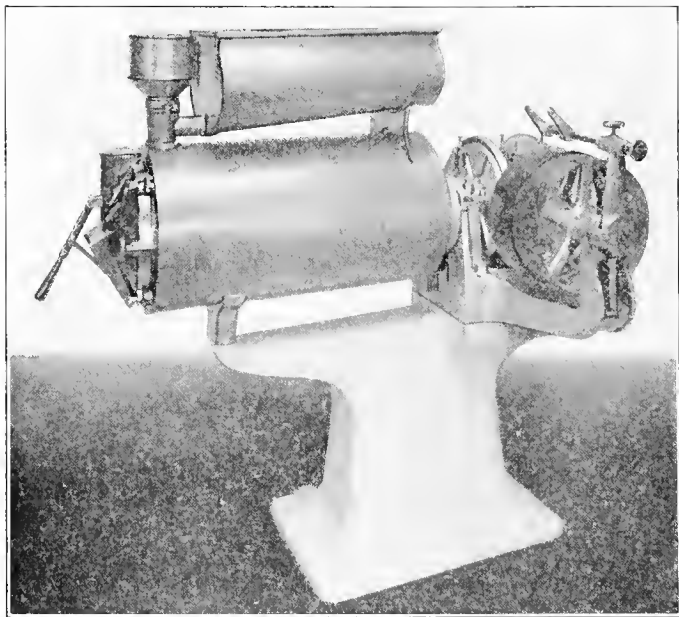

Fig. 74 The Ft. Atkinson Freezer.

**Durability and capacity.** An ice cream freezer must be made of good material, otherwise the joints will become leaky, the parts exposed to the action of the brine will become corroded, and the life of the machine will be short. Simplicity in construction is highly desirable in order that the machine may be easily cleaned. A machine in which

every part is accessible for cleaning or that can be taken apart and assembled quickly is sure to be taken care of better than one which does not possess this advantage in construction. The walls of the freezing chamber must be heavy enough to stand the pressure of the brine which is circulated in the brine chamber. In the tub freezers, the

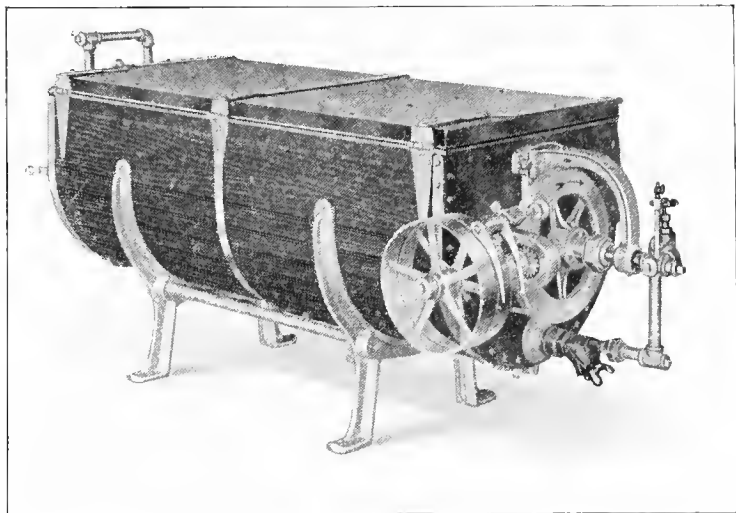

Fig. 75. A horizontal Batch Mixer.

can must be heavy enough so that there is no danger of denting it when the ice and salt is packed around it.

The freezer selected must be of ample capacity so that an unexpected demand for ice cream can be taken care of without crowding the capacity of the machine too much.

**The efficiency of a freezer will depend upon its construction and the material of which it is made. The sur-**

faces through which heat must be conducted are usually made of copper because that metal is a good conductor. Other surfaces through which heat is not to be conducted should be protected by insulation. The best type of a tub freezer is one having a heavy copper can and a substantial cedar tub. The tub must be strong enough to stand the hard usage to which it is subjected and thick enough to serve as an insulation to reduce the absorption of heat from the outside.

In selecting a brine freezer the number of wearing parts, the number and strength of gears, and the construction

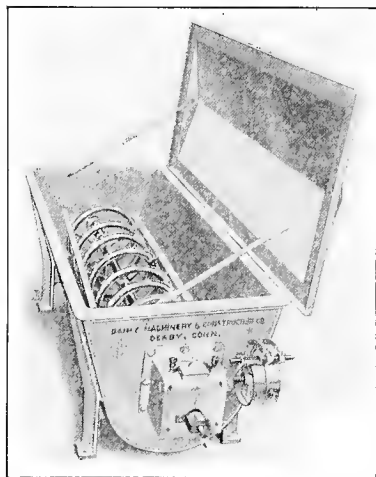

Fig. 76. A Progress Batch Mixer.

of the stuffing boxes are points that should also be taken into consideration. Few wearing parts and simple power transmission are always desirable. Brine freezers are more complicated and many of them have more wearing parts than the old tub freezers. One of the greatest sources of trouble with these machines is the stuffing boxes. The stuffing boxes should be so designed that the packing can be kept well set up to prevent the brine from leaking through and corroding the bearings. Provision must be made for keeping all bearings thoroughly lubricated.

The best results are obtained from any freezer only



when the temperature of the mix is reduced to the proper point before it is put into the freezer. A perfect control of temperature, and thorough mixing are obtained by using a properly constructed batch mixer.

A batch mixer of some sort must be used in any place where ice cream is made. The things which a batch mixer should accomplish are a uniform cooling of the mix and a uniform mixture of the various ingredients. These machines are made in various types and with a capacity of 100 gallons and over. Some of these machines resemble the ordinary cream ripener in which the agitation is produced by a rotating hollow coil through which the cooling water flows.

Another type is the upright mixer in which the cooling water is circulated in a water jacket around the vat which holds the mix. The agitation is produced by a two blade agitator located at the bottom of the vat. This agitator prevents the sugar from settling to the bottom. The entire machine is well insulated to insure a more economical use of the cooling water.

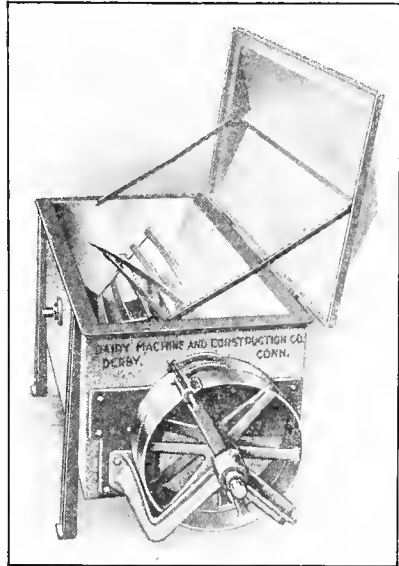

Fig. 77. A small size Progress Mixing Vat.

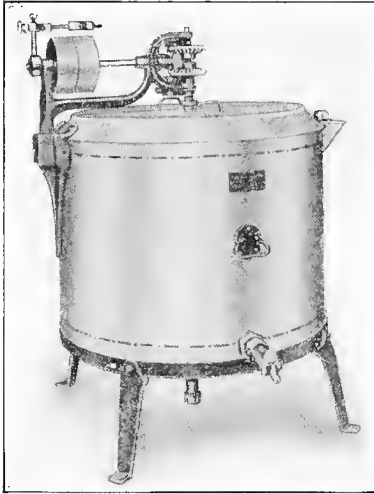

Fig. 78. A Perpendicular Batch Mixer.

The ice crusher is a very important part of the equipment whether the plant is equipped with brine freezers or not. The various makes of ice crushers are very similar in design. Practically all of them are so made that the machine can be set to crush the ice into pieces of any desired size. Not only is the ice crusher a labor saving device, but by crushing the ice into pieces of uniform size the results obtained both in freezing and packing are more uniform and satisfactory.

For small factories, where the volume of business will not warrant the installation of a large batch mixer, a small starter can may be used instead with very satisfactory results. These cans are fitted with a water jacket and agitator giving a fairly good control over the temperature. These cans may be obtained in sizes from ten gallons up and are well adapted to use in the small factories.



Fig. 79. A small Victor Starter Can which may be used as a Mixer.

**Can washers.** Where any great volume of business is done, the expense of washing cans is considerable and the results are often unsatisfactory, as it is sometimes difficult to

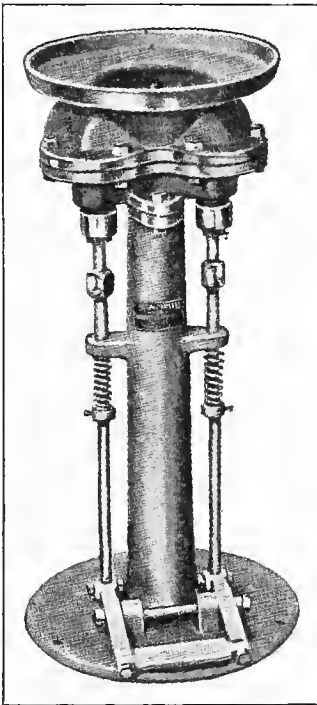

Fig. 81. The Danforth Sterilizer.

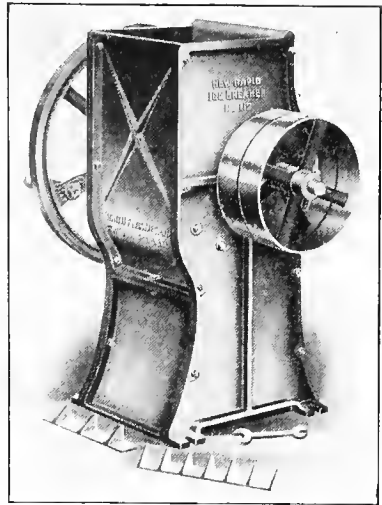

Fig. 80. An Ice Crusher.

obtain help that will do this kind of work thoroughly. There are a number of different kinds of can washers on the market which have proved quite satisfactory. When used in connection with a sterilizer and drier these can washers will be found a great help in solving the labor problem and insuring perfect cleansing of the packing cans.

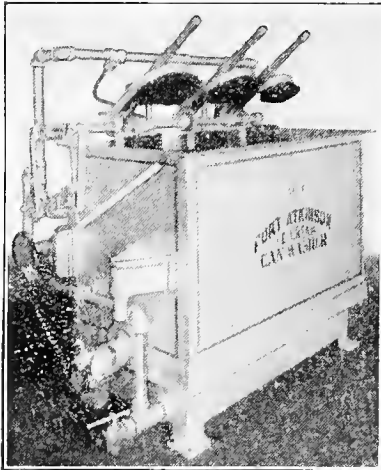

Fig. 82. The Ft. Atkinson Ice Cream Can Washer.

an apparatus for rinsing, sterilizing, and drying may be used. The rinsing may be done by inverting the can over a water jet. The sterilizing may be done either by steam or scalding water. One type of sterilizer, which is practically automatic in its operation, uses hot water in which the wash water is rinsed off and the cans sterilized as they pass through the machine. The hot cans dry quickly, but in many factories the drying is hastened by inverting each can over an air blast. Sterilizing and drying not only destroy germ life but prevent the cans from rusting and thus prolong their period of usefulness.

**Sterilizer and drier.** Any one who has watched the operation of can washing in any establishment knows that before many cans have been washed the water is very impure, and very frequently the help entrusted with this work do not realize the importance of properly rinsing and draining each can. To overcome this difficulty,

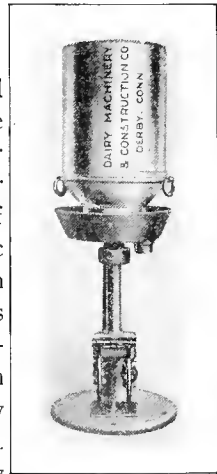

Fig. 83. The Progress Milk Can Sterilizer.

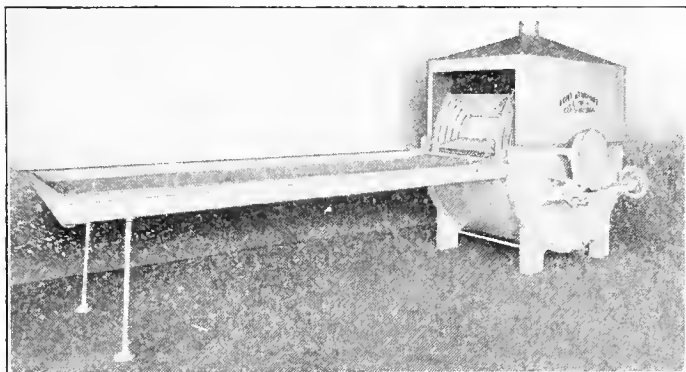

Fig. 84. The Ft. Atkinson Sterilizer.

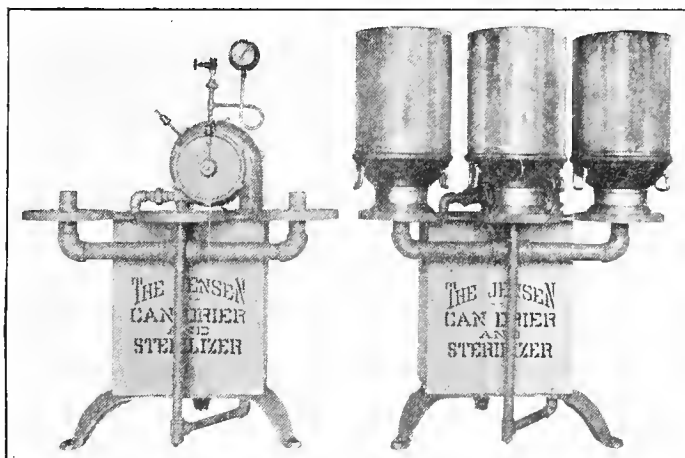

Fig. 85. The Jensen Can Drier and Sterilizer.

**Kettle for Neapolitan ice cream.** Another piece of apparatus which is quite important is the kettle for cooking Neapolitan ice cream mixtures. These kettles may also be used for other purposes, such as preparing simple syrups and

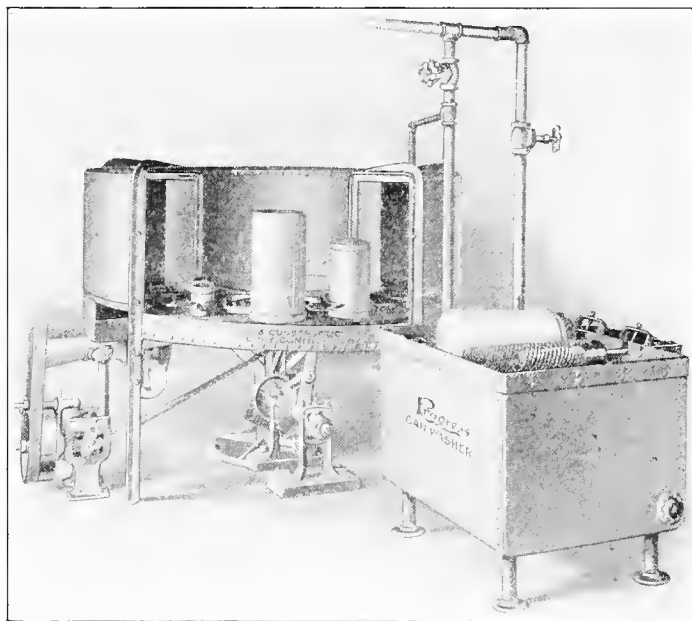

Fig. 86. The Progress Ice Cream Can Washer and Sterilizer.

for melting gelatin. Although the demand for cooked cream is small as compared with the demands for uncooked cream, every well regulated factory should be provided with this piece of equipment. The kettle may be made especially for that purpose, but any kind of arrangement whereby the mix is heated over steam or hot water will answer the purpose.

For small factories a double boiler will do very well. The special kettles are made with a steam jacket. In one type, the steam is generated by a furnace or a gas jet under the kettle. A more common type is the one in which the steam is supplied by the regular steam boiler.

The apparatus and equipment thus far discussed may be considered as essential to both large and small factories. But machines, such as the homogenizer, for instance, are confined to fairly large establishments.

**The homogenizer.** The modern homogenizing machines are of two types. In one type the machine is provided with

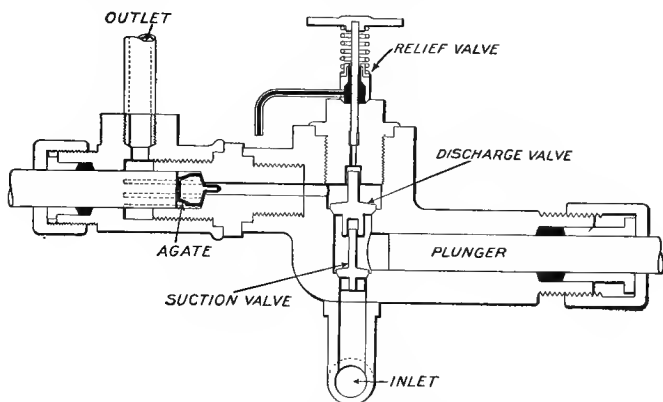

Fig. 87. Longitudinal section through the Gaulin Homogenizer, showing the agate valve. See also Fig. 25.

an accurately seated agate valve which is held in place by a strong spring. The pressure from a series of pumps forces the valve open and the mixture escapes through the small aperture. In passing through the aperture under

high pressure the fat globules are broken up and distributed through the liquid. In the other type of machine the aperture through which the mixture passes is fixed and will not vary with the pulsations of the machine. The homogenizing is done by forcing the mixture through grooves which are arranged radially in discs. The fat globules are thoroughly broken up in passing through this rigid aperture.

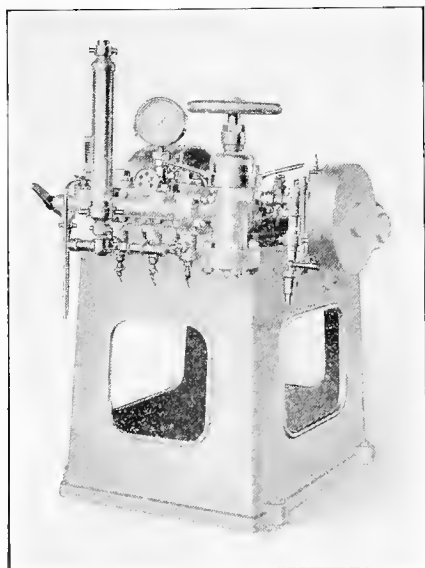

Fig. 88. The Progress Homogenizer.

Ordinary cream after passing through a homogenizer is more viscous and gives a better bodied ice cream than cream which has not been so treated. The most attractive feature of this machine to the ice cream maker, however, is that



a mixture of unsalted butter, skim milk powder, and water can be made into cream by passing the mixture through the homogenizer.

Cream which has been properly homogenized does not churn readily, and being more viscous than cream which has not been homogenized, is valuable alike for ice cream making and for whipping purposes.

**The emulser.** There are now a number of machines on the market variously known as emulsers, emulsifiers, converters, creamers, and cream makers which combine the butter fat and milk serum so thoroughly as to prevent further separation. A mixture containing the proper proportions of unsalted butter and milk after passing through an emulser has all the properties and appearances of fresh cream. In some of these machines the fat globules remain unchanged,

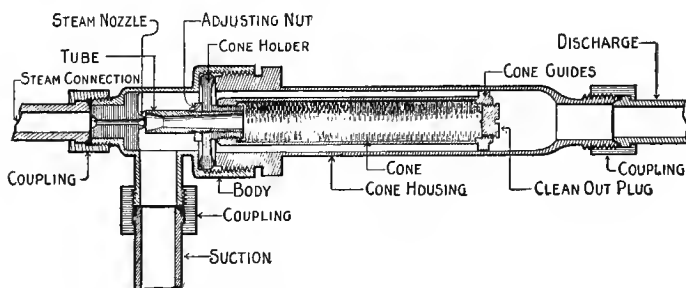

Fig. 89. A sectional view of Hawk's Emulser.

while in others quite a large percentage of them are broken up. The cream made by these machines can be whipped, frozen, or churned the same as ordinary cream.

The emulser is one of the very recent adaptations to the ice cream business. Since these machines are less expensive

than the homogenizers, they are therefore within the reach of smaller concerns.

Emulsers are of two general types; in the one the emulsification is effected by forcing the ingredients through very fine crevices by means of centrifugal force. In the other type, steam is used in various ways.

**Hauk's emulser** is one of the machines in which steam is used. Steam is discharged through a small nozzle into a tube, creating a vacuum. The ingredients are drawn into the emulser by the vacuum and forced with considerable pressure through the tube into a chamber, called a cone. The cone of the machine is made of specially constructed woven wire of fine mesh. The flow of the mixture through the machine is retarded by this cone. The agitation to which the mixture is subjected in passing through this machine is such that when it leaves the emulser the mixture is completely emulsified. A considerable number of fat globules are broken up by this machine. The extent to which the fat globules are broken up will depend upon the steam pressure.

The standard to which the emulser proper is connected contains a water trap of very unique design. The water trap is so constructed that only pure, dry steam is allowed to enter the emulser with the mixture. The condensation from the steam which enters the mixture amounts to about one pint in eight gallons of the finished product.

**The Dewitt and McCaddon converter** is also a steam emulser. To install and operate one of these machines, select a place as near the steam line as possible. If the converter must be located more than 20 feet from the boiler, the steam pipe should be covered with asbestos. Run a three-fourths inch steam line to the point where the

converter is to be installed. Put on a steam valve; reduce the three-fourths inch steam line at this place to fit the three-eighths inch steam inlet on the converter. On the top of the converter screw in a half inch "T" with a fourth inch side outlet. Use a fourth inch syphon and a small steam gauge. Take a 1 inch pipe long enough to elevate the cream into the cooler or vat and bend it in a semi-circle. Screw one end of the pipe into the "T." On the other end place a straight 1 inch water or steam cock. (9 in Fig. 90.)

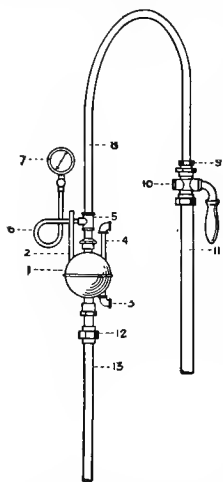

Fig. 90. The DeWitt & McCaddon Converter. (1) body of the converter; (2)  $\frac{3}{8}$  inch steam outlet; (3)  $\frac{1}{4}$  inch water inlet; (4)  $\frac{1}{4}$  inch water outlet; (5)  $\frac{1}{2}$  inch T; (6)  $\frac{1}{4}$  inch syphon; (7) steam gauge; (8)  $\frac{1}{2}$  inch discharge pipe; (9) 1 inch to  $\frac{1}{2}$  inch bushing; (10) 1 inch straight water cock; (11) 1 inch pipe; (12)  $\frac{3}{4}$  inch union; (13)  $\frac{3}{4}$  inch suction pipe.

Below the 1 inch cock use inch pipe of any length needed to convey the cream to the receiving vat. Put a three-fourths inch suction pipe on the bottom of the converter. Make the necessary water connections at the top and bottom of the converter. (3 and 4 in Fig. 90.) The machine is then ready to operate.

To begin operations, turn the steam on slowly. The emulsion will be drawn up into the converter, and forced out through the pipe. When the full head of steam has been turned on, partially close the water cock so that the pressure gauge above the converter registers at least ten pounds. With this pressure the converter will

give good results. The valve may be closed still more, making the gauge register higher. A pressure as high as 22 pounds will do no harm. The manufacturers advise operating at about 15 pounds pressure. The operator will soon learn which gives the best results, as the pressure varies according to the altitude of the place where the converter is used.

All the connections must be air tight, and the steam pressure not less than 80 pounds. The gauge above the converter must register at least ten pounds; cold water must circulate through the machine while it is in operation. The temperature of the emulsion should not exceed 130° F.

The steam emulsers described above are quite different from the centrifugal machines. The DeLaval Emulser and the Cooksley Creamer are good representatives of the machines of the centrifugal type.

The DeLaval emulser resembles a centrifugal separator. Instead of



Fig. 91. The DeLaval emulsifier discs partially cut away to show the interior construction.

(a) Feed shaft; (bb) the annular chambers; (c) crevices through which the mixture is discharged. See also Fig. 23.

a bowl, however, the emulser has a rotating, emulsifying device. The emulsifying mechanism consists of a series of chambered steel discs mounted one upon another around a central feed shaft. The mixture to be emulsified enters the machine through the feed shaft and is distributed to the chambered discs. The centrifugal force in the emulser discharges the mixture through the very fine crevices between the discs. The mixture is emulsified in passing through these small apertures.

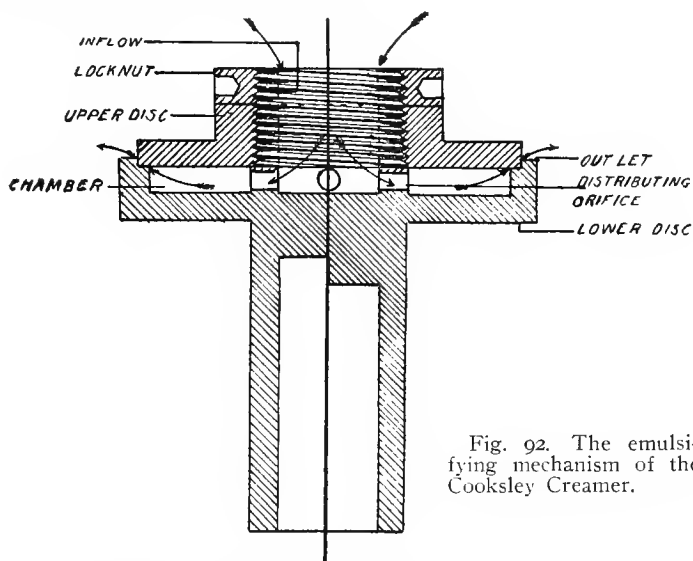

Fig. 92. The emulsifying mechanism of the Cooksley Creamer.

The Cooksley Creamer consists of a mixing vat, a centrifugal emulsifier, and a cooler. The melting vat in which the mixture is prepared and pasteurized is elevated above the centrifugal machine so that the mixture flows by gravity to the creamer and from thence to the cooler. No pump

and but very little piping is required for these machines.

The emulsifying mechanism consists of two heavy steel discs held together by a lock nut. This device rotates at the rate of about 12,000 revolutions a minute. The mixture enters the emulser at the top and is distributed to the chamber around the feed shaft. The pressure within the rapidly revolving emulser forces the mixture through the small aperture between the discs. The fat is reduced to small globules and evenly distributed through the milk serum.

Since the emulsers are all quite simple in construction and can easily be taken apart, it is not a very difficult matter to clean and sterilize the parts that come in contact with the mixture. The substance to be emulsified is first heated to a temperature of from 140 to 180 degrees.<sup>1</sup> In other words, the mixture is pasteurized before it enters the emulser. If the machine has been properly cared for it will not be necessary to pasteurize the cream again.

According to Prof. F. W. Bouska, in preparing the mixture for any of these machines, it is best to put the desired amount of butter in the cold milk rather than to add the butter after the milk has become quite warm. The reason for this precaution is that the butter is sometimes quite acidic. If such butter is placed in very hot milk, there may be sufficient acid present to cause a partial curdling of the mixture before the butter is evenly distributed. The difficulty is easily overcome by allowing the butter to melt and mix more slowly with the skim milk.

<sup>1</sup> The temperature to which the mixture is heated may vary somewhat with the different emulsers. The manufacturers of the Cooksley Creamer recommend heating only to 140° F. because the mixture is held for a time before it is emulsified. For the DeWitt & McCaddon Converter the temperature of the emulsion should not be over 130° F.

## CHAPTER XVIII

### FACTORY MANAGEMENT

Within comparatively recent years the ice cream industry has grown from a small caterer's business to a large factory system. Conditions and ideas are changing; new methods are being tried out and adopted or rejected according to their merits. The system of management that brought success and profit a few years ago will not prove satisfactory under present conditions. This transition from such an insignificant beginning to the present well organized and growing industry has been aided by the great improvements which have been made in ice cream machinery. The result of this improvement in methods is shown by the fact that the price of the manufactured product has been reduced while the cost of raw materials has actually increased. A factory equipped with old style apparatus can not compete on equal terms with a modern factory under present day conditions. The business methods followed have not in all cases kept pace with the improvements that have been made in machinery and equipment. Even the best equipped factories can not be operated most efficiently without an up-to-date system of accounting in which the actual costs of doing business are determined.

**The use of records** for determining the cost of manufacturing, selling, and delivering ice cream does not receive sufficient attention at the hands of many ice cream factory managers. There are two things to be accomplished by

the proper use of records. The product can be improved and kept more uniform, and losses can be detected and stopped or, at any rate, reduced.

**The uniformity of the product** is an important factor in gaining and holding trade. This in itself is a sufficient



Fig. 93. The Progress Drip Saver for saving the milk and cream that would otherwise be wasted.

reason for using records. Systematic improvement and development comes only by determining what conditions give the most satisfactory results. It is only by the use of records that the necessary data may be obtained. Where such records are kept a desirable method may be duplicated and the less satisfactory and wasteful methods detected. In



addition to this, the records furnish an index for the guidance of new help, making it much easier to take on new help and get them trained to the system with the least possible waste and inconvenience.

**A freezing record** will show the conditions under which the ice cream is frozen. It will also indicate the conditions under which the best yields are obtained. The ice cream maker's report shown below contains about all the necessary information. Such a report is not made out for each freezer full but for each large batch of mix. Where one man takes care of the mixing and another handles the freezers, the responsibility is divided by using such a form as is shown here. The man who does the mixing fills in the first half of the form and then passes it on to the man in charge of the freezing, who fills in the last half of the report.

## ICE CREAM MAKER'S REPORT

No. ....	Date .....
Kind of ice cream or sherbet.....	
Formula No. ....	Stabilizers used.....
Age of cream.....	
Acidity.....	Per cent. butter fat.....
Temperature of mix.....	
Gallons of mix.....	
Signed.....	
Number of batches from this mix.....	
Gallons of ice cream made.....	
Swell .....	gallons.....per cent.
Average time to freeze.....minutes. Temperature of brine.....degrees F.	
Remarks: .....	
.....	
.....	
Signed.....	

Other records should be kept which will make it possible to determine the cost of the various operations. The manager should not be satisfied in knowing that the factory as a whole yields a certain profit. His aim should be to make the factory yield a fair profit with the least possible waste of energy and material.

Any one familiar with the business can devise a system which will eliminate many of the losses and reduce manufacturing costs. If the business is very large, the simplest solution of the problem would be to employ an expert cost accountant and allow him to work out the details of the system.

The forms shown on the following pages appeared in the *Ice Cream Trade Journal* of July, 1912, and are reproduced here by permission. These forms are so simple that they require no further explanation.

**The costs of conducting the business** may be grouped under four main heads. The cost of material, power, and refrigeration would be charged against *making*. The cost of advertising, office expenses, and similar accounts would come under *selling*. The maintenance of horses or autos would be charged against *delivery*. The interest on the investment, depreciation, repairs, and similar items of expense may be charged against *maintenance*. The records that will be needed to furnish this information are a daily report of supplies taken into, and supplies taken out of the store rooms; a record of the amount of ice cream placed in the hardening rooms and the amount taken out. The difference between the amounts taken in and the amounts taken out will constitute the balances on hand at the close of the day's business. This balance should be carried forward to the next day's record. These various records when properly

DAILY REPORT ————— 19

Received from		Gallons		Received sundries					
		Milk	Cream						
	John Smith	100	50	5 bbls. sugar					
	William Jones	50	100	10 tons salt					
	Geo. Robinson	75	75	50 gallons condensed					
		225	225						
Made		In stock		Milk and Cream		Milk	Cream	Cond.	
Ice Cream									
400	Vanilla	135		On hand	280	165	75		
150	Chocolate	60		Received	225	225	50		
150	Strawberry	40		Total	505	390	125		
700		235		Used	150	90	30		
				On hand	355	300	95		
Retail		Wholesale		Ice		Salt		Sugar	
Delivered				Made	Used	On hand	Used	On hand	Used
5	Vanilla	125		15	6.5	17	.25	1756	75
10	Chocolate	45							
5	Strawberry	40							
		210							
	On hand	705							

## ICE CREAMS AND ICES

## ENGINEER'S REPORT FOR 24 HOURS

\_\_\_\_\_ M \_\_\_\_\_ 19 \_\_\_\_\_ to \_\_\_\_\_ M \_\_\_\_\_ 19 \_\_\_\_\_

ICE		Blocks
Blocks on hand—M yesterday		
Pulled N. Tank No. _____ to No. _____		
Pulled S. Tank No. _____ to No. _____		
Tickets issued		
	Total	
Signed for on sheets .....		
Ice cream room .....		
Sold for cash .....		
Tickets redeemed .....		
	Balance	
Actual count —M_____ 19_____		
	Over or short	

Tons on hand yesterday .....	_____
Unloaded since .....	_____
Total tons	_____
Tons consumed for 24 hours ending _____ M _____ 19_____	_____
Tons on hand .....	_____

## OIL USED

Engine \_\_\_\_\_ gallons  
 Cylinder \_\_\_\_\_ "  
 Ammonia \_\_\_\_\_ "

EMPLOYEES		
_____ Day Engineer	_____	_____
_____ Night "	_____	_____
_____ Fireman	_____	_____
_____ Oiler	_____	_____
_____ Tankman	_____	_____
_____ Vaultman	_____	_____
_____ Extra	_____	_____
Total	_____	_____

ENGINEER'S REPORT FOR 24 HOURS.—(Continued.)

TEMPERATURES

	7 A. M. to 7 P. M.			7 P. M. to 7 A. M.		
	Average	Min. Low	Max. High	Average	Min. Low	Max. High
Atmospheric						
North Tank						
South Tank						
Low Pressure						
High Pressure						
Steam						

SHUT DOWNS

How long \_\_\_\_\_ M to \_\_\_\_\_ M

What cause \_\_\_\_\_

\_\_\_\_\_

\_\_\_\_\_

\_\_\_\_\_

\_\_\_\_\_

AMMONIA

Used cyl. No. \_\_\_\_\_ | Received cyl. No's. \_\_\_\_\_

Returned cyl. No. \_\_\_\_\_ | \_\_\_\_\_

Supplies ordered.

Supplies needed — when.

Supplies received.

kept will enable the manager to tell at any time what it costs a gallon to manufacture and deliver the products of the factory.

The cost of delivery is too often far in excess of what it should be. This end of the business may be kept well in



Fig. 94. A good type of Delivery Wagon for heavy duty.

hand, however, by carefully checking each driver in and out. A form somewhat like the one shown on page 248 may be used for the purpose. In addition to the information contained on this report, provision may be made for reporting the time required for each trip. When a wagon goes out the driver signs for the load taken. When he returns the shipping clerk signs for the load returned. The original copy re-

mains in the shipping book. The driver is given a carbon copy for his own protection.

There are many factories in which there is no check of any sort upon the delivery men. Such loose methods foster carelessness and even dishonesty. It requires a little more time to keep these records, but the reductions in cost due to



Fig. 95. A lighter Delivery Wagon.

increased efficiency will more than compensate for extra time in keeping them.

**Keeping track of packing tubs.** In every factory many packing tubs are sent out that are never returned. The loss from this source is sometimes quite large. The difficulty in keeping track of all these packing tubs causes considerable annoyance and no small loss of time. This is particularly

(Name) \_\_\_\_\_ ICE CREAM COMPANY \_\_\_\_\_

19 \_\_\_\_\_

Quantity	Amount	Quantity	Ret'd	Sold	Over	Short
Gal. Vanilla Ice Cr.	Gal. Vanilla Ice Cr.					
“ Chocolate	“ Chocolate					
Strawberry “	Strawb'y					
“ Maple “	Maple “ “					
“ Caramel “	“ Caramel “ ‘					
Bricks	Bricks					
Ices and Sherbets	Ices and Sherbets					
Whipped cream	Whipped cream					
Specials						

Signed \_\_\_\_\_ Driver \_\_\_\_\_  
Signed \_\_\_\_\_ Shipping Clerk \_\_\_\_\_



true of the small factories that cater to a family trade and of factories that ship large quantities of ice cream to out of town points. A well planned system of checking outgoing and in-coming tubs will reduce the loss and annoyance to a minimum. The system adopted must be reliable and so simple that it will require but little attention. A system that is cumbersome and requires very much time will soon fall into disuse.

**Shipping tags.** One of the most common methods of checking packing tubs is by means of shipping tags with detachable stubs, a system which is quite satisfactory in factories with a large output. In this system a duplicating order book is used. The orders are taken in the office and sent to the shipping department to be filled. The shipping clerk fills out a shipping tag and hangs the tag and order upon a hook corresponding to the day of the week upon which the order must be filled. In this way advance orders are sure to be taken care of in due time. In the office or in the shipping department is a small case with 31 compartments which are numbered consecutively from 1 to 31. When an order is filled the shipping tag is attached to the tub. The stub is detached and filed in the compartment corresponding to the day of the month on which the order was filled. When a packer is returned to the factory the tag is detached and the stub belonging to the tag is removed from the compartment in which it was filed. The stubs remaining in the compartments represent the number of unreturned packing tubs. After about a week's time, if all the packers sent out on a certain day have not been returned, they should be collected. If any have been sent out of town, a post card to the person holding the packer will generally insure its prompt return. Since there are 31 compartments in this

ICE CREAMS AND ICES

<p>33023 Nebraska Printing Co., Lincoln, Neb.</p> 	<p>CONTENTS</p> <p>Gal. _____</p>	<p>PACKER NO.</p> <p>_____</p>	<p>Packer No. _____</p> <p>CONSIGNEE</p> <p>_____</p> <p>_____</p>
	<p><b>Do not remove this Tag</b></p>		
<p>Ship to _____</p>			
<p>VIA _____ TIME _____ DATE _____</p>			<p>Via _____</p>
<p>RETURN TO</p> <p><b>H. C. Hathaway Ice Cream Co.</b></p> <p>LINCOLN, NEBRASKA</p>			<p>Time _____</p> <p>Date _____</p>
<p>PHONE B6152                      2030-2032 O ST.</p>			<p>Ret'd _____</p>

<p>Tub No. _____ Date _____</p> <p>Name _____</p> <p>Address _____</p>	<p>Gal. _____</p> <p>Bulk _____</p>	<p>Gal. _____</p> <p>Brick _____</p>	<p>Tub No. _____</p> <p>Date _____</p> <p>Name _____</p> <p>Address _____</p> <p>Gal. _____</p> <p>Bulk _____</p>
<p></p>		<p>FROM</p> <p><b>B. RILEY HAWK SUPPLY CO.</b></p> <p>ST. LOUIS, MO.</p>	
<p>Please notify us if this freezer is not removed promptly.</p>			

<p>FROM</p> <p><b>Dept. of Dairy Husbandry</b></p> <p>THE UNIVERSITY OF NEBRASKA</p> <p>LINCOLN, NEBRASKA</p>	<p>To _____</p> <p>_____</p> <p>_____</p> <p>_____</p>	<p>Order No. _____</p> <p>Packer No. _____</p> <p>Date _____</p>
<p>To _____</p> <p>_____</p> <p>_____</p> <p>_____</p>	<p>Order No. _____</p> <p>Packer No. _____</p> <p>Date _____</p>	
<p>Order No. _____</p> <p>Packer No. _____</p>		

Fig. 96. Shipping tags with detachable stubs.

case, the stubs in one compartment may be checked over each day. In this way the tubs are checked and recalled in regular order. The principal objection to the system is that the tags are frequently detached and lost before the tub is returned to the factory. In such cases there is no record of the returned packer, and it is difficult to tell from whom the packer may have come.

**Numbering the packing tubs** will help to overcome this difficulty. The number of the packer may be recorded in the order book opposite the name of the person to whom the tub was sent. When a tub comes back without a tag,

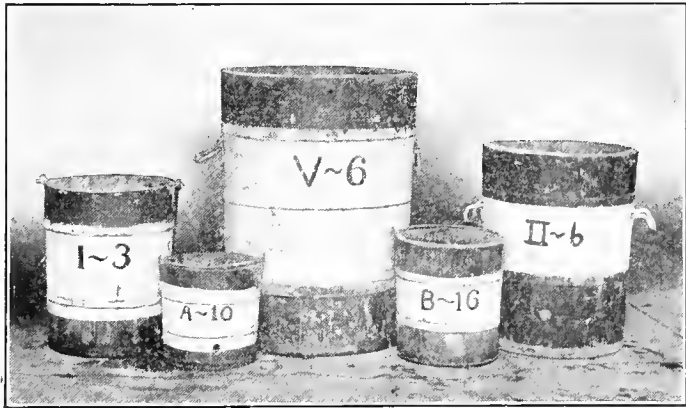

Fig. 97. Showing a System of Numbering Packing Tubs.

the shipping clerk makes a memorandum of the number. The name of the person returning the tub may be found by tracing the number in the order book. Another way to handle such cases is to file the memoranda away and refer to it whenever the stubs are checked over. When a stub is

found bearing the number of the packing tub, the stub is removed.

The problems which we have been discussing have to do entirely with preventable losses and factory efficiency. Along with this policy of factory efficiency there must be *selling* efficiency. When all the necessary arrangements have been made to insure economical operation and good service, the next problem is to increase the demand for the product of the factory. Quality and good service speak for themselves, but these should not be depended upon entirely. The public in general must know the factory, its product, and its reputation.

**The value of advertising** is quite well understood by modern business men, but beginners must learn that advertising pulls slowly and is therefore of little value to a "quitter." The advertising must be varied but uninterrupted in order that the public may become acquainted with the name and brand. When it is learned that one particular brand stands for cleanliness and uniformly high quality, the results of an advertising campaign will become apparent.

**The methods** by which a product may be introduced to the public are numerous and varied. Unique signs which take the eye and a catchy slogan are always valuable means of calling attention to the goods advertised. An advertisement may be unique or attractive, however, and yet be ineffective because it is not suggestive. A good ice cream advertisement must suggest eating to the reader of the advertisement.

**The paid reading advertisement** is a method of advertising which has been adopted by many plants. The paid reading advertisement differs from the ordinary newspaper advertising in that it is in the form of regular reading

matter instead of the ordinary advertising form. Such advertising when properly written up is particularly valuable at the opening of the season, or to call attention to some new specialty which is being introduced.

**The society column** of the local papers is made use of by some manufacturers with very good results. The way in which this kind of advertising is conducted is by means of personal or circular letters. When some social function has been announced in the society column the person who has given or who is about to give the party is sent a letter calling the person's attention to the particular factory, its equipment, and facilities for taking care of just such orders. A few timely suggestions could be offered in regard to the specialties which might be supplied and which would be found appropriate for social occasions. If this method of advertising is handled tactfully the results will be found quite satisfactory.

The various methods of advertising which have been applied to the ice cream business may be relied upon to bring results only when the quality of the products are up to standard. The public taste should be studied carefully and the public given what it demands. The winter season is ordinarily slack, but the progressive manufacturer need not close up the plant if he will but enter the field with some specialty and cater to the society or fancy trade. The summer and winter trades demand a different kind of ice cream. The fancy molded ice creams are best adapted to catch the trade during the fall and winter months.

**Ice cream for special occasions** is sure to draw trade. When one is catering to a high class trade it will be necessary to put out a greater variety of frozen products. The plain formulas used in the summer time are not the kinds

to use when one is after the winter trade. The unusual and unique in composition, flavor, and design are the best sellers.

**The importance of the winter trade** should not be overlooked. Many manufacturers do not consider the small special orders worth bothering with. This is a wrong policy upon which to operate a factory. There is a decided advantage in continuous operation. The public becomes accustomed to dealing with a certain firm. If the service is at all satisfactory, customers are not likely to discontinue their patronage without cause. The factory which does not close its doors or the manager who does not abate his efforts during the ordinarily slack months is sure to begin the next season with an advantage over his competitors. This advantage is due partly to the fact that he holds his customers from season to season and helps to create a larger demand for frozen dainties, increasing in this way his hold on the public. The uninterrupted operation also makes it possible to keep a certain number of steady men. When the season opens it will not be necessary to pick up and train an entire new force.

## CHAPTER XIX

### BY-PRODUCTS AND SIDE LINES

The question of by-products and side lines deserves the very serious consideration of the ice cream manufacturer. In a business such as ice cream making it is very important that all demands of the customer be met. The demand varies between such wide limits that on some occasions there is a shortage of milk or cream and at other times there is a surplus. The question is what to do with this surplus. Many factories have found it profitable to carry a side line which works in with the other factory operations. Since it is so important that the factory should have an abundant supply of sweet cream and milk at the times of heavy demand, it is obviously an advantage to buy more than is needed under ordinary conditions, provided the surplus can be disposed of profitably.

**A profitable side line.** The secondary products or side lines handled by an ice cream factory should be such as require but very little additional outlay of capital to properly carry them. Any product that can be so handled will prove profitable in more ways than one.

**Other dairy products** may be handled along with ice cream quite readily and are of particular importance to the ice cream manufacturer. Since a well equipped ice cream factory contains practically all the apparatus necessary for handling milk and cream, the sale of these commodities can be worked in with the regular ice cream busi-

ness and will afford an outlet for the surplus milk and cream.  
**Advantages in handling a side line.** Aside from the

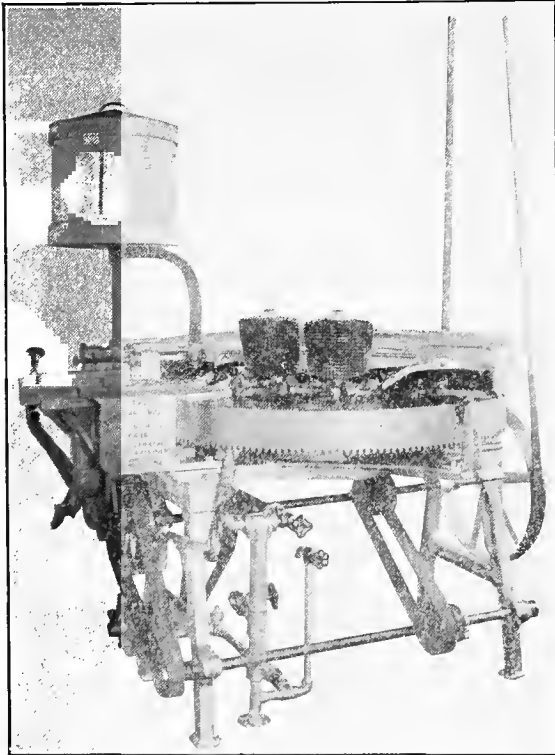

Fig. 98. The Turnbull Ice Cream Cone Machine.

direct profit derived from the by-products and side lines, there is the added advantage of continuous operation of the factory. The addition of one or more secondary prod-



ucts to the output of the factory makes it possible to retain a certain number of regular men, so that it is not necessary to shut down during the season when there is little demand for ice cream. A plant that is in continuous operation has a decided advantage over competing plants that are not so operated. With a part of the crew well trained it will be much easier to get into shape for the work of the busy season. Then, too, advantage can be taken of every demand for ice cream during the winter months. This would not be possible if the factory were operated intermittently during the winter.

**Butter**, as a rule, is the least profitable of the dairy products to be handled by the ice cream maker located in a large city, where rental and other expenses are apt to be very high. For example, if 3.5 per cent. milk costs \$1.50 a 100 pounds, when the butter fat price for sour cream is 28 cents, the 100 pounds of milk for which the ice cream maker paid \$1.50 will be worth only 98 cents at the ordinary market price, a loss of 52 cents for each 100 pounds of milk. The profit derived will, of course, depend upon the price that must be paid for butter fat and the manner in which the product is disposed of.

There is, however, a special trade that is not reached by the majority of butter factories. This is the trade the ice cream maker who finds himself forced to make butter should endeavor to reach. The cream may be too sour for ice cream making, but can very easily be made up into butter of superior quality which should command the very highest market price.

**Butter for homogenized cream.** With the introduction of the homogenizer for making up cream from butter and skim milk or milk powder there has arisen a demand for

unsalted butter of highest quality for this purpose. Some factories buy unsalted "June Extras" and hold it in cold storage for use during the rush season. Where factories have an occasional over supply of sweet cream that must be disposed of, it might be profitable to churn it and hold the butter in an unsalted condition in cold storage for use as soon as there is a demand for an extra supply of cream.

**Sweet cream** is one of the most profitable forms in which to dispose of the surplus cream or a portion of it. About 14 pounds of 25 per cent. cream will be obtained from each 100 pounds of 3.5 per cent. milk. This amount of cream, at 20 cents a pint, is worth \$2.80; at 15 cents a pint, it would bring \$2.10. In addition to the cream, there would be about 85 pounds of skim milk to be disposed of. At 5 cents a gallon, the skim milk is worth about 50 cents, but if it is made up into fermented milk it would bring about 8 cents to 10 cents a gallon or 80 cents to \$1 for the 85 pounds. Another form in which skim milk may be disposed of to good advantage, is as cottage cheese or soft cream cheese. Eighty-five pounds of milk yield about 12 pounds of cheese, which, at 8 cents to 10 cents a pound, gives a gross return of \$0.95 to \$1.20.

Skim milk, fermented milk, cottage cheese, and buttermilk are among the dairy products that are always handled as side lines in connection with some other business. That is to say, they never constitute the main output of a plant. Buttermakers and whole milk dealers have found these profitable. Under favorable conditions, there is no reason why they could not be handled profitably by ice cream makers. Since many factories have a surplus of skim milk to be disposed of, fermented milk is probably one of the

best side lines that can be carried. Very little additional equipment will be required and no extra expense need be involved for delivery.

**Fermented milk.** Within recent years considerable investigation of the therapeutic value of buttermilk and other forms of fermented milk has been carried on. Various kinds of fermented milk have been recommended by physicians in the treatment of intestinal disorders and considerable quantities of fermented milk and buttermilk are used in hospitals. As a natural result, the demand for these

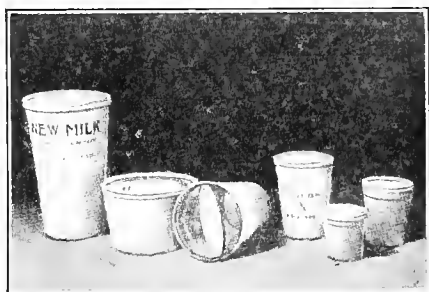

Fig. 99. Types of Single Service Milk Bottles may be used for milk, cream, or fermented milk.

products has increased considerably. This condition should be made use of by the ice cream factories. Since the raw material is available in many factories and the demand for the product already exists, it only remains for the ice cream factory to produce a satisfactory article. There are a number of special fermented preparations that may be made from milk. Some of these are placed on the market under some special trade name. Most of them, however, are fundamentally some form of a lactic fermentation.

**Lactic fermentation.** The most common fermentation occurring in milk is the lactic acid fermentation, which is brought about by the lactic acid group of bacteria. This is the same bacteria that is used in making starter and in cream ripening. Buttermilk, properly speaking, is the by-product obtained when cream is churned for buttermaking. Where good, clean flavored cream is churned, the buttermilk will have a rich, mildly acid flavor. Much of the buttermilk now sold in the cities is off flavor and of doubtful purity and quality. To secure an abundant supply of buttermilk in fresh condition and free from objectionable odors, large quantities are now made by churning specially soured skim milk. The resulting product does not have quite the same flavor as the true buttermilk but many prefer it to the buttermilk obtained by churning cream.

**Prepared buttermilk.** To make buttermilk by the method just mentioned, either whole milk, skim, or partly skimmed milk may be used. The buttermilk has a richer and more pleasing flavor where whole milk is used instead of skim milk. The milk should be pasteurized and cooled to 70° F., inoculated with a good starter, and allowed to stand until it begins to thicken. The soured milk should then be placed in a churn and churned for 20 to 30 minutes to break up the curd into very fine particles. Since buttermilk obtained by churning cream contains all the milk constituents except fat, it does not differ in composition from the prepared buttermilk made by fermenting pasteurized skim milk with special cultures of bacteria. In comparison with the average buttermilk from churned cream that is offered for sale in the large cities, this prepared buttermilk is decidedly superior from the sanitary standpoint as well as in body and flavor. This is the product frequently

put upon the market under the name of "Lactone."

**Special cultures.** In addition to the ordinary cultures of lactic acid bacteria, one may obtain cultures of special organisms for the manufacture of fermented milk. Many of these different cultures no doubt contain organisms nearly or quite identical with the *Bacillus bulgaricus*, which is the generally adopted name of the organism which produces a very characteristic fermentation and gives a product of very superior quality. This product, or a fermented milk nearly resembling the fermented milk made from *B. bulgaricus*, is frequently put upon the market under various names such as Bulgarian buttermilk, Lactone, Fer-mil-lac,<sup>1</sup> etc. Some of these processes are patented and may be used only by permission of the patentee.

**Yoghurt** is the general name given to this class of fermented milk by the U. S. Bureau of Animal Industry. The older name of *Bacterium caucasicum* is used instead of the more common name of *Bacillus bulgaricus* for the specific organism.<sup>2</sup>

**Bulgarian cultures.** There are several decided advantages in using the cultures of *B. bulgaricus* in the manufacture of fermented milk. The *Bulgaricus* cultures have a tendency to produce a more slimy curd which does not whey off like the natural or the prepared buttermilks in which only lactic acid organisms are used. The slimy curd produced by the Bulgarian bacteria is not so satisfactory when used alone, but in combination with the ordinary lactic acid fermentation a milk having a very smooth creamy consistency and a very mild and pleasing flavor is produced.

<sup>1</sup> Process patented.

<sup>2</sup> Circular 171, Bureau of Animal Industry.

**The method of manufacture.** The ordinary lactic acid bacteria and the Bulgarian bacteria can not be grown together in the milk at the same time, because of the different conditions of temperature required by the two organisms. The most satisfactory method of procedure is to pasteurize two batches of milk. Cool one to 70° F. and inoculate it with a pure culture of lactic acid bacteria. Cool the other batch of milk to 100° F. and inoculate it with a culture of Bulgarian bacteria or some similar organism and allow the two batches to ferment for 24 hours at the temperature at which they were inoculated. Both batches are then mixed and poured into a churn and churned for 15 or 20 minutes. This action breaks up the curd and the two cultures are thoroughly mixed. The more tenacious curd of the Bulgarian organism prevents the milk from wheying off and gives a rich creamy consistency to the finished product.

**Marketing fermented milk.** These special milk preparations are very popular and there should be no difficulty encountered in creating a larger demand for them. The milk should be put up in quart bottles. The caps used should contain some neat and appropriate design or name. A little advertising will soon get the public acquainted with the product and the ice cream factory will be assured of a profitable outlet for the surplus milk.

**Cottage cheese.** The method of making cottage cheese is very simple, but the quality of the product as found on the general market is rather variable. When properly made, cottage cheese has a very smooth texture, free from lumps, and a rich, clean acid flavor, resembling ripened

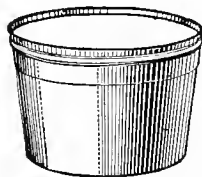

Fig. 100. A neat Container for Cottage Cheese

cream. The average composition, according to Publow, is as follows:

Water .....	72.0%
Proteids .....	20.0
Sugar, lactic acid, etc. ....	5.5
Mineral matter .....	2.5
	100.0%

A study of the above table shows the high nutritive value of cottage cheese made from skim milk. Its quality will be greatly improved and its food value increased by the addition of a little sweet cream.

**Methods of manufacture.** The simplest method of making cottage cheese is as follows: Add about 10 to 15 per cent. of good starter to raw skim milk at 70° F. and allow it to curdle. When it is evenly curdled, break up the curd into fine particles and heat to 104° F. and hold for 15 minutes. Pour the curd into a muslin bag and hang it up to drain. When dry, the mass of curd should be salted at the rate of one ounce of salt to eight or ten pounds of curd. A pound of sweet cream to ten pounds of curd may also be added to give a richer flavor. The curd should then be worked thoroughly to give a smooth, uniform texture and to distribute the salt. The cheese should then be packed in one pound containers and placed in a refrigerator. This cheese does not require curing but is ready for use at once.

More uniform results will be obtained by pasteurizing the skim milk before adding the starter. By regulating the amount of starter used, the milk can be set so that it will be ready for heating and draining at about the same time each day. In this way the process can be so timed that the

work of caring for the cheese need not interfere with other operations; however, if a high class trade is to be served, a high class product must be produced and each step of the process must have proper attention.

It is not customary to make this cheese from whole milk, as there is a very heavy loss of fat in the whey. The better way is to make it from skim milk and add the fat in the form of sweet cream after the curd has been drained.

Instead of a muslin bag a vat strainer with perforated sides and bottom may be used for draining the curd. A piece of ordinary cheese cloth is spread over the strainer before the curd is put in.

From 15 to 20 pounds of cottage cheese will be obtained from 100 pounds of skim milk, depending upon the amount of moisture retained by the curd. Care should be taken not to allow too much of the whey to remain in the curd, as this gives a sour, sticky cheese. The amount of moisture retained may be controlled by the heating process. Longer and higher heating gives a drier curd. When put up in a neat package, cottage cheese sells for 8 to 10 cents a pound.

**Neufchatel cheese.** This is the name of a soft French cheese cured by means of a mold. The method by which it is made in this country differs considerably from the original method and closely resembles the method for making cottage cheese.

**Method of manufacture.** Whole milk is pasteurized and cooled to 75° F. and about 20 per cent. of a good starter added and mixed well. Add rennet extract at the rate of two ounces to 1,000 pounds of milk. The rennet extract should be diluted with about five times its volume of cold water and thoroughly mixed with the milk. Cover the vat of milk and allow it to stand quietly for one to one



and one-half hours or until evenly coagulated and quite firm. The curd should be cut into small pieces by means of cheese knives and then poured into a strainer lined with cheese cloth and allowed to drain until it is quite dry. The expulsion of the whey may be hastened by the application of light pressure. The curd should then be salted at the rate of one ounce of salt to eight pounds of curd and worked until very smooth and free from lumps. It is then packed in containers the same as cottage cheese, or it may be put up in round rolls and wrapped in parchment paper and tin foil.

**Cream cheese** is made by the same process, using a thin cream testing about ten per cent. butter fat, but as there is a very heavy loss of fat by this method, it is more economical to use whole milk and add sufficient rich cream to give the desired flavor.

**Fancy soft cheese.**<sup>3</sup> From the Neufchatel and cream cheese made by the above process, a number of fancy soft cheeses may be made by the addition of nuts, peppers, olives, etc.

**Sandwich nut cheese** is made by adding four or five ounces of blanched almonds and walnuts, finely ground, to ten pounds of cream cheese.

**Pepper cream cheese** is made by adding one-fourth to one-half pound of red peppers to ten pounds of cream cheese.

**Olive cream cheese** is made by adding the meat of about two or three dozen olives to ten pounds of cream cheese.

The above products may be found valuable to those who desire to work up a winter trade. During the winter months the bulk of the ice cream sold is used at social

<sup>3</sup> "Fancy Cheese for Farm and Factory," Cornell Bulletin, 270.

functions. Fancy ice creams are popular on such occasions. Some fancy special product like those given will often prove an effective means of drawing this winter trade.

**Whipped cream.** This is a product that belongs properly with the ice cream business, although it is not a frozen product. In every town of any size large quantities of whipping cream are used both by confectioners and housewives. Owing to a lack of proper facilities, lack of knowledge, or both, much difficulty is sometimes experienced in whipping the cream. With all the facilities for cooling and handling the cream, this work could easily be taken care of in the ice cream factory. Whipped cream is a term applied to cream that has been beaten to a stiff froth by rapid agitation at a low temperature. In the whipping process a considerable volume of air is incorporated with the cream. The finished product should be light and smooth but must have sufficient body to enable it to stand up well.

The most important factors affecting the whipping qualities of cream are richness and temperature. A thin cream is not sufficiently viscous to hold the air incorporated in the whipping process and is apt to churn, particularly if the temperature is not very low. On an average the cream should contain 30 to 35 per cent. of butter fat, but even this cream will not whip unless it has been thoroughly chilled and held at a temperature of not more than 40° F. for some time before whipping.

It is well known to the average ice cream maker that pasteurized cream, when used in making ice cream, will not swell as much as raw cream unless it is first thoroughly chilled and held at a low temperature for some time in order to restore its viscosity. The same is true of whipping cream. Greater difficulty is experienced in whipping pas-

teurized cream unless special precautions are taken to age or ripen it. No attempt should be made to whip it at temperatures over 40° F.

According to experiments conducted by the Maryland station some years ago, it seems that acidity also affects the whipping qualities of cream: The following extract is taken from Bulletin 136 of the Maryland station.

“The older the cream up to the point of separation of whey from clabber the better it whipped. For this reason gravity cream of the same fat content whipped better than fresh separator cream, 12 hours usually being required to raise. This was accompanied by a development of 0.2 to 0.3 per cent. of lactic acid. Samples of cream were also whipped with and without commercial lactic acid so as to overcome any changes which would occur were the cream allowed to remain at various temperatures while lactic acid increased naturally. In every instance the cream to which commercial lactic acid had been added whipped in less time and produced a more dense foam than did that to which no acid had been added.

“**Lactic acid**, either natural or commercial, at low temperatures affected a gelatinous consistency of the casein and albumen of the cream, which rendered it capable of holding a considerable quantity of air, thus facilitating whipping.

“In the following tablet each sample of cream has been held at 45° F. for two hours. Here the effect of lactic acid proved to be of greater importance than that of the fat content . . . 0.3 of one per cent. of acidity is the maximum which cream may contain without acquiring a sour taste.”

**Viscogen.** A substance known as viscogen, which is

## TIME REQUIRED TO WHIP CREAM OF VARYING ACIDITY

Per cent. Fat in cream	Per cent. of acid in cream									
	0.1	0.2	0.3	0.4	0.5	0.6	0.7	0.8	0.9	1.0
15	1m. 50s.	1m. 30s.	1m. 20s.	1m. 10s.	1m.	50s.	1m. 30s.	1m. 20s.	1m.	50s.
20	1m. 10s.	55s.	50s.	41s.	37s.	32s.	42s.	34s.	30s.	30s.
25	55s.	45s.	40s.	37s.	34s.	30s.	28s.	25s.	23s.	23s.
30							26s.	23s.	22s.	22s.

made from a solution of sugar and lime water, is sometimes used to restore the viscosity of cream. While this substance is not in any way harmful, cream in which it has been used should be so labeled.

In case the consumers have been accustomed to buying the whipping cream and doing the whipping themselves it may be necessary to work up the trade for this product, but once established, it should prove a very profitable side line. The whipped cream can be packed in ice cream packers for delivery and will stand up well when properly packed.

## CHAPTER XX

### ICE CREAM AS A SIDE LINE IN THE LOCAL CREAMERY

According to a recent report of the Bureau of Animal Industry, many of the small creameries have taken up the manufacture of ice cream as a side line. The plan has, in many cases, proved highly satisfactory. However, before a small creamery company undertakes the manufacture of ice cream, local market conditions and demands, as well as the adaptability of the factory and its location, must be carefully considered.

**Local conditions.** In a town of 1,200 or 1,500 inhabitants there should be a ready market for a limited amount of ice cream. If the surrounding country is well settled, or if there are a few smaller towns within a reasonable distance, the prospects of securing a ready market for ice cream in paying quantities are sufficiently good to warrant the installation of the necessary machinery for the manufacture of ice cream in the local creamery. In a general way, however, it is safe to say that unless a market can be found for at least 20 or 30 gallons of ice cream a day during the summer, it will scarcely pay a small local concern to engage in the business.

**Advantages of ice cream as a side line.** Many small creameries find it difficult to compete with larger creameries in the general butter market. The keen competition makes it necessary to stop all waste of power and labor and at

the same time secure a market for the products of the factory at a fair price.

Under many conditions ice cream as a side line will prove to be the best means of securing greater efficiency and greater profit from the factory. In addition to the direct returns from the sale of ice cream, there will be the

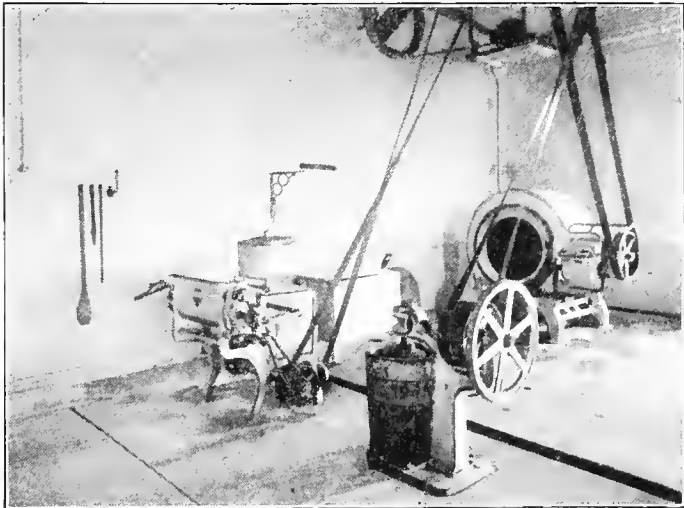

Fig. 101. Machinery for the manufacture of butter and ice cream in a small creamery.

indirect returns in the form of greater popularity and greater prestige accruing to the local concern, provided the business is properly handled.

There will be many possibilities for expansion and improvement open to the creamery that manufactures ice cream for the local trade. There is an opportunity to put into

effect a system of cream grading in which a special price can be paid for good cream. This in itself will have a moral effect upon all of the creamery patrons, and will make it possible to secure a better grade of cream from which a better grade of butter can be made. Once the creamery has established a reputation for the quality of its products the matter of competition from larger concerns fades into insignificance.

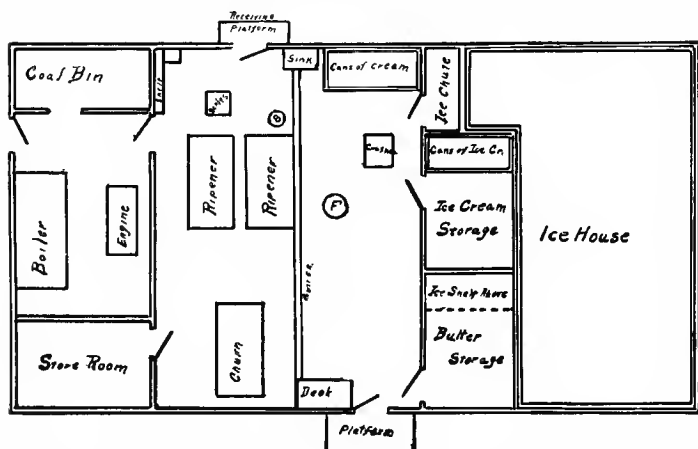

Fig. 102. The Floor Plan of a combined Butter and Ice Cream Factory.

nificance. Where a creamery has established its reputation for the quality of its butter, which should be known by some particular brand, the known good quality of the butter will help sell the ice cream. The ice cream should bear the same brand as the butter, since the public will naturally associate that brand with high quality. The creamery manager must be sure, however, that the ice cream turned out is of good quality, otherwise the good qualities of one product



when used to sell another product of inferior quality will eventually work against all the products and the concern itself.

**New problems to be dealt with.** Although the advantages in the manufacture of ice cream in the local creamery are great, it must also be remembered that there will be many new problems to solve. One of these is the competition from the specialized ice cream factory. In many respects the local creamery will have a decided advantage, but the manager must appreciate and use these advantages.

**Competition in selling.** In point of salesmanship, the large specialized ice cream factory will usually have the advantage over the local creamery. There is no reason, however, why the creamery man cannot learn much from his larger competitor and even adopt his best methods of selling. One of the points of advantage possessed by the manager of the local plant lies in his more intimate knowledge of local conditions and demands. If he will take the pains to study these local demands and make use of his personal influence with the consumers, the competition of the larger plant can easily be met.\*

**Competition in buying.** In the matter of buying, the creamery has a decided advantage, as it is already in touch with a large number of cream producers. It is not such a difficult matter for the creamery to secure an abundant supply of sweet cream at a price only slightly in advance of the price paid for butter fat for churning. In addition to this, the creamery has an outlet in the form of butter for all the cream which it may buy. Since the price paid for sweet cream is only slightly higher than for regular churning cream, the factory does not sustain a loss, should a small surplus of sweet cream be purchased.

**Additional equipment.** The cost of equipment may be anywhere from \$200 to \$1,000, depending upon the volume of trade to be taken care of. In the smaller concerns the manufacture of ice cream will prove profitable and advantageous only where the cost of the extra equipment is not great and no extra help is required.

To begin with, a ten-gallon tub freezer may be used and will take care of the trade until the business has increased

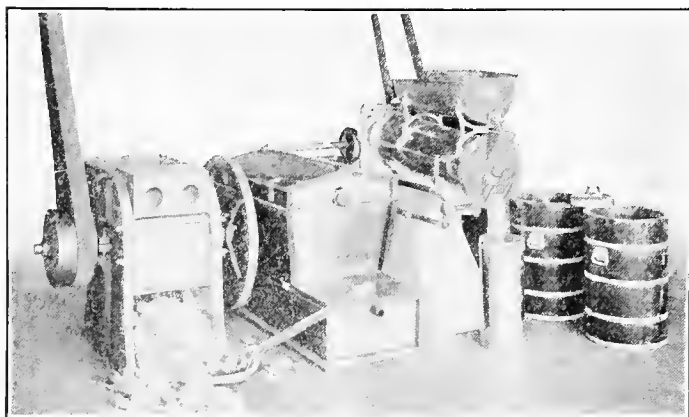

Fig. 103. Showing the complete equipment for a small ice cream factory.

sufficiently to warrant the installation of a larger freezer of a more improved type. An ice crusher, probably an extra vat, extra pulleys, and extra belting, and a number of ice cream packers of different sizes will complete the equipment. It is assumed, of course, that the factory already has an ice house or mechanical refrigerating system which can be adapted to the needs of the ice cream business with but little addition or alteration.

The following quotation from Circular No. 188 of the Bureau of Animal Industry gives some idea of the profits obtained by the creameries of this country engaged in the manufacture of ice creams.

“**The average cost of making a gallon of ice cream** is reported by them to be about 45 cents, and the same reports show the average wholesale selling price to be about 87 cents, leaving a margin of 42 cents a gallon.

“**The profits** from the manufacture and sale of ice cream are clearly brought out by the following example: 100 pounds of 18 per cent. cream are equal to 12 gallons, which with 66 per cent. overrun (swell) will produce 20 gallons of ice cream, and if sold for 87 cents a gallon will amount to \$17.42. Allowing that sugar and flavoring for this amount costs \$1.40, there is left \$16 for 18 pounds of butter fat used. On this basis, the butter fat sells for 88.8 cents a pound. The same amount of butter fat made into butter with a 21 per cent. overrun would produce 21.78 pounds of butter, and if sold for 31 cents a pound (average price for New York extras, 1910) would amount to \$6.75 or 37.5 cents a pound for butter fat. A comparison of these items shows a difference of 51.3 cents a pound in favor of ice cream.

“The special equipment necessary for the average creamery to manufacture ice cream consists of freezer, ice crusher, holding cans, and hardening vat, and need not exceed \$300 in cost. Such an outlay will often be paid for in one season and a substantial surplus remain from the profits of this branch of the business.”

## APPENDIX

### TABLE I

*Showing the Amount of Skim Milk, 3 Per Cent. Milk, 3.5 Per Cent. Milk, or 4 Per Cent. Milk to Add to 100 Pounds of Cream to Reduce the Test to 18 Per Cent.*

<i>Test of cream to be standardized</i>	<i>Lbs. skim milk to 100 lbs. of cream</i>	<i>Lbs. 3 per cent. milk to 100 lbs. of cream</i>	<i>Lbs. 3.5 per cent. milk to 100 lbs. of cream</i>	<i>Lbs. 4 per cent. milk to 100 lbs. of cream</i>	<i>Test of cream to be standardized</i>
19	5.55	6.66	6.90	7.14	19
20	11.11	13.33	13.79	14.28	20
21	16.66	19.99	20.68	21.42	21
22	22.22	26.66	27.58	28.57	22
23	27.77	33.33	34.48	35.71	23
24	33.33	39.99	41.37	42.85	24
25	38.88	46.66	48.27	50.00	25
26	44.44	53.32	55.16	57.14	26
27	49.99	59.99	62.06	64.28	27
28	55.55	66.66	68.96	71.43	28
29	61.10	73.32	75.85	78.57	29
30	66.66	79.99	82.75	85.71	30
31	72.21	86.65	89.64	92.85	31
32	77.77	93.32	96.54	100.00	32
33	83.32	99.99	103.44	107.14	33
34	88.88	106.65	110.33	114.28	34
35	94.43	113.32	117.23	121.43	35
36	99.99	119.98	124.12	128.57	36
37	105.54	126.65	131.02	135.71	37
38	111.10	133.32	137.92	142.86	38
39	116.65	139.98	144.81	150.00	39
40	122.21	146.65	151.71	157.14	40
41	127.76	153.31	158.60	164.28	41
42	133.32	159.98	165.50	171.43	42
43	138.87	166.65	172.40	178.57	43
44	144.43	173.31	179.29	185.71	44
45	149.98	179.98	186.19	192.86	45
46	155.54	186.64	193.08	200.00	46
47	161.09	193.30	199.98	207.14	47
48	166.65	199.97	206.87	214.29	48
49	172.20	206.64	213.77	221.43	49
50	177.76	213.30	220.66	228.57	50

TABLE II

*Showing the Amount of Skim Milk, 3 Per Cent. Milk, 3.5 Per Cent. Milk, or 4 Per Cent. Milk to Add to 100 Pounds of Cream to Reduce the Test to 20 Per Cent.*

<i>Test of cream to be standardized</i>	<i>Lbs. skim milk to 100 lbs. of cream</i>	<i>Lbs. 3 per cent. milk to 100 lbs. of cream</i>	<i>Lbs. 3.5 per cent. milk to 100 lbs. of cream</i>	<i>Lbs. 4 per cent. milk to 100 lbs. of cream</i>	<i>Test of cream to be standardized</i>
21	5.00	5.75	6.06	6.25	21
22	10.00	11.76	12.12	12.50	22
23	15.00	17.65	18.18	19.00	23
24	20.00	23.53	24.24	25.00	24
25	25.00	29.41	30.30	31.00	25
26	30.00	35.30	36.36	37.00	26
27	35.00	41.17	42.42	44.00	27
28	40.00	47.05	48.48	50.00	28
29	45.00	53.00	54.54	56.00	29
30	50.00	58.80	60.60	62.00	30
31	55.00	64.70	66.66	69.00	31
32	60.00	70.50	72.72	75.00	32
33	65.00	76.47	78.78	81.00	33
34	70.00	82.35	84.84	87.00	34
35	75.00	88.23	90.90	93.00	35
36	80.00	94.11	96.96	100.00	36
37	85.00	100.00	103.02	106.00	37
38	90.00	105.90	109.08	113.00	38
39	95.00	111.76	115.14	119.00	39
40	100.00	117.65	121.20	125.00	40
41	105.00	123.53	127.26	131.00	41
42	110.00	129.41	133.32	137.00	42
43	115.00	135.30	139.38	143.00	43
44	120.00	141.17	145.44	150.00	44
45	125.00	147.05	151.50	156.00	45
46	130.00	153.00	157.56	162.00	46
47	135.00	158.80	163.62	169.00	47
48	140.00	164.70	169.69	175.00	48
49	145.00	170.50	175.75	181.00	49
50	150.00	176.30	181.81	187.00	50

TABLE III

*Showing the Amount of Skim Milk, 3 Per Cent. Milk, 3.5 Per Cent. Milk, or 4 Per Cent. Milk to Add to 100 Pounds of Cream to Reduce the Test to 25 Per Cent.*

<i>Test of cream to be standardized</i>	<i>Lbs. skim milk to 100 lbs. of cream</i>	<i>Lbs. 3 per cent. milk to 100 lbs. of cream</i>	<i>Lbs. 3.5 per cent. milk to 100 lbs. of cream</i>	<i>Lbs. 4 per cent. milk to 100 lbs. of cream</i>	<i>Test of cream to be standardized</i>
26	4.00	4.54	4.65	5.00	26
27	8.00	9.09	9.30	10.00	27
28	12.00	13.63	13.95	14.00	28
29	16.00	18.18	18.60	19.00	29
30	20.00	22.72	23.25	24.00	30
31	24.00	27.27	27.90	29.00	31
32	28.00	31.81	32.55	33.00	32
33	32.00	36.36	37.20	38.00	33
34	36.00	40.90	41.85	42.00	34
35	40.00	45.45	46.51	46.00	35
36	44.00	49.99	51.16	52.00	36
37	48.00	54.54	55.81	57.00	37
38	52.00	59.08	60.46	62.00	38
39	56.00	63.63	65.11	67.00	39
40	60.00	68.17	69.76	71.00	40
41	64.00	72.72	74.41	76.00	41
42	68.00	77.26	79.06	81.00	42
43	72.00	81.81	83.71	86.00	43
44	76.00	86.35	88.36	90.00	44
45	80.00	90.90	93.02	95.00	45
46	84.00	95.44	97.67	100.00	46
47	88.00	99.99	102.32	105.00	47
48	92.00	104.53	106.97	109.00	48
49	96.00	109.08	111.62	114.00	49
50	100.00	113.63	116.27	119.00	50

TABLE IV

*Showing the Amount of Skim Milk, 3 Per Cent. Milk, 3.5 Per Cent. Milk, or 4 Per Cent. Milk to Add to 100 Pounds of Cream to Reduce the Test to 30 Per Cent.*

<i>Test of cream to be standardized</i>	<i>Lbs. skim milk to 100 lbs. of cream</i>	<i>Lbs. 3 per cent. milk to 100 lbs. of cream</i>	<i>Lbs. 3.5 per cent. milk to 100 lbs. of cream</i>	<i>Lbs. 4 per cent. milk to 100 lbs. of cream</i>	<i>Test of cream to be standardized</i>
31	3.33	3.70	3.77	3.84	31
32	6.66	7.40	7.54	7.69	32
33	9.99	11.10	11.32	11.53	33
34	13.33	14.81	15.09	15.38	34
35	16.66	18.51	18.86	19.23	35
36	19.99	22.21	22.64	23.07	36
37	23.33	25.92	26.41	26.92	37
38	26.66	29.62	30.18	30.76	38
39	29.99	33.32	33.96	34.61	39
40	33.33	37.03	37.73	38.46	40
41	36.66	40.73	41.51	42.30	41
42	39.99	44.43	45.28	46.15	42
43	43.33	48.13	49.05	49.99	43
44	46.66	51.84	52.83	53.84	44
45	49.99	55.54	56.60	57.69	45
46	53.32	59.24	60.37	61.53	46
47	56.61	62.95	64.15	65.38	47
48	59.99	66.65	67.92	69.22	48
49	63.33	70.35	71.70	73.07	49
50	66.66	74.06	75.47	76.92	50

TABLE V

*Showing the Amount of Skim Milk, 3 Per Cent. Milk, 3.5 Per Cent. Milk, or 4 Per Cent. Milk to Add to 100 Pounds of Cream to Reduce the Test to 35 Per Cent.*

<i>Test of cream to be standardized</i>	<i>Lbs. skim milk to 100 lbs. of cream</i>	<i>Lbs. 3 per cent. milk to 100 lbs. of cream</i>	<i>Lbs. 3.5 per cent. milk to 100 lbs. of cream</i>	<i>Lbs. 4 per cent. milk to 100 lbs. of cream</i>	<i>Test of cream to be standardized</i>
36	2.86	3.13	3.17	3.23	36
37	5.71	6.25	6.35	6.45	37
38	8.57	9.37	9.52	9.67	38
39	11.43	12.50	12.70	12.90	39
40	14.28	15.62	15.87	16.12	40
41	17.14	18.75	19.04	19.35	41
42	20.00	21.86	22.22	22.57	42
43	22.86	25.00	25.39	25.80	43
44	25.71	28.12	28.57	29.02	44
45	28.57	31.25	31.74	32.25	45
46	31.43	34.37	34.91	35.47	46
47	34.28	37.50	38.09	38.70	47
48	37.14	40.62	41.26	41.92	48
49	40.00	43.75	44.44	45.15	49
50	42.86	46.87	47.61	48.37	50



TABLE VI

*Showing the Amount of Skim Milk, 3 Per Cent. Milk, 3.5 Per Cent. Milk, or 4 Per Cent. Milk to Add to 100 Pounds of Cream to Reduce the Test to 40 Per Cent.*

<i>Test of cream to be standardized</i>	<i>Lbs. skim milk to 100 lbs. of cream</i>	<i>Lbs. 3 per cent. milk to 100 lbs. of cream</i>	<i>Lbs. 3.5 per cent. milk to 100 lbs. of cream</i>	<i>Lbs. 4 per cent. milk to 100 lbs. of cream</i>	<i>Test of cream to be standardized</i>
41	2.50	2.70	2.74	2.77	41
42	5.00	5.40	5.47	5.55	42
43	7.50	8.10	8.21	8.33	43
44	10.00	10.80	10.95	11.10	44
45	12.50	13.50	13.69	13.88	45
46	15.00	16.20	16.43	16.66	46
47	17.50	18.90	19.17	19.43	47
48	20.00	21.60	21.91	22.21	48
49	22.50	24.30	24.65	24.99	49
50	25.00	27.00	27.39	27.77	50

TABLE VII

*Showing the Amount of Skim Milk, 3 Per Cent. Milk, 3.5 Per Cent. Milk, or 4 Per Cent. Milk to Add to 100 Pounds of Cream to Reduce the Test to 45 Per Cent.*

<i>Test of cream to be standardized</i>	<i>Lbs. skim milk to 100 lbs. of cream</i>	<i>Lbs. 3 per cent. milk to 100 lbs. of cream</i>	<i>Lbs. 3.5 per cent. milk to 100 lbs. of cream</i>	<i>Lbs. 4 per cent. milk to 100 lbs. of cream</i>	<i>Test of cream to be standardized</i>
46	2.23	2.38	2.41	2.43	46
47	4.44	4.76	4.82	4.88	47
48	6.66	7.14	7.23	7.32	48
49	8.88	9.52	9.64	9.75	49
50	11.10	11.90	12.05	12.19	50

TABLE VIII

*Showing the Proportions in Which Cream and Skim Milk, 3 Per Cent. Milk, 3.5 Per Cent. Milk, or 4 Per Cent. Milk Must Be Mixed to Make 100 Pounds of 15 Per Cent. Cream*

<i>Test of cream</i>	<i>Lbs. cream</i>	<i>Lbs. skim milk</i>	<i>Lbs. cream</i>	<i>Lbs. 3 per cent. milk</i>	<i>Lbs. cream</i>	<i>Lbs. 3.5 per cent. milk</i>	<i>Lbs. cream</i>	<i>Lbs. 4 per cent. milk</i>	<i>Test of cream</i>
15	100.0	0.00	100.0	0.00	100.0	0.00	100.0	0.00	15
16	93.75	6.25	92.31	7.69	92.00	8.00	91.67	8.33	16
17	88.12	11.88	85.72	14.28	85.20	14.80	84.62	15.38	17
18	83.35	16.65	80.02	19.98	79.30	20.70	78.58	21.42	18
19	78.96	21.04	75.00	25.00	74.20	25.80	73.36	26.64	19
20	75.00	25.00	70.60	29.40	69.70	30.30	68.75	31.25	20
21	71.44	28.56	66.70	33.30	65.74	34.26	64.72	35.28	21
22	68.22	31.78	63.18	36.82	62.06	37.94	61.15	38.85	22
23	65.28	34.72	60.00	40.00	58.96	41.04	57.92	42.08	23
24	62.56	37.44	57.16	42.84	56.08	43.92	55.00	45.00	24
25	60.00	40.00	54.60	45.40	53.50	46.50	52.40	47.60	25
26	57.76	42.24	52.26	47.74	51.16	48.84	50.06	49.94	26
27	55.60	44.40	50.08	49.92	48.88	51.12	47.92	52.08	27
28	53.59	46.41	48.00	52.00	46.96	53.04	45.92	54.08	28
29	51.84	48.16	46.24	53.76	45.42	54.88	44.00	56.00	29
30	50.00	50.00	44.50	55.50	43.45	56.55	42.40	57.60	30
31	48.48	51.52	42.88	57.12	41.76	58.24	40.80	59.20	31
32	46.96	53.04	41.52	58.48	40.33	59.67	39.31	60.69	32
33	45.46	54.54	40.06	59.94	38.90	61.10	38.00	62.00	33
34	44.14	55.86	38.82	61.18	37.70	62.30	36.73	63.27	34
35	43.00	57.00	37.60	62.40	36.60	63.40	35.60	64.40	35
36	41.83	58.17	36.37	63.63	35.40	64.60	34.48	65.52	36
37	40.55	59.45	35.32	64.68	34.44	65.56	33.34	66.66	37
38	39.48	60.52	34.30	65.70	33.40	66.60	32.38	67.62	38
39	38.47	61.53	33.35	66.65	32.40	67.60	31.50	68.50	39
40	37.50	62.50	32.50	67.50	31.50	68.50	30.50	69.50	40

TABLE IX

*Showing the Proportions in Which Cream and Skim Milk, 3 Per Cent. Milk, 3.5 Per Cent. Milk, or 4 Per Cent. Milk Must Be Mixed to Make 100 Pounds of 18 Per Cent. Cream*

<i>Test of cream</i>	<i>Lbs. cream</i>	<i>Lbs. skim milk</i>	<i>Lbs. cream</i>	<i>Lbs. 3 per cent. milk</i>	<i>Lbs. cream</i>	<i>Lbs. 3.5 per cent. milk</i>	<i>Lbs. cream</i>	<i>Lbs. 4 per cent. milk</i>	<i>Test of cream</i>
18	100.00	0.00	100.00	0.00	100.00	0.00	100.00	0.00	18
19	94.74	5.26	93.75	6.25	93.55	6.45	93.36	6.64	19
20	90.00	10.00	83.24	11.76	87.88	12.12	87.50	12.50	20
21	85.72	14.28	83.50	16.50	82.87	17.13	82.36	17.64	21
22	81.84	18.16	78.96	21.04	78.32	21.68	77.80	22.20	22
23	78.30	21.70	75.00	25.00	74.35	25.65	73.70	26.30	23
24	75.10	24.90	71.44	28.56	70.72	29.28	70.00	30.00	24
25	72.00	28.00	68.22	31.78	67.45	32.55	66.68	33.32	25
26	69.28	30.72	65.28	34.72	64.48	35.52	63.68	36.32	26
27	66.70	33.30	62.56	37.44	61.66	38.34	60.94	39.06	27
28	64.30	35.70	60.00	40.00	59.20	40.80	58.94	41.06	28
29	62.16	37.84	57.76	42.24	56.88	43.12	56.00	44.00	29
30	60.00	40.00	55.60	44.40	54.76	45.24	53.92	46.08	30
31	58.14	41.86	53.59	46.41	52.68	47.32	51.90	48.10	31
32	56.32	43.68	51.84	48.16	50.86	49.14	50.02	49.98	32
33	54.55	45.45	50.05	49.95	49.15	50.85	48.40	51.60	33
34	52.96	47.04	48.48	51.52	47.68	52.32	46.72	53.28	34
35	51.55	48.45	46.96	53.04	46.11	53.89	45.26	54.74	35
36	50.14	49.86	45.46	54.54	44.60	55.40	43.84	56.16	36
37	48.70	51.30	44.14	55.86	43.38	56.62	42.43	57.57	37
38	47.40	52.60	43.00	57.00	42.00	58.00	41.20	58.80	38
39	46.24	53.76	41.83	58.17	40.85	59.15	40.15	59.85	39
40	45.00	55.00	40.60	59.40	39.72	60.28	39.06	60.94	40

TABLE X

*Showing the Proportions in Which Cream and Skim Milk, 3 Per Cent. Milk, 3.5 Per Cent. Milk, or 4 Per Cent. Milk Must Be Mixed to Make 100 Pounds of 20 Per Cent. Cream*

<i>Test of cream</i>	<i>Lbs. cream</i>	<i>Lbs. skim milk</i>	<i>Lbs. cream</i>	<i>Lbs. 3 per cent. milk</i>	<i>Lbs. cream</i>	<i>Lbs. 3.5 per cent. milk</i>	<i>Lbs. cream</i>	<i>Lbs. 4 per cent. milk</i>	<i>Test of cream</i>
20	100.0	0.00	100.0	0.00	100.0	0.00	100.0	0.00	20
21	95.24	4.76	94.45	5.55	94.29	5.71	94.12	5.88	21
22	90.92	9.08	89.48	10.52	89.16	10.84	88.90	11.10	22
23	86.98	13.02	85.00	15.00	84.61	15.39	84.22	15.78	23
24	83.36	16.64	80.96	19.04	80.49	19.51	80.00	20.00	24
25	80.00	20.00	77.30	22.70	76.75	23.25	76.20	23.80	25
26	76.96	23.04	73.96	26.04	73.36	26.64	72.76	27.24	26
27	74.10	25.90	70.88	29.12	70.18	29.82	69.62	30.38	27
28	71.44	28.56	68.00	32.00	67.36	32.64	66.72	33.28	28
29	69.04	30.96	65.44	34.56	64.72	35.28	64.00	36.00	29
30	66.70	33.30	63.00	37.00	62.30	37.70	61.60	38.40	30
31	64.58	35.42	60.73	39.27	60.20	39.80	59.30	40.70	31
32	62.56	37.44	58.72	41.28	57.88	42.12	57.16	42.84	32
33	61.00	39.00	56.71	43.29	55.93	44.07	55.28	44.72	33
34	58.84	41.16	54.91	45.08	54.08	45.92	53.38	46.62	34
35	57.25	42.75	53.20	46.80	52.45	47.55	51.70	48.30	35
36	55.68	44.32	52.00	48.00	50.77	49.23	50.08	49.92	36
37	54.10	45.90	50.02	49.98	49.34	50.66	48.49	51.51	37
38	52.66	47.34	48.70	51.30	47.80	52.20	47.08	52.92	38
39	51.36	48.64	47.37	52.63	46.50	53.50	45.85	54.15	39
40	50.00	50.00	46.00	54.00	45.20	54.80	44.60	55.40	40

TABLE XI

*Showing the Proportions in Which Cream and Skim Milk,  
3 Per Cent. Milk, 3.5 Per Cent. Milk, or 4 Per Cent.  
Milk Must Be Mixed to Make 100 Pounds of 25 Per  
Cent. Cream*

<i>Test of cream</i>	<i>Lbs. cream</i>	<i>Lbs. skim milk</i>	<i>Lbs. cream</i>	<i>Lbs. 3 per cent. milk</i>	<i>Lbs. cream</i>	<i>Lbs. 3.5 per cent. milk</i>	<i>Lbs. cream</i>	<i>Lbs. 4 per cent. milk</i>	<i>Test of cream</i>
25	100.0	0.00	100.0	0.00	100.0	0.00	100.0	0.00	25
26	96.16	3.84	95.66	4.34	95.56	4.44	95.46	4.54	26
27	92.60	7.40	91.68	8.32	91.48	8.52	91.32	8.68	27
28	89.29	10.71	88.00	12.00	87.76	12.24	87.52	12.48	28
29	86.24	13.76	84.64	15.36	84.32	15.68	84.00	16.00	29
30	83.35	16.65	81.50	18.50	81.15	18.85	80.80	19.20	30
31	80.68	19.32	78.58	21.42	78.16	21.84	77.80	22.20	31
32	78.16	21.84	75.92	24.08	75.43	24.57	75.01	24.99	32
33	76.00	24.00	73.36	26.64	72.89	27.11	72.48	27.52	33
34	73.54	26.46	71.02	28.98	70.49	29.51	70.03	29.97	34
35	71.50	28.50	68.80	31.20	68.30	31.70	67.80	32.20	35
36	69.53	30.47	66.67	33.33	66.23	33.77	65.68	34.32	36
37	67.60	32.40	64.72	35.28	64.24	35.76	63.64	36.36	37
38	65.81	34.19	62.95	37.05	62.31	37.69	61.78	38.22	38
39	64.16	35.84	61.22	38.78	60.60	39.40	60.10	39.90	39
40	62.50	37.50	59.50	40.50	58.90	41.10	58.45	41.55	40

TABLE XII

*Showing the Proportions in Which Cream and Skim Milk, 3 Per Cent. Milk, 3.5 Per Cent. Milk, or 4 Per Cent. Milk Must Be Mixed to Make 100 Pounds of 30 Per Cent. Cream*

<i>Test of cream</i>	<i>Lbs. cream</i>	<i>Lbs. skim milk</i>	<i>Lbs. cream</i>	<i>Lbs. 3 per cent. milk</i>	<i>Lbs. cream</i>	<i>Lbs. 3.5 per cent. milk</i>	<i>Lbs. cream</i>	<i>Lbs. 4 per cent. milk</i>	<i>Test of cream</i>
30	100.0	0.00	100.0	0.00	100.0	0.00	100.0	0.00	30
31	96.78	3.22	96.43	3.57	96.36	3.64	96.30	3.70	31
32	93.76	6.24	93.12	6.88	92.98	7.02	92.86	7.14	32
33	91.00	9.00	90.01	9.99	89.93	10.17	89.68	10.32	33
34	88.24	11.76	87.12	12.88	86.88	13.12	86.68	13.32	34
35	85.75	14.25	84.40	15.60	84.15	15.85	83.90	16.10	35
36	83.38	16.62	82.00	18.00	81.52	18.48	81.28	18.72	36
37	81.10	18.90	79.42	20.58	79.14	20.86	79.00	21.00	37
38	78.96	21.04	77.20	22.80	76.80	23.20	76.48	23.52	38
39	76.96	23.04	75.07	24.93	74.70	25.30	74.35	25.65	39
40	75.00	25.00	73.00	27.00	72.60	27.40	72.30	27.70	40

TABLE XIII

*Showing the Proportions in Which Cream and Skim Milk, 3 Per Cent. Milk, 3.5 Per Cent. Milk, or 4 Per Cent. Milk Must Be Mixed to Make 100 Pounds of 35 Per Cent. Cream*

<i>Test of cream</i>	<i>Lbs. cream</i>	<i>Lbs. skim milk</i>	<i>Lbs. cream</i>	<i>Lbs. 3 per cent. milk</i>	<i>Lbs. cream</i>	<i>Lbs. 3.5 per cent. milk</i>	<i>Lbs. cream</i>	<i>Lbs. 4 per cent. milk</i>	<i>Test of cream</i>
35	100.0	0.00	100.0	0.00	100.0	0.00	100.0	0.00	35
36	97.23	2.77	96.97	3.03	96.92	3.08	96.88	3.12	36
37	94.60	5.40	94.12	5.88	94.04	5.96	94.00	6.00	37
38	92.11	7.89	91.45	8.55	91.30	8.70	91.18	8.82	38
39	89.86	10.24	88.92	11.08	88.72	11.28	88.60	11.40	39
40	87.50	12.50	86.50	13.50	86.30	13.70	86.15	13.85	40

TABLE XIV

*Modification Table for Use in Making Approximately Ten Gallons of Ice Cream*<sup>1</sup>

Quality desired	10 per cent.	12 per cent.	15 per cent.	18 per cent.	20 per cent.	22 per cent.	25 per cent.
Kind of stock							
18 per cent. cream...	$3\frac{1}{3}$	4	5	6			
Skim milk .....	$2\frac{2}{3}$	2	1	0			
20 per cent. cream...	3	4	$4\frac{1}{2}$	$5\frac{1}{3}$	6		
Skim milk .....	3	2	$1\frac{1}{2}$	$\frac{2}{3}$	0		
22 per cent. cream...	$3\frac{2}{3}$	$3\frac{1}{3}$	4	5	$5\frac{1}{2}$	6	
Skim milk .....	$3\frac{1}{3}$	$2\frac{2}{3}$	2	1	$\frac{1}{2}$	0	
25 per cent. cream...	$2\frac{2}{5}$	3	$3\frac{3}{5}$	$4\frac{1}{5}$	$4\frac{4}{5}$	$5\frac{1}{5}$	6
Skim milk .....	$3\frac{3}{5}$	3 +	$2\frac{2}{5}$	$1\frac{2}{5}$	$1\frac{1}{5}$	$\frac{2}{5}$	0
30 per cent. cream...	2	$2\frac{1}{2}$ —	3	$3\frac{3}{5}$	4	$4\frac{1}{5}$	5
Skim milk .....	4	$3\frac{1}{2}$ +	3	$2\frac{2}{5}$	2	$1\frac{2}{5}$	1
35 per cent. cream...	2 —	2 +	$2\frac{2}{3}$	3 +	$3\frac{3}{7}$	$3\frac{3}{4}$	$4\frac{2}{7}$
Skim milk .....	4 +	4 —	$3\frac{1}{3}$	3 —	$3\frac{4}{7}$	$2\frac{1}{4}$	$1\frac{5}{7}$
40 per cent. cream...	$1\frac{1}{2}$	$1\frac{1}{5}$	$2\frac{1}{4}$	$2\frac{3}{4}$	3	$3\frac{3}{10}$	$3\frac{3}{4}$
Skim milk .....	$4\frac{1}{2}$	$4\frac{1}{5}$	$3\frac{3}{4}$	$3\frac{1}{4}$	3	$2\frac{7}{10}$	$2\frac{1}{4}$

NOTE.— This table may be used as follows: An 18 per cent. cream is to be frozen. One has a 30 per cent. cream on hand and skim milk. Follow the perpendicular column, headed 18 per cent., downwards until the location is reached which is on the horizontal line bearing the title "30 per cent. cream," at the left. The figures at this point show the proportions of 30 per cent. cream ( $3\frac{1}{3}$  gal.) and of skim milk ( $2\frac{2}{3}$  gal.) needed to make an 18 per cent. cream.

<sup>1</sup> Bulletin 155 Vermont Station.



TABLE XV

*For Use in Making Approximately a Gallon of Ice Cream, Showing Amounts of Cream and Skim Milk Needed to Make 4 Pounds of Fluid Cream Before Freezing. The Figures Represent Pounds or Pints of the Different Materials*<sup>1</sup>

<i>Quality desired</i>	<i>12 per cent.</i>	<i>15 per cent.</i>	<i>18 per cent.</i>	<i>20 per cent.</i>	<i>22 per cent.</i>	<i>25 per cent.</i>
Material on hand to be mixed .....						
18 per cent. cream.....	2.7	3.3	4.0			
Skim milk .....	1.3	.7	0.0			
20 per cent. cream.....	2.4	3.0	3.6	4.0		
Skim milk .....	1.6	1.0	.4	0.0		
22 per cent. cream.....	2.2	2.7	3.3	3.6	4.0	
Skim milk .....	1.8	1.3	.7	.4	0.0	
25 per cent. cream.....	1.9	2.4	2.9	3.2	3.5	4.0
Skim milk .....	2.1	1.6	1.1	.8	.5	.0
30 per cent. cream.....	1.6	2.0	2.4	2.7	2.9	3.3
Skim milk .....	2.4	2.0	1.6	1.3	1.1	.7
35 per cent. cream.....	1.4	1.7	2.1	2.3	2.5	2.8
Skim milk .....	2.6	2.3	1.9	1.7	1.5	1.2
40 per cent. cream.....	1.2	1.5	1.8	2.0	2.2	2.5
Skim milk .....	2.8	2.5	2.2	2.0	1.8	1.5
45 per cent. cream.....	1.1	1.3	1.6	1.8	2.0	2.2
Skim milk .....	2.9	2.7	2.4	2.2	2.0	1.8
50 per cent. cream.....	1.0	1.2	1.4	1.6	1.8	2.0
Skim milk .....	3.0	2.8	2.6	2.4	2.2	2.0

<sup>1</sup> Bulletin 155, Vermont station.

## PREPARATION AND USE OF VISCOGEN

The method of preparing viscogen as given in Bulletin 54 of the Wisconsin station is as follows: "Two and a half parts, by weight, of a good quality of cane sugar (granulated) are dissolved in 5 parts of water; and one part of quick lime gradually slaked in three parts of water. The milk of lime should be poured through a wire strainer to remove coarse, unslaked particles and then added to the sugar solution. The mixture should be agitated at frequent intervals and after two or three hours allowed to settle until the clear supernatant fluid can be siphoned off."

**Method of using viscogen.** Both raw and pasteurized cream contain small amounts of lactic acid. In using viscogen, great care must be exercised not to add too much because even a slight excess of viscogen will give the cream a bitter and soapy flavor. The safest method of procedure is to determine the amount of viscogen necessary to neutralize the acid in a definite amount of cream and from this determine the amount necessary for the whole batch to be treated. The cream must not be completely neutralized, so one-half to two-thirds of the amount of viscogen necessary for complete neutralization will be sufficient to restore the viscosity to the cream.

Babcock and Russell suggest the following method for determining the amount of viscogen to add. By means of a graduated pipette or burette find the number of cubic centimeters of viscogen needed to neutralize the acid in a pound of cream. Multiply the number of cubic centimeters of viscogen used for one pound of cream by the weight of the cream to be treated and find two-thirds of the product, which will be the number of cubic centimeters of viscogen to add.

Example: If it requires 4 c.c. of viscogen to neutralize 1 pound of cream, and there are 100 pounds of cream to be treated, then  $100 \times 4 \text{ c.c.} = 400 \text{ c.c.}$  of viscogen to *neutralize* 100 pounds of cream. But the cream should not be completely neutralized; consequently, the amount of viscogen to add to 100 pounds of cream *to restore the viscosity* will be  $\frac{2}{3}$  of 400 c.c. or 267 c.c.

Larsen and White suggest the use of a smaller quantity of cream for titration and make the necessary calculations by the following method. Assuming that it requires 0.6 c.c. of viscogen to neutralize 25 c.c. of cream, the amount of viscogen needed for say 800 pounds of cream would be  $35:0.6::800:x$  or 13.7 pounds of viscogen. Half this amount is sufficient to restore the viscosity of the cream; therefore,  $\frac{0.6 \times 800}{35 \times 2} = 6.8$  pounds of viscogen.

**Caution.** In many States the laws prohibit the addition of any substance to milk or cream, either for the purpose of neutralizing the acidity or for restoring the viscosity, unless the product is so labeled. It has been suggested that the term "visco-cream" be applied to cream which has been treated with viscogen.

## TO CALCULATE THE SPEED OF PULLEYS

Let  $D$  = the diameter of the driving pulley.

$R$  = speed in revolutions per minute.

$d$  = the diameter of the driven pulley.

$r$  = the speed of the driven pulley in revolutions per minute.

Then  $D \times R = d \times r$ .

1. To calculate the speed of a driven pulley, multiply the diameter and the speed of the driving pulley and divide the product by the diameter of the driven pulley.

$$\frac{D \times R}{d} = r$$

Example: If an 18-inch driving pulley runs 100 revolutions per minute, how fast will a 6-inch driven pulley run?

$$\frac{18 \times 100}{6} = 300 \text{ revolutions per minute.}$$

2. To find the required diameter of a driven pulley when the speed is known, multiply the diameter and the speed of the driving pulley and divide the product by the speed of the driven pulley.

$$\frac{D \times R}{r} = d$$

Example: Taking the same conditions as given above, the calculations would be as follows:

$$\frac{18 \times 100}{300} = 6 \text{ inches.}$$

3. To find the required diameter of a driving pulley when its speed, and the speed and diameter of the driven pulley are known, multiply the speed and the diameter of the driven pulley and divide the product by the speed of the driving pulley.

$$\frac{d \times r}{R} = D$$

Example: If a 6-inch pulley must run 300 revolutions per minute, what size driving pulley will be required if the main shaft runs 100 revolutions per minute?

$$\frac{6 \times 300}{100} = 18 \text{ inches.}$$

4. To calculate the speed of a main shaft when the speed and diameter of the driven pulley and the diameter of the driving pulley are known, multiply the speed of the driven pulley by its diameter and divide the product by the diameter of the driving pulley.

$$\frac{d \times r}{D} = R$$

Example: How fast must an 18-inch pulley run to drive a 6-inch pulley at the rate of 300 revolutions per minute?

$$\frac{6 \times 300}{18} = 100 \text{ revolutions per minute.}$$

## SANITARY CODES

The following rules and regulations are reproduced here as suitable guides for those who are interested in the production of clean, wholesome ice cream.

**New York Sanitary Code.** The code adopted by the association of ice cream manufacturers of New York State is as follows:

I. All factories or shops shall be open to the public at all times.

II. Work rooms must be thoroughly clean and shall be well ventilated and well lighted to the end that there shall be no dark or concealed corners where rubbish or dirt may accumulate.

III. The sidewalls and ceilings of all work rooms shall be well plastered or tiled or ceiled with metal. If plastered or ceiled with metal, they shall be kept well painted with oil paint to the end that they may readily be cleaned and they shall be kept clean at all times.

IV. The floors of all work rooms shall be impermeable and be made of cement, tile laid in cement, or of other suitable non-absorbent material which can be flushed and washed clean with water. Floors shall be sloped to one or more drains which must be properly connected with the sewerage system.

V. Store room for materials shall be kept clean and free from objectionable odors.

VI. Doors, windows and other openings of every work room shall be screened during the fly season, and all work rooms and store rooms shall be kept free from flies at all seasons of the year.

VII. All factories or shops shall have convenient toilet rooms separate and apart from the work rooms, and no toilet room shall be within or connected directly with a work room either by a door, window or other opening. The floors of the toilet rooms shall be of cement, tile or other non-absorbent material, and shall be kept clean at all times. Toilet rooms shall be furnished with separate ventilating flues or pipes, discharging into soil pipes or on the outside of the building in which they are situated. Lavatories and washrooms shall be adjacent to toilet rooms and shall be supplied with soap, running water and clean towels, and shall be maintained in a sanitary condition. Work room employees beginning work and after visiting toilet room shall wash their hands and arms thoroughly in clean water.

VIII. No person shall be allowed to live or sleep in any building used as a factory or shop, unless the factory or shop is separated by impervious walls, without doors or windows or other openings from the parts of the building used for living or sleeping purposes.

IX. No horses, cows or other animals shall be stabled or kept in any building where ice cream is made, unless the factory or shop is separated from the places where the horses, cows or other animals are stabled or kept by impenetrable walls without doors, windows or other openings.

X. No person suffering from an infectious disease, which can be transmitted through ice cream, shall be employed in an ice cream manufacturing plant.

XI. All work room employees shall be clean in person at all times and shall wear clean washable clothing and caps. They shall not touch the product with their hands at any time. Employees may be specially designated to cut and wrap brick ice cream and to fill fancy molds, and as this work necessitates some handling of the product, such employees must be scrupulously clean and wear clean, washable clothing and caps.

XII. All wagons, trucks, drays, cans and tubs, plat-

forms and racks shall be so constructed that they may be readily cleaned, and they shall be kept clean.

XIII. Suitable means or appliances shall be provided for the proper cleansing or sterilizing of freezers, vats, mixing cans or tanks, piping and all utensils used as containers for ice cream, and all tools used in making or the direct handling of ice cream, and all such apparatus, utensils and tools after use shall be thoroughly cleansed and rinsed with boiling water or sterilized with live steam.

XIV. Vessels used in the manufacture and sale of ice cream shall not be employed for any other purpose by any person.

XV. No member shall take back any broken package of ice cream, nor any unbroken package which contains soft or melted ice cream. No ice cream shall under any circumstances be melted and refrozen.

XVI. It is expressly declared that the object of this Code is to insure a clean product, made, stored and handled under cleanly conditions, and no technical defect in the construction of any clause shall relieve any member of the obligation of complying with the letter and spirit of this Code in its entirety.

**The Ohio Sanitary Code.** The code adopted by the Ohio ice cream manufacturers' association is as follows:

1. All factories or shops shall be open to the public at all times.

2. Work rooms must be thoroughly clean and free from dust, foul atmosphere and contamination, and shall be well lighted, to the end that there shall be no dark corners where rubbish or dirt may accumulate.

3. One square foot of glass surface exposed to natural light, unobstructed by buildings or other devices nearer than 10 feet, for each square foot of floor surface of the work rooms must be provided. Basements shall not be used as work rooms unless these provisions can be met.

4. Garbage and all waste material subject to decomposition, must be removed daily to the outside and deposited

in a can provided exclusively for this purpose, composed of impervious material and provided with a tight fitting cover. Covers must be kept on the cans at all times except when entering or removing the material.

5. The sidewalls and ceilings of all work rooms shall be well plastered, tiled or wainscoted, or ceiled with metal or lumber, and shall be well painted, to the end that they may be readily cleaned; and they shall be kept free from dust, dirt and foreign matter and clean at all times.

6. The floors of all work rooms shall be impermeable and be made of cement, tile laid in cement, or other suitable and non-absorbent material, which can be flushed and washed clean with water. Floors shall be sloped to one or more drains, which must be properly connected to the sewerage system.

7. Store and storage rooms for materials must be kept clean and free from objectionable odors.

8. Doors, windows and other openings of every work room shall be screened during the fly season with screens not coarser than 14-mesh wire gauge, or in any other manner equally effective, to keep the work rooms free from flies and vermin at all seasons of the year.

9. All factories or shops shall have convenient toilet rooms, separate and apart from the work rooms, and no toilet rooms shall be within or connected directly with a work room, either by a door, window or other opening. The floors of the toilet rooms shall be of cement, tile or other non-absorbent material, and shall be kept clean at all times. Toilet rooms shall be furnished with separate ventilating flues or pipes discharging into soil pipes, or on the outside of the building in which they are situated. Lavatories and wash rooms shall be adjacent to toilet rooms and shall be supplied with soap, running water and clean towels and shall be maintained in a sanitary condition. Work room employees beginning work and after visiting toilet rooms shall wash their hands and arms thoroughly in clean water.

10. No person shall live or sleep in any building used as



a factory or shop, unless the factory or shop is separated by impervious walls, without doors or windows or other openings from the parts of the building used for living or sleeping purposes.

11. No horses, cows or animals shall be stabled or kept in any building where ice cream is made, unless the factory or shop is separated from the places where the horses, cows or other animals are stabled or kept by impervious walls without doors, windows or other openings.

12. No persons suffering from an infectious disease, which can be transmitted through ice cream, shall work in an ice cream manufacturing plant.

13. All work room employees shall be clean in person at all times and shall wear clean, washable clothing and caps. They shall not smoke or chew tobacco while at work. They shall not touch the product with their hands at any time. Employees may be specially designated to cut and wrap brick ice cream and to fill fancy molds and, as this work necessitates some handling of the product, such employees must be scrupulously clean and wear clean, washable clothing and caps.

14. All wagons, trucks, drays, cans and tubs, platforms and racks, shall be so constructed that they may readily be cleaned and they shall be kept clean. Utensils must be of smooth, nonabsorbent material, as tin, or tinned copper, the seams of which are flushed smooth with solder.

15. Suitable means or appliances shall be provided for the proper cleansing or sterilizing of freezers, vats, cans, mixing cans or tanks, piping and all utensils used as containers for ice cream or raw material, and all tools used in making or the direct handling of ice cream, and all such apparatus, utensils, and tools after use shall be thoroughly cleansed and scalded with boiling water or sterilized with steam. The water supply for washing utensils must be free from contamination.

16. No persons shall use any vessel used in the manufacture and sale of ice cream for any other purpose.

17. Soft or melted ice cream or any other ice cream shall not be refrozen under any circumstance.

18. Milk and cream must be stored only in clean receptacles in clean refrigerators. Milk or cream which has undergone various fermentations, gaseous or bitter, shall not be used in the manufacture of ice cream. Flavoring extracts, condiments, syrups, fruits, nuts and other materials used as food must be securely protected from dust, dirt, vermin, flies and other contamination, and must be kept and stored only in clean receptacles. Decomposed, decayed, fermented, rancid food material shall not be used. Ice cream must be stored only in clean receptacles in clean refrigerators.

19. It is expressly declared that the object of this code is to insure a pure and clean product, made, stored and handled under clean conditions, and no technical defect in the construction of any clause shall relieve any person of the obligation of complying with the letter and spirit of this code in its entirety.

20. All creamery and condensory operators, ice cream manufacturers, and all other dealers in milk and cream, and their customers, must cleanse all receptacles used in shipping milk and cream as soon as they are emptied, when same are to be returned by railroad, trolley or boat, in order to prevent the development of dangerous bacteria to threaten the health of the consumers of the product.

---

The code adopted by the Ohio association has since been adopted by the dairy and food division of the agricultural commission of Ohio. The New York association code has been adopted with certain modifications by the New York board of health.<sup>1</sup>

**To make an emulsion** with sweet unsalted butter and whole sweet milk, for each 10 gallons of cream use: <sup>2</sup>

<sup>1</sup> *Ice Cream Trade Journal*.

<sup>2</sup> Courtesy of DeWitt & Co., Denver.

<i>For Cream Testing</i>	<i>Use Whole Sweet Milk</i>	<i>Unsalted Butter</i>
10%	77 lb.	6 $\frac{1}{2}$ lb.
16%	67 lb.	16 lb.
20%	66 lb.	17 lb.

To make an emulsion with sweet unsalted butter and skim milk, use:

<i>For Cream Testing</i>	<i>Use Skim Milk</i>	<i>Unsalted Butter</i>
10%	73 lb.	10 lb.
16%	67 lb.	16 lb.
20%	63 lb.	20 lb.

To make an emulsion with skim milk powder and unsalted butter:

<i>For Cream Testing</i>	<i>Use Water</i>	<i>Use Butter</i>	<i>Skim Milk Powder</i>
10%	66 lb.	10 lb.	7 lb.
16%	60 lb.	16 lb.	7 lb.
20%	56 lb.	20 lb.	7 lb.

When using skim milk powder put the water in the agitator and while it is warming up, put in the skim-milk powder. When the powder is thoroughly dissolved add the unsalted butter and treat the mixture the same as any other emulsion.

## LEGAL STANDARDS FOR DAIRY PRODUCTS

(From B. A. I. Circular 218 U. S. Dept. of Agriculture, 1913)

State	Milk		Cream	Butter	Whole milk cheese	Condensed milk		Ice cream	
	Total solids	Solids not fat				Fat	Total solids	Fat	Plain
Alabama (*)	...	..	...	...	...	...	...	...	...
Arizona (*)	...	..	...	...	...	...	...	...	...
Arkansas (†)	...	..	...	...	...	...	...	...	...
California	11.5	8.5	18.0	80.0	(1)50	(2)	12.0	12.0	...
Colorado	...	..	(3)16.0	80.0	(1)50	...	14.0	12.0	...
Connecticut	11.75	8.5	16.0	...	...	...	...	...	...
Delaware (*)	...	..	...	...	...	...	...	...	...
District of Columbia	12.5	9.0	20.0	83.0	...	...	...	...	...
Florida	11.75	8.5	18.0	82.5	(1)50	(4)28.0	12.0	...	...
Georgia	11.75	8.5	18.0	82.5	(1)50	28.0	14.0	12.0	...
Hawaii	11.5	8.5	...	...	...	28.0	7.7	...	...
Idaho	11.2	8.0	18.0	82.5	30	(2)	(2)	14.0	12.0
Illinois	11.5	8.5	18.0	82.5	(1)50	(2)	(2)	8.0	...
Indiana	...	8.5	18.0	82.5	(1)50	28.0	27.5	8.0	...
Iowa	12.0	..	16.0	(6)80.0	...	...	...	12.0	...
Kansas	11.75	8.5	(3)18.0	80.0	(1)50	(2)	(2)	14.0	12.0
Kentucky	12.5	8.5	18.0	82.5	(1)50	28.0	26.76	14.0	12.0
Louisiana	...	8.5	18.0	...	...	(2)	(2)	...	...
Maine	11.75	8.5	18.0	...	...	...	...	...	...
Maryland	12.5	..	18.0	...	...	(2)	(2)	...	...
Massachusetts	12.15	..	15.0	...	...	...	...	4.0	6.0
								...	...



## LEGAL STANDARDS FOR DAIRY PRODUCTS

State	Milk		Cream	Butter	Whole milk cheese		Condensed milk		Ice cream	
	Total solids	Solids not fat			Fat	Fat	Total solids	Fat	Total solids	Fat
South Dakota	...	8.5	3.25	18.0	80.0	(1)50	28.0	(1)27.5	14.0	12.0
Tennessee	...	8.5	3.25	...	...	...	...	...	...	...
Texas	...	8.5	3.25	...	...	...	...	...	...	...
Utah	12.0	9.0	3.2	18.0	80.0	(1)50	(2)	(2)	8.0	...
Vermont	(12)12.5	9.25	...	...	...	...	...	...	...	...
Virginia	...	8.5	3.25	18.0	82.5	30	(2)	(2)	...	...
Washington	11.75	8.5	3.25	18.0	...	30	...	...	...	...
West Virginia (*)	12.0	8.75	3.25	18.0	...	...	...	...	...	...
Wisconsin	...	...	...	...	...	...	...	...	14.0	...
Wyoming	...	8.5	3.0	18.0	82.5	(1)50	28.0	8.0	14.0	...
	...	8.5	3.25	18.0	82.5	(1)50	28.0	(13)	...	12.0

(\*) No. State standards.

(†) Federal rulings adopted.

(1) Percentage of fat based on total solids.

(2) Fat, 7.8 per cent.; total solids plus fat 34.3 per cent.

(3) For buttermaking, 25 per cent. fat.

(4) This standard for sweetened condensed milk; "Evaporated milk," solids, 24 per cent.; fat, 7.8 per cent.

(5) No report; 1910 standard given.

(6) By weight.

(7) Not more than 0.2 per cent. "filler."

(8) Must correspond to 11.5 per cent. solids in crude milk.

(9) If artificially colored.

(10) Must correspond to 12 per cent. solids in crude milk.

(11) 23 to 24 per cent. solids; 7.9 per cent. fat; 24 to 25 per cent. solids, 7.8 per cent. fat; 25 to 26 per cent. solids, 7.7 per cent. fat; 26 per cent. solids, 7.6 per cent. fat.

(12) In May and June, solids 12 per cent.

(13) Fat, 27.5 per cent. of total solids.

## THE BENKENDORF METHOD OF DETERMINING THE SWELL IN ICE CREAM <sup>1</sup>

**The apparatus** used in making the test consists of an ice cream sampler, a 250 c.c. Florence flask, a 200 c.c. Florence flask, a funnel or a 250 c.c. beaker, a burette and a 1 c.c. pipette. All of these, except the ice cream sampler, can be readily obtained from any supply house.

The ice cream sampler is a cylinder, about  $1\frac{5}{16}$  inches in diameter (inside measurements) and about  $2\frac{1}{4}$  inches long, preferably made of thin brass tubing. The sampler when filled should contain exactly 50 c.c. of ice cream. For testing ice cream that has been packed and has fully hardened the sampler should be provided with a handle. This type of sampler is also preferred where the ice cream container has a small diameter. These samplers are open at both ends. The sampler for use with the continuous type of ice cream freezer or for determining the swell of soft ice cream is closed at the lower end.

**Making the overrun test.** A sample of 50 c.c. of the ice cream is obtained by pressing the sampler down into the hardened ice cream until it is entirely below the surface. Allow the sampler to remain there for a moment to get cold and withdraw the sampler and the ice cream which it contains. By means of a case knife or a piece of tin the protruding ice cream can be removed from both ends of the tube. Where a continuous freezer is used, the sampler may be held under the spout of the freezer and filled with little difficulty. The sample is transferred from the sampler to the funnel, the stem of which is inserted in the neck of the 250 c.c. flask. In order to readily hold the 50 c.c. of

<sup>1</sup> From Bul. 241, Wis. Sta., Prof. G. H. Benkendorf.

ice cream the opening of the funnel should be three inches in diameter.

To transfer the ice cream from the funnel to the 250 c.c. flask it is melted by pouring over it exactly 200 c.c. of hot water.

In case a funnel is not available, equally good results can be obtained by transferring the sample of ice cream to a 250 or 300 c.c. beaker. By using the hot water from the 200 c.c. flask it can be melted and then transferred to the 250 c.c. flask.

**To reduce the foam.** All melted ice cream contains more or less foam which appears in the neck of the flask and must be destroyed before it is filled to the 250 c.c. mark. The foam can be eliminated by introducing a measured amount of ether directly into it. Usually 1 c.c. of ether will suffice. As soon as the foam has disappeared the flask can be filled with water to the 250 c.c. mark. This is best done by means of a burette.

**How calculations are made.** The number of cubic centimeters of water and ether used to bring the volume up to the 250 c.c. mark, represents the shrinkage which the 50 c.c. of ice cream has undergone when melted. Subtracting this shrinkage from 50 gives the original volume of the mix before freezing. It is then an easy matter to determine the per cent. of overrun by dividing the number of cubic centimeters of shrinkage by the number of cubic centimeters in the original mixture. This can be illustrated as follows:

Sample used .....	50	c.c.
Ether used to reduce foam .....	1	c.c.
Water used to bring to 250 c.c. mark .....	15.5	c.c.
Water and ether used (15.5 + 1) .....	16.5	c.c.
Volume of mix before freezing (50 - 16.5) .....	33.5	c.c.
Per cent. overrun (16.5 ÷ 33.5) .....	49.9	%



## INDEX



## INDEX

- ACIDITY OF CREAM ..... 1  
 testing the ..... 5  
 rapid tests for ..... 8  
 Acid, lactic ..... 261  
 Acid standard, The ..... 9  
 Acid tests ..... 4, 5  
 ADVERTISING ..... 252  
 paid reading ..... 252  
 society column ..... 253  
 value of ..... 252  
 ALBUMEN ..... 195  
 putrefaction of ..... 22  
 ALMOND ..... 112  
 and pistachio ice cream ..... 112  
 biscuits ..... 120  
 Alkali solutions ..... 6  
 AMMONIA ..... 164, 177  
 boiling point ..... 164  
 compressor ..... 166  
 condensers ..... 170  
 properties of ..... 179  
 pump ..... 168  
 weight of ..... 164  
 Antiseptics ..... 26  
 Appearance of ice cream ..... 195  
 Apple ice cream ..... 107  
 Artificial extracts, flavor of ..... 192  
 Aufait ..... 93  
 ;  
*Bacillus bulgaricus* ..... 261  
 BACTERIA ..... 19  
 acids produced by ..... 21  
 conditions affecting ..... 24, 206  
 fat splitting ..... 22  
 fermentative ..... 21  
 from fruit ..... 29  
 gas producing ..... 22  
 growth of ..... 19  
 in condensed milk ..... 31  
 in sour cream ..... 87  
 in gelatin ..... 31  
 in milk ..... 21  
 in old ice cream ..... 31  
 normal milk ..... 21  
 parasitic ..... 21  
 resistance to ..... 21  
 saprophytic ..... 19  
 sources of ..... 28  
 special cultures of ..... 260, 261  
 Bacterial content of pasteur-  
 ized cream ..... 29  
*Bacterium Caucasicum* ..... 261  
 Banana ice cream ..... 106  
 Barn flavors ..... 197  
 Batch freezer ..... 221  
 Batch mixer, The ..... 214, 225  
 Binders ..... 58  
 Biscuits ..... 120  
 Bisque ice cream ..... 93, 99  
 Bitter cream flavor ..... 197  
 Blanching nuts ..... 74  
 Blended flavor ..... 100, 191  
 BRICK ICE CREAM ..... 95, 97  
 fancy center ..... 139  
 layer ..... 137, 144  
 molds ..... 138  
 BRINE FREEZERS ..... 219  
 selecting ..... 224  
 temperature of brine for ..... 157  
 Brine hardening ..... 174  
 Brine tank agitator ..... 189  
 Body and texture ..... 194, 200  
 British Thermal Units ..... 160  
 BULGARIAN CULTURES ..... 261  
 propagating ..... 262  
 Burned flavor ..... 197

- Burnt almond ice cream ....112  
 BUTTER .....257  
   for homogenizing cream ...257  
   ice cream .....113  
 BUTTERMILK .....259  
   flavor of .....260  
   prepared .....260, 262  
 Calcium chloride .....187  
 Can washer .....227  
 CARAMEL ICE CREAM.....101  
   syrup for .....66, 101  
 Casein .....195  
 Cassell's fancy centers .....141  
 Centrifugal emulsers .....236  
 CHEESE .....258  
   cottage .....262  
   fancy soft .....265  
 CHERRY ICE CREAM .....107  
   biscuits .....121  
   sherbet .....127  
 Chestnut ice cream .....114  
 CHOCOLATE ICE CREAM .....100  
   flavor of .....101  
   paste .....101  
   syrup .....66  
 Cinnamon .....100  
 CLASSIFICATION OF ICE CREAMS 92  
   Larsen & White's .....95  
   Mortensen's .....92  
   Pure Food .....92  
   University of Nebraska...97  
   Washburn's .....94  
 Cleaning and sterilizing ....208  
 Coarse texture .....198  
 Cocoa .....101  
 Coffee ice cream .....114  
 Colloids .....58, 64  
 Color, ice cream ...136, 196, 199  
 Coloring matter .....89  
 Competition .....273  
 Composite samples .....34  
 COMPRESSOR, AMMONIA .....166  
   capacity .....167, 168  
   ice making capacity of ...186  
   stuffing boxes of .....168  
   valves of .....169  
 CONDENSED MILK .....48  
   bulk .....51  
   flavor .....197  
   formula containing .....102  
 CONDENSER, THE .....49  
   ammonia .....170  
   double pipe .....171, 183  
   open air .....170  
   submerged .....171  
 Conveyor .....211  
 CONVERTER .....233  
   DeWitt & McCaddon ....234  
 Cooked mixtures, curdling of 90  
 Cooking the mix .....89  
 Cooksley Creamer .....237  
 Coolers .....210, 211  
 COST .....242  
   accounting .....242  
   delivery .....246  
   of making ice cream .....275  
 COTTAGE CHEESE .....258, 262  
   composition .....263  
   food value .....263  
   starter for .....263  
 Cranberry sherbet .....126  
 CREAM .....1  
   acidity of .....86  
   French cooked .....109  
   grading .....2, 4, 9  
   homogenized .....48  
   neutralizing acid in .....86  
   odors in .....86  
   off flavored .....193  
   per cent. of fat in .....87  
   preventing bacterial growth  
   in .....39  
   pump .....214  
   sampling .....33  
   selecting .....86  
   storage .....210  
   sweet .....258  
   testing .....5, 34  
   tests, reading .....36  
   use of viscogen in .....86  
   whipped .....266  
 Creamers .....233, 237  
 Currant ice cream .....107  
 Custard .....111  
 CURDLING .....61

- cooked mixtures ..... 90  
 due to acid in butter ..... 238  
 due to fruit acid ..... 88  
 due to gelatin ..... 61  
 ,  
 Dairy products as side lines 255  
 Defects in color ..... 199  
 Defects in flavor ..... 197  
 Defects in texture ..... 198  
 Definition of ice cream ..... 92  
 Degrees, Mann's ..... 6  
 DeLaval Emulser ..... 236  
 Delivery costs ..... 246  
 DeWitt & McCaddon Con-  
 verter ..... 234-236  
 Difficulties in scoring ice  
 cream ..... 191  
 Disease bacteria in milk ..... 24  
 Disinfectants ..... 26  
 Double pipe condensers 171, 183  
 Driers ..... 228  
 Drip method of hardening . 174  
 Dry air hardening ..... 151, 175  
 Durability of freezers ..... 222  
  
 Effects of stabilizers on swell 62  
 EGGS ..... 89  
 albumen ..... 22  
 EMULSER, THE ..... 233  
 advantages of ..... 238  
 centrifugal ..... 236  
 cost of ..... 233  
 DeLaval ..... 236  
 Hauk's ..... 234  
 preparing mixtures for ..... 238  
 Endothermal actions ..... 162  
 Expansion coils ..... 173  
 Expansion valve ..... 172  
 Extracts ..... 69-78  
  
 FACTORY, THE ..... 202  
 by-products ..... 255  
 management ..... 239  
 Farrington's alkali tablets ..... 6  
 Fat splitting bacteria ..... 22  
 Fancy center bricks ..... 139  
 FERMENTED MILK ..... 259  
 marketing ..... 262  
  
 Filbert ice cream ..... 114  
 Filler ..... 58  
 Flavoring ..... 88, 90  
 FLAVOR ..... 65  
 barn ..... 197  
 bitter cream ..... 197  
 blended ..... 100  
 burnt almond ..... 112  
 butter ..... 113  
 coarse ..... 197  
 defects in ..... 197  
 extract ..... 69  
 flat ..... 193  
 for mousse ..... 117  
 foreign ..... 192  
 fruit ..... 67, 69  
 gelatin ..... 197  
 gum ..... 197  
 harsh ..... 192  
 high ..... 191  
 kinds of ..... 109  
 lemon ..... 67  
 low ..... 192  
 metallic ..... 197  
 mild ..... 192  
 molded ice cream ..... 136  
 moldy ..... 197  
 natural ..... 192  
 nut ..... 73, 193  
 of the cream ..... 193  
 oily ..... 197  
 old cream ..... 197  
 orange ..... 67  
 pineapple ..... 68  
 pistachio ..... 73  
 qualities of ..... 191  
 rancid nut ..... 197  
 stale fruit ..... 197  
 starch ..... 197  
 strawberry ..... 68  
 sour cream ..... 197  
 unclean ..... 197  
 weedy cream ..... 197  
 yeasty ..... 193  
 FORMULAS, ice creams and ices 99  
 almond ..... 103, 112  
 almond biscuits ..... 120  
 almond and pistachio ..... 103

- apple .....107  
 apricot .....104  
 banana .....106  
 bisque .....93, 99  
 biscuits .....120, 121  
 butter .....113  
 caramel .....101  
 cherry .....107  
 chestnut .....114  
 chocolate .....100  
 cocoa .....101  
 coffee .....108, 114  
 containing condensed.....102  
 cranberry .....104, 126  
 currant .....107  
 custard, frozen .....111  
 fancy ice creams .....117, 134  
 filbert .....103, 114  
 French cooked .....109  
 frozen custard .....111  
 fruit granite .....128  
 fruit ice cream .....104  
 fruit punch .....130  
 granite .....128  
 grape ice cream.....108  
 grape sherbet ....127, 128, 133  
 hazelnut ice cream .....103  
 hokey pokey .....116  
 lacto .....131, 133  
 lemon ice .....122, 124, 127  
 lemon ice cream .....105  
 Manhattan pudding .....111  
 maple .....101  
 milk sherbets .....128  
 mousse .....117, 120  
 Neapolitan .....109  
 Nesselrode pudding .....110  
 nut ice cream .....102, 103  
 orange .....105, 122  
 peach ice cream .....104, 118  
 peppermint .....108  
 Philadelphia .....99  
 pineapple cream souffle ....119  
 pineapple ices and sherbets  
     .....123, 125, 127, 133  
 pineapple ice cream .....104  
 pistachio .....103  
 plum pudding .....111  
 puddings .....110, 111  
 punch .....129, 130  
 raspberry .....106, 107, 133  
 rose ice cream .....108  
 royal ice cream .....115  
 sherbets .....124, 128  
 souffle .....119, 120  
 special .....117  
 strawberry .....104  
 Thanksgiving Day special.125  
 tutti frutti .....110  
 vanilla biscuits .....120  
 vanilla ice cream .....99  
 walnut .....103  
 water ices .....122, 123  
 wintergreen .....108  
 Formaldehyde, test for .....14  
 Frappe .....195  
 FREEZER, THE .....219  
     batch .....221  
     brine .....155, 219  
     continuous .....220  
     durability of .....222  
     efficiency of .....223  
     tub .....223  
     types of .....155  
 FREEZING .....148  
     brine .....157  
     control of .....155  
     effects of, on swell ..148, 195  
     effects of, on texture .....195  
     manner of .....195  
     mousse .....117  
     prolonged .....153  
     proper degree of .....149  
     rapid .....153  
     record .....241  
     time required for .....152  
     with ice and salt .....156  
 French cooked cream .....109  
 French ice cream .....94  
 FRUIT ICE CREAM .....88, 104  
     preparation of fruit for ..104  
 Fruit extracts .....69  
 GELATIN .....60  
     advantages of .....61  
     as a stabilizer.....89

- flavor ..... 197  
 the use of ..... 63  
 Gerber's fermentation test ... 12  
 GRANITES ..... 91, 96, 128  
 texture of ..... 195  
 Granular texture ..... 153  
 GRAPE ..... 108  
 sherbet ..... 127  
 milk sherbet ..... 128  
 Growth of bacteria ..... 19  
 GUMS ..... 60  
 flavor of ..... 197  
 as stabilizers ..... 89  
 HARDENING ..... 151  
 brine ..... 174  
 dry air ..... 151, 175  
 rooms ..... 216  
 slush box ..... 151  
 still air ..... 175  
 Harsh flavor ..... 192  
 Hauk's Emulser ..... 231  
 High flavor ..... 191  
 Hokey Pokey ..... 116  
 Homogenizer, The ..... 229  
 HOMOGENIZED CREAM ..... 48, 54  
 as a stabilizer ..... 89  
 viscosity of ..... 54  
 HOMOGENIZATION ..... 53  
 of natural cream ..... 54  
 the process of ..... 54  
 ICE ..... 160  
 and salt, proportions of .. 156  
 cans ..... 187  
 crusher ..... 216, 226  
 making ..... 186  
 machinery ..... 188  
 time to freeze ..... 187  
 ICES AND SHERBETS ... 90, 93, 95  
 cranberry ..... 126  
 cherry ..... 127  
 difference in composition  
   of ..... 90, 96  
 flavor of ..... 91  
 grape ..... 127, 128  
 lemon ..... 124, 127, 128  
 milk ..... 128  
 orange ..... 124, 127  
 pineapple ..... 125, 127  
 sugar for ..... 90  
 Thanksgiving Day special.. 126  
 use of syrup gauge in..... 91  
 ICE CREAM, classification of .. 92  
 almond ..... 103, 112  
 almond biscuits ..... 120  
 almond and pistachio,  
   without nuts ..... 103  
 apple ..... 107  
 apricot ..... 104  
 banana ..... 106  
 bisque ..... 93, 99  
 body and texture of ..... 58  
 brick ..... 95  
 butter ..... 113  
 caramel ..... 101  
 cherry ..... 107  
 chestnut ..... 114  
 chocolate ..... 100  
 cocoa ..... 101  
 coffee ..... 108, 114  
 cost of making ..... 276  
 currant ..... 107  
 custard, frozen ..... 111  
 fancy ..... 95, 117, 134  
 filbert ..... 103, 114  
 formulas ..... 99  
 French cooked ..... 109  
 frozen custard ..... 111  
 fruit ..... 92, 104  
 grape ..... 108  
 hardening ..... 151  
 hazel nut ..... 103  
 hokey pokey ..... 116  
 lemon ..... 105  
 Manhattan ..... 111  
 maple ..... 101  
 mousse ..... 93, 96  
 molded ..... 145  
 Neapolitan ..... 94, 97, 109  
 New York ..... 94  
 nut ..... 92  
 orange ..... 105  
 parfait ..... 93  
 peach ..... 104  
 peppermint ..... 108

- Philadelphia .....94, 97, 99  
 pineapple .....104  
 pistachio .....103, 112  
 plum pudding .....111  
 powders .....89  
 raspberry .....106, 107  
 rose .....108  
 royal .....115  
 strawberry .....104  
 tutti frutti .....110  
 vanilla .....99  
 walnut .....103  
 wintergreen .....108  
 Indicator .....5  
 Individual molds 95, 97, 137, 142  
 INSULATING .....184  
   brine tank .....186  
   hardening rooms .....186  
   materials .....184  
   slush boxes .....186  
 Insulator, properties of .....184
- LACTIC ACID .....6  
   bacteria .....260  
   in whipping cream .....268  
 LACTO .....98, 131  
   formulas .....133  
   milk for .....131  
   preparing the mix .....132  
   pineapple .....133  
   raspberry .....133  
 Lactone .....261  
 LEMON .....67  
   extract .....71  
   milk sherbet .....128  
   sherbet .....124, 127  
 Losses, elimination of .....242  
 Low speed, effects of .....154
- MACHINERY .....207  
   kinds of .....216  
   required .....218  
 Management, Ice cream fac-  
   tory .....239  
 Manhattan pudding .....111  
 Manufacture of buttermilk. 260
- MAPLE ICE CREAM .....101  
   sugar for .....66  
   syrup for .....66, 101  
 Metallic cream flavor .....197  
 Mexican vanilla beans .....74  
 Mild flavor .....192  
 MILK .....33  
   condensed .....51  
   preservatives in .....13  
   sherbet .....98, 127  
   solids .....59, 194  
   sugar .....195  
 MILK POWDER .....48, 51  
   as a stabilizer .....51, 53  
   in homogenized cream .....53  
   in ice cream .....51, 89  
   process .....52  
 Mix, The .....152  
 Mixers .....214  
 MOLDS .....138  
   brick .....138  
   fancy center .....139  
   individual .....142  
   preparation of .....144  
   removing ice cream from 145  
   sectional .....138  
 Moldy nut flavor .....197  
 Mousse .....93, 96, 97, 117
- Neapolitan ice cream 94, 109, 228  
 Nesselrode pudding .....110  
 NEUFCHATEL CHEESE .....264  
   manufacture of .....264-265  
 Normal milk bacteria .....21  
 Numbering packing tubs .....252  
 NUTS .....73  
   almond .....73  
   blanching .....74  
   filberts .....114  
   flavor of .....192  
   pistachio .....103  
   preparation of .....103
- Oil trap, The .....171  
 Oily flavor .....197  
 Old cream flavor .....197



- ORANGE ..... 67  
 extract ..... 71  
 ice cream ..... 105  
 sherbet ..... 124, 127
- Package ..... 196, 200
- PACKING ..... 150  
 cans for ..... 134, 150  
 sherbets ..... 123
- PACKING TUBS ..... 247  
 numbering ..... 251
- Parfait ..... 93
- PASTEURIZED CREAM ..... 29  
 storage of ..... 45  
 whipping ..... 266
- PASTEURIZERS ..... 210, 211  
 continuous ..... 40-41  
 intermittent ..... 42
- PASTEURIZATION ..... 27  
 advantages of ..... 46  
 cost of ..... 47  
 effects of, on swell ..... 45
- Peach mousse ..... 118
- Pepper cream cheese ..... 265
- Peppermint ..... 71, 108
- Permanency ..... 200
- PINEAPPLE ..... 68  
 lacto ..... 133  
 sherbet ..... 125, 127  
 souffle ..... 119
- Pistachio ice cream ..... 103
- Plum pudding ..... 111
- Poisons, ice cream ..... 22
- Preparing the mix ..... 86
- Preservatives, tests for ..... 13
- Profitable side lines ..... 255
- Profits ..... 275
- Properties of ammonia ..... 179
- Ptomaines ..... 22, 23
- Puddings ..... 93, 110, 111
- PUNCH ..... 94, 96  
 fruit ..... 130  
 Roman ..... 129
- Rancid nut flavor ..... 197
- Rapid freezing ..... 153
- Raspberry ice cream ..... 106
- Raspberry lacto ..... 133
- Records ..... 239
- Refrigerating capacity .. 177, 178
- REFRIGERATION ..... 160  
 brine ..... 173  
 carbon dioxide ..... 164  
 direct expansion ..... 173  
 ice cream ..... 167  
 measure of ..... 160  
 natural ice ..... 160  
 of bricking rooms' ..... 174  
 ton of ..... 162
- REPORTS ..... 243  
 ice cream maker's ..... 241  
 daily ..... 243  
 deliveryman's ..... 248  
 engineer's ..... 244, 245
- Retarder, The ..... 42
- Richness of ice cream .. 198, 200
- Ripening cream ..... 152
- Rose ice cream ..... 108
- Roman punch ..... 129
- Royal ice cream ..... 115
- Rule for standardizing ..... 82
- Samples, composite ..... 34
- Sandwich, nut cheese ..... 265
- Sanitation ..... 205
- Sanitary codes ..... 293
- Sauce for souffle ..... 120
- SCORE CARDS ..... 196  
 Mortensen's ..... 196-199  
 University of Nebraska .. 201  
 Washburn's ..... 199
- Scoring ice cream ..... 191
- Sediment tests ..... 11
- Selling ..... 242, 273
- SHERBETS ..... 93, 96, 97  
 freezing ..... 126, 152  
 formulas ..... 124  
 general formula for ..... 127  
 milk ..... 98  
 plain ..... 98  
 preparing the fruit for .. 123  
 texture of ..... 124
- Shipping department ..... 216
- Shipping tags ..... 250
- Side lines ..... 255
- Skim milk ..... 258
- Sodium chloride brine ..... 187

- Sodium hydroxide .....86  
 Soft cheese .....265  
 Sorbet .....96  
 Souffle .....94, 119  
 SOUR CREAM .....87  
   use of, in ice cream .....86  
   flavor .....197  
 Special formulas .....117  
 Speed of the dasher .....154  
 Speed of pulleys, calculating 291  
 Spices .....65  
 Spores .....27  
 STABILIZERS .....58, 195  
   condensed milk .....89  
   effects of, on swell .....62  
   egg as a .....59, 89  
   gelatin .....60, 89  
   gum .....59, 89  
   milk powder .....89  
   precautions regarding .....89  
   prepared .....62, 89  
   starchy .....59  
   use of .....89  
 Standard, butter fat .....79  
 STANDARDIZING .....79  
   diagram .....81  
   milk and cream .....80  
   rule for .....82  
   the ice cream mix .....82-84  
 STARCH .....89  
   flavor .....197  
 Starters .....260, 263  
 Steam kettles .....230  
 Sterilizer .....228  
 Sterilizing .....208  
 Sticky texture .....195, 198  
 STRAWBERRY FLAVOR .....68  
   ice cream .....104  
   preparation of .....69  
   mousse .....119  
 SUGARS .....65  
   for sherbets .....90  
   in the mix .....87  
   in meringue .....88  
   maple .....66  
   preparation of .....88  
   pulverized .....88  
   vanilla .....66  
 Sweet cream .....258  
 Sweetness, lack of .....197  
 SYRUP .....65  
   caramel .....66  
   chocolate .....66  
   gauge .....91  
   maple .....66  
   simple .....88, 91  
 TESTING, for Acid .....5  
   butter fat .....84  
   cream .....34  
   the purity of milk .....10  
   special acids for .....84  
 TEXTURE .....194, 195, 200  
   buttery .....198  
   coarse .....198  
   conditions affecting .....195  
   defects in .....198  
   granular .....153  
   icy .....198  
   of granites .....195  
   of sherbets .....123  
 Thanksgiving day special...126  
 Toxins .....23  
 Transferring .....150  
 Tub freezer .....219  
 Tutti Frutti ice cream.....110  
 Tyrotoxicon .....23  
 UNIFORMITY .....240  
   of color .....196  
 Use of starter .....263  
 Use of records .....239  
 Vacuum pan .....49  
 Valves .....169  
 VANILLA .....74  
   artificial .....78  
   beans .....75  
   biscuits .....120  
   extract .....77  
   sugar .....66  
 Vanillin .....77  
 Ventilation .....206  
 VISCOGEN .....86  
   in whipping cream .....269  
   preparation and use of .....290

Walls .....	206	WHIPPING CREAM .....	266
Walnut ice cream .....	103	time for .....	268
Wash room .....	208	use of viscogen in .....	269
Weigh can .....	210	Wintergreen .....	71, 108
Whipped cream .....	267	Winter trade .....	254

# STANDARD BOOKS

PUBLISHED BY

## ORANGE JUDD COMPANY

NEW YORK

ASHLAND BUILDING  
315-321 Fourth Avenue

CHICAGO

PEOPLE'S GAS BUILDING  
150 Michigan Avenue

---

*Any of these books will be sent by mail, postpaid, to any part of the world, on receipt of catalog price. We are always happy to correspond with our patrons, and cordially invite them to address us on any matter pertaining to rural books. Send for our large illustrated catalog, free on application.*

---

### First Principles of Soil Fertility

By ALFRED VIVIAN. There is no subject of more vital importance to the farmer than that of the best method of maintaining the fertility of the soil. The very evident decrease in the fertility of those soils which have been under cultivation for a number of years, combined with the increased competition and the advanced price of labor, have convinced the intelligent farmer that the agriculture of the future must be based upon more rational practices than those which have been followed in the past. We have felt for some time that there was a place for a brief, and at the same time comprehensive, treatise on this important subject of Soil Fertility. Professor Vivian's experience as a teacher in the short winter courses has admirably fitted him to present this matter in a popular style. In this little book he has given the gist of the subject in plain language, practically devoid of technical and scientific terms. It is pre-eminently a "First Book," and will be found especially valuable to those who desire an introduction to the subject, and who intend to do subsequent reading. Illustrated. 5x7 inches. 265 pages. Cloth. Net, \$1.00

### The Study of Corn

By PROF. V. M. SHOESMITH. A most helpful book to all farmers and students interested in the selection and improvement of corn. It is profusely illustrated from photographs, all of which carry their own story and contribute their part in making pictures and text matter a clear, concise and interesting study of corn. Illustrated. 5x7 inches. 100 pages. Cloth . . . . . Net, \$0.50

## **The Management and Feeding of Cattle**

By PROF. THOMAS SHAW. The place for this book will be at once apparent when it is stated that it is the first book that has ever been written which discusses the management and feeding of cattle, from the birth of the calf until it has fulfilled its mission in life, whether on the block or at the pail. The book is handsomely printed on fine paper, from large, clear type. Fully illustrated.  $5\frac{1}{2}\times 8$  inches. 496 pages. Cloth. . . . . Net, \$2.00

## **The Farmer's Veterinarian**

By CHARLES WILLIAM BURKETT. This book abounds in helpful suggestions and valuable information for the most successful treatment of ills and accidents, and disease troubles. A practical treatise on the diseases of farm stock; containing brief and popular advice on the nature, cause and treatment of disease, the common ailments and the care and management of stock when sick. It is profusely illustrated, containing a number of halftone illustrations, and a great many drawings picturing diseases, their symptoms and familiar attitudes assumed by farm animals when affected with disease, and presents, for the first time, a plain, practical and satisfactory guide for farmers who are interested in the common diseases of the farm. Illustrated.  $5\times 7$  inches. 288 pages. Cloth. Net, \$1.50.

## **First Lessons in Dairying**

By HUBERT E. VAN NORMAN. This splendid little book has been written from a practical point of view, to fill a place in dairy literature long needed. It is designed primarily as a practical guide to successful dairying, an elementary text-book for colleges and for use especially in short-course classes. It embodies underlying principles involved in the handling of milk, delivery to factory, shipping station, and the manufacture of butter on the farm. It is written in a simple, popular way, being free from technical terms, and is easily understood by the average farm boy. The book is just the thing for the every-day dairyman, and should be in the hands of every farmer in the country. Illustrated.  $5\times 7$  inches. 100 pages. Cloth. Net, \$0.50.

## **A Dairy Laboratory Guide**

By H. E. ROSS. While the book is intended primarily for use in the laboratory, it should be of value to the practical dairyman. The time has come when the successful dairyman must study his business from a purely scientific point of view, and in this book the scientific principles, upon which dairy industry is based, are stated clearly and simply, and wherever it is possible, these principles are illustrated by practical problems and examples. 90 pages.  $5\times 7$  inches. Cloth. . . . . Net, \$0.50.

## **Profitable Stock Raising**

By CLARENCE A. SHAMEL. This book covers fully the principles of breeding and feeding for both fat stock and dairying type. It tells of sheep and mutton raising, hot house lambs, the swine industry and the horse market. Finally, he tells of the preparation of stock for the market and how to prepare it so that it will bring a high market price. Live stock is the most important feature of farm life, and statistics show a production far short of the actual requirements. There are many problems to be faced in the profitable production of stock, and these are fully and comprehensively covered in Mr. Shamel's new book. Illustrated. 5x7 inches. 288 pages. Cloth. Net, \$1.50

## **The Business of Dairying**

By C. B. LANE. The author of this practical little book is to be congratulated on the successful manner in which he has treated so important a subject. It has been prepared for the use of dairy students, producers and handlers of milk, and all who make dairying a business. Its purpose is to present in a clear and concise manner various business methods and systems which will help the dairyman to reap greater profits. This book meets the needs of the average dairy farmer, and if carefully followed will lead to successful dairying. It may also be used as an elementary textbook for colleges, and especially in short-course classes. Illustrated. 5x7 inches. 300 pages. Cloth. Net, \$1.25

## **Questions and Answers on Buttermaking**

By CHAS. A. PUBLLOW. This book is entirely different from the usual type of dairy books, and is undoubtedly in a class by itself. The entire subject of butter-making in all its branches has been most thoroughly treated, and many new and important features have been added. The tests for moisture, salt and acid have received special attention, as have also the questions on cream separation, pasteurization, commercial starters, cream ripening, cream overrun, marketing of butter, and creamery management. Illustrated. 5x7 inches. 100 pages. Cloth. Net, \$0.50

## **Questions and Answers on Milk and Milk Testing**

By CHAS. A. PUBLLOW, and HUGH C. TROY. A book that no student in the dairy industry can afford to be without. No other treatise of its kind is available, and no book of its size gives so much practical and useful information in the study of milk and milk products. Illustrated. 5x7 inches. 100 pages. Cloth. . . . . Net, \$0.50

## Soils

By CHARLES WILLIAM BURKETT, Director Kansas Agricultural Experiment Station. The most complete and popular work of the kind ever published. As a rule, a book of this sort is dry and uninteresting, but in this case it reads like a novel. The author has put into it his individuality. The story of the properties of the soils, their improvement and management, as well as a discussion of the problems of crop growing and crop feeding, make this book equally valuable to the farmer, student and teacher. Illustrated. 303 pages. 5½x8 inches. Cloth. . Net, \$1.25

## Weeds of the Farm Garden

By L. H. PAMMEL. The enormous losses, amounting to several hundred million dollars annually in the United States, caused by weeds stimulate us to adopt a better system of agriculture. The weed question is, therefore a most important and vital one for American farmers. This treatise will enable the farmer to treat his field to remove weeds. The book is profusely illustrated by photographs and drawings made expressly for this work, and will prove invaluable to every farmer, land owner, gardener and park superintendent. 5x7 inches. 300 pages. Cloth. . . . . Net, \$1.50

## Farm Machinery and Farm Motors

By J. B. DAVIDSON and L. W. CHASE. Farm Machinery and Farm Motors is the first American book published on the subject of Farm Machinery since that written by J. J. Thomas in 1867. This was before the development of many of the more important farm machines, and the general application of power to the work of the farm. Modern farm machinery is indispensable in present-day farming operations, and a practical book like Farm Machinery and Farm Motors will fill a much-felt need. The book has been written from lectures used by the authors before their classes for several years, and which were prepared from practical experience and a thorough review of the literature pertaining to the subject. Although written primarily as a text-book, it is equally useful for the practical farmer. Profusely illustrated. 5½x8 inches. 520 pages. Cloth. . . . . Net, \$2.00

## The Book of Wheat

By P. T. DONBLINGER. This book comprises a complete study of everything pertaining to wheat. It is the work of a student of economic as well as agricultural conditions, well fitted by the broad experience in both practical and theoretical lines to tell the whole story in a condensed form. It is designed for the farmer, the teacher, and the student as well. Illustrated. 5½x8 inches. 370 pages. Cloth. . . . . Net, \$2.00

## The Cereals in America

By THOMAS F. HUNT, M.S., D.Agri., Professor of Agronomy, Cornell University. If you raise five acres of any kind of grain you cannot afford to be without this book. It is in every way the best book on the subject that has ever been written. It treats of the cultivation and improvement of every grain crop raised in America in a thoroughly practical and accurate manner. The subject-matter includes a comprehensive and succinct treatise of wheat, maize, oats, barley, rye, rice, sorghum (kafir corn) and buckwheat, as related particularly to American conditions. First-hand knowledge has been the policy of the author in his work, and every crop treated is presented in the light of individual study of the plant. If you have this book you have the latest and best that has been written upon the subject. Illustrated. 450 pages.  $5\frac{1}{2}$  x 8 inches. Cloth. . . . . \$1.75

## The Forage and Fiber Crops in America

By THOMAS F. HUNT. This book is exactly what its title indicates. It is indispensable to the farmer, student and teacher who wishes all the latest and most important information on the subject of forage and fiber crops. Like its famous companion, "The Cereals in America," by the same author, it treats of the cultivation and improvement of every one of the forage and fiber crops. With this book in hand, you have the latest and most up-to-date information available. Illustrated. 428 pages.  $5\frac{1}{2}$  x 8 inches. Cloth. . . . . \$1.75

## The Book of Alfalfa

History, Cultivation and Merits. Its Uses as a Forage and Fertilizer. The appearance of the Hon. F. D. COBURN'S little book on Alfalfa a few years ago has been a profit revelation to thousands of farmers throughout the country, and the increasing demand for still more information on the subject has induced the author to prepare the present volume, which is by far the most authoritative, complete and valuable work on this forage crop published anywhere. It is printed on fine paper and illustrated with many full-page photographs that were taken with the especial view of their relation to the text. 336 pages.  $6\frac{1}{2}$  x 9 inches. Bound in cloth, with gold stamping. It is unquestionably the handsomest agricultural reference book that has ever been issued. Price, postpaid, . \$2.00

## Clean Milk

By S. D. BELCHER, M.D. In this book the author sets forth practical methods for the exclusion of bacteria from milk, and how to prevent contamination of milk from the stable to the consumer. Illustrated. 5 x 7 inches. 146 pages. Cloth. . . . . \$1.00



## Farm Grasses of the United States of America

By WILLIAM JASPER SPILLMAN. A practical treatise on the grass crop, seeding and management of meadows and pastures, description of the best varieties, the seed and its impurities, grasses for special conditions, lawns and lawn grasses, etc., etc. In preparing this volume the author's object has been to present, in connected form, the main facts concerning the grasses grown on American farms. Every phase of the subject is viewed from the farmer's standpoint. Illustrated. 248 pages. 5 x 7 inches. Cloth. . . . . \$1.00

## The Book of Corn

By HERBERT MYRICK, assisted by A. D. SHAMBIA, E. A. BURNETT, ALBERT W. FULTON, B. W. SNOW, and other most capable specialists. A complete treatise on the culture, marketing and uses of maize in America and elsewhere for farmers, dealers and others. Illustrated. 372 pages. 5 x 7 inches. Cloth. . . . . \$1.50

## The Hop—Its Culture and Care, Marketing and Manufacture

By HERBERT MYRICK. A practical handbook on the most approved methods in growing, harvesting, curing and selling hops, and on the use and manufacture of hops. The result of years of research and observation, it is a volume destined to be an authority on this crop for many years to come. It takes up every detail from preparing the soil and laying out the yard, to curing and selling the crop. Every line represents the ripest judgment and experience of experts. Size, 5 x 8; pages, 300; illustrations, nearly 150; bound in cloth and gold; price, postpaid, . . . . . \$1.50

## Tobacco Leaf

By J. B. KILLEBREW and HERBERT MYRICK. Its Culture and Cure, Marketing and Manufacture. A practical handbook on the most approved methods in growing, harvesting, curing, packing and selling tobacco, with an account of the operations in every department of tobacco manufacture. The contents of this book are based on actual experiments in field, curing barn, packing house, factory and laboratory. It is the only work of the kind in existence, and is destined to be the standard practical and scientific authority on the whole subject of tobacco for many years. 506 pages and 150 original engravings. 5 x 7 inches. Cloth. . . . . \$2.00

## Feeding Farm Animals

By Professor THOMAS SHAW. This book is intended alike for the student and the farmer. The author has succeeded in giving in regular and orderly sequence, and in language so simple that a child can understand it, the principles that govern the science and practice of feeding farm animals. Professor Shaw is certainly to be congratulated on the successful manner in which he has accomplished a most difficult task. His book is unquestionably the most practical work which has appeared on the subject of feeding farm animals. Illustrated. 5½ x 8 inches. Upward of 500 pages. Cloth. . . . \$2.00

## Profitable Dairying

By C. L. PECK. A practical guide to successful dairy management. The treatment of the entire subject is thoroughly practical, being principally a description of the methods practiced by the author. A specially valuable part of this book consists of a minute description of the far-famed model dairy farm of Rev. J. D. Detrich, near Philadelphia, Pa. On the farm of fifteen acres, which twenty years ago could not maintain one horse and two cows, there are now kept twenty-seven dairy cattle, in addition to two horses. All the roughage, litter, bedding, etc., necessary for these animals are grown on these fifteen acres, more than most farmers could accomplish on one hundred acres. Illustrated. 5 x 7 inches. 200 pages. Cloth. . . . \$0.75

## Practical Dairy Bacteriology

By Dr. H. W. CONN, of Wesleyan University. A complete exposition of important facts concerning the relation of bacteria to various problems related to milk. A book for the classroom, laboratory, factory and farm. Equally useful to the teacher, student, factory man and practical dairyman. Fully illustrated with 83 original pictures. 340 pages. Cloth. 5½ x 8 inches. . . . \$1.25

## Modern Methods of Testing Milk and Milk Products

By L. L. VANSLYKE. This is a clear and concise discussion of the approved methods of testing milk and milk products. All the questions involved in the various methods of testing milk and cream are handled with rare skill and yet in so plain a manner that they can be fully understood by all. The book should be in the hands of every dairyman, teacher or student. Illustrated. 214 pages. 5 x 7 inches. . . . \$0.75







