

**የትርፍ ጊዜ ማሳለፊያዎች**  
**CREATIVE LEISURE**  
**ACTIVITIES**

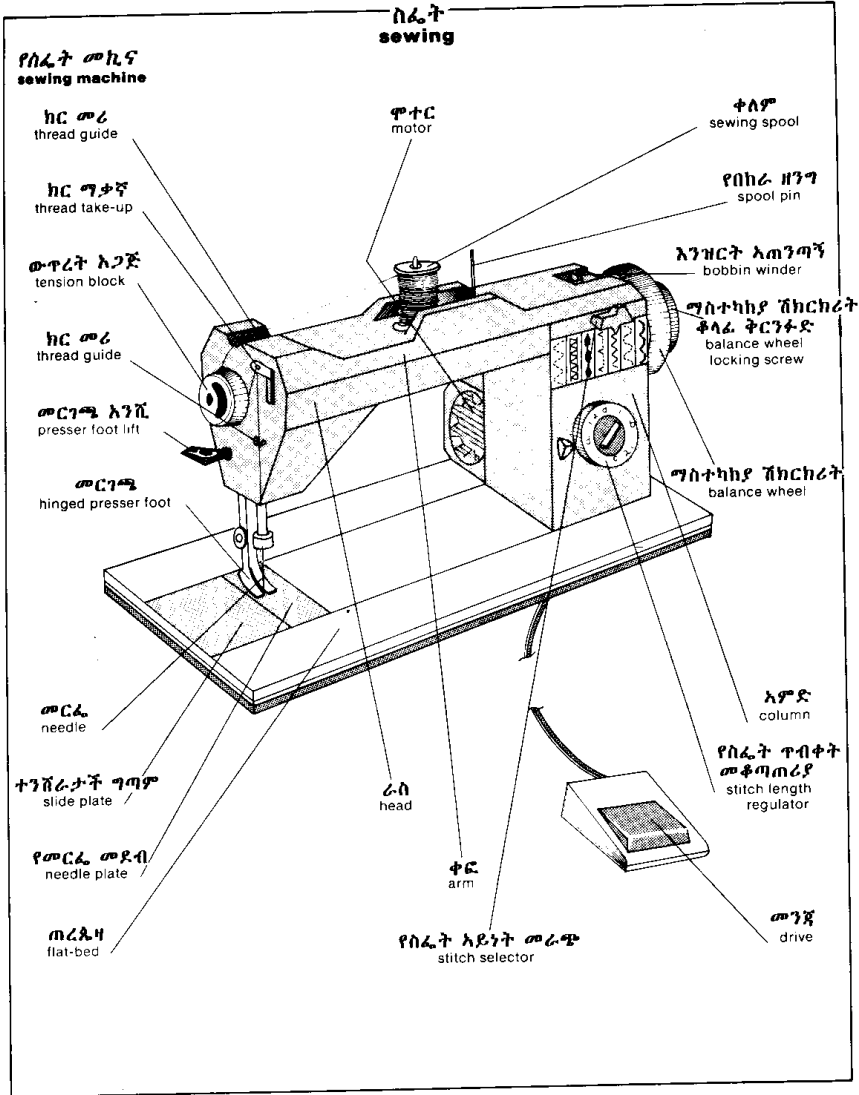

ስፌት  
sewing

የስፌት መኪና  
sewing machine

ውጥረት አጋጅ  
tension block

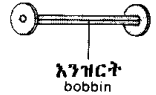
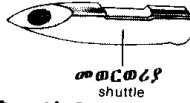
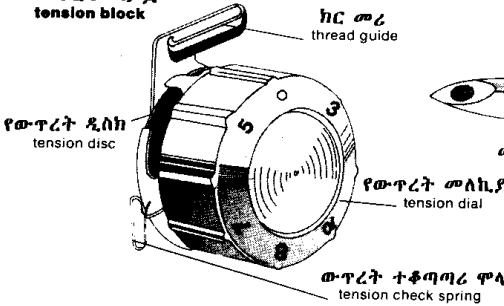

መርገሜ  
presser foot

መርፌ  
needle

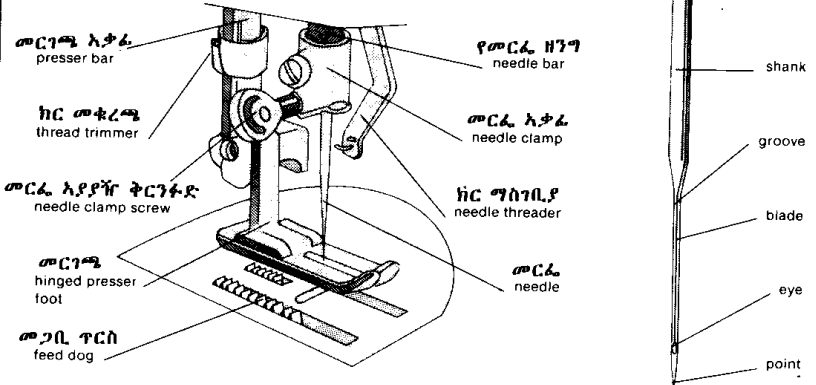

ማላቀቂያ  
latch lever

የእንዝርት ቀፎ  
bobbin case

እንዝርት  
bobbin

መክፈቻ  
hook

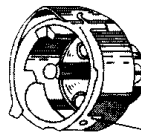

ስራት  
sewing

የስራት እቃዎች  
supplies

አስፒላ መሰኪያ  
pin cushion

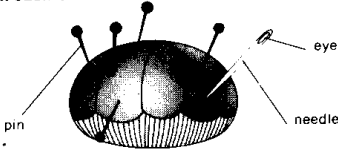

ማንኛ ሽከራሪት  
tracing wheel

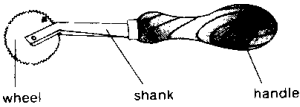

መቀስ  
scissors

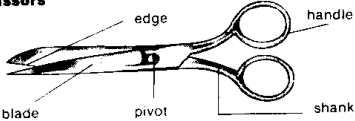

ባለጥርስ መቀስ  
pinking shears

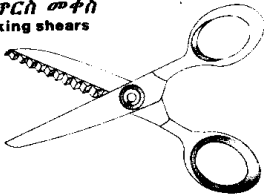

ሚትር  
tape measure

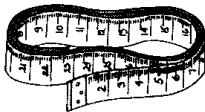

መግንጠስ  
magnet



መርፌ ቆላፍ  
safety pins



ክር ግስገሲያ  
needle threader



የጣት ቤዛ  
thimble



የልብስ ጥድ  
dressmaker's model

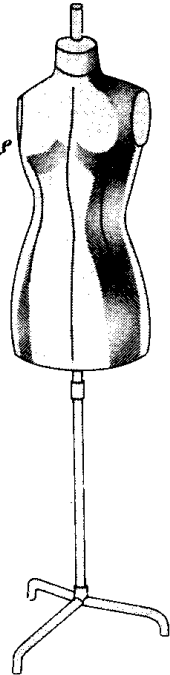

የቀሚስ ቆመት መለኪያ  
skirt marker

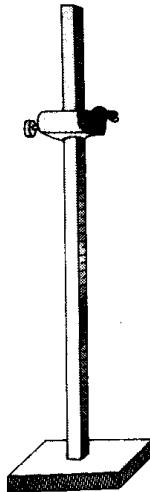

በፊት  
sewing

ማያያዣ  
fasteners

ዘለበት  
buckle

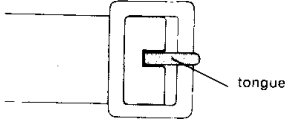

ባልና ሚስት ቁልፍ  
snap

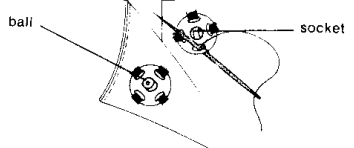

አገራር  
sew-through buttons

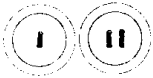

አግራፍ  
hook and eyes

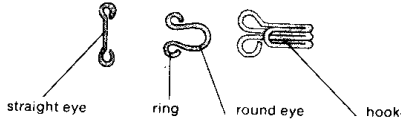

shank button



ዚፕ  
zipper

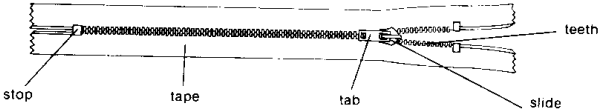

የጨርቅ ስረት  
fabric structure

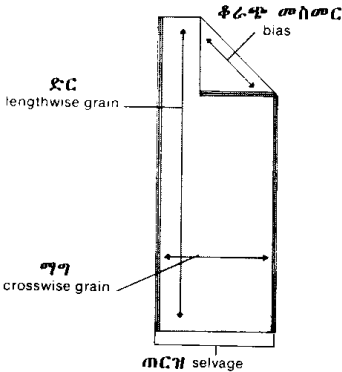

የጨርቅ አገገባ  
underlying fabrics

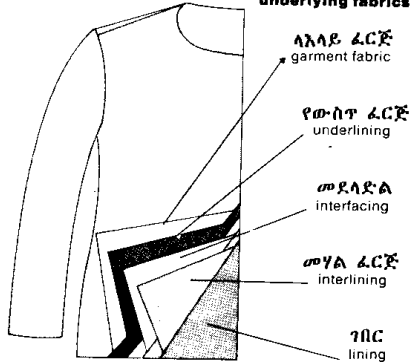

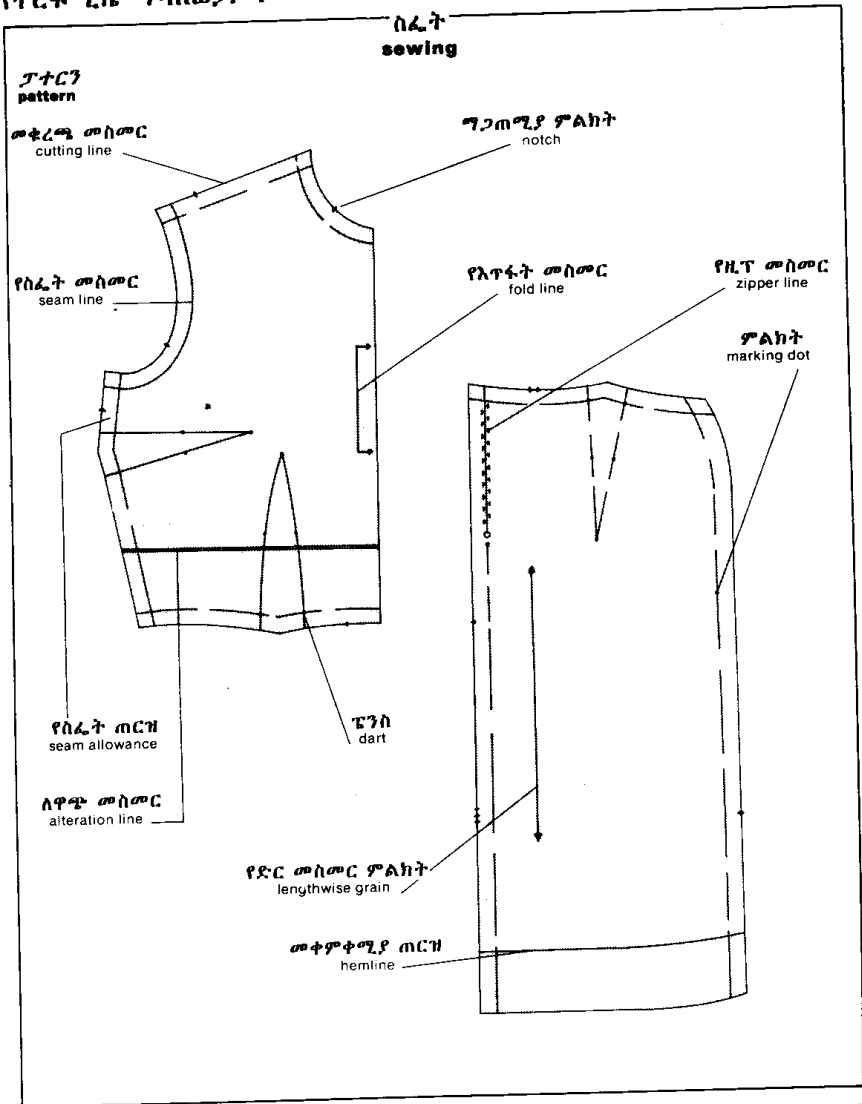

ሹራብ ስራ  
knitting

ሹራብ መስሪያ ሽቦ  
knitting needles

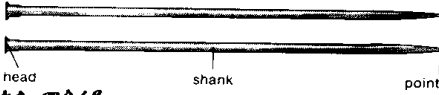

ጻንቲል መስሪያ  
crochet hook



ሹራብ መለኪያ  
knitting measure

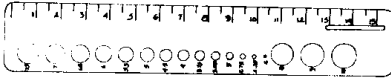

ውጥን  
cast-on stitches



የሹራብ ስራ አይነቶች  
stitch patterns

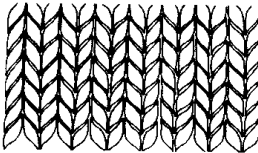

stocking stitch  
አስተኪንግ ስራ

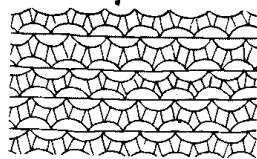

garter stitch  
ጃንያ ስራ

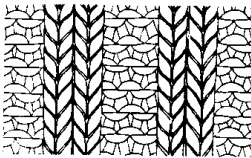

rib stitch  
ላስቲክ ስራ

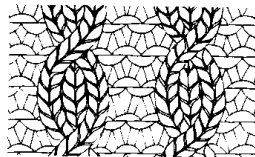

cable stitch  
ጉንጉን ስራ

ክብ ማውጫ ሽቦ  
circular needle

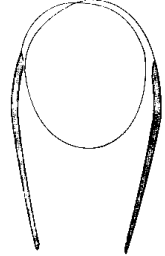

sample

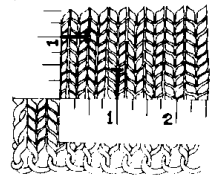

የሹራብ መኪና  
knitting machine

ውጥረት አጋጅ  
tension block

ውጣሪ ጥላ  
tension spring

ውጥረት ተቆጣጣሪ  
tension controller

ክር ቆንጣጭ  
yarn clip

የክር ዘንግ  
yarn rod

የውጥረት ዲስክ  
tension disc

የውጥረት መለኪያ  
tension dial

ክር ማስገቢያ ቀዳዳ  
eyelet

ውጥረት መሪ  
tension guide

መርጫ መደርደሪያ  
needle bed

የዲዛይን ክርድ አገባብ  
punch card feeding mechanism

የዲዛይን ማስገቢያ ምልክት  
punch card feeding dial

ፓተርን ማንበቢያ  
pattern reader

ዲዛይን ክርድ  
punch card

ዲዛይን ማንበቢያ  
punch card reader

ረድፍ አመልካች  
row indicator

መርወሪያ  
carriage

መርጫ መደርደሪያ  
needle bed

ሃዲድ  
rail

አጣብቂኝ  
clamp

መለያያ  
separators

መለወጫ ምልክት  
change dial

መርጫ መደርደሪያ ቀዳዳ  
needle bed groove

ማንሸራሸሪያ ሃዲድ  
slide-bar

ክብደት ተሸካሚ  
claw weight

መጋቢ ምልክት  
feeding dial

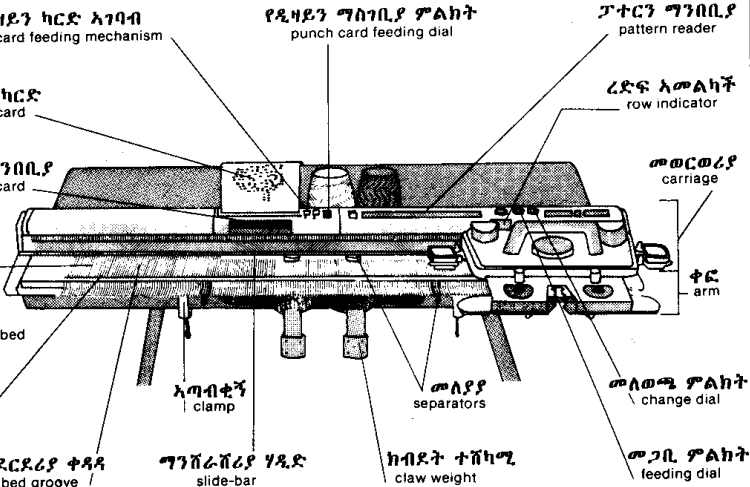
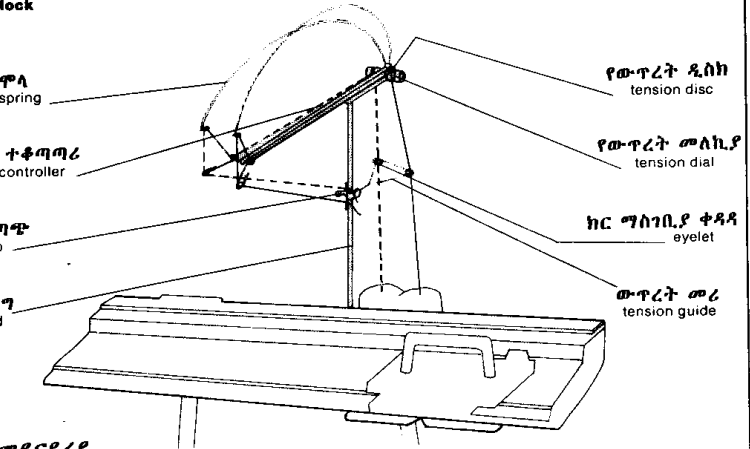



የሱራብ መኪና  
knitting machine

መወርወሪያ  
carriage

መወርወሪያ  
carriage

ቀፍ  
arm

መሰግሰጊያ  
tuck brush

መሸመኛ ብሩሽ  
weaving brush

የውጥረት መለኪያ  
tension dial

ክር መጋቢ  
yarn feeder

እጅታ  
handle

cam

ጉን እንሺ  
side lever

ማበጠሪያ እንሺ  
cam lever

ቅርንፋድ  
arm nut

ባለመንጠቆ መርፌ  
latch needle

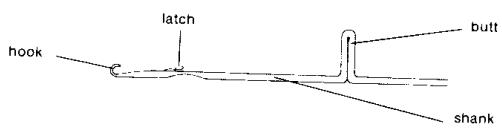

እንዘርት  
bobbin lace

ትራስ  
pillow

ተሽከርካሪ ሲሊንደር  
revolving cylinder

ፓተርን  
pattern

እንዘርት  
bobbin

ራስ  
head

ባክራ  
spool

እጅታ  
handle

መጠቅጠቂያ  
pricker



ጥልፍ

embroidery

መወጠሪያ  
frame

መቃን  
slat

መወጠሪያ  
hoop

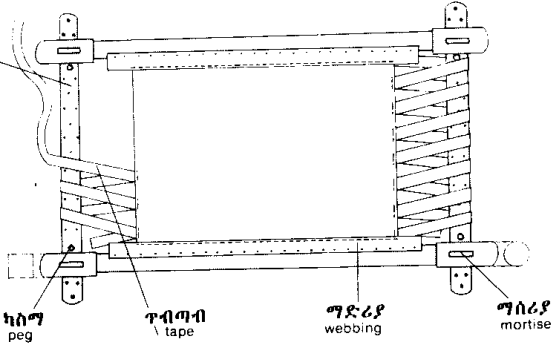
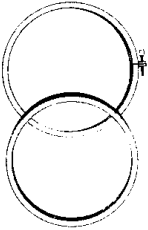

ካስግ  
peg

ጥብጣብ  
tape

ማድሪያ  
webbing

ማሰሪያ  
mortise

የጥልፍ ዎድብ  
groups of stitches

የጳጳር ስራዎች  
knot stitches group

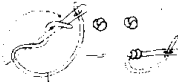

French knot stitch  
አበባ አንቡጥ



bullion stitch  
ጉል ስራ

ልጥፍ ስራዎች  
flat stitches group

couched stitches



ሙሉ ስራ  
long and short stitch



ዘንባላ ስራ  
fishbone stitch

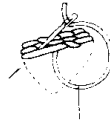

Roumanian couching stitch

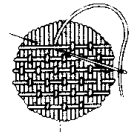

Oriental couching stitch

መስተልኛ ስራዎች  
cross stitches group

ቁልፍ ስራዎች  
loop stitches group



chevron stitch  
ዚግዛግ



herringbone stitch  
አክስ



chain stitch  
ሰንሰለት ሥራ

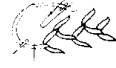

feather stitch  
ሰንፍ ስራ

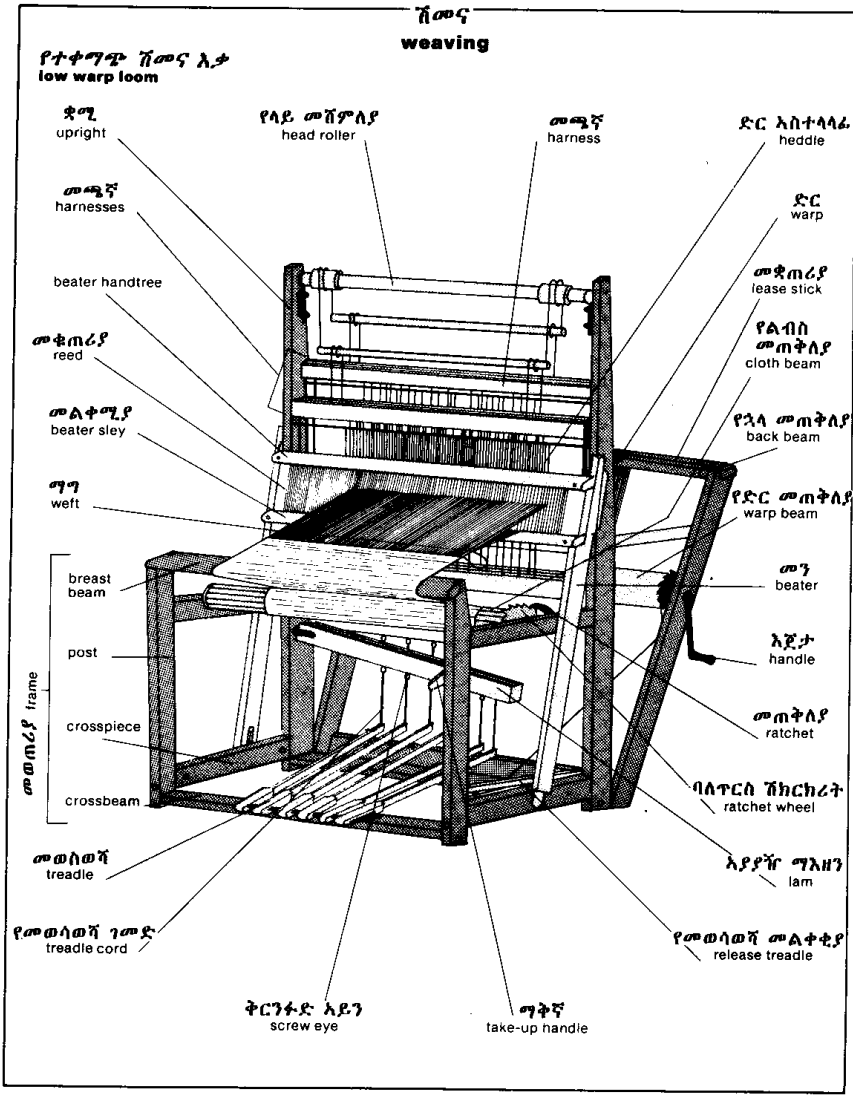

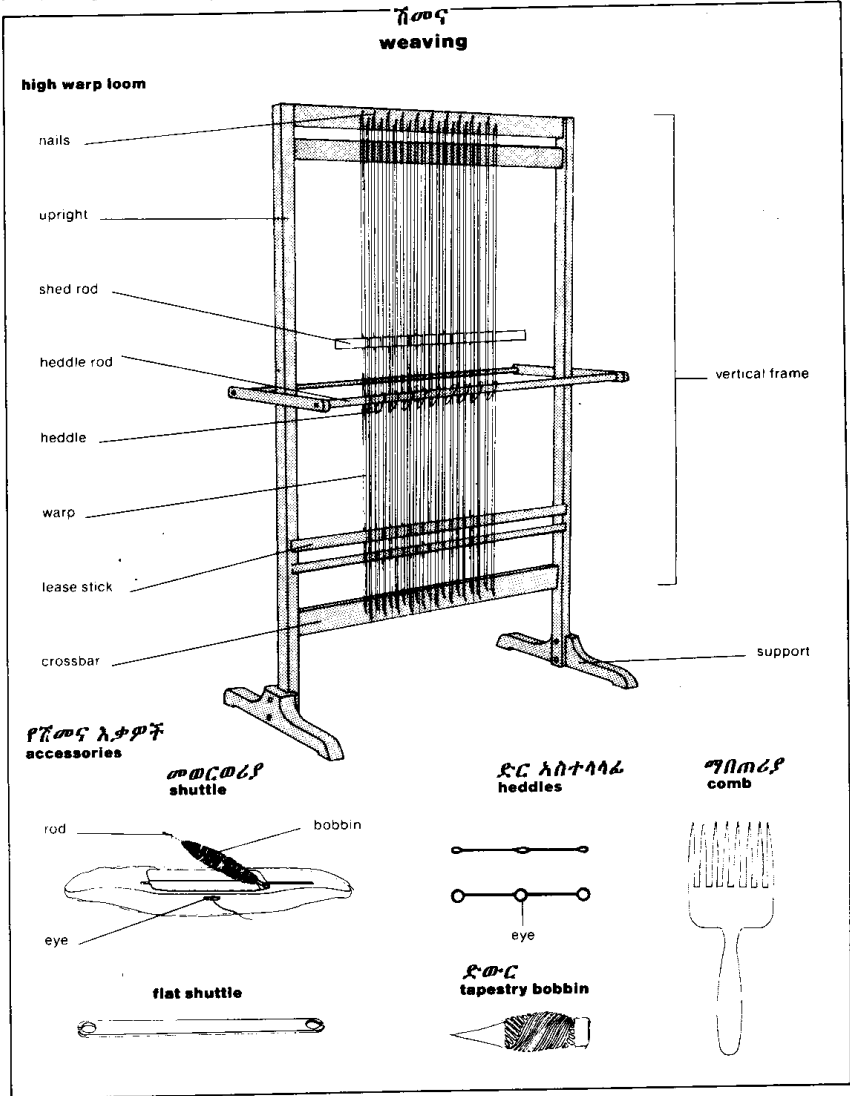

ሽመና  
weaving

ግዳወሪያ  
ball winder

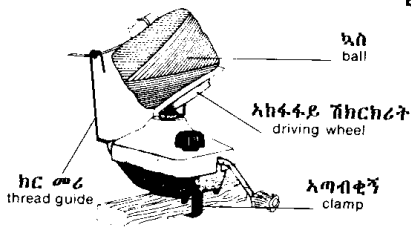

ግጦንጦኝ  
bobbin winder

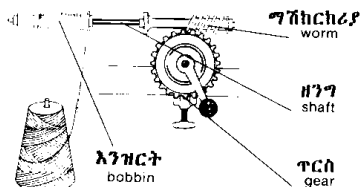

ቀግግሶ  
swift

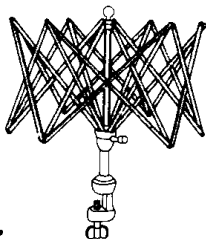

የልብስ መወገጫ  
temple



reed hooks

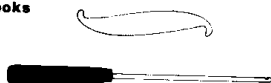

ግድራያ  
warping reel

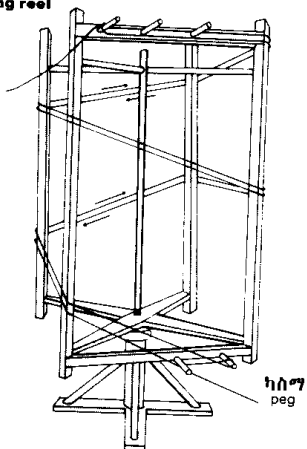

spool rack

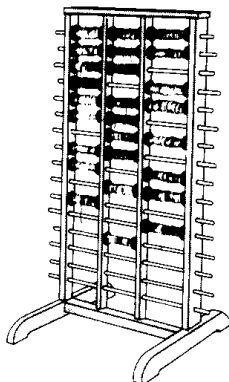

ሽመና

weaving

የሽመና አሰራር ንድፍ

diagram of weaving principle

የድር ክር  
warp thread

የማግ ክር  
weft thread

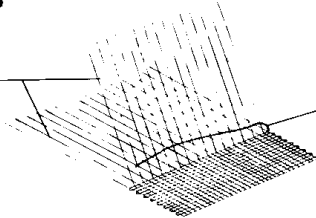

መሰረታዊ የሽግ አሰራር  
basic weaves

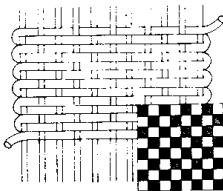

ልጠጥ ስራ (አንድ ባንድ)  
plain weave

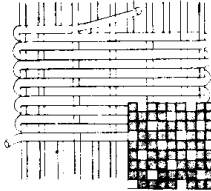

አራት ባንድ ስራ  
twill weave

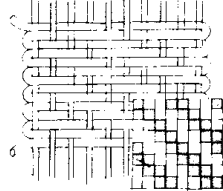

ሁለት በሁለት ስራ  
satin weave

ሌሎች የአሰራር ዘዴዎች  
other techniques

ቁላፍላፍ  
interloop

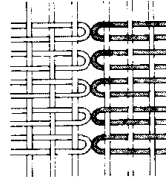
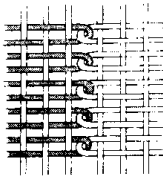

መሃል ክፍት ቁላፍላፍ  
slit

ተላላፊ ቁላፍላፍ  
hatching

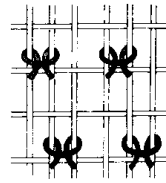
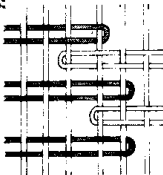

ቋጠር  
knot

ልቅም አጠራረዝ  
fine bookbinding

የተጠረዘ መፅሃፍ  
bound book

የራስጌ ሽፋን  
headcap

የራስጌ ጊጥ  
headband

የኋላ ሽፋን ጠርዝ  
back cornering

ደንደስ  
spine

የድጉስ ተብታ  
raised band

መጋጠሚያ  
joint

የፊት ሽፋን  
front board

የኋላ ሽፋን  
back board

አራት ማእዘን  
square

የላይ ጠርዝ  
top edge

የፊት ጠርዝ  
fore edge

ነጠላ ወረቀት  
flyleaf

የግርጌ ጠርዝ  
tail edge

የልባስ ጠርዝ  
corner

መሰብሰብ  
gathering

ሲግኔቸር  
signature

ማጠፊያ  
bone folder

መጨረሻ ቅጠል  
endpaper

ብትን ወረቀት  
sheet

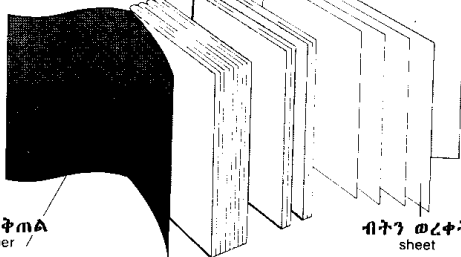

ልቅም አጠራረዝ  
fine bookbinding

ግረፍ  
trimming

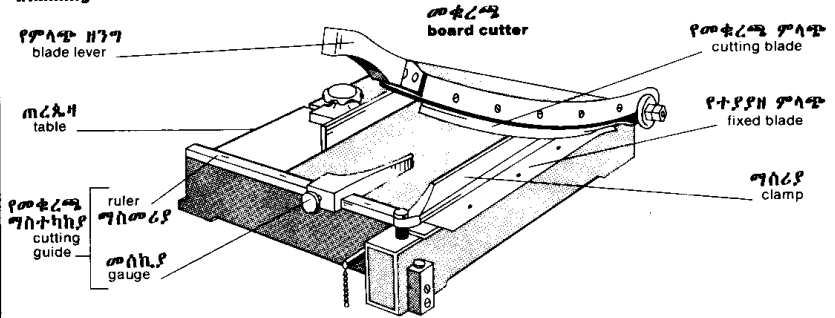

መቁረጥና መስፋት  
sawing-in and sewing

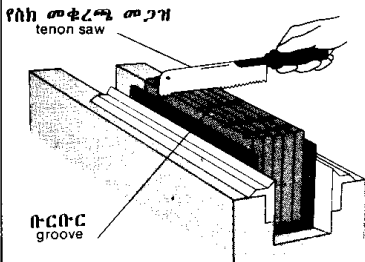

የመስፊያ ክፈፍ  
sewing frame

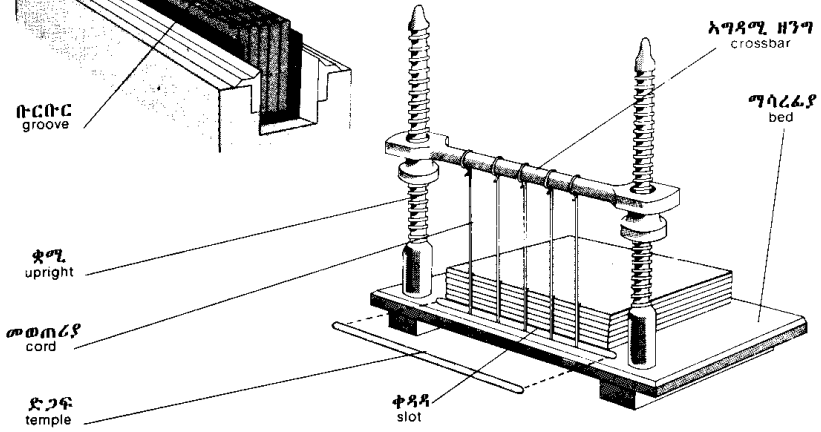



ልቅም አጠራረዝ  
fine bookbinding

መጠረኻያ  
backing

እጀታ  
handle

የመፅሐፍ ደንደስ  
spine of the book

የመደገፊያ ሳንታ  
backing board

የመጠረኻያ መጫኛ  
backing press

ክፍካፊ መደቫ  
backing hammer

ሰላ አካላ  
claw

ገፅታ  
face

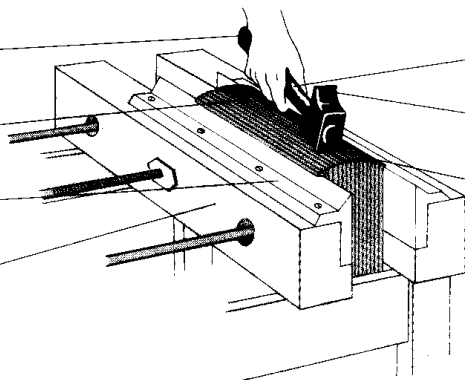

መጫኛ  
pressing

ቋሚ መጫኛ  
standing press

መ-አከላዊ ቅርንፉድ  
central screw

ቋሚ  
upright

የእጅ መዘውር  
hand-wheel

ዝርግ መጫኛ  
platen

መጫኛ ሳንታ  
pressing board

ተሸካሚ  
base

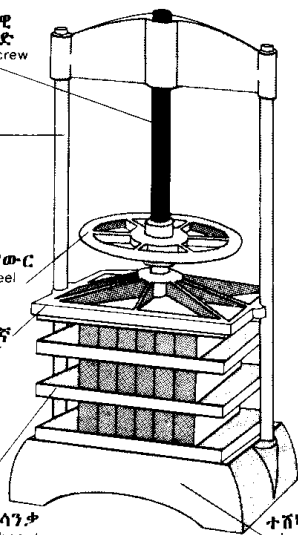

የመጠረኻያ ቅዳ  
bookbinding leather

ሽፋን  
covering

እግር  
feet

የራስጌ ድጉስ  
head

አንገትጌ ድጉስ  
neck

የጉን ድጉስ  
flank

ደንደስ  
spine

የግሮጌ ድጉስ  
tail

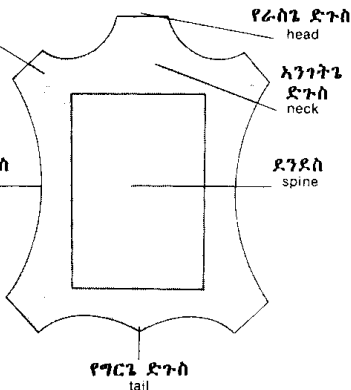

ሽክላ ስራ  
pottery

ማሽከሪያ  
turning wheel

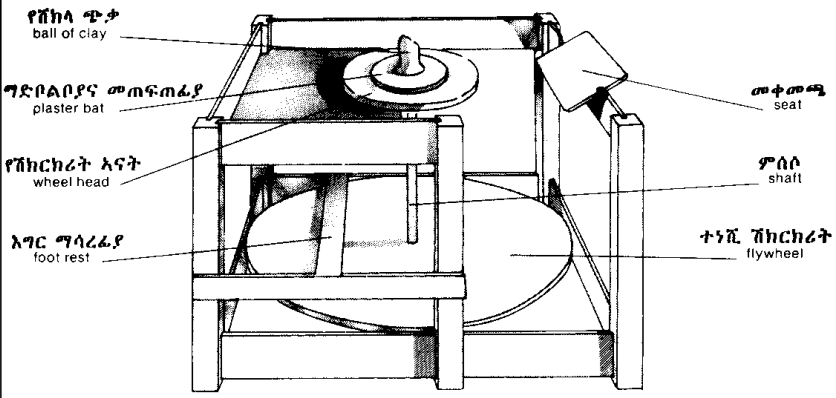

የእጅ መሳሪያዎች  
tools

መለኪያ  
banding wheel

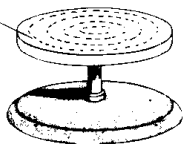

ወሳፍቻ  
needle tool



የቅርፅ መለዋወጫ  
ribs

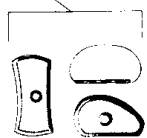

መቁረጫ ሽቦ  
cutting wire



ቅርፅ ማውጫ እንጨት  
wooden modeling tools

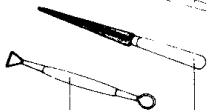
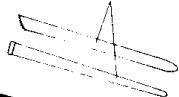

መቅረፊያ  
trimming tool

መክርሚያ  
fettling knife

መዳመጫ  
slab building



ማድቦልያ  
coiling

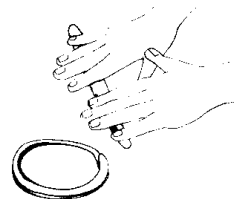

ሸክላ ስራ  
pottery

መጋገር  
baking

የሸክላ መጥበቻ  
ኮረንቲ ምድጃ  
electric kiln

ውሃ መርጫ  
damper

መቀት መለኪያ  
pyrometer

መቀት ሰጪ  
heating element

እናት  
crown

ሸክላ ክለላ  
refractory brick

መደርደሪያ  
shelf

ማሸለቂያ ቀዳዳ  
peephole

ምሰሶ  
post

መቆጣጠሪያ  
control knob

ምድጃ  
hearth

ምልክት ሰጪ መብራት  
signal lamp

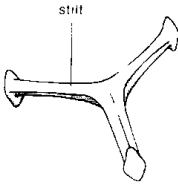

stilt

pyrometric cone

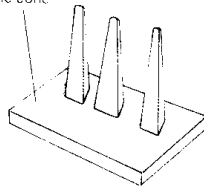

muffle

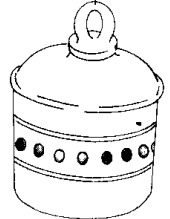

saggar

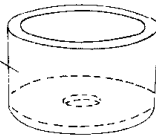

ሸግኔ

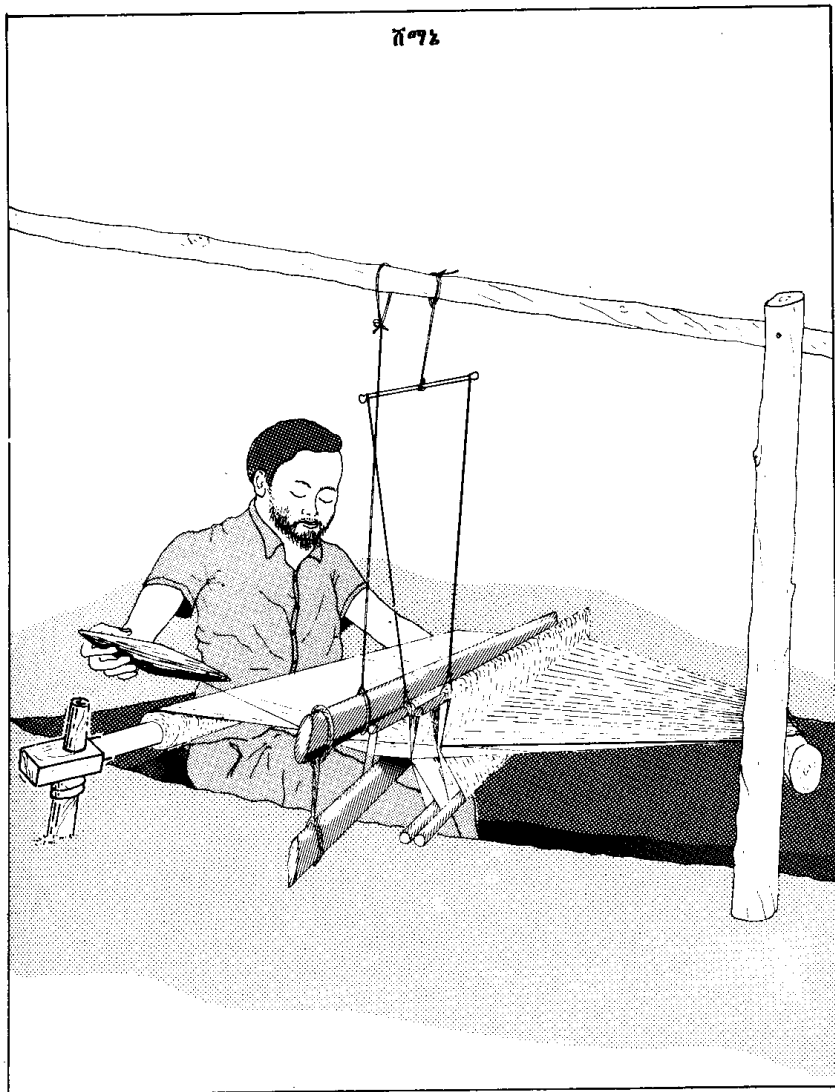

**ስፖርት**  
**SPORTS**

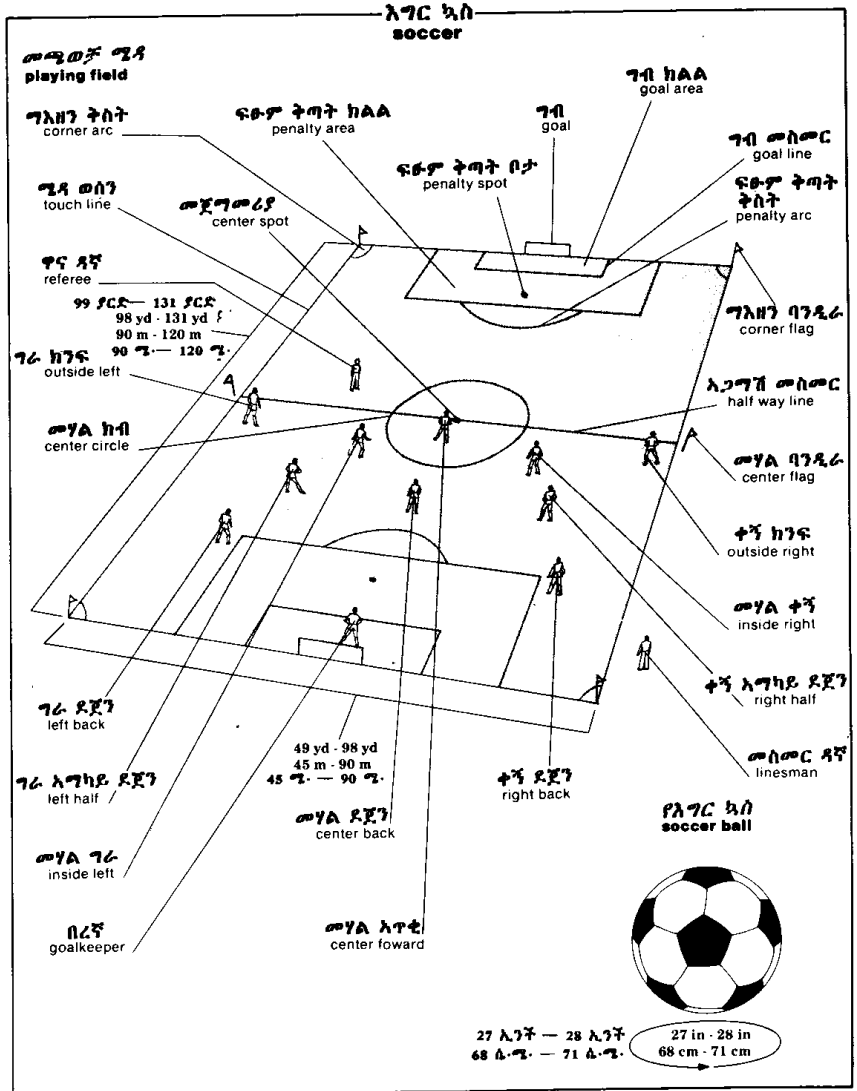

ቅርጫት ኳስ  
basketball

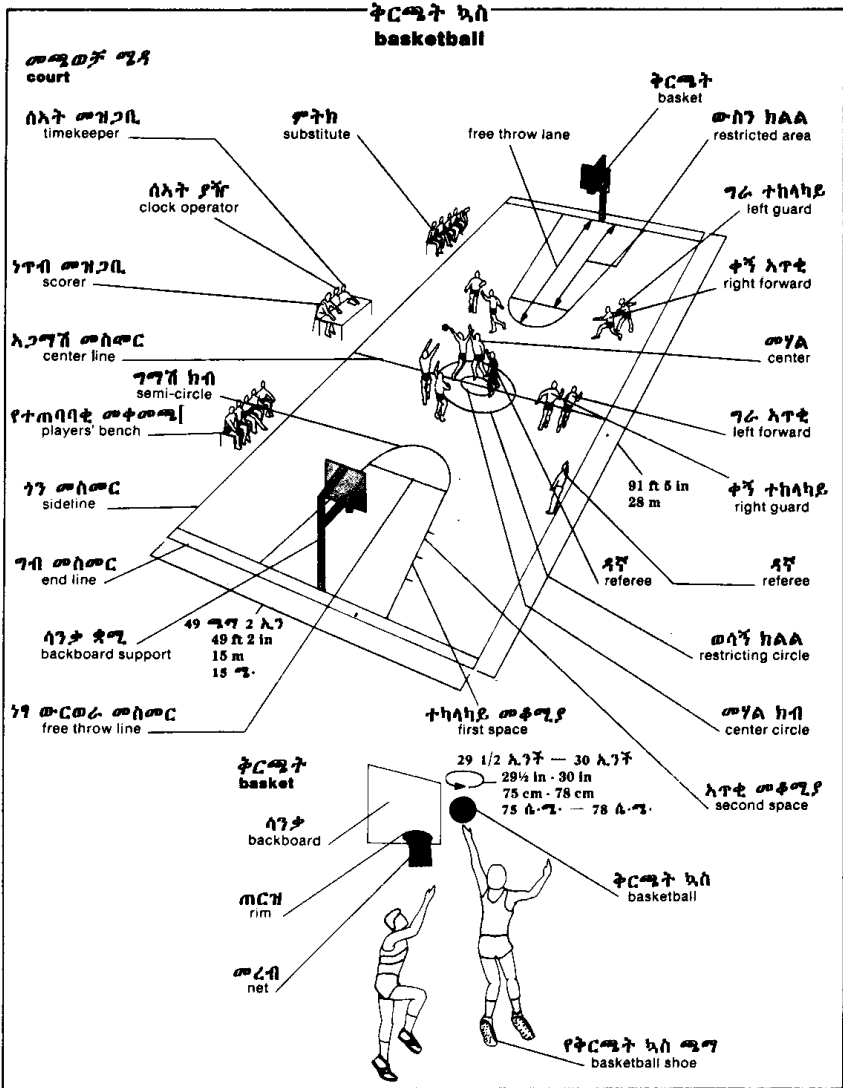

TEAM GAMES

የቡድን ጨዋታ

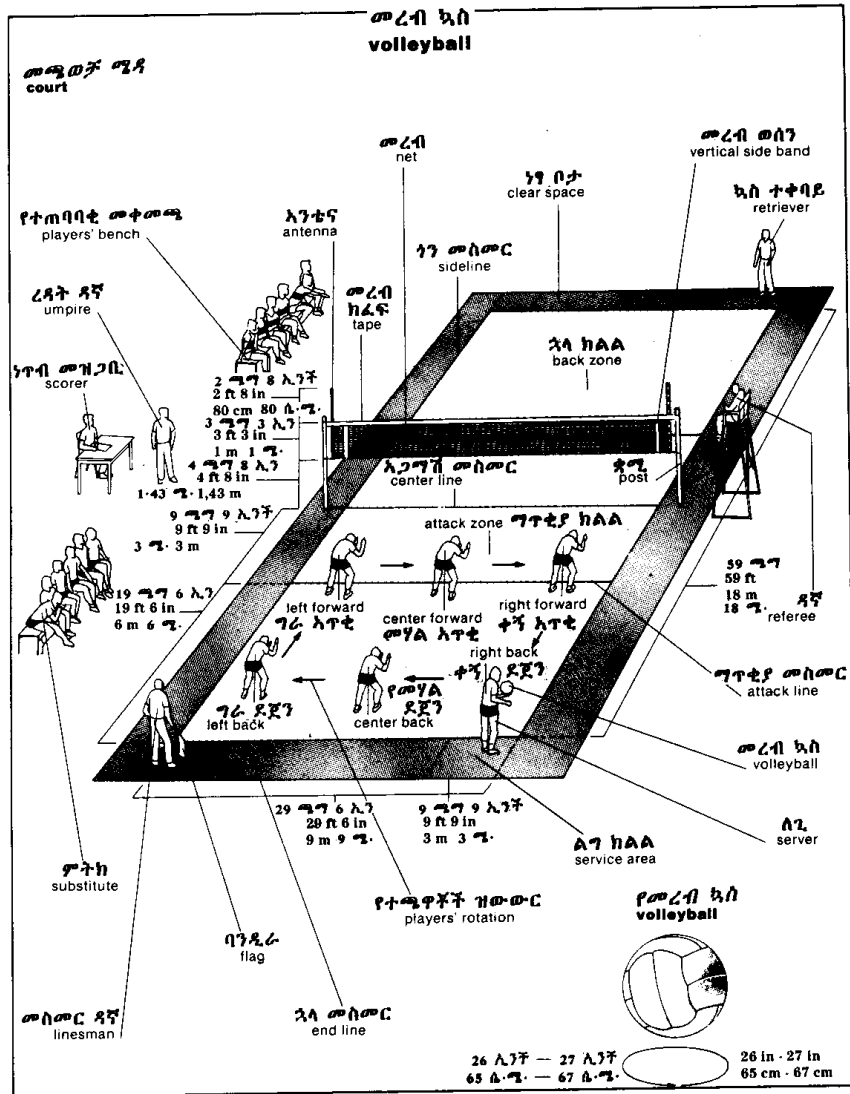

NO REPRODUCTION PERMITTED



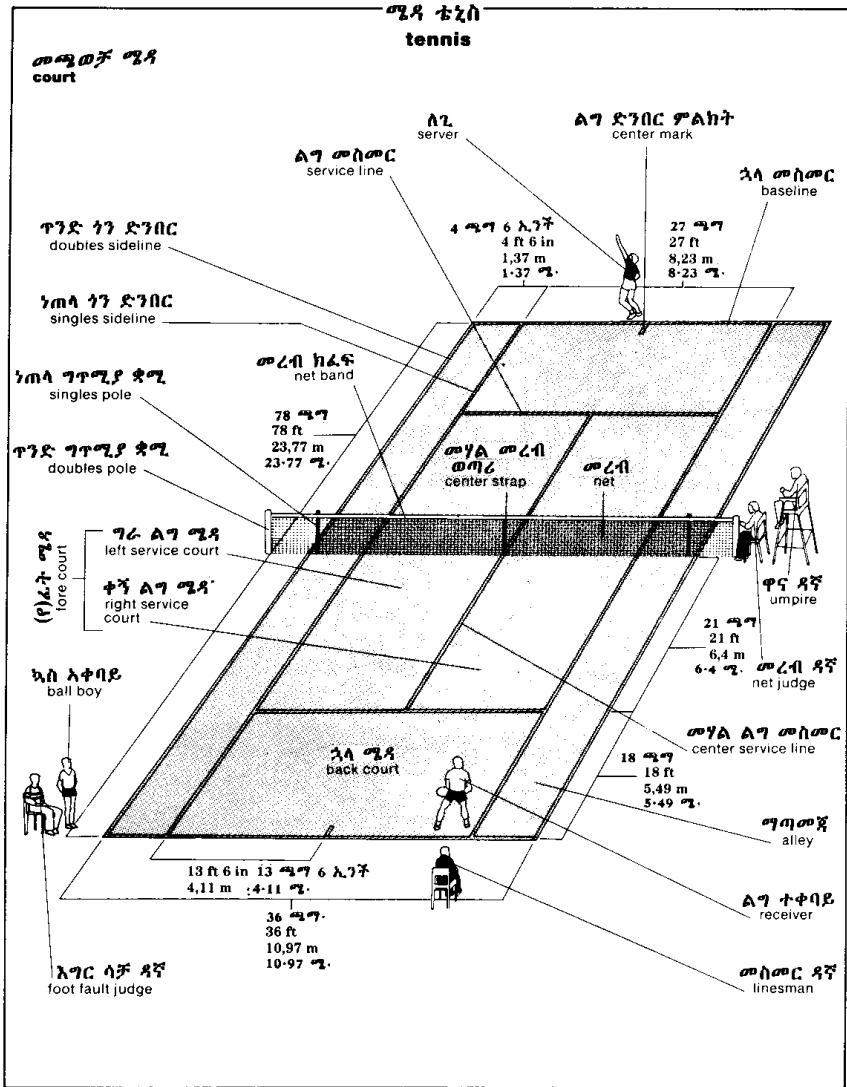

ጫዳ ቴኒስ  
tennis

ጫዳ ቴኒስ ተጫዋቾች  
tennis players

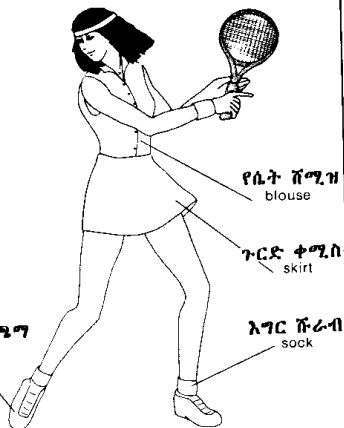
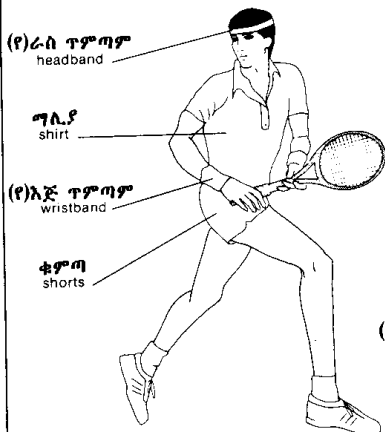

የጫዳ ቴኒስ ራኬት  
tennis racket

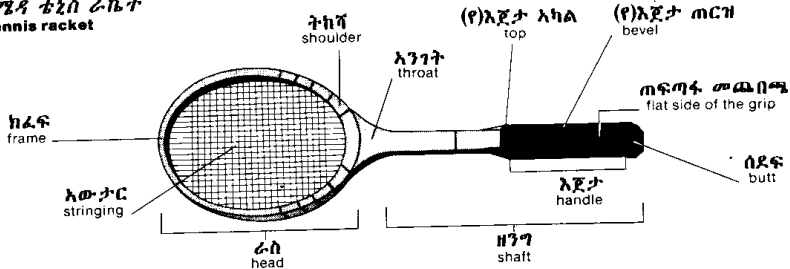

የጫዳ ቴኒስ ኳስ  
tennis ball



63.5 ሜ.ሜ. — 66.7 ሜ.ሜ.  
63.5 mm - 66.7 mm  
2 1/2 in - 2 3/4 in 2 1/2 እ.ኛች — 2 5/8 እ.ኛች

ክፈፍ ግቃኛ  
press

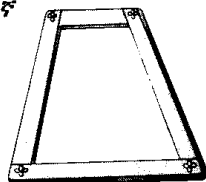

እጅ ኳስ  
handball

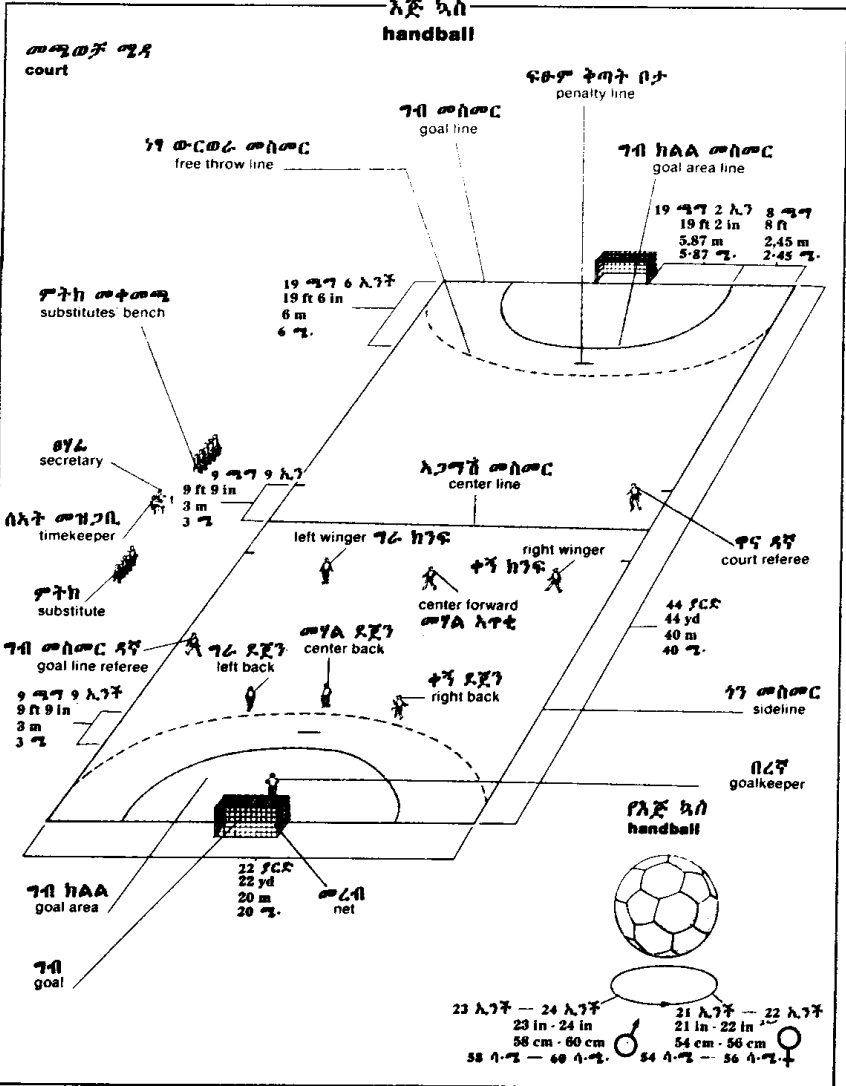

**TEAM GAMES**

**የቡድን ጨዋታ**

**ባድሚንተን  
badminton**

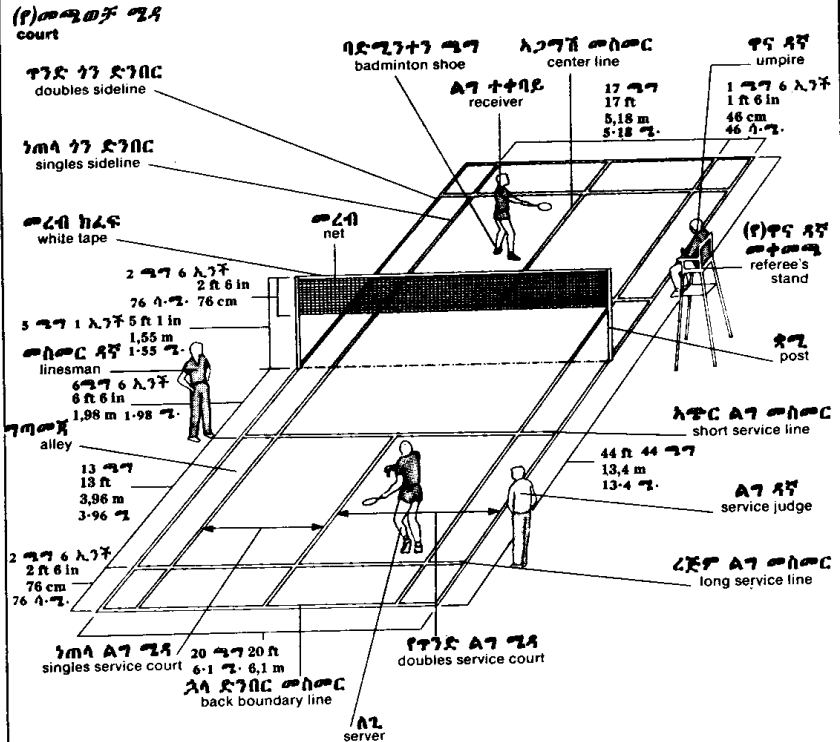

**(የ)ባድሚንተን ራኬት  
badminton racket**

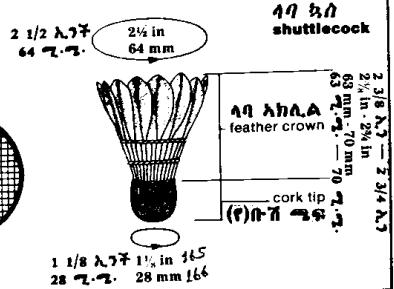
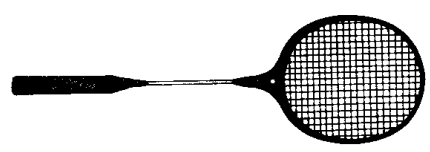

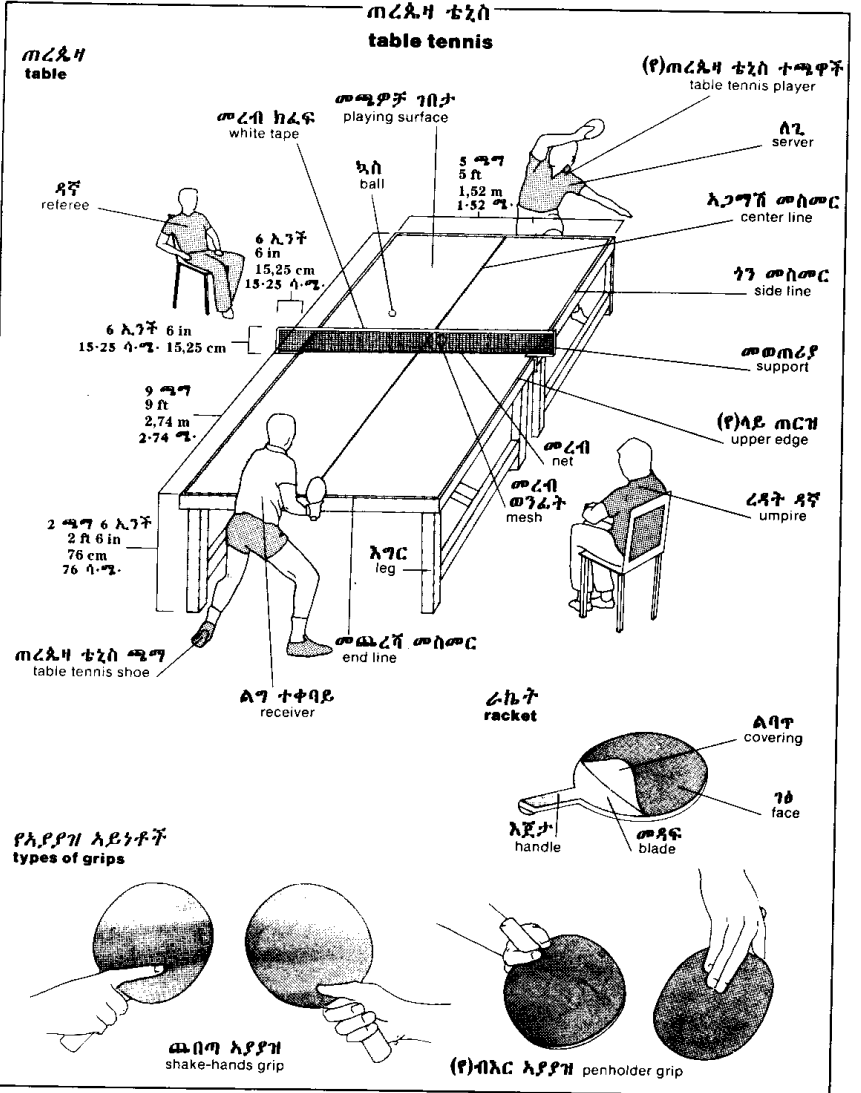

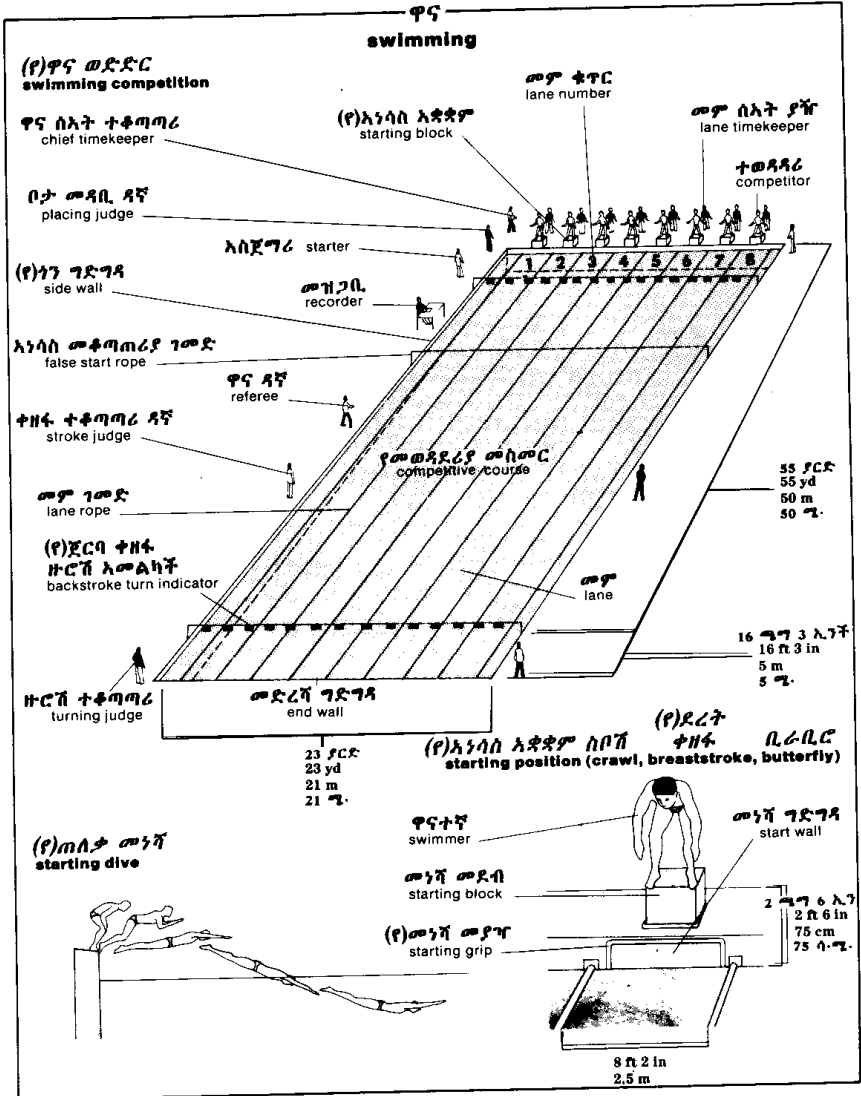

(የ) ቀዘፋ አይነቶች  
types of strokes

(የ) ፊት ስቦሽ ቀዘፋ  
front crawl stroke



(የ) ጀርባ ቀዘፋ  
backstroke

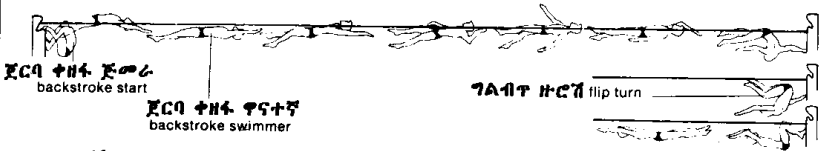

ቢራቢሮሽ ቀዘፋ  
butterfly stroke

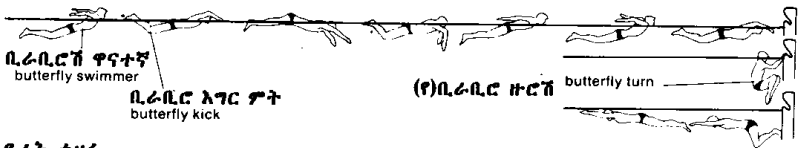

ደረት ቀዘፋ  
breaststroke



ጎን ቀዘፋ  
sidestroke



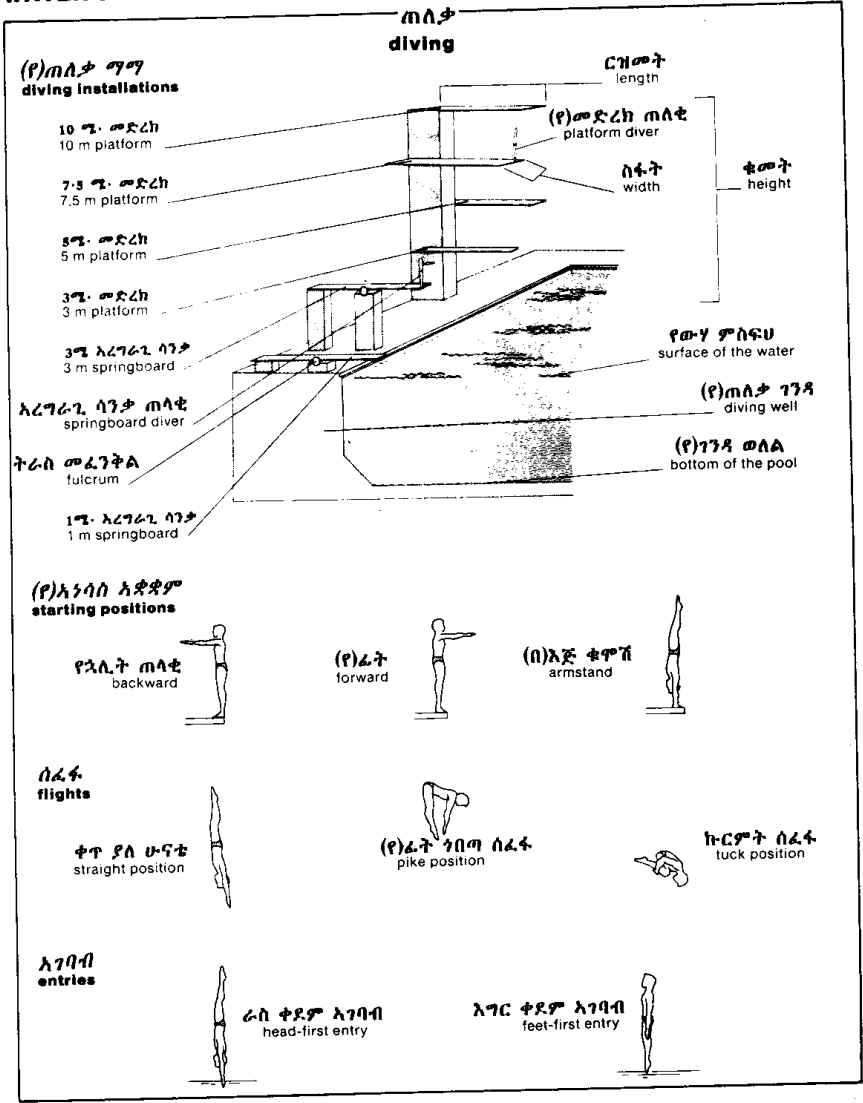



(የ)ጠለቃ አይነቶች  
groups of dives

(የ)ፊት ጠለቃ  
forward dive

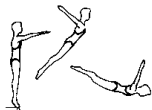

(የ) አነሳስ አቋቋም  
starting position

(የ) ከጎድ ሁኔታ  
arm position

(የ) እግር ሁኔታ  
leg position

አገባብ  
entry

ወደውስጥ ጠለቃ  
inward dive

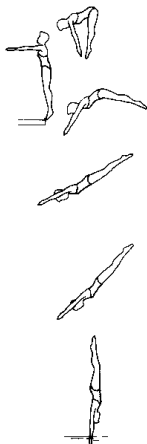

(የ)ጀርባ ጠለቃ  
backward dive

ጠለቃ  
diver



(የ)ጥምዝ ጠለቃ  
twist dive



(የ)ጀርባ ግልብጦሽ ጠለቃ  
reverse dive



(የ)ጠለቃ  
ዝላይ ከፍታ  
height  
of the dive

(የ)እጅ ቁምሽ ጠለቃ  
armstand dive



በረራ  
flight

ግልቢያ  
riding

ትጥቅ  
dress and equipment

ፈረስኛ ቦት  
riding coat

ተንፋንፍ ሱሪ  
breeches

ቦት  
boot

መኮርኮሪያ  
spur

ፈረስኛ ባርዬጣ  
riding helmet

ፈረስኛ ቅንቲ  
riding glove

አለንጋ  
riding whip

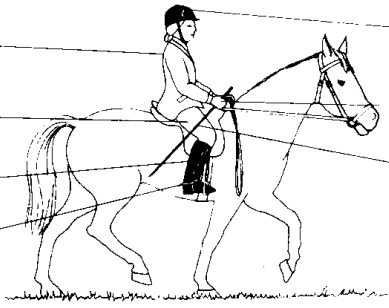

መሰናክሎች  
obstacles



ባላራት(ባለአራት) አግዳሚ  
post and rail

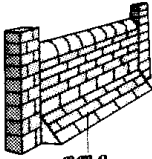

ግምብ  
wall

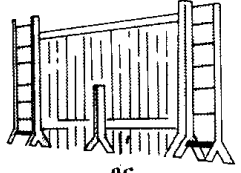

ቦር  
gate

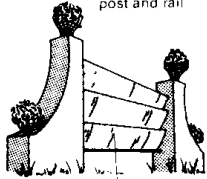

ስክ ሳንቃ  
post and plank

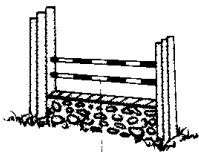

ግምብና ባለሁለት አግዳሚ  
wall and rails

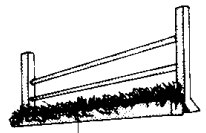

ቁጥጭና ባለሁለት አግዳሚ  
brush and rails



ኩሬ ዝላይ  
water jump

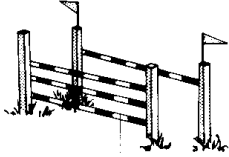

አክሰር  
oxer

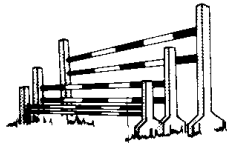

ስሉስ አግዳሚ  
triple bar

ገልቢያ  
riding

የመሰናከሎች አቅጣጫ  
course of obstacles

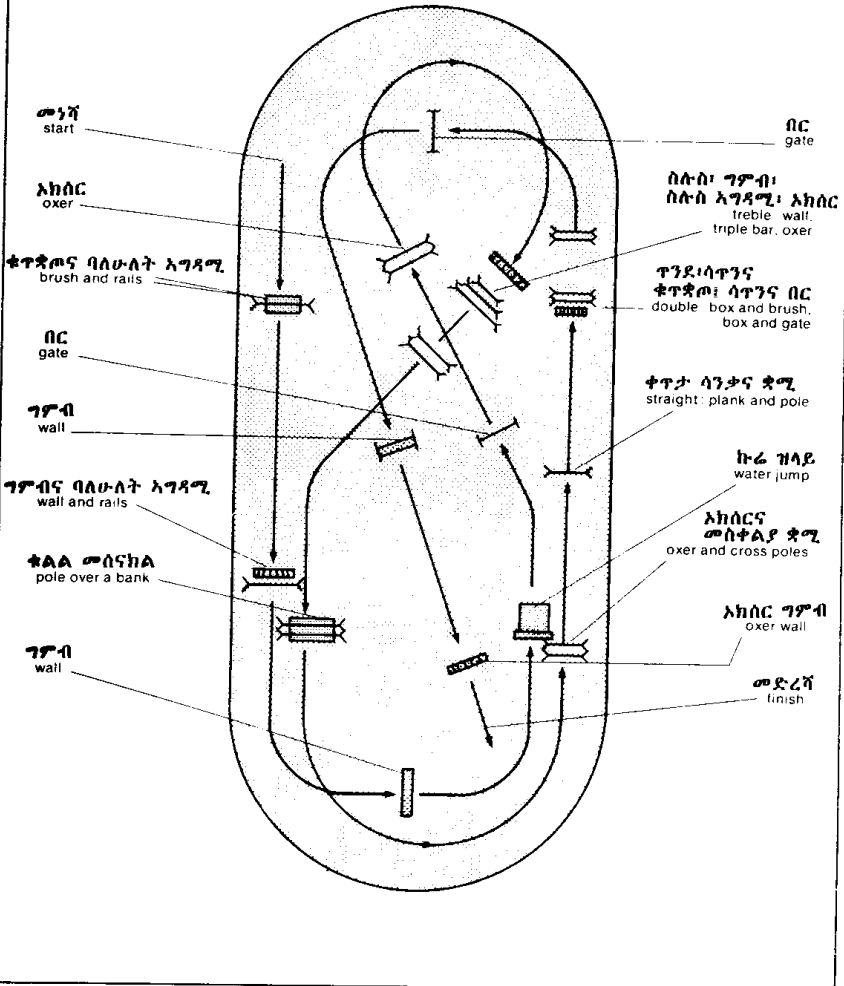

ገለልያ  
riding

(የ)ልጓም ትጥቅ  
bridle

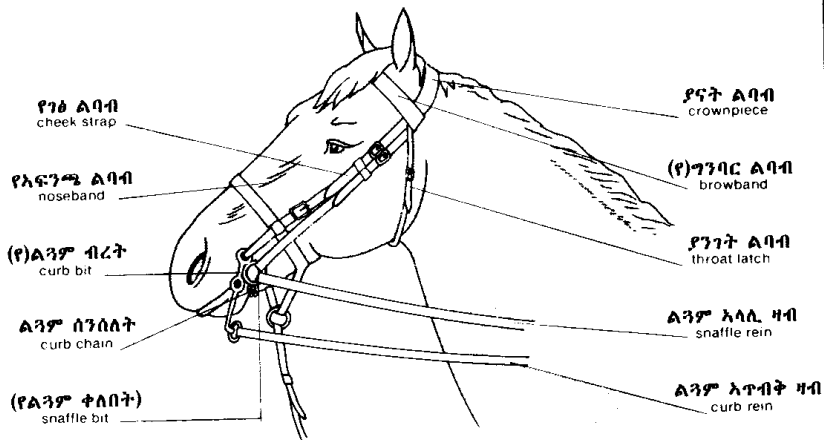

ኮርቻ  
saddle

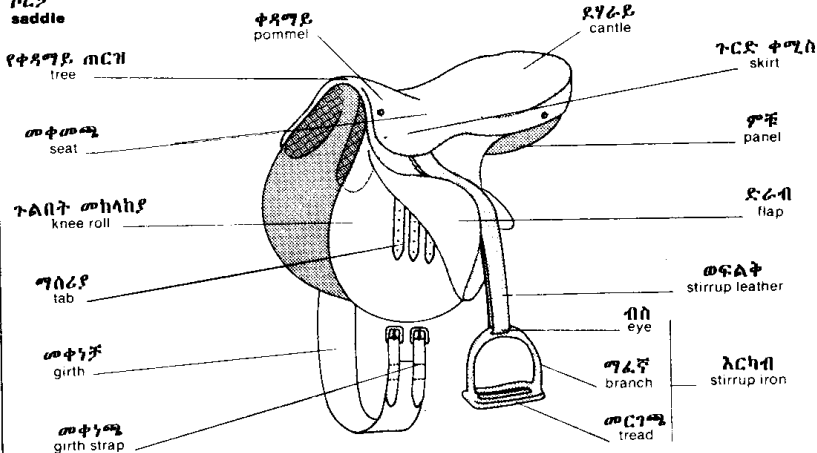

ፍውዝ (ፍጫ፣ ውርወራ፣ ዝላይ) track and field athletics

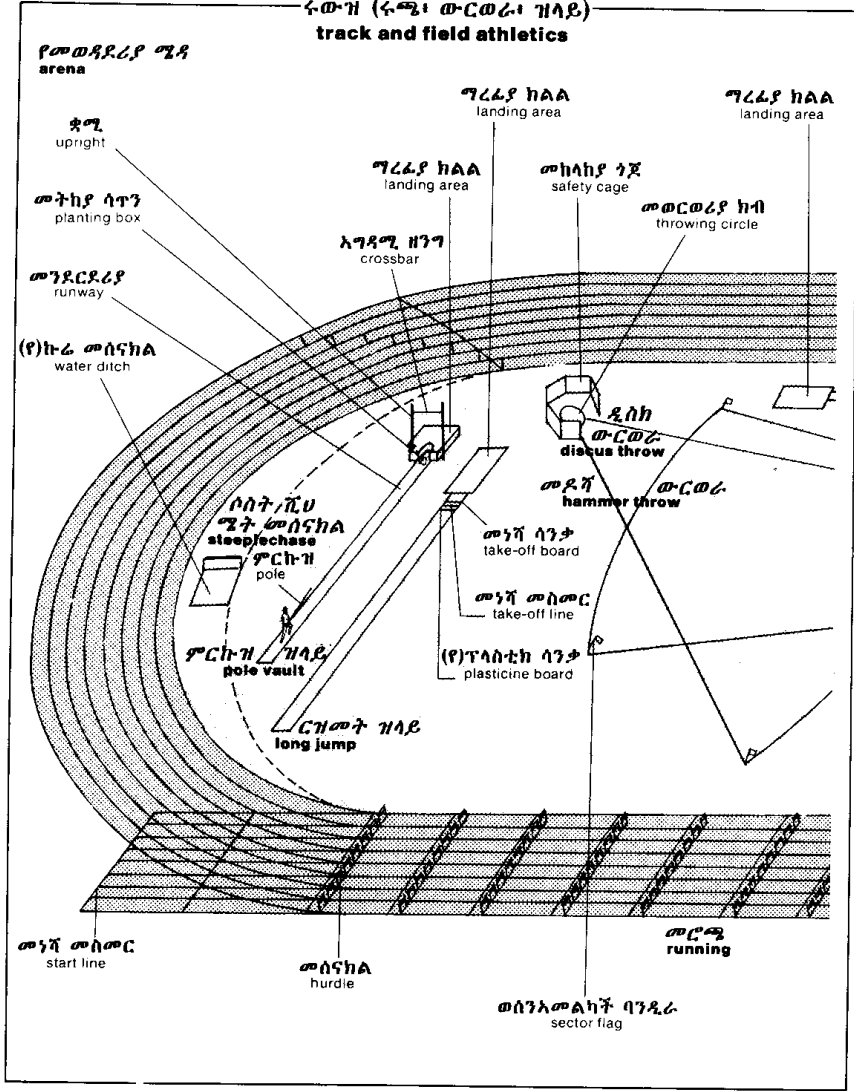

ሩውዝ (ሩጫ፣ ውርወራ፣ ዝላይ)  
 track and field athletics

የመወዳደሪያ ማዳ  
 arena

መነሻ ላንታ  
 take-off board

መንደርደሪያ  
 runway

መጥ  
 lane

መጥ መስመር  
 track

ግረሬያ ክልል  
 landing area

የውርወራ ቅስት  
 throwing circle

triple jump ስለ-ስ ዝላይ

አለ-ለ ውርወራ  
 shot put

(የ)ወርዋሪ መገቻ  
 stopboard

ጦር ውርወራ  
 javelin throw

upright ቋሚ

አገዳሚ ዘንግ  
 crossbar

ግረሬያ ክልል  
 landing area

high jump  
 (የ)ከፍታ ዝላይ

መንደርደሪያ  
 runway

የውርወራ ቅስት  
 throwing arc

(የ)መድረሻ ቋሚ  
 finishing post

መድረሻ መስመር  
 finish line

ፍውዝ (ፍጫ፣ ውርወራ፣ ዝላይ)

track and field athletics

ውርወራዎች  
throwings

መደብ  
hammer

ራስ  
head

አሁሪ  
swivel

ሽቦ  
wire

4 1/8 ኢንች 4.1 in  
10.5 ሴ.ሜ. 10.5 cm

4 3/8 ኢንች 4.1 in  
11 ሴ.ሜ. 11 cm

አጀታ  
handle

ግንቲ  
glove

4-4 3/4 ኢንች 4.4 in  
102-120 ሜ.ሜ. 102-120 mm

ጠሮች  
javelins

7 ሜግ 2 1/2 ኢንች - 7 ሜግ 6 1/2 ኢንች  
7 ft 2 1/2 in - 7 ft 6 1/2 in  
220 - 230 ሴ.ሜ.

8 ሜግ 6 1/4 ኢንች - 8 ሜግ 10 1/4 ኢንች  
8 ft 6 1/4 in - 8 ft 10 1/4 in  
260 - 270 ሴ.ሜ.

ሜፍ  
tip

ብረት ራስ  
metal head

የፊት ዘንግ  
shaft

አጀታ  
cord grip

ደስካ  
discus

ጠሮዝ  
rim

አካል  
body

ክብደት  
weight

8 5/8 - 8 3/8 ኢንች  
8 5/8 - 8 3/8 in  
219 - 221 mm

7 1/8 - 7 1/4 ኢንች  
7 1/8 - 7 1/4 in  
180 - 182 mm

አሎሎዎች  
shots

4 3/8 - 5 1/8 ኢንች  
4 3/8 - 5 1/8 in  
110 - 130 mm

3 3/4 - 4 3/8 ኢንች  
3 3/4 - 4 3/8 in  
95 - 110 mm

ጅምናስቲክ  
gymnastics

የጅምናስቲክ መሳሪያ (የወንዶች)  
men's apparatus

ቀለበቶች  
rings

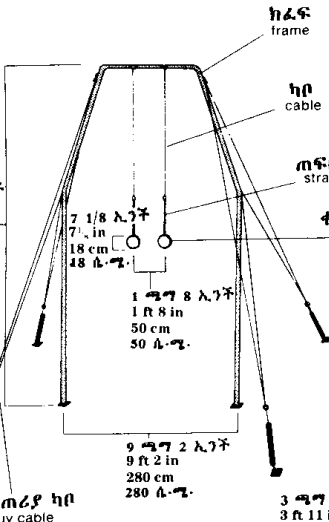

ባለቀዳማይ ኮርቻ  
pommel horse

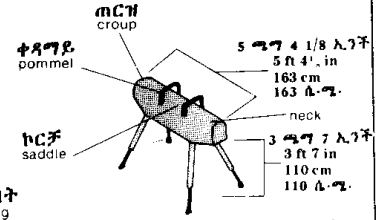

መዝለያ ፈረስ  
vaulting horse

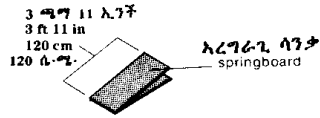
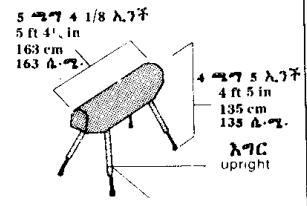

ትይዩ ዘንግ  
parallel bars

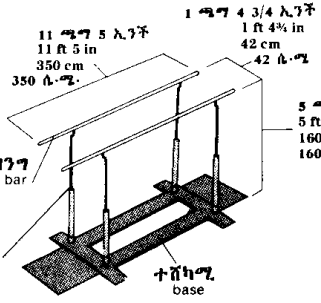

አገዳሚ ዘንግ  
horizontal bar

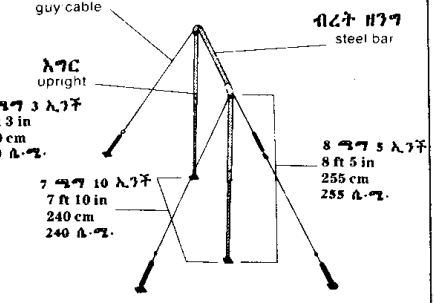



ጅምናስቲክ  
gymnastics

የጅምናስቲክ መሳሪያ (የሴቶች)  
women's apparatus

(የ)ሚዛን አግዳሚ  
balance beam

ወጣ ገብ ትይዩ ዘንግ  
uneven parallel bars

የላይ ዘንግ  
top bar

ታች ዘንግ  
low bar

ሁለተኛ ሰፈፋ  
second flight

(የ)ግረሬያ ፍሬሽ  
landing mat

መዝለያ ፈረስ  
vaulting horse

ጅምናስቲክኛ  
gymnast



መንደርደር  
run



ድጋፍ  
support



አረግሬጊ ሳንታ  
springboard

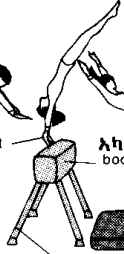

አካል  
body

አግር  
upright



ግረፍ  
landing

የመንጠሪያ አልጋ  
trampoline

አልጋ  
bed

መከላከያ ክፈፍ  
safety pad

አግር  
leg

ሞላ  
spring

ክፈፍ  
frame

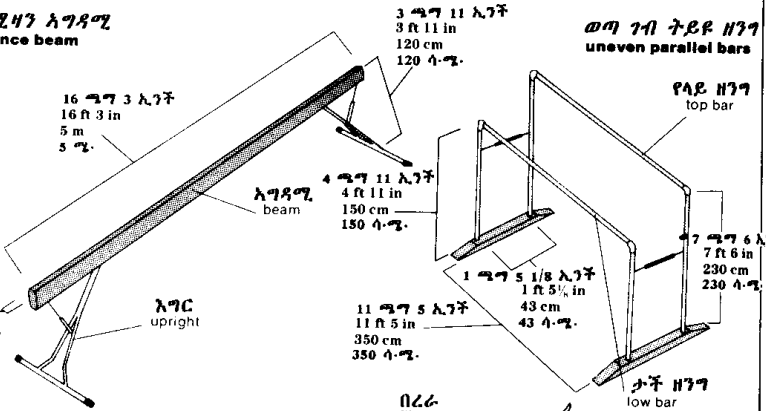

ክብደት ማንባት  
weightlifting

ክብደት አንሺ  
weightlifter

ክብደት  
weight

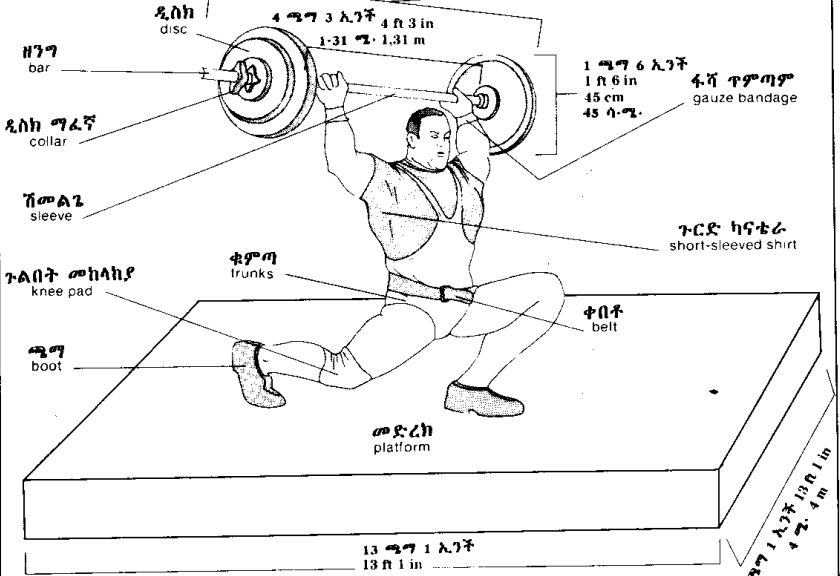

ምንጨቃ አነሳስ  
two-hand snatch

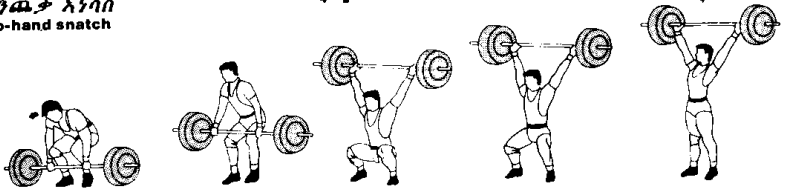

ዝግ ነጠላ አነሳስ  
two-hand clean and jerk

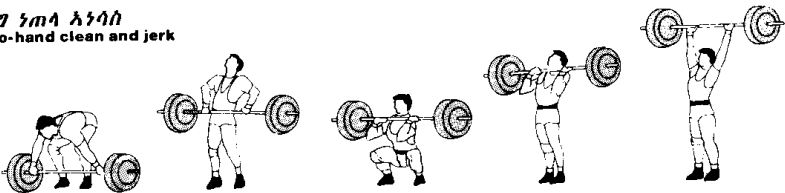

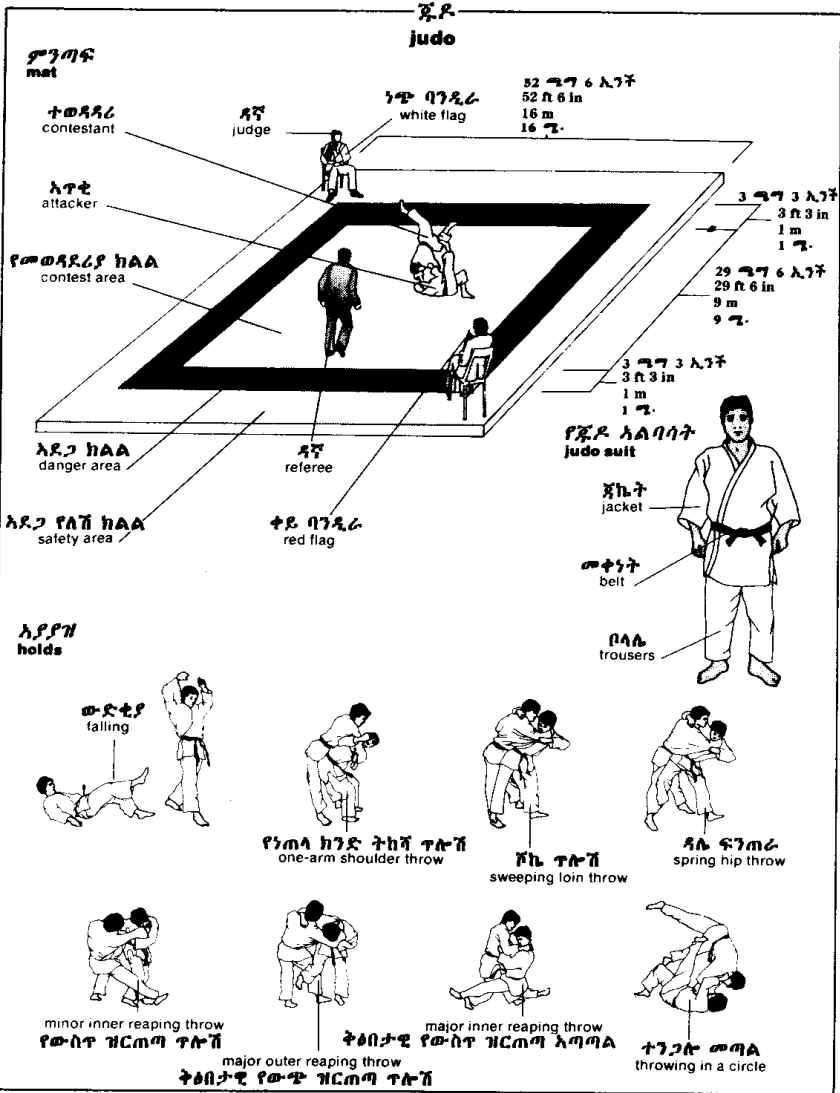

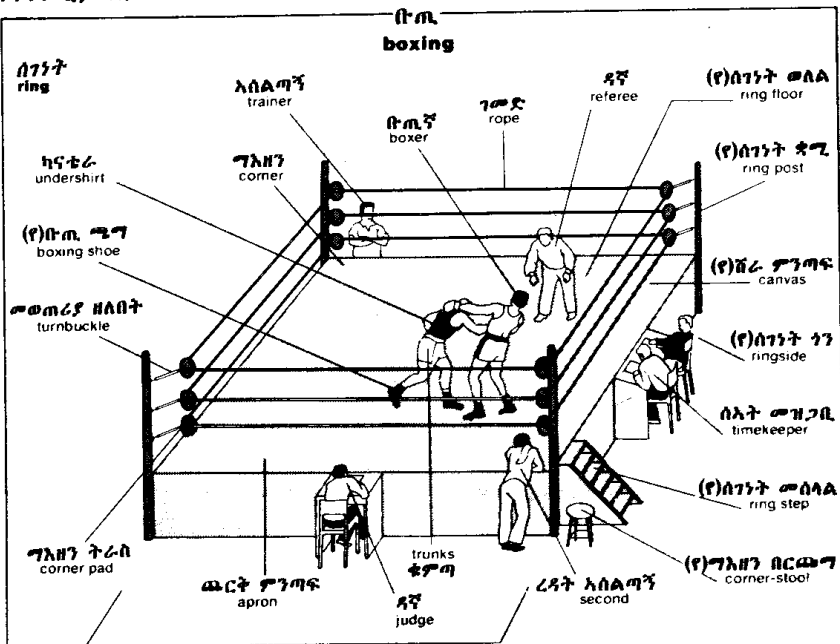

**(የ)ቡጢ ጓጓት boxing glove**

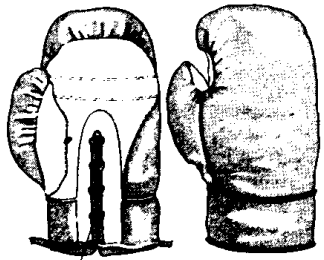

**ገሰሪያ lace**

**ፋኛ bandage**

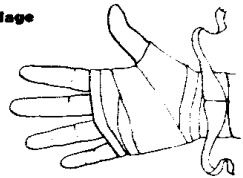

**የፕሮስ ጫላጎጥ mouthpiece**



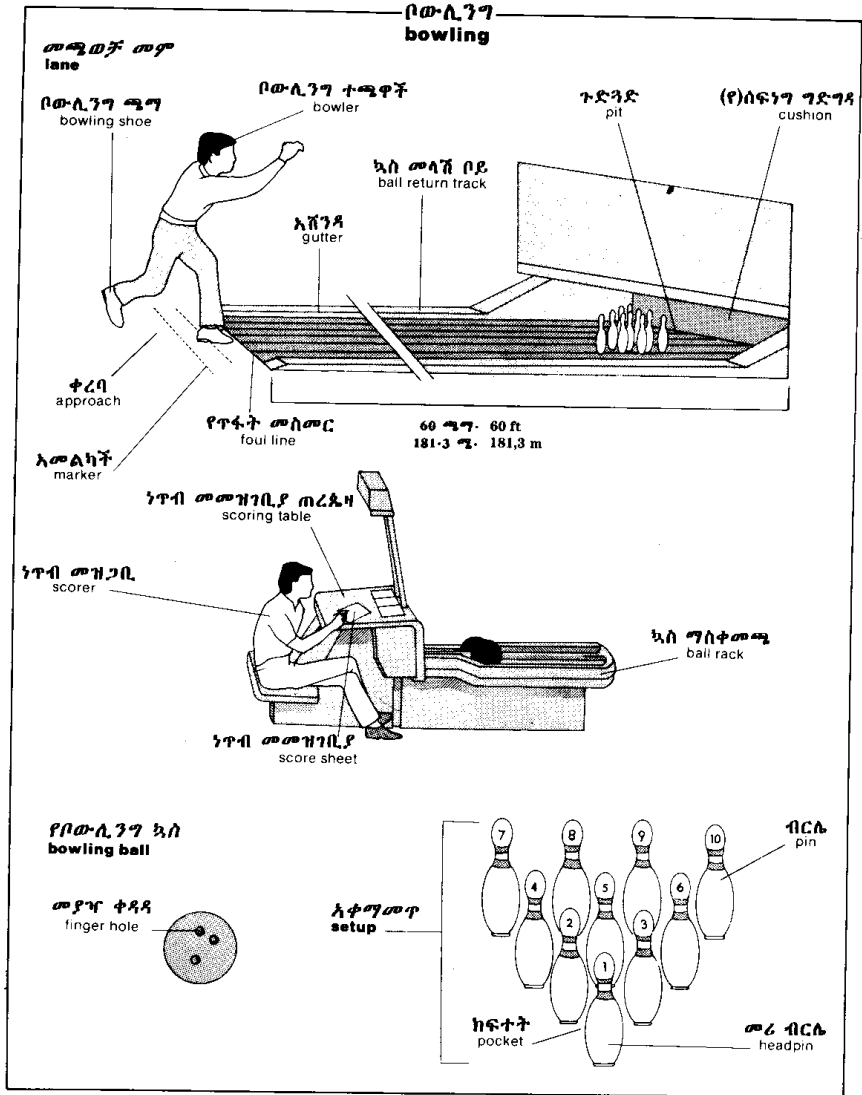

ሰንጠረዥ  
chess

ወንዶች  
men

ትንጣቶች  
pieces

ወታደር  
pawn

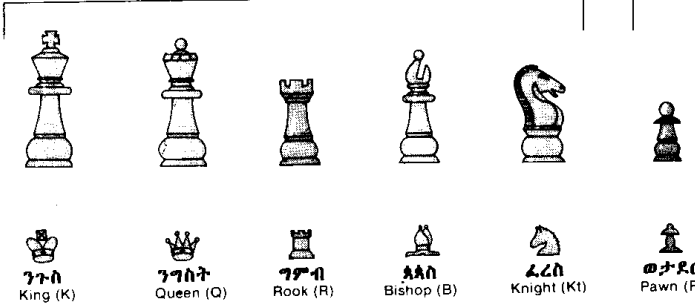

የሰንጠረዥ ሰሌዳ  
chessboards

ሰንጠረዥ ሰሌዳ  
French chessboard  
ጥቁር  
Black

የሰንጠረዥ አሰላሰፍ  
chess notation

a system

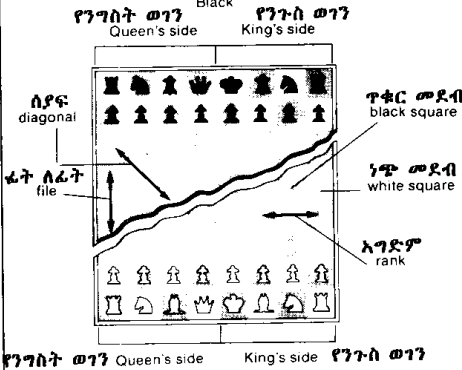

QR QKI QB Q K KB KKI KR

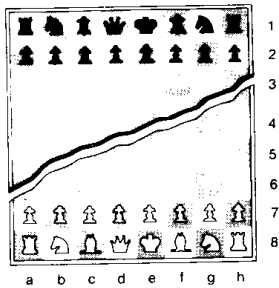

የንጉስት ወገን Queen's side King's side የንጉስ ወገን

ነጭ White  
ሰንጠረዥ ሰሌዳ  
English chessboard

b system

backgammon

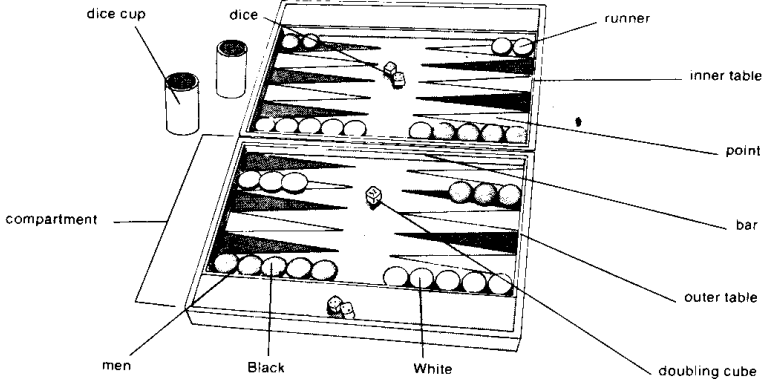

(የ)ካርታ ጨዋታ  
card games

ተምሳሌት  
symbols



♥ heart  
♦ diamond  
♣ club  
♠ spade



Ace  
ፋንጥ



King  
ንጉስ

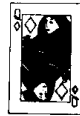

Queen  
ንግስት



Jack  
ወለድ



Joker  
አጫዋች

standard poker hands

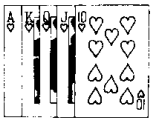

royal flush



straight flush

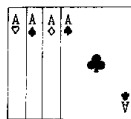

four of a kind

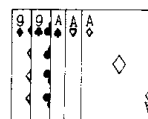

full house

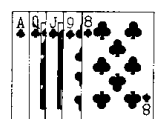

flush

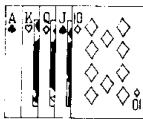

straight



three of a kind



two pairs



one pair

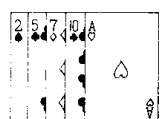

high card

ኩብ  
dice

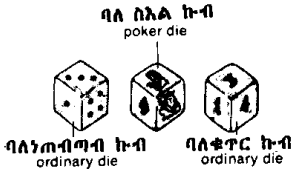

ጾጊኛ  
dominoes

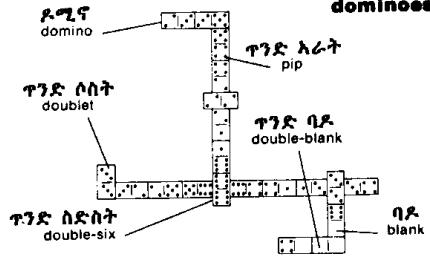

mah-jongg

suit tiles

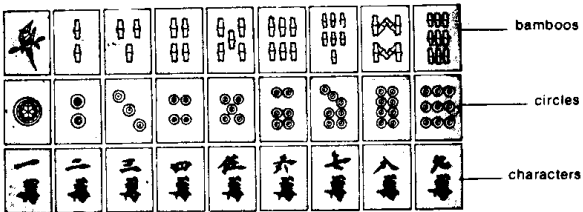

honor tiles

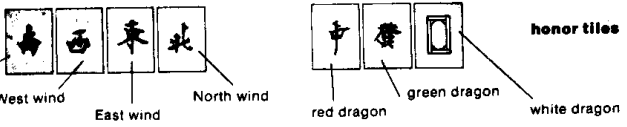

bonus tiles



square

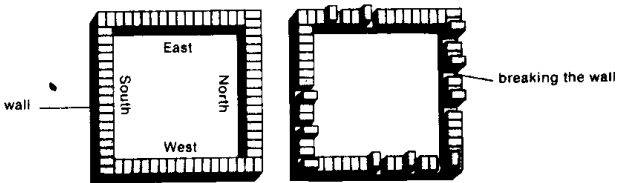



ድንኳኖች  
tents

የቤተሰብ ድንኳን  
family tents

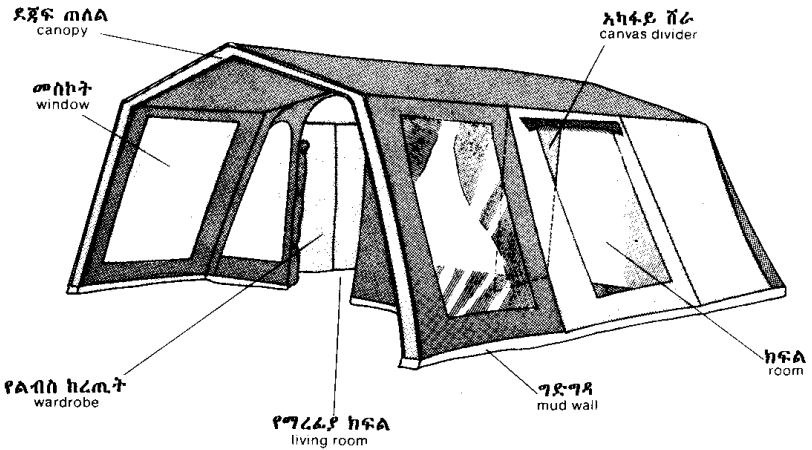
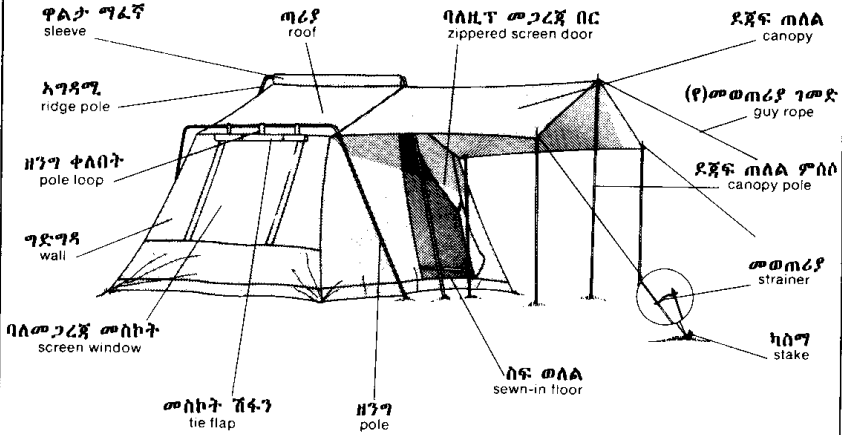

ድንኳኖች  
tents

አምራ ክንፍ ድንኳን  
pup tent

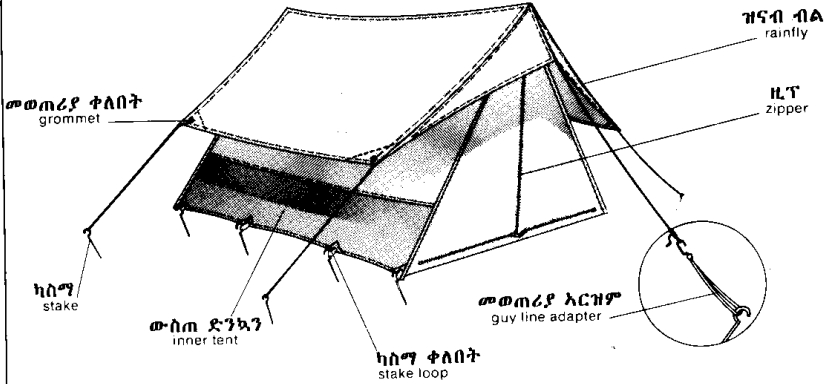

ዋናዎቹ የድንኳን አይነቶች  
major types of tents

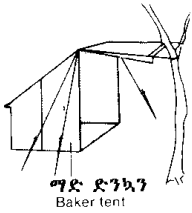

ሰቀላ ድንኳን  
wall tent

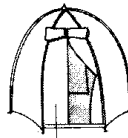
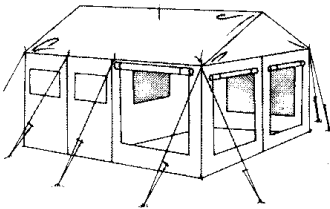

ፖፑ-ህፕ ድንኳን  
pop-up tent

ሰረገላ ድንኳን  
wagon tent

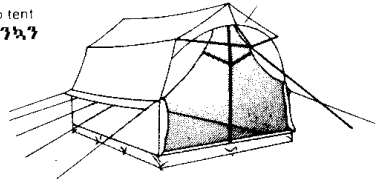

የሰፈራ መሳሪያዎች  
camping equipment

መተኛ ክረጢት  
sleeping bags

ሸፋን (የጠበቀ)  
mummy

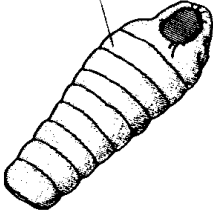

ገግሰ ሽፍን  
semi-mummy

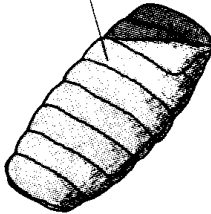

አራት ግእዘን  
rectangular

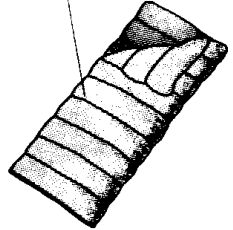

የመኝታ ፍራሽና እቃዎች  
bed-mattress and accessories

ታጣፊ አላጋ  
folding camp bed

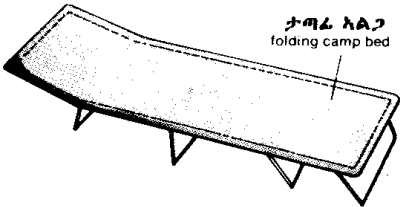

ስፍነግ ፍራሽ  
foam mattress

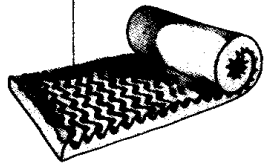

ስፍነግ ፖንጣፍ  
foam pad



አየርጥላ ፍራሽ  
air mattress

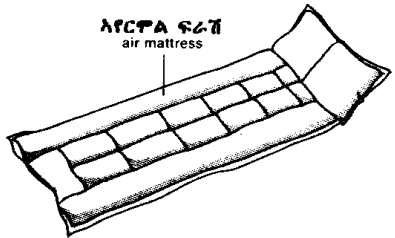

መንፈያና ግስተንፈኛ (አየር)  
inflator-deflator



አየር መንፈያ  
inflator

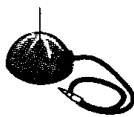

የሰፈራ መሳሪያዎች  
camping equipment

ቡታጋዝ መሳሪያዎች  
propane accessories

ቡታጋዝ ሲሊንደር  
propane cylinder

ግፊት አስተካካይ  
pressure regulator



ግጥቂያ  
heater

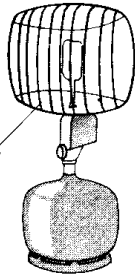

ግብ  
lantern

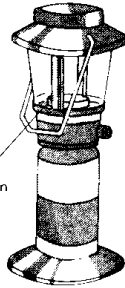

ባለአንድ ፍሮዳ  
one-burner camp stove

ድጋፍ ሰጪ ሽቦ  
wire support

ገፋስ መከላከያ  
wind baffle

መቆጣጠሪያ ባልቦላ  
control valve



ባለሶስት ፍሮዳ  
three-burner camp stove

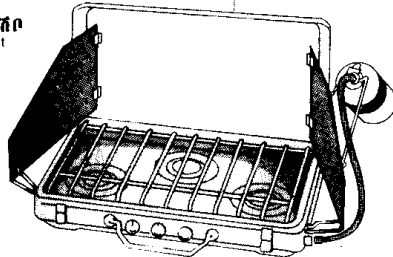

ግብረት ለቃዎች  
cook kit

የቡና ኩስኩስት  
coffee pot

ጀበና  
kettle

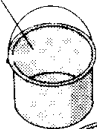

ሲኒ  
cup



ሳህን  
plate



መጥበሻ  
frying pan



እጀታ  
handle

ጥምር ሰንጠረዥ  
combination knife

ሰንጠረዥ  
penknife

ቢላዎ  
knife

መቀስ  
scissors

መጋዝ  
saw

ቆርቆሮ መክፈቻ  
can opener

ግንኪያ  
spoon

ግህደረ ሰንጠረዥ  
leather sheath

ሹካ  
fork

መታጠቂያ ማፈኛ  
belt loop

ቡሽ መክፈቻ  
corkscrew

(የ)ጠመንጃ  
screwdriver

ጥረድ  
file

መለኪያ  
gauge

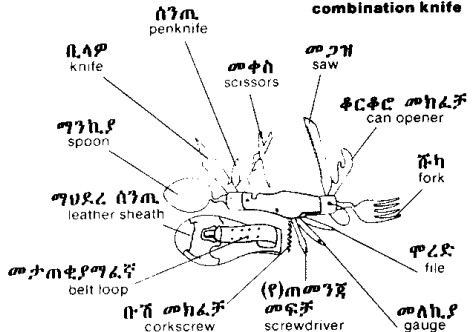

የሰፈራ መሳሪያዎች  
camping equipment

መሳሪያዎች  
tools

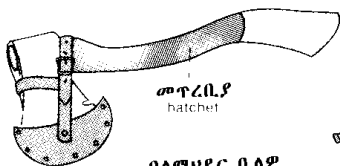

መጥረቢያ  
hatchet

ባለግህደር ቢላዎ  
sheath knife

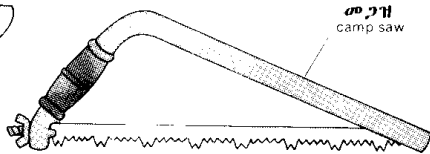
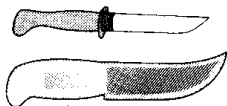

መጋዝ  
camp saw

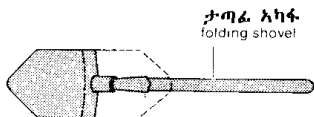

ታጣፊ አካፋ  
folding shovel

ማብሰል  
cooking

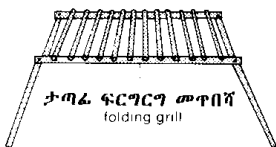

ታጣፊ ፍሮግርግ መጥበኝ  
folding grill

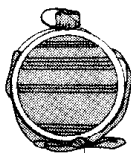

ኮዳ  
canteen

የውሃ መያዣ (ጀግ)  
water jug

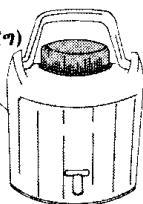

ብርሃን  
lighting

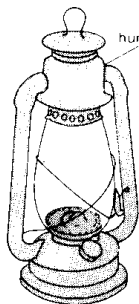

ፋኖስ  
hurricane lamp

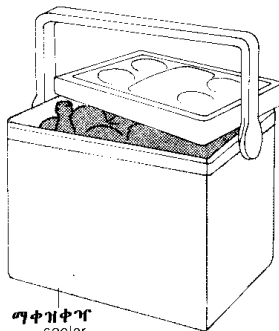

ማቀዝቀዣ  
cooler

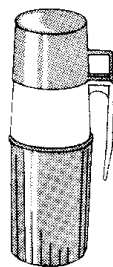

ፔሮሙስ  
vacuum bottle

ቋጦሮ  
knots



አቃፊ ቋጦሮ  
overhand knot



ድርብ ቋጦሮ  
reef knot



ድርብ ወጣ ገብ ቋጦሮ  
granny knot



ቅረፀ ስምንት ቋጦሮ  
figure-eight knot



ጥብቅ ጥምጥም ቋጦሮ  
heaving line knot



ተጣላፊ ቋጦሮ  
sheet bend



ጥንድ ተጣላፊ ቋጦሮ  
double sheet bend

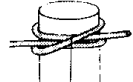

ድርብ ዙር ቋጦሮ  
clove hitch

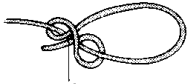

ሸምቀቆ  
running bowline



ደረቅ ቋጦሮ  
bowline



ድርብ ደረቅ ቋጦሮ  
bowline on a bight

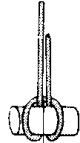

ድርብ ሸምቀቆ  
cow hitch

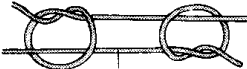

አሳ አጥማጅ ቋጦሮ  
fisherman's knot



ረዛሚ አጣሪ ቋጦሮ  
sheepshank



አጠናካሪ ቋጦሮ  
common whipping

ገመድ ቅጠላ  
short splice

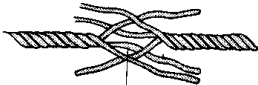

ውስብስብ ቋጦሮ forming



ዛብ ቋጦሮ  
completion

ካቦ  
cable

ጥምዝ ገመድ  
twisted rope

ጉንጉን ገመድ  
braided rope

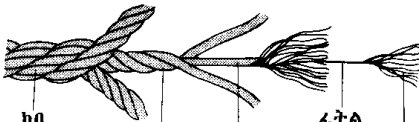

ካቦ  
cable

ገመድ  
rope

ክር  
strand

ፈትላ  
yarn

ቃጫ  
fibre



ጉንጉን ሽፋን  
sheath

(የ)ውስጥ ጉንጉን  
core