

605079

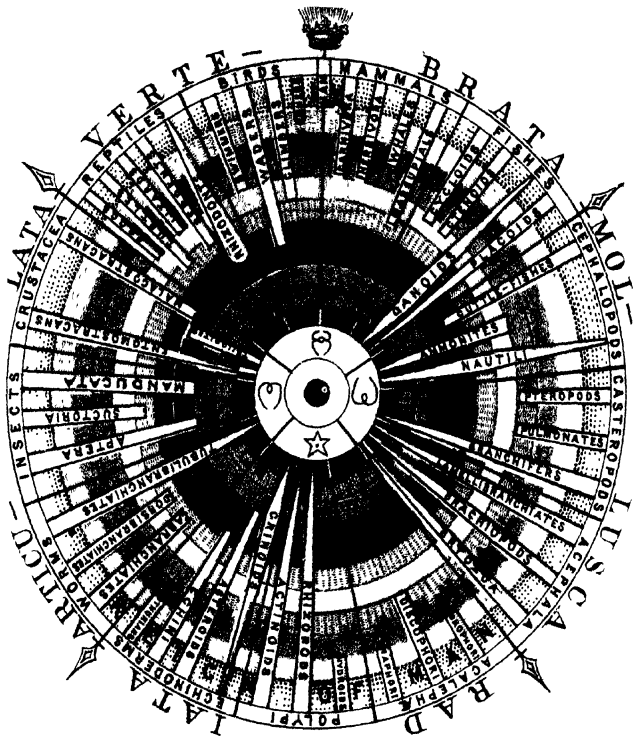

IV. Modern Age.	Human Epoch,
	Drift or Glacial,
III. Tertiary Age.	Upper Tertiary Formation.
	Lower Tertiary.
	Cretaceous,
II. Secondary Age.	Oolitic,
	Triassic,
	Carboniferous,
I. Palaeozoic Age.	Devonian,
	Upper Silurian,
	Lower Silurian,

Metamorphic Rocks.

CRUST OF THE EARTH AS RELATED TO ZOOLOGY

OUTLINES
OF
COMPARATIVE PHYSIOLOGY,
TOUCHING
THE STRUCTURE AND DEVELOPMENT
OF THE
RACES OF ANIMALS, LIVING AND EXTINCT.

FOR THE USE OF SCHOOLS AND COLLEGES.

•

BY
LOUIS AGASSIZ
AND
A. A. GOULD.

Edited from the Revised Edition, and greatly enlarged.

BY
THOMAS WRIGHT,

WITH 390 ILLUSTRATIONS.

LONDON:
H. G. BOHN, YORK STREET, COVENT GARDEN.
MDCCCLI.

J BILLING,
PRINTER AND STEREOTYPER,
WOKING, SURREY.

THE EDITOR'S PREFACE.

THE distinguished position occupied by Professor Agassiz, from his numerous and important contributions to Natural Science, especially his "*Recherches sur les Poissons Fossiles*," renders any eulogium on the contributions of so eminent a naturalist to zoological literature unnecessary.

The "Principles of Zoology," of which the present volume forms the first part, was designed by Professor Agassiz, in conjunction with Mr. Gould, as a text-book for the use of higher schools and colleges, for which it is undoubtedly well adapted, as the style is simple, the arrangement clear, and the range of subjects important and comprehensive: it is, moreover, well suited for imparting to the general reader a sound knowledge of Physiology and the Philosophy of Natural History.

In introducing the present edition of this work to the English public, the Editor desires to state that he has endeavoured still farther to increase its value, by large additions to several of the chapters. In doing so, he has availed himself of the treatises of Cuvier, Carus, and Meckel, on Comparative Anatomy; and those of Tiedeman, Müller, Valentin, and Wagner, on Physiology. From Dr. Willis's excellent translation of the Elements of the latter profound author much additional matter has been derived.

The additions from Wagner are duly acknowledged in the body of the work: those by the Editor are indicated by his

initials, and both are enclosed in brackets, so that the reader may readily distinguish between MM. Agassiz and Gould's text, and the additions made thereto.

The number and excellence of the wood-cuts form an important feature in this edition. With the exception of those belonging to the chapters on Embryology, and the Metamorphoses of Animals, they are nearly all additional, by which the original number is more than doubled: the American edition having only 170 wood-cuts, whilst the present contains 390. The beautiful drawings illustrative of human Osteology were engraved by Branston for the valuable Manual on the Bones by John F. South, Esq.; those illustrating the chapters on Circulation, Respiration, Secretion, and the Development of the Chick, are chiefly from Wagner's "*Icones Physiologicae*," and were engraved for the English translation of that author's Elements of Physiology; the other figures are selected from various sources, references to which are given in the Table of illustrations.

It has been the study of the Authors and of the Editor to exclude as much as possible a technical phraseology from the following pages; but as the use of scientific terms could not altogether be dispensed with, the Editor has given an interpretation of them in a copious Glossarial Index.

T. W.

Cheltenham, October, 1851.

P R E F A C E.

THE design of this work is to furnish an epitome of the leading principles of the science of Zoology, according to the present state of knowledge, so illustrated as to be intelligible to the young student. No similar treatise exists in this country, and indeed some of the topics have not been touched upon in the language, except in a strictly technical form, and in scattered articles. On this account, some of the chapters, such as those on Embryology and Metamorphosis, may at first seem too abstruse for the beginner. But so essential have these subjects now become to a correct interpretation of philosophical zoology, that the study of them will hereafter be indispensable. They furnish a key to many phenomena which have heretofore been locked in mystery.

The illustrations have been drawn from the best authorities ; some of them are merely hypothetical outlines, which convey a more definite idea than if drawn from nature ; others have been left imperfect, except as to the parts especially in question ; a large proportion of them, however, are complete and original. Popular names have been employed as far as possible, and Definitions of those least likely to be understood, will be found in the Glossary.

The principles of Zoology developed by Professor Agassiz in his published works have been generally adopted in this, and the results of many new researches have been added.

The Authors gratefully acknowledge the aid they have received in preparing the illustrations and working out the details from Mr. E. Desor, for many years an associate of Professor Agassiz; from Count Pourtalés and E. C. Cabot, Esq.; and also from Professor Asa Gray, by valuable suggestions in the revision of the letter-press.

The present volume is devoted to Comparative Physiology as the basis of classification; the second will comprise Systematic Zoology, in which the principles of classification will be applied, and the principal groups of animals briefly characterised.

Should our aim be attained, this work will produce more enlarged ideas of man's relations to Nature, and more exalted conceptions of the plan of Creation and its Great Author.

BOSTON, JUNE 1, 1848.

TABLE OF CONTENTS.

	Page
INTRODUCTION	xix
* CHAPTER FIRST.	
THE SPHERE AND FUNDAMENTAL PRINCIPLES OF ZOOLOGY	1
CHAPTER SECOND.	
GENERAL PROPERTIES OF ORGANIZED BODIES	9
SECTION I.	
Organized and Unorganized Bodies	9
SECTION II.	
Elementary Structure of Organized Bodies	10
SECTION III.	
Differences between Animals and Plants	20
CHAPTER THIRD.	
ORGANS AND FUNCTIONS OF ANIMAL LIFE	28
SECTION I.	
Of the Nervous System and General Sensation	28
Structure of the primary Fibres of Nerves, 29—Termination of the primary Fibres, 34—The Cerebro-spinal system of Man—The Cerebrum, 40—The Cerebellum, 41—The Optic Lobes, 42—The Spinal Cord, 42—Nervous system of Fishes, 44—Amphibia, 45—Scaly Reptiles, 45—Birds, 45—Mammalia, 46—Cerebral Nerves, 49—Nervous system of Articulata, 54—Conchifera, 55—Gasteropoda, 55—Cephalopoda, 56—Radiata, 57.	
SECTION II.	
Of the Special Senses	58
1. Of Sight, 58—The Eye, 58—Dioptrics of the Human Eye, 60—2. Of Hearing, 70—Comparative Anatomy of the Organ of Hearing, 70—80—3. Of Smell, 80—The Nose, 80—4 Of Taste, 81—5. Of Touch, 82—6. The Voice, 83.	

	Page
CHAPTER FOURTH.	
OF INTELLIGENCE AND INSTINCT	86
Perception	86
CHAPTER FIFTH.	
OF MOTION	91
SECTION I.	
Apparatus of Motion	91
Voluntary and Involuntary Muscles, 92—Microscopic Anatomy of Muscular Fibre, 90—94—Ciliary Motions, 95—Skeleton of Polyps, 100—Echinidæ, 101—Asteriadae, 102—Crinoidea, 103—Mollusca, 104—Articulata, 105—Vertebrata, 106.	
SECTION II.	
Organs of Locomotion	109
Skeleton of Man, 111—Composition of the Bones in Fishes, 113—Reptiles, 113—Birds, 113—Mammals, 113—Analysis of Bones, 114—Microscopic Structure of Bones, 115—The Head, 116—The Orbits, 123—The Trunk, 126—The Cervical Vertebrae, 127—The Dorsal Vertebrae, 129—The Lumbar Vertebrae, 130—The Sacrum, 131—The Coccyx, 131—The Vertebrae, 131—Comparative Table of the number of the Vertebrae, 134—The Thorax, 135—The Pelvic Arch, 136—The Thigh, 138—The Leg, 139—The Foot, 139—The Tarsus, 140—The Metatarsus, 140—Toes, 140—The Scapular arch, 141—The Scapula, 142—The Clavicle, 143—The Humerus, 143—The Hand, 146—The Carpus, 146—The Metacarpus, 146—The Phalanges, 147—1. Plan of the Organs of Locomotion in the Vertebrata, 148—2. Of Standing, and the Modes of Progression, 152—Walking, 154—Running, 155—Leaping, 155—Climbing, 155—Flight, 156—Swimming, 157.	
CHAPTER SIXTH.	
NUTRITION	159
SECTION I.	
Of Digestion	160
The Polypifera, 160—The Infusoria, 161—The Acalephæ, 162—The Echinoderms, 163—The Bryozooan Polypifera, 165—The Tunicated Mollusca, 166—The Conchifera, 166—The Gastro-poda, 167—The Cephalopoda, 171—The Annelida, 172—The Crustacea, 173—The Arachnida, 174—Insects, 174—The Vertebrata, 178—Organs of Mastication, 185—Insalivation, 191—Prehension, 193.	

CHAPTER SEVENTH.

OF THE BLOOD AND CIRCULATION 194
 Blood globules in Man, 194—Mammalia, 196—Birds, Reptiles, and Fishes, 197, 198—Blood vessels, 199—Heart, 200—Circulation of the Blood in Mammals and Birds, 202—Reptiles, 203—Fishes, 204—Crustacea, Mollusca, and Insecta, 205—Capillary Vessels, 207—Circulation of the Blood in the Web of the Frog's foot, 208—212—Circulation in the Lungs of the Triton, 213.

CHAPTER EIGHTH.

OF RESPIRATION 216
 The Echinoderms, 27—The Tunicata, 218—The Conchifera, 219—The Gasteropoda, 219—The Pteropoda, 220—The Cephalopoda, 220—The Crustacea, 220—The Annelida, 220—Fishes, 221—Insects, 223—Air-breathing Vertebrata, 225—Development of the Lungs, 226—231—Respiration in Gases other than Atmospheric Air, 234.

CHAPTER NINTH.

OF THE SECRETIONS 241
 Endosmose and Exosmose, 243—Structure of Glands, 246—Elementary parts of Glands, 263—Origin of Glands, 265—Distribution of the Vessels in Glands, 269.

CHAPTER TENTH.

EMBRYOLOGY 272

SECTION I.

Of the Egg 271
 Form of the Egg, 272—Formation of the Egg, 273.

SECTION II.

Development of the Young within the Egg 278
 Development of Fishes, 280—289—Development of the Chick, 290—Structure of the Egg as just laid, 290—Detachment of the Ovum from the Ovary, and completion of its formation in the Oviduct, 292—Earliest Period in the Development of the Chick, from the first appearance of the Embryo to the first traces of Circulation, 295—Second Period of the Development of the Chick, to the Evolution of the Second Circulation, 308—Third Period in the history of the Development of the Incubated Egg: from the commencement of the Circulation in the Allantois to the Exclusion of the Embryo, 324—Birth of the Chick, 333—Physical and Chemical changes in the Egg during Incubation, 334.

SECTION III

Zoological Importance of Embryology 336

	Page
CHAPTER ELEVENTH.	
PECULIAR MODES OF REPRODUCTION	339
SECTION I.	
Gemmiparous and Fissiparous Reproduction	339
SECTION II.	
Alternate and Equivocal Reproduction	348
SECTION III.	
Consequences of Alternate Generation	348
 CHAPTER TWELFTH.	
METAMORPHOSES OF ANIMALS	353
 CHAPTER THIRTEENTH.	
GEOGRAPHICAL DISTRIBUTION OF ANIMALS	363
SECTION I.	
General Laws of Distribution	363
SECTION II.	
Distribution of the Faunas	369
1. Arctic Fauna, 371—2. Temperate Faunas, 373—Tropical Faunas, 377.	
SECTION III.	
Conclusions	380
 CHAPTER FOURTEENTH.	
GEOLOGICAL SUCCESSION OF ANIMALS; OR, THEIR DISTRIBUTION IN TIME	390
SECTION I.	
Structure of the Earth's Crust	390
SECTION II.	
Ages of Nature	396
The Palæozoic Age, 397 — The Secondary Age, 402 — The Tertiary Age, 414—The Modern Epoch, 415—Conclusion, 417.	
List of the most important Authors who may be consulted in reference to the Subjects treated in this Work	419
GLOSSARIAL INDEX	421

EXPLANATION OF THE FIGURES.

FRONTISPIECE.—The diagram opposite the title-page is intended to present, at one view, the distribution of the principal types of animals, and the order of their successive appearance in the layers of the earth's crust. The four Ages of Nature, mentioned at page 190, are represented by four zones, each of which is subdivided by circles of different shades, indicating the number of formations of which it is composed. The whole disc is divided by radiating lines into four segments, to include the four great departments of the animal kingdom; the Vertebrata are placed in the upper compartment, the Articulata at the left, the Mollusca at the right, and the Radiata below, as being the lowest in rank. Each of these compartments is again subdivided to include the different classes belonging to it, which are named at the outer circle. At the centre is placed a figure representing the primitive egg, with its germinative vesicle and germinative dot (§ 436), indicative of the universal origin of all animals, and the epoch of life when all are apparently alike. Surrounding this, at the point from which each department radiates, are placed the symbols of the several departments, as explained on page 337. The zones are traversed by rays which represent the principal types of animals; their origin and termination indicate the age at which they first appeared or disappeared; all those which reach the circumference being still in existence. The width of the ray indicates the greater or less prevalence of the type at different geological ages. Thus, in the class of Crustaceans, the Trilobites commence in the earliest strata, and disappear with the carboniferous formation. The Ammonites also appeared in the Silurian formation, and became extinct with the deposition of the Cretaceous rocks. The Belemnites appear in the lower Oolitic beds; many new forms commence in the Tertiary; a great number of types make their appearance only in the Modern age; while only a few have continued from the Silurian, through every period to the present. Thus, the Crinoids were very numerous in the Primary Age, and are but slightly developed in the Tertiary and Modern Age. It is seen, at a glance, that the animal kingdom is much more diversified in the latter, than in the earlier ages.

Below the circle is a section, intended to show more distinctly the relative position of the ten principal formations of stratified rocks (§ 648), composing the four great geological ages; the numerals corresponding to those on the ray leading to Man, in the circular figure. See also figure 376.

The CHART OF ZOOLOGICAL REGIONS, page 370, is intended to show the limits of the several Faunas of the American Continent, corresponding to the climatal regions. As the higher regions of the mountains correspond in temperature to the climate of higher latitudes, it will be seen that the northern temperate fauna extends, along the mountains of Mexico and Central America, much farther towards the Equator, than it does on the lower levels. In the same manner, the southern warm fauna extends northward, along the Andes.

- | | | | |
|------|--|------|---|
| Fig. | | Fig. | |
| 1 | Tissue of the house leek. Agassiz | 21* | A portion of the spinal cord shewing the double union of the nerves . . . Edwards |
| 2 | Pith of the elder . . . Ibid. | 22 | The brain of the eel seen from above . . . Carus |
| 3 | Microscopic structure of cartilage . . . Schwann | 23 | The brain of the eel seen from below . . . Ibid. |
| 4 | Branchial cartilage of the larva of a frog . . . Ibid. | 24 | The brain of the tortoise seen from above . . . Bojanus |
| 5 | Evolution of cellular tissue. Ibid. | 25 | The brain of the tortoise seen from below . . . Ibid. |
| 6 | Evolution of muscular fibre. Ibid. | 26 | The brain of the turkey seen from above . . . Carus |
| 7 | Evolution of nervous fibre. Ibid. | 27 | The brain of the pigeon seen from below . . . Ibid. |
| 8 | Nucleated cells from the granulations of the umbilical cord. Breschet | 28 | The brain and spinal cord of the rat . . . Ibid. |
| 9 | Primary fibres of a human nerve . . . Wagner | 29 | The brain of the hare . Ibid. |
| 10 | Branch of a nerve distributed to a muscle of the eye . Ibid. | 30 | The brain of the common cat. Ibid. |
| 11 | Primary fibres of the olfactory nerve in man . . . Valentin | 31 | The brain and spinal cord of the racoon . . . Ibid. |
| 12 | Terminal plexus of the auditory nerve (pike) . . . Wagner | 32 | The brain of a monkey laid open . . . Ibid. |
| 13 | Terminal plexus from the ciliary ligament (duck) . Valentin | 33 | The brain of a monkey seen from below . . . Ibid. |
| 14 | Terminal fibres (central) from the yellow substance of the cerebellum . . . Wagner | 34 | The nervous system of the garden beetle . . . Ibid. |
| 15 | Abdominal ganglion of the sympathetic nerve . . . Ibid. | 35 | The nervous system of <i>Paludina vivipara</i> . Cuvier |
| 16 | Primary fibres of the intercostal nerve of the sparrow . Ibid. | 36 | The nervous system of the starfish . . . Tiedeman |
| 17 | Thin slice from the cervical ganglion of the calf. Valentin | 37 | Section of the globe of the eye . . . Agassiz |
| 18 | Primary fibres and ganglion globules of the human brain. Ibid. | 38 | Diagram shewing the effect of the eye on rays of light. Wagner |
| 19 | The nervous system of Man. [Milne Edwards | 39 | Diagram shewing the effect of the eye on rays of light. Wagner |
| 20 | A section of the human brain, shewing likewise the point of union of the cerebral nerves therewith . . . Ibid. | 40 | Ditto ditto . . . Ibid. |
| 21 | The brain and spinal cord of the <i>Cyprinus atburnus</i> . Carus | 41 | Ditto ditto . . . Ibid. |
| | | 42 | Ditto ditto . . . Ibid. |

- | | | | |
|--------|---|-------------|--|
| Fig. | | Fig. | |
| 43 | Optical diagram . . . Wagner | 75 | <i>Astacus Vectensis</i> , from Isle of Wight . . . Mantell |
| 44 | Compound eyes of insects and crustacea . . . Müller | 75* | External skeleton of <i>Dasyypus sewcinctus</i> . |
| 45 | Vertical section of the organ of hearing in man . . . Edwards | 76 | The muscular system of the perch . . . Carus |
| 46 | Malleus or hammer-bone of the internal ear . . . South. | 77 | The muscular system of the <i>Falco nisus</i> . . . Ibid. |
| 47 | Incus or anvil bone ditto. Ibid. | 78 | The skeleton of man. Cheselden |
| 48 | Stapes or stirrup ditto. Ibid. | 79 | The human cranium . . . South |
| 49 | Chain of bones in situ. Ibid. | 80—83 | The temporal bones. Ibid. |
| 50 | Relative situation of the tympanum and labyrinth. Soëmmering | 84 | The calvaria of the human skull . . . Ibid. |
| 51 | Views of the labyrinth. Ibid. | 85 | The temporal bones . . . Ibid. |
| 52 | Ditto of the cochlea. Ibid. | 86 and 87 | External and internal views of ditto . . . Ibid. |
| 53 | Ditto of the semicircular canals. [Ibid. | 88 and 89 | Anterior and posterior faces of petrous portion. Ibid. |
| 54 | Ditto ditto ditto. Ibid. | 90, 90* | External and internal views of the occipital bone. Ibid. |
| 55 | The cochlea, base and apex. Ibid. | 91 | The sphenoid and ethmoid. Ibid. |
| 56 | The spiral laminae of the cochlea . . . Ibid. | 92 | The superior and inferior maxillaries . . . Ibid. |
| 57 | The external shell of the cochlea removed . . . Ibid. | 93 | Internal view of the superior maxillary . . . Ibid. |
| 58 | Horizontal section of the cochlea . . . South | 94 | The partition of the nostrils. Ibid. |
| 59 | Front view of the human larynx. | 95 | A vertical section of the orbits, nostrils, and palate. Ibid. |
| 60 | The larynx of the merganser (<i>Mergus Merganser</i>). | 96 | The lateral boundary of ditto. Ibid. |
| 60 | A muscular fasciculus of the ox. [Wagner | 97 | The orbits . . . Ibid. |
| 61 | The structure of human muscle. [Ibid. | 98 and 99 | Views of the internal structure of the nose . . . Ibid. |
| 62 | Muscular fibre, after Skey. Skey | 100, 101 | The internal and external surface of the superior maxilla. Ibid. |
| 63 | Muscles from the back of the rattle-snake . . . Wagner | 102 | The osseous roof of the mouth . . . Ibid. |
| 64 | Muscular fibres from the invertedrata . . . Ibid. | 103, 104 | External and internal surfaces of the superior maxilla. [Ibid. |
| 65 | Muscular fibres from the esophagus . . . Skey | 105 | The dorsal vertebrae. Ibid. |
| 66 | Streaked muscles of the <i>Scolopendra Afra</i> . . . Wagner | 106, 107 | The cervical ditto. Ibid. |
| 67 | Cilia arising from the epithelial cylinders . . . Ibid. | 108 and 109 | The atlas . . . Ibid. |
| 68 | Epithelial cells producing cilia. [Ibid. | 110 | The axis . . . Ibid. |
| 69, 70 | <i>Litharæa Websteri</i> . Sowerby | 111 | The seventh cervical vertebra. [Ibid. |
| 71 | The test of an echinus. Edwards | 112, 113 | The dorsal vertebrae. Ibid. |
| 72 | <i>Apocrinus rotunda</i> . . . Miller | 114 | The mode of articulation of the dorsal vertebrae . . . Ibid. |
| 73 | <i>Eucrinus moniliformis</i> . . . Ibid. | 115, 116 | Lumbar vertebrae. Ibid. |
| 74 | <i>Cypræacassis rufa</i> . Stutchbury | 117 | The fifth lumbar vertebra. Ibid. |

- | Fig. | Fig. |
|--|--|
| 118, 119, 120 | 165 |
| Different views of the sacrum . . . South | The anterior extremity of the sloth . . . [Agassiz |
| 121 | 166 |
| The front view of the spinal column . . . Ibid. | Ditto of the turtle . . . Ibid. |
| 122 | 167 |
| The back view of ditto. Ibid. | Ditto of the mole . . . Ibid. |
| 123 | 168 |
| The lateral view of ditto. Ibid. | Ditto of a fish . . . Ibid. |
| 124 | 169 |
| The thorax . . . Ibid. | The skeleton of the camel. [Edwards |
| 125, 126 | 170 |
| Views of the male and female pelvis . . . Ibid. | The fresh-water polyp (<i>Hydra viridis</i>) . . . Ibid. |
| 127, 128 | 171 |
| The ossa innominata. Ibid. | <i>Leucophrys patula</i> . Ehrenberg |
| 129, 130 | 172 |
| The outlet of the pelvis [Ibid. | <i>Eosphora najas</i> . . . Ibid. |
| 131 | 173 |
| The acetabulum . . . Ibid. | A vertical section of <i>Rhizostoma Cuvieri</i> . . . Eysenhardt |
| 132 | 174 |
| The position of the pelvis, the axis . . . Ibid. | Anatomy of the sea urchin, <i>Echinus esculentus</i> . Delle Chiaje |
| 133, 134 | 175 |
| The anterior and posterior view of the femur. Ibid. | <i>Plumatella repens</i> . Edwards |
| 137 | 176 |
| The tibia, fibula and patella. [Ibid. | The anatomy of the common oyster (<i>Ostrea edulis</i>) . . . Poli |
| 138 | 177 |
| The tarsus, metatarsus and toes . . . Ibid. | The anatomy of the sea-hare (<i>Aplysia Camelus</i>) . . . Cuvier |
| 139 | 178 |
| Tibio-tarsal articulation. Ibid. | The anatomy of the leech (<i>Hirudo medicinalis</i>) . . . Carus |
| 140, 141 | 179 |
| The two rows of tarsal bones . . . Ibid. | The digestive organs of a beetle . . . Edwards |
| 142 | 180 |
| The metatarsus. . . Ibid. | The thoracic and abdominal viscera of a monkey . . . Ibid. |
| 143 | 181, 182 |
| The toes . . . Ibid. | The gastric glands from the stomach of man. Wagner |
| 144 | 183 |
| The scapular arch. . . Ibid. | Magnified diagram of these glands . . . Ibid. |
| 145, 146, 147 | 184 |
| Different views of the scapula . . . Ibid. | Other forms of glands of this class . . . Ibid. |
| 148 | 185 |
| The clavicle . . . Ibid. | Stomach of the plover (<i>Vanelus cristatus</i>). . . Ibid. |
| 149, 150 | 186, 187, 188 |
| Front and back view of the humerus . . . Ibid. | Gastric glands of birds . . . Ibid. |
| 151, 152 | 189 |
| The condyles of ditto. [Ibid. | The chyliiferous vessels and glands . . . Edwards |
| 153 | 190 |
| The radius and ulna. Ibid. | The jaws of an urchin (<i>Echinarachmus parma</i>). Agassiz |
| 154 | 191 |
| The carpus, metacarpus and phalanges . . . Ibid. | The jaws of an urchin (<i>Echinus granulatus</i>) . . . Ibid. |
| 155, 156 | 192 |
| The two rows of carpal bones . . . Ibid. | The jaws of a cuttle fish. Ibid. |
| 157, 158 | 193, 194 |
| The upper and lower surfaces of the carpal bones Ibid. | The dental organs of <i>Nerita</i> and <i>Patella</i> . . . Wright |
| 158* | 195 |
| The metacarpus . . . Ibid. | The anatomy of the mouth of a beetle . . . Edwards |
| 159 | 196 |
| The phalanges of the thumb and fingers . . . Ibid. | Ditto of the bee . . . Ibid. |
| 160 | 197 |
| The anterior extremity of the stag . . . Agassiz | Ditto of the bug . . . Ibid. |
| 161 | 198 |
| Ditto of the lion . . . Ibid. | Ditto lancets of ditto . . . Ibid. |
| 162 | |
| Ditto of the whale . . . Ibid. | |
| 163 | |
| Ditto of the bat . . . Ibid. | |
| 164 | |
| Ditto of the bird . . . Ibid. | |

- | Fig. | Fig. |
|---|--|
| 199 The anatomy of the mouth of the butterfly . . . Edwards | 224 Capillary vessels of the intestinal villus of a hare . . . Wagner |
| 200 The jaws of the snapping turtle (<i>Emysaurus serpentina</i>).
[Agassiz | 225 Circulation of the blood in the inter-digital membrane of the hind foot of a frog, magnified three diameters . . . Ibid. |
| 201 The head of a whale, shewing the whale-bone . . . Ibid. | 226 The same, magnified forty-five diameters . . . Ibid. |
| 202 The head of an ant-eater.
[Ibid. | 227 The same, magnified one hundred and ten diameters. Ibid. |
| 203 The head of an alligator. Ibid. | 228 A venous branch, magnified three hundred and fifty times. Ibid. |
| 204 The head of a skate-fish (<i>Myliobatis</i>), shewing palate teeth.
[Ibid. | 229 View in outline of a vein, magnified six hundred times. Ibid. |
| 205 The skull of the horse. | 230 A portion of the lung of a living triton, drawn under the microscope, magnified one hundred and fifty times . . . Ibid. |
| 206 The skull of a squirrel. | 231 Capillary circulation in the lung . . . Ibid. |
| 207 The skull of a tiger. | 232 The anatomy of the <i>Holothuria tubulosa</i> . . . Delle Chiaje |
| 208 Globules of the blood of man.
[Wagner | 233 The branchiæ of the <i>Arenicola</i> .
[Edwards |
| 209 Ditto of the common goat (<i>Capra domestica</i>) . . . Ibid. | 234 The respiratory apparatus of the <i>Nepa cinerea</i> . Leon Dufour |
| 210 Blood and lymph globules of the pigeon (<i>Columba domestica</i>) . . . Ibid. | 235 Lungs, heart, and principal blood-vessels of man . . . Edwards |
| 211 Blood globules of the <i>Proteus anguinus</i> . . . Ibid. | 236 Lung of the triton, magnified.
[Wagner |
| 212 Blood and lymph globules of the <i>Triton cristatus</i> . . . Ibid. | 237 Lung of the triton, injected. Ibid. |
| 213 Blood globules of the <i>Rana esculenta</i> . . . Ibid. | 238 Lung of the frog, magnified. Ibid. |
| 214 Blood and lymph globules of the <i>Cobitis fossilis</i> . . . Ibid. | 239 Lung of the tortoise ditto. Ibid. |
| 215 Blood globules of the <i>Ammocetes branchialis</i> . . . Ibid. | 240 Lung of the serpent ditto. Ibid. |
| 216 Vein laid open to shew the valves . . . Cloquet | 241 Terminal vesicles of the human lung . . . Ibid. |
| 217 Diagram of the course of the blood in mammals and birds.
[Edwards | 242 Portion of the lung of a hog. Ibid. |
| 218 Diagram of an ideal section of the human heart . . . Ibid. | 243 Portion of the human lung magnified two hundred times. Ibid. |
| 219 Diagram of the circulation in reptiles. . . . Ibid. | 244 Rudiment of the lung from the embryo of a fowl . . . Ibid. |
| 220 Diagram of the circulation in fishes Ibid. | 245 Rudimentary lung from the embryo of a sheep . . . Müller |
| 221 The heart and vascular system of the <i>Doris</i> . . . Ibid. | 246 Termination of the bronchi of the embryo of a hog. Rathke |
| 222 The vascular system of the lobster Ibid. | 247 Diagram of experiment to illustrate Endosmose and Exosmose. |
| 223 The organs of circulation in a nenopterous insect . . . Ibid. | 248 Glands from the auditory passage of the human subject.
[Wagner |

- | | | | |
|----------|---|---------|--|
| Fig. | | Fig. | |
| 249 | Sudoriparous glands from the palm of the hand. Wagner | 282 | The ova of a fresh-water polyp (<i>Hydra</i>) . . . Agassiz |
| 250 | Do. do. . . Gurlt | 283 | The egg of an insect — the snow-flea (<i>Podurella</i>). Ibid. |
| 251 | Thin layer of the scalp magnified . . . Ibid. | 284 | The primary ova of a bird magnified . . . Wagner |
| 252 | The salivary glands of insects [Ramdohr and Succow | 285 | The eggs of the <i>Pyrula</i> . Agassiz |
| 253 | Glands of insects . . . Ibid. | 286 | The ovarian sacs of a <i>Monoculus</i> [Ibid. |
| 254 | Do. do. . . Ibid. | 287 | Ideal section of a fowl's egg. [Baer |
| 255 | Harderian gland of the <i>Pelecanus onocrotalus</i> . Wagner | 288 | Cell layer of the germ. Agassiz |
| 256 | Cowper's gland of the hedgehog (<i>Erinaceus</i>) . . . Ibid. | 289 | Separation of the cell layer into three laminæ . . . Ibid. |
| 257 | Parotid gland of a new-born infant . . . Weber | 290 | Embryo of a crab, showing the incipient rings . . . Ibid. |
| 258 | Kidney and supra-renal capsule of an infant . . . Wagner | 291 | Embryo of a vertebrate animal, showing the dorsal furrow. Ibid. |
| 259 | Portions of do. magnified. Ibid. | 292—294 | Sections of the embryo, showing the formation of the dorsal canal . . . Ibid. |
| 260 | Do. magnified 60 diameters. Ibid. | 295 | Section showing the position of the embryo of a vertebrate animal in its relation to the yolk . . . Ibid. |
| 261 | Termination of one of the tubuli magnified 250 times . . . Ibid. | 296 | Section showing the same in an articulate animal . . . Ibid. |
| 262 | Kidney of the porpoise (<i>Delphinus phocæna</i>) . . . Muller | 297—308 | Sections showing the successive stages of development of the white-fish magnified. [Ibid. |
| 263 | Lobules of the human liver. [Wagner | 309 | The young white-fish just escaped from the egg, with the yolk not yet fully taken in. Ibid. |
| 264 | A branch of the hepatic vein and liver lobules . . . Ibid. | 310—311 | Sections of the embryo of a bird, showing the formation of the allantois: <i>e</i> , embryo; <i>x, x</i> , membrane arising to form the amnios; <i>a</i> , the allantois; <i>y</i> , the yolk. |
| 265 | Superficial lobules of the liver. [Kiernan | 312 | The same fully developed; the allantois (<i>a</i>) is further developed and bent upwards; the upper part of the yolk (<i>d, d</i>) is nearly separated from the yolk sphere, and is to become the intestine; the heart (<i>h</i>) is already distinct and connected by threads with the blood layer of the body. |
| 266 | The intra-lobular plexus of biliary vessels . . . Ibid. | | |
| 267 | A transverse section of the lobes of the liver . . . Ibid. | | |
| 268 | A view, magnified 40 times, of the liver of a newt. Wagner | | |
| 269—272 | Show the development of the liver . . . Muller | | |
| 273 | Ramifications of the bronchi from the embryonic <i>Falco tinnunculus</i> . . . Wagner | | |
| 274, 276 | Rudimentary form of the parotid gland . . . Müller | | |
| 277 | Lobules of the parotid gland. Ibid. | | |
| 278 | Development of the liver in the <i>Falco tinnunculus</i> Wagner | | |
| 279, | 280 Malpighian bodies from the kidney of the <i>Triton</i> and <i>Strix aluco</i> . . . Huschke | | |
| 281 | The egg of a skate-fish (<i>Myliobatis</i>). . . . Agassiz | | |

- Fig. 313, 314 Sections of the egg of a mammal; *v*, the thick vitelline membrane or chorion; *y*, the yolk; *s*, the germinative spot; *g*, the germinative vesicle; *k*, the empty space between the vitelline sphere and chorion.
- 315 Shows the first indication of the germ dividing into layers, the serous (*s*) and the mucous (*m*).
- 316 The mucous layer (*m*) expands over nearly half the yolk, and becomes covered with many little fringes.
- 317 The embryo (*c*) is seen surrounded by the amnios (*b*), and covered by the large allantois (*a*); *p*, *e*, fringes of the chorion; *p*, *m*, fringes of the matrix.
- 318 One of the chalazæ of a jackdaw's egg pulled straight. [Wagner]
- 319 Vitellus of a hen's egg. Ibid.
- 320 The yolk of a jackdaw's egg. [Ibid.]
- 321 Section of a yolk almost ripe included in its calyx. Ibid.
- 322 The ovary of a fowl. Ibid.
- 323, 324 The vitellus twelve hours after incubation. Ibid.
- 325 Magnified view of the blastoderma. Ibid.
- 326 Ideal sections. Bæer
- 327 Yolk after eighteen hours' incubation. Wagner
- 328 The pellucid area magnified. [Ibid.]
- 329 Ideal sections of 327, 328. Ibid.
- 330 Yolk after twenty-four hours' incubation. Ibid.
- 331 Magnified view of the pellucid area. Ibid.
- 332 Ideal sections of 329—331. [Ibid.]
- 333 Yolk of the natural size after thirty-six hours' incubation. [Ibid.]
- Fig. 334 Magnified view of the pellucid area of the vitellus Wagner
- 335 Ideal sections of the embryo. [Ibid.]
- 336 Incubated vitellus of the jackdaw's egg. Ibid.
- 337 Anterior extremity of an embryo. Ibid.
- 338 Ideal section of an embryo. [Ibid.]
- 339—342 Views of embryos magnified. [Ibid.]
- 343 Ideal section of ditto. Ibid.
- 344, 345 Outlines of embryos of the fowl. Ibid.
- 346 View of the vitellus magnified. [Ibid.]
- 347 View of the embryo of the yolk. Ibid.
- 348 Yolk of the hen's egg. Ibid.
- 349—354 Views of embryos in different stages of development. [Ibid.]
- 355 Embryo of a lizard (*Lacerta agilis*). Ibid.
- 356 Vorticella, showing its reproduction by buds. Agassiz
- 357 Vorticella, showing its reproduction by division. Ibid.
- 358 Polyps, showing the same phenomenon. Ibid.
- 359 A chain of *Salpa*. Ibid.
- 360 An individual *Salpa*. Ibid.
- 361 Cercaria, or early form of the *Distoma*. Steenstrup
- 362 *Distoma*, with its two suckers. [Ibid.]
- 363 Nurse of the *Cercaria*. Ibid.
- 364 The same magnified, showing the included young. Ibid.
- 365 Grand nurses of the *Cercaria*, including the young nurses. [Ibid.]
- 366 Stages of development of the Acalephæ (*Medusa*): *a*, the embryo in its first stage, much magnified; *b*, summit, showing the mouth; *c*, *f*, *g*, tentacles shooting forth; *c*, embryo adhering, and forming *b*

- | | |
|---|---|
| <p>Fig.</p> <p>a pedicle; <i>h, i</i>, separation into segments; <i>d</i>, a segment become free; <i>k</i>, form of the adult. [Sars</p> <p>367 Portion of a horny sheathed polyp (<i>Campanularia</i>): <i>a</i>, cup, which bears tentaculæ; <i>b</i>, the female cell, containing eggs; <i>c</i>, the cells in which the young are nursed, and from which they issue. Steenstrup</p> <p>368 The young of the same, with its ciliated margin, magnified.</p> <p>369 Transformations of the canker worm (<i>Geometra vernalis</i>): <i>a</i>, the canker worm; <i>b</i>, its crýsalis; <i>c</i>, female moth; <i>d</i>, male moth. Agassiz</p> <p>370 Metamorphoses of the Duck-barnacle (<i>Anatifa</i>): <i>a</i>, eggs magnified; <i>b</i>, the animal as it escapes from the egg; <i>c</i>, the stem and eye appearing, and the shell enclosing them; <i>d</i>, animal removed from the shell, and further magnified; <i>e, f</i>, the mature barnacle affixed by its pedicle. Ibid.</p> <p>371 Metamorphoses of a star-fish (<i>Echinaster sanguinolentus</i>), showing the changes of the yolk, <i>e</i>; the formation of the pedicle, <i>p</i>; and the gradual change into the pentagonal and rayed form. Ibid.</p> <p>372 <i>Comatula</i>, a West Indian species, in its early stage attached to a stem. Agassiz</p> | <p>Fig.</p> <p>373 The same. detached and swimming free. Ibid.</p> <p>374 Longitudinal section of the sturgeon, to show its cartilaginous vertebral column. Ibid.</p> <p>375 <i>Amphioxus</i>, natural size, showing its imperfect organization. Ibid.</p> <p>376 Section of the earth's crust, showing the relative position of the rocks composing it. [Agassiz</p> <p>377 Fossils of the Palæozoic age. [Murchison.</p> <p>378 <i>Homalonotus delphinocephalus</i>. [König</p> <p>379 <i>Pterichthys</i>. Miller</p> <p>380 <i>Coccosteus cuspidatus</i>. Ibid.</p> <p>381 The Flora of the coal period. [Richardson</p> <p>382 Foot-prints of birds. Ibid.</p> <p>383 <i>Plesiosaurus rugosus</i>. Owen</p> <p>384 <i>Pterodactylus crassirostris</i>. [Goldfuss</p> <p>385 Jaw of the <i>Thylacotherium</i>, magnified. Richardson</p> <p>386 Fossils, shells, and <i>Hemicidaris</i> from the oolitic rocks. [Phillips</p> <p>387, 388 Fossil shells from the greensand strata of the Isle of Wight. Mantell</p> <p>389 Fossil shells, and Mammalian remains, from the locustrine tertiary strata of the Isle of Wight, to illustrate the fauna of that period. Ibid.</p> <p>390 The Megatherium. [Pander and D'Alton</p> |
|---|---|

INTRODUCTION.

EVERY art and science has a language of technical terms peculiar to itself. With those terms the student must make himself familiarly acquainted at the outset; and first of all, he will desire to know the names of the objects about which he is to be engaged.

The names of objects in Natural History are double, that is to say, they are composed of two terms. Thus, we speak of the white-bear, the black-bear, the hen-hawk, the sparrow-hawk; or, in strictly scientific terms, we have *Felis leo*, the lion; *Felis tigris*, the tiger; *Felis catus*, the cat; *Canis lupus*, the wolf; *Canis vulpes*, the fox; *Canis familiaris*, the dog, &c. They are always in the Latin form, and consequently the adjective name is placed last. The first is called the *generic* name; the second is called the *trivial*, or *specific* name.

These two terms are inseparably associated with every object of which we treat. It is very important, therefore, to have a clear idea of what is meant by the terms *genus* and *species*; and although the most common of all others, they are not the easiest to be clearly understood. The Genus is founded upon some of the minor peculiarities of anatomical structure, such as the number, disposition, or proportions of the teeth, claws, fins, &c., and usually includes several kinds. Thus, the lion, tiger, leopard, cat, &c., agree in the structure of their feet, claws, and teeth, and they belong to the genus *Felis*; while the dog, fox, jackall, wolf, &c., have another and a different peculiarity of the feet, claws, and teeth, and are arranged in the genus *Canis*.

The *species* is founded upon less important distinctions, such as colour, size, proportions, sculpture, &c. Thus we have different kinds, or species, of duck, different species of squirrel, different species of monkey, &c., varying from each

other in some trivial circumstance, while those of each group agree in all their general structure. The specific name is the lowest term to which we descend, if we except certain peculiarities, generally induced by some modification of native habits, such as are seen in domestic animals. These are called *varieties*, and seldom endure beyond the causes which occasion them.

Several genera which have certain traits in common are combined to form a *family*. Thus, the alewives, herrings, shad, &c., form a family called *CLUPEIDÆ*, among fishes; the crows, black-birds, jays, &c., form the family *CORVIDÆ*, among birds. Families are combined to form *orders*, and orders form *classes*, and finally, classes are combined to form the four primary divisions of the animal kingdom, namely, the *departments*.

For each of these groups, whether larger or smaller, we involuntarily picture in our minds an image, made up of the traits which characterize the group. This ideal image is called a *TYPE*, a term which there will be frequent occasion to employ, in our general remarks on the animal kingdom. This image may correspond to some one member of the group; but it is rare that any one species embodies all our ideas of the class, family, or genus to which it belongs. Thus, we have a general idea of a bird; but this idea does not correspond to any particular bird, or any particular character of a bird. It is not precisely an ostrich, an owl, a hen, or a sparrow; it is not because it has wings, or feathers, or two legs; or because it has the power of flight, or builds nests. Any, or all of these characters would not fully represent our idea of a bird; and yet every one has a distinct ideal notion of a bird, a fish, a quadruped, &c. It is common, however, to speak of the animal which embodies most fully the characters of a group, as the type of that group. Thus, we might perhaps regard an eagle as the type of a bird, the duck as the type of a swimming-bird, and the mallard as the type of a duck.

As we must necessarily make frequent allusions to animals, with reference to their systematic arrangement, it seems requisite to give a sketch of their classification in as popular terms as may be, before entering fully upon that subject, and with particular reference to the diagram fronting the title-page.

The Animal Kingdom consists of four great divisions which we call DEPARTMENTS, namely,

- I. The department of Vertebrata.
- II. The department of Articulata.
- III. The department of Mollusca.
- IV. The department of Radiata.

I. The department of VERTEBRATA includes all animals which have an internal skeleton, with a back-bone for its axis. It is divided into four classes.

1. Mammals (animals which nurse their young).
2. Birds.
3. Reptiles.
4. Fishes.

The class of MAMMALS is subdivided into three orders.

- a. Beasts of prey (*Carnivora*).
- b. Those which feed on vegetables (*Herbivora*).
- c. Animals of the whale kind (*Cetaceans*).

The class of BIRDS is divided into four orders.

- a. Birds of prey (*Incessores*).
- b. Climbers (*Scansores*).
- c. Waders (*Grallatores*).
- d. Swimmers (*Natatores*).

The class of REPTILES is divided into five orders.

- a. Large reptiles with hollow teeth, most of which are now extinct (*Rhizodonts*).
- b. Lizards (*Lacertans*).
- c. Snakes (*Ophidians*).
- d. Turtles (*Chelonians*).
- e. Frogs (*Batrachians*).

The class of FISHES is divided into four orders:

- a. Those with enamelled scales, like the gar-pike *Lepidosteus* (*Ganoids*).
- b. Those with the skin like shagreen, as the sharks and skates (*Placoids*).
- c. Those which have the edge of the scales toothed, and usually with some bony rays to the fins, as the perch (*Ctenoids*).
- d. Those whose scales are entire, and whose fin rays are soft, like the salmon (*Cycloids*).

II. Department of ARTICULATA. Animals whose body is composed of rings or joints. It embraces three classes.

1. Insects.
2. Crustaceans, like the crab, lobster, &c.
3. Worms.

The class of INSECTS includes three orders.

- a. Those which have jaws for dividing their food (*Manducata*), fig. 195.
- b. Those with a trunk for sucking fluids, like the butterfly (*Suctoria*), fig. 199.
- c. Those destitute of wings, like fleas (*Aptera*).

The class of CRUSTACEANS may be divided as follows:—

- a. Those furnished with a shield, like the crab and lobster (*Malacostraca*).
- b. Such as are not thus protected (*Entomostraca*).
- c. An extinct race, intermediate between these two (*Trilobites*), fig. 378.

The class of WORMS comprises three orders:

- a. Those which have thread-like gills about the head (*Tubulibranchiata*).
- b. Those whose gills are placed along the sides (*Dorsibranchiata*).
- c. Those which have no exterior gills, like the earth-worm (*Abranchiata*).

III. The department of MOLLUSCA is divided into three classes, namely:

1. Those which have arms about the head, like the cuttle-fish (*Cephalopoda*).
2. Those which creep on a flattened disc or foot, like snails (*Gasteropoda*).
3. Those which have no distinct head, and are enclosed in a bivalve shell, like the clams (*Acephala*).

The CEPHALOPODA may be divided into—

- a. The cuttle-fishes, properly so called (*Teuthideans*).
- b. Those having a shell, divided by sinuous partitions into numerous chambers (*Ammonites*).
- c. Those having a chambered shell with simple partitions (*Nautilus*).

The GASTEROPODA contains three orders :

- a. The land-snails which breathe air (*Pulmonata*).
- b. The aquatic snails which breathe water (*Branchifera*).
- c. Those which have wing-like appendages about the head, for swimming (*Pteropoda*).

The class of ACEPHALA contains three orders :

- a. Those having shells of two valves (bivalves), like the clam (*Lamellibranchiata*).
- b. Those having two unequal valves, and furnished with peculiar arms (*Brachiopoda*).
- c. Those living in chains or clusters, like the *Salpa*, or upon plant-like stems, like the *Flustra*.—*Bryozoa*.

IV. The department of RADIATA is divided into three classes :

1. Sea-urchins, bearing spines upon the surface (*Echinodermata*).
2. Jelly-fishes (*Acalepha*).
3. Polyps, fixed like plants, and with a series of flexible arms around the mouth.

The ECHINODERMS are divided into four orders :

- a. Sea-slugs, like the biche-le-mar (*Holothurians*).
- b. Sea-urchins (*Echini*), fig. 71.
- c. Free star-fishes (*Asteriadae*), fig. 36.
- d. Star-fishes mostly attached by a stem (*Crinoidae*), figs. 69, 70.

The ACALEPHA includes the following orders :

- a. The Medusæ, or common jelly-fishes (*Discophori*), fig. 173.
- b. Those provided with aerial vesicles (*Siphonophori*).
- c. Those furnished with vibrating hairs, by which they move (*Ctenophori*).

The class of POLYPS includes three orders :

- a. Fresh-water polyps, and similar marine forms (*Hydroids*), fig. 170.
- b. Marine polyps, like the sea-anemone and coral-polyp (*Actinoids*).
- c. A still lower form, allied to the mollusca by their shell (*Rhizopods*).

In addition to these, there are numberless kinds of microscopic animalcules, commonly called infusory animals (*Infusoria*), from their being found specially abundant in water infused with vegetable matter. Indeed, a great many that were formerly supposed to be animals are now known to be vegetables. Others are ascertained to be crabs, mollusks, worms, &c. in their earliest stages of development. In general, however, they are exceedingly minute, exhibiting the simplest forms of animal life, and are now grouped together, under the title of Protozoa. But, as they are still very imperfectly understood, notwithstanding the beautiful researches already published on this subject, and as most of them are likely to be finally distributed among vegetables and various classes of the animal kingdom, we have not assigned any special place to them.

PHYSIOLOGICAL ZOOLOGY.

CHAPTER FIRST.

THE SPHERE AND FUNDAMENTAL PRINCIPLES OF ZOOLOGY.

§ 1. ZOOLOGY is that department of Natural History which relates to Animals.

§ 2. The enumeration and naming of the animals which are found on the globe, the description of their forms, and the investigation of their habits and modes of life, are the principal, but not the only objects of this science. Animals are worthy of our regard not only in respect to the variety and elegance of their forms, and their adaptation to the supply of our wants; but the Animal Kingdom, as a whole, has also a still higher signification. It is the exhibition of the divine thought, as it is carried out in one department of that grand whole which we call Nature; and considered as such, it teaches us the most important lessons.

§ 3. Man, in virtue of his twofold constitution, the spiritual and the material, is qualified to comprehend Nature. Having been made in the spiritual image of God, he is competent to rise to the conception of His plan and purpose in the works of Creation. Having also a material body, like that of animals, he is prepared to understand the mechanism of organs, and to appreciate the necessities of matter, as well as the influence which it exerts over the intellectual element, throughout the whole domain of Nature.

§ 4. The spirit and preparation we bring to the study of Nature, is not a matter of indifference. When we would study with profit a work of literature, we first endeavour to make ourselves acquainted with the genius of the author;

and in order to know what end he had in view, we must have regard to his previous labours, and to the circumstances under which the work was executed. Without this, although we may perhaps enjoy the perfection of the whole, and admire the beauty of its details, yet the spirit which pervades it will escape us, and many passages may even remain unintelligible.

§ 5. So, in the study of Nature, we may be astonished at the infinite variety of her products, and may even study some portion of her works with enthusiasm, and nevertheless remain strangers to the spirit of the whole, ignorant of the plan on which it is based; and may fail to acquire a proper conception of the varied affinities which combine beings together, so as to make of them that vast picture, in which each animal, each plant, each group, each class, has its place, and from which nothing could be removed without destroying the proper meaning of the whole.

§ 6. Besides the beings which inhabit the earth at the present time, this picture also embraces the extinct races which are now known to us by their fossil remains only. These are of very great importance, since they furnish us with the means of ascertaining the changes and modifications which the Animal Kingdom has undergone in the successive creations which have taken place since the first appearance of living beings.

§ 7. It is but a short time since it was not difficult for a man to possess himself of the whole domain of positive knowledge in Zoology. A century ago, the number of known animals did not exceed 8000; that is to say, in the whole Animal Kingdom, fewer species were then known than are now contained in many private collections of certain families of insects alone. At the present day, the number of living species which have been satisfactorily made out and described, is more than 50,000.* The fossils already described exceed

* The number of vertebrate animals may be estimated at 20,000. About 1500 species of mammals are pretty precisely known, and the number may probably be carried to about 2000.

The number of Birds well known is 4 or 5000 species, and the probable number is 6000.

The Reptiles, like the Mammals, number about 1500 described species, and will probably reach the number of 2000.

The Fishes are more numerous; there are from 5 to 6000 species in the museums of Europe, and the number may probably amount to 8 or 10,000.

The number of Mollusks already in collections, probably reaches 8 or

6000 species; and if we consider that wherever any one stratum of the earth has been well explored, the number of species discovered has not fallen below that of the living species which now inhabit any particular locality of equal extent, and then bear in mind that there is a great number of geological strata, we may anticipate the day when the ascertained fossil species will far exceed the living species.²

§ 8. These numbers, far from discouraging, should, on the contrary, encourage those who study Natural History. Each new species is, in some respects, a radiating point which throws additional light on all around it; so that as the picture is enlarged, it at the same time becomes more intelligible to those who are competent to seize its prominent traits.

§ 9. To give a detailed account of each and all of these animals, and to show their relations to each other, is the task of the Naturalist. The number and extent of the volumes already published upon the various departments of Natural History show, that only a mere outline of so vast a domain could be given in an elementary work like the present, and that none but those who make it their special study can be expected to survey its individual parts.

10,000. There are collections of marine shells, bivalve and univalve, which amount to 5 or 6000; and collections of land and fluviatile shells, which count as many as 2000. The total number of mollusks would therefore probably exceed 15,000 species.

Among the articulated animals it is difficult to estimate the number of species. There are collections of coleopterous insects which number 20 to 25,000 species; and it is quite probable, that by uniting the principal collections of insects, 60 or 80,000 species might now be counted; for the whole department of articulata, comprising the crustacea, the cirrhipeda, the insects, the red-blooded worms, the intestinal worms, and the infusoria, as far as they belong to this department, the number would already amount to 100,000; and we might safely compute the probable number of species actually existing at double that sum.

Add to these about 10,000 for radiata, echini, star-fishes, medusæ, and polypi, and we have about 250,000 species of living animals; and supposing the number of fossil species only to equal them, we have, at a very moderate computation, half a million of species.

² In a separate work, entitled "*Nomenclator Zoologicus*," by L. Agassiz, the principles of nomenclature are discussed, and a list of the names of genera and families proposed by authors is given. To this work those are referred who may desire to become more familiar with nomenclature, and to know in detail the genera and families in each class of the Animal Kingdom.

§ 10. Every well-educated person, however, is expected to have a general acquaintance with the great natural phenomena constantly displayed before his eyes. A general knowledge of man and the subordinate animals, embracing their structure, races, habits, distribution, mutual relations, &c., is calculated not only to conduce essentially to our happiness, but is a study which it would be inexcusable to neglect. This general knowledge, which is given by the science of Zoology, it is the purpose of the present work to afford.

§ 11. A sketch of this nature should render prominent the more general features of animal life, and delineate the arrangement of the species according to their most natural relations and their rank in the scale of being; and thus give a panorama, as it were, of the entire Animal Kingdom. To accomplish this, we are at once involved in the question, what is it that gives an animal precedence in rank?

§ 12. In one sense, all animals are equally perfect. Each species has its definite sphere of action, whether more or less extended,—its own peculiar office in the economy of nature; and is perfectly adapted to fulfil all the purposes of its creation, beyond the possibility of improvement. In this sense, every animal is perfect. But there is a wide difference among them, in respect to their organization. In some it is very simple, and very limited in its operation; in others, extremely complicated, and capable of exercising a great variety of functions.

§ 13. In this physiological point of view, an animal may be said to be more perfect in proportion as its relations with the external world are more varied; in other words, the more numerous its functions are. Thus, a quadruped, or a bird, which has the five senses fully developed, and which has, moreover, the faculty of readily transporting itself from place to place, is more perfect than a snail, whose senses are very obtuse, and whose motion is very sluggish.

§ 14. In like manner, each of the organs, when separately considered, is found to have every degree of complication, and, consequently, every degree of nicety in the performance of its function. Thus, the eye-spots of the star-fish and jelly-fish are probably endowed with the faculty of perceiving light, without the power of distinguishing objects. The keen eye of the bird, on the contrary, discerns minute objects

at a great distance, and when compared with the eye of a fly, is found to be not only more complicated, but constructed on an entirely different plan. It is the same with every other organ.

§ 15. We understand the faculties of animals, and appreciate their value, just in proportion as we become acquainted with the instruments which execute them. The study of the functions or uses of organs therefore requires an examination of their structure; Anatomy and Physiology must never be disjoined, and ought to precede the systematic distribution of animals into classes, families, genera, and species.

§ 16. In this general view of organization, we must ever bear in mind the necessity of carefully distinguishing between *affinities* and *analogies*, a fundamental principle recognized even by Aristotle, the founder of scientific Zoology. *Affinity* or *homology* is the relation between organs or parts of the body which are constructed on the same plan, however much they vary in form, or serve for different uses. *Analogy*, on the contrary, indicates the similarity of purposes or functions performed by organs of different structure.

§ 17. Thus, there is an analogy between the wing of a bird and that of a butterfly, since both of them serve for flight. But there is no affinity between them, since, as we shall hereafter see, they differ totally in their anatomical relations. On the other hand, there is an affinity between the bird's wing and the hand of a monkey, since, although they serve for different purposes, the one for climbing, and the other for flight, yet they are constructed on the same plan. Accordingly, the bird is more nearly allied to the monkey than to the butterfly, though it has the faculty of flight in common with the latter. Affinities, and not analogies, therefore, must guide us in the arrangement of animals.

§ 18. Our investigations should not be limited to adult animals, but should also be directed to the changes which they undergo during the whole course of their development. Otherwise, we shall be liable to exaggerate the importance of certain peculiarities of structure which have a predominant character in the full-grown animal, but which are shaded off, and vanish, as we revert to the earlier periods of life.

§ 19. Thus, for example, by regarding only adult individuals, we might be induced to divide all animals into two

groups, according to their mode of respiration; uniting in one group all those which breathe by gills, and, in the other, those which breathe by lungs; but this distinction loses its importance, when we consider that various animals, as, for example, frogs, which respire by lungs in the adult state, have only gills when young: hence it is evident that the respiratory organs cannot be taken as a satisfactory basis for fundamental classification. They are, as we shall see, subordinate to a more important organism, namely, the nervous system.

§ 20. Again, we have a means of appreciating the relative grade of animals by the comparative study of their development. It is evident that the caterpillar, in becoming a butterfly, passes from a lower to a higher state; clearly, therefore, animals resembling the caterpillar, as, for instance, worms, occupy a lower rank than insects. There is no animal which does not undergo a series of changes similar to those of the caterpillar or the chicken; only, in many of them, the most important ones occur before birth, during what is called the embryonic period.

§ 21. The life of the chicken has not just commenced when it issues from the egg; for, if we break the shell some days previous to the time of hatching, we find in it a living animal, which, although imperfect, is nevertheless a chicken; it has been developed from a hen's egg, and we know that, should it continue to live, it will infallibly display all the characteristics of the parent bird. Now, if there existed in nature an adult bird, as imperfectly organized as the chicken on the day before it was hatched, we should assign to it an inferior rank.

§ 22. In studying the embryonic states of the mollusks or worms, we observe in them points of resemblance to many animals of a lower grade, to which they afterwards become entirely dissimilar; for example, the myriads of minute aquatic animals embraced under the name of Infusoria, whose organization is generally very simple, remind us of the embryonic forms of other animals. We shall have occasion to show that the Infusoria are not to be considered as a distinct class of animals, but that among them there are found members of all the lower classes of animals, as mollusks, crustaceans, polyps, and even vegetable organisms.³

³ And are grouped in the families *Desmidiæ* and *Diatomaceæ*.—ED.

§ 23. Not less striking are the relations that exist between animals and the regions they inhabit. Every animal has its home. Animals of the cold regions are not the same as those of temperate climates; and these latter, in their turn, differ from those of tropical regions. Certainly, no one will maintain it to be the effect of accident that the monkeys, the most perfect of all brute animals, are found only in hot countries; or that it is by chance that the white bear and reindeer inhabit only cold regions.

§ 24. Nor is it by chance that the largest of all animals, of every class, as the whales, the aquatic birds, and the sea-turtles, dwell in the water rather than on the land; and while this element affords freedom of motion to the largest, so is it also the home of the smallest of living things.

§ 25. In the study of zoology we must not confine our researches to animals now in existence. There are buried, in the crust of the earth, the remains of a great number of animals belonging to species which do not exist at the present day; many of these remains present forms so extraordinary, that it is almost impossible to trace their connection with any animals now living. In general, they bear a striking analogy to the embryonic forms of existing species; for example, the curious fossils known under the name of Trilobites (Fig. 378) have a shape so singular, that it might well be doubted to what group of articulated animals they belong; but if we compare them with the embryo crab, we find so remarkable a resemblance, that we hesitate not to refer them to the crustaceans. We shall also see that some of the fishes of ancient epochs present shapes entirely peculiar to themselves (Fig. 379), resembling in a striking manner the embryonic forms of some of our common fishes. A determination of the successive appearance of animals, in the order of *time*, is therefore of much importance in assisting us to determine their relative zoological rank.

§ 26. Besides the distinctions derived from the varied structure of organs, there is another less subject to rigid analysis, but no less decisive, to be drawn from the immaterial principle, with which every animal is endowed. It is this vital principle which determines the constancy of species, from generation to generation, and which is the source of all the varied exhibitions of instinct and intelligence which we see displayed, from

the simple impulse in the polyps to receive the food which is brought within their reach through the higher manifestations, as observed in the cunning fox, the sagacious elephant, the faithful dog, and the exalted intellect of man, which is capable of indefinite expansion.

§ 27. Such are some of the general aspects in which we shall contemplate the animal creation. Two points of view should never be lost sight of, or disconnected, namely, the animal in respect to its own organism, and the animal in its relations to creation as a whole. By adopting too exclusively either of these points of view, we are in danger of falling either into gross materialism, or into a vague pantheism. He who beholds nothing in Nature besides organs and their functions, may persuade himself that the animal is merely a combination of chemical and mechanical actions and reactions, and thus becomes a materialist.

§ 28. On the contrary, he who considers only the manifestations of intelligence and of creative will, without taking into account the means by which they are executed, and the physical laws, by virtue of which all beings preserve their characteristics, will be very likely to confound the Creator with the creature.

§ 29. It is only by a simultaneous contemplation of matter and mind, that Natural History rises to its true character and dignity, and attains its noblest end, namely, the indication throughout the whole of creation of a plan fully matured in the beginning, and invariably pursued; the work of a God infinitely wise, regulating Nature according to the immutable laws which He has himself imposed on her.

CHAPTER SECOND.

GENERAL PROPERTIES OF ORGANIZED BODIES.

SECTION I.

ORGANIZED AND UNORGANIZED BODIES.

§ 30. NATURAL HISTORY, in its broadest sense, embraces the study of all the bodies which compose the crust of the earth, or which are dispersed over its surface.

§ 31. These bodies may be divided into two great groups ; inorganic bodies (minerals and rocks), and living or organic bodies (vegetables and animals). These two groups have nothing in common, save the universal properties of matter, such as weight, colour, &c. They differ at the same time in form, structure, composition, and mode of existence.

§ 32. The distinctive characteristic of inorganic bodies is *rest* ; while that of organic bodies is *independent motion*, LIFE. The rock or the crystal, once formed, never change ; their constituent parts or molecules invariably preserve the position which they have once taken in respect to each other. Organized bodies, on the contrary, are continually in action. The sap circulates in the tree, the blood flows through the animal, and in both there is, besides, the incessant movement of growth, decomposition, and renovation.

§ 33. Their mode of formation is also entirely different. Unorganized bodies are either simple, or made up of elements unlike themselves ; and when a mineral is enlarged, it is simply by the outward addition of particles constituted like itself. Organized bodies are not formed in this manner. They always, and necessarily, are derived from beings similar to themselves ; and once formed, they always increase interstitially by the successive assimilation of new particles derived from various sources.

§ 34. Finally, organized bodies are limited in their duration. Animals and plants are constantly losing some of their parts by decomposition during life, which at length cease to

be supplied, and they die, after having lived their appointed period. Inorganic bodies, on the contrary, contain within themselves no principle of destruction; and unless subjected to some foreign influence, would never change. The limestone and granite of our mountains remain just as they were formed in ancient geological epochs; while numberless generations of plants and animals have lived and perished upon their surface.

SECTION II.

ELEMENTARY STRUCTURE OF ORGANIZED BODIES.

§ 35. THE exercise of the functions of life, which is the essential characteristic of organized bodies (§ 32), requires a degree of flexibility of the organs. This is secured by means of a certain quantity of watery fluid, which penetrates all parts of the body, and forms one of its principal constituents.

§ 36. All living bodies, without exception, are made up of *tissues* so constructed as to be permeable by liquids. There is no part of the body, no organ, however hard and compact it may appear, which has not this peculiar structure. It exists in the bones of animals, as well as in their flesh and fat; in the wood, however solid, as well as in the bark and flowers of plants. It is to this general structure that the term *organism* is now applied. Hence the collective name of *organized beings*,¹ which includes both the animal and the vegetable kingdoms.

§ 37. The vegetable tissues, and most organic structures, when examined by the microscope, in their early states of growth, are found to be composed of hollow vesicles or *cells*. The natural form of the cells is that of a sphere or of an ellipsoid, as may be easily seen in many plants; for example, in the tissue of the house-leek (Fig. 1). The intervals which sometimes separate them from each other are called *intercellular spaces* (*m*). When the cellules are very numerous, and

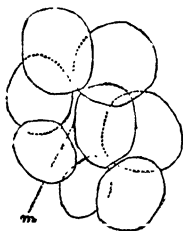

Fig. 1.

* Formerly, animals and plants were said to be *organized* because they are furnished with definite parts, called *organs*, which execute particular functions. Thus, animals have a stomach, a heart, lungs, &c.; plants

crowd each other, their outlines become angular, and the intercellular spaces disappear, as seen in figure 2, which represents the pith of the elder. They then have the form of a honey-comb, whence they have derived their name of cellules.

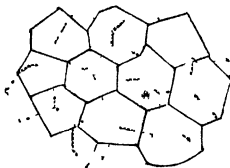

Fig. 2.

§ 38. All organic tissues, whether animal or vegetable, originate from cells. The cell is to the organized body what the primary form of the crystal is to the secondary in minerals. As a general fact, it may be stated that animal cells are smaller than vegetable cells, but they alike contain a central dot or vesicle, called the *nucleus*. Hence such cells are called *nucleated cells* (Figs. 3 and 48). Sometimes the nucleus itself contains a still smaller dot, called *the nucleolus*.

§ 39. The elementary structure of vegetables may be observed in every part of a plant, and its cellular character has been long known. But with the animal tissues there is far greater difficulty. Their variations are so great, and their transformations so diverse, that after the embryonic period, it is sometimes impossible, even by the closest examination, to detect their original cellular structure.

§ 40. Several kinds of tissues have been designated in the animal structure; but their differences are not always well marked, and they pass into each other by insensible shades. Their modifications are still the subject of investigation, and we refer only to the most important distinctions.

§ 41. 1st. The *areolar tissue* consists of a network of delicate fibres intricately interwoven, so as to leave numberless communicating interstices filled with fluid. It is interposed, in layers of various thickness, between all parts of the body, and frequently accompanied by clusters of fat cells. The fibrous and the serous membranes are mere modifications of this tissue.

have leaves, petals, stamens, pistils, roots, &c., all of which are indispensable to the maintenance of life, and the perpetuation of the species. Since the discovery of the fundamental identity of structure of animal and vegetable tissues, a common denomination for this uniformity of texture has been justly preferred; and the existence of vital tissues is now regarded as the basis of organization.

§ 42. 2ndly. The *cartilaginous tissue* is composed of nucleated cells, the intercellular spaces being filled with a more compact substance, called the *hyaline matter*.

§ 43. 3dly. The *osseous* or *bony tissue*, which differs from the cartilaginous tissue, in having the meshes filled with salts of lime, instead of hyaline substance, whence its compact and solid appearance. It contains besides minute, rounded, or star-like points, improperly called bone-corpuscles, which are found to be cavities or canals, sometimes radiated and branched.

§ 44. 4thly. The *muscular tissue*, which forms the flesh of animals, is composed of bundles of parallel fibres, which possess the peculiar property of contracting or shortening themselves, under the influence of the nerves, the muscles under the control of the will, are commonly crossed by very fine lines or wrinkles, but not so in the involuntary muscles. Every one is sufficiently familiar with this tissue, in the form of lean meat.

§ 45. 5thly, the *nervous tissue* is of different kinds. In the nerves proper, it is composed of very delicate fibres, which return back at their extremities, and form loops, as shown in figures 12 and 13, representing the primary fibres of the auditory nerve from the auditory sac of the pike. The same fibrous structure is found in the white portion of the brain. But the grey substance of the brain is composed of very minute granulations, interspersed with clusters of large cells, as seen in fig. 14.

§ 46. The tissues above enumerated differ from each other more widely, in proportion as they are examined in animals of a higher rank. As we descend in the scale of being, the differences become gradually effaced. The soft body of a snail is much more uniform in its composition than the body of a bird, or a quadruped. Indeed, multitudes of animals are known to be composed of nothing but cells in contact with each other. Such is the case with the polyps; yet they contract, secrete, absorb, and reproduce; and most of the Infusoria move freely, by means of little fringes on their surface, arising from modified cells.

§ 47. A no less remarkable uniformity of structure is to be observed in the higher animals, in the earlier periods of their existence, before the body has arrived at its definite form. The head of the adult salmon, for instance, contains not only all the tissues we have mentioned—namely, bone, cartilage,

muscle, nerve, brain, and membranes, but also blood-vessels, glands, pigments, &c. If we examine it during the embryonic state, while it is yet in the egg, we shall find that the whole head is made up of cells which differ merely in their dimensions; those at the top of the head being very small, those surrounding the eye a little larger, and those beneath still larger. It is only at a later period, after still further development, that these cellules become transformed, some of them into bone, others into blood, others into flesh, &c.

§ 48. Again, the growth of the body, the introduction of various tissues, the change of form and structure, proceed in such a manner as to give rise to several cavities, variously combined among themselves, and each containing, at the end of these transformations, peculiar organs, or peculiar systems of organs.

[§ 49. "All organic tissues," says Dr. Schwann, "however different they may be, have one common principle of development as their basis—viz., the formation of cells;* that is to say, nature never unites molecules immediately into a fibre, a tube, and so forth, but she always, in the first instance, forms a round cell, or changes, where it is requisite, cells into the various primary tissues in which they present themselves in the adult state. The formation of the elementary cells takes place, in the main points, in all the tissues according to the same laws; the farther formation and transformation of the cells is different in the different tissues.

[§ 50. "The primary phenomena of cells are the following:—there is first a structureless substance present (cytoblastema), which is either contained in pre-existing cells, or exists on the outside of these. Within this, cell-nuclei generally first arise—round or oval, spherical or flat corpuscles—which usually include one or two small dark points (nuclear-corpuscles). Around these cell-nuclei the cells are produced, and in such wise that they at first closely surround the nuclei. The cells expand by growth, and indeed by intussusception, and the same thing very commonly happens, for a certain period, in regard to the nuclei. When the cells have attained a certain stage of development, the nuclei generally disappear. With reference to the place at which the new cells arise in

* These observations have been confirmed by Wagner, Valentin, Kölliker, Schleiden, Mohl, Nägeli, and others.—ED.

any tissue, the law is, that they constantly appear where the nutritive fluid penetrates the tissue most immediately; therefore it is that the formation of new cells in the unorganized tissues only takes place at the points where they are in contact with the organized matter; in the completely organized tissues, again, where the blood is distributed to the whole of the texture, new cells are produced in the entire thickness of the tissue.

[§ 51. "The process by which the cells evolve themselves into the elementary formations of the individual tissues is very multifarious. The most remarkable differences are the following:—1. The elongation of the cell into a fibre, which probably takes place in consequence of one or more parts of the cell-wall increasing in a greater degree than the others. 2. The division into so many isolated fibres, of a cell elongated in different directions. 3. The blending of several simple or primary cells into one secondary cell.

[§ 52. "CARTILAGE.—The cartilages are distinguished among all the tissues of the human body, by containing the largest quantity of cytoblastema, which is also extremely consistent (fig. 3). The quantity of cytoblastema, however, differs greatly in different cartilages. It is, for instance, much smaller than usual in the branchial cartilages of the larva of the frog (fig. 4). Here the cells may be observed flattening one another as soon as they touch. The first formation, and subsequent growth of cartilage, take place in such wise, that cytoblastema is first produced, in which cells then form, whilst, at the same time, fresh cytoblastema arises, within which, again, cells are evolved as

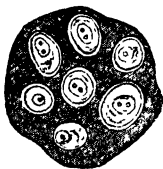

Fig. 3.—Cartilage; the nidus of the os ileum, but as yet without earthy deposit, from the fetus of the sow.

before, and so the process goes on. As the cartilage is without vessels at first, the formation of new cells only proceeds on the superficies of the substance, or, at all events, in its vicinity; in the situation, therefore, where the cartilage is in immediate contact with the nutritive matter. The production and growth of the cells of cartilage are exhibited in figure 4. In the cytoblastema, on the surface of the cartilage at *a*, or between the new-formed cells at *b*, new cell-nuclei are arising. Around

these, cells will by and by be formed, as at *c* and *d*, which still surround the nucleus intimately, and are very thin in the walls. These cells expand by growth, and their walls, at the same time, become thicker. The nuclei also grow in a very slight degree for a while. The cells now contain a clear fluid, then a granular precipitate, which generally first forms itself around the nucleus, as at *e*, figure 4, for example. In the old cells young cells occasionally arise. By and by cavities or canals are formed in the cartilages in a way which has not yet been investigated with sufficient care, through which these vessels also take their course.

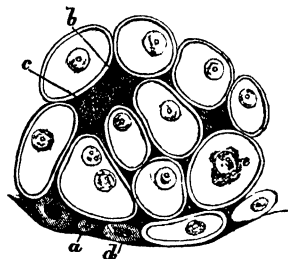

Fig. 4 represents the branchial cartilage of a very young larva of the frog. The lower edge of the preparation is the natural limit of the cartilage.

If, after this epoch, any new cells are produced, we may presume that their evolution takes place, not only from the surface of the cartilage, but also around these vascular cavities and canals; and, perhaps, it is from this circumstance that, after ossification, the cells are found disposed in laminae, partly concentric around the cavity of the medullary canal, partly parallel with the surface of the cartilage. In the process of ossification, the earth is first deposited in the cytoplasm of the cartilage. The cells of the cartilage, at the same time, suffer a remarkable change, which seems to consist in their becoming elongated in different directions into hollow processes or canals, and thus acquiring a stellated appearance (stellated cells). The nuclei of the cells, during this process, are absorbed. At length, and finally, the cells themselves, and the canals proceeding from them, appear to become filled with calcareous earth.

[§ 53. CELLULAR TISSUE.—The cytoplasm of the cellular tissue is a structureless, gelatinous looking, transparent substance, not unlike the vitreous humour of the eye. Within this arise small round granular-looking cells, furnished with nuclei (fig. 5 *a*.) Here, too, the nucleus appears to be the part first formed, the cell being developed around it. As the

cellular tissue contains blood-vessels, the evolution of new cells also proceeds through the entire substance of the tissue. The cells grow, but scarcely attain to twice the diameter of the nuclei they enclose ; at a very early period, however, they

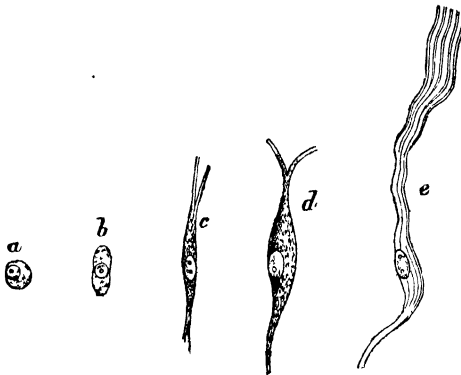

Fig. 5.—Various stages in the evolution of the cellular tissue of the fetus of the sow; the stages are in the order of the letters of reference; *c* and *d* are mere varieties.

begin to lengthen out in two opposite directions into fibres (figure 5 *b*). The fibres then stretch on either hand into several branches (*c*, *d*), and these, in their turn, divide into still smaller fibres. This fibrillation of the branches, however, by and by proceeds backwards, towards the stem of the fibre arising immediately from the body of the cell ; so that at a later period, instead of a single fibre, a bundle of isolated fibres is seen proceeding from either side of the body of the cell (fig. 5 *e*). Finally, the body of the cell itself also splits into fibres, and then, instead of a cell, we have a bundle of separate fibres, to which the nucleus of the former cell still continues attached. This process consists, therefore, in a kind of splitting up of a single cell into a multitude of hollow fibres. At a subsequent period, the nucleus is taken away, so that the fibres alone remain, and compose the filaments of the cellular tissue, as we find them in adults. It would appear, however, that they must suffer a chemical change, in addition to the changes in form, inasmuch as the cellular tissue at first affords no proper gelatine.

[§ 54. “MUSCLE.—The researches of Valentin have shown that the muscles are composed of globules arranged in rows, like strings of beads, which then unite into a fibre,—the pri-

mary muscular fibre. The fibre thus evolved is a hollow cylinder, in the cavity of which, cell-nuclei lie near to one another (fig. 6, *a*).

From this it is probable that the globules which compose the fibre were hollow, — were cells, — and that the nuclei, included in the cylinder, are the nuclei belonging to these primary cells. The earlier

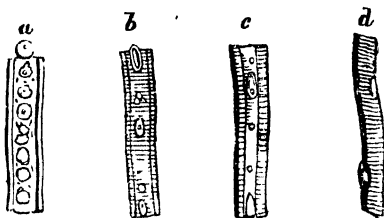

Fig. 6. *a, b, c*. Different stages in the evolution of muscular fibre; *d*, a muscular bundle imperfectly developed, standing on its edge.

process of evolution must therefore have been as follows:— the globules or primary cells arranged themselves in a row, or coalesced into a cylinder, and then the septa, by which this cylinder must have been divided, underwent absorption. The nuclei are flat, and lie within the cylinder, not in its axis, but on its walls. This cylinder, rounded and closed at its ends, — this secondary muscular cell, grows continually, like a simple cell, but only in the direction of its length, for it either gains nothing in point of breadth, or it becomes actually thinner. The growth lengthwise, however, does not proceed from the ends only, but through the entire extent of the cylinder, as is obvious, from the fact of the nuclei, which at first lay close to one another, getting more and more distant, and even themselves elongating often in no inconsiderable degree. In this way, the muscular bundle *a*, (fig. 6) is changed into the bundle *b*. At this period, the deposition of a new substance upon the inner surface of the parietes of the cylinder, or cellular membrane of the secondary muscular cell, takes place, by which its wall is thickened (compare the fibre *c* with the fibre *b*, fig. 6). That the thickening of the wall here, is no thickening of the cell-membrane itself, as is in the case of cartilage, appears from this, that the nuclei are not forced inwards, towards the hollow of the cylinder, but outwards, and continue lying in front of the secondary deposition, as is seen in *d* (fig. 6). The secondary deposition in question, goes on until the cylinder is completely filled. The deposited substance changes into very

delicate fibres, which run in the direction of the length of the cylinder. These are the primary muscular fibres; together they constitute a bundle, and this is the primary muscular fasciculus, which is inclosed externally by a peculiar structureless wall—the cell-membrane of the secondary muscular cell. A process, in all respects analogous, occurs, according to Meyen, in the cells of the liber, or inner bark of vegetables. Here, too, simple cells arise, which arrange themselves in rows, and by coalescing at the points where the cellular parietes are in contact, subsequent absorption of the septa being produced, change into a secondary cell, the wall of which increases in thickness by means of secondary deposition; the only thing wanting in the resemblance is, that this thickening should take place by means of longitudinal filaments.

[§ 55. "NERVE.—The nerves appear to be formed after the same manner as the muscles, viz. by the fusion of a number of primary cells arranged in rows into a secondary cell. The primary nervous cell, however, has not yet been seen with perfect precision, by reason of the difficulty of distinguishing nervous cells, whilst yet in their primary state, from the indifferent cells out of which entire organs are evolved. When first a nerve can be distinguished as such, it presents itself as a pale cord, with a coarse longitudinal fibrillation, and in this cord a multitude of nuclei are apparent (fig. 7, *a*).

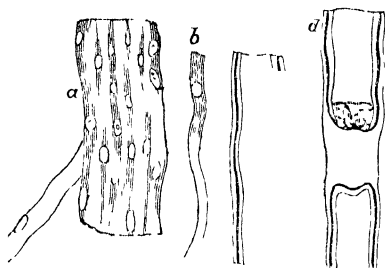

Fig. 7.—Different stages in the development of nerve; *a* and *b*, of a very young fetal sow; *c* and *d*, nervous vagus, from the cranium of a foetal calf.

It is easy to detach individual filaments from a cord of this kind, as the figure just referred to shows, in the interiors of which many nuclei are included, similar to those of the primitive muscular fasciculus, but at a greater distance from one another. The filaments are pale, granulated, and (as appears by their farther development) hollow. At this period, as in muscle, a secondary deposit takes place upon the inner aspect of the walls of

the fibrils, or upon the inner aspect of the cell-membrane of the secondary nervous cell. This secondary deposit is a fatty white-coloured substance, and it is through this that the nerve acquires its opacity (fig. 7, *b*). Superiorly, the fibril is still pale; inferiorly, the deposition of the white substance has occurred, and its effect, in rendering the fibril dark, is obvious. With the advance of the secondary deposit, the fibrils become so thick, that the double outline of their parietes comes into view, and they acquire a tubular appearance (fig. 7, *c*). On the occurrence of this secondary deposit, the nuclei of the cells are generally absorbed; yet a few may still be found to remain for some time longer, when they are observed lying outwardly between the deposited substance and the cell-membrane (fig. 7 *c*), as in the muscles. The remaining cavity of the secondary nervous cell appears to be filled with a pretty, consistent substance, the *band* of Remak, and discovered by him. In the adult a nerve consequently consists, 1st, of an outer pale thin cell-membrane—the membrane of the original constituent cells, which becomes visible, when the white substance is destroyed by degrees (*ex. gr.* fig. 7, *d*); 2nd, of a white fatty substance, deposited on the inner aspect of the cell-membrane, and of greater or less thickness; 3rd, of a substance which is frequently firm or consistent, included within the cells, the *band* of Remak.*

[§ 56. From this *resumé*, it would appear that the universal elementary form of every tissue is the CELL, which is preceded by the NUCLEUS as mediate, and the NUCLEOLUS as immediate products of the formative power. Cells and nuclei seem to stand in mutual and relative opposition; so that generally, perhaps invariably, the one is evolved at the expense of the other (fig. 8). After these transition stages are accomplished, the tissue attains individuality according to the general character and place it occupies in the system. During this last stage the more distant

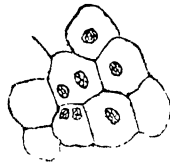

Fig. 8.—Cells from the granulations of the umbilical cord of the calf. They bear a striking resemblance to the cellular tissue of vegetables; nuclei are seen included in the several cells. After Breschet and Gluge (*Ann. des Sc. Nat. t. viii. pl. 6, fig. 5*).

* Dr. Schwann, in Professor Wagner's Physiology, p. 222.

organic parts enlarge, as is distinctly seen in the cells of the epithelium, in the muscular fibres, and in the primary fibrous fasciculi of the nerves; whilst mere nuclei, as the blood, lymph, or pus-globule, remain, or suffer diminution in the course of farther development.]*

SECTION III.

DIFFERENCES BETWEEN ANIMALS AND PLANTS.

§ 57. AT first sight, nothing would appear more widely different than animals and plants. What is there in common, for instance, between an oak and the bird which seeks shelter amidst its foliage?

§ 58. The difference, indeed, is usually so obvious, that the question would be superfluous, if applied only to the higher forms of the two kingdoms; but as we descend to the simpler and therefore lower forms, the distinctions become so few, and so feebly characterized, that it is at length difficult to pronounce whether the object we have before us is an animal or a plant. Thus, the sponges have so great a resemblance to some polyps, that they have generally been included in the animal, although in reality they belong to the vegetable kingdom.†

§ 59. Animals and plants differ in the relative predominance of their component elements, oxygen, carbon, hydrogen, and nitrogen. In vegetables, only a small proportion of nitrogen is found, while this element enters largely into the composition of animal tissues.

§ 60. Another peculiarity of the animal kingdom is the presence of large, distinctly limited cavities, for the lodgment of certain organs; such is the skull and the chest in the higher animals, the branchial chamber in fishes, and the abdomen or general cavity of the body, which exists in all animals, without exception, for the reception of the digestive organs.

§ 61. The well-defined and compact forms of the organs lodged in these cavities is a peculiarity belonging to animals only. In plants, the organs designed for special purposes are never embodied into one mass, but are distributed over various parts of the individual; thus the leaves, which answer to the

* Wagner's Physiology, p. 221.

† The animality of sponges is maintained by some of our most distinguished naturalists.—ED.

lungs of animals, instead of being condensed into one organ, are developed on the stem and branches; nor is there any organ corresponding to the brain, the heart, the liver, or the stomach.

§ 62. Moreover, the presence of a proper digestive cavity involves marked differences between the two kingdoms, in respect to alimentation, or the use of food. In plants, the fluids absorbed by the roots are carried to every part of the plant, before they arrive at the leaves; in animals, on the contrary, the food is at once received into the digestive cavity, where it is elaborated; and it is only after it has been dissolved and prepared, that it is introduced into the other parts of the body. The food of animals consists of organized substances, while that of vegetables is derived from inorganic elements; vegetables produce albumen, sugar, starch, &c., whilst animals consume them.

§ 63. Plants commence their development from a single point, the seed, and, in like manner, all animals are developed from the egg. But the animal germ is the result of successive transformations of the yolk, while nothing similar takes place in the plant. The subsequent development of individuals is for the most part different in the two kingdoms. No limit is usually placed to the increase of plants; trees put out new branches and new roots as long as they live. Animals, on the contrary, have a limited size and figure; and these once attained, the subsequent changes are accomplished without any increase of volume or essential alteration of form; while the appearance of most vegetables is repeatedly modified, in a notable manner, by the development of new branches. Some of the lowest animals, however, as the polyps, increase in a somewhat analogous manner.

§ 64. In the effects they produce upon the air, by respiration, there is an important difference. Animals consume the oxygen, and give out carbonic acid gas, which is destructive to animal life; while plants, by respiration, which they, in most instances, perform by means of the leaves, reverse the process, and furnish oxygen, which is essential to the life of animals. If an animal be confined in a small portion of air, or water containing air, this soon becomes so vitiated by respiration as to be unfit to sustain life; but if living plants are enclosed with the animal at the same time, the air is maintained pure, and

no difficulty is experienced. The practical effect of this compensation, in the economy of nature, is obviously most important; vegetation restoring to the atmosphere what is consumed by animal respiration, combustion, &c., and *vice versa*.

§ 65. But there are two properties which, more than all others, distinguish the animal from the plant, namely, the power of moving itself or its parts at will, and the power of perceiving objects and the influences produced by them; in other words, *voluntary motion* and *sensation*.

§ 66. All animals are susceptible of pleasure and pain. Plants have also a certain sensibility. They wither and fade under a burning sun, or when deprived of moisture; and they die when subjected to too great a degree of cold, or to the action of poisons. But they have no consciousness, and therefore suffer no pain; while animals under similar circumstances endure it. Hence they have been called *animate beings*, in opposition to plants, which are *inanimate beings*.

[§ 67. If we take a general view of the animal and vegetable kingdoms, we find that each kingdom may be grouped into three divisions.

IN THE ANIMAL.

1. Zoophyta.
2. Mollusca and Articulata.
3. Vertebrata.

IN THE VEGETABLE.

1. Acotyledons.
2. Monocotyledons.
3. Dicotyledons.

[§ 68. The first great division of the animal series comprehends the zoophytes; their bodies have a circular or radiated form like some of the lowest vegetables, and are composed of a simple organic tissue, which is soft, pulpy, more or less transparent, and possessed of irritability and contractibility, although muscular fibres have not been observed in many groups of this division. They manifest a high degree of sensibility, although distinct nerves and ganglia have been only discovered in the *acalephæ* and *echinodermata*. In these classes the ganglia form so many centres of life, and each segment of the body has its own special ganglion. Through this simple condition of the nervous system many zoophytes possess the power of reproduction by scission or slips, and by buds or gemmules, after the manner of plants. The most inferior forms have no distinct organ except a digestive cavity, which

is sometimes furnished with small cœca ; they have no perceptible blood-vessels nor special organs for respiration and reproduction ; they are all aquatic, and are analogous to the lowest division of the vegetable series, the acotyledonous or cellular plants, both in form, consistence, and chemical composition.

[§ 69. The acotyledons all possess a soft, pulpy tissue of the most simple organisation, deprived of fibres. The reproductive organs are altogether absent, or are united on the same individual ; they have no medullary substance, and are merely expansions of simple cells, in which no special organs are developed for any of the functions.

[§ 70. The second division of the animal series comprehends all those in which we find the nervous system disposed in cords in a body more or less symmetrical, extending from the head to the posterior extremity, under the intestinal canal. In all the classes of this great section the nervous trunks lie on the ventral surface of the body, and are provided at intervals with a number of ganglia, from which leashes of filaments emanate to supply the different organs. The nervous centre we call the brain, is formed in them of a double ganglion, situated above the esophagus ; from it two branches arise to unite in ganglia situated below that tube, thus embracing the esophagus like a necklace or collar : from this nervous circle filaments proceed to be distributed to the different organs of the body. In all the mollusca, the nervous system preserves this general character ; but among the articulata, as crustacea, insects, and annelides, each ring of the body possesses a ganglion, which distributes filaments to the organs contained therein. The number of ganglia in the series corresponds to the segments comprised in the length of the body, the whole being connected together by a double cord, emanating from the lateral parts of the esophagean ganglion. From this disposition of the nervous system, life is not confined to a single centre (as in the vertebrata), each ganglion presiding, as it were, over the vital manifestations of the organs proper to the individual segments : it is thus they can reproduce many important parts that may have been removed, or lost by accident, as the claws of the crab and lobster, &c.

[§ 71. The nutritive functions of the mollusca and articulata

are under the empire of a ganglionic cord, similar to the sympathetic nerve in man. These two great classes never present an internal articulated skeleton; their muscles are attached to the skin, which is more or less indurated. The crustacea and mollusca have a heart and blood-vessels, for propelling and circulating their nutritive fluids, with branchiæ for aquatic and pulmonary sacs for æriform respiration. In the arachnida, insects, and annelides, the circulation is carried on by a pulsating dorsal vessel, and respiration is accomplished by sacs, branchiæ, or trachiæ, that ramify, like blood-vessels, through every part of the body: their jaws move on a horizontal plane, and many of them are provided with a proboscis or a suctorial apparatus. They possess the senses of vision, and even those of smell and hearing; touch and taste, being refined modifications of sensibility, are enjoyed in a greater or less degree by all animals. The reproductive organs in the acephalous mollusca (as the oyster) are united in the same individual: they are separate, however, in the gasteropoda (as the snail) and cephalopoda (as the cuttle-fish), as well as in the crustacea and insects.

[§ 72. This division of the animal series is analogous to the monocotyledonous plants. The marrow or pith is interwoven with their vegetable fibres, as the nervous system is disseminated by ganglia through the bodies of the invertebrata; there is no osseous skeleton in the one, nor is there any true wood in the other, but in both the circumference is more solid than the centre. We see among some families of this section (as the grasses, lilies, and palms, &c., the same as among insects, crustacea, and annelides), the integument more or less indurated, and in some families containing a quantity of silicious particles, just as the external skeleton of insects is composed of peculiar animal substances, termed chitine and coccine, and consolidated by minute proportions of the phosphates of lime, magnesia, and iron; or that of crustacea, which is hardened with nearly half its weight of the carbonate of lime, and a considerable proportion of the phosphate, with traces of magnesia, iron, and soda. The knotty-jointed stems of many grasses represent the articulated bodies of worms, crustacea, and myriapods. Many families of this division produce seed only once in their lives, like some worms and insects which cease to exist after having deposited their ova. Their leaves are

simple, and their nerves are, in general, parallel : their flowers possess only three stamens, or their multiples (6 or 9), and they are often incomplete in many of their parts. None of these endogenous vegetables grow by layers, but by a swelling out of their internal structure, just as the horny or calcareous envelope of insects and crustacea is periodically shed to allow of a general increase from within. Among some classes and families of both kingdoms there are many groups which are aquatic in their habits.

[§ 73. The third great division of the animal kingdom, called *vertebrata*, comprehends all those animals provided with two distinct nervous systems ; the one formed of a series of ganglia extending through the body, and called the ganglionic or sympathetic system, which presides over the functions of internal life or nutrition. The other, consecrated to external life or relation, is composed of the brain, spinal cord, and nerves, the principal centres of which are enclosed in the cranium and the canal of the vertebral column ; they all possess an internal framework or skeleton, the several jointed pieces of which are moveable on each other. The most perfect possess five senses ; four of these occupying the cavity of the cranium, and there are never more than four members disposed in pairs. They have all a heart with red blood, and respire by lungs, or branchiæ, and the sexes are separate. They are usually parted into two great groups, the *vertebrata* with cold blood and feeble respiration, fishes and reptiles, and the *vertebrata* with warm blood and a complete respiration, birds and mammals. The nervous system, in this division of the series, attains its greatest development, presenting the most perfect centralisation, from which the most noble faculties emanate.

[§ 74. We compare with this group of animals the dicotyledonous vegetables, or those whose embryo possesses two cotyledons or seed lobes. The form of their reproductive organs is always the most perfect, being composed of the number five and its multiples. Their trunks or stems grow by the addition of concentric layers or rings of wood made to their outer surface. Being thus exogenous, they display more or less solidity internally, like the osseous skeleton of the *vertebrata*. The central marrow or pith is enclosed in a sheath (analogous to the spinal canal) extending through the entire

length of the plant from the collar of the root to the terminal flowers of the stem and branches. This division comprehends the most highly developed families of the vegetable series in which the manifestations of life display themselves in their fullest perfection. Here we meet with all the most vivacious plants, all the large trees, and all those which manifest the most marked irritability, as the sensitive plant, &c. &c.

[§ 75. In *resumé* we observe in animals and plants certain functions that are analogous, and contain organic traits that are different in each kingdom. The following table will enable the student to understand these analogies and differences :—

IN THE VEGETABLE.

1. The roots are external, and are implanted in the earth, and all the special vital organs are situated externally.

2. Nourishment surrounds the vegetable, which it absorbs by the external organs (the roots, leaves, &c.)

3. The sap ascends and descends by the agency of the vessels, aided by absorption and exhalation, through the influence of light and heat.

4. The leaves are the ærating organs or lungs of plants, and are usually of a green colour, and situated externally.

5. The vegetable absorbs carbonic acid gas, retains the carbon, and exhales the oxygen through the influence of the solar rays.

IN THE ANIMAL.

1. The absorbent vessels or internal roots penetrate the membranes of the digestive canal, and the vital organs are concealed internally.

2. The animal is compelled to search for its pasture, or its prey, and absorbs the juices by internal organs.

3. The blood (whether white or red) circulates by means of one or more hearts, or by the contractility of the vessels themselves.

4. The respiratory organs of animals are sacs, tracheæ, branchiæ or lungs, and are usually placed internally, and tinged of a red colour, from the blood that circulates through them.

5. The animal absorbs the oxygen of the atmosphere, or that contained in the water, and exhales carbonic acid.

IN THE VEGETABLE.

6. The vegetable is a compound of many plants that are divisible and capable of multiplication by buds, slips, suckers, or seeds.

7. The plant has a circular or radiated form, both sexes being often united on the same individual.

8. The reproductive organs in the vegetable fall every year.

9. Fructification is the great end of vegetable existence, by the development of the flower and fruit.

10. The movements in the vegetable are involuntary, depending on a state of turgescence in the vessels, or in a degree of irritability peculiar to their tissues.

11. The vegetable is endowed with an organic sensibility without consciousness.

12. Vegetables possess defensive or protective weapons, and many have poisonous organs.

IN THE ANIMAL.

6. Animals, some polyps and mollusca excepted, form a whole that is indivisible, being composed of central organs, as the brain, spinal cord, heart, &c.

7. Animals have mostly a binary form, each half being the counterpart of the other: the sexes are usually separate, although they are united in the inferior classes of mollusca and radiata.

8. In the animal they are permanent during life.

9. Sensibility and consciousness are the highest conditions of animal life, through the operation of the brain and nerves.

10. The motions of animals are voluntary, depending on the energy of their muscular system, regulated by the will acting through the nerves. Some movements belong to the involuntary class.

11. The nervous system confers on animals sensibility, accompanied with consciousness.

12. Animals, in addition, are furnished with offensive instruments for seizing and destroying prey; some have a venomous, and others an electrical apparatus to accomplish the same end.—T. W.]

CHAPTER THIRD.

ORGANS AND FUNCTIONS OF ANIMAL LIFE.

SECTION I.

OF THE NERVOUS SYSTEM AND GENERAL SENSATION.

§ 76. LIFE, in animals, is manifested by two kinds of functions, viz. : First, the *functions of animal life*, or those of *relation*, which include sensation and voluntary motion ; those which enable us to approach, and perceive our fellow-beings and the objects around us, and bring us into relation with them : Second, the *functions of vegetable life*, which are nutrition in its widest sense, and reproduction ;* those indeed, which are essential to the maintenance and perpetuation of life.

§ 77. The two distinguishing characteristics of animals, namely, sensation and motion (§ 65), depend upon special systems of organs, wanting in plants, and which are called the *nervous and muscular systems*. The nervous system, therefore, is the grand characteristic of the animal body. It is the centre from which all the commands of the will issue, and to which all sensations tend.

§ 78. Greatly as the form, the arrangement, and the volume of the nervous system vary in different animals, they may all be reduced to four principal types, which correspond, moreover, to the four great divisions of the animal kingdom. In the vertebrate animals, namely, fishes, reptiles, birds,

* This distinction is the more important, inasmuch as the organs of animal life, and those of vegetative life, spring from very distinct layers of the embryonic membrane. The first are developed from the upper layer, and the second from the lower layer of the germ of the animal. See Chapter on Embryology

and mammals, the nervous system is composed of two principal masses, the *spinal cord* (fig. 19), which runs along the back, and the *brain* (fig. 20), contained within the skull.* The volume of the brain is proportionally larger, as the animal occupies a more elevated rank in the scale of life. Man, who stands at the head of creation, is in this respect also the most highly endowed being.

§ 79. With the brain and spinal cord the nerves are connected, which are distributed, in the form of branching threads, through every part of the body. The branches which unite with the brain are nine pairs, called the cerebral nerves, and are destined chiefly for the organs of sense located in the head. Those which join the spinal cord are also in pairs, one pair for each vertebra or joint of the back. The number of pairs varies, therefore, in different classes and families, according to the number of vertebræ. Each spinal nerve is double, being composed of two threads, which at their junction with the cord are separate, and afterwards accompany each other throughout their whole course. The anterior thread transmits the commands of the will, which induce motion; the posterior receives and conveys impressions to the brain, to produce sensation.

STRUCTURE OF THE PRIMARY FIBRES OF NERVES.

[§ 80. Whoever would acquire a knowledge of the minute anatomy of the nervous system, had better begin by examining one of the peripheral nerves. Let a piece of one of the trunks or branches of a nerve, that can easily be dissected out, be chosen, and laid upon a glass plate: here let the nervous bundles be separated or teased out by the aid of a needle in either hand, until free spaces of the glass plate appear; let the preparation now have a drop of serum or of albumen added to it, and then be covered with a piece of thin glass. Under a magnifying power of from three to four hundred diameters, numbers of transparent cylindrical, straight, or slightly sinuous filaments will be perceived as the chief structure,

* The brain is composed of several distinct parts, which vary greatly, in their relative proportions, in different animals, as will appear hereafter. They are: 1. The medulla oblongata; 2. Cerebellum; 3. Optic lobes; 4. Cerebral hemispheres; 5. Olfactory lobes; 6. The Pituitary body; 7. The Pineal body. See figures 19, 20. The spinal cord is composed of four nervous columns.

having a mean diameter of from 1-200th to 1-300th of a line, and always proceeding distinct from one another, never anastomosing. These are the PRIMITIVE FIBRES of the nerve (figs.

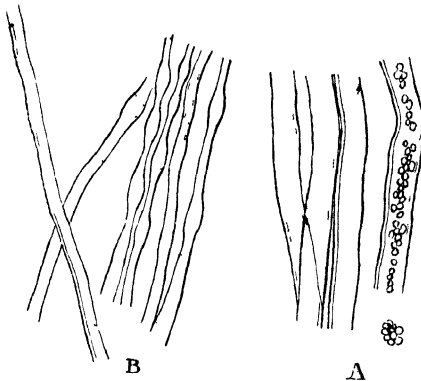

Fig. 9.—A, Primary fibres of a human body. B, primary fibres (more highly magnified) of the brain.

9, *et seq.*) If these fibres have undergone little or no change, each is severally seen to be bounded by a double contour—an appearance which must be viewed as the optical expression of a transparent covering or membrane. The middle space is completely transparent. When the nerve has suffered change from pressure, imbibition of water, or the like, the appearance is altered. In the middle clear space granular or grumous particles or masses are perceived, which, under pressure, escape from the divided ends of the primitive fibres (fig. 9, A, to the right). Other changes, but more difficult of apprehension, also take place in the lateral contours of the fibres, which are made up of the double lines.

To observe the primitive fibres of nerves in their normal situation, the best subject is the delicate flat muscle of some small animal—one of the muscles of the eye of the common sparrow, for example (fig. 10)—which must be gently pressed between two plates of glass. Here, in the middle trunk (*a*), which, to the naked eye, looked finely fasciculated only, a great number of primitive fibrils are perceived lying over one another, but without running altogether parallel, inasmuch as some diverge a little to the right, others a little to the left, some proceed from below upwards, others from above downwards, but all preserve the main course onwards. They lie so close, and cover each other so much, that their structure individually cannot be distinctly made out. At the parts

where smaller branches are sent off transversely, however, (fig. 10, *b, b,*) the structure of the primary fibres running in a parallel direction may be seen as distinctly as when they are separated by art. It frequently happens that we may tear fresh primitive fibres in such a way that the broader, clear, middle portion alone retains its continuity, the bounding lines having given way transversely; the middle portion is then seen to be enclosed within an extremely delicate contour. From all this, it may be inferred that each primitive fibre consists of a very clear included substance,

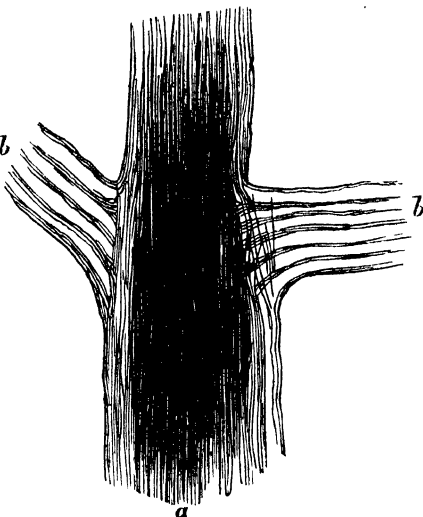

Fig. 10.—Branch of a nerve distributed to one of the muscles of the eye of a sparrow.

and a transparent tubular sheath. The double line or contour of either side being the optical expression of the inner and outer wall of this tube. Other observers admit a more compound structure, and some have even spoken of a ciliary epithelium, lining the inner aspect of the sheath.

[§ 81. These primary tubes or fibres of the peripheral nerves are similar, with very slight modifications, in every part of the nervous system. It is necessary, however, to except from this general rule the first and second cerebral nerves. In the auditory nerve the fibres are somewhat more delicate than elsewhere. They also very commonly appear rather finer than wont where they traverse ganglions. They appear to be distributed over the periphery of the body, without, in any instance, anastomosing. They have a central and a peripheral termination. With reference to the first, or

where they enter the brain or spinal cord as roots of nerves, they pass immediately into the white medullary fibres, or central parts, and at the same time become by one-half, or even two-thirds, smaller. The primary fibres of the brain and spinal cord, as well as those of the olfactory and auditory nerves, are in some cases so delicate, that they measure but the 1-1000th of a line in diameter: frequently, however, they are thicker, from the 1-400th to the 1-500th of a line in diameter. These fibrils, of different dimensions, are constantly observed running over, and under, and near to one another.

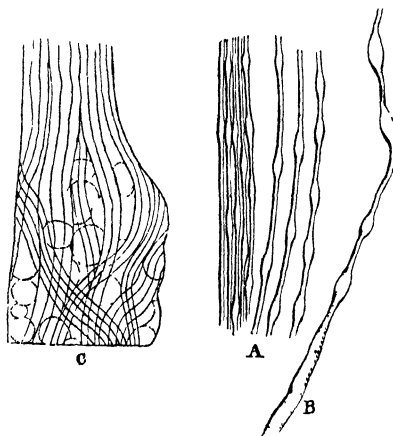

Fig. 11.—A, primary fibres of the olfactory nerve of man. B, a primary fibre from the thoracic portion of the spinal cord of man. C, a thin slice from the outer aspect of the ophthalmic ganglion of man. After Valentin.

(Figs. 9, 10, B, and 11, C.) Examined in the most recent state possible, they are, for the major part, cylindrical, but in part also knotty or varicose, inasmuch as they exhibit little oval or rounded enlargements in their course. (Figs. 9, B, 11, A, B.) It is doubtful whether or not this varicose state is accidental only, or is really peculiar to certain primary fibres in the living state. So much is certain, that the knots are constantly seen arising under the eye of the observer, and that they

are frequently effects of the methods of investigation pursued. There is nevertheless this peculiarity to be noted in regard to the primary fibres of the central parts, that they are much more apt to assume the varicose condition than those of the periphery—a peculiarity that seems to be connected with their structure. The sheaths, in fact, of the central primary fibres are much more delicate, although in general still charac-

terised by the double contour, than those of the peripheral fibres. In the central fibres, too, the sheath and contents appear to be far more intimately connected; in many cases they are completely inseparable, so that the contrast as betwixt sheath and contents disappears. These delicate primary fibrils of the central masses run in such a variety of ways, crossing and interlacing, and forming such a tangled skein, that it is impossible to follow them to the roots of the nerves, or towards the periphery of the brain and cord, and so to make certain that they never anastomose. To all appearance, however, they



Fig. 12.—A small portion of the terminal plexus of primary fibres of the auditory nerve in the auditory sac of the pike (*Esox lucius*.)

never divide ; and they seem no more to run into one another, or to communicate by anastomoses here, than they do in the peripheral parts of the body. But these fine primary fibres of the central parts enlarge conspicuously and immediately at the entrances of the different nerves into the brain and spinal cord.

TERMINATION OF THE PRIMARY FIBRES.

[§ 82. A very important question, which naturally presents itself in connexion with the primary fibrils, is this : how do they end ? Although generally traced with difficulty, the peripheral terminations of the nervous fibrils are still much more easily demonstrated than those of the centres. United into bundles, and surrounded with cellulo-membranous sheaths (neurilema), the primary fibres penetrate all the organs nearly

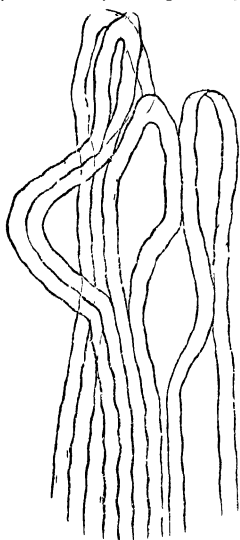

Fig. 13.—Terminal primary fibres from the ciliary plexus of the common duck. After Valentin.

to their peripheral confines, to where they are covered with epithelial or epidermic formations. Here it is that the bundles of primary fibres separate and form plexuses—*terminal plexuses*, as they have been designated ; at last single primary fibres form loops, or rather two primary fibres meet and form a loop—*terminal loops*. These loops are smaller or larger in different tissues. (Figs. 12, 13.) Wherever the primary fibres of nerves have been distinctly traced to their extremities, this mode of termination in loops has been observed, so that it appears to be general, and even to extend to the nerves of special sense, with the single exception of the olfactory and optic nerves, in the peripheral expansions of which, no loopings have been positively ascertained to exist, although no one has yet descended upon any other mode of termination in regard to these two

nerves. It has been stated that the mode of termination of the primary fibres is much more difficult of demonstration in the central parts than in the peripheries. It is impossible at present to say positively that they again turn round loop-wise, on the surface of the brain, as certain observations would lead us to conclude that they did. (Fig. 14.)

[§ 83. Besides the tubular or primary fibrous formations now described, there is a second and general elementary structure in the nervous system, entitled the *ganglionic*, or *nervous globules*, better the *ganglionic cells* or *corpuscles*. These corpuscles are met with in the brain, spinal cord, and ganglia, and also here and there in particular nerves. The cineritious, or grey nervous substance, wherever it occurs, be it deep seated or superficial, consists of aggregations of these ganglionic corpuscles. They have always a certain quantity, more or less, of the tubular or primary fibrous structure mixed with them; the more abundant the primary fibres, the lighter is the mass; the fewer they are, the darker is its colour. The ganglionic corpuscles, particularly in the brain and spinal cord, are much more delicate and easily destroyed than the primary fibres. To study them, it is well to begin with the Gasserian ganglion of a small animal, such as a rabbit, or a thoracic ganglion of a small bird (figs. 16, B. 17, a). Here they mostly appear as globular or oval, indistinctly granular bodies, having

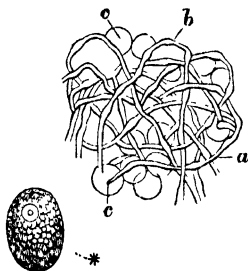

Fig. 14.—Central terminal fibres from the yellow substance of the cerebellum of the common pigeon: *a*, terminal plexus of primary fibres; *b*, loopings of the terminal fibres; *c*, ganglionic globules.* A ganglionic cell from the Gasserian ganglion of man, removed from its sheath and highly magnified.

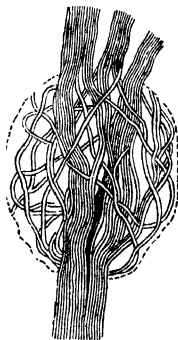

Fig. 15.—Second abdominal ganglion of the sympathetic nerve of the *Fringilla spinus*, to show the course of the primary fibres.

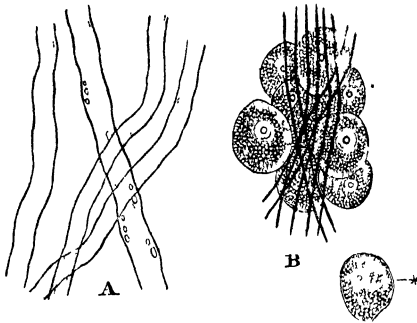

Fig 16—A, single primary fibres from an intercostal nerve of the common sparrow. B, several primary fibres and ganglionic cells, from one of the thoracic ganglions of the same bird *A single ganglionic cell, with a clear nucleus and darker nucleolus.

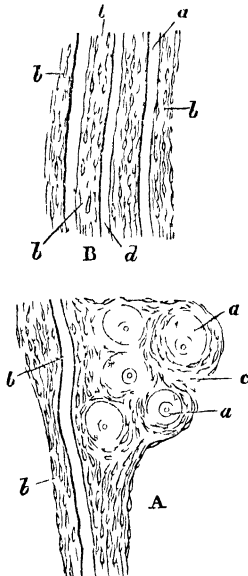

Fig. 17—A, thin slice from the superior cervical ganglion of the calf; a, ganglionic globules; b, primitive fibre; c, involucrem of the ganglionic cells. B, thin slice from the soft nerve of the plexus maximus carotidis of the calf; a, a, isolated primary fibres; b, b, thick sheaths of the same. After Valentin.

internally a clear vesicular-looking nucleus, which in its turn mostly includes a nucleolus. They are composed of extremely fine molecules, connected together by a semi-fluid, glutinous, or viscid, amorphous substance. It is doubtful whether or not they possess a delicate transparent proper capsule. For

the major part, however, each ganglionic corpuscle is surrounded by a cellulo-membranous capsule or sheath: extremely delicate, greyish or reddish coloured cellulo-membranous fibres, furnished with nuclei, are interwoven into true capsules; but from these the ganglionic corpuscles very readily become detached and fall out. Frequently, as, for instance, in the cervical portion of the sympathetic nerve (fig. 17, A and B), this cellulo-membranous sheath is so highly developed, that the ganglionic corpuscles (A, a, a) appear to be bedded in a kind of matrix, which is only intersected here and there by single primary fibres (B, a, a); these, like the corpuscles, seeming to be separated and kept apart by the abundant cellular tissue.

This cellular tissue, with its nucleated fibres, has been erroneously described as a third and distinct special element of the nervous system, under the name of the *organic fibrils*, probably from their abundance in the sympathetic and its ganglia, or of the nodulated fibrils—*fibrillæ nodulosæ*.

The ganglionic corpuscles present numerous varieties in regard to form, size, arrangement, and the structure of their remoter elements. They are singularly delicate and destructible in the central masses. Here the cellular sheath, just described, is entirely wanting; and the finely granular substance of which they consist, and the clear nucleus which they contain, are so diffuent, that it is seldom we succeed in finding more under our microscopes than a homogeneous, finely granular mass. Whether from the great nervous centres, or from the more peripheral ganglia, they are generally either round or oval in figure (figs. 14, 16*, 17, *a*, and 18, *a*); frequently, however, they are elongated, sausage shaped, four - cornered, tetrahedral, and furnished with off-sets or processes (fig. 18, *B*); it is seldom that two are connected by a bridge. The nucleus is always clear, roundish, or lengthened and simple; the nucleolus is extremely small. In their general external appearance, these ganglionic corpuscles have a surprising resemblance to

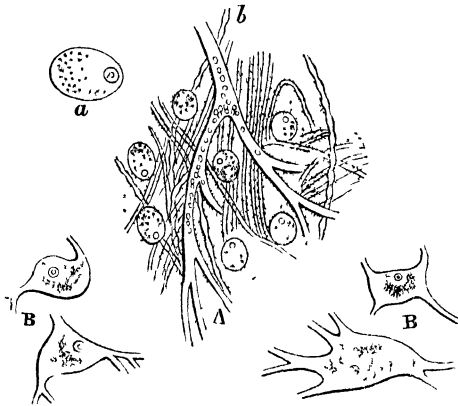

Fig. 18.—Primary fibres and ganglionic globules from the human brain. A, ganglionic globules in the substance of the thalamus, mixed with varicose primary fibres. *a*, a single ganglionic globule or cell, highly magnified; *b*, a blood-vessel. B, B, ganglionic globules with processes of various form, as they are met with in the black substance of the crura cerebri. After Valentin.

primitive ova; they are constituted after the general type of cellular formations, although they have more of the character of solid bodies than of true cells with fluid contents.*]

[§ 84. The general form and distribution of the nervous system of animal life is shown in the annexed plate (fig. 19), which represents the cerebro-spinal system, and the course of the principal nerves in man. At *a* are seen the two hemispheres of the cerebrum; at *b* those of the cerebellum; and at *c* the spinal cord. The principal motory nerve, passing to the muscles of the face, is seen at *d*; and at *e*, the brachial plexus formed by the interlacing of five spinal nerves, destined to give off branches to the upper extremities. The principal of these are, the median nerve, *f*, which passes down the arm; the ulnar nerve, *g*, which passes round the inner condyle of the humerus, is distributed to the integument and muscles, and sends terminal twigs to the ring, and fourth fingers; the internal cutaneous nerve, *h*; and the radial and muscular nerves, *i*, which are in like manner distributed to the integument and muscles of the fore-arm, hand, and fingers. From the spinal cord are given off the intercostal nerves, *j*, which, escaping through the holes formed in the spinal column, pass between the ribs, and are lost in the skin and muscles of the trunk. The lumbar plexus, *k*, sends nerves to the front of the thigh and leg; the sacral plexus, *l*, gives origin to the principal nerves of the lower extremities. The great sciatic nerve—the largest nerve in the body—proceeds down the back of the thigh, and at the ham divides into the tibial nerve, *m*, the external peroneal, or fibular nerve, *n*, and the external saphenous nerve, *o*.

[§ 85. THE BRAIN is a compound organ, enclosed in the skull, and surrounded by three membranes: these are, the *dura-mater*, the external or fibrous, the *pia-mater*, the middle, or vascular; and the *arachnoid*, the internal or serous. These membranes are prolonged into the canal of the spinal column for lodging the cord, and invest in like manner this central portion of the nervous system. Figure 20 will serve to give the student a general idea of the different parts which compose the brain. It represents a vertical section of the cerebrum, *a*; the cerebellum, *d*; the medulla oblongata, *e*; and shews the

* Professor Wagner's Elements of Physiology, p. 464, *et seq.*

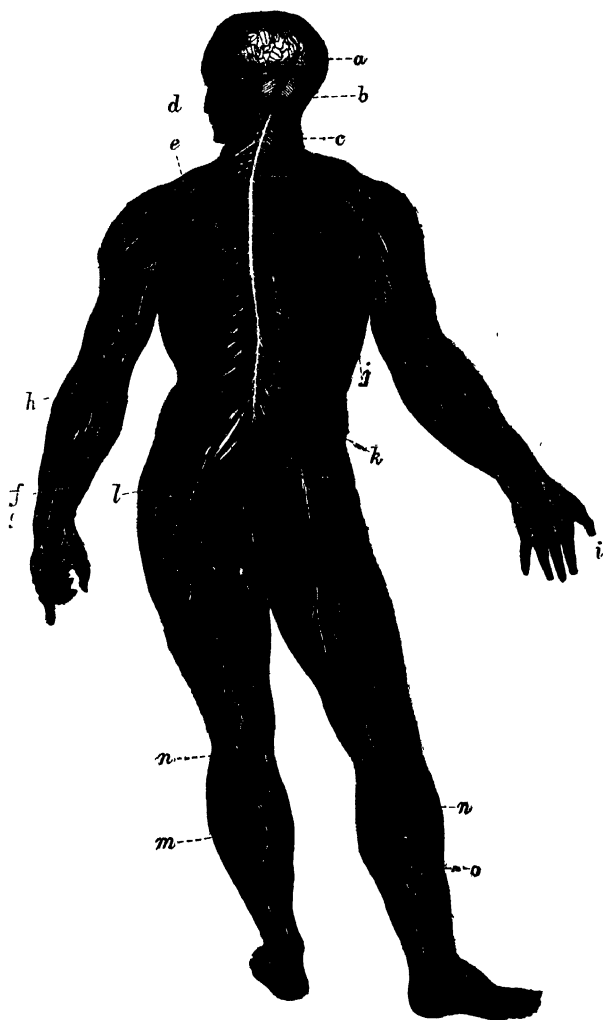

Fig. 19.—The Nervous System of Man.

primary course of the cerebral nerves, and their points of union with the brain and medulla oblongata.

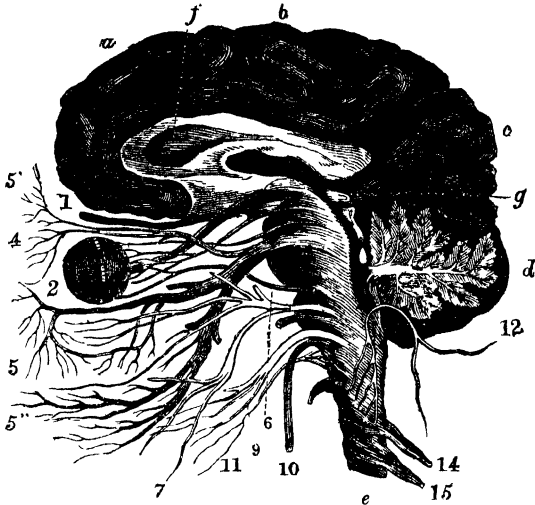

Fig. 20.—Section of the Brain of Man, shewing the primary course of the Nerves.

[§ 86. THE CEREBRUM (*a*) is in man the most voluminous part of the brain. It occupies all the upper portion of the cranium, from the frontal to the occipital bone (fig. 79). It is of an ovoid form, with the largest extremity directed backwards. Superiorly and posteriorly it is divided into two hemispheres, separated from each other by a fold of the dura mater, called the *falx cerebri*, which descends between them. Inferiorly, the hemispheres are limited by a broad band, *f*, called the *corpus callosum*, which extends its fibrous structure into both hemispheres, and unites them organically together. The surface of the cerebrum presents a number of elevations and depressions, which wind in a tortuous manner, resembling the foldings of the small intestine in the abdomen. These are called the convolutions of the brain, and arise from the great development of the nervous substance being thus folded to pack into a small compass; the convolutions are more or less deep in proportion to the development of the cerebrum. In infancy they are shallow, as well as

in the cerebrum of the higher orders of mammals, whilst in some of the lower orders, as the rodentia (figs. 28 and 29), they entirely disappear. The inferior surface of the cerebrum is divisible into three lobes, separated from each other by transverse furrows (fig. 20). *a* is the anterior, *b* the middle, *c* the posterior lobes. Near the median line we observe two round eminences, the optic lobes, *g*; and two large masses of neurine, the peduncles of the brain, which pass downwards to be continued into the *medulla oblongata*. It is from the base of the brain, likewise, that the nerves proceed which are classed under the division cerebral. The surface of the cerebrum is formed almost entirely of grey nervous substance, which covers the internal white neurine. When we cut off the hemispheres parallel to the corpus callosum, we observe that the cerebrum contains internally several cavities communicating with each other, called the ventricles of the brain. In these chambers several bodies are found, the study of which more especially belongs to the professed anatomist.

[§ 87. The CEREBELLUM occupies the posterior and inferior part of the skull (fig. 19, *b*. fig. 20, *d*): its weight, as compared with that of the brain, is, in man, 1:9, whilst in other mammals it varies from 1:2 to 1:14. It is protected from the pressure of the posterior lobes of the cerebrum by a large extension of the dura mater (*tentorium cerebelli*), which becomes an osseous plate in the carnivora. The cerebellum is divided into two large lateral lobes, and one small central lobe. The lateral lobes are separated by a membranous process (*falx cerebelli*), and the middle lobe is situated in a depression behind and below them. In the quadrumana (figs. 32 and 33), the third lobe is proportionally larger; and in the rodentia (figs. 28 and 29) it equals in volume a lateral lobe. The nervous substance is folded into a series of transverse concentric lamellæ, placed perpendicularly on their edges, and enclosed one within the other. If the sulci are carefully opened, several other lamellæ will be found enclosed within them, but smaller in size, more irregular, and with various degrees of inclination. The distribution of the neurine is seen on making a vertical section of one of the lateral lobes, as shown at (*d*) figure 20. The white substance is found so disposed as to resemble the stem and branches of a tree, and hence called the *arbor vitæ*. The branches project into the lamellæ, and are invested with a covering of grey substance.

A horizontal section shows that the quantity of white substance considerably exceeds that of the gray. The cerebellum is connected with the brain and spinal cord by three pairs of medullary fasciculi. From the interior of the lobes two fasciculi (*processus e cerebello ad testes*) pass forwards and upwards to the optic lobes, *g*. In their ascent they converge, and are connected by a fold of neurine, called the valve of Vieussens.* Two round white processes, *corpora restiformia*, pass obliquely downwards, and are continued into the posterior columns of the medulla oblongata. The largest of the fasciculi are the *crura cerebelli*, which incline forwards and inwards, and become continuous with the fibres of the pons Varolii.† This bridge of neurine bears the same relation to the cerebellum that the corpus callosum does to the cerebrum; it is composed of converging fibres, and may therefore be regarded as the cerebellar commissure.

[§ 88. THE OPTIC LOBES. When we raise the posterior lobes of the brain, we observe between this organ and the cerebellum four small round eminences, placed in pairs on each side of the median line (fig. 20, *g*), upon the superior surface of the medullary prolongations, which ascend from the spinal cord to expand in the cerebrum; these are the optic lobes, which are developed in a direct ratio with the volume of the optic nerves.

[§ 89. THE SPINAL CORD is that division of the cerebro-spinal system, inclosed in all the vertebrata, within the spinal canal. In man it reaches from the lower border of the pons Varolii to the first or second lumbar vertebra, whilst in the foetus it extends throughout the whole length of the spinal canal; in this respect representing the permanent condition of the spinal cord in reptiles and fishes. We observe three distinct enlargements of the cord, in different parts of its course. The cranial swelling, or *medulla oblongata*, exhibits a considerable expansion, near the margin of the pons, which diminishes before entering the foramen magnum: on its lateral parts are three eminences, the *pyramidal*, *olivary*, and *restiform* bodies. The second enlargement corresponds to the interval between the third and fifth cervical vertebræ; the third, to that be-

* Vieussens, a great anatomist; his *Neurographia Universalis* was published at Lyons in 1685.

† In honour of a celebrated anatomist of the sixteenth century, Varoli.

tween the tenth dorsal and first lumbar vertebræ; its inferior termination presents considerable variety; the spinal cord is divided into two lateral halves by sulci, extending, on its anterior and posterior surfaces, throughout its entire length; it is composed of white and grey substance: the grey occupying the centre, and the white the periphery of the organ. About an inch below the pons the pyramidal bodies of the anterior columns communicate very freely. The white fibrous layer dips into the sulcus, and its fibres interlace along the median line; those from the right column passing into the left, and *vice versa*, whilst on the posterior columns no such interchange of fibres is observed: experiments have proved that the anterior columns are the motory, the posterior columns the sensitive centres of the cord.

[§ 90. The spinal cord gives attachment to thirty-one pairs of nerves, which are regular, symmetrical, and double-rooted; one of the roots of each nerve (fig. 21*, *d*) is united to the anterior column, the other (*b*) to the posterior column of the cord; on the posterior root a ganglion (*c*) is formed; the anterior root (*d*) joins the posterior (*b*) external to it, and thus forms a nerve (*e, f*) compound in structure and function.

Sir Charles Bell, Mayo, Majendie, and others, have proved by experiments that sensation depends on the posterior root, and the power of voluntary motion on the anterior root. The cord is attached, throughout its whole length, to the tube of the dura mater by a thin shining membrane, derived from the pia mater, which sends out about twenty dentate processes, to pin it to that fibrous sheath; this ligament is hence called *membrana dentata*: it extends from the foramen magnum to the first lumbar vertebra, and forms a vertical septum, separating the

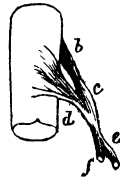

Fig. 21*.—A segment of the spinal cord, to show the double origin of the spinal nerves: *b*, the posterior root; *c*, the ganglion of that root; *d*, the anterior root; *e*, the compound nerve.

anterior from the posterior roots of the nerves. The sheath of the dura mater is not entirely occupied by the spinal cord, but contains a considerable quantity of limpid fluid, in which it is suspended. By this admirable provision this nervous centre is preserved from pressure and commotion, in violent movements of the vertebral column.



[§ 91. Comparative anatomy, and the history of animal evolution, have shed an important light upon the relative importance of the different masses that compose the brain; a general survey, therefore, of the morphology of this organ may illuminate the student's path, and enable him to comprehend more clearly its complicated structure.

[§ 92. We can easily trace a progressive development of the structure of the brain, in the entire series of the vertebrated animals. In FISHES its constituent parts appear in the form of globular masses, which lie behind each other on the same plane. The volume of the brain is small in proportion to the mass of the body; thus it is 1-720 in *Gadus lata*, 1-1305 in *Esox lucius*, 1-1837 in *Silurus glanis*, and only 1-37440 in *Scomber thynnus*. Its relative proportion to the spinal cord is seen in the annexed figure of the cerebro-spinal system of the bleak, *Cyprinus alburnus* (fig. 21), where *a*, is the ganglia of the hemispheres; *b*, is the optic lobes; *c*, the cerebellum; *d*, the medulla oblongata; *e*, the spinal cord. The cord presents anterior and posterior columns, as in man, and enlarges into the medulla oblongata, which may be regarded as an integral part of the brain; from it arises most of the cerebral nerves; the cerebellum (*c*) is single, and occupies the median line; it exhibits various phases of development in the different families.

Fig. 22.



Fig. 23.



In front of the cerebellum we find a pair of ganglia—the optic lobes (*b*)—which in bony fishes give origin to the optic nerves; they are hollow, and exhibit internally the rudiments of parts that are more fully developed in the higher classes; transverse bands of neurine unite these ganglia together. Before the optic lobes a second pair of ganglia are placed—the cerebral hemispheres (*a*); they are small, and lie apart, but are united by a transverse band in bony fishes: with these masses the olfactory nerves (fig. 22, 1) are connected, which sometimes form ganglia before they are distributed to the nose (figs. 22 and 23,

a a***). The optic nerves (fig. 22, 2) decussate in most fishes like two fingers laid crosswise ; in the skate the right nerve goes through a fissure in the left ; in bony fishes the nerves cross without any organic intermixture.

[§ 93. In the AMPHIBIA, as the frog and newt, the brain exhibits many of the essential features of the fishes type. In front of the medulla oblongata we observe the small single-lobed cerebellum, *c* ; before it lies the optic lobes, *b*, and pineal gland ; and before these are the hemispheres, *a*, more developed than in fishes.

[§ 94. In SCALY REPTILES, serpents, lizards, and tortoises, (figs. 24 and 25) the optic lobes and pineal gland preserve the same relations ; but the hemispheres (fig. 24, *a*) are much increased in volume, and the olfactory nerves (fig. 25, *c*) arise from their anterior parts. The hemispheres appear in the form of rolled laminæ, and enclose lateral ventricles ; on their floor we observe the corpora striata, through which the ascending fibres of the hemispheres are seen to pass.

[§ 95. BIRDS present a still further development, and exhibit a very uniform arrangement of the cerebral parts.

Fig. 26 represents the brain of a turkey. The medulla oblongata, *d*, is considerably expanded ; a true pons is absent, but some transverse medullary fibres represent the rudiment of this cerebellar commissure. The cerebellum, *c*, exhibits the middle lobe, with feeble indications of lateral expansions, *c**. It is divided into lamellæ by transverse fissures ; portions of the posterior co-

Fig. 24.

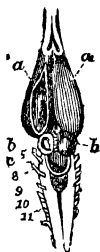

Fig. 25.



Fig. 24 represents the brain of a tortoise, in which *a*, is the hemispheres ; *b*, the optic lobes ; *c*, the cerebellum ; *d*, the pineal gland ; 5, 9, 10, 11, the pairs of nerves.

Fig 25 shows the base of the same brain : *b*, are the hemispheres ; *c*, the olfactory nerves ; 1, the optic nerves ; 2, the auditory nerve ; 3, the medulla oblongata.

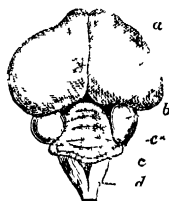

Fig. 26 The brain of a turkey.

lumns of the medulla expand in its interior, giving off branches which are covered by grey substance, and forming an arbor vitæ. The optic lobes are considerably developed, and seen at *b*, behind the hemispheres. When these bodies are separated,

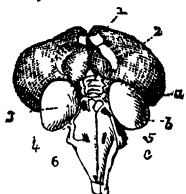

Fig. 27.—The brain of a pigeon.

The olfactory nerves, with their ganglionic enlargement, are seen in fig. 27, which represents the base of the brain of a pigeon. *a*, is the hemispheres; *b*, the optic lobes; *c*, the cerebellum; 1 to 6, pairs of nerves. The olfactory nerves arise at the anterior and inferior parts of the anterior lobes of the hemispheres; the corpus callosum is represented by a feeble rudiment in this class.

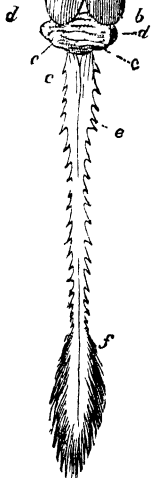

Fig. 28.—The brain and spinal cord of a rat.

we observe the anterior commissure bounding the third ventricle; pineal and pituitary bodies are distinct; the hemispheres are greatly increased in volume in this class; they are still smooth, without convolutions and posterior lobes. The absence of the latter permits us, when we open the skull, to see the optic lobes lying behind them.

The olfactory nerves, with their ganglionic enlargement, are seen in fig. 27, which represents the base of the brain of a pigeon. *a*, is the hemispheres; *b*, the optic lobes; *c*, the cerebellum; 1 to 6, pairs of nerves. The olfactory nerves arise at the anterior and inferior parts of the anterior lobes of the hemispheres; the corpus callosum is represented by a feeble rudiment in this class.

[§ 96. The Brain presents many phases of development in the different orders of the MAMMALIA. In the monotremata, and marsupialia, the hemispheres are not much more developed than in birds; and the corpus callosum is still rudimentary. In the ornithorhyncus, the cerebellum, like that of birds, is one-lobed, with indications only of the lateral lobes, and the hemispheres become narrow and pointed as they advance. In the rodentia, as in fig. 28, which represents the brain and spinal cord of a rat (*Musdecumanus*) the hemispheres, *a*, are smooth, and without convolutions, and the posterior lobes are undeveloped; the cerebellum, *d*, lies free and uncovered, as do also the optic lobes, *b*, and pineal gland; the middle lobe of the cerebellum, *c*, *c*, is more highly developed than the lateral lobes, *d*, *d*; the superior enlargement of the spinal cord, *e*, extends into the middle swelling; *f*, is the inferior enlargement, terminating in the cauda equina; 1, is the ganglia of the olfactory nerves.

Fig. 29 is the brain of a hare (*Lepus timidus*), seen from above, with the right hemisphere laid open. 1, 1, the ganglia of the olfactory nerves; *a, a*, the cerebral hemispheres, without convolutions; *b, c*, the optic lobes of the right side; *d*, the posterior border of the corpus callosum; *f*, the corpus striatum of the right side; *g*, the cornu ammonis; *h*, the posterior part of the right lateral ventricle; *i*, the root of the right optic nerve; *k*, the right ganglion of the hemispheres; *l*, the cerebellum; *m*, its lateral lobes; *n*, the lateral lobules; *o*, the medullary laminæ at the surface of the cerebellum; *p*, the fourth ventricle; *q*, the arbor vitæ.

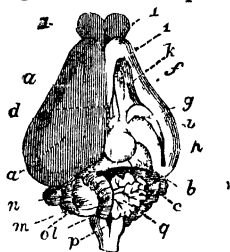

Fig. 29 — The brain of a hare.

In the ruminantia and carnivora, the convolutions exist as seen in the brain of the common cat, (*Felis catus*), fig. 30, where

1, 1, are the ganglia of the olfactory nerves, and 1*, the cavity which they contain; 2, the commissure of the optic nerves; 3, the roots of the third pair; 8, the roots of the eighth pair; *a*, the anterior lobes; *b*, the middle lobes of the cerebrum; *a*, the white root of the olfactory nerve; *c*, the grey matter of the infundibulum; *d*, crura cerebri; *e*, the pons Varolii; *f*, corpora restiformia; *g*, corpora pyramidalia; *h*, medulla oblongata; *i*, the cerebellum; *k*, corpora albicantia.

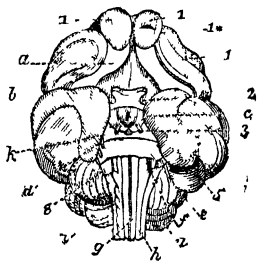
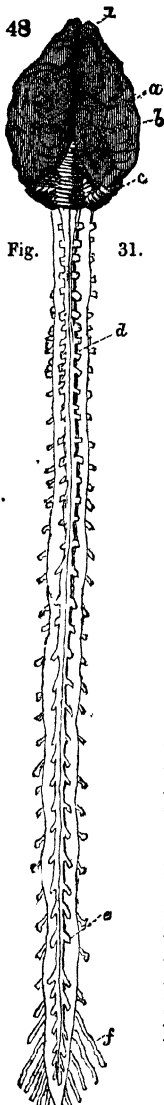

Fig. 30.—The brain of the cat.

Fig. 31 represents the brain and spinal cord of the raccoon, (*Procyon lotor*). *a*, the cerebral hemispheres; 1, the ganglia of the olfactory nerves; *b*, the optic lobes; *c*, the cerebellum; *d*, the superior, and *e*, the inferior enlargement of the spinal cord; *f*, the cauda equina. The spinal sheath is laid open, to show the cord and the double roots of the spinal nerves. In the rounded brain of the porpoise, and in that of the raccoon (fig. 31) and the cat (fig. 30), the convolutions are well developed; in the brain of the elephant they are deep, numerous, and isolated from one another; the optic thalami increase in size as we ascend the animal series, and the corpus callosum is developed



in a direct ratio with that of the hemispheres, as is also the pons Varolii with that of the lateral lobes of the cerebellum.

In the monkeys, as the *Cercopithecus sabæus*, the brain (figs. 32 and 33) evidently resembles that of man in its general configuration. The hemispheres (fig. 33, *a*, *a'*, *a''*) are well developed, both in their anterior and posterior lobes; the latter almost cover the cerebellum (in fig. 33, *c*, *c*); they are relatively of large size, and have well-developed lateral lobes (fig. 32). The medulla oblongata, *d*, is large, and presents the pyramidal olivary, and restiform eminences, as in man. The internal structure of the brain of this monkey is seen at fig. 32, where *a* is the corpus callosum; *b*, the anterior commissure; *c*, corpora striata; *d*, optic thalami; *e*, the radiated disposition of the medullary fibres, as they pass through the thalami and striated bodies; *f*, the pineal gland; *g*, the anterior tubercles; *h*, the posterior tubercles, nates, and testes, of the corpora quadrigemina; *i*, the posterior termination of the lateral ventricle; *l*, the fourth ventricle; *m*, the medulla oblongata; *n*, the lateral lobes of the cerebellum, divided to show the arbor vitæ.

Fig. 33 is the base of the same brain: 1, the olfactory nerves; 2, the optic nerves; 3, the third; 4, the fourth; 6, the sixth pairs of nerves: *a*, the anterior; *a'*, the middle; *a''*, the posterior lobes of the hemispheres; *c*, the cerebellum; *c'*, the pons Varolii. The corpora albicantia form a single projection behind the infundibulum; the olfactory nerves have no mammillary swelling like the olfactory of man; the posterior cornu of the lateral ventricles, and the pes hippocampi, are wanting. The brain of the ourang, and particularly that of the chimpansee, bear a still closer resemblance to that of man: the hemispheres are more largely developed, the convolutions more numerous and

symmetrical; the cerebellum is relatively larger to the cerebrum than in man; the trapezium, which is present in the lower monkeys, is absent in them, as it is in man; corpora albicantia are distinct; the posterior cornu of the lateral ventricle becomes developed with the pes hippocampi of the cornua ammonis, parts which are only found in the human brain besides.

Fig. 32.

Brain of *Cercopithecus Sabæus*
laid open.

Fig. 33.

Base of the same brain, showing
the cerebral nerves.

[§ 97. CEREBRAL NERVES. We have shown in fig. 20 the primary course of the cerebral nerves, and their union with the brain. The olfactory ganglia are large in the cold-blooded vertebrata, but very small in man, consisting merely of an enlargement of the trunk of the *olfactory nerves* (1), which are the first pair that unite with the brain. From the olfactory ganglia, reposing on the cribriform plate of the ethmoid bone, numerous fine filaments proceed to the nasal cavity, and are distributed to the mucous membrane of the nose.

[§ 98. The *optic nerves* (2) may be traced from the globe of the eye to their union with the optic lobes, which are developed in a direct ratio with these nerves (§ 88). Behind the eye we observe the third, fourth, and sixth pairs of nerves.

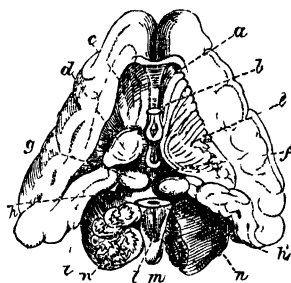
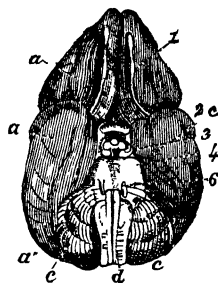
[§ 99. The *third pair* are the principal motory nerves of the muscles of the eye: they distribute branches to the three recti, and the inferior oblique muscles, and send fibrils to regulate the motions of the iris. Reflex motions of the parts to

which these nerves are distributed are occasioned by impressions made upon the optic nerve; as such motions cease when the trunk of that nerve is divided.

[§ 100. The *fourth pair* consist of motory fibrils. They take a long course, and are distributed to the superior oblique muscles, to which they are especially destined.

[§ 101. The *sixth pair* are likewise motory nerves. Their distribution is restricted to the external straight muscles of the eye-ball. The function of these nerves has been proved, both by experiments and pathological observations.

[§ 102. The *fifth pair* resemble in their origin, structure, and distribution, compound spinal nerves. Their anterior roots are distributed exclusively to the muscles of mastication. The posterior roots impart sensation to the integuments of the forehead, temples, eyelids, nose, mouth, the greater part of the ear, the conjunctiva, the mucous membrane of the nasal fossæ, a great part of the mouth, pharynx, upper surface of the tongue, teeth, and gums. These great nerves divide into three branches, 1st, the *ophthalmic* (5) passes into the orbit, endows the eye with sensibility, and comes out beneath the eyebrow, to be distributed on the forehead and temples; 2nd, the *superior maxillary* (5) traverses a canal beneath the orbit, and distributes leashes of filaments to the skin of the cheeks, nose, and upper lip; 3rd, the *inferior maxillary* (5'') is distributed to the tongue, pharynx, tonsils, mouth, teeth, gums, chin and lips.

[§ 103. The *Facial Nerve* (fig. 19, *d*, fig. 20, 7) is the true motory nerve of the muscles of the face, and enables the countenance to reflect the varied emotions of the mind. This nerve does not impart sensation, that function being performed by the branches of the fifth pair. Beneath the origin of the facial nerve is seen the divided trunk of the acoustic, or auditory nerve.

[§ 104. The *Glosso-pharyngeal Nerve* (9) is distributed to the tongue and pharynx: its function is not so clear as that of the preceding nerves. By some it is regarded as the special nerve of taste; by others as a moto-sensitive nerve, as it contains motory and sensitive fibrils.

[§ 105. The *Pneumo-gastric Nerve* (10) is distributed to the larynx, air passages, lungs, heart, esophagus, and stomach. It sends branches, likewise, to the plexuses which surround the

roots of the great arteries that supply the viscera; it possesses motory and sensitive filaments; through the whole of its extensive course it confers sensibility on the vocal and respiratory organs, and on the stomach.

[§ 106. The *Spinal Accessory* (12) is seen ascending along the spinal cord, and passing backwards beneath the cerebellum. It is distributed principally to the great respiratory muscles, and is a motory nerve.

[§ 107. The *Lingual Nerve* (11) is the motory nerve of the tongue, special sensibility being imparted to that organ by the fifth pair, common sensation by the glosso-pharyngeal, and motion by the lingual. It guides the muscles of the tongue in the various operations of chewing, swallowing, and articulating, as often as that organ comes into play in the latter act.

[§ 108. The *Spinal Nerves*, we have already shown (§ 90), unite with the spinal cord by two roots. The posterior roots are furnished with ganglia, over which the primary fasciculi of the anterior roots pass without mixing. Immediately beyond the ganglia, the primary fibres of both roots blend together, and form compound nerves. At 14 and 15 (fig 20), the two first pairs of spinal cervical nerves are seen: these enter into combination with several cerebral nerves. Their sensitive fibres supply the skin of the occiput, ear, chin, and cheek, and send motory fibres to several of the muscles of the tongue. The *phrenic* nerve chiefly derived from the fourth cervical, although it obtains filaments from other nerves, is distributed to the diaphragm, and regulates the involuntary respiratory movements effected by the rising and falling of that muscle. The general distribution of the other spinal nerves has been indicated in our outline of fig. 19.

[§ 109. The *Great Sympathetic Nerves* are placed along the sides of the vertebral column, and extend from the base of the skull to the os coccyx. They may be said to consist of a chain of ganglia, communicating with all the cerebral and spinal nerves, those of the three higher senses excepted. They are destined to preside over the processes of nutrition, and have their great centre, the solar plexus, situated in the abdomen; from the ganglia of the sympathetic, branches proceed to the heart and blood vessels, the lungs and air passages, the stomach and intestinal canal, the liver, kidneys, and other glands. From this distribution of the sympathetic nerves, to the organs sub-

[§ 114. "If we agree, then, that the sympathetic in general performs the functions of the cerebro-spinal nerves at large, we must still admit that it exhibits numerous peculiarities. It not only extends over all the vegetative organs of the abdomen, and in part also of the thorax, but, by its fibrils detached from the ganglia, it accompanies the great blood-vessels in their course, and with these penetrates every part of the body. In its motory, as well as in its sensitive functions, it also exhibits essential modifications: the motions of the parts to which it is distributed are abstracted from the empire of the will. These involuntary, and in the healthy state, unconscious, motions, extend to the most remote structures with which it is in communication, by means of ganglia, such as the iris, for example. Reaction upon stimulation generally lasts longer than the stimulus, which is exactly the reverse of what happens in reference to the muscles of voluntary motion, when the reaction so constantly ceases before the stimulus is removed. The sensibility, as already observed, is extremely slight in the healthy state. The conduction from the peripheral to the central parts, has therefore undergone a manifest alteration, and even partial interruption, as it would seem. The central parts receive no impressions from the organs which are supplied with nerves from the sympathetic; and they have, farther, no power of controlling the motions of these organs. These remarkable effects can only be referred to the influence of the ganglions."*]

[§ 115. The nervous system of the articulata is arranged different from that of the vertebrata. The absence of an internal osseous skeleton in the former removes the nervous centres into new relations: and accordingly, we find it associated with the tegumentary and muscular systems, and ruled by the law which regulates their development. We still, however, distinguish cerebro-spinal, and sympathetic nerves. The brain is situated, without exception, above the anterior extremity of the digestive tube, and connected by two lateral trunks with the spinal cord. Instead of being situated in the dorsal region of the body, as in the vertebrata, it is found, on the contrary, without exception, along the abdominal line. This difference in the disposition of the nervous system constitutes one of the essential characters distinguishing the two great primary subdivisions

* Wagner's Physiology, p. 512, *et seq.*

of the animal series. The number of the ganglia in the simpler forms of the articulata, corresponds in general to the number of the rings of the body: but in the higher groups there is often a fusion of two or more ganglia into one. This change is well exemplified in the development of insects, spiders, and crustaceans: the spinal cord of the articulata, like that of the vertebrata, is composed of motory and sensitive columns.

In insects, a special nervous system, the sympathetic, is distributed to the organs of vegetative life. The annexed figure (34) shows the distribution of the cerebro-spinal system in a beetle, *Carabus nemoralis*.

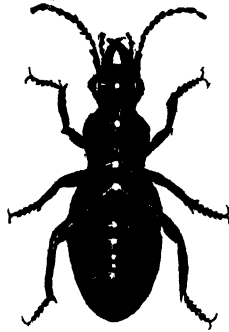

Fig. 34.—The nervous system of *Carabus nemoralis*, a garden beetle. The cephalic ganglia supply nerves to the eyes, antennæ, parts of the mouth, &c.; the thoracic ganglia supply nerves to the thorax, the three pairs of legs and the wings; the abdominal ganglia send branches to the organs contained in the abdomen.

[§ 116. In the mollusca, the principal centre of the nervous system surrounds the gullet, in the form of a gangliated collar; but it exhibits many phases of development in the different classes of this sub-kingdom. In the CONCHIFERA, which are acephalous, as the mussel (*Mytilus edulis*), distinct organs exist for the ingestion of the food, respiration, and locomotion, and each of these possesses ganglia, in immediate relation with the function over which it presides. Hence we find—

1st. *Æsophageal ganglia*, which surround the gullet, and represent the brain. These nerves proceed to the labial processes, that serve for taste and touch.

2nd. *Branchial ganglia* presiding over the respiratory function. From these ganglia, likewise, the muscles concerned in the act of respiration, the adductors of the shell, the folds of the mantle, and the intestine are supplied.

3rd. *Pedal ganglia* vary with the presence or absence of a foot for locomotion. The whole of these ganglia are united into a nervous chain by connecting filaments.

In the GASTEROPODA we observe a further development of the nervous system. They possess a head; and the brain

[§ 114. "If we agree, then, that the sympathetic in general performs the functions of the cerebro-spinal nerves at large, we must still admit that it exhibits numerous peculiarities. It not only extends over all the vegetative organs of the abdomen, and in part also of the thorax, but, by its fibrils detached from the ganglia, it accompanies the great blood-vessels in their course, and with these penetrates every part of the body. In its motory, as well as in its sensitive functions, it also exhibits essential modifications: the motions of the parts to which it is distributed are abstracted from the empire of the will. These involuntary, and in the healthy state, unconscious, motions, extend to the most remote structures with which it is in communication, by means of ganglia, such as the iris, for example. Reaction upon stimulation generally lasts longer than the stimulus, which is exactly the reverse of what happens in reference to the muscles of voluntary motion, when the reaction so constantly ceases before the stimulus is removed. The sensibility, as already observed, is extremely slight in the healthy state. The conduction from the peripheral to the central parts, has therefore undergone a manifest alteration, and even partial interruption, as it would seem. The central parts receive no impressions from the organs which are supplied with nerves from the sympathetic; and they have, farther, no power of controlling the motions of these organs. These remarkable effects can only be referred to the influence of the ganglions."*]

[§ 115. The nervous system of the articulata is arranged different from that of the vertebrata. The absence of an internal osseous skeleton in the former removes the nervous centres into new relations: and accordingly, we find it associated with the tegumentary and muscular systems, and ruled by the law which regulates their development. We still, however, distinguish cerebro-spinal, and sympathetic nerves. The brain is situated, without exception, above the anterior extremity of the digestive tube, and connected by two lateral trunks with the spinal cord. Instead of being situated in the dorsal region of the body, as in the vertebrata, it is found, on the contrary, without exception, along the abdominal line. This difference in the disposition of the nervous system constitutes one of the essential characters distinguishing the two great primary subdivisions

* Wagner's Physiology, p. 512, *et seq.*

of the animal series. The number of the ganglia in the simpler forms of the articulata, corresponds in general to the number of the rings of the body: but in the higher groups there is often a fusion of two or more ganglia into one. This change is well exemplified in the development of insects, spiders, and crustaceans: the spinal cord of the articulata, like that of the vertebrata, is composed of motory and sensitive columns. In insects, a special nervous system, the sympathetic, is distributed to the organs of vegetative life. The annexed figure (34) shows the distribution of the cerebro-spinal system in a beetle, *Carabus nemoralis*.

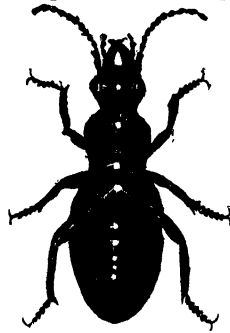

Fig. 34.—The nervous system of *Carabus nemoralis*, a garden beetle. The cephalic ganglia supply nerves to the eyes, antennæ, parts of the mouth, &c.; the thoracic ganglia supply nerves to the thorax, the three pairs of legs and the wings; the abdominal ganglia send branches to the organs contained in the abdomen.

[§ 116. In the mollusca, the principal centre of the nervous system surrounds the gullet, in the form of a gangliated collar; but it exhibits many phases of development in the different classes of this sub-kingdom. In the CONCHIFERA, which are acephalous, as the mussel (*Mytilus edulis*), distinct organs exist for the ingestion of the food, respiration, and locomotion, and each of these possesses ganglia, in immediate relation with the function over which it presides. Hence we find—

1st. *Æsophageal ganglia*, which surround the gullet, and represent the brain. These nerves proceed to the labial processes, that serve for taste and touch.

2nd. *Branchial ganglia* presiding over the respiratory function. From these ganglia, likewise, the muscles concerned in the act of respiration, the adductors of the shell, the folds of the mantle, and the intestine are supplied.

3rd. *Pedal ganglia* vary with the presence or absence of a foot for locomotion. The whole of these ganglia are united into a nervous chain by connecting filaments.

In the GASTEROPODA we observe a further development of the nervous system. They possess a head; and the brain

as in the river snail (*Paludina vivipara*), fig. 35, consists of two oval lobes, *u, u*, united by a nervous commissure. From

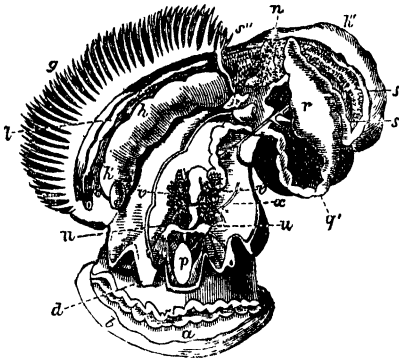

Fig. 35.—The anatomy of *Paludina vivipara* (river snail). *a*, the foot; *b*, the operculum, fixed to the posterior part of the foot; *d*, the respiratory tube, prolonged under the right tentacle; *g*, the branchiæ; *l*, the canal of the mucous organ; *n*, the heart and auricle; *p*, the pharynx; *q'*, the second curvature of the esophagus; *r'*, the stomach; *s*, first turn of the intestine; *s'*, the second turn; *s''*, point where the intestine enters the branchial cavity; *v, v*, salivary glands; *u, u*, supraesophageal ganglia, which represent the brain; *x*, principal nerve to the muscular envelope.

the cerebral masses nerves proceed to the eyes, tentacles, and mouth; another ganglionic centre, the pedal, occupies the body, from which fibrils pass to the muscular foot, whilst other ganglia supply the respiratory and digestive organs.

In the CEPHALOPODA, as the cuttlefish, the brain is still more developed. Large optic nerves are distributed to the highly organised eyes, and auditory nerves to the rudimentary ears, and branches are sent to each of the tentacula, eight or ten in number, that surround the head. We find, likewise, in this class, a rudimentary skull, in

the form of a cartilaginous plate, extended over the brain. The ganglia placed beneath the esophagus are very large, and give origin to many branches. Ganglia are moreover scattered among the nutritive organs, which are regarded as belonging to the sympathetic system.

§ 117. In the radiata, the nervous system is reduced to a single ring, encircling the mouth. It differs essentially from that of the mollusca, by its star-like form and horizontal position. In the anatomy of *Asterias aurantiaca* (common sea-star), fig. 36, the typical form of the nervous system of the radiata is shown. We observe the mouth surrounded by a nervous ring; at the centre of each ray of the body is a

ganglion, from which nerves proceed to the organs contained in that segment of the animal.—T. W.]

§ 117. The nerves branch off and diffuse sensibility to every portion of the body, and thereby animals are enabled to gain a knowledge of the general properties of the objects which surround them; every point of the body being made capable of determining whether an object is hot or cold, dry or moist, hard or soft. There are some parts, however, the ends of the fingers, for example, in which this sensibility is especially acute, and these also receive a larger supply of nerves.

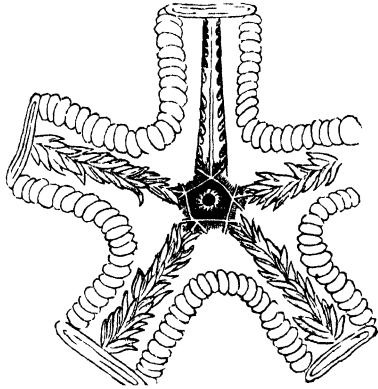

Fig. 36.—The Anatomy of *Asterias aurantiaca*.

§ 118. On the contrary, those parts which are destitute of sensibility, such as the feathers of birds, the wool of animals, and the hair of man, are likewise destitute of nerves. But the conclusive proof that sensibility resides in the nerves is, that when the nerve which supplies any member of the body is severed, that member at once becomes insensible.

§ 119. There are animals in which the faculty of perception is limited to this general sensation; but their number is small, and, in general, they occupy the lowest place in the series. Most animals, in addition to the general sensibility, are endowed with peculiar organs for certain kinds of perceptions, which are called the SENSES. These are five in number, namely: *sight, hearing, smell, taste, and touch.*

SECTION II.

OF THE SPECIAL SENSES.

1. *Of Sight.*

§ 120. SIGHT is the sense by which light is perceived, and by means of which, the outlines, dimensions, relative position, colour, and brilliancy of objects are discerned. Some of these properties may be also ascertained, though in a less perfect manner, by the sense of touch. We may obtain an idea of the size and shape of an object, by handling it; but the properties that have a relation to light, such as colour and brilliancy, and also the form and size of bodies that are beyond our reach, can be recognized by sight only.

§ 121. The EYE is the organ of vision. The number, structure, and position of the eyes in the body is considerably varied in the different classes. But whatever may be their position, these organs, in all the higher animals, are in connection with particular nerves, called the *optic nerves* (fig. 13, *a*). In the vertebrata, these are the second pair of the cerebral nerves, and arise directly from the middle mass of the brain (fig. 20, *b*), which, in the embryo, is the most considerable of all.

§ 122. Throughout the whole series of vertebrate animals,

Fig. 37.



the eyes are only two in number, and occupy bony cavities of the skull, called the *orbits*. The eye is a globe or hollow sphere, formed by three principal membranes enclosed one within the other, and filled with transparent matter. Fig. 37 represents a vertical section through the organ, and will give an idea of the relative position of these different parts.

§ 123. The outer coat is called the *sclerotic* (*b*); it is a thick, firm, white membrane, having its anterior portion transparent. This transparent segment, which seems set in the opaque portion, like a watch-glass in its rim, is called the *cornea* (*f*).

§ 124. The inside of the sclerotic is lined by a thin, dark coloured membrane, the *choroid* (*c*). It becomes detached from the sclerotic when it reaches the edge of the cornea, and forms a curtain behind it. This curtain gives to the eye

its peculiar colour, and is called the *iris* (*g*). The iris readily contracts and dilates, so as to enlarge or diminish the opening in its centre, the *pupil*, according as more or less light is desired. Sometimes the pupil is circular, as in man, the dog, the monkey; sometimes in the form of a vertical ellipse, as in the cat; or it is elongated transversely, as in the sheep.

§ 125. The third membrane is the *retina* (*d*). It is formed by the optic nerve, which enters the back part of the eye by an opening through both the sclerotic and choroid coats, and expands into a whitish and most delicate membrane upon the *vitreous humour* (*h*). It is upon the retina that the images of objects are received, and produce impressions, which are conveyed by the nerve to the brain.

§ 126. The fluids which occupy the cavity of the eye are of different densities. Behind, and directly opposite to the pupil, is placed a spheroidal body, called the *crystalline lens* (*e*). It is tolerably firm, perfectly transparent, and composed of layers of unequal density, the interior being always more compact than the exterior. Its form varies in the different classes. In general, it is more convex in aquatic than in land animals; whilst with the cornea, it is the reverse, being flat in the former, and convex in the latter.

§ 127. By means of the iris, the cavity (*i*) in front of the crystalline is divided into two compartments, called the *anterior* and *posterior chambers* (*i*). The fluid which fills these chambers is a clear watery liquid, called the *aqueous humour*. The portion of the globe behind the lens, which is much the largest, is filled by a gelatinous liquid, perfectly transparent, like that of the chambers, but somewhat more dense. This is called the *vitreous humour* (*h*).

§ 128. The mechanical structure of the eye may be imitated by art;—indeed, the camera obscura is an instrument constructed on the same plan. By it, external objects are pictured upon a screen, placed at the bottom of the instrument, behind a magnifying lens. The screen represents the retina; the dark walls of the instrument represent the choroid; and the cornea, the crystalline and the vitreous humour combined, are represented by the magnifying lens. But there is this important difference, that the eye has the power of changing its form, and of adapting itself so as to discern, with equal precision, very remote, as well as very near objects.

§ 129. By means of muscles which are attached to the

ball, the eyes may be rolled in every direction, so as to view objects on all sides, without moving the head. The eyes are usually protected by lids, which are two in the mammals, and generally furnished with a range of hairs at their edges, called *eye-lashes*. Birds have a third, or vertical lid, which is also found in most reptiles, and a few mammals. In fishes, the lids are wanting, or immovable.

DIOPTRICS OF THE HUMAN EYE.

[§ 130. "The rays of light which attain the retina, and there unite to form images, must of course pass through the whole of the refracting media described in the preceding paragraphs. The refracting powers of these media, which are spoken of collectively as the humours of the eye, differ in conformity with the fashion, structure, density, and chemical constitution of each.* These humours are farther the principal cause of the form of the eye-ball, which not only differs in reference to kinds, but also among individuals of the same kind. In man, the eye-ball, in a general way, presents the form of an ellipsoid open in front, where it is met and completed by a small segment of a sphere engrafted upon it. The axis of the eye corresponds with the optic or visual axis, and extends from the centre of the cornea backwards to the foramen of Soemmerring, a little to the outside of the point at which the optic nerve makes its entrance. This optic axis of the eye measures on an average from $10\frac{1}{2}$ to 11 lines, and differs from the axis of the optic nerve which passes from the outer third of the cornea, to the middle of the point of entrance of the optic nerve, crossing the optic axis at an angle of about 20 degrees. In its general condition, the eye is so fashioned that the rays which arrive from a point divergingly upon the cornea, are immediately made to converge, and this in such measure precisely, that they meet in a focus as they attain the retina. It is of course the central ray alone of a pencil of rays that passes through dioptric media unrefracted; all the other rays suffer refraction, and are approximated to the

* [We have various estimates of the refracting powers of the transparent media of the eye, a summary of which is given by Weber in his edition of Hildebrand's *Anatomy*, IV. 103. The numbers of the several humours of the human eye, according to Brewster, are the following: Cornea, 1,386; aqueous humour, 1,3366; lens, as a whole, 1,3767; middle portion of the same, 1,3786; nucleus of ditto, 1,3999 (according to Young, 1,4025); vitreous humour, 1,3394.]

central ray. The rays composing a pencil falling upon the cornea are refracted in different degrees by the transparent media of the eye, in proportion to the difference between the density of these media and that of the air, and in proportion to the curves presented by their several surfaces. The rays are in the first place refracted by the cornea, by the membrane of the aqueous humour, and by the aqueous humour itself; then, and very particularly, by the crystalline lens, and that differently, by different strata of this body in the ratio of their several densities; finally, by the vitreous humour; having passed through which they have come to a focus, and reached the retina at one and the same moment.

[§ 131. “When the object from which the rays of light proceed has extent in space, — length and breadth, suppose, for example, that it is the arrow *a*, *b*, in fig. 38, then must the object of necessity appear reversed upon the retina *c*, *d*; that which is superior in the object becomes inferior, that which is to the right appears to the left in the image.* As every object emits rays from every point in all directions, which then proceed in straight lines, the axial rays *e*, *f*, *g*, of the different pencils proceeding from either end, and the middle of the arrow, *a*, *b*, must cross at some point within the eye. Numerous observations satisfy us that this point lies very near the centre of the eye (*h*), somewhat behind the crystalline lens (*x*). The prime rays, *e*, *f*, *g*, which proceed from the object may be named, in reference to the eye, rays of direction, because every prime or axial ray of a pencil determines the direction of the other rays, in order that all of them may meet in a focus upon the retina. The point at

Fig. 38.

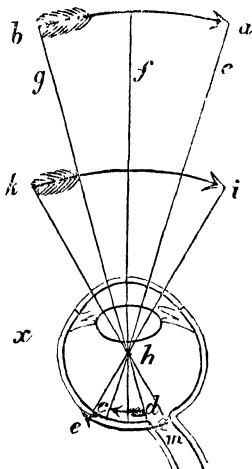

* [It is most easy to obtain conviction of this reversed position of objects upon the retina, by taking the eye of a white rabbit, free from pigment, clearing the globe from fat, muscles, &c., and then presenting it with the cornea in front to the window; all the objects before it, such as trees,

which the rays must diverge, if a clearly defined image is to be formed, is called the point of intersection, or focal centre.* The position of this point is determinable, with the assistance of an instrument for measuring angles; it lies somewhat behind the crystalline lens, and very near the centre of the eye. The intersecting axial rays of two objective points (fig. 38) inclose an angle (a, h, b , for the object a, b ; i, k, h , for the object i, k), which is called the visual angle. This angle diminishes with the distance of the two objects from the eye, and the retinal image is in the same proportion smaller. The arrow, i, k , is only half the distance of the arrow, a, b , from the eye; the visual angle, i, k, h , is therefore twice as large as the angle a, h, b , and the same thing is true in reference to the images depicted upon the retina. It is on this account that objects of different magnitudes seen at different distances, but of which the visual angles are the same, form retinal images of the same size.

[§ 132. All images falling upon the retina through the

houses, &c., are perceived, forming a very elegant little picture, but reversed or upside down upon the posterior wall of the transparent eye. If a simple or double glass lens be now placed at a proper distance, the reversed image which the objects refracted by the crystalline lens form, may be projected on a sheet of paper.

Fig. 39.

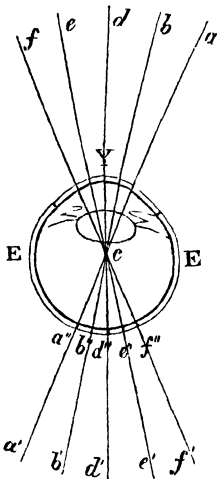

* [Volkman instituted many very able experiments upon the condition of retinal images, and from this inferred the focal centre. An experiment easily performed is the following:—Upon an horizontal table let a number of straight lines (fig. 39) $a a'$, $b b'$, &c., be drawn, all of which intersect at the point c ; upon this point, c , let a prepared white rabbit's eye, E, Y, E , be so placed, that the axis of the eye coincides with the line d, d' . If the anterior part of the cornea, Y , stand at the due distance from c , then will objects at a, b, d, e, f , form their appropriate retinal images at a'', b'', d'', e'', f'' . The chamber being darkened, let tapers be placed at a, b, d, e, f , and the spectator look successively at a , from a' , at b , from b' , at d , from d' , &c., and it will be found that the line of vision will cut the retinal image of a , at a'' , of b , at b'' , &c. The retinal images of the whole of the tapers lie in straight lines, which intersect at the focal point, c .

dioptrical media of the eye are appreciated, but all are not seen with equal distinctness. Images appear by so much the more indistinct, as they are formed more remotely from the point upon which the optic axis of the eye falls. This point corresponds very accurately to the foramen of Soemmerring. Whether the peculiar distinctness of vision at this point depends on the structure of the retina there, or is to be ascribed to this, that in the usual position of the eyes their axes are so directed towards objects, that the principal rays from these strike through the centres of the lenses, remains doubtful. The latter view is, however, the more probable. For as those rays of a pencil of light that strike through the edges of the lens must be differently refracted from those that pass through its centre; in consequence of the difference of density between these edges and the centre, &c., they cannot all unite in the same focus; hence there is unequal dispersion and ill-defined images. It is not unimportant to observe, that we do not in fact see more than a single point of an object with perfect distinctness; if we seem to take in more, it is only from the rapidity with which the eyes travel and survey each point in succession one after the other. In surveying a picture closely, we are conscious of this—we look at one part after another; at a distance, indeed, we receive a general impression of the work, but this is only because the rays then come from the object at large in a pencil so delicate, that it passes entirely by the centre of the lens. There is a particular circumscribed spot at the bottom of the eye, corresponding to the place of entrance of the optic nerve, or, at all events, to the centre of this part, which the *arteria centralis retinæ* perforates, where we have no sense of visual perception.*

Fig. 40.

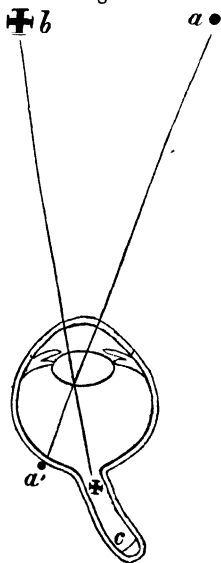

* Marrotti was the first who described the disappearance of the visual image at the entrance point of the optic nerve. To make the experiment, let two black objects be taken and placed at *a* and *b* (fig. 40), upon a white

[§ 133. The motions of the eye are of great importance in the act of vision. As in the steady contemplation of objects we have to bring them into the focal centre of the produced visual axis, we necessarily move the eye-ball in the act of looking around and studying the details of objects successively, according to determinate laws. It has been ascertained that in this motion the eye-ball revolves accurately round a point,—the point of revolution of the eye—which remains unaltered ; it is at once the point of intersection of the rays of direction

Fig. 41.

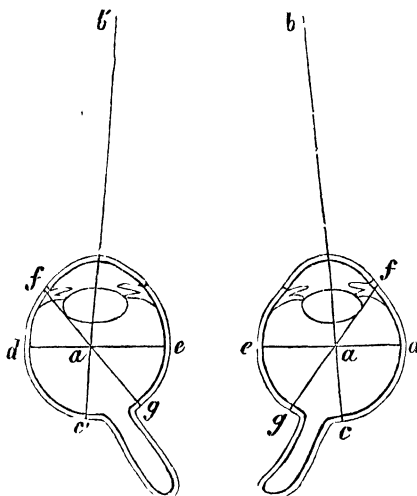

and of those of vision. In this point (fig. 41), *a*, in the appended diagram, all the diameters of the eye intersect, and many of these diameters are at the same time the axes of revolution with reference to the actions of the muscles of the eye. If the two eyes be directed to the points *b* and *b'*, the axial rays fall upon *c* and *c'*. Both eyes then look forwards, and also somewhat convergingly, so that the two axes *b c*, and *b' c'*, do not run precisely parallel, but diverge slightly, by which *c* and *c'* are further from one another than *b* and *b'*. In the horizontal

ground. From the diagram it is seen that in the right eye, the spot, *a*, falls upon the point of the retina, *a'*, whilst the cross, *b*, falls in the middle of the entrance point of the optic nerve, precisely where the central artery and vein of the retina are situated. Now if the left eye be closed, and the point *a*, and cross *b*, are regarded at the usual distance for distinct vision, the attention being, however, particularly directed to *a*, the cross *b*, will be found to disappear the moment the pencil of rays proceeding from it comes to fall upon the middle of the entrance place of the optic nerve.

transverse diameter, $d e$, which runs from the temporal to the nasal side of the eye-ball, lies the axis of the organ in reference to the action of the superior and inferior straight muscles. The perpendicular diameter passes from above downwards through the point of revolution a , cutting the transverse diameter at a right angle, and is at the same time the axis of revolution of the internal and external straight muscles of the eye. A line drawn from the outer margin of the cornea, f , to the inside of the entrance place of the optic nerve, g , represents the horizontal diagonal axis of the eye-ball, and is at the same time the axis of revolution in reference to the two oblique muscles. The superior oblique turns the pupil downwards and outwards; the inferior oblique turns it upwards and outwards. The action of the whole muscles of the eye is productive of no change in the position of the eye-ball, but only of a revolution upon its axis. The faculty, however, which enables us to judge of distances, and to adjust the eye so as to obtain distinct vision at different distances, although it is probably only gradually acquired, is generally exerted unconsciously. The power of thus accommodating the eye is possessed in very different degrees by different individuals; it is particularly remarkable in some of the higher animals; and in some men is either totally wanting or is reduced to a minimum. Short-sightedness depends almost invariably on a loss of the power of accommodation in the eye, as a consequence generally of early and undue exercise of the organ upon objects close at hand. This defect is therefore almost entirely confined to persons in a certain rank of life, or having certain pursuits: the majority of scholars and men of letters are short-sighted. In the same way also far-sightedness is frequently an effect of the want of the power of accommodation in the eye: sailors, who are always looking at the horizon, are all but invariably far-sighted. Both short-sightedness and far-sightedness are but the limits to innumerable and individual departures from that which may be held the standard in the structure of the eye.

[§ 134. There are many experimental ways of proving the different positions which the images of near and distant objects occupy upon the retina. One of the best known is that of Scheiner,* which has been variously modified by different

* Father Scheiner made this experiment more than two hundred years ago: *Rosa ursina*, &c. 1626—29.

observers. If in a card (fig. 42, **) two small holes be pricked, over or to the side of one another, but not more distant than the

Fig. 42.

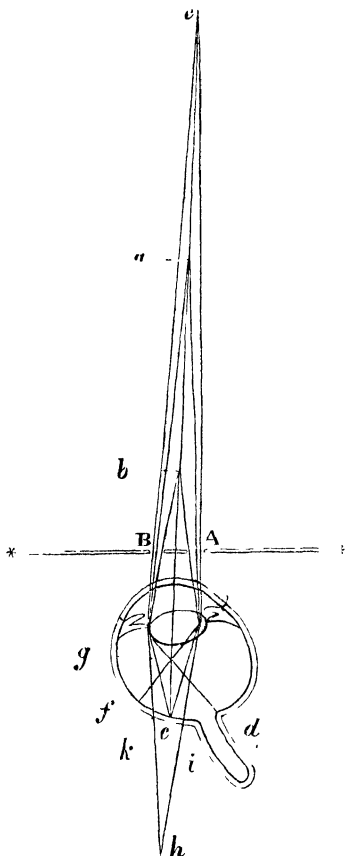

diameter of the pupil, A, B, and a small object, such as a pin, be looked at through them, it will be seen single only when it is at a certain distance from the eye, say at *a*; for the rays of the pencil which proceeds from the object at *a*, come precisely to a focus upon the retina, at *c*. If the pin be now placed at *b*, the rays will centre at *g*, in front of the retina, and the object be then seen double at *d* and *f*. The same thing happens when the pin is removed to a greater distance than *a*, say to *e*; the pencil of rays in this case could only centre after their refraction by the lens at *h*, far beyond the retina, so that the single object is necessarily again seen double at *i* and *k*. Double vision of this kind sometimes occurs along with partial opacities, streaks and specks of the cornea.

[§ 135. Although there are two images formed by the refracting media upon the retina of the two eyes, still in ordinary vision we see objects single, not double. This depends on the condition or quality of particular spots of the two retinæ. Objects, to wit, are seen single when the axes of the two eyes meet in the object contemplated. In this case the point fixed

by the eyes, *l*, in the accompanying diagram (fig. 43), falls upon the two terminal points of the two eyes' axes, *a* and *b*. The points in the two eyes, A and B, which correspond or are similarly situated, with reference to all surrounding points

Fig. 43.

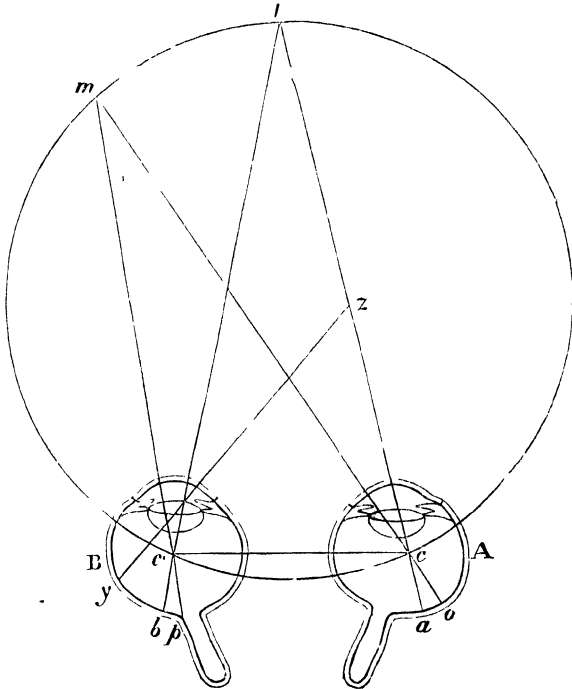

are entitled IDENTICAL, inasmuch as they comport themselves subjectively as if they were in reality but a single point, and images impressed upon them excite in the mind the idea of but one image. Besides these, there are other points of the retina which are also identical or correspondent; in other words, which present single mental conceptions of double retinal impressions; but it is a law that the objects and corresponding points of the retina must lie in a certain circle,

which is designated the HOROPTER,—a circle (fig. 43) which passes at once through the point of coincidence, l , of the visual axes, $l a$, $l b$, and the points of decussation, $c c'$, of these axes with the lines of direction.]*

§ 135. The eye constructed as above described, is called a *simple eye*, and belongs more especially to the vertebrate animals. In man, it arrives at its highest perfection. In him, the eye also performs a more exalted office than mere vision. It is a mirror in which the inner man is reflected. His passions, his joys, and sorrows, are reflected with the utmost fidelity, in the expression of his eye, and hence it has been called “the window of the soul.”

§ 136. Many of the invertebrate animals have the eye constructed upon the same plan as that of the vertebrate animals; the optic nerves, which form the retinæ, are derived from the cephalic ganglia, a nervous centre analogous to the brain. The eye of the cuttle-fish contains all the parts essential to that organ in the superior animals, and, what is no less important, the eyes are only two in number, and placed upon the sides of the head.

§ 137. The snail and kindred animals have, in like manner, only two eyes, mounted on the tip of a long stalk (the *tentacle*), or situated at its base, or on a short pedicle by its side. Their structure is less perfect than in the cuttle-fish, but still there is a crystalline lens, and more or less distinct traces of the vitreous body. Some bivalved mollusca, the pectens for example, have a crystalline lens, but instead of two eyes, they are furnished with numerous eye spots, which are arranged like a border around the lower margin of the animal.

§ 138. In spiders, the eyes are likewise simple, and usually eight in number. These little organs, called *ocelli*, instead of being placed on the sides of the body or of the head, occupy the anterior part of the cephalo-thorax. All the essential parts of a simple eye, the cornea, the crystalline lens, the vitreous body, are found in them, and even the choroid, which presents itself in the form of a black ring around the crystalline lens. Many insects, in their caterpillar state, have also simple eyes.

§ 139. Rudiments of eyes have likewise been observed in many worms. They generally appear as small black spots on the head; such as are seen on the head of the leech, the

* Professor Wagner's Physiology, p. 577—585.

planaria and the nereis. In these latter animals there are four spots. According to Müller, they are small bodies, rounded behind, and flattened in front, composed of a black, cup-shaped membrane, containing a small white, opaque body, which seems to be a continuation of the optic nerve. It cannot be doubted, therefore, that these are eyes; but as they lack the optical apparatus which produces images, we must suppose that they can only receive a general impression of light, without the power of discerning objects.

§ 140. Eye-spots very similar to those of the nereis are found at the extremity of the rays of some of the star fishes; in the sea-urchins they are placed around the border of the apical disc, and at the margin of many medusæ, and in some polyps. M. Ehrenberg has shown that similar spots also exist in a large number of the infusoria.

§ 141. In all the animals mentioned above, the eyes, whatever their number, are apart from each other. But there is still another type of simple eyes, known as *aggregate eyes*. In some millipedes, the pill-bugs, for instance, the eyes are collected into groups, like those of spiders; each eye inclosing a crystalline lens and a vitreous body, surrounded by a retina and choroid. Such eyes consequently form a natural transition to the compound eyes of insects and crustacea, to which we now give our attention.

§ 142. *Compound eyes* have the same general form as simple eyes; they are placed either on the sides of the head, as in insects, or supported on pedicles, as in crabs. If we examine an eye of this kind by a magnifying lens, we find its surface composed of an infinite number of angular, usually six-sided facettes (fig. 44). If these facettes are removed, we find beneath, a corresponding number of cones (*c*), side by side, five or six times as long as they are broad, and arranged like rays around the optic nerve, from which each one receives a little filament, so as to present, according to Müller, the following disposition. The cones are perfectly transparent, but separated from each other by walls of pigment, in such

Fig. 44.

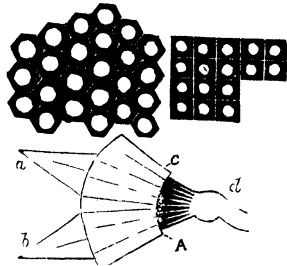

a manner, that only those rays which are parallel to the axes can reach the retina (A); all those which enter obliquely are lost; so that of all the rays which proceed from the points *a* and *b*, only the central ones in each pencil act upon the optic nerve, *d*: the others strike against the walls of the cones. To compensate for the disadvantage of such an arrangement, and for the want of motion, the number of facettes is greatly multiplied, so that no less than 25,000 have been counted in a single eye. The image on the retina, in this case, may be compared to a mosaic, composed of a great number of small images, each of them representing a portion of the figure. The entire picture is, of course, more perfect, in proportion as the pieces are smaller and more numerous.

§ 143. Compound eyes are destitute of the optical apparatus necessary to concentrate the rays of light, and cannot adapt themselves to the distance of objects; they see at a certain distance, but cannot look at pleasure. The perfection of their sight depends on the number of facettes or cones, and the manner in which they are placed. Their field of vision is wide, when the eye is prominent; it is very limited, on the contrary, when the eye is flat. Thus the dragon-flies, on account of the great prominency of their eyes, see equally well in all directions, before, behind, or laterally, whilst the water-bugs, which have the eyes nearly on a level with the head, can see to only a very short distance before them.

§ 144. If there be animals destitute of eyes, they are either of a very inferior rank, such as most of the polyps, or else they are animals which live under unusual circumstances, such as the intestinal worms. Even among the vertebrata, there are some that lack the faculty of sight, as the *Myxine glutinosa*, which has merely a rudimentary eye concealed under the skin, and destitute of a crystalline lens. Others, which live in darkness, have not even rudimentary eyes, as, for example, that curious fish (*Amblyopsis spelæus*), which lives in the Mammoth cave, and which appears to want even the orbital cavity. The crawfishes (*Astacus pellucidus*) of this same cavern are also blind; having merely the pedicle for the eyes, without any traces of facettes.

2. OF HEARING.

§ 145. To hear, is to perceive sounds. The faculty of perceiving sounds is seated in a peculiar apparatus, the EAR, which

is constructed with a view to collect and augment the sonorous vibrations of the atmosphere, and convey them to the acoustic or auditory nerve (fig. 45, *o*), which arises from the posterior part of the brain (fig. 20).

§ 146. The ears never exceed two in number, and are placed, in all the vertebrata, at the hinder part of the head. In

large proportion of animals, as the dog, horse, rabbit, and most of the mammals, the external parts of the ear are generally quite conspicuous, and as they are at the same time moveable, they become one of the prominent features of the physiognomy.

§ 147. These external appendages, however, do not, properly speaking, constitute the organ



Fig. 45.—Vertical Section of the Organ of Hearing in Man.—The internal parts are enlarged, to make them more evident. *a, b, c*, the external ear; *d*, the entrance to the auditory canal; *f, e, e*, petrous portion of the temporal bone, in which the internal ear is excavated; *g*, membrane of the tympanum; *h*, cavity of the tympanum, the chain of bones being removed; *i, j*, openings from the cavity into the cells, excavated in the bone; on the side opposite the membrana tympani are seen the foramen ovale and foramen rotundum; *k*, the Eustachian tube; *l*, the vestibule; *m*, the semicircular canals; *n*, the cochlea; *o*, auditory nerve; *p*, part of the glenoid fossa, for receiving the head of the lower jaw; *r*, the style-like process of the temporal bone, which gives attachment to muscles; *s*, the mastoid process of the temporal bone.

of hearing. The true seat of that sense is in the interior of the head. It is usually a very complicated apparatus, especially in the superior animals. In mammals it is composed of three parts; the external ear, the middle ear, and the internal ear, as shewn in fig. 45.

§ 148. The external ear consists of the *conch* (*a*), and the canal which leads from it, the *external auditory passage* (*c, d*). The first is a gristly expansion, in the form of a horn or a funnel, the object of which is to collect the waves of sound; for this reason, animals prick up their ears when they listen. The ear of man is remarkable for being nearly immoveable; therefore, persons whose hearing is deficient employ an artificial trumpet, by which they collect vibrations from a much more extended surface. The external ear is peculiar to mammals, and is wanting even in some aquatic species, such as the seals and the ornithorynchus.

§ 149. The *middle ear* has received the name of the *tympanic cavity* (*h*). It is separated from the auditory passage by a membranous partition, the *tympanum* or drum (*g*); though it still communicates with the open air by means of a narrow canal, called the Eustachian tube (*k*), which opens at the back part of the mouth. In the interior of the chamber, are four little bones of singular forms, which anatomists have distinguished by the names of *malleus* (fig. 49, *a*), *incus* (*b*), *stapes* (*d*), and *os orbiculare* (*c*); which are articulated together, to form a continuous chain.

Fig. 46.

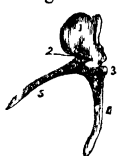

Fig. 47.



[The *malleus*, or hammer (fig. 46), has a rounded head (1), a smooth articular surface connected by a short neck (2) with the shaft of the bone, which has a short process (3). The shaft or handle (4) is lengthened and curved, and from the front thereof proceeds a long delicate process (5).

The *incus*, or anvil (fig. 47), resembles a bicuspid tooth; its head (1) is hollowed out to receive the head of the malleus; the short process (2) serves for the attachment of a ligament; and the long process (3) for its articulation with the orbicular bone, which is early soldered to it.

The *stapes*, or stirrup (fig. 48), is placed horizontally, with its base resting upon the foramen ovale, and its head articulated

with the round nodule at the extremity of the long process of the incus; the base of the bone (3) is of the same figure as the foramen; the lateral walls of the arch (2, 2) are connected by a membrane, and surmounted by a small head (1), which articulates with the os orbiculare. These four bones, when united together, form a chain, as shown

Fig. 48.



Fig. 49.

in fig. 49, where the membrane of the tympanum is seen at (1), and *a, b, c, d*, are the bones by which the membrane of the tympanum is connected with that of the foramen ovale, the handle of the malleus being attached to the tympanum, and the base of the stapes being applied to the vestibular membrane. The motions of this chain are regulated by four small muscles, three of which are inserted into the malleus, and one is attached to the stapes.—T. W.]



§ 150. The *internal ear*, which is also denominated the *labyrinth*, is an irregular cavity formed in the most solid part of the temporal bone, beyond the chamber of the middle ear, from which it is separated by a bony partition, and perforated by two small holes, called, from their form, the round and the oval apertures, the *foramen rotundum* and the *foramen ovale*,

l. (fig. 45). The first is closed by a membrane similar to that of the tympanum, while the latter is closed by the *stapes*.

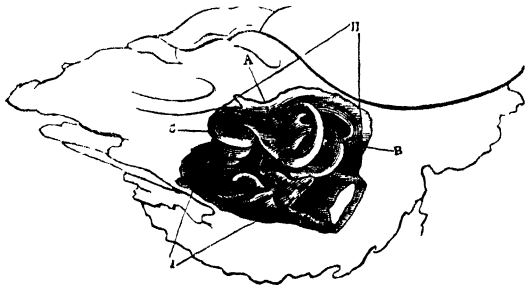

Fig. 50.—Relative situation of the Tympanum and Labyrinth

[The relative position of the *tympanum* and *labyrinth* is shown in figure 50. (1), is the tympanum, with its tubes

and bony chain; (1 1), A, the *labyrinth*, in which the nervous expansion floats; B, the semicircular canals; and C, the cochlea. The labyrinth is the true auditory organ, and is more or less developed wherever audition exists as a special sense. Comparative anatomy shows many phases of structure in this intricate apparatus.

[§ 151. The labyrinth is situated (fig. 45) *l, m*, in the most solid portion of the temporal bone: it consists of three portions (fig. 51); the vestibule (*a*); the semicircular canals (*b*); and the cochlea (*c*).

Fig. 51.—Views of Labyrinth.



[§ 152. The *vestibule* (Fig. 51, *a*) is placed at the inner side of the drum, with which it communicates by the oval hole (fig. 52, 11); it is surrounded by the cochlea and semicircular canals. This small chamber is about the size of a grain of wheat; into it open the five *ampullæ* of the semicircular canals (19, 19, 19, 19, 19); the opening for the passage of the auditory nerve (20); on

Fig. 52.—Vertical Section; internal surface.

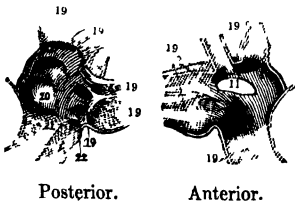

the fore and under part is a hole leading to the cochlea (21); and behind is the aqueduct of the vestibule (22).

Fig. 53.—Semicircular canals.

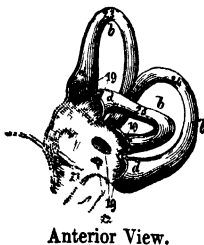

[§ 153. The *semicircular canals* (fig. 53, *b*) rise from the superior and posterior part of the vestibule, immediately behind the tympanum. They are three in number, in the form of tubes, with flask-like swellings at their extremities. From their position they are named the vertical, or superior (23); the oblique, or posterior (24); and the horizontal, or inferior (25). As two of the canals ter-

minate in a common orifice, there are only five openings from them into the vestibule. Fig. 54 exhibits a section of the semicircular canals.

Fig. 54.—Section of Canals.

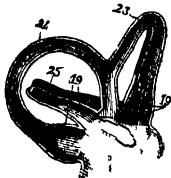

Anterior internal Surface.

Fig. 55.—Views of the Cochlea.

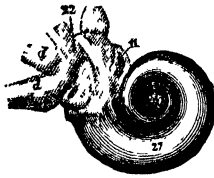

Base.

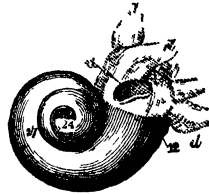

Apex.

[§ 154. The *cochlea* (fig. 51, c, and 55) is a singular organ, in form very like the shell of a garden snail. Its cavity (fig. 56) is divided by a longitudinal partition, half osseous and half membranous, called the spiral lamina (fig. 57, 29), which makes two and a-half turns round a central pillar, the *modiolus* (fig. 58, 26), the apex of which is called the *cupola* (28). One of these passages (fig. 57, 33) leads to the *foramen ovale* (22), of the vestibule, and is called *scala vestibuli*; the other (32) terminates in the *foramen rotundum* of the tympanum, and is called *scala tympani*. These passages are freely perforated, to give transit to filaments of the auditory nerve, which enters the cochlea through the cribriform base of the central pillar (fig. 58, 35). The whole of the internal ear is filled with a limpid fluid, *perilymph*, in which the membranous and nervous parts of the semicircular canals and cochlea are suspended. This *membranous labyrinth* contains a similar fluid, the *endolymph*.*—T. W.]



Fig. 56.—Anterior-internal surface of spiral tube; the lamina spiralis removed.

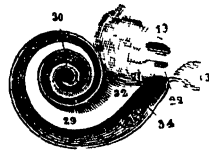
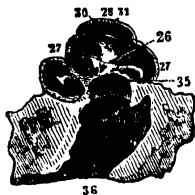

Fig. 57.—Lamina spiralis; the external shell of the cochlea removed.

§ 155. By this mechanism, the vibrations of the air are first collected by the external ear, whence they are conveyed along the auditory passage, at the bottom of which is the tym-

* The figures of the internal ear, the last excepted, are copied from Soëmmering.

panum. The tympanum, by its delicate elasticity, augments the vibrations, and transmits them to the internal ear, partly by



.g. 58.—Horizontal section through tube, lamina, modiolus, and meatus internus.

means of the little bones in the chamber, which are disposed in such a manner that the stapes exactly fits the oval aperture (*foramen ovale*); and partly by means of the air which strikes the membrane covering the round aperture (*foramen rotundum*), and produces vibrations there, corresponding to those of the tympanum. After all these modifications, the sonorous vibrations arrive at last at the labyrinth and the auditory nerve, which transmits the impression to the brain.

§ 156. The mechanism of hearing is not so complicated in all classes of animals, but is found to be more and more simplified, as we descend the series. In birds, the middle and internal parts of the ear are constructed on the same plan as in mammals, but the outer ear no longer exists, and the auditory passage, opening on a level with the surface of the head behind the eyes, is surrounded only by a circle of peculiarly formed feathers. The bones of the middle ear are also less numerous, there being generally but one.

[The owls have a large membranous crescentic fold, provided with tufts of short feathers, and which can be used as a valve. The largest ear-conch is met with in the long-tufted hibou (*Strix otus*). A true chain of ossicles may be distinguished in the tympanum, one of which is style-shaped and bony, while the others remain in a cartilaginous state. The principal bone represents the *stapes*: its base forms an oval plate, which is applied to the *foramen ovale*, and through this the sonorous vibrations are transmitted to the aqueous fluid of the labyrinth. Only one muscle can be detected for moving the ossicles, which is thought to represent the laxator of the tympanum. The labyrinth consists of compact bony walls, surrounded by spongy osseous tissue. The vestibule is small; the semicircular canals are large, and vary in size, being broad and elevated in rapacious and passerine birds, and thick and depressed in the gallæ, gallinæ, and palmipedes. The cochlea consists of a slightly curved osseous cone. In the membranous sac of the vestibule minute masses of crystallized phosphate of lime (*otoliths*) are found, as in mammals.—T. W.]

§ 157. In reptiles, the external ear disappears; the auditory passage is wanting, and the tympanum becomes external. In some toads, the middle ear also is completely wanting. The fluid of the vestibule is charged with salts of lime, which frequently give it a milky appearance, and which, when examined by the microscope, are found to be composed of an infinite number of crystals.

[The tympanic cavity is absent in the *proteus* and *salamander*, and both the skin and muscles are continued over the external ear. The foramen ovale is closed by a cartilaginous operculum, on which is inserted a style-shaped ossicle, called *columella*, regarded as the four bones soldered into one. The Eustachian tube is absent: the tympanic cavity is also absent in *serpents*. In *frogs* it consists of a membranous chamber, which commences by a funnel-shaped cartilaginous ring, upon which a naked *membrana tympani* is stretched. The *columella* rests its oval base on the foramen ovale, and its gristly head on the tympanum. In the *crocodile*, the rudiment of an external ear exists in the form of a tegumentary fold, containing a bony plate, and which can be made to shut down, like a valve, by a muscle. The internal ear presents numerous phases of development in the different groups of reptiles: in all it is lined by a membrane, and separated from the cranial cavity. The vestibule varies in form and size, and contains crystalline cretaceous masses, or otoliths: the semicircular canals expand into ampullæ: the cochlea is absent in frogs and salamanders, but exists in serpents, tortoises, and lizards, in the form of a hollow cone, with a blunt and dilated apex; it includes a pair of cartilages, covered by a plicated membrane, turned towards each other, and upon which the auditory nerve expands its delicate fibrils, as upon the lamina spiralis of the human ear.—T. W.]

§ 158. In fishes, the middle and external ear are both wanting; and the organ of hearing is reduced to a membranous vestibule, situated in the cavity of the skull, and surmounted by semicircular canals, from one to three in number. The liquid of the vestibule contains chalky concretions of irregular forms, the use of which is doubtless to render the vibration of sounds more sensible.

[The structure of the organ of hearing in this class exhibits an interesting series of gradations, ranging from the simple primitive type of the invertebrata, to the more complicated

mechanism described in amphibious reptiles. In osseous fishes, the membranous labyrinth lies for the most part full within the cranial cavity, and adjacent to the brain; or it is only imperfectly and partially enclosed in bones, as the skin and muscles are continued over the skull. The sonorous vibrations propagated by the water are communicated through the walls of the cranium, as no openings exist for the special reception of waves of sound. The labyrinth consists—1st, of a simple *vestibule*, or transparent sac, which receives the ampullæ of the arched canals, and is provided with nervous expansions: 2nd, the *auditory sac* is separated from the vestibule by a partition, and divided into two chambers, which, with the vestibule, contain the ossicles and calcareous parts, surrounded by the fluid of the labyrinth: 3rd, the *semicircular canals*, which are more or less developed in different genera, and open by ampullæ into the vestibule. In the *rays* and *sharks*, the labyrinth is separated from the cranial cavity, and imbedded in a mass of cartilage, which is more solidified around the membranous labyrinth. We find two openings, closed by membranes, on each side of the skull, which communicate with the internal ear, and represent the round and oval foramina of the labyrinth. Between each of these openings and the integument a membranous sac is placed, which is filled with a calcareous mass, and extends into the membranous vestibule. A pair of otoliths, composed of the carbonate of lime, are appended to the walls of the sacs. Osseous fishes are furnished with three of these concretions, almost as hard as porcelain: one is lodged in the vestibule, the others occupy the chambers of the sac. In the cyclostome fishes, as the petromyzon, the ear is simple, consisting of a cartilaginous part, and a pair of hard yellow oval capsules, connected with the skull, and enclosing, like a bony labyrinth, a membrane lining the same, and having interposed between them a fibro-membranous layer. The membrane of the labyrinth consists of a small sac, divided into two cells, two wide depressed semicircular canals, which enter the vestibule by one common ampulla, a rudimentary auditory sac, which appears as an appendage to the vestibule. The auditory nerve sends two branches to supply the labyrinth. In the myxine the ear is still more simple: the auditory capsule is filled with a membranous labyrinth, within which a single arched canal is blended with the vestibule. Otoliths and calcareous

salts are not found in the labyrinth of cyclostomes, although such bodies exist in the cuttle-fish, among the invertebrata. No vestige of an auditory organ has been detected in the amphioxus, which forms, in this respect, an exception to the law which prevails in all other vertebrata.—T. W.]

§ 159. In crabs, the organ of hearing is found at the lower surface of the head, at the base of the large antennæ. It is a bony chamber, closed by a membrane, in the interior of which is suspended a membranous sac, filled with fluid. On this sac the auditory nerve is expanded. In the cuttle-fish, the vestibule is a simple excavation of the cartilage of the head, containing a little membranous sac [and otolith], in which the auditory nerve terminates.

§ 160. Finally, some insects, as, for instance, the grasshopper, have an auditory apparatus, no longer situated in the head, as with other animals, but in the legs; and from this fact we may be allowed to suppose, that if no organ of hearing has yet been found in most insects, it is because it has been sought for in the head only.

[Much doubt exists as to the true seat of the organ of hearing in insects. Treviranus thought it was situated in *Blatta orientalis*, at the base of the antennæ. Ramdohr considered a vesicle placed at the base of the jaws of the bee as an organ of hearing. Straus-Durckheim thinks the seat of this sense in the cockchaffer is in the plates of the antennæ. D'Blainville thought that certain vesicles situate in the sides of the body, and covered by a membrane, were organs of audition. These differences of opinion about a matter of fact, is a proof that we as yet possess no certain knowledge of the true seat of this sense, although there can be no doubt that insects hear.—T. W.]

§ 161. It appears from these examples, that the part of the organ of hearing uniformly present, is that in which the auditory nerve ends; this, therefore, is the essential part of the organ. The other parts of the apparatus, the tympanum, auditory passage, and the semicircular canals, have for their object merely to aid, with more precision and accuracy, the perception of sound. Hence we may conclude, that the sense of hearing is dull in animals where the organ is reduced to its most simple form; and that animals, which have merely a simple membranous sac, without a tympanum and audi-

tory passage, as fishes, or without semicircular canals, as crabs, perceive sounds in a very imperfect manner.

3. OF SMELL.

§ 162. SMELL is the faculty of perceiving odours, and is a highly important sense in many animals. Like sight and hearing, smell depends upon special nerves, the *olfactory*, which form the first pair of cerebral nerves (fig. 20, *i*), and which, in the embryo, are direct prolongations of the brain.

§ 163. The organ of smell is the NOSE. Throughout the series of vertebrata it makes a part of the face, and in man, by reason of its prominent form, it becomes one of the dominant traits of his countenance; in other mammals, the nose, by degrees, loses this prominency, and the nostrils no longer open downwards, but forwards. In birds, the position of the nostrils is a little different; they open farther back, and higher up, at the origin of the beak.

§ 164. The nostrils are usually two in number—some fishes have four. They are similar openings, separated by a partition upon the middle line of the body. In man and the mammals, the outer walls of the nose are composed of cartilage; but internally, the nostrils communicate with cavities situated in the bones of the face and forehead. These cavities are lined by a thick membrane, the *pituitary*, on which are expanded the olfactory nerves, [and some filaments of the fifth pair.]

§ 165. The process of smelling is as follows. Odours are particles of extreme delicacy, which escape from very many bodies, and are diffused through the air. These particles make an impression on the nerves of smell, which transmit the impressions to the brain. To facilitate the perception of odours, the nostrils are placed in the course of the respiratory passages, so that many of the odours diffused in the air, which are inspired, pass over the pituitary membrane.

§ 166. The acuteness of the sense of smell depends on the extent to which that membrane is developed. Man is not so well endowed in this respect as many mammals, which have the internal surface of the nostrils extremely complicated. Such is especially the case among the carnivora.

§ 167. The sense of smell in reptiles is less delicate than in mammals; their pituitary membrane being less developed

Fishes are probably still less favored in this respect. As they perceive odours through the medium of water, we should anticipate that the structure of their apparatus would be different from that of animals which breathe air. Their nostrils are mere superficial pouches, lined with a membrane gathered into folds, which generally radiate from a centre, but are sometimes arranged in parallel ridges on each side of a central band. As the perfection of smell depends on the amount of surface exposed, it follows that those fishes which have these folds most multiplied are also those in which this sense is most acute.

§ 168. No special apparatus for smell has yet been found in the invertebrata. And yet there can be no doubt that insects, crabs, and some mollusca perceive odours, since they are attracted from a long distance by the odour of objects. Some of these animals may be deceived by odours similar to those of their prey; which clearly shows that they are led to it by this sense. The carrion fly will deposit its eggs on plants which have the smell of tainted flesh.

4. OF TASTE.

§ 169. TASTE is the sense by which the flavour of bodies is perceived. That the flavour of a body may be perceived, it must come into immediate contact with the nerves of taste, and hence these nerves are distributed at the entrance to the digestive tube, on the surface of the tongue and the palate. By this sense animals are guided in the choice of their food, and warned to abstain from what is noxious. There is an intimate connexion between taste and smell, so that both these senses are called into requisition in the selection of food.

§ 170. The nerves of taste are not so strictly special as those of sight and hearing. They do not proceed from one single trunk; and, in the embryo, do not correspond to a particular part of the brain. The tongue receives nerves from several trunks; and taste is perfect in proportion as the nerves which go to the tongue are more minutely distributed. The extremities of the nerves generally terminate in the little asperities of the surface, called *papillæ*. Sometimes these papillæ are very harsh, as in the cat and the ox; and, again, they are very delicate, as in the human tongue, in that of the dog, horse, &c.

§ 171. Birds have the tongue cartilaginous, sometimes be-

set with little stiff points; sometimes fibrous, and fringed at the edges. In the parrots, it is thick and fleshy; or it is even barbed at its point, as in the woodpeckers. In some reptiles, the crocodile, for example, the tongue is adherent; in others, on the contrary, it is capable of extensive motion, and serves as an organ of touch, as in the serpents; or it may be thrust out to a great length, to take prey, like that of the chameleon, toad, and frog. † In fishes it is usually cartilaginous, as in birds, and is generally adherent, and has its surface frequently covered with teeth.

§ 172. It is to be presumed, that in animals which have a cartilaginous tongue, the taste must be very obtuse, especially in those which, like most fishes, and many granivorous birds, swallow their prey without mastication. In fishes, especially, the taste is very imperfect, as is proved by their readily swallowing artificial bait. It is probable that they are guided in the choice of their prey by sight, rather than by taste or smell.

§ 173. Some of the inferior animals select their food with no little discernment. Thus, flies will always select the sugary portions of bodies. Some of the mollusca, as the snails, for example, are particularly dainty in the choice of their food. In general, taste is but imperfectly developed, except in mammals, and they are the only animals which appear to enjoy the flavour of their food. With man this sense, like others, may be greatly improved by exercise; and it is capable of being brought to a high degree of delicacy.

5. OF TOUCH.

§ 174. The sense of TOUCH is merely a peculiar manifestation of the general sensibility, seated in the skin, and dependent upon the nerves of sensation which expand over the surface of the body. By the aid of this general sensibility, we learn whether a body is hot or cold, wet or dry. We may also, by simple contact, gain, to a certain extent, an idea of the form and consistence of a body, as, for example, whether it be sharp or blunt, soft or hard.

§ 175. This faculty resides more especially in the hand, which is not only endowed with a more delicate tact, but, owing to the disposition of the fingers, and the opposition of the thumb to the others, is capable of so moulding itself around objects, as to multiply the points of contact. Hence

touch is an attribute of man rather than of other animals ; for among these latter, scarcely any, except the monkeys, have the faculty of touch in their hands, or, as it is technically termed, of *palpation*.

§ 176. In some animals, this faculty is exercised by other organs. Thus the trunk of the elephant is a most perfect organ of touch ; and probably the mastodon, whose numerous remains are found scattered in the superficial layers of the earth's crust, was furnished with a similar organ. Serpents make use of their tongue for touch ; insects employ their palpi, and snails their tentacles for the same purpose.

6. THE VOICE.

§ 177. Animals have not only the power of perceiving, but many of them have also the faculty of producing sounds of every variety, from the roaring of the lion to the song of the bird as it salutes the rising sun. It is moreover to be remarked, that those which are endowed with a voice, likewise have the organ of hearing well developed.

§ 178. Animals employ their voice, either for communication with each other, or to express their sensations, enjoyments, or sufferings. Nevertheless, this faculty is possessed by a small minority of animals : with but very few exceptions, only mammals, birds, and a few reptiles, are endowed with it. All others are dumb. Worms and insects have no true voice ; for we must not mistake for it the buzzing of the bee, which is merely a noise created by the vibration of the wings ; nor the grating shriek of the locust, caused by the friction of his legs against his wings ; nor the shrill noise of the cricket, or the tell-tale call of the ratydid, produced by the friction of the wing covers on each other. And in numerous similar cases which might be cited.

§ 179. Consequently, were mammals, birds and frogs, to be struck out of existence, the whole animal kingdom would be dumb. It is difficult for us, living in the midst of the thousand various sounds which strike the ear from all sides, to conceive of such a state. Yet, such a state did doubtless prevail for thousands of ages on the surface of our globe, when the watery world alone was inhabited, and before man, the mammals, and birds were called into being.

§ 180. In man and the mammals, the voice is formed in an organ called the *larynx*, situated at the upper part of the windpipe, below the bone of the tongue (*a*).

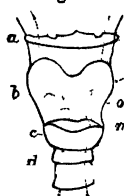

The human larynx, the part called Adam's apple, is composed of several cartilaginous pieces, called the thyroid cartilage (*b*), the cricoid cartilage (*c*), and the small arytenoid cartilages. Within these are found two large folds of elastic substance, known by the name of the *vocal cords* (*m*). Two other analogous folds, the *superior ligaments of the glottis* (*n*), are situated a little above the preceding. The glottis (*o*) is the space between these four folds. The arrangement of the vocal cords, and of the interior of the glottis in man, is indicated by dotted lines in fig. 59.

§ 181. The mechanism of the voice is as follows: the air, on its way to the lungs, passes the vocal cords. So long as these are in repose, no sound is produced; but the moment they are made tense, they narrow the aperture, and oppose an obstacle to the current of air, and it cannot pass without causing them to vibrate. These vibrations produce the voice; and as the vocal cords are susceptible of different degrees of tension, these

Fig. 60.

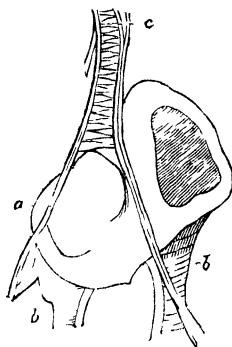

tensions determine different sounds; giving an acute tone when the tension is great, and a grave and dull one when the tension is feeble.

§ 182. Some mammals have, in addition, large cavities which communicate with the glottis, and into which the air reverberates, as it passes the larynx. This arrangement is especially remarkable in the howling monkeys, which are distinguished above all other animals, for their deafening howls.

§ 183. In birds, the proper larynx is very simple, destitute of vocal cords, and incapable of producing sounds; but at the lower end of the windpipe there is a second or inferior larynx, which is very complicated in structure. It is a kind of bony drum (fig. 60 *a*), having within it two glottides,

formed at the top of the two branches (*b, b*) of the windpipe (*c*), each provided with two vocal cords. The different pieces of this apparatus are moved by peculiar muscles, the number of which varies in different families. In birds which have a very monotonous cry, such as the gulls, the herons, the cuckoos, and the margansers (fig. 60), there is but one or two pairs; parrots have three; and the birds of song have five.

§ 184. Man alone, of all the animal creation, has the power of giving, to the tones he utters, a variety of definite or articulate sounds; in other words, he alone has the gift of speech.

CHAPTER FOURTH.

OF INTELLIGENCE AND INSTINCT.

§ 185. BESIDES the material substance of which the body is constructed, there is also an immaterial principle, which, though it eludes detection, is none the less real, and to which we are constantly obliged to recur in considering the phenomena of life. It originates with the body, and is developed with it, while yet it is totally apart from it. The study of this inscrutable principle belongs to one of the highest branches of philosophy; and we shall here merely allude to some of its phenomena which elucidate the development and rank of animals.

§ 186. The *constancy of species* is a phenomenon depending on the immaterial nature. Animals, and plants also, produce their kind, generation after generation. We shall hereafter show that all animals may be traced back, in the embryo, to a mere point in the yolk of the egg, bearing no resemblance whatever to the future animal, and no inspection could enable us to declare with certainty what that animal is to be; but even here, an immaterial principle is present, which no external influence can modify, and which determines the growth of the future being. Essentially the egg of the hen, for instance, cannot be made to produce any other animal than a chicken; and the egg of the cod-fish produces only the cod. It may therefore be said with truth, that the chicken and the cod existed in the egg before their formation as such.

§ 187. PERCEPTION is a faculty springing from this principle. The organs of sense are the instruments for receiving sensations, but they are not the faculty itself, without which they would be useless. We all know that the eye and ear may be open to the sights and sounds about us, but if the mind happens to be preoccupied, we perceive them not. We

may even be searching for something which actually lies within the compass of our vision ; the light enters the eye as usual, and the image is formed on the retina ; but, to use a common expression, we look without seeing, unless the mind that perceives is directed to the object.

§ 188. In addition to the faculty of perceiving sensations, the higher animals have also the faculty of recalling past impressions, or the power of *memory*. Many animals retain a recollection of the pleasure or pain that they have experienced, and seek or avoid the objects which may have produced these sensations ; and in doing so, they give proof of *judgment*.

§ 189. This fact proves that animals have the faculty of comparing their sensations and of deriving conclusions from them ; in other words, that they carry on a process of *reasoning*.

§ 190. These different faculties, taken together, constitute *intelligence*. In man, this superior principle, which is an emanation of the divine nature, manifests itself in all its splendour. God “breathed into him the breath of life, and man became a living soul.” It is man’s prerogative, and his alone, to regulate his conduct by the deductions of reason ; he has the faculty of exercising his judgment not only upon the objects which surround him, and of apprehending the many relations which exist between himself and the external world ; but he may also apply his reason to immaterial things, observe the operations of his own intellect, and, by the analysis of his faculties, may arrive at the consciousness of his own nature, and even conceive of that Infinite Spirit, “whom none by searching can find out.”

§ 191. Other animals cannot aspire to conceptions of this kind ; they perceive only such objects as immediately strike their senses, and are incapable of continuous efforts of the reasoning faculty in regard to them. But their conduct is frequently regulated by another principle of inferior order, called *INSTINCT*, still derived from the immaterial principle.

§ 192. Under the guidance of instinct, animals are enabled to perform certain operations, in one undeviating manner, without instruction. When man chooses wood and stone, as the materials for his dwelling, in preference to straw and leaves, it is because he has learned by experience, or because his associates have informed him that these materials are

more suitable for the purpose. But the bee requires no instructions in building her comb. She selects at once the fittest materials, and employs them with the greatest economy; and the young bee exhibits, in this respect, as much discernment as those who have had the benefit of long experience. She performs her task without previous study, and, to all appearance, without the consciousness of its utility, being in some sense impelled to it by a blind impulse.

§ 193. If, however, we judge of the instinctive acts of animals, when compared with the acts of intelligence, by the relative perfection of their products, we may be led into gross errors, as a single example will show. No one will deny that the honey-comb is constructed with more art and care than the huts of many tribes of men. And yet, who would presume to conclude from this, that the bee is superior in intelligence to the inhabitant of the desert or of the primitive forest? It is evident, on the contrary, that in this particular case we are not to judge of the artisan by his work. As a work of man, a structure as perfect in all respects as the honey-comb would indicate very complicated mental operations, and probably would require numerous preliminary experiments.

§ 194. The instinctive actions of animals relate either to the procuring of food, or to the rearing of their young; in other words, they have for their end the preservation of the individual and of the species. It is by instinct that the leopard conceals himself, and awaits the approach of his prey. It is equally by instinct that the spider spreads his web to entangle the flies which approach it.

§ 195. Some animals go beyond these immediate precautions; their instinct leads them to make provision for the future. Thus the squirrel lays in his store of nuts and acorns during autumn, and deposits them in cavities of trees, which he readily finds again in winter. The hamster digs, by the side of his burrow, compartments for magazines, which he arranges with much art. Finally, the bee, more than any other animal, labours in view of the future; and she has become the emblem of order and domestic economy.

§ 196. Instinct exhibits itself, in a no less striking manner, in the anxiety which animals manifest for the welfare of their anticipated progeny. All birds build nests for the shelter and nurture of their young, and in some cases these nests are

made exceedingly comfortable. Others show very great ingenuity in concealing their nests from the eyes of their enemies, or in placing them beyond their reach. There is a small bird in the East Indies, the tailor bird (*Sylvia sutoria*), which works wool or cotton into threads, with its feet and beak, and uses it to sow together the leaves of trees for its nest.

§ 197. The nest of the fiery hang-bird (*Icterus Baltimore*), dangling from the extremity of some slender, inaccessible twig, is familiar to all. The beautiful nest of the humming-bird, seated on a mossy bough, and itself coated with lichen, and lined with the softest down from the cotton-grass or the mullein leaf, is calculated equally for comfort and for escaping observation. An East Indian bird, (*Ploceus Philippinus*,) not only exhibits wonderful devices in the construction, security, and comfort of its nest, but displays a still further advance towards intelligence. The nest is built at the tips of long pendulous twigs, usually hanging over the water. It is composed of grass, in such a manner as to form a complete thatch. The entrance is through a long tube running downwards from the edge of the nest; and its lower end is so loosely woven, that any serpent or squirrel attempting to enter the aperture, would detach the fibres, and fall to the ground. The male, however, who has no occasion for such protection, builds his thatched dome similar to that of the female, and by its side; but simply makes a perch across the base of the dome, without the nest-pouch or tube.

§ 198. But it is among insects that this instinctive solicitude for the welfare of the progeny is every where exhibited in the most striking manner. The bees and wasps not only prepare cells for each of their eggs, but take care, before closing the cells, to deposit in each of them something appropriate for the nourishment of the future young.

§ 199. It is by the dictate of instinct, also, that vast numbers of animals of the same species associate, at certain periods of the year, for migration from one region to another; as the swallows and passenger pigeons, which are sometimes met with in countless flocks.

§ 200. Other animals live naturally in large societies, and labour in common. This is the case with the ants and the bees. Among the latter, even the kind of labour for each member of the community is determined beforehand, by in-

instinct. Some of them collect only honey and wax, others are charged with the care and education of the young, whilst others are the natural chiefs of the colony.

§ 201. Finally, there are certain animals so guided by their instinct as to live like pirates, on the fruits of others' labour. The lestris or jager will not take the trouble to catch fish for itself, but pursues the gulls, until, worn out by the pursuit, they eject their prey from their crop. Some ants make war upon others less powerful, take their young away to their nests, and oblige them to labour in slavery.

§ 202. There is a striking relation between the volume of the brain, compared with the size of the body, and the degree of intelligence which an animal may attain. The brain of man is the most voluminous of all, and among other animals there is every gradation in this respect. In general, an animal is the more intelligent, in proportion as its brain bears a greater resemblance to that of man.

§ 203. The relation between instinct and the nervous system does not present so intimate a correspondence as exists between the intellect and the brain. Animals which have a most striking development of instinct, as the ants and bees, belong to a division of the animal kingdom where the nervous system is much less developed than that of the vertebrata, since they have only ganglia, without a proper brain. There is even a certain antagonism between instinct and intelligence, so that instinct loses its force and peculiar character whenever intelligence becomes developed.

§ 204. Instinct plays but a secondary part in man; he is not, however, entirely devoid of it. Some of his actions are prompted by instinct, as, for instance, the attempts of the infant to nurse. The fact again, that these instinctive actions mostly belong to infancy, when intelligence is but slightly developed, goes to confirm the two last propositions.

CHAPTER FIFTH.

OF MOTION.

SECTION I.

APPARATUS OF MOTION.

§ 205. THE power of voluntary motion is the second grand characteristic of animals (§ 65). Though they may not all have the means of transporting themselves from place to place, there is no animal which has not the power of executing some motions. The oyster, although fixed to the ground, opens and closes its shell at pleasure; and the little coral animal protrudes itself from its retreat, and retires again at its will.

§ 206. The movements of animals are affected by means of *muscles*, which are organs designed expressly for this purpose, and make up that large portion of the body, commonly called *flesh*. They are composed of a series of bundles, which are readily seen in boiled meat. These bundles are again composed of parcels of still more delicate fibres, called *muscular fibres* (§ 215), which have the property of elongating and contracting.

§ 207. The motions of animals and plants depend, therefore, upon causes essentially different. The expansion and closing of the leaves and blossoms of plants, which are their most obvious motions, are due to the influence of light, heat, moisture, cold, and other external agents; but all the motions peculiar to animals are produced by an agency residing within themselves, namely, the *contractility* of muscular fibres.

§ 208. The cause which excites contractility resides in the nerves, although its nature is not precisely known. We only know that each muscular bundle receives one or more nerves, whose filaments pass at intervals across the muscular fibres. It has also been shown, by experiment, that when a nerve entering a muscle is severed, the muscle instantly loses its power of contracting, under the stimulus of the will, or, in other words, is paralyzed.

§ 209. The muscles may be classified according as they are more or less under the control of the will. The contractions of some of them are entirely dependent on the will, as in the muscles of the limbs which are used for locomotion. Others are quite independent of it, like the contractions of the heart and stomach. The muscles of respiration ordinarily act independently of the will, but are partially subject to it; thus, when we attempt to hold the breath, we arrest, for the moment, the action of the diaphragm.

[§ 210. The movements of animals are therefore divided into VOLUNTARY and INVOLUNTARY; the immediate agent of the former is the muscular tissue, which is most intimately associated with the nervous system, and is brought thereby under the control of the will. The motions characterised as involuntary, are for the most part effected by means of muscular tissue; but the fibres of the involuntary muscles present histological characters, which distinguish them from that of the voluntary class. The muscular tissue passes by insensible gradations into other forms of contractile fibrous tissue, so that it is difficult to define the limits between them.

[§ 211. Besides muscular movements, animals execute motions which appear to be altogether independent either of the muscular or the nervous systems. These are called CILIARY MOTIONS; they are most extensively performed, and may be best studied in the lowest classes of the invertebrata, although they take place in connection with some of the organic functions in all.

[§ 212. When studied by the aid of the microscope, with a quarter of an inch object-glass, true muscular fibres present two distinct histological forms. 1st. The simple unstreaked fibrillæ of organic life. 2nd. The compound streaked fibrillæ of animal life.

[§ 213. The first class consists of pale-coloured smooth cylindrical fibres, arranged parallel to each other, and forming bundles connected by a delicate cellular tissue. This class is met with in the form of layers, investing the hollow organs, as the stomach, intestines, and bladder; it is likewise found surrounding the excretory ducts of the larger glands, and enters into the structure of the veins. The ultimate fibrillæ are estimated at about 1-1000th of a line in diameter.

[§ 214. The second class consists of fibrillæ mostly of a red

colour, which, when separated and examined by the microscope, exhibit an infinite number of cross streaks. All the muscles known as voluntary; the muscles of the eye-ball, the internal ear, tongue, and palate, a great part of the esophagus, the diaphragm, the sphincters, and those of the trunk and extremities, belong to this class. The muscular fibres of the heart are, however, faintly streaked, although this organ occupies the centre of the system of organic life. Cross-streaked muscles are found in many of the invertebrated classes; they are well seen in insects, crustacea, and spiders, and may be observed in the fibrous layer on the under side of the umbrella of some medusæ. In various animals, however, possessing voluntary motions, the simple class of muscular fibres is only observed; but it may be assumed as a general proposition, subject, however, to some exceptions, that the streaked muscles belong to the system of animal life, and the unstreaked muscles to that of organic life, and that the former are developed from the serous, the latter from the mucous layer of the germinal membrane.

[§ 215. Much difference of opinion exists as to the cause of the cross streaks observed in the fibrillæ of voluntary muscles. We refer to the works of Wagner, Valentin, Bowman, and others for a statement of their various opinions, and proceed to describe the appearance presented by a beautiful preparation of a portion of one of the voluntary muscles of a pig in fluid now before me, viewed with one-eighth of an inch object-glass, each fibrilla appears to be composed of an investing membrane or *sarcolemma*, from which transverse processes extend across the tube, dividing it into a number of square discs; these cells or discs, it is presumed, are occupied by the primitive substance of the muscular tissue; the discs are of a rectangular form, and have the same dimensions in the long as in the transverse diameter; in those fibrillæ which are stretched the discs appear oblong, but in one unstretched fibril, which lies most advantageously for observation, the diameters are equal; the ultimate fibre of muscular tissue therefore, appears to consist of a longitudinal row of rectangular discs placed end to end, as seen in Figs. 60 and 63. A number of fibrillæ united by delicate tissue form a *primitive fasciculus*, and many fasciculi united by areolar tissue, make the common fibres of muscle as seen by the naked eye. From this arrangement of

the fasciculi into fibres, we can readily understand one feature of voluntary muscle—the tendency which it shews to separate in the longitudinal direction by a kind of natural cleavage. The following figures from Wagner illustrate most clearly the different forms of muscular tissue.—T. W.]

Fig. 60.

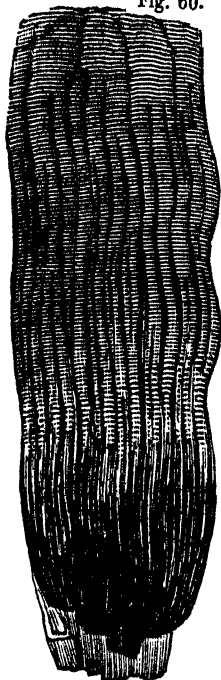

In Fig. 60 we have a fresh muscular fasciculus of the ox, one-thirtieth of a line in thickness. The upper extremity of the bundle exhibits transverse striæ only; but they appear to fail here and there, and these gaps seem as if they separated fibrils or bundles of fibres at some little distance from one another; the opposite or lower end of the fasciculus, on the contrary, shows nothing but longitudinal striæ or primitive fibrils, an effect which is entirely due to the focussing of the microscope. At the place where the muscular bundle is torn through (inferiorly) a scaleform appearance is perceived very beautifully brought out by the different layers of the primitive fibrils, which have contracted again in different degrees after yielding to the tearing force; in the middle of the specimen the microscope is so focussed that transverse and longitudinal striæ are perceived at the same time; here the former, there the latter, more distinctly, according to the difference of level of the surface of the fibre examined. The transverse striæ are in a general way extremely constant, and a highly characteristic indication of the muscular fibre of animal life; so that the smallest portion of a muscle belonging to this system is at once recognized under the microscope by their presence. The transverse striæ, however, become extremely faint under many circumstances; in bodies with very soft or flabby muscles, and in very young

animals, for example; but even here they are often very distinct, and are readily studied in the living larva of the frog, near to the spinal column in the tail. They are very distinct in boiled and roasted meat, and in muscle that has been macerated in spirit (Fig. 61, 62, B), in which, indeed, they often present themselves as absolute transverse rugæ, with lateral notchings, so that we should be very apt to suppose that a peculiar sheath enveloped the muscular bundles, a supposition which gains strength from the fact, that towards the torn ends of the specimen, the primitive fibrils are often seen free, isolated, and without any appearance of cross-barring (Fig. 62, A). On the other hand, however, we frequently recognize the

CILIARY MOTIONS.

[§ 216. We have already stated that ciliary motions take place independent of either the muscular or nervous systems (§ 211). transverse streaking upon the several isolated primitive fibrils (Fig. 63, A. and B). It would seem that transverse sections ought to supply the surest grounds for conclusions; but no such thing as a sheath can ever

Fig. 61.

Fig. 61.—Structure of human muscle; a portion of the attollens auriculæ, which had been long kept in spirit. A, A number of primary muscular fasciculi magnified about 200 diameters. B, A single fasciculus more highly magnified. C, Some fibres of cellular tissue interposed between the muscular fasciculi.

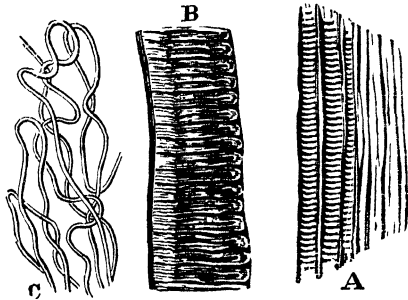
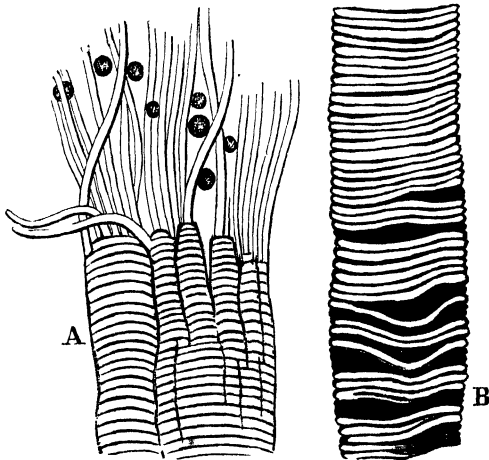

Fig. 62.

Fig. 62.—Muscular fibre, after Skey. (*Philos. Trans.* 1837.) A, Fibra Muscularis—primitive muscular fasciculus. Superiorly the primitive fibres are separated from each other; the globules are blood-discs to serve as standards for the estimation of their diameter. B, A primitive muscular fibre, to show how the transverse striæ are produced, and that they may be severally seen as elevations.



The peculiar motory phenomena that fall under this class were known to the older naturalists, but their more successful investigation was reserved for our day.

Ciliary motions may be most conveniently studied with the microscope, on portions of the mucous membranes; that from the mouth of the frog is most readily obtained, placed on a glass slide in a drop of water, then covered with a small piece of thin glass, and viewed with a fourth or an eighth of

with certainty be shown in the circumference of the muscular fibres, however prepared by hardening, &c. The intimate structure is excellently displayed, both by Bowman and Henle, as also in the accompanying figures.

Fig. 63.

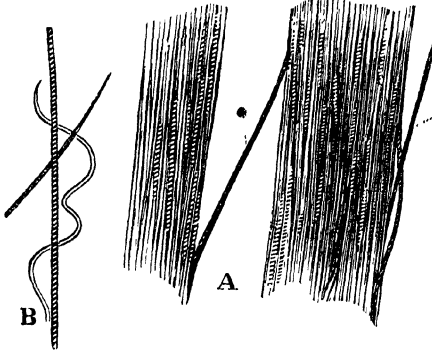

Fig. 63.—Two primary muscular fasciculi from the dorsal muscles of a rattle-snake, which had been long kept in spirits. At * and * fine fibres are seen distinctly brought into view by separating the muscular bundles; they seem each to consist of several or ultimate fibres.

B, Two of these fine filaments, seen under a power of 800, which exhibit crossmarkings. The sinuous filament is cellular tissue.

Fig. 64.

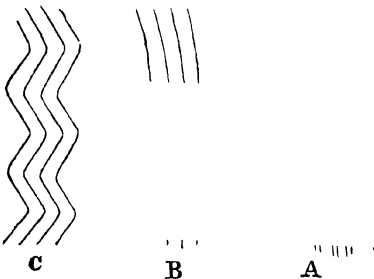

Fig. 64.—A, A bundle of fibres without cross striæ, from the adductor muscle which closes the shell of *Unio pictorum*. B, A muscular bundle without cross-streaking from the *Distoma duplicatum*. C, The same bundle thrown into zig-zags at the moment of contraction.

If we take a small piece of the margin of the mantle, or a I particularly recommend the muscular elements of the dorsal vessel or heart of *Scolopendra* for the study of the natural resolution of the muscular fasciculi into fibres, and of their termination in elastic tissue. (Vide Fig. 66.)

Fig. 65.—Muscular fibre from the esophagus, about three inches below the pharynx, to show the union of muscular fibres of the animal (*a, a*) and of the organic (*b, b*) life, after Skey. *B*, Plan figure of the spiral fibre, which, according to some, surrounds the primary muscular fasciculi, and gives the appearance of cross-streaking. After Mandl, *Anat. Microscop.*

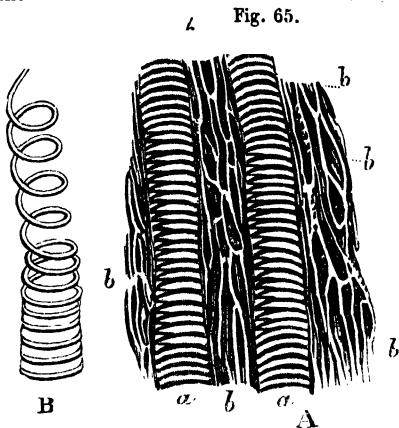

Fig. 66.

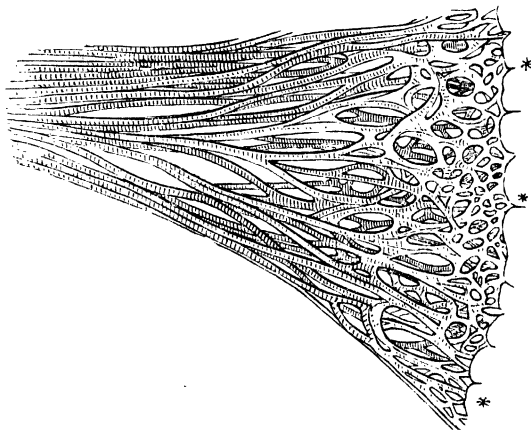

Fig. 66.—A piece of a wing-shaped muscle from the *Scolopendra Afra*, inserted at * * * into the dorsal vessel of the insect. The transition of the striated muscular fasciculi into a net of elastic tissue is very beautifully displayed.

portion of the gills of the fresh-water mussel (*Anodon cygneus*), it will be found to exhibit cilia and their motions to great advantage; viewed with a quarter of an inch object-glass, the

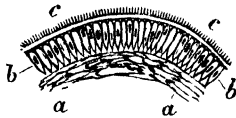

Fig. 67.*
 the cilia are then seen to consist of delicate filaments like hairs, set more or less regularly in rows, and moved with rapidity. In this mollusk, the cilia are about 1-100th of a line in length, as seen in (c, c), and are set upon rounded cells (b, b), as upon bulbs; their motion is hook-like, or,

in other words, the point of each cilia successively bends towards its base, and is rapidly stretched out again. These motions are performed more or less vividly in different animals, and in different states of the same animal. The infusoria (fig. 171) exhibit this phenomenon in an admirable manner; the surface of their bodies is covered with rows of cilia, which perform various motions; a great number of the embryos of sponges, polyps, acalophæ (fig. 368), and mollusca are covered with vibratile cilia during the first periods of their existence, and these microscopic filaments play an important part in many of the organs of the invertebrata. The sides of the bodies of beroes, and the tentacula of medusæ, exhibit these motions; they are seen in the interior of the tentacula of *Actinia* and other ZOANTHIDÆ; on the oral lobes of the rotifera (fig. 172); on the exterior of the tentacula of *Flustra*, *Alcyonella*, and other BRYOZOIDÆ (fig. 175); the membrane lining the test of urchins, CIDADIDÆ, and sea-stars, ASTERIIDÆ; the anterior parts of the bodies of the fresh-water mollusca, and the branchiæ of all univalve and bivalved genera, with those of cirripedes and crustacea (fig. 370), are provided with vibratile cilia.

In the vertebrated animals ciliary motions are seen on many parts of their bodies. On the mucous membrane covering the gills of the tadpoles of frogs and salamanders, and on the respiring organs as well as on the membrane lining the mouth, fauces, and nasal passages of amphibia, reptiles, birds, and mammals. Ciliary motions are intended to renew the stratum of water or air bathing the surface covered by these

* There ought to be no space betwixt the epithelial cylinders that support the cilia, and the cilia themselves, as in the above figure, which is a mistake of the artist; they are immediately sessile upon the epithelium, as in the plan (fig. 68).

filaments, they thus become important aids to the due performance of the function of respiration in the invertebrate classes; and are the chief agents by which it is performed in the subkingdom radiata.

[§ 217. The most singular fact connected with the history of ciliary motions, is their independence of the nervous system, or even of the life of the organism itself. In the fresh-water mussel, ciliary motions are observed for many days on the surface of the membranes detached from the body, even when the putrefactive process has considerably advanced, and the same fact has been observed on the mucous membranes of decapitated tortoises; but in birds and mammals, they cease in a few hours after death. Wherever ciliary motions have been detected, cilia are seen as their instruments. Set upon a particular form of cylinder-epithelium, composed of closely arranged conical cells, implanted perpendicularly upon the subjacent tissues (fig. 68), each cell supporting from six to eight cilia upon its free summit (*b, b, b*), and containing internally a distinct nucleated nucleus (*c, c, c*); the cilia and nucleated cells are deciduous formations, and are cast off and rapidly reproduced. The functions of this form of epithelium are still obscure, and we know nothing of the cause and the mechanism of the motions of the cilia.—T. W.]

Fig. 68.

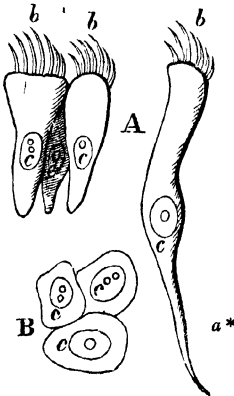

Fig. 68.—Some of the cylindrate epithelial cells are produced inferiorly into a point, *a**, in which case the nucleus, *c*, occurs about the middle of the formation. *B*, is a transverse section of the nuclei and nucleoli. To obtain a view of the ciliary motions in man, we have but to draw the extremity of the handle of the scalpel over the mucous membrane of the nose, and to transfer the mucus thus obtained, properly prepared, to the stage of the microscope; it rarely happens that one or more epithelial cylinders with active cilia are not discovered. The tessular epithelium of the mucous membrane of the mouth may be procured by lightly scraping the inner surface of the cheek, and should be examined at the same time, by way of contrast.—WAGNER.]

§ 218. In the great majority of animals, motion is aided by the presence of solid parts, of a bony or horny structure, which either serve as firm attachments to the muscles, or, being arranged to act as levers, they increase the force and precision of the movements. The solid parts are usually so constructed as to form for the body a substantial frame-work, which has been variously designated in the several classes of animals, the *test*, *shell*, *carapace*, and *skeleton*. The study of these parts is one of the most important branches of comparative anatomy, as their characters are the most constant and enduring of all others. Indeed, these solid parts are nearly all that remain to us of the numerous extinct races of animals of

Fig. 69.

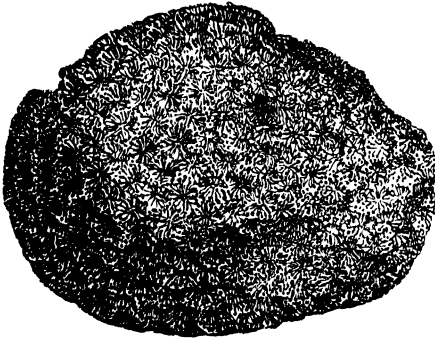
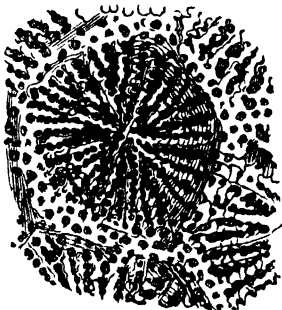

Fig. 70.

Figs. 69 and 70.--*Litharæa Websteri*. tertiary sands of Bracklesham Bay,

past geological eras; and from these alone, we are enabled to determine the structure and character of the ancient fauna.

§ 219. Most of the radiata have a calcareous test or shell. In the polyps, this structure, when it exists, is usually very solid, sometimes assuming the form of a simple interal skeleton, or forming extensively branched stems, as in the sea-fans; and sometimes solid masses, furnished at the sides with numerous cavities, in which the animals are lodged, with the power, however, of protruding and retracting themselves at pleasure, by means of their muscles, as in the corals.

[*Litharæa Websteri* (fig. 69) is a fossil coral, from the

showing the skeleton of one of these lithophytes. The natural size of the polypary is seen at fig. 69, and a magnified view of one of the cells, with its rays, is given in fig. 70.]

In the echinoderms, the test is brittle, and intimately united with the soft parts. It is composed of numerous little plates, sometimes consolidated and immoveable, as in the sea-urchins, or combined, so as to allow of various motions, as in the star-fishes (fig. 36), and in the sea-lilies (figs. 72 and 73), which use their arms both for crawling and swimming.

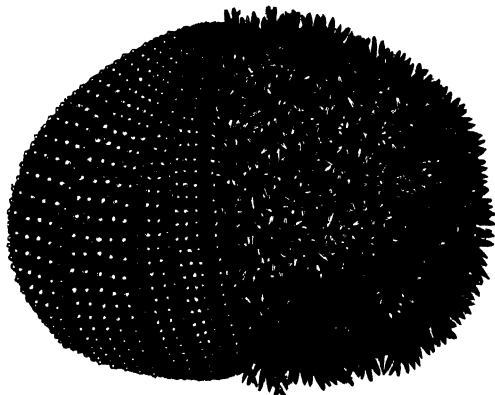

Fig. 71.—The test of an *Echinus*. On the right side are seen the spines and tubular suckers: on the left side, those parts have been removed, to show the surface of the test, composed of the ambulacral area, with the small plates, and poriferous avenues at their margins, and the interambulacral area, composed of the large polygonal plates. The plates of both areas being covered with tubercles, for supporting spines.

[In the ECHINIDÆ, or sea urchins, the test is of a spherical or pentagonal form, constructed of many series of calcareous polygonal plates articulated together, and divided into two groups, of which five form the ambulacral areas, and five the interambulacral areas, each area being composed of two columns of plates (fig. 71 and 174, *d*, *e*). The ambulacral alternate with the interambulacral areas, and they are separated from each other by ten rows of small perforated plates, through the holes of which numerous tubular retractile suckers pass: the

mouth occupies the base of the test; the opening is of a circular or decagonal form, in which a complicated mechanism of five jaws and five teeth, with their muscles, are lodged (figs. 190 and 191). The anus in this group opens at the vertex of the test; the opening is surrounded by a circle of ten plates, five of which are perforated to give passage to ducts from the genital organs, and called *ovarial plates*, and five are perforated for lodging the eyes, and called *ocular plates*. The surface of the ambulacral and interambulacral plates is covered with tubercles of various sizes, in general raised upon prominent eminences, the tubercles having a round smooth head, to which a spine with a concave base is fitted and moved by muscles; the entire surface of the test and spines is covered by an organised skin; the skeleton therefore is enclosed in membranes, participating in the life and growth of the animal, and forming an integral part of the urchin.

In the ASTERIADEÆ, or sea stars (figs. 36 and 373), a similar complicated skeleton exists, with this difference, that the ambulacral and interambulacral areæ, instead of being united to form a hollow case, are stretched out into rays, at the ex-

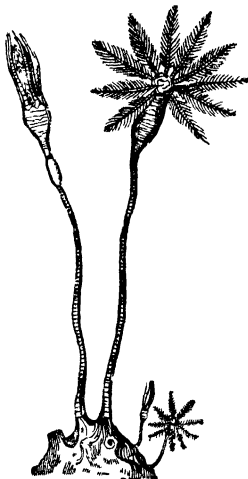

Fig. 72.—*Apiocrinus rotunda*.

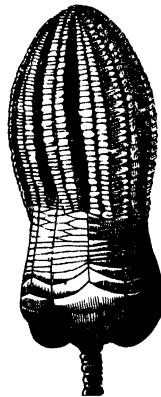

Fig. 73.—*Encrinurus moniliformis*.

tremity of which the eyes are situated, corresponding to their position in the echinidæ; the summits of the areæ being analogous to the extremities of the rays bent up towards the anal pole.

In the CRINOIDEÆ, or sea lilies, which may be likened to sea-stars supported upon many jointed columns, the skeleton is very complicated, being composed of many thousand separate pieces, beautifully and nicely fitted to each other. Fig. 72 represents the pear encrinite (*Apiocrinus rotunda*), from the Bradford clay; and fig. 73, the lily encrinite (*Encrinus moniliformis*), from the Muschelkalk. These stalked echinoderms attained a great generic development in the palæozoic rocks, entire strata being sometimes composed of their broken skeletons; their forms are less numerous in the triassic and oolitic periods; a few only are found in the chalk, and one rare species lives in the warm regions of our present seas. —T. W.]

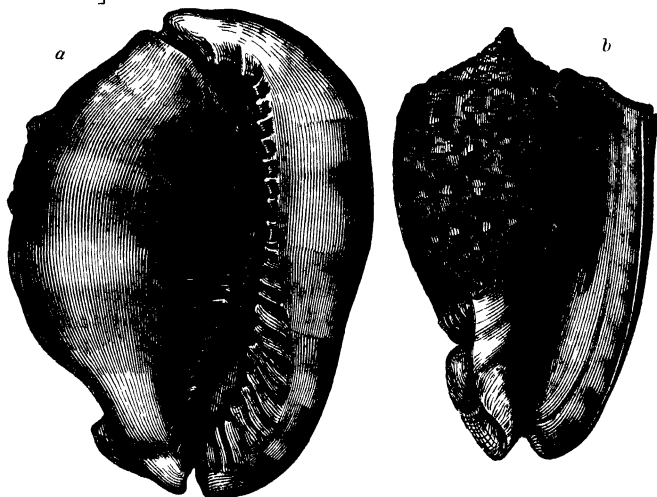

Fig. 74.—*Cypræacassis rufa*, *a*, mature, *b*, immature state of the same shell.

§ 220. In the mollusca, the solid parts are secreted by the skin, most frequently in the form of a calcareous shell of one, two, or many pieces, serving for the protection of the soft

parts which they cover. These shells are generally so constructed as to afford complete protection to the animal within their cavities. In a few, the shell is too small for this purpose; in others it exists only at a very early period, and is lost as the animal is developed, so that at last there is no other covering than a slimy skin. In some the tegumentary membrane becomes so thick and firm as to have the consistence of elastic leather, or it is gelatinous or transparent; and what is very curious, these tissues may be the same as those of woody fibre, as, for example, in the ascidia. In general the solid parts do not aid in locomotion, so that the mollusca are mostly sluggish in their movements. It is only in a few rare cases that the shell becomes a true lever, as in the scallops (*Pecten*), which use the valves thereof to propel themselves in swimming.

[The shells of a great majority of the gasteropoda are univalve, and rolled obliquely, in consequence of the unequal development of the body of the animal. They consequently form a helix or oblique spiral; sometimes the coil is towards the right, but in general it is towards the left side. Some univalve shells have a patelloid form, and are symmetrical, without being spiral; and there are various intermediate groups, by which these forms blend into each other. Some of the shells vary very much in form at different stages of their growth, as shown in the beautiful *Cypræacassis rufa*, from the coral reefs of the South Pacific. Fig. 74, *a*, is the mature form of that shell, with its greatly developed right lip; and *b*, the young, or immature form of the same.—T. W.]

§ 221. The muscles of mollusca either form a flat disc under the body, or large bundles across its mass, or they are distributed in the skin, so as to dilate and contract it, or are arranged about the mouth and tentacles, which they put in motion. However varied in their disposition, the muscles always form very considerable masses, in proportion to the size of the body, and have a soft and mucous appearance, such as is not seen in the contractile fibres of the other divisions of the animal kingdom. This peculiar aspect no doubt arises from the numerous small cavities extending between the muscles, and the secretion of mucus which takes place in them.

§ 222. In the articulated animals (fig. 34), the solid parts are external, in the form of rings, generally of a horny structure, but sometimes calcareous, and successively fitting into each other at their edges. The tail of a lobster gives a good idea of this

structure. The rings differ in the several classes of this division, merely as to volume, form, solidity, number of pieces, and the degree of motion which one has upon another. In some groups they are consolidated, so as to form a shield or carapace, such as is seen in the crabs. In others, they are membranous, and the body is capable of assuming various forms, as in the leeches and worms generally. Fig. 75 is a beautiful fossil *Astacus*, from the lower greensand, which exhibits the character of the skeleton of the crustacea.

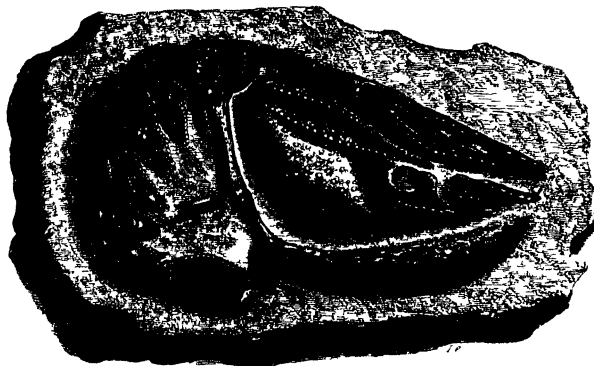

Fig 75.—*Astacus Vectensis*, from the lower greensand, Isle of Wight.

§ 223. A variety of appendages are attached to these rings, such as jointed legs (fig. 34), or, in place of them, stiff bristles, oars fringed with silken threads, wings either firm or membranous (fig. 369), antennæ, moveable pieces which perform the office of jaws (fig. 195), &c. But, however diversified this solid apparatus may be, it is universally the case that the rings, to which every segment of the body may be referred, as to a type, combine to form but a single internal cavity, in which all the organs are enclosed, the nervous system, as well as the organs of vegetative life (§ 76).

§ 224. The muscles which move all these parts have this peculiarity, that they are enclosed within the more solid framework, and are not external to it, as in the vertebrata; and also that the muscular bundles, which are very considerable in number, have the form of ribbons, or fleshy strips, with parallel fibres of remarkable whiteness.

§ 225. The vertebrated, like the articulated animals, have

solid parts at the surface, as the hairs and horns of mammals, the coat of mail of the armadillo (fig. 75*), the feathers and

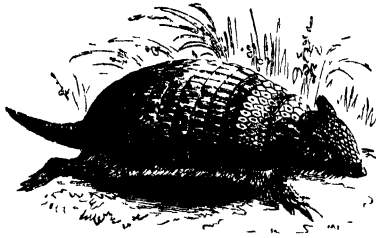
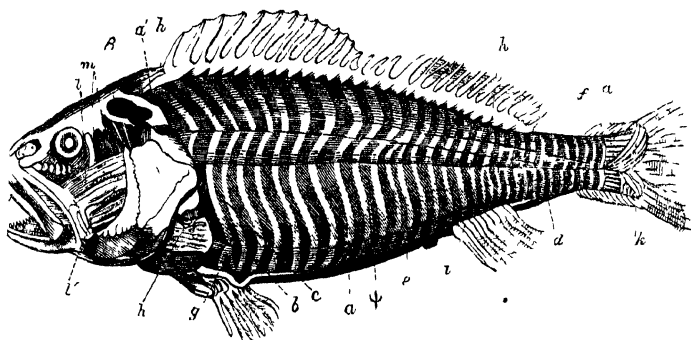

Fig. 75*.—External skeleton of the *Dasypus septentrionalis*.

claws of birds, the bucklers and scales of reptiles and fishes, &c. But they have, besides this, along the interior of the whole body, a solid framework, not found in the invertebrata, well known as the SKELETON.

§ 226. The skeleton is composed of a series of separate bones, called vertebræ, united to each other by ligaments. Each vertebra has a solid centre with several branches, two of which ascend and form an arch above, and two descend, forming an arch below the body of the vertebra. The upper arches form a continuous cavity along the region of the trunk, which encloses the spinal cord, and in the head receives the brain (§ 85 and § 89). The lower arches form another cavity, similar to the superior one, for containing the organs of nutrition and reproduction; the branches generally meet below, and when disjoined, the deficiency is supplied by fleshy walls. Every part of the skeleton may be reduced to this fundamental type, the vertebra, as will be shown when treating specially of the vertebrate animals; so that, between the pieces composing the head, the trunk, and the tail, we have only differences in the degree of development of the body of the vertebra, or of its branches, and not in reality different plans of organization.

§ 227. The muscles which move this solid framework of the vertebrata are disposed around the vertebræ, as is well exemplified among fishes, where there is a band of muscles for each vertebra (fig. 76). In proportion as limbs are developed, this intimate relation between the muscles and the vertebræ diminishes. The muscles are unequally distributed, and are concentrated about the limbs, where the greatest amount of muscular force is required. For this reason the largest masses of flesh, in the higher vertebrata, are found about the shoulders and hips (fig. 77); while in fishes they are concentrated about the base of the tail, the part on which they principally depend for motion.



[Fig. 76 represents the Muscles of the Perch.—*a*, inferior half of the great lateral muscular mass; *a'*, the superior half; *b* and *c*, points where these masses divide for the passage of the rays of the pectoral and ventral fins; *d* *e*, the middle inferior longitudinal muscles; *f*, the middle superior; *g*, muscles for moving the ventral fin; *h*, the muscles special to the pectoral fin; *h h*, the particular muscles of the dorsal fin; *i*, the muscles of the anal fin; *k*, the muscles of the caudal tail fin; *l l'*, the muscles common to the jaws; *m*, the muscles of the operculum and the first intercostal of the cranium; β , attachment of the latero-superior muscles of the occiput; ψ , the lateral line between the muscular masses; the great lateral nerve has been removed, and the superior muscular mass pushed upwards.—Cuvier, *Histoire des Poissons*.

[Fig. 77.—Muscular system of Birds.—The muscles of the *Falco nisus*: 1, the great complexus; 1 *a*, its tendon; 1 *b*, its superior head; 1 *c*, its inferior head; 2, the small complexus; 3, the lateral flexor of the head; 4, the long flexor of the head; 5, the great extensor of the neck; 6, the descending cervical; 7, 7', the demi-spinal muscles of the neck and back; 8, the superior flexor of the head; 9, the inferior, or long flexor of the head; 10, 10, the anterior and posterior inter-transverse muscles of the neck; 11, the elevator of the coccyx; 12, the depressor of the coccyx; 13, the cruri-coccygean; 14, the pubi-coccygean; 15, the eschio-coccygean; 16, the quadratus; 17, the external oblique of the abdomen; 18, the trapezium; 19, the great serratus; 20, the great pectoral; 21, the latissimus dorsi; 22, the deltoid; 23, the subscapular; 24, the coraco-brachialis; 25, the biceps brachialis; 26, the supinator; 27, the long anconæus; 28, the short anconæus; 29, the small anconæus; 30, the anterior extensor of the skin of the wing; 30 *a*, the portion which goes to the carpus; 30 *b*, the portion which goes to the radius; 31, the posterior extensor of the skin of the wing, divided; 32, the long extensor of the metacarpus; 33, the short extensor of the metacarpus; 34 *a*, the common flexor of the thumb and second finger; 34 *b*, the extensor of the

second and third phalanx of the second toe; 34 *c*, the short flexor of the thumb; 35, the radial flexor of the metacarpus; 36, the ulnar flexor of the metacarpus; 37, the great gluteus; 38, the first adductor of the thigh; 39, the sartorius; 40, the large muscle of the thigh; 41, the small muscle of the thigh, the tendon of which passes upon the knee, and joins the flexor of the toes; 42, the common extensor of the leg, the vastus externus and internus; 43, the first anterior flexor of the leg; 44, the third flexor of the leg, the semimembranosus; 45, the fourth flexor, or semi-tendinosus; 46, the gastrocnemius; 47, the internal part of this muscle; 48, the pyramidal muscle which opens the jaws; 49, the temporal; 50, the long ligament of the lower jaw; 51, the cutaneous muscle of the head; 52, the anterior masseter; 53, the coniform muscle of the hyoid bone; 54, the anterior tibial; 55, the posterior tibial; 56, the extensor of the toe; 57, the flexor of the toe; 58, the long head of the common flexor of the toes; 59, the tendon of the extensor of the toes; 60, the abductor of the internal toes; 61, the perforated flexor of the three toes; 62, the fibular muscle; 63, the abductor of the little toe; 64, the abductor of the great toe; *a*, the pharynx; *b*, the trachea; *c*, the hyoid; *d*, the ear; *e*, the humerus; *f*, the radius; *g*, the ulna; *h*, the thumb; *i*, the tibia; *k*, the metatarsus; *l*, the great toe; *m*, the internal toe; *n*, the median toe; *o*, the external toe.—

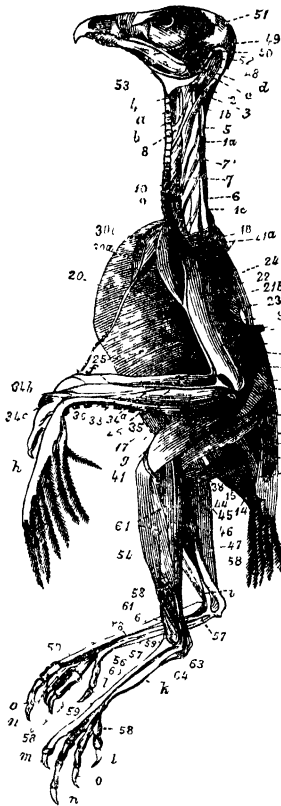

Fig. 77.—Muscular system of the *Falco nisus*.

Carus, Anatomie Comparée.—T.W.]

SECTION II.

OF LOCOMOTION.

§ 228. ONE of the most curious and important applications of this apparatus of bones and muscles is for LOCOMOTION. By this is understood the movement which an animal makes in passing from place to place, in the pursuit of pleasure, sustenance, or safety, in distinction from those motions which are performed equally well while stationary, such as the acts of respiration, mastication, &c.

§ 229. The means which nature has brought into action to effect locomotion, under all the various circumstances in which animals are placed, are very diversified; and the study of their adaptation to the necessities of animals is highly interesting in a mechanical, as well as in a zoological point of view. Two general plans may be noticed, under which these varieties may be arranged. Either the whole body is equally concerned in effecting locomotion, or only some of its parts are employed for that purpose.

§ 230. The medusæ (fig. 173) swim by contracting their umbrella-shaped bodies upon the water below, and its resistance urges them forwards. Other animals are provided with a sac or syphon, which they may fill with water, and suddenly force out, producing a jet, which is resisted by the surrounding water, and the animal is thus propelled. The *Holothuria* (fig. 232), the cuttle-fishes, the salpæ, &c. move in this way.

§ 231. Others contract small portions of their body in succession, which being thereby rendered firmer, serve as points of resistance, against which the animal may strive in urging the body onwards. The earth-worm, whose body is composed of a series of rings united by muscles, and shutting more or less into each other, has only to close up the rings, at one or more points, to form a sort of fulcrum, against which the rest of the body exerts itself in extending forwards.

§ 232. Some have, at the extremities of the body, a disc, or some other organ, for maintaining a firm hold, each extremity acting in turn as a fixed point. Thus the leech (fig. 178) has a disc, or sucker, at its tail (*o*), by which it fixes itself; the body is then elongated by the contraction of the muscular fibres which encircle the animal; the mouth (*a*) is next fixed by a similar sucker, and by the contraction of muscles running lengthwise the body is shortened, and the tail, losing its hold, is

brought forwards to repeat the same process. Most of the bivalved mollusca, such as the clams, move from place to place in a similar way. A fleshy organ, called the foot, is thrust forward, and its extremity fixed in the mud, or to some firm object, when it contracts, and thus draws along the body and the shell enclosing it. Snails, and many similar animals (fig. 35), have the fleshy under-surface of their body (*a, b*) composed of an infinitude of very short muscles, which, by successive contractions—so minute, indeed, as scarcely to be detected—enable them to glide smoothly and silently along, without any apparent muscular effort.

§ 233. In the majority of animals, however, locomotion is effected by means of organs specially designed for the purpose. The most simple are the minute hair-like cilia, fringing the body of most of the microscopic infusory animalcules (fig. 171), and which, by their incessant vibrations, cause rapid movements. The sea-urchins (fig. 174) and star-fishes (fig. 36) have little thread-like tubes issuing from every side of the body, furnished with a sucker at the end. By attaching these to some fixed object, they are enabled to draw or roll themselves along; but their progress is always slow. Insects are distinguished for the number and great perfection of their organs of motion: they have at least three pairs of legs (fig. 34), and usually two pairs of wings (fig. 369), but those that have numerous feet, like the centipedes, are not distinguished for agility. The crustacea generally have at least five pairs of legs, which are used for both swimming and crawling. The worms are much less active; some of them have only short bristles at their sides; some of the marine species use their gills for paddles.

§ 234. Among the vertebrata, we find the greatest diversity in the organs of locomotion, and the modes of their application, as well as the greatest perfection, in whatever element they may be employed. The sailing of the eagle, the bounding of the antelope, the swimming of the shark, are not equalled by any movements of insects. This superiority is due to the internal skeleton, which, while it endows the animal with great force, gives to the motions, at the same time, a nice degree of precision.

[§ 235. Before entering upon the study of the various motions of the vertebrate animals, and the means by which these are performed, it is important to put the student in possession of a standard by which he will be enabled to compare the form of the osseous elements and the modifications they undergo in fishes, reptiles, birds, and mammals. With this view we

proceed to give an outline of the structure of the Skeleton of Man (fig. 78), and the uses of its several parts. This bony framework is formed of 249 separate pieces, articulated together in

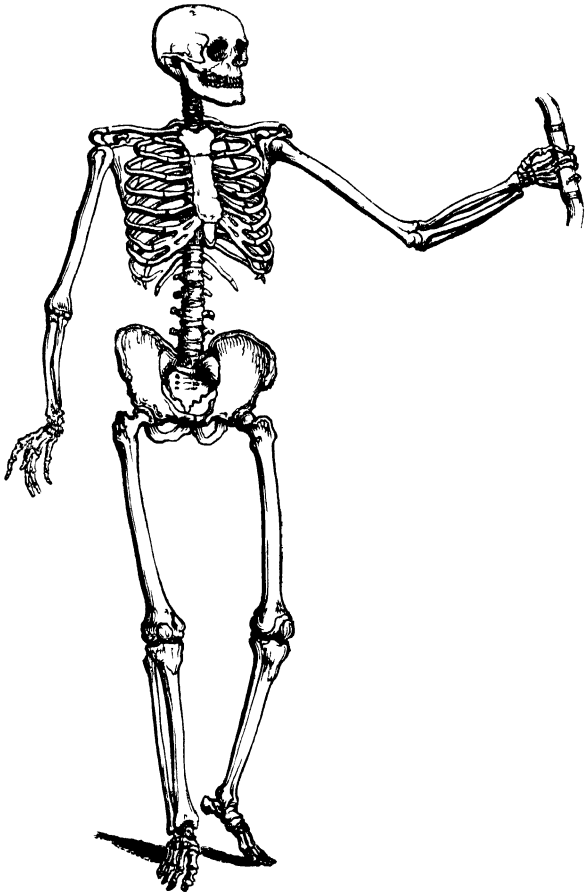

Fig 78 —The Skeleton of Man

various ways, and divided into the HEAD, TRUNK, and EXTREMITIES. Some of the bones are single, and disposed on the median line of the body, in which case they are always formed of two halves, the counterpart of each other; the great majority, however, consist of pairs. The following table exhibits the distribution of the bones.

Of the Head, 63.	Os frontis	1
	Ossa parietalia	2
	Os occipitis	1
	Ossa temporum	2
	Ossicula auditus	8
	Os sphenoides	1
	Os ethmoides	1
	Ossa malarum	2
	Ossa maxillaria superiora	2
	Ossa nasi	2
	Ossa lachrymalia	2
	Ossa palatina	2
	Ossa turbinata	2
	Vomer	1
Os maxillare inferius	1	
Dentes	32	
Os hyoides	1	
Of the Trunk, 54.	Vertebræ	24
	Costæ	24
	Sternum	2
	Ossa innominata	2
	Os sacrum	1
	Os coccygis	1
Of the Extremities, 132.	Claviculæ	2
	Scapulæ	2
	Ossa humeri	2
	Ulnæ	2
	Radii	2
	Ossa carpi	16
	Ossa metacarpi	10
	Phalanges digitorum manus	28
	Ossa sesamoidea	4
	Ossa femoris	2
	Patellæ	2
	Tibiæ	2
	Fibulæ	2
Ossa tarsi	14	
Ossa metatarsi	10	
Phalanges digitorum pedis	28	
Ossa sesamoidea	4	

[§ 236. The internal skeleton of the vertebrata is formed, for the most part, of bone, a substance which is peculiar to this primary division of the animal kingdom. It consists of an organic gelatinous matter, hardened by inorganic earthy particles distributed regularly throughout the animal tissue. The relative proportion of the organic to the inorganic matter varies in the different classes of the vertebrata; the bones of fishes have the least, those of birds the greatest proportion of inorganic elements, whilst reptiles and mammals occupy an intermediate position; the mammals, however, especially the active predacious genera, having a larger proportion than the reptiles. From a series of experiments recently made, and conducted with great care, by Bibra,* on thoroughly dried bones of fishes, reptiles, birds, and mammals, the following results were obtained.

[§ 237. FISHES.

	SALMON. <i>Salmo salar.</i>	CARP. <i>Cyprinus carpio.</i>	COD. <i>Gadus morrhua.</i>
Organic.....	60.62	40.40	34.30
Inorganic	39.38	59.60	65.70
	1000	1000	1000

REPTILES.

	FROG. <i>Rana esculenta.</i>	SNAKE. <i>Coluber natrix.</i>	LIZARD. <i>Lacerta agilis.</i>
Organic.....	35.50	31.04	46.67
Inorganic	64.50	68.96	53.33
	1000	1000	1000

MAMMALS.

	DOLPHIN. <i>Delphinus delphis.</i>	OX.† <i>Bos taurus.</i>	WILD CAT.† <i>Felis catus.</i>	MAN.† <i>Homo.</i>
Organic....	35.90	31.00	27.77	31.03
Inorganic ..	64.10	69.00	72.23	68.97
	1000	1000	1000	1000

BIRDS.

	GOOSE.† <i>Anser.</i>	TURKEY.† <i>Meleagris gallo-pavo.</i>	HAWK.† <i>Falco gallinarius.</i>
Organic	32.91	30.49	26.72
Inorganic	67.09	69.51	73.28
	1000	1000	1000

* Chemische Untersuchungen über die Knochen u. Zähne des Menschen u. der Wirbelthiere, 1844.

† From the femur.

[§ 238. The chemical composition of the inorganic constituents of bone in the four classes, is shewn in the following table.

ANALYSIS OF BONES.

	Hawk.	Man.	Tortoise.	Cod.
Phosphate of Lime with a trace of Fluat	64.39	59.63	52.66	57.29
Carbonate of Lime	7.03	7.33	12.53	4.90
Phosphate of Magnesia	0.94	1.32	0.82	2.40
Sulphate, Carbonate, and Chlorate of Soda	0.92	0.69	0.90	1.10
Glutin and Chondrin	25.73	29.70	31.75	32.31
Oil	0.99	1.33	1.34	2.00
	1000	1000	1000	1000

[§ 239. The primitive basis of bone, is a subtransparent glairy fluid, resembling mucus in its chemical composition, and containing a multitude of minute corpuscles. When it passes into the stage of cartilage, a number of elliptical nucleated cells make their appearance; in proportion as the cells increase in size and number, the cartilage hardens, and at the point where ossification is about to commence, they arrange themselves in linear rows. In the long bones the cell rows are parallel to the axis of the bone, and in the flat bones, they run in rays from the centre to the periphery. The nucleated cells are the agents by which the earthy particles are arranged in order; and in bone, as in teeth, there may be discerned in this predetermined arrangement, the same relation to the acquisition of power and resistance with the greatest economy in the building material, as in the disposition of the beams and columns of a work of human architecture.*

[§ 240. The intimate structure of bone can only be studied by the aid of the microscope; for this purpose, very thin sections of the bones of fishes, reptiles, birds, and mammals, should be prepared and mounted on glass slides in canada balsam, and covered with very thin glass; by this means a series of comparative observations may be made. If we take a transverse section of one of the long bones of man, the femur, for example, and examine it with a power of about two hundred linear, we observe that it is traversed by a number of canals called Haversian, which transmit blood-vessels

* Professor Owen's Comparative Anatomy of Fishes contains ample details on this subject.

through the substance of the bone; around each of these canals a series of bony laminæ are concentrically arranged, as if they resulted from rings of growth, and reminding us of a transverse section of the branch of a dicotyledonous tree. Between the laminæ a number of peculiar spider-like bodies are arranged likewise in a concentric manner; they have an irregular oval form, with jagged edges, and send out from their circumference a number of small branching tubes, which anastomose freely with the tubes from other cells, forming thereby a complete network of tubes and reservoirs, which traverse the osseous tissue in all directions. The sides of the spider-like bodies lying nearest the Haversian canals, send their small tubes to open into them, by which nutritive fluids passing through the canals are absorbed and transmitted through the osseous tissue, so that it is possible to inject the spider-like bodies and the whole system of tubes, by forcing fluids into any of the canals. The spider-like bodies have received different names, as osseous corpuscles, calcigerous cells, lacunæ, or bone cells, according as the observer considered them to be solid or hollow. The spider-like bodies or bone-cells in man, measure, on an average, about 1-1400 to 1-2400th of an inch in their long diameter, and about from 1-4000th to 1-8000th of an inch in their shortest diameter. The structure between the bone cells has been shewn by Mr. Tomes* to consist of a cellular basis, in which the granular earthy matter of bone is deposited. The granules vary from 1-6000th to the 1-14,000th of an inch in size, and are best shewn in a bone which has been long subjected to the action of boiling water or steam. The microscope, therefore, enables us to demonstrate that bone is composed of—1st, granular earthy matter, distributed throughout the cellular tissue;—2nd, bone cells and branching tubes, traversing the osseous structure; the former being the hardening material; the latter for the distribution of nourishment through its substance. This view of the function of the bone cells and tubes is supported by the fact, that there is a constant relation between the size of the bone cell and that of the blood corpuscle of the same animal, thus:

In birds, a transverse section of the femur shews that the Haversian canals are more numerous and smaller, and that

* Cyclopædia of Anatomy and Physiology. Art. Osseous Tissue, p. 848.

fewer radiating tubes proceed from the bone cells ; in the ostrich the bone cells are from 1-1300th to 1-2200th of an inch in their long diameter, and from 1-5425th to 1-9600th in their shortest. In reptiles the Haversian canals are few in number, but large in size, and in the same section we observe the canals and the bone cells arranged both vertically and longitudinally. The bone cells in the turtle measure 1-375th of an inch in length ; in the amphibia, as the siren, they measure 1-290th of an inch in length. Fishes present considerable variety in the intimate structure of the osseous tissue ; their bone cells have a singular quadrate form ; the ramifying tubes are few in number, and of considerable size, and anastomose freely with the tubes from neighbouring cells, forming thereby a well marked trellis-work in the osseous substance. The specimen before me, a thin section of the scale of an osseous fish, shews this anastomosis most distinctly. The size of the bone cells has been found to bear a remarkable relation to that of the blood corpuscle in the different classes of the vertebrata.*

[§ 241. THE HEAD is composed of two parts, the cranium, or skull, and the face. The cranium (fig. 79) is a bony case of an oval form, occupying the upper and back part of the head ; it lodges the brain (§ 80), and protects it from injury, and in two of its bones is situated the organ of hearing. The walls are formed of the frontal bone (3), which forms the forehead ; the two parietal bones (1) occupy the sides and roof of the skull ; the two temporal (2) form the walls of the temporal region ; and the occipital (4) is situated at the posterior and inferior part. These bones are firmly united to each other by sutures, the character of which varies in different parts of the cranium, and their evident intention being to afford the best kind of mechanism for resisting external violence. Thus, a blow upon the vertex tends to separate the parietal bones from each other and from the frontal, and to force their lower borders outwards ; but this accident is admirably provided against by the different kinds of sutures which unite the parietal to the frontal, occipital, and temporal bones, thus a serrated suture locks them together above, to the occi-

* For much valuable information on this subject, consult Mr. John Quekett's papers in the Trans. of the Microscopic Soc. London, vol. ii. part 2.

pital behind, and to the frontal before, whilst the temporal bones form the buttresses of this arch, overlapping in a spliced manner

Fig. 79.

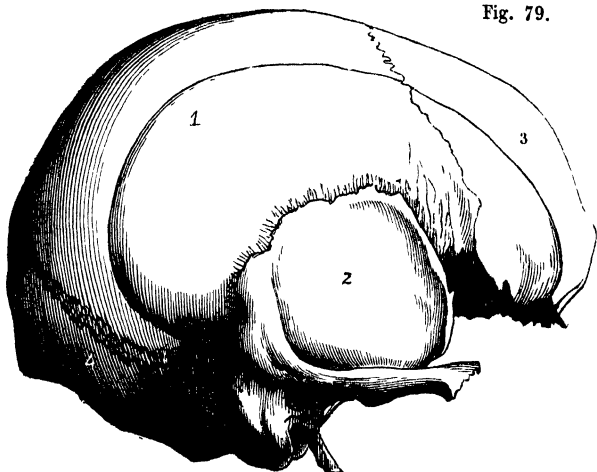

the lower border of the parietals, to prevent that portion being thrust outwards. The same mechanical provision prevents the temporal bones from being driven inwards by blows given on the temporal region.

Fig. 80.

Fig 80 shews the Fronto-temporal portion of the frontal bone (*os frontis*), bounded below by the frontal prominences (1, 1), and above by the suture by which it is connected with the parietals. 4, 4,

are the temporal arches; 5, 5, the temporal fossæ, in which the temporal muscles are lodged; 10,

10, the superciliary arches; 11, 11, the supra-orbital holes through which the nerves of that name pass.

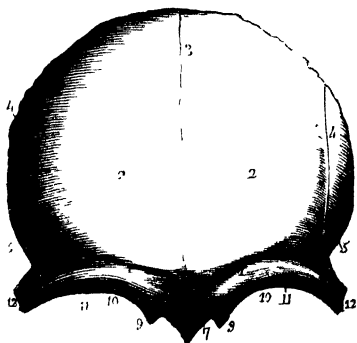

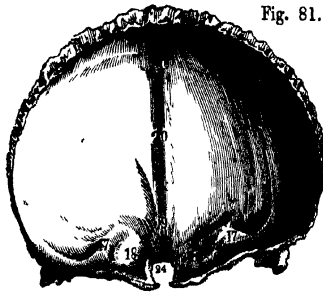

Fig. 81.

Fig. 81 is the internal surface of the same bone, shewing the broad and shallow depressions (17 and 18) produced by the convolutions of the anterior lobes of the cerebrum and the internal crest (19 and 20), which gives attachment to the dura mater.

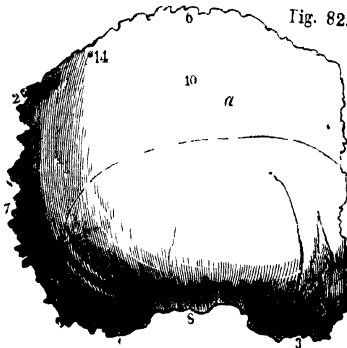

Fig. 82.

Fig. 82 represents the external surface of the parietals (*ossa parietalia*). At its upper (6), anterior (5), and posterior borders (7), are seen the serrated edges of the suture, and at its lower border (8), the bevelled edge, which is overlapped by the temporal bone.



Fig. 83.

Fig. 83 is the internal surface of the same bone, and at the lower anterior angle is shewn the canal (12) for lodging the middle artery of the dura mater, which is here seen to groove the bone with its numerous branches (b).

On the internal surface of the parietal bones (fig. 84) we observe the longitudinal groove, *sulcus longitudinalis* (1, 1, 1), for the longitudinal sinus

of the brain, and a number of little pits (2, 2, 2, 2), more or less deep, in which the glandulæ parhionæ are situated : there are also the impressiões digitatæ (3, 3, 3, 3), and eminentiæ mamillares,

(4, 4, 4, 4), produced by the convolutions of the brain ; the groovings for the meningeal arteries are seen at 5, 5, 5, 5, and the parietal holes at 6, 6.

[§ 244.

The temporals (*ossa temporum*), fig. 85, are of an irregular form, and consist of three portions, the squamous

the mammillary (II), and the petrous (III.)

Fig. 86, represents the external surface of the squamous portion (*a*), with the root of zygomatic process (2), and the glenoid cavity for the head of the lower jaw (6). The internal surface of the same portion (fig. 87)

bits the bevelled edge that overlaps the parietals, and the depressions (*b*) for receiving the convolutions of the cerebrum.

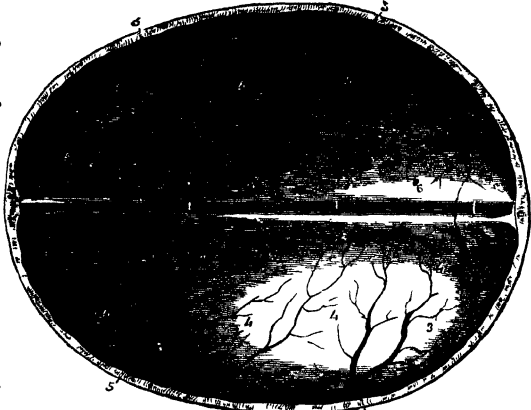

Fig. 85.

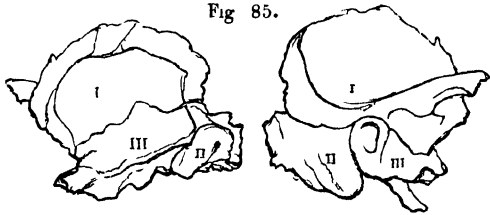
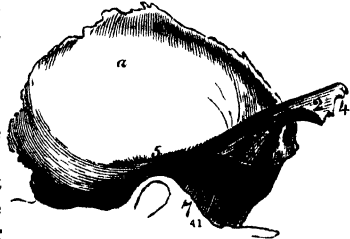

Fig. 86.



External surface.

Figs. 88 and 89 represent the anterior and posterior surfaces of the petrous portion of the temporal bone in which the internal ear is situated. These parts, consisting of the tympanum and its ossicles, the labyrinth with the vestibule, semicircular canals, and cochlea, have been already described in our section on the internal ear. § 150 to 154.

Fig. 87.

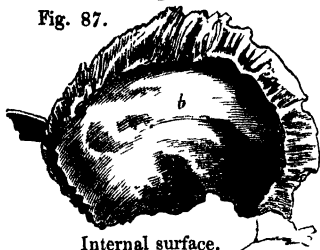

Internal surface.

Fig. 88.

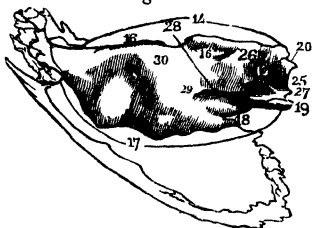

Anterior face.

Fig. 89.

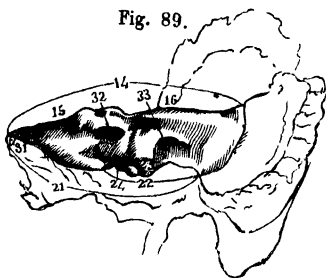

Posterior face.

Fig. 90 shows the external surface of the occipital bone (*os occipitis*), with its arched protuberances (10), for giving attachment to the muscles of the neck, and the large aperture (*foramen magnum*) (13) serving for the passage of the spinal cord. The basal portion is seen at (14); at each side of the foramen magnum are seen the *condyles* (16, 16), by which the skull rests upon the first vertebra of the neck, and moves backwards and forwards thereon.

Fig. 90* represents the internal surface of the *os occipitis*, which behind the foramen magnum (13), is divided into four cavities by a crucial ridge (23, 23, 24, 24). To the vertical spine, above the transverse portion, is attached the *falx cerebri*, and to that below, the *falx cerebelli*, whilst to the transverse ridge the *tentorium* is attached: the cavities above the transverse spine (21, 21) are for lodging the posterior lobes of the cerebrum, and those below (22, 22), for the cerebellum; the upper surface of the basal process (14) is hollowed out to receive the *medulla oblongata*.

transverse ridge the *tentorium* is attached: the cavities above the transverse spine (21, 21) are for lodging the posterior lobes of the cerebrum, and those below (22, 22), for the cerebellum; the upper surface of the basal process (14) is hollowed out to receive the *medulla oblongata*.

The head is almost in equilibrium on the condyles (16, 16), but that portion situated in front of the joint is heavier than that placed behind it, hence it overweighs the latter : this necessitates the presence of more powerful muscles in the posterior region of the neck, to maintain the head erect upon the spinal column; when these become relaxed, as in sleep, the head falls forward upon the chest.

[§ 246. The sphenoid and ethmoid bones, Fig. 91 (1, 2), are wedged between the cranial bones at the base of the skull, and may be said to be common to the cranium and the face.

[§ 247. The face is formed by the union of fourteen different shaped bones, which form five large cavities for lodging the organs of vision, smell, and taste. All the bones of the face, the lower jaw excepted, are completely immoveable, and firmly united to each other

Fig. 90.

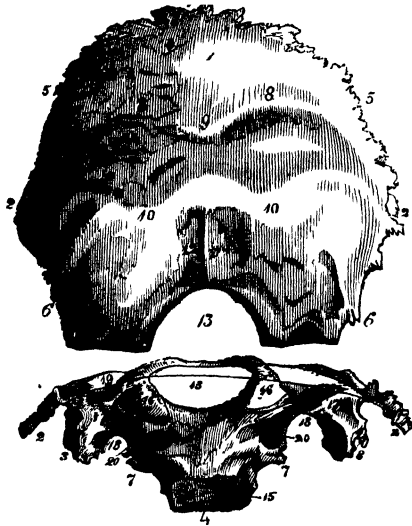
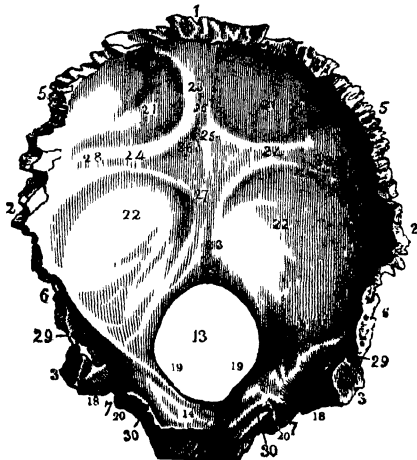
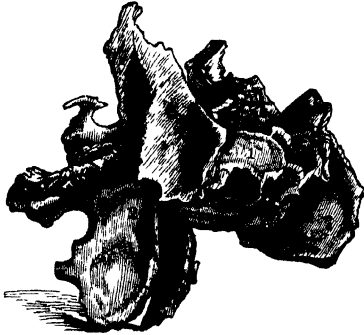

Fig. 90*.



and to the bones of the skull; the principal of these are the superior maxillaries, Fig. 92 (2), forming nearly the whole of

Fig. 91.



the upper jaw, and which are connected with the frontal bone in such a manner as to contribute to the formation of the orbits (4) and the nasal cavities (fig. 93, 6); they form the anterior part of the roof of the mouth, and unite with the malar bones (1), to constitute the prominence of the cheeks; behind they unite with the palate bones. In the interior of

the nasal fossæ are found two spongy bones (figs. 94 and 95), curiously folded, upon which the mucous membrane of the nose

Fig. 92.

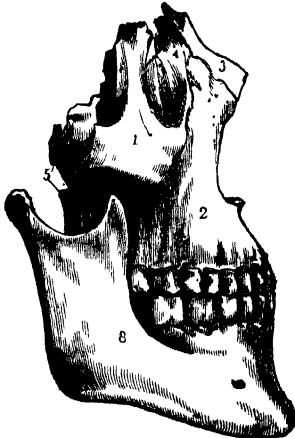

Fig. 93.



is spread. It is through the horizontal cribriform plate of the ethmoid bone, which separates the nasal cavity from that of the skull, that the olfactory nerves proceed into the nasal fossæ

(13); this plate, being pierced with numerous holes for their transit; the cavity of the nose is further increased by commu-

Fig. 94.

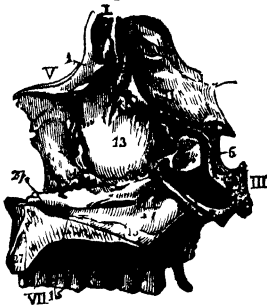

Partition of Nostrils.

Fig. 95.

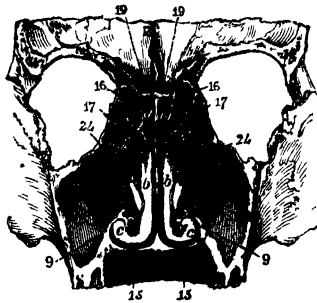

Transverse vertical section of Orbits, Nostrils, and Palate.

nications established between it and the sinuses existing in the frontal and superior maxillary bones, and which are lined by a continuation of the nasal membrane.

Fig. 96.

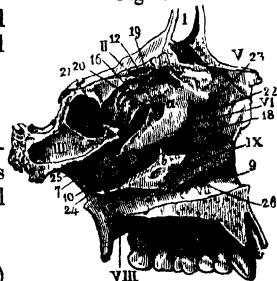

Lateral boundary.

Fig. 96 shews the lateral boundary of the nose, and the passages leading to and from the frontal and maxillary sinuses.

Fig. 97.

[§ 248. Fig. 97. THE ORBITS (10) are two deep conical cavities, with their base directed outwards; they are destined to lodge and protect the eyes. The roof of the orbit is formed by a thin plate of the frontal bone (fig. 81, 18); the floor chiefly by the superior maxillary (11), the internal wall by the ethmoid and lachrymal (3,4); the latter bone is grooved for the passage of the nasal duct (11), which conveys the tears into the nose; the external

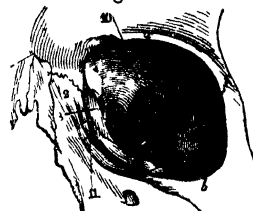

wall is formed by the malar (6) and a part of the sphenoid bones; the latter bounds the apex of the orbital cone; in it are pierced holes for the passage of the optic and other nerves appertaining to the organ of vision. The orbit contains the muscles that move the eye-ball, and in its upper and outer region, the lachrymal gland.

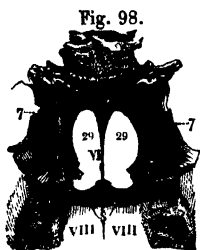

Anterior boundary.

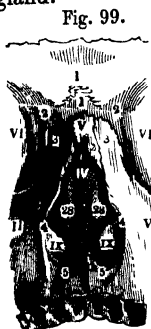

Posterior boundary. vity is divided by a vertical partition into two fossæ, as seen in fig. 99, 5 and 28, which shews the posterior boundary of the nose; superiorly it is hollowed out of the ethmoid bone, the interior of which is full of cells; and its floor is formed by the superior maxillary.



Fig. 100.



Fig. 101.

[§ 250. The superior maxillary bones (figs. 100 and 101) contain the teeth of the upper jaw; in infancy this bone is composed of several elements, one of which, called the intermaxillary, remains as a permanently distinct bone in

monkeys and other quadrupeds, whilst in man it is early soldered to the superior maxillary. Fig. 100 shews the internal,

and fig. 101 the external surface of the superior maxillary, with the sixteen teeth, four incisors, two canine, and ten molars in situ.

Fig. 102 exhibits the palate plates of the superior maxillary (2), and the palatine bones (3), together with the arch formed by the sixteen teeth (1, 1).

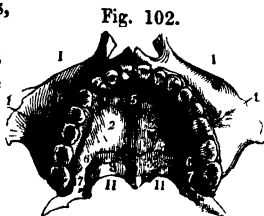

Fig. 102.

[§ 251. The lower jaw, in the adult, is composed of a single bone; in the infant, it consists of two branches united along the median line; and this separation is permanent in a great many animals, whilst in reptiles and fishes each branch consists of several distinct bones united together.

In man the lower jaw (figs. 103 and 104) has some resemblance to a horse shoe with the branches bent upwards at an obtuse angle; it contains sixteen teeth, and is articulated to the glenoid cavity of the temporal bone by a prominent condyle (12); in front of the condyle rises a second eminence, called the cor-
 noid process (14), serving

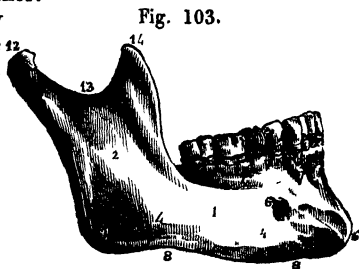

Fig. 103.

External surface.

for the attachment of the temporal muscle. The elevatory muscles of the lower jaw are all attached near its angle (3), they consequently act at a short distance from the fulcrum, the condyle (12), whilst the resistance is situated at a distance from the power; the masseter and pterygoid muscles are fixed to the inside as well as to the outside of the lower jaw; they are fleshy and powerful, for the purpose of raising the jaw with force, for crushing

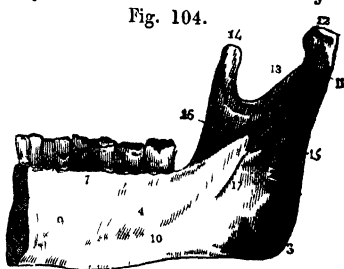

Fig. 104.

Internal surface.

the jaw with force, for crushing

and dividing the substances introduced between the teeth. The mechanical disadvantage arising from having the power thus placed so near the fulcrum, is compensated by the greater rapidity of motion which such an arrangement permits, whilst sufficient vital power is given to the elevatory muscles to admit of the sacrifice of lever power. When a hard body is introduced between the teeth, requiring an unusual force to break it, we instinctively carry the body far back in the mouth, in order to bring it more immediately under the power of the lever. The motions of the jaws of quadrupeds will be treated of more in detail, when the anatomical structure of the ruminants, carnivora, and rodents is under special investigation.

THE TRUNK.

[§ 252. The most essential part of the skeleton is the vertebral column, of which the skull may be considered an expansion, consisting, as it does, of three vertebra, the elements of which have undergone great development, to encompass and enclose the three primary divisions of the brain. The osseous appears to follow the cerebro-spinal system, in the various phases of its development, and may be regarded as a satellite moving round the primary nervous centres. The vertebral column occupies the middle line of the body, forming the central axis, which sustains all the other parts of the skeleton. It is composed in man of thirty-three vertebræ, arranged into those of the neck, back, loins, sacrum, and coccyx.

[§ 253. A vertebra (fig. 105) is one of the segments of

Fig. 105.

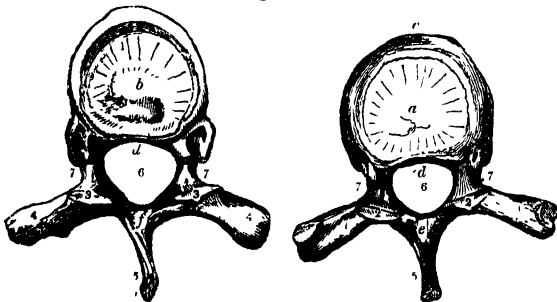

the internal skeleton constituting this axis, and forming canals

for protecting the central trunks of the nervous and vascular systems, and to which, likewise, sometimes, appendages are attached. A typical vertebra consists of a centre (*centrum*), and ten processes (*apophyses*). From the upper part of the *centrum* rise two *neurapophyses*, which form an arch for enclosing the spinal cord and brain. These are surmounted by a spine, called the *neural spine*. From the sides of the *centrum* two transverse processes, or *parapophyses*, project, which sometimes carry ribs, or *pleurapophyses*. From the under side of the *centrum* two processes descend to enclose the vascular trunks, in the same manner as the *neurapophyses* enclose the spinal cord, they are called *hæmapophyses*; from them descends a single *hæmal spine*. The vertebral elements undergo various phases of development in the different classes, and in different regions of the spinal column of the same animal; it is therefore only by taking a philosophical view of their structural development in the animal series that we obtain a knowledge of the beautiful law which produces such endless variety out of a few simple elements.

[§ 254. THE CERVICAL VERTEBRÆ (figs. 106 and 107) are smaller than the others. We observe in them a deviation from the typical form existing in the dorsal region, fig. 105; the transverse processes, fig.

Fig. 106.



Fig. 107.

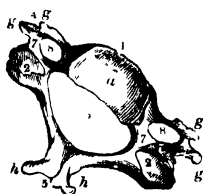

107 (*g, g*), *parapophyses*, and ribs, *pleurapophyses*, are rudimentary, and soldered together, forming a hole (8), through which the vertebral artery passes to the brain; the *hæmapophyses* are absent. This explanation of the structure of the transverse processes of the cervical vertebræ is beautifully illustrated in the neck of struthious birds. In all mammals we find seven cervical vertebræ. The first vertebra of the neck, the *atlas* (figs. 108 and 109), supports the skull; it is more moveable than the others, and differs considerably from the typical form; the *centrum* (*i*) is much reduced to receive a toothlike process, rising from the *centrum* of the second vertebra (fig. 110, *k*); around this pivot the atlas revolves, and

the lateral movements of the head are accomplished thereby, whilst the upward and downward movements are performed by

Fig. 108.

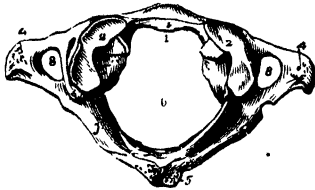
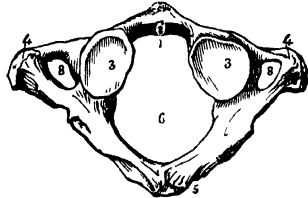

Fig. 109.



the play of the condyles of the occipital bone (fig. 90, 16) on the broad concave articular surfaces of the atlas (fig. 108, 2). Fig. 108 shews the superior, and fig. 109 the inferior surface of this vertebra. A firm ligament is stretched across the ring, dividing it into two apertures; the anterior hole (1) receives the tooth-like process of the axis, the posterior hole (6) gives passage to the spinal cord. The essential element of a vertebra is the *centrum*, the next in constancy are the two *neurapophyses*, the other elements undergo various phases of development. We rarely find all the elements present in one vertebra; some are absent, others are rudimentary, and others expand into disproportionate dimensions, in order to accomplish some destined end. A typical vertebra with all its elements, presents four channels disposed around the *centrum*; we find this typical vertebra in the thorax of mammals, birds, and lizards. Let us take, for example, the third, fourth, or fifth dorsal vertebra of man (fig. 105): the *centrum* (a, b) is broad, solid, and slightly biconcave; from its posterior part arise the two *neurapophyses* (fig. 105, 7), which arch over and enclose the spinal cord (6), and terminate in the *neural spine* (5); the two transverse or *parapophyses* are seen at (4, 4); to the sides of the *centrum* the dorsal ribs or two *pleurapophyses* are attached (fig. 124); the *hæmapophyses* are represented by the sternal cartilages, which are united to the distal extremity of the ribs; the *hæmal* element is a broad flat bone, forming one of the segments of the sternum; these five elements unite to form one of the large hoops of the thoracic cage (fig. 124), for enclosing and protecting the heart and the great trunks of the vascular system; the lateral channels giving transit to the nerves and blood-vessels.

Fig. 110 is the *axis* or second vertebra of the neck, with the round tooth-like process (*k*) rising from its *centrum* (1); from the extremity of this process two strong ligaments pass obliquely outwards, to be attached to the occipital bone; (2) is the articular surface, which plays on a like process of the atlas (fig. 109, 3).

Fig. 110.



The *seventh vertebra* (fig. 111) differs from the other cervical, in being larger, having the transverse processes (4, 4) single, with a hole in each for the transmission of the vertebral veins; constituting a transition to the typical form met with in the middle region of the thorax.

Fig. 111.

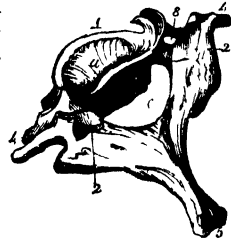

[§ 255. THE DORSAL VERTEBRÆ (figs. 112 and 113) diminish in size from the first to the fourth or fifth, from which they increase to the twelfth, which is the largest of all. The *centrum* (1, *a*, *b*,) is longest in the antero-posterior direction; the *parapophyses* (4, 4,) are short and stout, and the *neurapophyses* (6) broad, and inclined to form a complete osseoustile-like case for protecting the spinal cord; the *neural spine* (5) is long, and directed obliquely downwards, terminating in a tubercle for muscular attachment. The number of the dorsal vertebrae corresponds with the number of the ribs, which in man amounts to twelve pair.

Fig. 112.

Fig. 113.

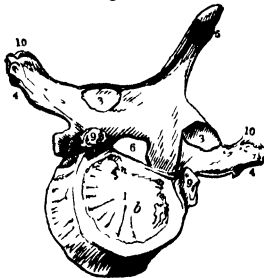

Fig. 114 shews the articulation of the *xth*, *xIth*, and *xIIth* dorsal vertebrae, and the changes of form which the *centrum* and

apophyses present, when compared with the fourth and fifth ; (figs. 112 and 113) the *parapophyses* and *pleurapophyses* are short, and the *hæmapophyses* have disappeared. We here see a transition form, for blending with the vertebræ of the loins.

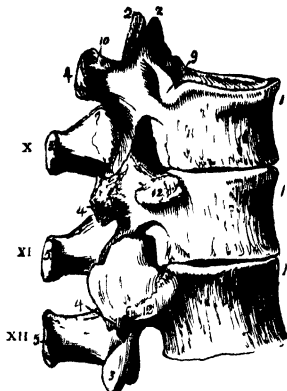

Fig. 115.

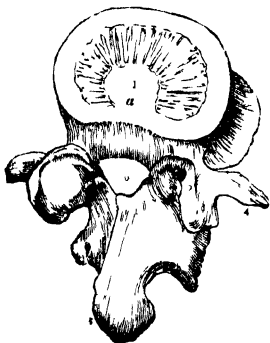

Fig. 116.

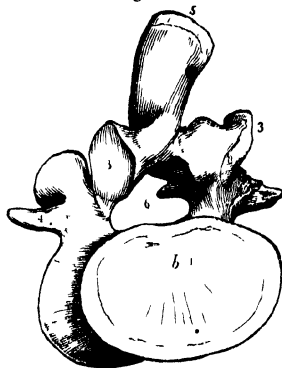

Fig. 117 represents the fifth lumbar vertebra, which differs from the others in having the under surface of its *centrum* oblique, so that the anterior is deeper than the posterior part, whereby it is better adapted for articulating with the sacrum, and affording us another example of a phase of transition from one form to another.

[§ 257. The SACRUM (fig. 118) is of a triangular shape, its base (1) facing upwards and forwards; its apex, which is

Fig. 117.



Fig. 118.

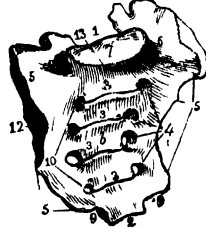

truncated (2), also facing forwards. It is concave before (b), from above downwards, and irregularly convex behind (fig. 120, a) in the same direction.

Fig. 119.



Fig. 120.

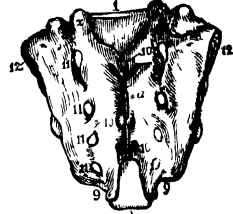

In the young subject it consists of five vertebræ, which in the adult become soldered into a single bone. In mammals it is much narrower than in man, and forms in them a straight line with the spine; the separate

pieces thereof remaining permanently united by ligaments. In animals which sometimes hold themselves erect, as monkeys, bears, sloths, and many rodents, it is proportionally larger than in other mammals. On the concave anterior surface of the sacrum we observe holes (4) for the passage of the nerves; and on its posterior surface (fig. 120), similar apertures (11, 11, 11) for the same purpose are seen. Fig. 119 is a profile of this bone.

[§ 258. The COCCYX consists of four small bones, which retain only a rudimentary centrum, and are soldered together in man (fig. 119, 2.) These bones are, in fact, the rudiment of an organ, the tail, which attains great importance and dimensions in some animals, as shown in the comparative table (§ 260).

[§ 259. The VERTEBRÆ are firmly united together by processes of bone (fig. 114—116, 2 and 3) that lock into each other. Between every two vertebræ, an elastic fibro-cartilaginous cushion

is interposed. By this arrangement the chain of bones is converted into a strong elastic central axis, more or less move-

Fig. 121.

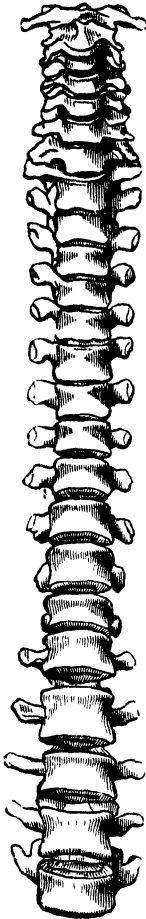
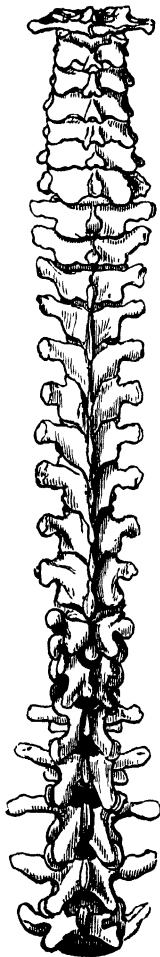

Fig. 122.



ble in different animals, according to the general structure and habits of each.

Fig. 121 exhibits a front view of the spinal column of man. It is of a pyramidal form, the base of the pyramid rests upon the sacrum, and the apex supports the skull. We observe, likewise, that the diameter of the bodies of the vertebræ differs in different regions, being broad in the neck, narrow in the back, and broad again in the loins.

Fig. 122 represents a posterior view of the spinal column. The different forms of the *neurapophyses*, in the cervical, dorsal, and lumbar regions, are here shewn. They are observed to project backwards and a little downwards in the neck; they lie obliquely downwards in the back, and stand backwards in the loins. On each side of the *neural spines*, a groove is seen formed by a junction of the arches of all the vertebræ; bounded internally by the *neural spines*, and externally by the *parapophyses*; in this groove the muscles are lodged that impart motion to the column.

Fig. 123 is a lateral view of the spinal column, which presents anteriorly two convex, and one concave surface.

The upper convexity is formed by the lower cervical and the upper dorsal vertebræ, and the lower convexity by the lumbar vertebræ; whilst the central concavity is formed by the middle dorsal vertebræ. Behind the *centra* we see the lateral holes for giving transit to the spinal nerves, and formed by the junction of the notches in the *neurapophyses*. The direction of the *neurapophyses* and *parapophyses* is likewise well seen in this figure.

Fig. 123

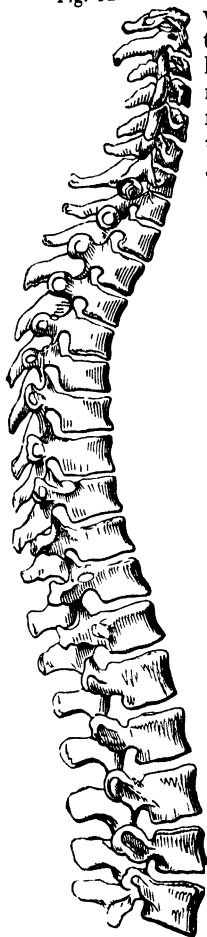

[§ 260. The following table* shows the number of the vertebræ in the different regions of the spinal column, in a few familiar examples from mammals, birds, reptiles, and fishes. It is important to note, that the number seven prevails in the cervical vertebræ of all mammals, whether we study these bones in the rudimentary condition in which they exist in whales, or in the enormous development they attain in the neck of the giraffe. The increased number of the bones in the same region, in birds, is a compensation for the want of anterior prehensile members, the neck, in birds, being used as an arm. The number of the dorsal vertebræ ranges from 7 to 320; the lumbar, from 2 to 9; and the coccygeal, from 4 to 115. The table might have been greatly extended; but those who wish for further information on this interesting branch of comparative osteology, are referred to the great work from which it is extracted:—

* Cuvier, Leçons D'Anatomie Comparée, tom. 1.

COMPARATIVE TABLE OF THE NUMBER OF THE
VERTEBRÆ.

	Cervi- cal.	Dorsal.	Lumbar.	Sacral.	Coccy- geal.	Total.
MAMMALIA.						
Man	7	12	5	5	4	33
Long-tailed Monkey ..	7	12	7	3	31	60
Lion	7	13	7	3	26	56
Long-tailed Opossum ..	7	16	6	2	36	64
Long-tailed Ant-eater ..	7	16	3	6	40	72
Elephant	7	20	3	4	27	61
Giraffe	7	14	5	4	18	48
Whale	7	15	9	1	27	59
BIRDS.						
Vulture	15	7	—	13	6	41
Swallow	13	7	—	10	7	37
Turkey	14	7	—	15	6	42
Ostrich	18	9	—	19	9	55
Crane	17	10	—	15	6	48
Swan	23	11	—	16	8	58
REPTILES.						
Tortoise	9	10	—	3	20	42
Monitor (Lizard).....	6	21	2	2	115	146
Python (Boa)	—	320	—	—	102	422
Rattle-Snake	—	171	—	—	36	207
Land Salamander	1	14	—	1	26	44
Axolote	2	18	—	—	42	62
FISHES.						
Perch	—	21	—	—	21	42
Mackerel	—	15	—	—	16	31
Trichiurus	—	60	—	—	100	160
Salmon	—	34	—	—	22	56
Cod	—	19	—	—	34	53
Conger Eel	—	60	—	—	102	162
Electric Eel	—	—	—	—	—	236
Shark	—	95	—	—	270	365

[§ 261. The THORAX is formed by the twelve dorsal vertebræ, the ribs, and sternum; the vertebræ have their elements well developed in this region, to form an osseous cage for protecting the heart, lungs, and great bloodvessels (fig. 124). The

ribs, or *pleurapophyses*, are attached by a head to the *centrum*, and by a tubercle to the *parapophyses*; the *hæmapophyses*, or cartilages, are unossified, and removed to the distal end of the ribs; they unite before with the *hæmal* bones, or sternum, which is here placed in the median line.

Fig. 124.

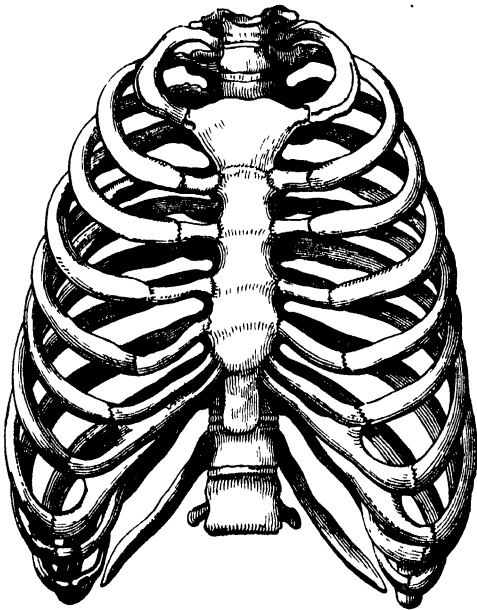

The *hæmal* elements play an important part in the economy of many animals. In

birds and tortoises, the sternum is widely expanded, its deep keel affording a large surface for the attachment of the pectoral muscles in birds (fig. 77), and for the same muscles in the mole and the bat among mammals. In man, only seven of the twelve ribs form a complete hoop, as the *hæmapophyses* of the five inferior ribs are united together, and the *hæmal* elements of these are wanting. In crocodiles, the *hæmapophyses*, or sternal ribs, are ossified; and similar ossified *apophyses* are continued along the fore part of the abdomen to the pubis. Rudiments of these abdominal ribs are seen in the transverse tendinous intersections of the rectus abdominis muscles in

man and other mammals; which attain their culminating point in the reptilian type of structure, where they exist under the form of true abdominal ribs.

[§ 262. The extremities are united to the trunk by two girdles of bone, composed in the upper of the scapular, and

Fig. 125.

Fig. 126

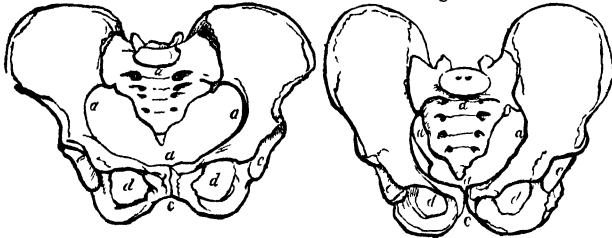

Female.

Male.

in the lower of the pelvic arches. The scapular arch presents many modifications, to adapt the anterior members as instruments for prehension and locomotion. The pelvic arch is of a more uniform structure, as the posterior extremities form instruments of locomotion alone.

§ 263. The PELVIC ARCH (fig. 125) is composed of three pair of bones, which are separate in infancy, but soldered together in the adult. One of these bones, the *ilium* (*a*), is firmly

Fig. 127.

Fig. 128.

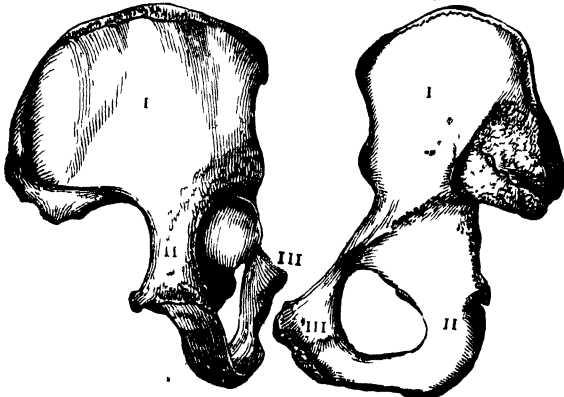

united to the sacrum, and another, the *pubis*, joins its fellow from the opposite side, forming the crown of the arch, whilst the *ischium* is wedged in between them; these three bones form the *ossa innominatum* of the human anatomist.

Figs. 127 and 128 represent these haunch bones. (I) is the ilium (II), the ischium, and (III) the pubis. The broad iliac bones form the brim of the pelvis (fig. 125), they afford support to the viscera of the abdomen, and give attachment by both their surfaces to the large and powerful muscles by which the thigh is moved, and the trunk retained erect upon the lower extremities. The brim of the pelvis (*a, a, a, a*) differs in the two sexes. In the male (fig. 126), the greatest diameter is in the antero-posterior; in the female (fig. 125), in the transverse direction. A comparative view of the *outlet* (*b, b, b, b*) (figs. 129 and 130) in a male and female pelvis, shews this opening to be of a diamond form, having the angles before, behind, and on the sides. In the male (fig. 130), the outlet is

Fig. 129.

Outlet.

Fig. 130.



Female.

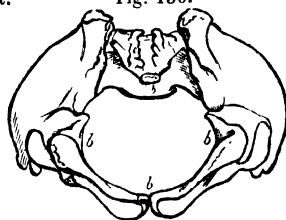

Male.

small; in the female (fig. 129), it is large. The greatest diameter is from the sacrum to the pubis in the female, in consequence of the sacrum being less curved than in the male. The space comprised between the brim and the outlet is called the true pelvis, in which the pelvic viscera are lodged. On each side of the pubic arch a large oval hole (*obturator foramen*), is formed by the ischium and pubis. It gives passage to blood vessels and nerves, and is partly closed by a ligament. On each side of the obturator hole, but somewhat behind that opening, is the cup-shaped cavity for receiving the head of the thigh bone (*acetabulum*) (fig. 131, *e*), formed by the junction of the ilium (I),

Fig. 131.



the ischium (II), and pubis (III). The continuity of the margin is interrupted at the under and fore part, by a notch (*f*), which is filled up with ligament. Opposite the notch is a cavity (*g*), to which the round ligament of the *femur* is attached. The axis of the pelvis is so placed that the weight of the trunk

Fig 132.

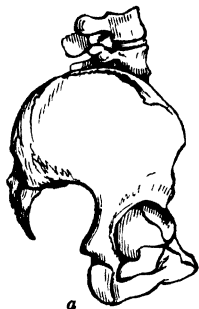

Fig. 133.

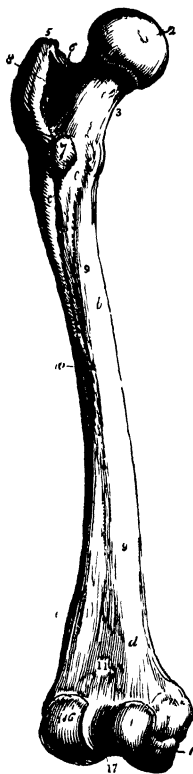
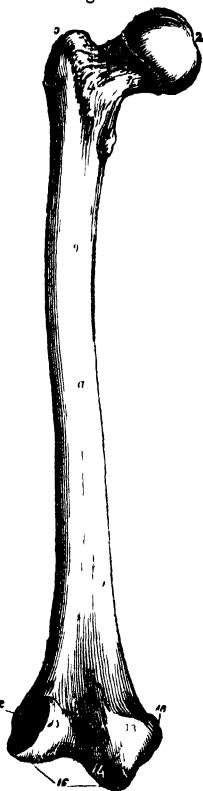

Fig. 134.



does not rest on the outlet, but upon the tuberosities of the ischia (fig 132, *a*). The opening of the outlet, therefore, points downwards and backwards, and that of the brim forwards and upwards.

[§1264. THE THIGH is composed of a single bone, the *femur* (figs. 133 and 134). It consists of a head, neck, trochanters, body, and condyles. The round head (1) has a pit for the insertion of the round ligament (2), which is accurately adapted to the acetabulum and retained therein by ligaments and atmospheric pressure. The neck (3) connects the head with the shaft or body. At the point where it joins the latter, we observe two

large projections. The larger (5) is called the great, and the smaller (7) the lesser trochanter, which serve for the attachment of the principal motory muscles of the thigh. The body (9) is arched before, and slightly concave behind, where we observe a rough projecting line (*linea aspera*) (10), which likewise affords a firm surface for the attachment of the muscles of the thigh. The lower end of the body expands into two large condyles (12, 13), of which the inner (13) is longer and larger. Fig. 134 represents a front view, and fig. 133 a back view of the femur. The condyles move upon the head of the *tibia* only in one plane. The knee joint is, therefore, a pure hinge, its motions being restricted by lateral and crucial ligaments, whilst the round head of the *femur* forms, with the acetabulum, a ball and socket joint, and executes thereby movements in all directions.

[§ 265. THE LEG (fig. 137) consists of two bones, the *tibia* (II) and *fibula* (III). The tibia has a broad head, on which the condyles of the femur play; to its upper surface is attached, by a ligament, a small round bone, the *patella* (1), or knee-pan, which protects the joint in front, and changes the direction of the tendons descending from the thigh to be inserted into the *tibia*, and thereby enabling them to act more advantageously upon the leg. The *fibula* (III) is a slender bone placed at the external side of the *tibia*. It affords attachment to muscles, and assists in the formation of the ankle joint. The latter joint, however, being formed chiefly by the lower end of the tibia; that bone supporting the entire weight of the body.

[§ 266. THE FOOT consists of the TARSUS, METATARSUS, and TOES. Fig. 138 shews these parts of the foot. A is the tarsus, B the

Fig. 137.

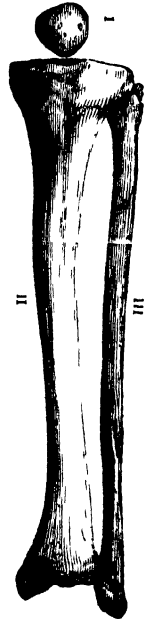
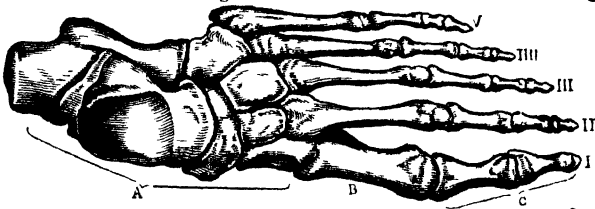
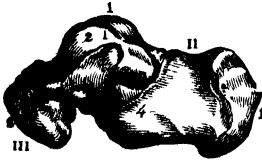

Fig. 138.



metatarsus, c the phalanges of the toes. The TARSUS consists of seven bones arranged in two rows. In the first row

Fig. 139.



(fig. 139) is the *astragalus* (I), *os naviculare* (II), *os calcis* (III). The articulation with the leg is formed by the astragalus, which projects above the rest, and fits into the space between the *tibia* and the *fibula*. The *astragalus* (I) rests upon the heel bone, *os calcis*, (III), which projects backwards, and is connected before with the navicular bone (II).

The second row (Fig. 140) consists of three

Fig. 140.

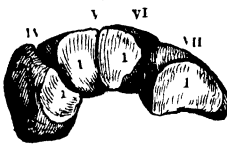
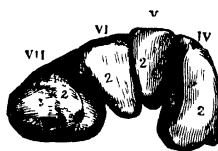

Fig. 141.



wedge-shaped bones, *ossa cuneiformia* (IV, V, VI), and the cuboid bone, *os cuboides* (VII). The concave posterior

surfaces (I, I, I, I) articulate with the first row of the tarsal

Fig. 142.

Bases.



bones and the convex anterior surfaces (fig. 141, 2, 2, 2, 2) with the metatarsal bones.

[§ 267. The METATARSUS consists of five bones (fig. 142), of which the first, or that of the great toe, is the shortest and largest, and that of the second the longest. The *bases* (A) have flat articular surfaces to join them with the tarsus, and *heads* (c) or articular surfaces for the phalanges; the middle part is the *body* (B), which is convex above and broad beneath.

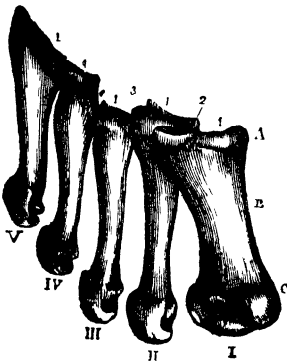

[§ 268. THE TOES consist of fourteen bones (fig. 143), of which there are but two rows

to the great toe (I), and three to the other toes (II, III, IV, V); their division is similar to that of the fingers, into base, body, and head, but they are much shorter and flatter.

The foot of man is distinguished from the corresponding part in the quadrumana by its capability of being planted flat upon the ground, and the strength of the base thus afforded; the parallelism and magnitude of the great toe, the advanced position of the astragalus, the backward extension of the heel, the fixed condition of the tarsus, the

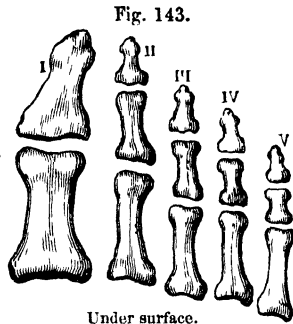

Fig. 143.

Under surface.

strength of the metatarsal bones and those of the phalanges, form the distinctive differences between the foot of man and that of monkeys: when we notice an ourang or chimpanzee attempting to walk erect, the foot is seen resting on its outer side, the heel scarcely projecting, and they can only sustain the erect position by supporting their hands upon some body.

[§ 268*. The internal side of the foot is constructed as an arch, for lodging and protecting the blood vessels, nerves, and tendons of the toes; this arch likewise forms a spring by which sudden shocks are diminished, the elasticity of the tarsal and metatarsal articulations contributing to this end; the jar being broken thereby before it is transmitted to the limb. This provision is still further developed in the feet of certain animals, like the cats, which bound after their prey; in addition to the elasticity of the tarsus and metatarsus, their feet are supplied with elastic pads, to break the shocks occasioned by their springing habits.

[§ 269. THE SCAPULAR, like the pelvic arch, consists of three pair of bones, the scapula, the coracoid and the clavicle, which are the homologues of the ilium, the ischium, and the pubis; early in life, in man, the coracoid becomes soldered to the scapula, and is described as a process of the latter bone, but it exists as a distinct element of the scapular arch in reptiles and birds, and in the *Ornithorhynchus* among the monotrematous mammalia.

Fig. 144 shews the right half of the scapular arch of man *in*

situ. The clavicle (1) is seen resting its internal head upon the

Fig. 144.

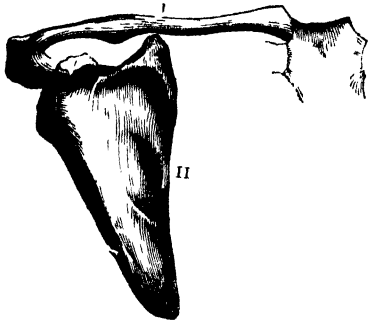

first bone of the sternum, and having its external end attached by ligaments to the acromion process of the scapula; the clavicle maintains the shoulder at a fixed distance from the trunk.

[§ 270. THE SCAPULA is a large flat bone, situated on the upper and external part of the back. It is of a triangular form, and at its upper

and external angle expands to form a shallow cavity, called

Fig. 145.

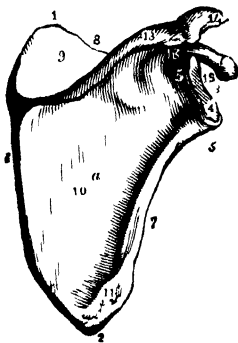

Fig. 146.

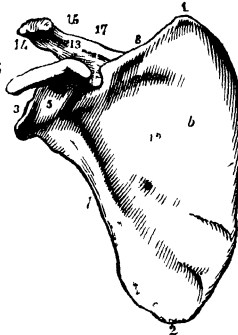
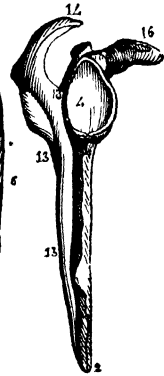

Fig. 147.



the *glenoid cavity* (4), in which the head of the humerus is received; on the upper part of the body a prominent ridge of bone rises (13), which passes upwards and outwards, and terminates in the *acromion process* (14), which is expanded over the top of the joint, forming the bony projection of the shoulder. The *coracoid process* (16) is attached by a thick root to the anterior and upper part of the neck of the bone (5), and curves forwards and out-

wards before the glenoid cavity; the scapula is articulated by the smooth face of the acromion process (15), to the clavicle; and affords an extensive attachment to the muscles of the shoulder and those belonging to the arm and fore-arm; this bone is present in all animals possessing anterior members, although its form undergoes many changes in birds and reptiles. Fig. 145 represents the posterior view. Fig. 146, the anterior view. Fig. 147, a profile of the scapula.

[§ 271. THE CLAVICLE, so called from its resemblance to an ancient key, is divided into a body, two extremities, two articular surfaces, and two processes. Its shape is that of a small Italic *f*, placed horizontally; its inner or *sternal extremity* (1) is very large, and irregularly cylindrical; upon its point is a large articular surface (2), by which it joins with the interarticular cartilage placed between it and the sternum; the round arched body expands and forms the scapular extremity (4), having on its under surface a tuber (5), for the attachment of ligaments, and upon the outer extremity a plain articular surface (6), by which it is united to the acromion process of the scapula. The principal use of this bone is to keep the shoulders apart, and complete the resistance of the scapular arch in those animals, as the quadrumana and rodents, that use their anterior members as prehensile instruments, and in the bats and birds, whose anterior members are organs of flight; as the down-stroke of the wing tends to force the humerus inwards; in birds, likewise, the coracoid bone appears as a distinct element of the arch.

Fig. 148.

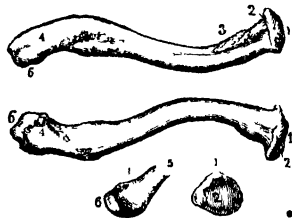

[§ 272. THE HUMERUS (fig. 149) is the homologue of the femur, and, like it, is formed of a head, neck, body, and condyles. The large round head (1) is received into the shallow glenoid cavity (fig. 147, 4), by which great freedom of motion in all directions is obtained; the neck (5) is short and thick, and the body (6) appears as if the upper part were twisted outwards, and the lower part inwards, the outer side of the body presenting a rough surface (9) for the attachment of muscles. The lower extremity of the shaft is enlarged to form a pulley-like surface, upon which the *ulna* moves in one plane; the outer

condyle (13) projects but little, whilst the inner condyle (14)

Fig. 149.

Fig. 150.

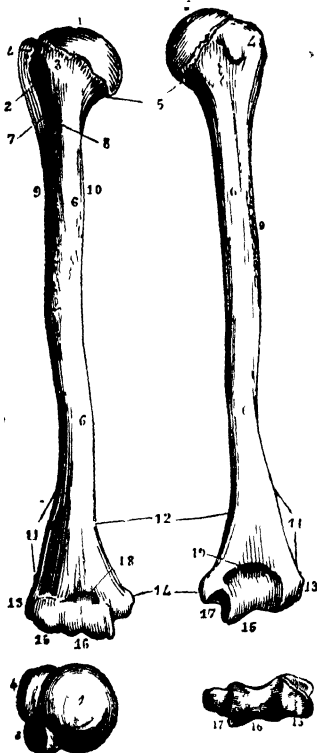

Fig. 151.

Fig. 152.

forms a considerable prominence which projects inwards; the condyles afford an extensive surface for the attachment of the muscles of the fore-arm; behind the inner condyle is a deep fossa (19), for receiving the olecranon process of the ulna, and above the condyles, on the front of the bone, is a pit (18) for receiving the coronoid process of the same. Fig. 149 gives a front view, fig. 150 a back view of the humerus; fig. 151, the round head and tubercles (3, 4); fig. 152, the lower surface of the condyles, (15) is the surface on which the head of the radius plays, (16) receives the sigmoid cavity of the ulna, and (17) is a groove for the passage of the ulnar nerve.

[§ 273. The fore-arm consists (fig. 153) of two bones, the **RADIUS** and the **ULNA**, which are the homologues of the *tibia* and the *fibula*. These bones lie nearly parallel to each other, the radius (1) on the outer, and the ulna (11) on the inner side of the arm; they are united by ligaments, and by a fibrous membrane stretched across the interspace between them; they have, however, a considerable range of motion upon each other and upon the humerus. The flexion and extension of the forearm is performed by the ulna (1), which forms, with the humerus, a true hinge joint. At its upper part we observe the olecranon process (fig. 153), which locks into a cavity (fig. 150, 19) on the posterior

surface of the humerus ; which acting as a stop, renders extension beyond the straight line impossible. The hand is attached to the lower end of the radius ; and as that part was designed to perform pronation and supination, a peculiar mechanical provision was necessary for these important motions. The round head of the radius (fig. 153, II) is bound by a firm annular ligament to the ulna (I), and the concavity on its surface is received in a corresponding convexity on the outer condyle of the humerus. Hence both bones move upon the humerus, in acts of flexion and extension, whilst the radius rolls upon the ulna, carrying with it the hand in pronation and supination, separate sets of muscles being assigned to each class of movements. It is only among the higher mammals that any motion is permitted between the bones of the fore-arm. These motions are most important in man ; for without them the hand would be incapable of a vast variety of movements so necessary to the full development of the purposes for which that instrument was designed. When the free motions between the bones of the fore-arm are impaired by injury

Fig 153.

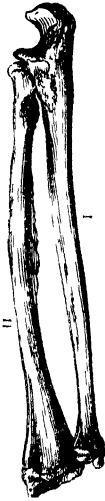
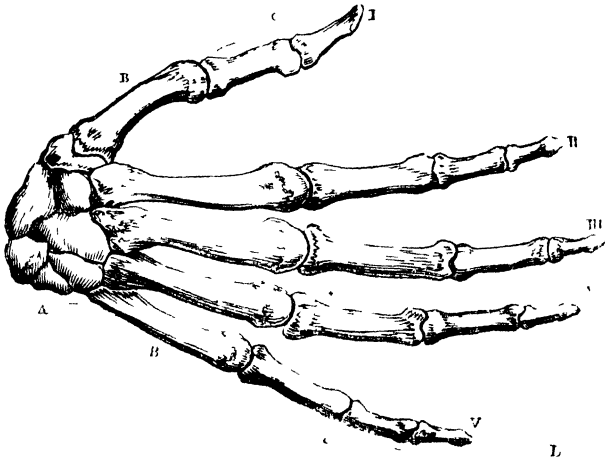

Fig. 154



or disease, we learn the amount of importance they confer upon the hand.

[§ 274. The HAND consists of the CARPUS, METACARPUS, and PHALANGES; of these, part of the carpus (fig. 154 A), with the radius, form the wrist joint; the metacarpus (B) forms the palm of the hand, and the phalanges (C) the fingers.

[§ 275. The CARPUS consists of eight bones, forming an

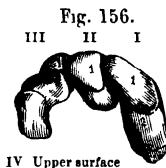

there are, in the *first* row (figs. 155, 156), on the outside the os scaphoides (I), on its inner side the os lunare (II), next it the os cuneiforme (III), and on the front of that bone the os pisiforme (IV): in the *second* row (figs. 157, 158), on the outside is the

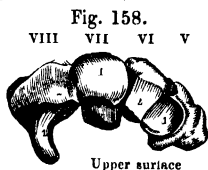
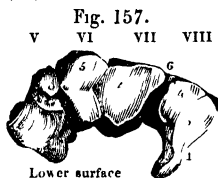

os trapezium (V), next to it the os trapezoides (VI), to its inner side, the os magnum (VII), and next to that the os unciforme (VIII). Of these bones the first row is articulated above with the radius, and the interarticular cartilage at the extremity of the ulna, and below with the second row; the second row articulates above with the first row, and below with the bases of the metacarpal bones.

[§ 276. The METACARPUS consists of five bones (fig. 158*), each of which is divided into its upper part, or *basis* (A); middle or body, *corpus* (B); and lower part or head, *caput* (C), which forms the knuckle, and projects when the fingers are bent. Upon the bases are articular surfaces for the carpal bones.

[§ 277. The thumb and fingers of each hand consist of fourteen pieces, or phalanges (fig. 159); of these twelve belong to the fingers, and are disposed in three rows, those of the middle finger (III) being longest, and of the little finger (V) shortest;

whilst the thumb (I) has but two, its middle phalanx being deficient, but they are stronger than those of the fingers.

[§ 277. The PHALANGES consist of base (fig. 159) (1), body (2), and head (3); they taper from the base, or upper part of the head, the intermediate part or body being rounded behind, and flat before, with two projecting lateral edges for giving attachment to the sheaths of the tendons.

[§ 278. In reviewing the structure of the upper extremity, we have seen that it consists of a series of levers joined together, and diminishing progressively in length. Thus, the arm is longer than the fore-arm; the latter is longer than the hand; and each joint of the fingers is shorter than the one which it succeeds. By this admirable arrangement the numerous joints in the hand permit that useful instrument to vary its motions in a thousand different ways, to adapt it to the various bodies it is designed to handle, grasp, and touch; whilst the long levers formed by the

arm and fore-arm allow the hand to be rapidly changed to a considerable distance in all directions. It is principally by the movements of the humerus upon the scapula, that the direction of the limb is given; the flexion and extension of the fore-arm

Fig. 158.*

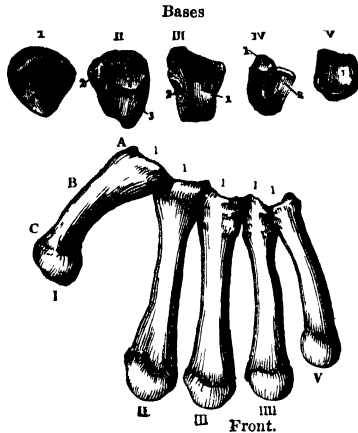
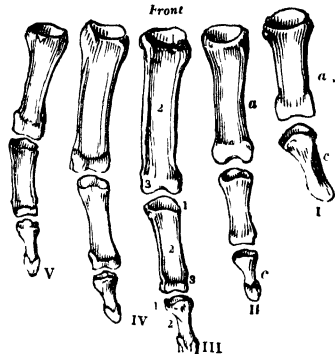

Fig. 159.



regulating the length ; whilst the multiplied movements of the thumb and fingers perform the special acts which the hand was designed so admirably to execute. The quadrumana, like man, have the thumb opposable to the other fingers. It is this, in fact, which forms the true character of the hand. But the bones of the thumb in man are more lengthened and powerful, in proportion to the other fingers, than in monkeys, whose hand does not equal his in perfection ; for monkeys can neither seize minute objects with that precision, nor grasp and support large ones with that firmness which is so essential to the dextrous performance of the multitudinous purposes for which the hand of man was designed.—T. W.]

1. PLAN OF THE ORGANS OF LOCOMOTION.

§ 279. The organs of progression in vertebrated animals never exceed four in number, and to them the term *limbs* is more particularly applied. The study of these organs, as characteristic of the different groups of vertebrate animals, is most interesting, especially when prosecuted with a view to trace them all back to one fundamental plan, and to observe the modifications, oftentimes very slight, by which a very simple organ is adapted to every variety of movement. No part of the animal structure more fully illustrates the unity of design, or the skill of the Intellect, which has so adapted a single organ to such multiplied ends. On this account we shall illustrate the subject somewhat in detail.

§ 280. It is easy to see, that the wing which is to sustain the bird in the air (fig. 164), must be different from the leg of the stag (fig. 160), which is to serve for running, or the fin of the fish (fig. 168) that swims. But, notwithstanding their dissimilarity, the wing of the bird, the leg of the stag, and the shoulder fin of the fish, may still be traced to the same plan of structure ; and if we examine their skeletons, we find the same fundamental parts.

§ 281. In the arm of man (fig. 78), the shoulder-blade is flat and triangular ; the bone of the arm is cylindrical, and enlarged at its extremities ; the bones of the fore-arm are nearly the same length as the humerus, but more slender ; the hand is composed of the eight small bones of the carpus, arranged in two rows, five metacarpal bones, which are elongated, and succeed those of the wrist ; five fingers of unequal length, one of which, the thumb, is opposed to the four others.

§ 282. In the stag (fig. 160), the bones of the fore-arm (*c, d,*) are rather longer than that of the arm (*b*), and the radius no longer turns upon the ulna, but is blended with it; the metacarpal or cannon-bone (*f*), is greatly developed; and being quite as long as the fore-arm, it is apt to be mistaken for it. The fingers (*g*) are reduced to two, each of which is surrounded by a hoof, at its extremity.

Fig. 160.



§ 283. In the arm of the lion (fig. 161), the arm bone (*b*) is stouter, the carpal bones (*e*) are less numerous, and the fingers (*f*) are short, and armed with strong, retractile claws (*g*). In the whale (fig. 162), the bones of the arm (*b*) and fore-arm (*c, d,*) are much shortened, and very massive; the hand is broad, the fingers (*g*) strong, and distant from each other. In the bat (fig. 163), the thumb, which is represented by a small hook, is entirely free, but the fingers

Fig. 161.

Fig. 162.



Fig. 163.

Fig. 164.

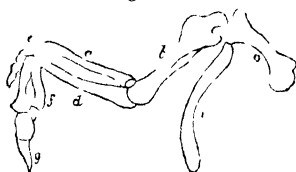

are elongated in a disproportionate manner, and the skin is stretched across them, so as to serve the purpose of a wing.

In birds, the pigeon, for example (fig. 164), there are but two fingers (*g*), which are soldered, and destitute of nails; and the thumb is rudimentary.

§ 284. The arm of the turtle (fig. 166) is peculiar in having,

Fig. 165

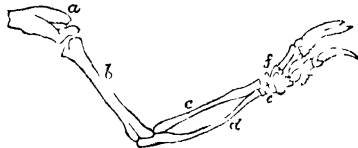

Fig. 166.



Fig. 167.



besides the shoulder-blade (*a*), the coracoid bone and the clavicle; the arm-bone (*b*) is twisted outwards, as well as the bones of the fore-arm (*c, d*), so that the elbow, instead of being behind, is turned forwards; the fingers (*g*) are long, and widely separated. In the sloth (fig. 165), the bones of the arm (*b*) and fore-arm (*c, d*) are very greatly elongated, and at the same time very slender; the hand is likewise very long, and the fingers (*g*) are terminated by enormous non-retractile nails. The arm of the mole (fig. 167) is still more extraordinary. The shoulder-blade (*a*), which is usually a broad and flat bone, becomes very narrow; the arm-bone (*b*), on the contrary, is contracted so much as to seem nearly square, the elbow projects backwards, and the hand (*e, f, g*) is excessively large and stout.

§ 285. In fishes, the form and arrangement of the bones is so peculiar, that it is often difficult to trace their correspondence to all the parts found in other animals; nevertheless, the bones of the fore-arm (*c, d*) are readily recognized. In the cod (fig. 168),

Fig. 168.

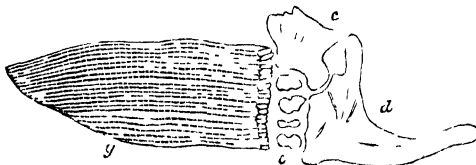

there are two flat and broad bones, one of which the ulna (*d*), presents a long point, anteriorly.

orly. The bones of the carpus (*e*) are represented by four nearly square little bones; but in these, again, there are considerable variation in different fishes, and in some genera they are much more irregular in form. The fingers are but imperfectly represented by the rays of the fin (*g*), which are composed of an infinitude of minute bones, articulated with each other. As to the humerus and shoulder, their analogies are variously interpreted by different anatomists.

§ 286. The form of the members is so admirably adapted to the especial offices which they are designed to perform, that by a single inspection of the bones of the arm, as represented in the preceding sketches, one might infer the uses to which they are to be put. The arm of man, with its radius turning upon the ulna, the delicate and pliable fingers, and the thumb opposed to them, bespeak an organ for the purpose of handling. The slender and long arm of the sloth, with his monstrous claws, would be extremely inconvenient for walking on the ground, but appropriate for seizing upon the branches of trees, on which these animals live. The short fingers, armed with retractile nails, indicate the lion, at first glance, to be a carnivorous animal. The arm of the stag, with his very long cannon-bone, and that of the horse also, with its single finger enveloped in a hoof, are organs especially adapted for running. The very slender, and greatly elongated fingers of the bat are admirably contrived for the expansion of a wing, without increasing the weight of the body. The firm and solid arm of the bird indicates a more sustained flight. The short arm of the whale, with his spreading fingers, resembles a strong oar. The enormous hand of the mole, with its long elbow, is constructed for the difficult and prolonged efforts requisite in burrowing. The twisted arm of the tortoise can be applied to no other movement than creeping; and, finally, the arm of the fish, completely enveloped in muscles (fig. 76), presents, externally, a mere delicate balancer, the pectoral fin.

§ 287. The posterior members are identical in their structure with the anterior. The bones of which they are composed are, 1. The *pelvis* (figs. 125 and 169), which corresponds to the shoulder blade; 2. The thigh bone, or *femur*, which is a simple bone like the humerus; 3. The bones of the leg, the *tibia* and *fibula*, which, like the radius and ulna, sometimes coalesce into one bone; and lastly, the bones of the foot,

which are divided, like those of the hand, into three parts, the tarsus, metatarsus, and toes. Their modifications are generally less marked than in the arm, inasmuch as there is less diversity of function; for in all animals, without exception, the posterior extremities are used exclusively for support or locomotion.

§ 288. The anterior extremity of the vertebrata, however varied in form, whether it be an arm, a wing, or a fin, is composed of essentially the same parts, and constructed upon the same general plan. This affinity does not extend to the invertebrata, for although in many instances their limbs bear a certain resemblance to those of the vertebrata, and are even used for similar purposes, yet they have no real affinity. Thus the leg of an insect (fig. 34), and that of a camel (fig. 169), the wing of a butterfly, and the wing of a bat, are quite similar in form, position, and use; but in the bat (fig. 163) and the camel (fig. 169), the organ has an internal bony support, which is a part of the skeleton; while the leg of the insect has merely a horny covering, proceeding from one of the rings of the body, and the wing of the butterfly is merely a fold of the skin; showing that the limbs of the articulata are constructed upon a different plan. It is by ascertaining and regarding these real affinities, or the fundamental differences existing between similar organs, that the true natural grouping of animals is to be attained.

2. OF STANDING, AND THE MODES OF PROGRESSION.

§ 289. STANDING, or the natural attitude of an animal, depends on the form and functions of the limbs. Most of the terrestrial mammals, and the reptiles, both of which employ all four limbs in walking, have the back-bone horizontal, and resting at the same time upon both the anterior and posterior extremities. Birds, whose anterior limbs are intended for a purpose very different from the posterior, stand upon the latter, when at rest, although the back-bone is still very nearly horizontal. Man alone is designed to stand upright, with his head supported on the summit of the vertebral column. Some monkeys can rise erect upon their hind legs; but this is evidently a constrained posture, and not their habitual attitude.

§ 290. In standing, it is requisite that the limbs should be so disposed that the centre of gravity may fall within the space included by the feet. If the centre of gravity be with-

out these limits, the animal falls to that side towards which the centre of gravity inclines. On this account, the albatros, and some other aquatic birds which have their feet placed very far back, cannot use them for walking.

§ 291. The more numerous and the more widely separated the points of support are, the firmer an animal stands. On this account, quadrupeds are less liable to lose their balance than birds. If an animal has four legs it is not necessary that they should have a broad base. Thus we see that most quadrupeds have slender legs touching the ground by only a small surface (fig. 169). Broad feet would interfere with each other, and only increase the weight of the limbs, without adding to their stability. Birds are furnished with long toes, which as they spread out, subserve the purpose of tripods.

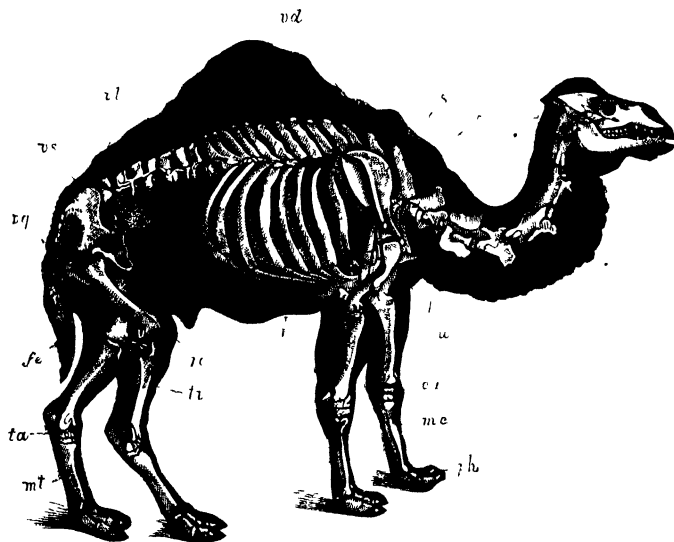

Fig. 169.—The Skeleton of the Camel.

v o, cervical vertebræ; *v d*, dorsal vertebræ; *v l*, lumbar vertebræ; *v s*, the sacrum; *v g*, caudal vertebræ; *c*, the ribs; *o*, scapula; *h*, the humerus; *c a*, the carpus; *m c*, the metacarpus; *p h*, the phalanges; *c u*, the radius and ulna; *f e*, the femur; *r o*, the patella; *t i*, the tibia; *t a*, the tarsus; *m t*, the metatarsus.

Moreover, the muscles of the toes are so disposed that the weight of the bird causes them to contract firmly, hence birds are enabled to sleep standing, in perfect security, upon their perch, and without effort.

§ 292. In quadrupeds, the joints at the junction of the limbs with the body bend freely in one direction only, that is, towards the centre of gravity; so that if one limb yields, the tendency to fall is counteracted by the resistance of the limbs at the other extremity of the body. The same antagonism is observed in the joints of the separate limbs, which are flexed alternately in opposite directions. Thus the thigh bends forwards, and the leg backwards; while the arm bends backwards, and the fore-arm forwards. Different terms have been employed to express the various modes of progression, according to the rapidity or the succession in which the limbs are advanced.

§ 293. PROGRESSION is a forward movement of the body, effected by successively bending and extending the limbs. WALKING is the ordinary and natural gait, and other paces are only occasionally employed. When walking is accomplished by two limbs only, as in man, the body is inclined forwards, carrying the centre of gravity in that direction, and whilst one leg sustains the body, the other is thrown forwards to prevent it from falling, and to sustain it in turn. For this reason, walking has been defined to be a continual falling forwards, interrupted by the projection of the leg.

§ 294. The throwing forwards of the leg, which would require a very considerable effort were the muscles obliged to sustain the weight of the limbs also, is facilitated by a very peculiar arrangement; that is, the joints are perfectly closed up, so that the external pressure of the atmosphere is sufficient of itself to maintain the limbs in place, without the assistance of the muscles. This may be proved by experiment. If we cut away all the muscles around the hip-joint, the thigh-bone still adheres firmly to the pelvis, but the moment a hole is pierced, so as to admit air into the socket, it separates.

§ 295. In ordinary walking, the advancing leg touches the ground before the other is raised; so that there is a moment when the body rests on both limbs. It is only when the speed is very much accelerated, that the two actions become simultaneous. The walking of quadrupeds is a similar process,

but with this difference, that the body always rests on two legs at least. The limbs are raised in a determinate order, usually in such a manner that the hind-leg of one side succeeds the fore-leg of the opposite side. Some animals, as the giraffe, the lama, and the bear, raise both legs of one side at the same moment. This is called *ambling* or *pacing*.

§ 296. RUNNING consists of the same successions of motion as walking, so accelerated that there is a moment between two steps when none of the limbs touch the ground; in the horse and dog, and in most mammals, a distinction is made between the walk, the trot, the canter, and the gallop, all of which have different positions or measures. The *trot* has but two measures. The animal raises a leg on each side, in a cross direction; that is, the right fore leg with the left hind leg, and so on. The *canter* has three measures. After advancing the two fore legs, one after the other, the animal raises and brings forward the two hind legs, simultaneously. When this movement is greatly urged, there are but two measures; the fore legs are raised together, as well as the hind legs, it is then termed a gallop.

§ 297. LEAPING consists in a bending of all the limbs, followed by a sudden extension of them, which throws the body forwards with so much force as to raise it from the ground, for an instant, to strike it again at a certain distance in advance. For this purpose, the animal always crouches before leaping. Most animals make only an occasional use of this mode of progression, when some obstacle is to be surmounted; but in a few instances, this is the habitual mode. As the hind legs are especially used in leaping, we observe that all leaping animals have the posterior members very much more robust than the anterior; as frogs, kangaroos, jerboas, and hares. Leaping is also common among certain birds, especially among sparrows, thrushes, &c. Finally, there is also a large number of leaping insects, such as fleas, grasshoppers and crickets, in which we find the posterior pair of legs much more developed than the others.

§ 298. CLIMBING is merely walking upon an inclined or upright surface. It is usually accomplished by means of sharp nails; and hence many carnivorous animals climb with great facility, such as the cat tribe, lizards, &c., many birds, the woodpeckers and parrots, &c., have the toes arranged in two

divisions, so as to grasp branches like a forceps. Others like the bears employ their arms for this purpose; monkeys use their hands and tails; and parrots their beaks. Lastly, there are some whose natural mode of progression is climbing; such as the long-armed sloths, which, when placed upon the ground, move very awkwardly; yet their structure is by no means defective, for in their accustomed movements upon trees, they use their limbs with very great adroitness.

§ 299. Most quadrupeds can both walk, trot, gallop, and leap; birds walk and leap; lizards neither leap nor gallop, but only walk and run, and some of them with great rapidity. No insect either trots or gallops, but many of them leap. Yet their leaping is not always the effect of the muscular force of their legs, as with the flea and grasshopper; but some of them leap by means of a spring, in the form of a hook, attached to the tail, which they bend beneath the body, and which, when let loose, propels them to a great distance, as in the *Podurellæ*. Others leap by means of a spring, attached beneath the breast, which strikes against the abdomen when the body is bent; as the spring-beetles (*Elaters*).

§ 300. FLIGHT is accomplished by the simultaneous action of the two anterior limbs, the wings, as leaping is by that of the two hinder limbs. The wings being expanded, strike and compress the air, which thus becomes a momentary support, upon which the body of the bird rests. But as this support very soon yields, owing to the slight density of the air, it follows that the bird must make greater and more rapid efforts to compensate for this disadvantage. Hence it requires a much greater expenditure of strength to fly than to walk; and therefore, we find the great mass of muscles in birds concentrated about the breast (fig. 77). To facilitate its flight, the bird, after each stroke of the wings, brings them against the body, so as to present as little resisting surface to the air as possible, and for the same end all birds have the anterior part of the body very slender.

§ 301. Some quadrupeds, as the flying squirrel, *Galeopithecus* [and flying lizard, *Draco volans*], have a fold of the skin at the sides, which in some extends to the legs, thereby enabling them to leap from branch to branch with more facility. But this is not flight, properly speaking, since none of the peculiar operations of this act are performed. There are also some

fishes, whose pectoral fins are so extended as to enable them to dart from the water, and sustain themselves for a short time in the air; and hence they are called flying fishes. But this is not truly flight.

§ 302. SWIMMING is the mode of locomotion employed by the greater number of aquatic animals. Swimming has this in common with flight, that the medium in which it is performed being also the support of the body, readily yields to the impulse of the fins. But water being much more dense than air, and the body of most aquatic animals being nearly the same weight as the water it displaces, it follows, that in swimming, very little effort is requisite to keep the body from sinking. The whole power of the muscles is consequently employed in progression, and hence swimming requires much less muscular force than flying.

§ 303. Swimming is accomplished by means of various organs, designated under the general term *fins*, although, in an anatomical point of view, these represent very different parts. In whales, it is the anterior extremities, and the tail, which are transformed into fins. In fishes, the pectoral fins, which represent the arms, and the ventral fins, which represent the legs, are employed for swimming, but they are not the principal organs; for it is by the tail, or caudal fin, that progression is principally effected. Hence the swimming of a fish is precisely that of a boat under the sole guidance of the sculling-oar. In the same manner as a succession of strokes, alternately right and left, propels the boat straight forwards, so the fish advances by striking alternately right and left with its tail. To advance obliquely, it has only to strike in the opposite direction. Whales, on the contrary, swim by a vertical movement of the tail; and it is the same with a few fishes also, such as the rays and the soles. The air-bladder facilitates the rising and sinking of the fish, by enabling it to vary the specific weight of its body.

§ 304. Most land animals swim with more or less ease, by simply employing the ordinary motions of walking or leaping. Those which frequent the water, like the beaver, or which feed on marine animals, as the otter, the duck, and other palmipedes, have webbed feet, the toes being united by membranes, which, when expanded, act as paddles.

§ 305. There is also a large number of invertebrate animals,

in which swimming is the principal, or the only mode of progression. Lobsters swim by means of a vertical motion of their tail. Other crustacea have a pair of legs fashioned like oars; as the posterior legs in sea crabs, for example. Many insects, likewise, swim with their legs, which are abundantly fringed with hairs, to give them surface; as the little water boatmen (*Gyrinus*, *Dytiscus*), whose mazy dances on the summer streams every one must have observed. The cuttle-fish uses its long arms as oars, and some star-fishes (*Comatula*, *Euryale*), use their rays with great adroitness. Finally, there are some insects which have their limbs constructed for running on the surface of water, as the water spiders (*Ranatra*, *Hydrometra*).

§ 306. A large number of animals have the faculty of moving both in the air and on the land, as is the case with most birds, and a large proportion of insects. Others move with equal facility, and by the same members, on land and in water, as some aquatic birds and most reptiles. The latter have received the name amphibia on this account. There are some which walk, fly, and swim, as ducks and water-hens; but they do not excel in either mode of progression.

§ 307. However different the movements of the limbs may appear to us, according to the element in which they are performed, we see that they are the effect of the same mechanism. The contraction of the same set of muscles, causes the leg of the stag to bend in leaping, the wing of the bird to flap in flying, the arm of the mole to strike outwards in digging, and the fin of the whale to row in swimming.

CHAPTER SIXTH.

NUTRITION.

§ 308. THE second class of functions are those which relate to nutrition and the perpetuation of the species ; the functions of *vegetative* or *organic* life.

§ 309. The increase of the volume of the body requires additional materials. There is also an incessant waste of particles, which, having become unfit for further use, require to be carried out of the system. Every contraction of a muscle expends the energy of some particles, whose place must be supplied by others. These supplies are derived from every natural source, the animal, vegetable, and mineral kingdoms ; and are received under every variety of solid, liquid, and gaseous form. Thus, there is a perpetual interchange of substance between the animal body and the world around. The conversion of these supplies into a suitable material, its distribution to all parts, and the assimilation and appropriation of it to the growth and sustenance of the body, is called NUTRITION, in the widest sense of the term.

§ 310. In early life, during the period of growth, the amount of substances received is greater than that which is lost. At a later period, when growth is completed, an equilibrium between the matters received and those rejected is established. At a still later period, the equilibrium is again disturbed, more is rejected than is retained, decrepitude begins, and at last the organism becomes exhausted, the functions cease, and *death* ensues.

§ 311. The solids and fluids taken into the body as food are subjected to a process called *Digestion*, by which the solid portions are reduced to a fluid state, the nutritive particles separated from the excrementitious, and the whole prepared to become blood, bone, muscle, &c. The residue is afterwards expelled, together with those particles of the body which require to be renewed, and those which have been derived from the blood by several processes, termed *Secretions*. Matters in a gaseous form are also received and expelled with the air we

breathe, by a process called *Respiration*. The nutritive fluids are conveyed to every part of the body by currents, usually confined in vessels, and which, as they return, bring back the particles which are to be either renovated or expelled. This circuit is termed the *Circulation*. The function of Nutrition, therefore, combines several distinct processes.

SECTION I.

OF DIGESTION.

§ 312. DIGESTION, or the process by which the nutritive parts of food are elaborated and prepared to become blood, is effected in certain cavities, the *stomach* and *intestines*, or *alimentary canal*. This canal is more or less complicated in the various classes of animals; but there is no animal, however low its organization, which is destitute of a digestive sac.

[§ 313. In the Hydraform POLYPIFERA, as in the common fresh-water polype (*Hydra viridis*), the body consists of a digestive sac, with a row of simple tentacula disposed around the mouth, fig. 170. When the polype is watching for its prey

Fig. 170.



The *Hydra viridis*.

it remains expanded, with its tentacula widely spread in all directions, to seize a passing victim. No sooner does a larve, or worm, or crustacean, impinge upon one of these organs, than it is arrested in its course as if by some magical influence: it appears fixed to the almost invisible thread, and in spite of its efforts, is unable to escape. The prey, seized in this manner, and represented in fig. 170, is conveyed into the stomach (*a*), which has the appearance of a delicate film, stretched over the contained animal. If we watch attentively the process of digestion, we observe the outline of the included victim gradually becoming more indistinct: soon are the soft parts dissolved, and reduced to a fluid mass; and if any hard parts remain, as the shells of *Cypris* or *Daphnia*, these are expelled through the oral aperture. It is impossible to say by what process the nutritive product of

digestion enters the system of the hydra, as no vessels have been discovered in them; that the colour of the granular parenchyma depends in some measure on the nature of the food is satisfactorily shown; thus, when a polype feeds upon red larvæ, or upon black planariæ, the granules acquire a similar hue, although the fluid in which they float remains colourless; these granules move about in the parenchyma of the animal, and give the appearance of globules of blood undulating at large through the general tissue of the polype. Should the *Hydra* be made to fast for a considerable time, the granules lose their colour, and become almost transparent, in a manner similar to that by which the blood-globules of frogs lose their redness during the winter months, when deprived of nourishment.

[§ 314. The researches of Ehrenberg have demonstrated that the INFUSORIA admit of a natural division into two groups, founded on the degree of development of their digestive organs; the one group comprehends those in the interior of whose bodies numerous cellular globules are seen, into which alimentary matters pass: from the many gastric cavities possessed by these animalcules they are called POLYGASTRICA (fig. 171). In the second group we find a more perfect organization; the mouth is large, opening into an esophagus and stomach, in which are found gastric teeth, a distinct intestine, and anus; around the head are numerous ball-shaped bodies, furnished with cilia, which perform motions resembling those of a revolving wheel. The group is therefore called ROTIFERA (fig. 172). The structure of the digestive organs of many of the inferior forms of polygastrica is still involved in much obscurity; but in the higher forms, as in *Leucophrys patula* (fig. 171), these organs become visible when the animalcule has been fed with minute particles of carmine diffused through the water. The body is covered with long cilia, which form a circle round the mouth, their vibrations causing currents of water to flow therein, together with the minute particles on which *Leucophrys* subsists; the intestine is seen taking a winding course through the body, having appended to its walls numerous globular cells, many of which are distended with colouring

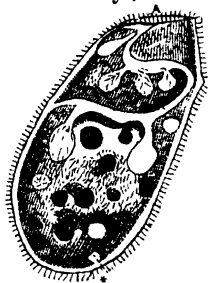

Fig. 171.—*Leucophrys patula*.

matter, and forming a natural injection of the gastric cavities; the anus opens at *, from which egesta are often seen exuding.

[§ 314. The *Eosphora najas* is typical of the rotifera. The body (fig. 172) is enclosed in a double elastic tunic, into which the muscles are inserted; its anterior part is truncated, and furnished with globular bodies armed with vibratile cilia; this rotatory apparatus is moved by muscles inserted into the base of the ciliiferous organs; the eyes are seen at *a, a, b*; the pharynx (*c*) is large and capacious, and the stomach (*d*) is provided with a triturating apparatus, which in many allied genera is armed with jaws. The intestine terminates in the anus at *d*; the ovary, with many ova, is seen at *f*. The posterior extremity of the body is furnished with a pair of forceps, by which the rotiferæ attach themselves at pleasure.

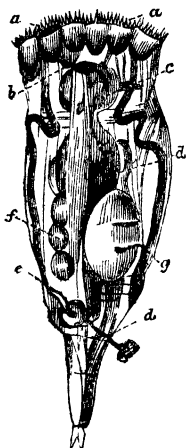

Fig. 172. — *Eosphora najas*.

[§ 315. The digestive organs in the ACALEPHÆ present many phases of development; in some, their pendant arms are traversed by tubes, through which aliments pass to reach the gastric cavity. The most remarkable structure of this class exists in the *Rhizostoma Cuvieri*, of which a longitudinal section is seen in fig. 173; the gastric cavity (*b*), surrounded by four respiratory chambers, occupies the upper part of the disc; the peduncle, hanging from the centre of the disc, divides into eight arms, four of which are seen terminating in spongy expansions, and perforated with numerous apertures, leading into a common channel (*c*); these vessels traverse the centre of the tentacula; in the middle and upper part of each of the arms are numerous fimbriated folds, in which vessels ramify that likewise open into the central canals; these, uniting two and two, enter the gastric cavity by four principal trunks. The walls of the stomach are divided by delicate septæ from the four ovarian sacs (*d*), which open externally by distinct apertures (*a, a*); from the periphery of the stomach sixteen vessels radiate, which divide and anastomose as they proceed towards the margin of the disc, where they form a net-

work of vessels, in which the blood is exposed to the oxygenating influence of the water, whilst the rhizostome floats like a gigantic animalcule through the sea. The aliments gain admission to the stomach only through these absorbent tubes, which remind us of a type of structure so common in plants; in the *Medusa aurita* the mouth is large and patent, and can be closed by a sphincter muscle; the stomach is divided by septæ; in these cavities fishes are sometimes found, in different states of digestion.

The ciliograde tribe, as in the *Beroë pileus*, have a digestive tube, passing straight through the body;

from the walls of which numerous vessels take their origin, to traverse the structure of this most elegant acalèphe, the marvels of whose organization can only be understood after patient observation with the microscope.

[§ 316. The ECHINODERMS afford a striking illustration of the law of progressive development, in the structure of their skeleton, and internal organs. In the *Asterias* the mouth is surrounded by tubular tentacula, and protected by fasciculi of spines; the short esophagus leads into a capacious stomach, occupying the central disc, provided with a mucous lining, and covered by a muscular layer; from the stomach branches proceed into each ray; around these canals a number of cæcal processes cluster, regarded as rudimentary glands: in *Ophiura* and *Euryale* the cæcal processes are absent. In *Comatula*, which connects the sea-stars with the urchins, the stomach occupies the central disc, and leads into a long intestine, which makes two turns around that organ. The mouth forms a large opening at one side of the under surface, and the intestine terminates in a prominent aperture, at the opposite side. In

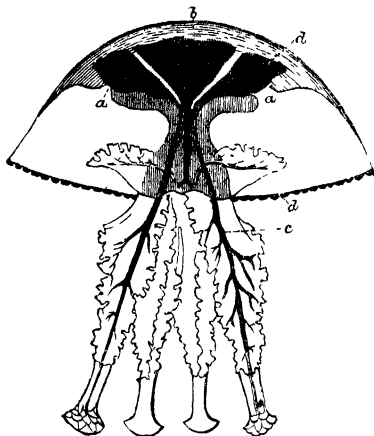

Fig. 173.—*Rhizostoma Cuvieri*.

the urchins the mouth is for the most part armed with jaws and teeth, and the oral and anal openings, gradually becoming more separate, occupy distinct positions on the shell; in *Echinus* and *Cidaris*, the mouth is found at the under pole, and the anus at the upper pole of their globular shells. Fig. 174 shows the structure of a common urchin (*Echinus esculentus*); the test

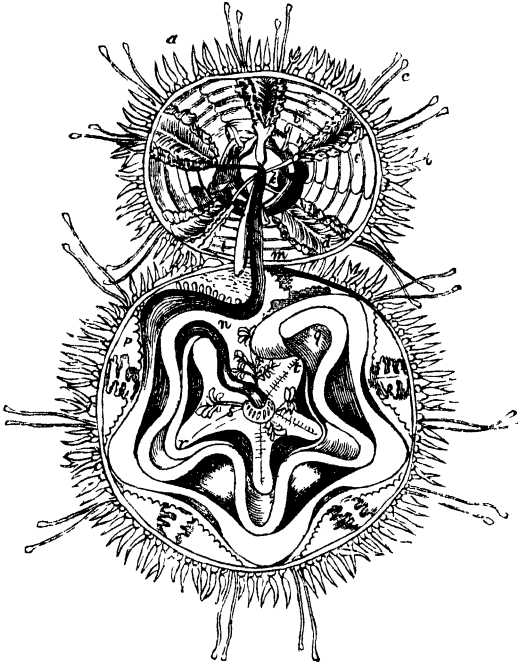

Fig. 174.—The anatomy of the *Echinus esculentus*.

is divided near its equator, and the small section is raised to shew the mouth from above; *k, h* is the lantern, with the pyramids and teeth; the esophagus (*m*) is long and delicate, and continuous with the stomach (*n*); the first convolution of the intestine is seen at *o*, and the second at *q, r*; the rectum (*s*) terminates in the centre of the opening formed by the circle of ovarian plates, and surrounded by the branching

ovaries (*t*), which open by canals passing through each of the five ovarian plates. The auricles surrounding the mouth (*i*) give attachment to the lantern; the ambulacral avenues (*e*) give passage to tubular feet; the simple spines (*a*) arming the shell are moved by muscles; the small trident spines, or pedicellariæ (*b*), move like forceps, and the long tubular feet (*c*) are protruded by the injection of a fluid; an oblong vesicle (*l*) opens near the mouth; the intestine is retained *in situ* by a delicate mesentery (*p*), on which blood-vessels ramify; currents of water flow constantly through the shell, their course being directed by the vibratile cilia covering the lining membrane of the test; the net-work of blood-vessels ramifying upon these membranes is therefore bathed by the sea-water, and maintained in a state of oxygenation, so that the whole interior of the shell of urchins is a great respiratory chamber.

In the *Holothuria* (fig. 232) the long and uniform intestinal canal makes several convolutions before terminating in the cloaca; around the mouth are numerous cæcal salivary vessels; a mesentery retains the intestine, and affords an extensive surface for the ramification of blood-vessels; the respiratory tubes are distinct from the general cavity of the body, and form an arborescent organ like a rudimentary lung.

[§ 317. In the BRYOZOAN POLYPIFERA, as the *Plumatella* (fig. 175), the digestive organs present a much higher phase of development than in the hydraform group, and manifest an approach to the type of the tunicated mollusca. The mouth is surrounded by a circle of ciliated tentacula, the vibrations of which cause currents of water to flow towards the oral aperture; the possession of ciliated tentacula forming one of the distinctive features of this group. The mouth, situated in the centre of the tentacular circle, leads into a long sacculated stomach, the walls of which are studded with glandular specks, or biliary follicles. From about the middle of the stomach the intestine proceeds, and ascending close to its walls, opens by a rectum near the mouth (*c*), in such a position that the excrementitious matter ejected therefrom is at once carried away by the currents sweeping round this region; the intestinal canal is attached to the sac by muscular bands, and floats freely in the visceral cavity. The tegumentary sheath is an organic portion of the polype, and, after enclosing

the internal organs, is reflected over the aperture of the cell, and becomes continuous with the tentacular circle. In consequence of this union between the polype and its cell, it follows, that when the animal retires therein, that portion of the tunic (*c*) pushed outwards by the exit of the polype, is drawn inwards on its retreat by a process of in-



Fig. 175.—*Plumatella repens*.—*a*, natural size; *b*, the same magnified.

that the flexible extremity of the cell is at the same time a sheath for the body, a support to the tentacula, and a door for closing it. In fig. 175, muscular bands are seen passing from the inner membrane of the cell to the body of the polype, by which the retraction of the animal and the invagination of the superior part of the cell is effected. At *a*, we see the natural size of the polypedom of *Plumatella*; at *b* and *c*, the cells and polyps magnified and protruded in search of prey; at *d*, the polype withdrawn into its cell, and the orifice closed by the retraction (*c*) of the integument.

[§ 318. In the TUNICATED MOLLUSCA the digestive organs are very simple. At the bottom of the cavity formed by the muscular mantle is found the mouth, a simple absorbent tube, opening into the stomach; that organ is surrounded by the follicles of the liver, the ducts from which enter its cavity; the short intestine terminates near the ventral aperture of the muscular sac.

[§ 319. In the CONCHIFERA, as in the oyster (*Ostrea edulis*, fig. 176), the mouth, surrounded by four labial plates (*r*), opens into an oval stomach (*a*); the intestine (*d*, *f*) makes

two turns through the body, terminating in the rectum (*g*), at the posterior border of the shell; the liver (*l*) is very large, surrounding the digestive tube, and the biliary ducts open into the stomach, as in the tunicata; the large branchial leaflets (*h*, *k*) for respiration are covered by the mantle (*l*); in them we find the cells for lodging the ova; the adductor muscle (*g*, *h*) serves for closing the valves of the shell, and at its internal side is seen the heart (*i*).

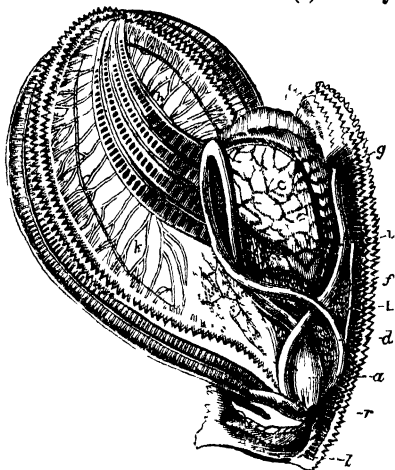

Fig. 176.—The anatomy of the *Ostrea edulis*

[§ 320. The GASTEROPODA possess more perfect organs of prehension than the preceding class; here we find not only complicated tubes for absorbing, but likewise organs for mastication and deglutition. Some gasteropoda (*Buccinum Murex Voluta*) are furnished with a singular and powerful organ, the proboscis, which they can protrude at pleasure to a considerable distance from the mouth. In the *Buccinum* (whelk) it is in the form of a hollow tube, surrounded by muscular fibres; on laying open this sheath we find a bifid cartilaginous tongue, provided with sharp, silicious recurved teeth, and sending out two long processes behind, into which numerous powerful muscles are inserted; on the right side of the tongue is the opening of the esophagus. The proboscis, in a state of repose, is lodged in a distinct cavity, into which it is retracted by numerous longitudinal muscles, having a close analogy in their arrangement with the fleshy columns in the heart of the mammalia. At the point where the esophagus diverges from the proboscis, in *Paludina vivipara* (fig. 35), it is surrounded by two salivary glands, which insert their ducts at this part; these glands are always considerably developed in this class;

the esophagus now runs a short course, and near the stomach dilates into a small crop, opening into a round membranous stomach, surrounded or imbedded in the substance of the liver; the length of the intestine is considerably less than that of the esophagus; it describes a turn, dilates into a wide colon, and terminates on the right side, under the open mantle; the liver is of considerable size, occupying the spiral turns of the shell, and, as in the preceding classes, pours its secretion by numerous ducts into the stomach. The digestive organs of other gasteropoda are formed after the same type.

The *Patella* (or limpet) feeds on marine vegetables, and is always found in situations where they are most abundant. It is deprived of a proboscis, but the mouth is armed with a long, slender, convoluted tongue, studded with rows of sharp, silicious recurved teeth (fig. 194), by which it exercises a filing process on its vegetable food. The wide sacculated esophagus opens into a large stomach of a lengthened form, surrounded by the liver; the long convoluted intestinal canal makes several turns through the structure of this organ, and finally opens into a dilated rectum; the long salivary vessels empty themselves into the esophagus.

The *Helix* (snail) and *Limax* (slug) have large lips, which may be regarded as the rudiments of a proboscis; the upper jaw of the garden snail (*Helix aspera*) is furnished with sharp teeth, which perforate and file down the leaves of plants. The short esophagus, having passed through the nervous collar, dilates into a large membranous stomach, contracted in the centre, into the posterior half of which the biliary ducts enter; the intestine, having made a turn through the liver, passes up along the right side of the body, and opens by a small orifice at the margin of the respiratory sac.

In the *Pleuro-branchus* the digestive organs are remarkable for their complex structure, and for the resemblance the stomach bears to the compound stomach of ruminating quadrupeds. The esophagus is dilated into a membranous bag, or paunch, into which the biliary ducts open; to this succeeds a globular muscular organ, analogous to the second or honeycomb stomach of ruminants; this leads to a membranous organ, provided internally with longitudinal folds of the lining membrane, the analogue of the leaflet, or manyplies, and, lastly, into a fourth,

or true chylic membranous stomach ; the second chamber is traversed by a muscular gutter, leading from the first to the third stomach.

The digestive organs of *Aplysia Camelus* (sea hare, fig. 177) are not less singular, being not only equally complex, but in addition, having the internal membrane of the second stomach, or gizzard, armed with cartilaginous bodies. The pharynx (*a*) is large and muscular ; the straight esophagus (*b*) having traversed the nervous collar (*m*), soon dilates into an ample membranous crop (*o, o*), turned into a semilunar form. This leads into a strong muscular gizzard (*p*), internally armed with rhomboid semi-cartilaginous plates, their action being analogous to the teeth found in the stomach of the lobster, and, like them, performing a similar bruising function. This musculo-cartilaginous organ opens into a third chylic stomach (*q*), the internal surface of which is furnished with sharp recurved horny spines, most numerous around the pyloric orifice ; into this region of the canal the ducts from the liver (*u, u*), and the termination of a glandular cæcal appendage, the pancreas, pour their secretions. It is extremely interesting, in a physiological point of view, to study

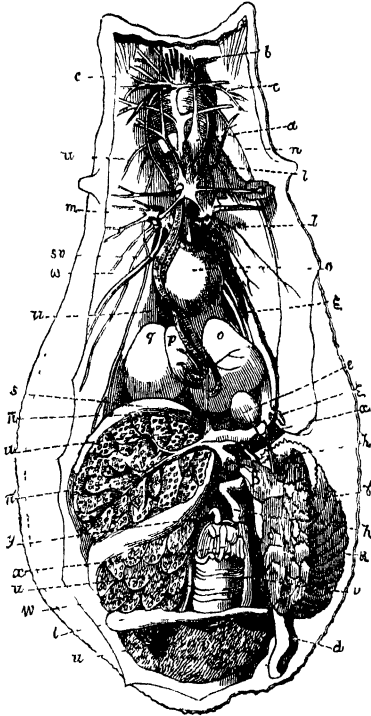

Fig. 177.—The anatomy of the *Aplysia Camelus*.

the development of the glandular organs connected with the assimilating functions. In *Holothuria* we have seen salivary vessels developed in the form of a series of blind processes surrounding the mouth. In the mollusca these organs are glandular, and extend through nearly half the body in *Aplysia* (*s, v*); the liver in the mollusca is likewise glandular, whilst in the articulated animals it is composed of a series of convoluted vessels. A rudimentary pancreas exists in some mollusca, which, like the salivary vessels in *Holothuria*, assumes the form of a long blind secreting sac. The intestinal canal (*s*) in *Pleuro-branchus* and *Aplysia* presents nothing very remarkable; it makes several turns through the structure of the liver, terminating in the rectum (*t*), which opens near the branchial, or respiratory aperture (*d*); the ovary (*v*), the oviduct (*v'*) and its appendage (*y*) occupy the posterior part of the body, surrounded by the testes (*w*) and the epididymus (*x*); ascending from the latter is seen the common generative canal (*z, z'*); the heart, consisting of an auricle (β) and a ventricle (ϑ), is placed near the branchiæ (B); the principal artery (ξ) runs forwards to supply the different organs situated at the anterior part of the body; the gastric artery (π) and the hepatic (π') artery are given off from the root of the principal trunk.

In *Bulla lignaria* the plates lining the muscular stomach, or gizzard, acquire the consistence of shell; they are moved by powerful muscles, and perform the part of stomach jaws. Among the gasteropodous mollusca the liver is a very voluminous organ, divided into many lobes, and very distinct from the intestine; thus, in the garden snail, whelk, &c., it occupies the several turns of the shell, embracing the convolutions of the intestine, and pouring its secretion, by distinct ducts, into the cavity of the stomach. In the slug and sea-hare it occupies a great portion of the muscular sac, common to the general visceral cavity. The liver of the *Doris* is remarkable, from the circumstance of possessing, besides ducts for pouring the biliary secretion into the stomach, a particular canal running in a direct course from the liver to the anus, and conveying a portion of the bile out of the system, without traversing the intestinal tube. This anatomical fact clearly proves that a portion of the bile is

excrementitious; and that the liver is partly an eliminating organ, destined to separate impure carbonaceous materials from the blood.

[§ 321. In the CEPHALOPODA the mouth is situated in the centre of the tentacular circle, and armed with two horny jaws, resembling the bill of a parrot, imbedded in the flesh, and moved by powerful muscles. In the interior of the mouth is a moveable cartilaginous tongue; the pharynx, lodged at the anterior part of the cephalic cartilage, is very large and muscular; the long and straight esophagus is surrounded by the nervous collar; the stomach, like that of *Aplysia*, presents three enlargements, forming a crop, a gizzard, and a true digestive stomach. The crop is a dilatation of the esophagus, leading into the second globular stomach; it is very muscular, and communicates by a narrow opening with the third, or true digestive cavity, remarkable for possessing a singular spiral valve, formed by a fold of the lining membrane winding round its inner surface; a modification of structure which we shall find repeated in some cartilaginous fishes, with which the cephalopoda are closely connected in many points of organization. Into this third chamber the ducts from the liver and pancreas pour their several secretions. The short intestinal canal, commencing at the pyloric orifice of the third stomach, ascends in front of the liver, and terminates in a valvular opening within the funnel, situated at the under part of the neck. The liver in the whole of this class is very large, and its copious secretion is poured by two ducts, along with the vessel, from the follicular pancreas into the third stomach, their orifices being provided with a valvular apparatus; the salivary glands, four in number, insert their superior pair of ducts into the pharynx, and their inferior pair into the esophagus.

The naked cephalopods, as the cuttle-fish, have a peculiar black, inky fluid, prepared by the glandular lining membrane of a particular bag, provided with a duct opening into the funnel. This fluid is secreted in great abundance, and being very miscible with water, forms a black cloud when injected into the sea; and by means of this singular provision these naked, defenceless animals are enabled to elude the pursuit of their numerous enemies. The inky fluid, abounding in

carbon, may probably be the excrementitious portion of the biliary secretion, eliminated from the system by a distinct organ, and thus made to serve a double use; it may, in fact, be analogous to that portion of the bile which is carried directly out of the body by a separate canal in the *Doris*.

[§ 322. In the ANNELIDA the digestive tube passes straight through the body. The mouth is provided with jaws, and the glands of the intestine are in the form of lateral cæcal appendages. The circulation is carried on by arteries and veins; their blood is red, and their respiratory organs are in the form of branchiæ, or internal air sacs.

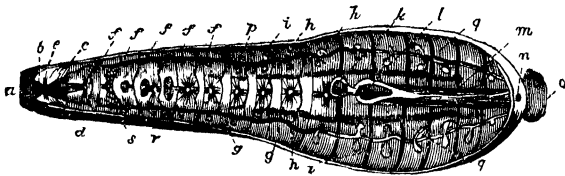

Fig. 178.—The anatomy of the *Hirudo medicinalis*.

[§ 323. The Leech (*Hirudo medicinalis*, fig. 178) has a triangular-shaped mouth (a), armed with three small teeth, a pharynx, composed of numerous muscles (c); the action of which is seen when the animal is engaged in sucking; the pharynx opens into a very large capacious sacculated stomach, with membranous parietes, united by small folds to the enveloping elastic tunic. The stomach is divided into numerous separate chambers (f, f, f, f), by transverse processes of the lining membrane, communicating with each other by central oval openings; it extends through about three parts of the entire length of the body, where it enters the intestine (m) by a valvular funnel-shaped opening; this tube passes between the two posterior cæcal appendages of the stomach, and terminates in a small aperture (n), at the margin of the posterior disc. The gangliated nervous chain (g) is uniform in its development throughout the body, giving off nerves at each ring; the respiratory vesicles (h) and the lateral vessels (i) encircle the body; the cæca of the digestive tube are seen at q; the

female genital parts at *r*, the male organs at *s*, and the anal sucker at *o*.

[§ 324. In some annelida the mouth is provided with a projectile proboscis, formed of the anterior part of the intestinal canal (fig. 233). This organ can be protruded and inverted like the finger of a glove, and, like the proboscis of predacious mollusca, has a set of muscles consecrated to effect its movements; in the *Nereis* it is very complicated, its free extremity being armed with long jaws, like the pincers of crustacea. The proboscis is regarded by some physiologists as a pharynx, armed with teeth, like those of star-fishes and echini; and being like them, capable of eversion. The stomach of *Nereis* is large, and from its posterior part two cæcal appendages project; its inner surface is armed with two small white teeth; the intestine passes straight through the body, and terminates in an aperture at the posterior part.

In the *Arenicola*, or sand-worm (fig. 233), we observe an additional complication of structure; to the short esophagus succeeds a complicated stomach, the first portion of which is simple, and the second very complex; into the latter division of the organ an immense number of branched appendages open, which appear to be a repetition of the biliary cæca observed in the star-fish; the stomach passes imperceptibly into the intestine, which terminates at the posterior part of the body. In the *Aphrodita aculeata*, or sea-mouse, a similar arrangement of the internal organs exists.

[§ 325. In the CRUSTACEA the digestive organs, when compared with those of the annelida, present a greater development of the organs of mastication. The jaws, which are numerous, move horizontally by powerful muscles; the mouth of the lobster and crab is situated on the under surface of the body, on each side of which we find the first pair of jaws expanded into a broad form, and sending out behind long pedicles for the insertion of powerful muscles, which have their points of attachment at the internal surface of the dorsal shield; succeeding these we find a second, third, fourth, fifth, and sixth pair of jaws: they are all, especially the three first pair, provided with sensitive palpi, in which it is probable the sense of taste resides. The esophagus is short, opening into a singularly complicated stomach, extended on a carti-

aginous skeleton, which renders it better adapted for bruising the aliments; the framework is composed of five semi-osseous pieces, provided internally with five teeth, surrounding the pylorus; three are large and two are small, being a repetition of the type of organization we have already described in some mollusca; the several plates of this skeleton are moved by muscles, so as to render it a powerful organ for bruising and fracturing the shells of the smaller mollusca, on which the crustacea prey; the calcareous parts of the stomach, like the external shell, are periodically cast off; the intestine forms a straight tube, extending from the pylorus to the tail, and terminating at the under surface of the central plate.

[§ 326. In the ARACHNIDA, as the common domestic spider (*Tegea domestica*), the mouth is provided with a pair of mandibles, armed with sharp claws, a venomous apparatus, and maxillæ or jaws; the mandibles are used for seizing, wounding, and retaining prey, whilst with the maxillæ they squeeze out and suck the contained juices of their victim. The esophagus is short, of a delicate texture, and opens into four crops, or stomachs; the tube then continues a straight and narrow canal, soon expanding into a muscular organ, surrounded by numerous adipose granules; this dilatation again contracts, and, before terminating in the rectum, undergoes another swelling; into this enlargement the biliary vessels terminate; the apparatus for spinning is formed of four hollow cylinders, the inferior parts of which are perforated like a sieve, their superior apertures communicating with ducts, from ramified vessels, destined for the secretion of the viscous fluid forming the filaments of the web; these tubes occupy a considerable portion of the abdomen, surrounding the termination of the intestine, and their sole function being the secretion of this fluid.

[§ 327. In INSECTS (fig. 179) the digestive organs are exceedingly varied and complicated; in some the mouth is provided with jaws for bruising (fig. 195), in others with an apparatus for sucking (fig. 196); the intestinal canal presents many enlargements, and, in some orders, is extremely convoluted, terminating at the posterior part of the body; there are distinct organs for the secretion of the bile and the saliva, and in some a rudimentary pancreas exists. Insects pass

through a series of metamorphoses, presenting changes both in their external form and internal structure, peculiar to each successive stage; from the egg is produced a vermiform animal, the larva; this, after a time, becomes the chrysalis, which finally develops the perfect insect. The jaws of insects (figs. 195 to 199) are constructed after the type we have already described in annelida, crustacea, and arachnida, that is to say, they are placed laterally, and moved by powerful muscles; we recognize two pair, an external pair, or mandibulæ (fig. 195, *m*), and an internal pair, or maxillæ (*j*); the mouth is furnished with a superior lip, or labrum, and an inferior lip, or labium. The development of the jaws is in strict relation with the natural food of the insect. The suctorial apparatus of the hymenoptera, that of the common bee (fig. 196), for example, is very singular; projecting from between the jaws we observe a sucker (*l*), composed of numerous rings; this organ, called by Treviranus the fleshy tongue, is situated at the commencement of the esophagus, in a horny sheath, formed by a prolongation of the labiæ, into which it can be withdrawn at pleasure. The canal of the sucker is very incon-

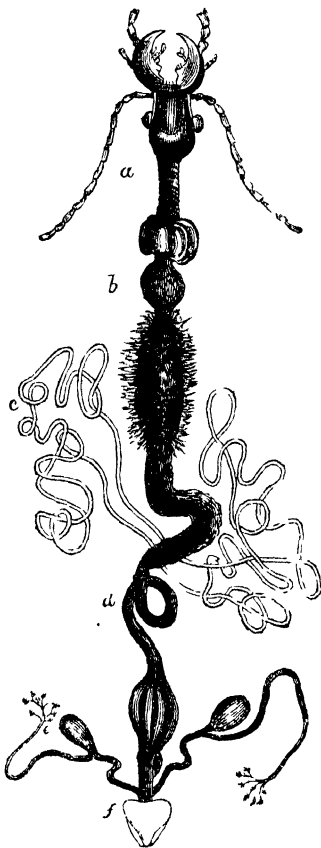

Fig. 179.—Digestive Organs of a Beetle.

a, the head which supports the jaws; *b*, the crop and gizzard; *c*, the chylific stomach; *d*, the intestine; *e*, secreting organs; *f*, the anus.

siderable, opening into a bag situated before the esophagus, into which it leads; the function of this bag appears, according to Burmeister, to be simply the rarefaction of its contained air, by which fluids in the proboscis and esophagus are pumped up into the first stomach. Insects provided with organs of mastication are deprived of this sucking apparatus; so that the development of maxillæ and succtorial instruments stand in an inverse ratio to one another. Burmeister is of opinion that, in insects deprived of a proboscis, the sucking bag is converted into a crop. The digestive organs of coleopterous insects present considerable variety in their structure; two sections of the order are formed on this difference alone; to the one section belongs those which have a globular muscular stomach, and short intestinal canal; to the other, those having a large membranous stomach, furnished with cæca, and a long tortuous intestine: the first group are carnivorous, the second phytophagous.

In *Cicindila campestris*, a carnivorous beetle, belonging to the first group, the short esophagus is dilated into a large glandular crop, opening into a small muscular gizzard, furnished internally with horny teeth, to perforate, rub down, and divide the aliments. In this muscular stomach we recognize a repetition of the type already described in some mollusca. To this organ, called by Ramdohr the plaited stomach, succeeds a flask-shaped chylic organ, furnished with a number of small glandular follicles, for secreting the gastric juice; at the point where this organ emerges into the pylorus, the ramified biliary vessels enter its cavity by four ducts; the intestine is short and straight, and develops a large muscular colon, soon terminating in an anal aperture.

The *Melolontha vulgaris* (common cockchafer) is an example of the structure of these organs in the coleoptera, comprised in the second group. Here we find the entire canal much increased in length and diameter; in this vegetable-eating insect the glandular organs are more voluminous, and from the sides of the ramified vessels numerous cæcal appendages are produced. The esophagus is dilated into a membranous crop; the gizzard is merely rudimentary; the stomach is in the form of a long glandular sac, twisted in a spiral man-

ner on itself, and receiving at its pyloric extremity the ducts of the highly complicated biliary organs ; the small intestine is short, and the colon has three dilatations in passing to the anal aperture ; the biliary vessels are very numerous, and their secreting surface is much increased by the development of innumerable small cæca from the sides of the large glandular vessels ; these two examples sufficiently prove that in the structure of the digestive organs of carnivorous and phytophagous insects a marked difference exists.

In the orthoptera, the *grasshopper* for example, the esophagus is dilated into a crop, opening into a round muscular stomach, the internal surface of which is armed with horny teeth ; the true chylic stomach succeeds this muscular organ, and is abundantly supplied with minute follicular appendages, and the secreting surface of its internal membrane is greatly increased by being thrown into delicate folds.

In the neuroptera the stomach and intestinal canal are allied to the preceding ; being nearly all predacious, their masticatory organs are highly developed, and the intestine passes nearly straight through the body.

Among the hymenoptera the digestive organs of the *bee* are the most interesting, as, in addition to the functions of nutrition, they form two important products, wax and honey. The sucker (fig. 196), leads into a large bag, situated on the anterior part of the esophagus, with which it communicates ; here the nectar obtained from flowers is converted into honey, which the bee disgorges at pleasure into the cells of the honeycomb. The esophagus terminates in a small gizzard, to which succeeds a large sacculated stomach ; into its pyloric portion the biliary vessels enter ; the diameter of the small intestine is inconsiderable, but that of the colon is very ample, the internal membrane of which has a glandular character, probably intended for the secretion of the wax.

In the hemiptera, the common *bug* has been examined with great care by Ramdohr ; he found its digestive organs to consist of two stomachs, the first being very capacious, and serving as a reservoir for the imbibed juices ; the second being very complicated, and provided with cæca ; to the small intestine succeeds a colon of considerable dimensions, provided with cæcal appendages. Connected with the termination of the in-

testinal canal of hymenopterous insects we find in some genera a venomous apparatus, consisting of a sting, a poison-bag, and secreting glandular organs. In the bee the sting is situated on the last segment of the abdomen, above the opening of the rectum; its base is surrounded by a small bag, embraced at its superior part by numerous muscles; two vessels, or cæca, enter this reservoir with their poisonous secretion; the sting is composed of two portions, the corresponding surfaces of which are grooved in a semilunar manner, so that, when approximated, a channel is formed; into this the duct of the poison-gland opens; each half being armed with small sharp recurved teeth, for retaining it in the wound. The sting has a sheath for its reception, and a particular set of muscles, under the control of the will, for effecting its movements.

Insects possess salivary vessels opening into different situations; some pour their secretion into the mouth, others into the commencement of the stomach (fig. 179). When we survey the varied forms which the biliary organs assume in the invertebrated animals, we may remark that among the articulata, respiring atmospheric air, these organs present an arrangement and structure very different from that observed in the aquatic articulata and mollusca; we are thus led to study more particularly the relations existing between the function of the liver as a secreting organ, and the respiratory apparatus as an exhalant system; the latter rejecting from the economy carbonaceous matter in a gaseous form, whilst the liver is constantly eliminating from the system secretions abounding in carbon and hydrogen, with other greasy and resinous materials.

[§ 328. The vertebrate animals resemble man in the general arrangement and division of the digestive organs (fig. 180); their principal differences depending upon the nature of the food; the purely carnivorous species having a shorter and simpler apparatus than those which are frugivorous: among the latter the stomach is often a compound organ. In the rodents, as the rat, there are two compartments, and in ruminants four distinct cavities, whilst in the carnivora it forms a simple bag, as in man. The intestinal canal bears a constant relation, in its length and development, to the kind of food to be digested. In general, the length of the intestine is greatest in the ruminants, varying from fifteen to twenty times the length

of the body ; in the sheep its proportionate length is as 28 to 1, whilst in the carnivora the proportion is about 4 to 1. In

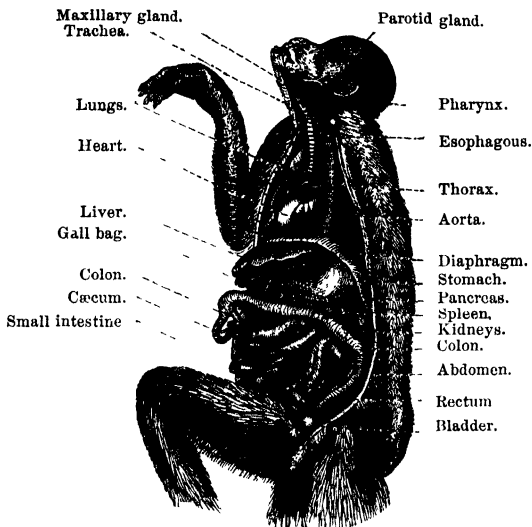

Fig. 180.—The Digestive Organs of a Monkey.

animals living upon a mixed diet of animal and vegetable food, the proportionate length of the intestine occupies an intermediate position ; in many rodents and monkeys the proportion is about 5 to 1 ; in man about 6 to 1. It may be stated, as a general rule, that the stomach is simple when the food consists of easily-digested animal substances, and is more complicated when the harder vegetable substances form the sustenance of the animal ; wherever a plurality of stomachs exist, there is one which is the true digestive cavity, the others subserving the processes of maceration and preparation.

[§ 329. Upon minute examination with the microscope, the mucous membrane of the stomach is found to be covered with small glandular follicles, which open internally ; these apertures are surrounded by an abundant vascular network, which also extends more deeply, and includes the cæcal and somewhat racemiform follicles. The glands are sometimes simple and

cylindrical, as in fig. 181, which represents the gastric glands of the pyloric portion of the stomach ; at others they are compound.

Fig. 181.

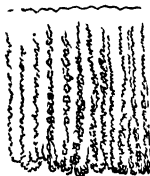
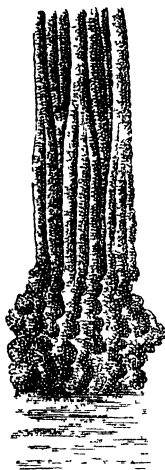

Fig. 182.



A



B

Fig. 182 represents the gastric glands in Man ; at A is a section of the stomach with all its elements, magnified about three diameters ; B represents the same glands, with their racemiform terminations distended with fluid, as seen with the microscope, and magnified about twenty diameters ; the contents of these glands are always dark and granular, and the membranous walls are of extreme delicacy. Lying between these are other glands of a larger size, and having a much more compound racemiform structure ; they lie separate from each other, and contain a transparent fluid, destined for a purpose different to that secreted by the gastric glands. Fig. 183 is an outline and highly magnified view of one of these human glands, from the middle part of the human stomach ; the excretory duct is composed of three branches, which proceed from a multitude of blind cells. Fig. 184 is another gland of the same class, from the vicinity of the pylorus, where they are more common than in other parts of the stomach ; it is viewed under the same magnifying power as fig. 181 ; this gland is more compound in structure, and its contents are more transparent than those of the other gastric glands. Much difference of opinion prevails regarding these organs : we have followed Wagner in our description, as they accord with our own microscopic investigations.*

[§ 330. The stomach of birds presents a repetition of the type of structure which we have already seen in insects. In the

* The stomach should be examined very soon after death, if correct observations are to be made.

common plover (*Vanellus cristatus*, fig. 185), the esophagus (*a*) opens into the proventriculus (*b*), the walls of which are studded with gastric glands, and the muscular stomach, or gizzard (*c*), is continued into the duodenum (*d*).

Fig. 183.

The gastric glands have their blind extremities turned towards the periphery, and their orifices open into the proventriculus, the granular contents are there voided under the most gentle pressure. These glands are, for the most part, simple externally; sometimes they form cæcal follicles (fig. 186, B); they are well-developed in the rasoires, where they are racemiform and lobular (*e*), or divided into many clusters, as in *f*. The common fowl, or goose, form excellent subjects for study, and they can always be procured in a fresh state. Fig. 187 represents the gastric glands in the glandular layer of the proventriculus of the common fowl; A is the gland of its natural size, and B is a magnified representation of the same, where the cæca appear like clusters of berries attached to a stem. In young birds the cellular structure of these glands is very conspicuous. Fig. 188, at A, are seen the simple gastric glands of a young owl, of the natural size; and at B, the same magnified, to shew the cellular structure of these organs.

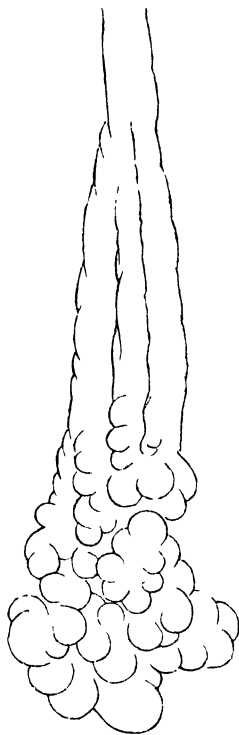

The relation in which these glands stand to the secretion of the gastric juice is not yet satisfactorily ascertained; the microscope shows that the orifices, and inner lining of the glands, are covered with a fine tessellated epithelium, whilst the parenchyma of the gland consists of minute granular corpuscles, about 1-200th of a line in diameter, not always nucleated, but formed of an uniform granular

mass, rather than of elements having a cellular character; the wall of the gland is formed of a transparent structureless mem-

Fig. 184.

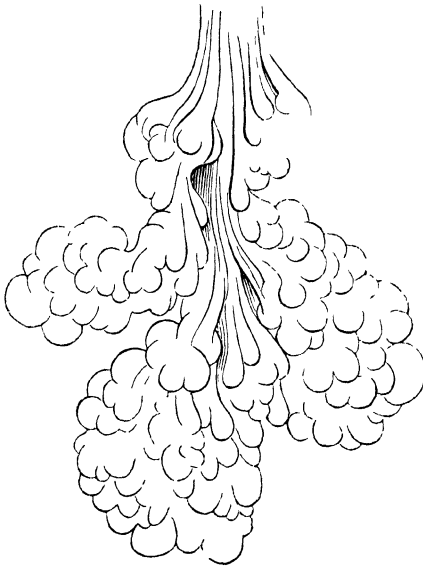

brane. Besides these granular corpuscles an albuminous fluid exudes from the walls of the stomach, and mingles with that yielded by the gastric glands; the gastric juice appears to be loaded with corpuscles, having a peculiar acid mixed with it, secreted by an appropriate set of glands, from which it is expressed by the contrac-

tion of the muscular coat of the stomach, when excited into action by the presence of food.—T. W.]

§ 331. The result of this process is the reduction of the food to a pulpy fluid called chyme, which varies in its nature with the food. Hence the function of the stomach has been named *chymification*. With this the function of digestion is complete in many of the invertebrata, and chyme is circulated throughout the body; this is the case in polyps, acalaphæ, some worms, and mollusca. In other animals, however, the chyme thus formed is transferred to the intestine, by a peculiar movement like that of a worm in creeping, which has accordingly received the name of *vermicular* or *peristaltic motion*.

§ 332. The form of the small intestine is less variable than that of the stomach. It is a narrow tube with thin walls, coiled

Fig. 185.

A

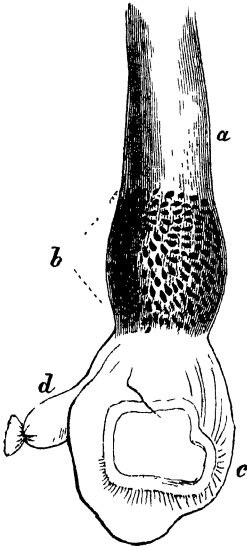

Fig. 186.

B

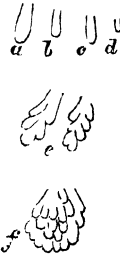

Fig. 186.—B, glands of the proventriculus of different birds; *a*, of the peacock (*Pavo cristatus*). *b*, of the *Cathartes percnopterus*. *c*, of *Casuarus galeatus*. *d*, of *Falco pygargus*. *e*, of the fowl. *f*, of the ostrich. — After Home, *Lecture on Comp. Anat.* ii. pl. 56.

in various directions in the vertebrate animals (fig. 180), but more simple in the invertebrata, especially the insects (fig. 179), Its length varies according to the nature of the food, being in general longer in herbivorous than in carnivorous animals. In this portion of the canal, the aliment undergoes its complete elaboration, through the agency of certain juices which here mingle with the chyme, such as the bile secreted by the liver, and the pancreatic juice secreted by the pancreas. The result of this elaboration is to produce a complete separation of the truly nutritious parts, in the form of a milky liquid called *chyle*. The process is called *chylification*; and there are great numbers of animals, as insects, crabs, lobsters, some worms, and most of the mollusca, in which the product of

digestion is not further modified by respiration, but circulates through the body as chyle.

Fig. 187.

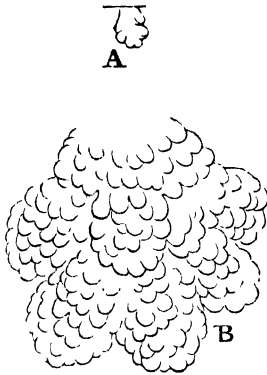
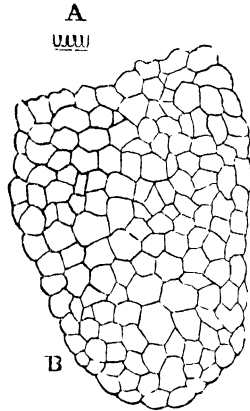

Fig. 188.



§ 333. The chyle is composed of minute, colourless globules, of a somewhat flattened form. In the vertebrata, it is taken up and carried into the blood by means of very minute vessels, called *lymphatic vessels* or *lacteals*, which are distributed everywhere in the walls of the intestine, and communicate with the veins, forming also in their course several glandular masses, as seen on a portion of intestine connected with a vein (fig. 189), and it is not until thus taken up and mingled with the circulating blood that any of our food really becomes a part of the living body. Thus freed of the nutritive portion of the food, the residue of the product of digestion passes on to the large intestine, from whence it is expelled in the form of excrement.

§ 334. The organs above described constitute the most essential for the process of digestion, and are found more or less developed in all but some of the radiated animals; but there are, in the higher animals, several additional ones for aiding in the reduction of the food to chyme and chyle, which render their digestive apparatus quite complicated. In the first place, hard parts, of a horny or bony texture, are usually placed about

the mouth of those animals that feed on solid substances, which serve for cutting or bruising the food into small frag-

ments before it is swallowed, and, in many of the lower animals, these organs are the only hard portions of the body. This process of subdividing or chewing the food is termed *mastication*.

§ 335. Beginning with the radiata, we find the apparatus for mastication partaking of the star-like arrangement which character-

izes those animals. Thus, in the *Scutella* (fig. 190), we have a pentagon composed of five triangular jaws, converging at their summits towards a central aperture corresponding to the mouth, each one bearing a plate or tooth, like a knife-blade, fitted by one edge into a cleft. The five jaws move towards the centre, and pierce or cut the objects which come between them. In some of the sea-urchins, *Echinidæ*, this apparatus, which has been called Aristotle's lantern (fig. 191), consists of

Fig. 189.

Aorta. Thoracic duct. Lymphatic glands

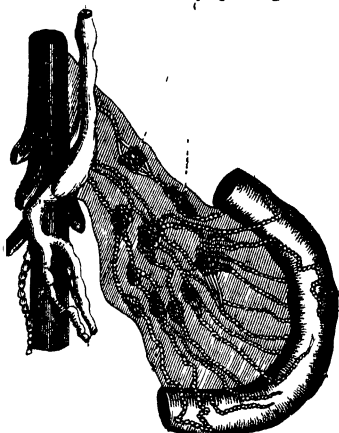

{ Roots of the chyloferous vessels.
Intestine.

Lymphatic vessels. Mesentery

Fig. 190.

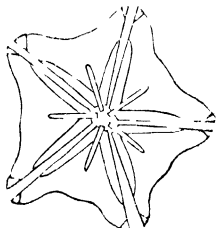
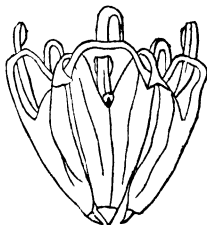

Fig. 191.



numerous pieces, and is much more complicated. Still, the five fundamental pieces or jaws, each of them bearing a tooth at its point, may be recognized, as in the *Scutella*; only, instead of being placed horizontally, they form an inverted pyramid.

§ 336. Among the mollusca, a few, like the cuttle-fishes,

Fig. 192.

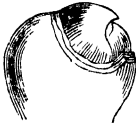

Fig. 194.



Fig. 193.

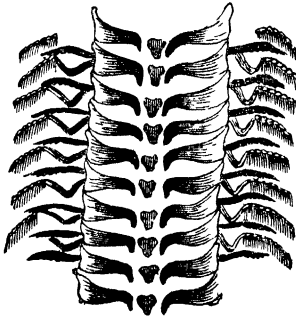

Fig. 193.—The dental organ of the *Nerita Ascensionensis*.

Fig. 194.—The dental organ of a *Patella*, from the Straits of Magellan.

have solid jaws closely resembling the beak of a parrot (fig. 192), which move up and down, as in birds. [But a much larger number rasp their food by means of a tongue sometimes coiled like a watch-spring, the surface of which is covered with innumerable tooth-like points, as in the highly magnified portions of the dental organ of *Nerita* (fig. 193) and *Patella* (fig. 194). The teeth present a great variety of patterns, which are constant in the different genera, and even characterize the species. They consist of variously-coloured silicious bodies, generally of hook-like forms, arranged in triple rows upon a musculo-membranous band,

as in figs. 193 and 194. The central part is called the *rachis*, and the lateral parts *pleuræ*. The rachidian teeth sometimes form a row of plates, as in *Nerita*; or they have a tile-shaped disposition, with pectinated borders, as in *Buccinum*. The lateral series exhibit an immense variety of forms, some having fringed processes, as in *Nerita* (fig. 193). By the aid of this singular dental organ the gasteropoda bruise, rasp, or pierce the vegetable or animal substances on which they subsist, and bore through the shells of mollusca, on which they prey. The tongue of the whelk (*Buccinum*) is furnished with upwards of one hundred rows of pectinated teeth, but the number of the dental rows on the lingual ribbon varies in different genera, and at the different periods of life of the individual. The dental organ of the common limpet (*Patella vulgata*) is more than twice the length of the animal, and in a state of repose is folded back into the digestive tube. The dental membrane is wide in the mouth, and contracted in the esophagus; and after a course of nearly three inches, terminates near the small transverse stomach. The new teeth, like those of rays and sharks, are developed from behind, and are brought into use when required, a new series arising with the age of the individual.*—T. W.]

§ 337. The articulates are remarkable, as a class, for the diversity and complication of the apparatus for taking and dividing their food. In some marine worms, *Nereis*, for example, the jaws consist of a pair of curved, horny instruments, lodged in a sheath. In spiders, they are external, and sometimes mounted on long, jointed stems. Insects which *masticate* their food have, for the most part, at least two pairs of horny jaws (figs. 195, 196 *m*), besides several additional pieces serving for seizing and holding their food. Those living on the fluids extracted either from plants or from the blood of other animals, have the masticatory organs transformed into a trunk or tube for that purpose. This trunk is sometimes rolled up in a spiral manner, as in the butterfly (fig.

* Lovén's *Memoir on the Teeth of Mollusca* is nearly all that we possess on this subject.

Figures 193 and 194 were drawn by Mr. Etheridge, of the Bristol Institution, from specimens dissected and prepared by my friend John W. Wilton, Esq., F.R.C.S., Gloucester. The position of the dental organ of the *Patella* (fig. 194) on the slide does not permit the left lateral teeth of the specimen to be seen.

199); or it is stiff, and folded beneath the chest, as in the squash-bugs (fig. 197), containing several piercers of extreme delicacy (fig. 198), adapted to penetrate the skin of animals or other objects whose juices they extract; or the parts of the mouth are prolonged, so as to shield the tongue when thrust out in search of food, as in the bees (fig. 196, *j*, *p*). The crabs have their

Fig. 195.



Fig. 196.



Fig. 197.



Fig. 198.

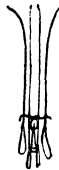

Fig. 199.



anterior feet transformed into jaws, and several other pairs of articulated appendages perform exclusively masticatory functions. Even in the microscopic rotifera, we find very complicated jaws, as seen in the interior of *Esophora* (fig. 172). But amidst this diversity of apparatus, there is one circumstance which characterizes all the articulata, namely, the jaws move sideways; while those of the vertebrata and mollusca move up and down, and those of the radiata concentrically.

§ 338. In the vertebrata, the jaws form a part of the bony skeleton. In most of them the lower jaw (fig. 103) only is moveable, and is brought up against the upper jaw by means of the temporal and masseter muscles, which perform the principal motions requisite for seizing and masticating food.

§ 339. The jaws are usually armed with solid cutting instruments, the **TEETH**, or else are enveloped in a horny covering, the **beak**, as in birds and tortoises (fig. 200). In some of the whales, the true teeth remain concealed in the jaw bone, and they have instead, a range of long, flexible, horny plates or fans, fringed at the margin, serving as strainers to separate

Fig. 200.



the minute marine animals on which they feed from the water drawn in with them (fig. 201). A few are entirely destitute of teeth, as the ant-eaters (fig. 202).

§ 340. Though all the vertebrata possess jaws, it must not be inferred that they all chew their food. Many swallow their prey whole; as most birds, tortoises, and whales.

Even many of those which are furnished with teeth do not masticate their food; some using them merely for seizing and securing their prey, as the lizards, frogs, crocodiles and

the great majority of fishes. In such animals, the teeth are nearly all alike in form and structure, as, for instance, in

Fig. 201

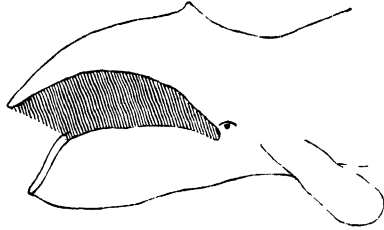

Fig. 202.

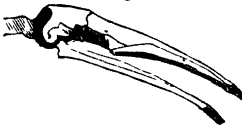
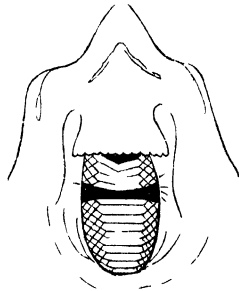

Fig. 203



Fig. 204.



the alligator (fig. 203); the porpoises and many fishes. A few of the latter, some of the rays, for example, have a sort of bony pavement (fig. 204), composed of a peculiar kind of teeth, with which they crush the shells of the mollusca and crabs on which they feed.

§ 341. The mammals, however, are almost the only vertebrata which can be properly said to masticate their food. Their teeth are well developed, and present great diversity in form, arrangement, and mode of insertion. Three kinds of teeth are usually distinguished in most of these animals, whatever may be their mode of life; namely, the cutting teeth, *incisors*; the

tusks, or carnivorous teeth, *canines*; and the grinders, *molars* (fig. 205). The

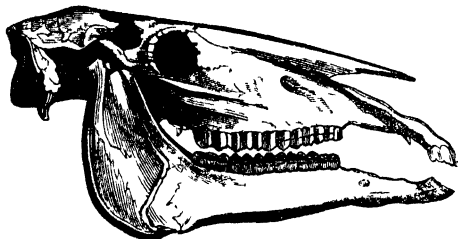

Fig. 205.—The skull of a horse.

incisors occupy the front of the mouth; they are the most simple and the least varied; they have a thin cutting summit, and are employed almost exclusively for seizing food, except in the elephant, in which they assume the form of large tusks. The *canines* are conical, more prominent than the others, more or less curved, and only two in each jaw; they have but a single root, like the incisors, and in the carnivora become very formidable weapons. In the herbivora they are wanting, or, when existing, they are usually so enlarged and modified as also to become powerful organs of offence and defence, although useless for mastication, as in the babyroussa.



Fig. 206.—The skull of a squirrel.

The *molars* are the most important for indicating the habits and internal structure of the animal, they are, at the same time, most varied in shape. Among them we find every transition, from those of a sharp and pointed form, as in the cat tribe (fig. 207), to those with broad and level summits, as in the ruminants and rodents (fig. 206); still, when most diversified in the same animal, they have one character in common, their roots being never simple, but double or triple, a peculiarity which not only fixes them more firmly, but prevents them from being driven into the jaw in the efforts of mastication.

§ 342. The *harmony of organs*, already spoken of, is illustrated, in the most striking manner, by the study of the teeth of mammals, and especially of their molar teeth. So constantly do they correspond with the structure of other parts of the body, that a single molar is sufficient not only to indicate the mode of life of the animal to which it belongs, and to show whether it fed on flesh or vegetables, or both, but also to de-

termine the particular group to which it is related ; thus, those beasts of prey which feed on insects, and which, on that account, have been called insectivora, such as the moles and bats, have the molars terminated by several sharp, conical points, so arranged that the elevations of one tooth fit exactly into the depressions of the tooth opposite to it. In the true carnivora (fig. 207), on the contrary,



Fig 207.—The skull of a tiger.

the molars are compressed laterally, so as to have sharp-cutting edges, as in the cats, and shut by the side of each other, like the blades of scissors, thereby dividing the food with great facility.

§ 343. The same adaptation is observed in the teeth of herbivorous animals. Those which chew the cud (ruminants), many of the thick-skinned animals (pachydermata), (fig. 205), like the horse and the elephant, and some of the gnawers (rodentia), like the squirrel (fig. 206), have the summits of the molars flat, like mill-stones, with more or less prominent ridges, for grinding the grass and leaves on which they subsist ; finally, the omnivora, those which feed on both flesh and fruit, like man and the monkeys, have the molars terminating in several rounded tubercles (fig. 102), being thus adapted to the mixed nature of their food.

§ 344. Again, the mode in which the molars are combined with the canines and incisors furnishes excellent means for characterizing families and genera ; even the internal structure of the teeth is so peculiar in each group, and yet subject to such invariable rules, that it is possible to determine, with precision the general structure of an animal, merely by investigating fragments of its teeth under a microscope.

§ 345. Another process, subsidiary to digestion, is called *insalvation*. Animals which masticate their food have glands, in the neighbourhood of the mouth, for secreting a fluid called *saliva*. This fluid mingles with the food as it is chewed, and prepares it also to be more readily swallowed. The salivary glands are generally wanting, or rudimentary or otherwise modified, in animals which swallow their food without masti-

cation. After it has been masticated, and mingled with saliva, it is moved backwards by the tongue, and passes down through the esophagus into the stomach ; this act is called *deglutition*, or *swallowing*.

§ 346. The wisdom and skill of the Creator is strikingly illustrated in the means afforded to every creature for securing its appointed food. Some animals have no ability to move from place to place, but are fixed to the soil, as the oyster, the polype, &c. ; these are dependent for subsistence upon such food as may stray or float near them, and they have the means of securing it only when it comes within their reach. The oyster closes its shell, and thus entraps its prey ; the polype has flexible tentacula (figs. 170 and 175), capable of great extension, which it throws instantly around any minute animal coming in contact with them ; the cuttle-fish has elongated arms about the mouth, furnished with ranges of suckers, by which it secures its victim.

§ 347. Some are provided with instruments for extracting food from places which would be otherwise inaccessible. Some of the mollusca, with their rasp-like tongue (fig. 193), perforate the shells of other animals, and thus reach and extract the inhabitant. Insects have various piercers, suckers, or a protractile tongue for the same purpose (figs. 195 to 199). Many of the annelida, the leeches for example (fig. 178), have a sucker, which enables them to produce a vacuum, and thereby draw out blood from the perforations they make in other animals. Many infusoria and rotifera are provided with hairs, or cilia, around the mouth (figs. 171, 172), which, by their incessant motion, produce currents that bring within reach the still more minute creatures, or particles, on which they feed.

§ 348. Among the vertebrata, the herbivora generally employ their lips or their tongue, or both together, for seizing the grass or leaves they feed upon. The carnivora use their jaws, teeth, and especially their claws, which are long, sharp, and moveable, and admirably adapted for the purpose. The woodpeckers have long, bony tongues, barbed at the tip, with which they draw out insects from deep holes and crevices in the bark of trees ; some reptiles also use their tongue to take their prey ; thus, the chameleon obtains flies at a distance of three or four inches, by darting out its tongue, the enlarged end of which is covered with a glutinous substance, to which they adhere. The elephant, whose tusk and short neck prevent him from bringing

his mouth to the ground, has the nose prolonged into a trunk, which he uses with great dexterity, for bringing food and drink to his mouth. Doubtless the mastodon, once so abundant in the pre-Adamite earth, was furnished with a similar organ; man and the monkeys employ the hand, exclusively, for prehension.

§ 349. Some animals drink by suction, like the ox; others by lapping, like the dog. Birds simply fill the beak with water, then, raising the head, allow it to run down into the crop. It is difficult to say how far aquatic animals require water with their food; it seems, however, impossible that they should swallow their prey without introducing at the same time some water into their stomach. Of many among the lowest animals, such as the polyps, it is well known that they frequently fill the whole cavity of their body with water, through the mouth, the tentacles, and pores upon the sides, and empty it at intervals through the same openings. And thus the aquatic mollusks introduce water into special cavities of the body, or between their tissues, through various openings, while others pump it into their blood-vessels, through pores at the surface of their body. This is the case with most fishes.

Besides the more conspicuous organs above described, there are among the lower animals various microscopic apparatus for securing prey. The lassos of polypi have been already mentioned incidentally. They are minute cells, each containing a thin thread coiled up in its cavity, which may be thrown out by inversion, and extended to a considerable length beyond the sac to which it is attached. Such lassos are grouped in clusters upon the tentacles, or scattered upon the sides of the actinia, and of most polypi. They occur also in similar clusters upon the tentacles and the disc of jelly-fishes. The netting sensation produced by the contact of many of these animals is undoubtedly owing to the lasso cells. Upon most of the smaller animals, they act as a sudden, deadly poison. In echinoderms, such as star-fishes, and sea-urchins, we find other microscopic organs in the form of clasps, placed upon a moveable stalk. The clasps, which may open and shut alternately, are composed of serrated or hooked branches, generally three in number, closing concentrically upon each other. With these weapons, star-fishes not more than two inches in diameter, seize and retain shrimps of half that length, notwithstanding their efforts to disentangle themselves.

CHAPTER SEVENTH.

OF THE BLOOD AND CIRCULATION.

§ 350. THE nutritive portions of the food are poured into the general mass of fluid pervading every part of the body, out of which every tissue is originally constructed, and from time to time renewed. This fluid, in the general acceptation of the term, is called blood; but it differs greatly in its essential constitution: in the different groups of the animal kingdom, in polyps, and medusæ, it is merely *chyme*; in most mollusca and articulata it is *chyle*; but in vertebrata it is more highly organised, and constitutes what is properly called blood.

§ 351. The BLOOD, when examined by the microscope, is found to consist of a transparent fluid, the *serum*, consisting chiefly of albumen, fibrin, and water, in which float many rounded, somewhat compressed bodies, called blood discs, or *globules*. These vary in number with the natural heat of the animal from which the blood is taken. Thus, they are more numerous in birds than in mammals, and more abundant in the latter than in fishes. In man and other mammals they are very small, and nearly circular (figs. 208 and 209); they are somewhat larger, and of an oval form, in birds and fishes (figs. 210, 214, 215); and still larger in reptiles (figs. 211, 212, 213). [The blood-globules in man appear distinctly dis-



Fig. 208.—Globules of the blood of man, the blood having been drawn from a vein and beaten, to separate the fibrin. A, blood globules, seen, *a*, on the flat aspect; *b*, standing

on the edge; *, three-quarter view: B, a congeries of blood-globules, with their flat surfaces in opposition, and forming columns such as are made by a number of coins laid one upon another. C, a blood globule in process of alteration, such as simple exposure to the air will produce. D, a lymph globule, mingled with the proper blood globules.

N.B. The subjects of this and the succeeding figures of blood discs from Wagner's *Icones Physiologicae*, are all magnified to the same extent, viz. about nine hundred diameters.

coidal (fig. 208, A), and vary between the 300th to the 400th of a line in diameter. They are rarely seen either larger or smaller. That they are flat, disc-like bodies, is discovered by examining them on different sides. At the beginning of an observation, before the drop has spread itself abroad completely, and the globules have come to rest, or at any time when the port-object is inclined a little one way or another, numbers of them are always seen on their edges (A, *b*), when they appear as long-shaped bodies, bounded by two parallel lines. They are also seen falling, or rolling over (*), and with everything at rest, finally sinking down upon their flat sides (*a*). The blood-discs are severally so pale in colour, and so transparent, that when one lies over another, the undermost is seen distinctly shining through the uppermost (*a* inferiorly). If quite normal, a delicate semicircular shadow upon the flat surface gives the observer the idea that the blood-discs are very slightly hollowed out, or sunk, in the manner of a concave lens. In a short time, sometimes after the lapse of a few seconds only, particularly when the diluting medium has not been well selected, though it also happens from the action of the air, the blood-discs begin to suffer change; they appear puckered and uneven; they acquire notched edges, and are stellated; they seem to be made up of very minute globules, or they look like mulberries or raspberries (C). The blood-discs seem to have a natural tendency to approximate by their flat surfaces, and go to form columns such as are produced by pieces of money piled one upon another (B).

[§ 352. It is a matter of interest to compare the blood-cor-



Fig. 209.—Blood globules of the common goat (*Capra domestica*).

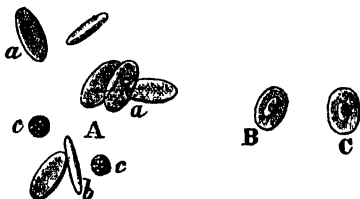

Fig. 210.—A, blood and lymph globules of the pigeon (*Columba domestica*). B, a blood-globule, treated with diluted acetic acid; C, with water, by which the central nucleus becomes visible.

puscles of the lower animals with those of man. In the mammalia they are in all essential respects the same as in man, round and discoidal; for the most part, however, particularly among the ruminants, decidedly smaller (fig. 209). In the monkeys, again, they are very nearly of the same size.* In birds, on the other hand, the blood-corpuscles are very different, having an elongated oval shape (fig. 210, *a*), and their broad sides, instead of being depressed, are vaulted or raised (*b*). They are on an average from 1-125th to 1-150th of a line in length, and about half as broad. It is among the amphibia that we meet with the largest blood-corpuscles. They are here, as in birds, oval-shaped, but relatively somewhat broader; and their surface is rather depressed than vaulted. They are particularly large in the naked amphibia: in the *Proteus*, for example, they are from 1-30th to 1-50th of a line in the long diameter, and are even distinguishable as little points by the

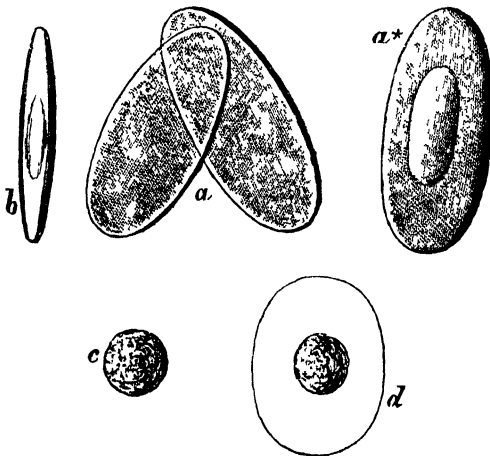

Fig. 211.—Blood-globules of the *Proteus anguinus*. In the globule *a** the nucleus is seen, and in the globule, *d*, which has been treated with water, it is still more apparent; *c* is a lymph granule.

* The blood-corpuscles of the monkeys are in no wise to be distinguished from those in man. In different human subjects,—men, women, children, negroes,—no difference can be perceived.

naked eye (fig. 211, *a b*). They are, consequently, from eight to ten times larger here than in man. After the *Proteus*, we observe the largest blood-corpuses in the land salamanders, where they measure in the long diameter from the 1-50th to the 1-60th of a line. In the water salamanders they are still very large,—from the 1-70th to the 1-80th of a line in length (fig. 212). In the frog and toad they are from the 1-80th to the 1-100th of a line in length (fig. 213). In the lizards, serpents, and tortoises, they are throughout smaller, though still measuring from the 1-122d to the 1-150th of a line in length.

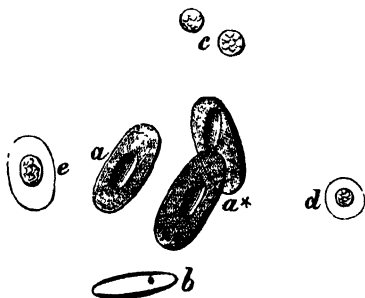

Fig. 212.—Blood and lymph-globules of the great water-newt (*Triton cristatus*). *a*, *b*, blood-globules; *a**, a blood-globule with eccentric nucleus; *c*, lymph-granules. *d*, *e*, blood-globules in progress of development; they are surrounded with delicate involucra. Globules of this description are found abundantly in the blood of well-fed animals generally.

In the majority of fishes, and particularly in all the bony fishes, the blood-corpuses are of a rounded oval (fig. 214), not much longer than broad, flattened, and from the 1-150th to the 1-200th of a line in the long diameter. In the skates and sharks,

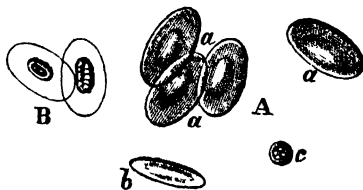

Fig. 213.—A, *a*, *a*, *a*, *b*, blood-globules of the edible frog (*Rana esculenta*); *c*, lymph granule. B, blood-globules after the action of acetic acid.

again, they are notably larger, and very similar to those of the frog; they are as much as from the 1-50th to the 1-100th of a line in the long axis. It is remarkable that in the cyclostomes they greatly resemble those of man, being rounded, discoidal, vaulted, slightly bi-concave (fig. 215, *a*, *b*), and mea-

asuring 1-200th of a line in diameter; they are, therefore, only somewhat larger than in man. In the invertebral series of animals they are generally irregular, granular, rounded corpuscles.*]



Fig. 214.—Blood and lymph globules of the loach (*Cobitis fossilis*); *a, a, b*, perfect blood-globules; *d*, a blood-globule altered by the action of water, and shewing its nucleus; *c*, lymph granules.

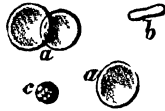

Fig. 215.—Blood-globules of the *Ammocetes branchialis*; *a, a, b*, perfect blood-globules; *c*, lymph-globule. The blood-globules are exactly similar in the lamprey (*Petromyzon*), and unlike those of all other fishes, whether cartilaginous or bony.

§ 353. The colour of the blood in the vertebrata is bright red; but in some invertebrata, as the crabs and mollusca, the nutritive fluid is nearly or quite colourless, while in the worms, and some echinoderms, it is variously coloured, yellow, orange, red, violet, lilac, and even green.

§ 354. The presence of this fluid in every part of the body is one of the essential conditions of animal life. A perpetual current flows from the digestive organs towards the remotest parts of the surface; and such portions as are not required for nutriment and the secretions, return to the centre of circulation, mingled with fluids, which need to be assimilated to the blood, and with particles of the body which are to be expelled, or before returning to the heart are distributed through the liver. The blood is kept in an incessant circulation for this purpose.

§ 355. In the lowest animals, such as the polypi, the nutritive fluid is simply the product of digestion, chyme, mingled with water in the common cavity of the viscera, with which it comes in immediate contact, as well as with the whole interior of the body. In the jelly-fishes, *Medusæ*, which occupy a somewhat higher rank, a similar liquid is distributed by prolongations of the principal cavity to the different parts of the body (fig. 173). Currents are produced in these, partly by the general

* Professor Wagner's Physiology, p. 233, *et seq.*

movements of the animal, and partly by means of the incessant vibrations of *cilia*, which overspread the interior. In most of the mollusca and articulata, the blood, chyle, is also in immediate contact with the viscera, water being mixed with it in the mollusca; the vessels, if there are any, forming a complete circuit, but not emptying into various cavities which interrupt their course.

§ 356. In animals of still higher organization, as the vertebrata, we find the vital fluid inclosed in an appropriate set of vessels, by which it is successively conveyed throughout the system, to supply nutriment and secretions, and to the respiratory organs, where it absorbs oxygen, or, in other words, becomes *oxygenated*.

§ 357. The vessels in which the blood circulates are of two kinds: 1. The *arteries*, of a firm, elastic structure, which may be distended, or contracted, according to the volume of their contents, and which convey the blood from the centre towards the periphery, distributing it to every point of the body. 2. The *veins*, of a thin, membranous structure, furnished with valves (fig. 216, *v*), which aid in sustaining the column of blood, only allowing it to flow from the periphery towards the centre. The arteries constantly subdivide into smaller and smaller branches, while the veins commencing in minute twigs, are gathered into branches and larger vessels, to unite finally into a few trunks near the centre of circulation.

§ 358. The extremities of the arteries and veins are connected by a net-work of extremely delicate vessels, called *capillary vessels* (figs. 224, 225); which pervade every portion of the body, so that almost no point can be pricked without wounding some of them. Their office is to distribute the nutritive fluid to the organic cells, where all the important processes of nutrition are performed, such as the alimentation and growth of all organs and tissues, the elaboration of bile, milk, saliva, and other important products derived from the blood, the removal of effete particles, and the substitution of new ones, and all those changes by which the bright blood of the ar-

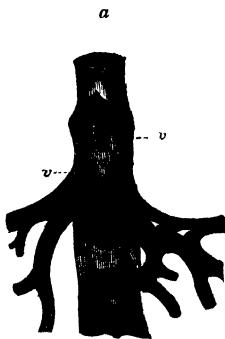

Fig. 216.—Vein laid open, to shew the valves, *v*, *v*.

teries becomes the dark blood of the veins; and again, in the cells of the respiratory organs, which the capillaries supply, the dark venous blood is oxygenated, and restored to the bright scarlet hue of the arterial blood.

§ 359. Where there are blood-vessels, in the lowest animals, the blood is kept in motion by the occasional contraction of some of the principal vessels, as in the worms. Insects have a large vessel running along the back, furnished with valves so arranged that, when the vessel contracts, the blood can flow only towards the head, and being thence distributed to the body, is returned again into the *dorsal vessel* (fig. 223), by fissures at its sides.

§ 360. In all the higher animals there is a central organ, the *heart*, which forces the blood through the arteries towards the periphery, and receives it again on its return. The HEART is a hollow muscular organ, of a conical form, which dilates and contracts at regular intervals, independently of the will. It is either a single cavity, or is divided by walls into two, three, or four compartments, as seen in the following diagrams. These modifications are important in their connection with the respiratory organs, and indicate the higher or lower rank of an

Fig. 217.

Lesser circulation.

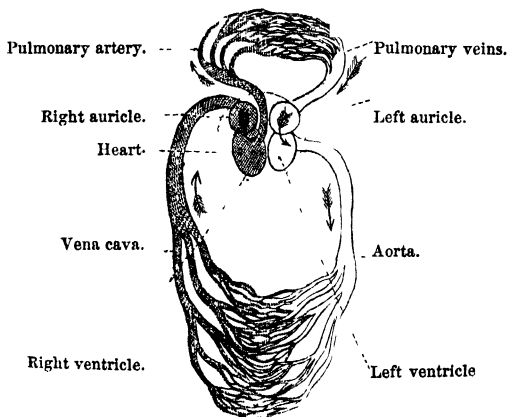

Greater circulation.

animal, as determined by the quality of the blood distributed in those organs.

§ 361. In mammals and birds the heart is divided, by a vertical partition, into two cavities, each of which is again divided into two compartments, one above the other (fig. 217). The two upper cavities are called *auricles*, and the lower ones are called *ventricles*. Reptiles have two auricles and one ventricle (fig. 219); fishes have one auricle and one ventricle only (fig. 220). The plan (fig. 217) represents the course of the blood in mammals and birds, in which we have a double circulation; a lesser one through the lungs, and a greater one through the body.

§ 362. The auricles do not communicate with each other, in adult animals, nor do the ventricles. The former receive the blood from the body and the respiratory organs through veins, and each auricle sends it into the ventricle beneath, through an opening, guarded by valves to prevent its reflux; while the ventricles, by their contractions, force the blood through arteries into the lungs, and through the body generally.

§ 363. The two auricles dilate at the same instant, and also contract simultaneously; so, also, do the ventricles. These successive contractions and dilatations constitute the pulsations of the heart. The contraction is called *systole*, and the dilatation is called *diastole*. Each pulsation consists of two movements, the diastole, or dilatation of the ventricles, during which the auricles contract, and the systole, or contraction of the ventricles, while the auricles dilate. The frequency of the pulse varies in different animals, and even in the same animal, according to its age, sex, and the degree of health: in adult man, they are commonly about seventy beats per minute.

§ 364. The course of the blood, in those animals which have four cavities to the heart, is as follows, beginning with the left ventricle (fig. 218, *l, v*). By the contraction of this ventricle, the blood is driven through the main arterial trunk, called the *aorta* (*a*), and is distributed by its branches throughout the body; it is then collected by veins, carried back to the heart, and poured into the right auricle (*r, a*), which sends it into the right ventricle (*r, v*). The right ventricle propels it through another set of arteries, the *pulmonary arteries* (*p*), to the lungs; it is there collected by the *pulmonary veins*, and

conveyed to the left auricle (*l, a*), by which it is returned to the left ventricle, thus completing the circuit.

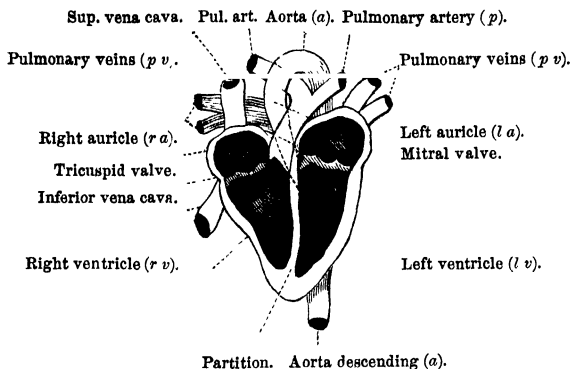

Fig. 218.—Ideal section of the human heart.

§ 365. Hence the blood, in performing its whole circuit, passes twice through the heart. The first part of this circuit, the passage of the blood through the body, is called the *great circulation*, and the second part, the passage of the blood through the lungs, is the *lesser* or *pulmonary circulation*: this double circuit is said to be a *complete* circulation (fig. 217). In this case, the heart may be justly regarded as two hearts conjoined, and, in fact, the whole of the lesser circulation intervenes in the passage of the blood from one side of the heart to the other; except that during the embryonic period, when there is an opening between the two auricles, which closes as soon as respiration commences.

§ 366. In reptiles (fig. 219) the venous blood from the body is received into one auricle, and the oxygenated blood from the lungs into the other. These throw their contents into the single ventricle below, which propels the mixture in part to the body, and in part to the lungs; but as only the smaller portion of the whole quantity is sent to the lungs in a single circuit, the circulation is said to be *incomplete*. In the crocodiles, the ventricle has a partition which keeps separate the two kinds of blood received from the auricles; but the

mixture soon takes place by means of a special artery which passes from the pulmonary artery to the aorta. [The reptiles have a heart with one ventricle, and two auricles; the right auricle receives the impure venous blood from the body, the left auricle receives the pure arterial blood from the lungs, and both pour their contents into the same ventricle, where they are mingled together. This mixed blood is transmitted by the ventricular contractions partly into the lungs and partly into the body; in the crocodile a partial partition divides the ventricle into a right side and a left side, as in birds and mammals. Fig. 219 is a plan of the circulation in reptiles; the arrows indicating the course of the blood.

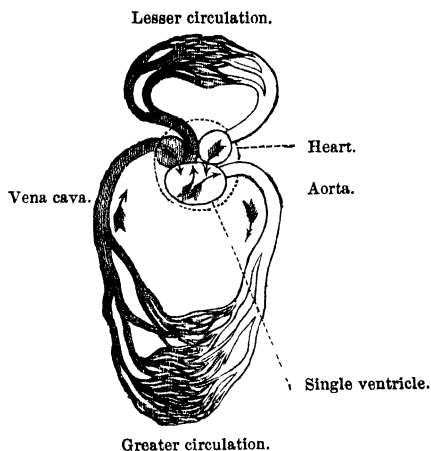

Fig. 219.—Circulation in reptiles.

[§ 367. In fishes the heart possesses two cavities, an auricle and a ventricle, and only receives and transmits venous blood; it therefore represents the right side of the heart of birds and mammals. The venous blood returned by the systemic veins is poured into the auricle and ventricle, from whence a highly elastic artery arises, which divides into five pairs of branches; these branchial arteries distribute the blood throughout the gills; from these organs it is conveyed into a large single vessel,

lying along the spine, and by its branches is distributed throughout the body. Fig. 220 is a plan of this type of circulating organ.

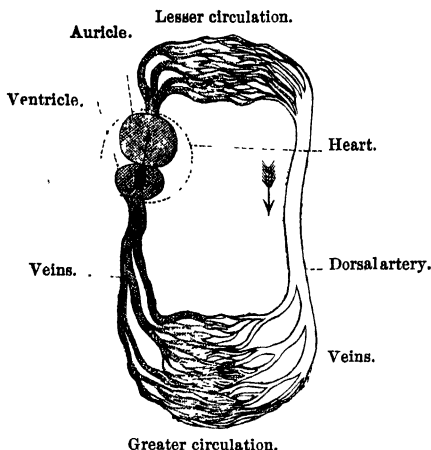

Fig. 220.—Circulation in fishes.

[§ 368. In the *mollusca* the heart consists of a ventricle and an auricle, as in fishes; but it differs in this, that it is destined to propel the blood through the system, and not through the gills, as in that class.

[Fig. 221 represents the circulating organs of the *Doris*; the heart consists of a ventricle (*a*), from whence arises the

aorta (*b*), which sends branches to all parts of the body; and a single or double auricle (*c*), in which the veins (*d*) of the branchial organs (*e*) terminate, the branchiæ being developed in the form of external vascular tufts. The blood purified in these organs is conveyed to the heart, and transmitted by arteries through the body; it is collected by the radicles of the veins, which terminate in a large trunk (*f*). By this vena cava it is distributed through the gills (*e*), and from these organs it is returned to the heart. In the CEPHALOPODA the circulation through the gills is aided by branchial ventricles, situated at the bases of these organs, but in other respects their circulatory apparatus resembles that of the mollusca in general.

[§ 369. In the crustacea (fig. 222), the circulation is after the type of the mollusca. The heart (*a*) consists of a ventricle only, from which several arteries arise; the ophthalmic (*b*), the antennal (*c*), the hepatic (*d*), the superior abdominal (*e*), and the sternal (*f*). After having circulated through the body, the blood is collected in certain reservoirs (*g g*), which take the

place of veins ; these venous sinuses swell out at the base, and send a branch to each branchia. After having circulated through these organs, the blood is returned to the heart, to perform a similar circuit.

[§ 370. In insects (fig. 223) the circulation is maintained by a dorsal vessel (*a*), which acts the part of a heart : it is divided into several chambers by valves, which permit the blood to flow only towards the head ; the vessel here appears to cease, and the blood seems to flow in the interspaces of the tissues ; currents of globules form arches in the antennæ, wings, legs, and the prolongations of the abdomen ; lateral currents are seen at *b*, the direction of their course being indicated by the arrows. The circulation in insects can only be

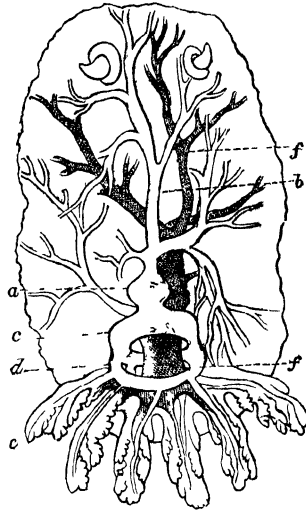
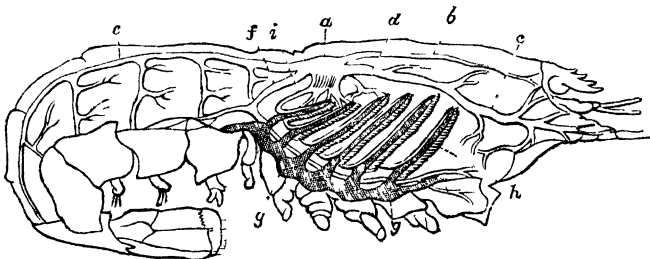

Fig. 221.—Circulating organs of the Doris.

Fig. 222.



Vascular system of the lobster.

studied in transparent aquatic larva, as those of the ephemera, in which it forms a beautiful spectacle for the microscopist. The chyle globules enter the dorsal vessel by

lateral slits, which are protected by valves. The simplicity of the circulating organs in insects forms a striking contrast

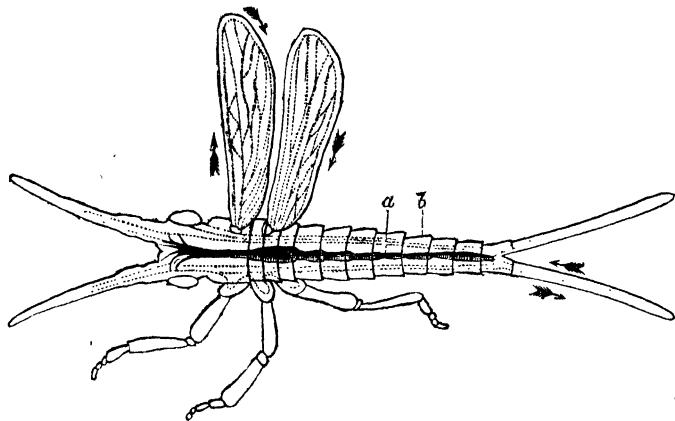

Fig. 223.—Circulation of insects.

to the preceding classes ; but we shall see, when treating of the function of respiration, that in insects the air is so completely conveyed to all parts of their bodies, that a simple arrangement suffices for the perfect æration of their blood.

[§ 371. We have seen that the arteries terminate in the veins in the periphery of all the organs ; these two divisions of the vascular system are connected by the *capillary vessels*. A view of these vessels can only be obtained by successful minute injections, and the aid of the microscope ; size injections of the skin, and the mucous membranes of the lungs and intestinal canal, exhibit the peripheral capillary system in great variety. The web of the frog's foot, the fishes' tail, and the branchiæ of the tadpoles* of frogs, and salamanders, shew the splendid spectacle of the vascular system in action.—T. W.]

[§ 372. However different the more minute capillary reticulations in the various organs appear, they may nevertheless be

* Every season of the year is not alike favourable for making observations on the circulation. It is only in the spring that tadpoles are to be had, but they are excellent subjects. They should be rolled up in moist

all reduced to a single fundamental type, a type which is most readily observed in the vascular distribution of the intestinal villi (fig. 224): the terminal twig of an artery (*b, b*) bends round into the terminal twig of a vein (*a, a*), and the two are repeatedly connected by means of delicate loop-like twigs, these in their turn being formed into meshes by cross or intermediate branches. The fundamental type of the peripheral vascular system is therefore an arterial and a venous branchlet — proper capillary vessels, and an interposed net-work of fine vascular canals—*vasa intermedia*. A distinct separation between capillaries, and intermediate vessels, as this is perceived in the intestinal villi more especially, is not generally to be observed, the two blend or are lost insensibly in one another. The parenchyma, or organic substance lying between the finest vascular subdivisions, forms islets of very various size and figure, according as the meshes of the intercurrent vessels are open or closer, and as they are rounded or angular. The intimate structure of every organ, the mode of union and of the grouping of its elementary parts, and the diameter of the

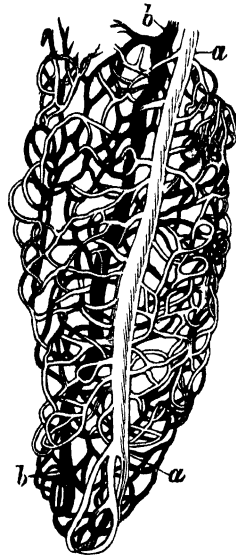

Fig. 224.—Vessels of one of the intestinal villi of the hare; after an extremely beautiful dry preparation by Doellinger. The villus is magnified about 45 times. The vein *a, a*, is injected with white; the artery, *b b*, with red; between the two a most beautiful rete of capillaries is apparent.

blotting-paper, nearly to the end of the tail, and so laid upon a plate of glass of sufficient size, and placed under the microscope, the wrapper of bibulous paper being kept constantly moist by a few drops of water let fall on it from time to time. In this way the circulation may be watched for hours, and the tadpole set free at the end of the observation is nothing the worse. Young and still transparent fishes may also be treated in the same

vessels which appertain to it, give rise to the greatest diversity of form in the peripheral vascular system, which has nevertheless so determinate a character in each tissue, that an examination with the microscope of the smallest particle of a finely injected preparation enables us to say with certainty from what part of the body it was obtained.*

[§ 373. When a transparent part of a cold-blooded animal, the web of the frog's foot, for example, is examined under a

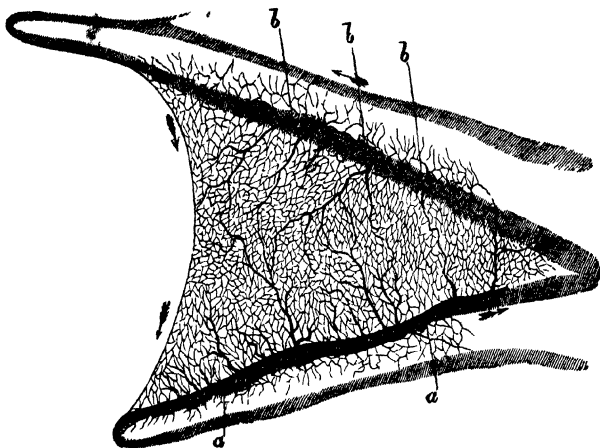

Fig. 225.—Membrane between two of the toes of the frog's (*Rana esculenta*) hind-foot, with the vessels and their anastomoses, drawn under the lens, and magnified three diameters. *a a*, Veins. *b b*, Arteries.

way, and are excellent subjects, but they require more delicate handling than tadpoles. The circulation in the allantoid of the young embryos of lizards and snakes is also a very beautiful sight, when these subjects can be had at the proper point of evolution; they require to be removed from the ova, and observed covered with fluid albumen in a watch-glass. In the winter, frogs are the best subjects; fishes are then much less proper. In the web of the hind foot of the common frog (*Rana temporaria*), the circulation is perhaps seen to as great advantage as anywhere. All our better microscopes are now provided with a stage adapted for placing the animal, which is best secured by being put into a linen or calico bag, with tapes at each corner to tie it down.

* Professor Wagner's Physiology, p. 236.

low magnifying power, the directions of the arterial and venous currents are readily discovered (fig. 225, *a a*, *b b*). The anastomoses of both orders of vessels are seen distinctly. Under a higher power (figs. 226 and 227) a net-work of very fine vessels is perceived lying now over, now under the larger branches, and connected with these by small twigs. In the larger vessels the arterial and venous currents are distinguished, not merely by their opposite directions, but also by the kind of motion appropriate to each: that of the arteries is distinctly jerking or pulsatory, but it gets ever less and less, so as the minuter subdivisions are attained, and in the intermediate and finest vessels of all it becomes a continuous stream, which has the character appropriate to the venous current. In all the vessels, even in the very finest, a distinct boundary, formed by a simple dark line, is perceptible; the surrounding parenchyma, now distinctly cellular (fig. 226), now rather granular and fused, though still including individual ramified pigmentary cells within it (fig. 227), is sharply limited; the vessels never appear as simple channels pierced through its substance and without distinct parietes. Larger vessels (figs. 227 and 228) are obviously enough furnished with darker parietes, composed of various layers of fibres. In the most minute vessels there is room for no more than a single row of blood-corpuscles, and even these can only pass by their long diameters through the

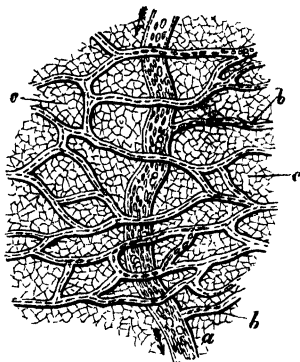

Fig. 226.—A portion of the web of a frog's foot, exhibiting the included network of vessels, magnified 45 times. The angular unnuclated cells *c c*, of the parenchyma, lying between the different vessels, are beautifully shown; *a* is a deeper-lying venous trunk, with which two smaller capillary veins, *b b*, communicate. The superficial net-work of capillaries is seen admitting but a single series of blood-globules. All the vessels here figured are furnished with distinct parietes.

axis of the vessel. The larger vessels admit several blood-corpuscles together, and in the decidedly arterial or venous branches they are observed passing on in all positions—three, four, and five abreast, over and near to one another, but those in the centre of the current always in more rapid motion than those on its outside and in contact with the walls of the vessel. (Figs. 227 and 228.) Occasionally we observe single vessels of larger calibre running very immediately under the epithelium (*a*), which is made up of tubular cells with nuclei (*b, b, b, b*), through which the fibrous parietes of the vessel are seen shining (fig. 228).

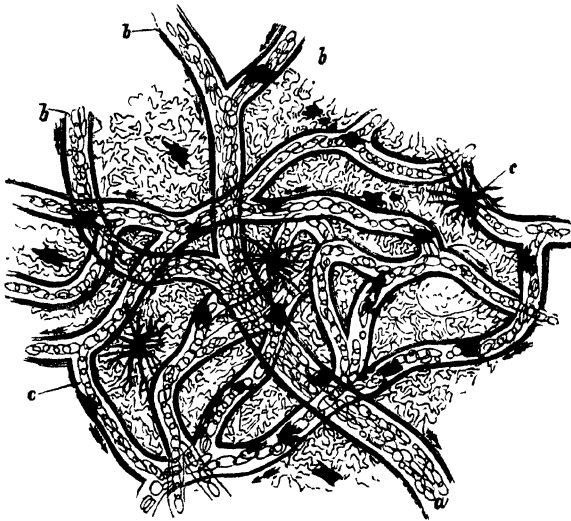

Fig. 227.—Vascular rete and circulation of the web of the hind-foot of *Rana temporaria*, magnified 110 times. The individual cells of the parenchyma are indefinite and obscure. The black spots, some of them star-shaped, are depositions of pigmentary matter. The deep venous trunk, *a*, composed of three principal branches, *b, b, b*, is covered with a rete of smaller vessels. Mingled with the oval-shaped blood-globules, the smaller and rounder lymph-globules are apparent; here, under the blood-globules, there, more on the outside of the stream.

[§ 374. A magnifying power of from two to three hundred diameters is required, to make out the particular details of the peripheral circulation. The blood in mass, or in the larger channels, is seen to flow more rapidly than in the smaller. Here the blood-corpuscles advance with great rapidity, especially in the arteries, and with a whirling motion, and form a closely crowded stream in the middle of the vessel, without ever touching its parietes.

With a little attention a narrower and clearer but always very distinct space is seen to remain betwixt the great middle current of blood-corpuscles and the bounding walls of the vessel, in which a few of the lymph-corpuscles are moved onwards, but at a vastly slower rate (figs. 228 and 229, *a, a*). These round lymph-corpuscles swim in smaller numbers in the transparent liquor sanguinis, and glide slowly, and in general smoothly, though sometimes they advance by fits and starts more rapidly, but with intervening pauses, and, as a general rule, at least from ten to twelve times more slowly than the corpuscles of the central stream. The clear space filled with liquor sanguinis and lymph-corpuscles is obvious in all the larger capillary vessels, whether arterial or venous; but it ceases to be apparent in the smaller intermediate

vessels, which admit but one or two ranks of blood-corpuscles

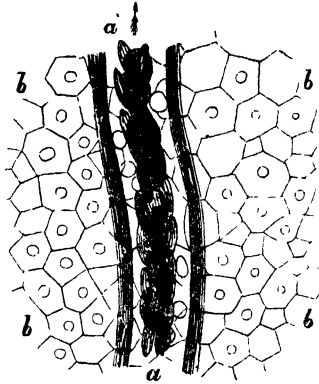

Fig. 228.—A venous branch from the web of *Rana temporaria* magnified 350 times, running immediately under the surface. The cells of the epidermis, *b, b, b, b*, flattened, mostly six-sided, connected like a piece of pavement, and generally provided with nuclei, are seen extended over the vessel. The closely serried column of blood-globules, some with their edges, others with their broad faces turned to the eye, is distinguished; in the clear space betwixt the blood-globules and the parietes of the vessel, which appear made up of longitudinally disposed parallel fibres, the round, clear, and more sluggishly moving lymph-globules are apparent. The object is represented under a weak light.

(fig. 229). In these vessels the round lymph-corpuses (*a, a, a, a*) are seen swimming under, over, and behind the oval

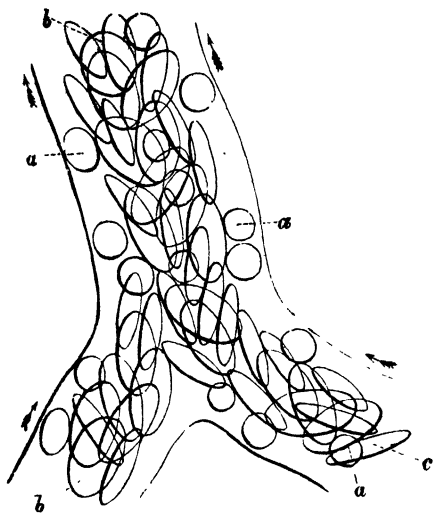

Fig. 229.—View in outline of a large vein of the frog's foot magnified 600 times. The blood-globules, *b* and *c*, present sometimes their thin edges, sometimes their broad surfaces, here they lie parallel, there diagonally, and elsewhere athwart the course of the vessel. The lymph-globules, *a, a*, are principally conspicuous in the clear space near the walls of the vessel.

blood-discs (*b, b*), both of them proceeding *pari passu* here, and having the same moderated motion: still it is impossible not to observe that the blood-corpuses are possessed of a greater degree of lubricity, that they evidently glide more readily over one another and over the smooth walls of the vessels, than the lymph-corpuses, which seem often to get set fast at the bendings of the vessels, and at the angles where anastomosing branches are received or given off; there they remain sticking for an instant, and then are suddenly carried on again. Single blood-corpuses, too, may frequently be observed hurled by a wave, as it were, against angles of the containing vessels, and remain hanging for a brief interval; at these times they may be seen quivering or oscillating, in spite of the pressure they must undergo; but their stoppages are never long, they soon fly off again, or, becoming involved in the general stream, they are borne onwards. In contemplating the circulation under these circumstances, a spectacle of the most interesting kind is presented to the eye:.

blood-discs (*b, b*), both of them proceeding *pari passu* here, and having the same moderated motion: still it is impossible not to observe that the blood-corpuses are possessed of a greater degree of lubricity, that they evidently glide more readily over one another and over the smooth walls of the vessels, than the lymph-corpuses, which seem often to get set fast at the bendings of the vessels, and at the angles where anastomosing branches are received or given off; there they remain sticking for

the little molecules of the blood are seen in ceaseless motion and alive, but altogether without inherent activity, now borne forward as upon gentle waves, and then pushed more impetuously along; now advancing in serried ranks, now threading their way in single files, the entire phenomena dependent upon the activity of the central organ. In the most minute intermediate vessels of all, a great degree of repose is

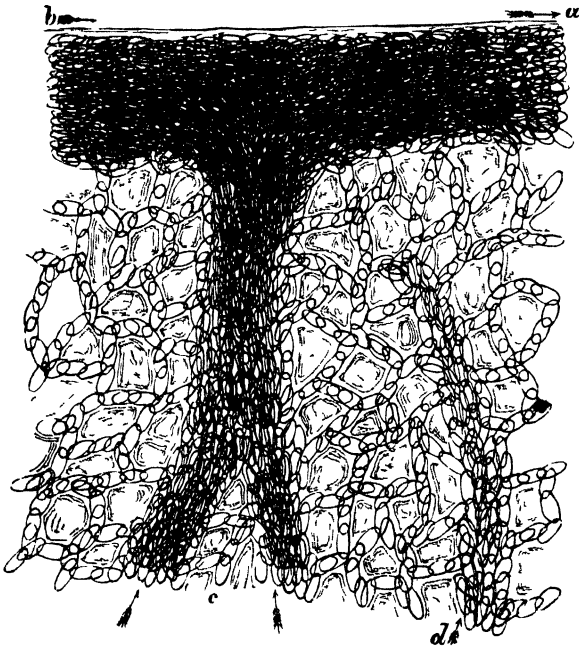

Fig. 230.—Portion of the lung of a live *Triton* drawn under the microscope, and magnified 150 times; *a*, *b*, *c*, streams of venous blood; *d*, a branch of the pulmonary artery. The very delicate capillaries serving as bonds of union between the pulmonary vessels, are seen playing round little islets of the substance of the lung. The clear space between the current of the blood and the walls of the vessels observed in the larger branches is almost entirely wanting here. The lymph granules, therefore, are observed mixed with the general torrent. The arrows indicate the course of the currents.

apparent; single streams are often only recognizable by their bounding parietes; comprehended within two dark lines, these vessels are usually filled with the liquor sanguinis alone; it is at intervals only that a blood-corpuscule, more rarely a lymph-corpuscule, from some neighbouring and larger streamlet, detaches itself and makes its way into the canal, which till now had appeared empty; one corpuscule entering in this way is frequently followed by several others in pretty rapid succession, and then, or without anything of the kind occurring, the vessel for a long time circulates nothing but the limpid plasma. Whether there are any vessels or not that never circulate aught but plasma, refusing, by reason of the smallness of their diameters, at all times to admit the blood-corpuscules, is doubtful.

[§ 375. Such is the peripheral systemic circulation in every tissue susceptible of special examination. In the peripheral vessels of every part yet examined, the separation into the quicker stream of blood-corpuscules in the centre, and of the slower one of liquor sanguinis in the circumference above indicated, has been observed. But the circulation of the respi-

ratory apparatus, whether lungs or gills, offers a most remarkable exception to this rule, so uniform in reference to the circulation at large. The capillaries of the respiratory organ are filled with blood generally, *i. e.* liquor sanguinis, with its super-added blood and lymph-corpuscules, — to their very walls (figs. 230 and 231.) It is only in the larger capillary vessels that a thin stratum of plasma is to be seen in contact with the parietes,

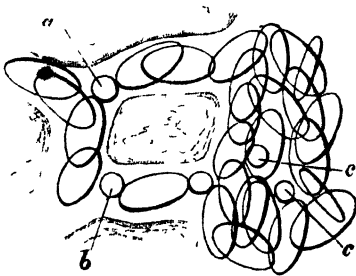

Fig. 231.—One of the pulmonary islets bounded by capillaries on three sides, by a larger venous branch on the fourth side. *a, b, c* are lymph-globules mingled with the blood-globules. The object is magnified about 300 times.

which are much more delicate than those of the systemic circulation, and not, like them, formed of a series of dark

fibrous layers. The circulation through the lungs of the water-newt is a very beautiful object (fig. 230). The pulmonary arteries (*d*) here expand very speedily into a fine-meshed net-work of intermediate vessels, which in general admit no more than single files of blood-corpuses playing around very minute islets of the parenchyma of the lung (fig. 231). The vessels always appear with distinct parietes, and terminate partly in capillary veins of the same character as themselves (fig. 230), partly in larger venous trunks. The blood-corpuses mixed with lymph-corpuses (fig. 231, *c*), as already stated, fill both arteries and veins close to their parietes. The same appearances are presented in the branchial fringes of the larva of the water-newt.]*

* Professor Wagner's Physiology, page 294, *et seq.*

CHAPTER EIGHTH.

OF RESPIRATION.

§ 376. FOR the maintenance of its vital properties, the blood must be submitted to the influence of the air. This is true of all animals, whether they live in the atmosphere or in the water. No animal can survive for any considerable period of time without air; and the higher animals almost instantly die when deprived of it. It is the office of RESPIRATION to bring the blood into communication with the air.

[§ 377. In the lowest classes of animals no special organ is developed for the exposure of the nutritive fluid to the oxygenating influence of the air contained in the water in which they live. In them, the general cutaneous surface is a respiratory organ; such is the case in infusoria, polyps, medusæ, and many other invertebrata. Many parts of the cutaneous membrane on the exterior of their bodies, or that lining the digestive organs, are covered with vibratile cilia, by the motions of which, currents of water are made to flow over these surfaces, and thereby oxygenating the nutritive fluids circulating in them.

[§ 378. In the echinodermata special organs exist; the upper surface of the tegumentary membrane of the *Asterias* is covered with innumerable small transparent fleshy tubes, which in the living state are seen advancing and receding through openings in the integument. The interior of these tubes is lined with cilia, and by their vibrations currents of water are made to flow through them into the visceral cavity, into which they open. The peritoneal membrane lining this cavity presents a considerable extent of surface continually in contact with the surrounding medium, and appears to be the principal seat of respiration. Its surface is covered with cilia, by which currents of water are made to flow in a determinate direction,

and thus the stratum in contact with the vascular membrane is incessantly renewed, and respiration thereby maintained.

[In the *Echinidæ* (fig. 174), the space comprised between the viscera and the test is filled with water, which is drawn into and rejected from the body by five pairs of membranous respiratory tubes, collected into ten tuft-like organs, situated around the circumference of the oral aperture, and opening internally by two perforated pits, as in *Asterias*. The water thus introduced into the interior of the test flows along the membrane, covering its surface, and over the peritoneal layer, investing the digestive organs and tubular feet and ovaria by the action of cilia, so that the interior of the test of the *Echinus* is incessantly traversed by respiratory currents, whilst the blood, circulating through the coriaceous integument, is in like manner aerated by currents flowing over its surface by the vibrations of cilia.

In the *Holothuria* (fig. 232), the respiratory function is limited to a pair of organs formed after a type which attains



Fig. 232.—The anatomy of the *Holothuria tubulosa*.

its full development, among the air-breathing vertebrata, instead of entering the general visceral cavity by tubes, and flowing over the surface of the peritoneum by the motions of cilia, as in the *Asteriadae* and *Echinidae*; the water is inspired through a single chamber, called the cloaca (*g*, fig. 232); and by the contraction of its muscular walls flows into two tubular branched organs (*i*, *k*), attached by a process of the peritoneum to the walls of the body; upon the membranous lining of these organs, which divide and subdivide, like a tree, into branches, terminating in tuft-like cells (*m*); the blood-vessels ramify like the pulmonary vessels on the bronchial tubes in the air-breathing vertebrata, which they further resemble in the rhythmic movements of dilatation and contraction, which take place three times in a minute in the *Holothuria tubulosa* (fig. 232), the water, after each inspiration, remaining about twenty seconds in the body.

[§ 379. The respiratory organs, in all the other classes of the animal series, may be grouped into three principal forms; branchiæ, tracheæ, lungs. The plan manifested in the structure of these organs is to fold up, into the smallest possible space, a large extent of membranous surface, upon which a network of blood-vessels may be spread. It is impossible to imagine a more perfect fulfilment of these conditions than is accomplished in the structure of the branchiæ and lungs, whereby the whole circulating fluid of the body is made to traverse a vascular network, and is brought thereby into mediate or immediate contact with the air of the atmosphere, or that held in solution in the water: as a general rule, it may be stated that branchiæ are adapted for aquatic, and lungs for aërial respiration.

[§ 380. Most of the mollusca respire by branchiæ. In the TUNICATA they occupy the interior of a cavity which is traversed by currents of water, entering at one orifice and escaping at another, and caused by the vibrations of cilia. In the *Salpæ* the branchia has the form of a tube, formed by a fold of the internal membrane, disposed transversely in spiral turns, which gives an annulated appearance to the cavity, and has caused it to be likened to the tracheæ of insects. The superior border of this membrane is provided with an infinity of small vessels, running parallel with each other; in other genera the branchia forms a more continuous lining of the respiratory

sac; the inhaled currents are made to traverse the body by the cilia, encircling the afferent aperture, and developed on the surface of the branchial membrane.

In the CONCHIFERA the mantle presents two orifices, the one for the entrance and the other for the exit of the water from the branchial cavity. In the oyster (fig. 176), the branchiæ form four leaflets (*h*, *k*), attached by their contiguous upper margins, and free below; they consist of innumerable elongated filaments, covered by a delicate membrane, on which a rete of capillary blood-vessels is spread; vibratile cilia are developed on the surface of this membrane, as well as on that of the branchial cavity, by which currents of water are made to traverse the respiratory organs in a determinate direction; in the conchifera, burrowing in rocks, sand and mud, the branchiæ are greatly elongated, and the mantle is prolonged into tubes, for conducting water into the pallear cavity. The vibratile cilia are of large size in *Mytilus* and *Anodon*, covering the entire surface of the branchial filaments, and lining all parts of the respiratory cavity; a small portion of the branchiæ, detached from the living animal, is seen to row itself, like an animalcule, through the water, by the motion of its cilia.

Nearly all the GASTEROPODA respire by branchiæ, which, in most of the naked marine species, are in the form of tufts, fans, or combs, variously disposed on the surface of the body, and in the testaceous kinds are concealed under a fold of the mantle. In the *Doris* (fig. 221) the branchiæ (*e*) form elegant ramose tufts, disposed around the anal opening; in *Thethys* they are composed of two dorsal rows of alternately tufted and crested organs. In *Aplysia* (fig. 177) they occupy the right side of the body, and are protected by a delicate pellucid shell. In the numerous pecteni-branchiate gasteropods, as the *Paludina* (fig. 35), inhabiting univalve turbinated shells, the branchiæ (*g*) are placed under an extended fold of the mantle, and in many of the carnivorous genera the water is conducted into the branchial chamber, through a muscular siphuncle, lodged in a canal of the shell, and flowing over the surface of the filamentary gills, by the vibrations of the cilia, is discharged through an opening in the pallear cavity, carrying with it the excreted materials from the glands and intestinal canal.

[In the PTEROPODA, as the *Clio* and *Hyalea*, the branchiæ resemble membranous expansions, like fins, or lamellæ, on the surface of the body. In the CEPHALOPODA they form two or four organs, lodged in a distinct chamber, into which the water is inspired, and expelled through a funnel-like tube, situated on the under side of the neck.



Fig. 233.—
Branchiæ of
the *Arenicola*.

[§ 381. The CRUSTACEA present various phases of branchial development; in the lowest forms, no special organ exists; the tegumentary membrane forming a general aërating surface. In the branchiopods, the last joints of the feet are flattened and covered with a vascular membrane, adapted for respiration; these organs having a continual oscillating movement. In the *Squilla*, the branchiæ are limited to the abdominal members; whilst in the decapoda, as the crab and lobster (fig. 222), they are formed like those of mollusca and fishes, and lodged in separate cavities under the thoracic shield; the renewal of the water being effected by the motion of distinct appendages. In those crustacea, as the land crabs, which live for a time on shore, the branchiæ are kept moist by the membrane lining, the cavities being disposed in folds, to serve as reservoirs for water; and sometimes it presents a spongy texture for the same end.

[§ 382. The marine ANNELIDA respire by branchiæ variously disposed, on different parts of their bodies; in those living in tubes, as *Serpula* and *Sabella*, they resemble the tentacula of polyps, and form plumelike coloured organs, sometimes with a spiral winding. When fully expanded in the water, they are adorned with the most beautiful colours. In the *Amphitrite* they are pectinated; in *Terebellæ* they resemble small trees planted round the neck. In the genera which swim freely through the water, they are disposed in longitudinal lines; in the *Arenicola* (fig. 233), they form a series of tufts, rich in bloodvessels. In *Eunices*, they have a pectinated form, and in *Aphrodita* they are placed on scales along the back. In the *Hirudo* (fig.

178) a series of vesicles lined with mucous membrane, and richly supplied with blood vessels, are regarded as respirating sacs.

[§ 383. Fishes respire by branchiæ, or gills, for the support and protection of which a complicated framework of bones, cartilages, ligaments, and muscles is provided; the form and arrangement of this apparatus varies in the different families and genera. It may, however, be classified into—1st. The lingual bone and branchiostegous rays; 2nd. The branchial arches; 3rd. The opercula or gill covers.

The gills are for the most part attached to the branchial arches, which extend from the sides of the os hyiodes, backwards to the cranium. They are, in general, four in number on each side of the head, and are composed of numerous lamellæ, placed closely together, and arranged in a regular series over the whole external convex margin of the branchial arches, like the barbs of a feather, or the teeth of a comb. Everything is arranged to afford the greatest possible extent of surface for the contact of the water with the mucous membrane on which a rich vascular network is spread. In the common ray, the extent of surface of the mucous membrane of the gills is estimated at 2250 square inches. In osseous fishes, as the pike and perch, the gills adhere by their superior border, and are covered by moveable opercula. In the cartilaginous genera, as the rays and sharks, they are attached by both borders, and there are no opercula; the water, which in the former enters by the mouth and escapes by the opercula, in the latter is expelled by a series of fissures situated at the sides of the neck. In the *Hippocampus* and *Syngnathus*, the gills are disposed in the form of tufts along the surface of the branchial arches, resembling the tufted branchiæ of gastropoda and annelida. In sucking fishes, as the lamprey, *Petromyzon*, they are in the form of vesicular sacs, arranged on each side of the neck, into which the water is introduced by a canal coming from the cavity of the mouth, and discharged through the holes situated at the sides of the same region.

Most fishes, besides gills, possess a hollow organ analagous to a lung, and called the air-sac, or swim-bladder; it is situated in the abdominal cavity, lying along the under side of the ver-

tebral column, and, in general, communicating with the pharynx, or stomach, by a membranous canal. Numerous blood-vessels and nerves, derived from the eighth pair and the sympathetic, are distributed on its walls; this organ is most developed in those fishes which come frequently to the surface of the water, and are remarkable for their vehement and prolonged muscular movements, as the *Lepidosteus* of the American rivers. The air-sac in this fish is divided into two chambers, the lining membrane presenting an arrangement of cells like the lung of a reptile; the duct from this air-sac, surmounted by a rudimentary larynx, opens high up in the throat, and, although a simple membranous tube, is the homologue of the trachea of air-breathing vertebrata. In the *Lepidosiren* the air-sac is a double organ, each division being divided into several lobes; it is situated behind the kidneys, against the ribs, and is internally cellular, like the lung of a serpent; anteriorly it opens by a tolerably long, narrow membranous tube into the esophagus; each division of the air-sac receives a branch of the pulmonary artery, arising from the branchial arteries. For these reasons the air-sac of fishes is regarded as a rudimentary lung, performing an accessory part in the great function of respiration. It is least developed, or even wanting, in those species which live at the bottom, and burrow in sand or mud, as the lampreys, rays, and *Pleuronectidæ*. Many fishes respire by the intestinal canal, the air which they swallow at the surface being employed for that purpose, as it escapes from the intestine loaded with carbonic acid gas. The fact of fishes swallowing air may be seen in the electric eel, and in fishes kept in vases, the water of which has been deprived of its air by their respiration.

[§ 384. The higher forms of reptiles, as serpents, lizards, and turtles, breathe by lungs. In the amphibia, one group comprising the frogs and salamanders, respire, during a term of their embryonic development, by vascular tufted gills; but these organs are subsequently absorbed, as the lungs become developed; and, during adult life, they breathe air by lungs, respiration being aided by the general surface of their smooth, naked, tegumentary membrane. In another group the gills are persistent through life, and co-exist with the lungs. Such is the case in the *Amphiuma*, *Menobranchus*, *Proteus*, *Siren*,

Axolotl; all these amphibia, like fishes, have branchial arches attached to the hyoid bone, and situated at the under part of the head; in the *Proteus*, there are three pairs of branchiæ, with ramified filaments, extending in the form of vascular branched organs to a considerable distance beyond the branchial apertures; the water enters by the mouth and escapes by the inter-branchial spaces. Besides gills, the perennibranchiate amphibia possess lungs resembling the air-sacs of fishes, and which we shall describe in treating of the development of these organs.

[§ 385. The second form of respiratory organs, called *tracheæ*, is met with in myriapoda, insecta, and some arachnida. The tracheæ are air-tubes which divide and subdivide, and become smaller and smaller in diameter, and penetrate the substance of all the organs; sometimes they are enlarged into vesicular sacs, of different forms and sizes (fig. 234). These tubes convey atmospheric air to the interior of all the tissues, and, as they are everywhere surrounded by the blood, diffused through the body of insects, a perfect aëration of that fluid is effected; the extensive ramification of the tracheæ being a compensation for the imperfection of their organs of circulation. The large quantity of air contained in the bodies of insects impart the necessary lightness and elasticity to them, and the highly oxygenated condition of their circulating fluids imparts energy to the muscular system, and precision and activity to their movements; to the same cause we must likewise attribute the high temperature which their bodies so often acquire. Fig. 234 exhibits the respiratory system in the *Nepa cinerea*. The air is admitted by the spiracles, or stigmata, into two great lateral tubes, which subdivide and ramify through the body; the tracheæ are lined with a soft mucous membrane, and covered externally with a dense, shining, serous coat; between these is interposed an elastic fibrous tunic, formed of a cartilaginous filament rolled into a spiral form, like the spiral vessels in plants. This admirable structure, affording as it does one of those striking examples of creative wisdom and design, extends through all the ramifications of the tracheæ, giving the necessary elasticity and patency to tubes destined to convey air, and to ramify like blood-vessels through all parts of the head, antennæ, palpi, legs, tarsi, wings, muscular, nervous and digestive systems;

the stigmata, or spiracles, are provided with muscles to open and close them, and with valves, processes, and hairs, va-

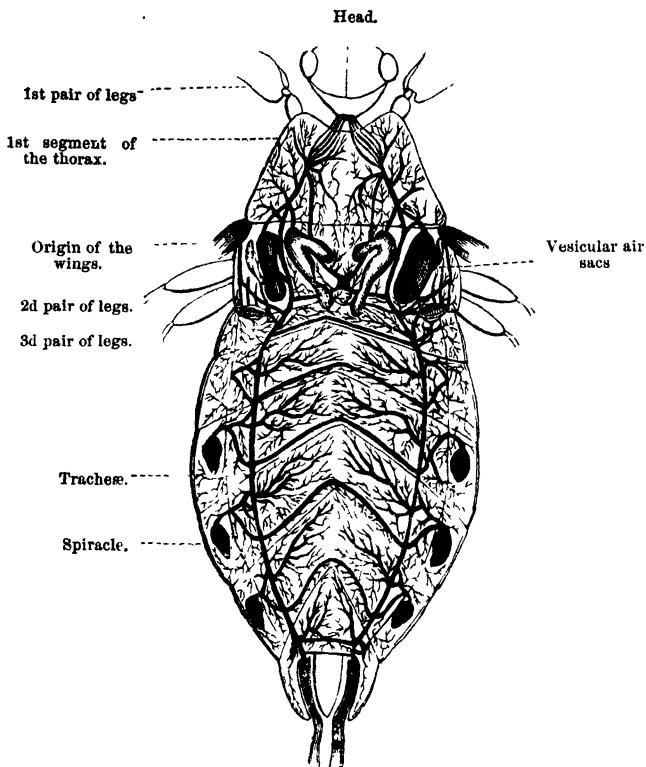

Fig. 234.—Respiratory apparatus of the *Nepa cinerea*.

riously modified in the different families, to protect them from the entrance of foreign bodies. The abdominal segments of the body exhibit rhythmic contractions and expansions during respiration, which are well seen in the dragon-fly, and resemble the muscular movements of the thorax and abdomen during the same act in the pulmonated vertebrates.—T. W.]

§ 386. In the lower vertebrata provided with lungs they form a single organ; but in the higher classes they are in pairs, placed in the cavity formed by the ribs, one on each side of the vertebral column, and enclosing the heart between them (fig. 235). The lungs communicate with the atmosphere by means of a tube, composed of cartilaginous rings, arising at the back part of the mouth, and dividing below,

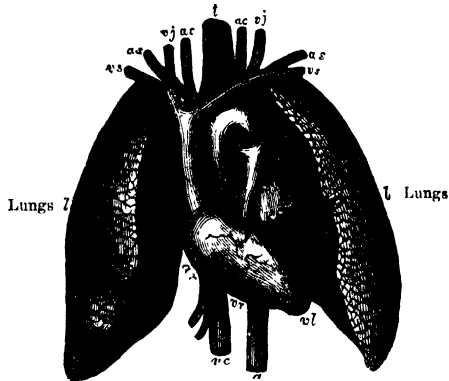

Fig. 235.—LUNGS, HEART, and principal blood-vessels of MAN.

ar, right auricle; *vr*, right ventricle; *vl*, left ventricle; *a*, aorta; *vc*, veinæ cava; *ac*, carotid arteries; *vj*, jugular veins; *as*, subclavian artery; *vs*, subclavian veins; *t*, trachea.

first into a branch for each organ, and then into innumerable branches penetrating their whole mass, and finally terminating in minute cells. This tube is the *trachea* (*t*), and its branches are the *bronchi*. In the higher air-breathing animals the lungs and heart occupy an apartment by themselves, the *chest* (fig. 124), which is separated from the other contents of the lower arch of the vertebral column by a fleshy partition, called the *diaphragm* (fig. 180), passing across the cavity of the body, and arching into the chest. The only access to this apartment from without is by the glottis through the trachea (fig. 235, *t*).

§ 386*. The mechanism of respiration by lungs may be compared to the action of a bellows. The cavity of the chest is enlarged by raising the ribs, the arches of which naturally slope somewhat downward, but more especially by the contraction of the diaphragm, whereby its intrusion into the chest is diminished. This enlargement causes the air to rush in through the trachea, distending the lungs so as to fill the ad-

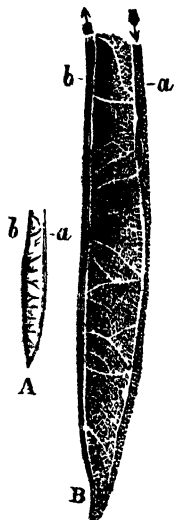

Fig. 236.—Lung of the water-newt (*Triton cristatus*): A, the natural size; B, magnified. *a*, pulmonary artery; *b*, pulmonary vein.



Fig. 237.—Portion of the lung of the *Triton cristatus*. The vessels are injected with fine size and vermilion, and form so dense a network that minute islets only of

ditional space. When the diaphragm is again relaxed, and the ribs are allowed to subside, the cavity is again diminished, and the air expelled. These movements are termed *inspiration* and *expiration*. The spongy pulmonary substance being thus distended with air, the blood sent from the heart is brought into such contact with it as to allow the requisite interchange to take place.

[§ 387. The minute anatomy of the lungs, in vertebrate animals, exhibits many interesting varieties. The structure is simplest in the naked amphibia, where it is but little more complex than in the snails.* In the water-newt, for instance, the lungs present themselves as a pair of simple elongated sacs (fig. 236), attached to an extremely short rudimentary larynx, and internally exhibiting no projection; the air distends the entire hollow internal sac, or cavity. In the frogs the membranous surface of the lungs is increased by the development of cells upon their internal aspects (figs. 237 and 238), upon the bottoms of which cells other secondary and smaller ones can be perceived; all these pulmonic cells,

* The lung presents itself in its very simplest form in the snails and slugs. The contractile respiratory orifice here leads to a simple smooth internal cavity lined with a delicate mucous membrane, upon which the pulmonary vessels are distributed.

however, are merely parietal, and communicate directly with the middle cavity of the lung, which is filled with atmospheric air, and upon the membranous walls of which, as well as upon their bottoms, the blood-vessels ramify. In the turtles (fig. 239) and crocodiles the cellular subdivisions increase in number and decline in size, and the common cavity is divided by various bands and septa stretching across it, into a number of mutually communicating sacs or pouches; the whole lung thus acquires a more compact or parenchymatous appearance. In the serpents (fig. 240), in which one only of the two lungs is ever completely evolved, this at the upper part is covered with small parietal cells; but these gradually become smaller and smaller, less and less distinct, and finally disappear entirely, so that the lower part of the lung is completely vesicular and unvascular.

[§ 388. In the class of birds we observe, in the same interesting manner, the general type of the lung preserved, but the surface of contact is greatly increased by means of parietal cells, which are repeated again and again. This modification is made necessary by the larger quantity of blood which is here transmitted to



Fig. 238.—Portion of the frog's lung from within, to shew the open parietal cells—figure drawn twice the size of nature.

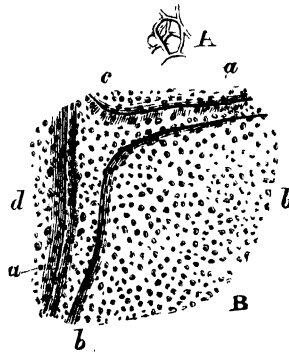

Fig. 239.—A, several cells from the lung of a Tortoise. A portion of one of these cells is exhibited in B, magnified five hundred times—part of the septum, *a, a*, which divides this cell from those next to it, *c* and *d*, is seen. The vessels are injected with size and vermilion, and form such thick masses, that the islets of pulmonic parenchyma betwixt them almost disappear.

the respiratory system, and the consequent augmented amount



Fig. 240.—A piece from that part of the Serpent's lung which is most scantily supplied with vessels, magnified four hundred times. The vessels here form a very beautiful rete, with wide meshes; they have been successfully injected with fine size and vermilion.



Fig. 241.—Terminal vesicles of the human lung, hanging to a branch of the bronchi as berries hang to their stalk, and distinct from one another. The figure is half a plan, and the magnifying power used very high.

of respiratory process, by which a larger extent of membranous surface became indispensable. The bronchi in birds are continued into the lungs, where they divide into membranous tubes, which permeate their substance; the deeper tubes stand like organ-pipes, and open into the superficial tubes; and all are covered with small parietal cells, upon which vessels are distributed; the cells form very elegant, delicate microscopic reticulations, and generally present themselves as six-sided spaces.

[§ 389. The lungs of man and the mammalia are formed after another and a different type; the trachea here divides and subdivides, like the branches of a tree, into finer and finer branches, which at first contain cartilages in their constitution, but which by and by become membranous, and finally end in blind sacculi, or rather in hollow berry or bud-like and clustered vesicles (figs. 241 and 242). The pulmonic cells of man and the mammalia, consequently, are not parietal, but terminal; they vary from the

6th to the 18th of a line in magnitude, the majority of them measuring between the 8th to the 10th of a line in diameter.

Delicate arcuate fibres, of the nature of elastic tissue, surround these terminal vesicles, and hold them distended, whilst the vessels spread freely over their surface (fig. 242).

[§ 390. The development of the lungs is extremely interesting. In the embryo of the bird and mammal they first appear in the shape of a simple, and then of a double projection from the esophagus (fig. 244, *a*), which soon divides more distinctly into two, becomes separated from this part, and is finally supported upon a pedicle—the future trachea (fig. 244, *b*). In birds these little sacs are then drawn out into hollow

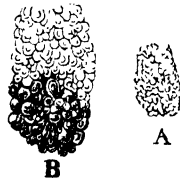

Fig. 242—A, portion of the lung of a hog. The terminal vesicles are filled with mercury, and of the natural size. B, the same part seen under a simple lens.

tubes, which pass over into the parallel pipes above described (§ 387). In the mammalia they divide, after the manner of branches, into twigs and minute vesicles (figs. 241 and 242), which advance in development, and become the future terminal cells (fig. 242, B).

[§ 391. The capillary vascular network of the lungs, as already stated, exhi-

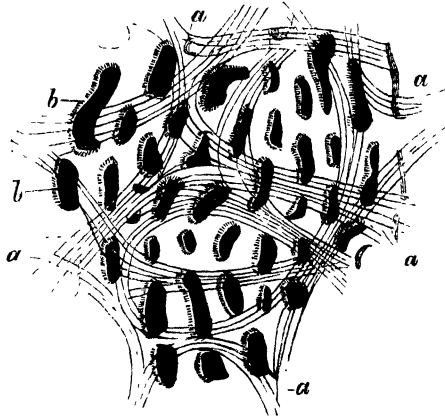

Fig. 243.—Small portion of lung from the body of a man examined shortly after death, under a magnifying power of 200 times. The vessels, *b, b, &c.*, still turgid with blood, include very minute islets of parenchyma between them; the semicircular fibres, *a, a, a*, surround the smallest terminal cells of the lungs.

bits a peculiar structure, which may be studied very readily in the lungs of the live newt (fig. 230), or in preparations of the same part that have been finely injected. From the whole extent of the pulmonary artery a vast number of very small arteries arise, the orifices of which give the inner surface of its principal branches the appearance of a regularly perforated sieve; these minute vessels form a very close irregular hexagonal intermediate network, without resolving themselves into branches and twigs like a tree, and so forming a capillary rete. Yet single larger vessels (fig. 230, *d*) proceed from the pulmonary artery to reach some more remote part of the lung. The pulmonary vein, like the pulmonary artery, is partly perforated at every point in its course for the reception of smaller vessels, and is partly formed by larger venous trunks, which collect and bring the blood from greater distances (fig. 230, *c*). The islets of the thin and indistinctly cellular parenchyma, are often of a diameter inferior to that of the vessels which surround them; this is the case in the tortoise, for example (fig. 239), and appears to be the case in man also (figs. 241, 242). It is remarkable that even in the more conspicuous branches of the pulmonary vascular system, the layer of transparent lymph in immediate contact with the walls of the vessels

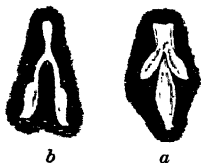

Fig. 244.—*a*, Rudiment of the lung in the embryo of the fowl of the fourth day; *b*, the lung in the embryo of the sixth day. Both figures twice the size of nature.



Fig. 245.—The greater part of the right lung of a foetal sheep, an inch and a half long, seen under the microscope (after Müller, *De Gland. discern. struct. penit.* T. xvii. f. 7).



Fig 246.—Termination of one of the branchings of the bronchi from the lung of a very young embryo of the hog after Rathke (fig. viii. T. xviii.)

should either be wanting, or of the greatest delicacy; and that no lymph-corpuscles should be visible swimming in it apart from the general current, but that they should be observed mingled with the common stream (fig. 230 *a, b, c*.)*

[§ 392. The organs which serve in man and the various classes of animals for respiration, and the mechanical part of the function of these organs, have now been described. The very essence of respiration, however, consists in this: that the air of the atmosphere brought into contact with the blood within the lungs effects certain changes in that fluid which are indispensable to the maintenance of life. The air, it is true, does not come into direct contact with the blood even in the lungs, but is separated from it by the parietes of the pulmonary cells and the walls of the blood-vessels. The air, however, readily penetrates these moist tissues, for it combines with the watery fluid which permeates them, and so makes its way even immediately to the blood.† As the lungs contain air at all times, the influence which the elastic fluid exerts upon the blood, and the changes which the blood undergoes, are not connected with the alternate assumption and rejection of so much air. These are but means to an end: the proper respiratory process, or that process for which inspiration and expiration are instituted, goes on incessantly. Inspiration and expiration are merely provisions for changing the air, which must be renewed at intervals, longer or shorter, if the object of respiration is to be attained.—Before entering on the peculiar chemical processes occurring in respiration, it is proper to inquire into the changes which, 1st, the *air*, and 2nd, the *blood*, experience in its course.

[§ 393. The earliest accurate researches into the nature of respiration, were instituted with a view to determine the changes which the air experienced in passing through the lungs, and our information upon this part of the function

* Professor Wagner's Physiology, pp. 358, *et seq.*

† The penetration of the moist parietes of the air-cells and blood-vessels is a general physical phenomenon, and independent of any peculiar power or property inherent in the lungs; any moist animal membrane without or within the living body is gradually penetrated by the air of the atmosphere and other gases. (§ 413). The extensive subdivision which the blood undergoes in the minute vessels of the lungs is obviously calculated greatly to assist the operation of the air.

may be said to be pretty full. The air of the atmosphere consists of a mixture of nitrogen and oxygen, with a slight addition of carbonic acid and of hydrogen gases: 100 parts of atmospheric air consist, according to the latest analyses, very constantly of 79 parts of nitrogen, and 21 of oxygen; the admixtures of carbonic acid and hydrogen, on the contrary, are extremely variable in amount; the carbonic acid has been ascertained to vary between 0,0003 and 1,0 per cent.; the hydrogen may amount to about 1 per cent. The air that is expired yields very nearly the same quantity of nitrogen as the air that is inspired; but it contains less oxygen, and a larger quantity of carbonic acid, and also of hydrogen; it likewise contains some volatile organic matters. The quantities of oxygen and carbonic acid, in the air, have altered relatively during respiration, in suchwise that the volume of the oxygen which has disappeared is rather greater than that of the carbonic acid which has made its appearance. Sir Humphrey Davy breathed during one minute, making 19 inspirations in the time, 161 cubic inches of air, which in 100 parts consisted of 72,7 nitrogen, 26,3 oxygen, and 1,0 carbonic acid; and during this time he expired 152 cubic inches of air, of which 100 parts contained 73,4 nitrogen, 15,1 oxygen, and 11,5 carbonic acid. In this experiment, consequently, if we disregard the disappearance of 9 cubic inches of air and a slight increase of nitrogen, it appears that from the respired air 11,2 per cent of oxygen had vanished, and 10,5 per cent. of carbonic acid had appeared. In the experiments of Allen and Pepys, 100 parts of expired air were found to consist of 79 nitrogen, 13 oxygen, and 8 carbonic acid; supposing, therefore, the air which was breathed to have been of the normal constitution, 8 per cent. of oxygen had disappeared, and rather more than 8 per cent. of carbonic acid had been evolved. Like results were come to by Dulong, Despretz, Lavoisier, and Seguin. In the quantity of the absorbed oxygen and of the added carbonic acid, however, the statements of the different observers differ. Davy, for example, found that the quantity of the added carbonic acid amounted to from 3,95 to 4,5 per cent.; in the particular experiment quoted above, it was as much as 10,5 per cent. Allen and Pepys state it at from 8 to 8,5 per cent.; Berthollet at from 5,53 to 13 per cent.; Menzies at 5 per cent.; Prout at from

3,3 to 4,6 per cent. ; Murray at from 6,2 to 6,5 per cent. ; Fyfe at 8,5 per cent., and Irvine at 10 per cent. The mean of the whole of these observations is about 5,8 per cent. If we presume that errors had crept into some of these experiments, it is still obvious that the quantity of carbonic acid eliminated by different individuals, and at different times, is not always the same. Prout, whose skill in observation inclines us to place the most implicit reliance on his results, found by direct experiment that the time when the smallest quantity of carbonic acid was produced, was shortly after midnight ; it increased towards morning, and rose continually towards mid-day, when it attained its maximum ; in the afternoon it declined again, and sank continually through the course of the evening, until it reached its minimum about midnight. The formation of carbonic acid, therefore, experiences regular fluctuations in accordance with the times of the day. Prout observed, farther, that a larger quantity of carbonic acid was produced in states of mental tranquillity, during gentle exercise and with a low state of the barometer ; and that, on the contrary, less was formed under the influence of active exertion, depression of mind, and the use of spirituous liquors. The estimates which we have of the absolute quantity of carbonic acid eliminated during a given time also vary greatly. According to Lavoisier and Seguin, the quantity formed in twenty-four hours amounts to 8,534 grains French ; according to Davy, it is 17,811 grains English ; according to Allen and Pepys, it is 18,612 grains English. But these quantities Berzelius has shown are far too great with reference to the quantity of food consumed in the same interval of time.*

* Berzelius observes (*Thierchemie*, 3te Auf. S. 124), that upwards of six pounds of solid aliment daily would be required to replace this loss of carbonic acid, even were the whole of the carbon of the food to be eliminated by the lungs in the shape of carbonic acid, and none to pass off with the fœces, the bile, the urine, &c., which, however, is very far from being the case. The above quantities must, therefore, be looked upon as exaggerated, though the observations themselves may be perfectly correct ; the error, probably, lies in the reckoning ; during the short period that such experiments last—one or two minutes—inspiration and expiration are almost certainly forced or exaggerated ; the air is more rapidly changed, and more carbonic acid is eliminated than during ordinary respiration. The indications afforded by two minutes, under such circumstances, applied to the whole of the twenty-four hours, obviously raise the general result far above the proper standard.

The quantity of water contained in the expired air amounts, taking the mean of the estimates of a great number of observers, to about 8,000 grains, or one pound in the four-and-twenty hours.*

RESPIRATION IN GASES OTHER THAN ATMOSPHERIC AIR.

[§ 394. With a view of obtaining still more precise information regarding the changes induced in air by its assumption into the lungs, experiments have been instituted on the respiration of different kinds of gas. These experiments, however,

* See Müller's *Physiology*, by Baly, vol. i. p. 330. The statements in the text refer particularly to man; but they also apply very closely to animals which breathe by lungs, with this difference, that in cold-blooded animals the quantities of oxygen absorbed, and of carbonic acid eliminated, are relatively smaller. Dulong found, no matter what animal he made the experiment upon, that there was rather more oxygen absorbed than carbonic acid evolved. The excess in gramivorous animals amounts to one-tenth; in carnivorous creatures, it was from one-fifth to one-half more than the carbonic acid. Despretz observed the same thing. Allen and Pepys, on the other hand, found the quantity of oxygen that disappeared, and of carbonic acid that was generated, to be equal. The oxygen which disappears is used up in the combustion of hydrogen, the product of which is watery vapour. Treviranus and Müller instituted comparative experiments upon the respiration of some of the lower animals, and the quantity of carbonic acid formed in a given time, contrasted with the weight of the animal, from which it appears that mammals, for every one hundred grains of their weight, produce 0.52 of cubic inch of carbonic acid in one hundred minutes; that birds, considered in the same way, produce 0.97 of a cubic inch; that amphibia (the frog), still considered in the same way, produce 0.05 of a cubic inch. The respiratory process performed by the medium of water is precisely the same as that which goes on with the direct contact of air: the air dissolved in the water comes into contact with the blood which circulates through the gills, and oxygen disappears, and carbonic acid appears as usual. Water, in general, contains from five to five and a quarter per cent. of its bulk of air dissolved in it—this air, however, having a somewhat greater relative proportion of oxygen than the air of the atmosphere, oxygen being somewhat more soluble in water than nitrogen. We have very admirable researches on the respiration of fishes by A. von Humboldt and Provençal. The water in which the fishes were put in these experiments contained 20,3 per cent. of air, which, in one hundred parts, consisted of 29,8 oxygen, 66,2 nitrogen, and 4,0 carbonic acid. After having been used for respiration, the water still contained 17,6 per cent. of air, which consisted, in one hundred parts, of 2,3 oxygen, 63,9 nitrogen, and 33,8 carbonic acid. Here, therefore, oxygen was also absorbed, and carbonic acid evolved.

almost necessarily extended to the consideration of the effects which breathing different gases produced upon the organism, as well as to the changes which the gases suffered in the process. We shall therefore here consider the two together. During healthy respiration, the atmospheric air that supplies the lungs is constantly changed. If this renewal of the air is not provided for, but the same air is breathed over and over again, the circumstances attending respiration are altered. In the same proportion, for example, as the oxygenous contents of the air diminish, and the carbonaceous contents increase, less and less oxygen is absorbed, less and less carbonic acid is evolved; and when the air comes to have a certain proportion of carbonic acid mixed with it, which, from the experiments of Allen and Pepys, appears to be ten per cent., no more carbonic acid is formed, and the elastic fluid no longer suffices for respiration, although it still contains something like ten per cent. of oxygen. A little oxygen, indeed, continues to disappear, but the respiration becomes laborious, and cannot be carried on without imminent risk of suffocation to any of the higher animals. This is the source of the oppressive sensation experienced when many persons, crowded together in a limited space, continue to breathe the same atmosphere. In pure oxygen gas respiration goes on as readily as in atmospheric air, but a feeling of uneasiness and of exhaustion is soon experienced. The changes produced in the gas are of the same nature as when the common atmospheric air is breathed—oxygen disappears, and carbonic acid is engendered; the quantity of the latter, according to Allen and Pepys, being, however, greater than under ordinary respiration—it amounts, instead of eight per cent., to between eleven and twelve per cent. The same experimenters also found that nitrogen gas was evolved during the respiration of oxygen gas. Nitrous oxide gas (consisting of sixty-four nitrogen, thirty-six oxygen), like oxygen, will support life for a time, but it produces a peculiar intoxicating effect upon the economy. A portion of the gas is dissolved by the blood, which assumes a purple red colour; and the face and hands, in consequence of this change, acquire a livid and cadaverous hue. Nitrogen and traces of carbonic acid are found in the expired nitrous oxide gas. Pure nitrogen, although it can be taken readily into the lungs, and is not at all poisonous, is quite incompetent to support

life; small animals immersed in it, therefore, soon die asphyxiated. Pure hydrogen, too, can be breathed, but will not support life; it is either without effect on the economy, or exerts a soporific influence. The experiments of many inquirers, however, have shown that cold-blooded animals, such as frogs, can exist for hours in pure nitrogen and hydrogen; they become asphyxiated at length, and are apparently dead; but if not kept too long immersed in the gases, they recover when brought into contact with the air of the atmosphere. All observers, too, are agreed that these animals eliminate carbonic acid when confined in nitrogen and hydrogen. In a mixture of four parts hydrogen and one part (volume) oxygen, animals were found by Allen and Pepys to become sleepy, without any prejudicial effect upon the health appearing to ensue. Oxygen disappeared, and carbonic acid was evolved precisely as when atmospheric air was breathed; at the same time, however, nitrogen made its appearance, and in such quantity, too, that in the course of an hour the volume eliminated equalled, and even exceeded by a half, the volume of the animal which was the subject of experiment. Other gases are true poisons to the economy—carburetted, phosphuretted, sulphuretted, arseniuretted hydrogen, &c. Air that contained no more than 1-1500th of its bulk of sulphuretted hydrogen was sufficient to prove fatal to a bird; 1-800th destroyed a dog, 1-250th killed a horse. Some gases inspired in a state of purity, or but little diluted, induce spasm and complete closure of the glottis, and consequent death; more largely diluted, they excite violent cough. To this list belong chlorine, the vapour of iodine, nitric oxyde, ammoniacal gas, fluoboric and fluosilicious gas, and the greater number of the strong acid vapours, such as those of nitric acid, sulphuric and sulphurous acid, succinic acid, &c. The greater number of the particulars related in the preceding paragraph have been made known to us through the admirable researches of Sir Humphrey Davy.]*

§ 395. The vivifying power of the air upon the blood is due to its oxygen. If an animal be confined for a time in a closed vessel, and the contained air be afterwards examined, a considerable portion of its oxygen will have disappeared, and another gas of a very different character, namely, carbonic

* Dr. Julius Vogel, in Wagner's Physiology, p. 366.

acid gas, will have taken its place. The essential office of respiration is to supply oxygen to the blood, at the same time that carbon is removed from it.

§ 396. An immediately obvious effect of respiration in the red-blooded animals is a change of colour; the blood, in passing through the respiratory organs, being changed from a very dark purple to a bright scarlet. In the great circulation the scarlet blood occupies the arteries, and is usually called *red blood*, in contradistinction to the venous blood, which is called *black blood*. In the lesser or pulmonary circulation, on the contrary, the arteries carry the dark, and the veins the red blood.

§ 396*. The quantity of oxygen consumed by various animals in a given time has been accurately ascertained by experiment. It has been found, for instance, that a common-sized man consumes, on an average, about one hundred and fifty cubic feet in twenty-four hours; and as the oxygen constitutes but twenty-one per cent. of the atmosphere, it follows that he inhales, during a day, about seven hundred cubic feet of atmospheric air. In birds, the respiration is still more active, while in reptiles and fishes it is much more sluggish.

§ 397. The energy and activity of an animal is somewhat dependent on the activity of its respiration. Thus the toad, whose movements are very sluggish, respire much more slowly than mammals, birds, and even insects; and it has been ascertained that a butterfly, notwithstanding its comparatively diminutive size, consumes more oxygen than a toad.

§ 398. The circulation and respiration have a reciprocal influence upon each other. If the heart be powerful, or if violent exercise demand a more rapid supply of blood to repair the consequent waste, respiration must be proportionally accelerated to supply air to the greater amount of blood sent to the lungs. Hence the panting occasioned by running or other unusual efforts of the muscles. On the other hand, if respiration be hurried, the blood being rendered more stimulant by greater oxygenation, causes an acceleration of the circulation. The quantity of air consumed varies therefore with the proportion of the blood which is sent to the lungs.

§ 399. The proper temperature of an animal, or what is termed ANIMAL HEAT, depends on the combined activity of

the respiratory and circulating systems, and is in direct proportion to it. In many animals the heat is maintained at a uniform temperature, whatever may be the variations of the surrounding medium. Thus birds maintain a temperature of about 108° Fahrenheit; and in a large proportion of mammals it is generally from 95° to 105°. These bear the general designation of *warm-blooded animals*.

§ 400. Reptiles, fishes, and most of the invertebrate animals, have not this power of maintaining a uniform temperature. The heat of their body is always as low as from 35° to 50°, but varies perceptibly with the surrounding medium, being, however, often a little above it when the external temperature is very low, though some may be frozen without the loss of life. For this reason they are denominated *cold-blooded animals*; and all animals which have such a structure of the heart, that only a part of the blood which enters it is sent to the respiratory organs (§ 366), are among them.

§ 401. The production of animal heat is obviously connected with the respiratory process. The oxygen of the respired air is diminished, and carbonic acid takes its place. The carbonic acid is formed in the body by the combination of the oxygen of the air with the carbon of the blood. The chemical combination attending this function is, therefore, essentially the same as that of combustion. It is thus easy to understand how the natural heat of an animal is greater, in proportion as respiration is more active. How far nutrition in general, and more particularly *assimilation*, by which the liquid parts are fixed and solidified, is connected with the maintenance of the proper temperature of animals, and the uniform distribution through the body, has not yet been satisfactorily ascertained.

§ 402. Some of the higher warm-blooded animals do not maintain their elevated temperature during the whole year; but pass the winter in a sort of lethargy, called *HIBERNATION*, or the *hibernating sleep*. The marmot, the bear, the bat, the crocodile, and most reptiles, furnish examples. During this state the animal takes no food; and as it respire only after very prolonged intervals, its heat is diminished, and its vital functions generally are much reduced. The structural cause of hibernation is not ascertained; but the phenomena attending it fully illustrate the laws already stated (§397—401).

§ 403. There is another point of view in which 'respiration should be considered, namely, with reference to the buoyancy of animals, or their power of rising in the atmosphere, and their ability to live at different depths in the water, under a diminished or increased pressure. The organs of respiration of birds and insects are remarkably adapted for the purpose of admitting at will a greater quantity of air into their body, birds being provided with large pouches extending from the lungs into the abdominal cavity and into the bones of the wing; insects have their whole body penetrated by air-tubes, the ramifications of their tracheæ, which are enlarged at intervals into wider cells, whilst most of the aquatic animals are provided with minute, almost microscopic tubes, penetrating from the surface into the substance, or the cavities of the body for admitting water into the interior, by which they thus adapt their whole system to pressures which would otherwise crush them. These tubes may with propriety be called water-tubes. In fishes, they penetrate through the bones of the head and shoulder, through skin and scales, and communicate with the blood vessels and heart, into which they pour water; in mollusca they are more numerous in the fleshy parts, as, for example, in the foot, which they help to distend, and communicate with the main cavity of the body, supplying it also with liquid; in echinoderms they pass through the skin, and even through the hard shell, whilst in polyps they perforate the walls of the general cavity of the body, which they constantly fill with water.

§ 404. In order fully to appreciate the homologies between the various respiratory apparatus observed in different animals, it is necessary to resort to a strict comparison of the fundamental connections of these organs with the whole system of organization, rather than to the consideration of their special adaptation to the elements in which they live. In vertebrata, for instance, there are two sets of distinct respiratory organs, more or less developed at different periods of life, or in different groups. All vertebrata, at first, have gills arising from the sides of the head, and directly supplied with blood from the heart; but these gills are the essential organs of respiration only in fishes and some reptiles, and gradually disappear in the higher reptiles, as well as in birds and mammalia, towards the close of their embryonic life (§ 489). Again, all vertebrata have lungs opening in or near the head; but the lungs

are fully developed only in mammalia, birds, and the higher reptiles, in proportion as the branchial respiration is reduced; whilst in fishes the air-bladder constitutes a rudimentary lung.

§ 405. In the articulata, there are also two sorts of respiratory organs; aërial, called tracheæ in insects, and lungs in spiders; and aquatic, called gills in crustacea and worms. But the tracheæ and lungs open separately upon the two sides of the body (air never being admitted through the mouth or nostrils in the articulata); the gills are placed in pairs; those which are like the tracheæ occupying a similar position, so that there are nearly as many pairs of tracheæ and gills as there are segments in these animals. The different respiratory organs in the articulata are in reality mere modifications of the same apparatus, as their mode of formation and successive metamorphoses distinctly show, and cannot be compared with either the lungs or gills of the vertebrata; they are special organs not found in other classes, though they perform the same functions. The same may be said of the gills and lungs of mollusca, which are essentially alike in structure, the lungs of snails and slugs being only a modification of the gills of aquatic mollusca; but these two kinds of organs differ again in their structure and relations from the tracheæ and gills of articulata, as much as from the lungs and gills of vertebrata. In those radiata which are provided with distinct respiratory organs, such as the echinoderms, we find still another type of structure, their gills forming bunches of fringes around the mouth, or rows of minute vesicles along the radiating segments of the body.

CHAPTER NINTH.

OF THE SECRETIONS.

§ 406. WHILE, by the process of digestion, a homogeneous fluid is prepared from the food, for supplying new material to the blood, another process is also going on, by which the blood is analyzed, as it were ; some of its constituents being selected and so combined as to form products for useful purposes, while other portions of it, which have become useless or injurious to the system, are taken up by different organs, and expelled in different forms.—This process is termed SECRETION.

§ 407. The organs by which these operations are performed are much varied, consisting either of flat surfaces or membranes, of minute simple sacs, or of delicate elongated tubes, all lined with minute cells, called *epithelium cells*, which latter are the real agents in the process. Every surface of the body is covered by them ; and they either discharge their products directly upon the surface, as on the mucous membrane, or they unite in clusters, and empty into a common duct, and discharge by a single orifice, as is the case with some of the intestinal glands, and of those from which the perspiration issues from the skin.

§ 408. In the higher animals, where separate organs for special purposes are multiplied, numerous sacs and tubes are assembled into compact masses called glands. Some of these are of large size, as the salivary glands, the kidneys, and the liver. In these, clusters of sacs open into a common canal, and this canal unites with similar ones, forming larger trunks ; and finally, they all discharge by a single duct, as we find in the salivary glands.

§ 409. By the organs of secretion two somewhat different purposes are effected, namely, fluids of a peculiar character are selected from the blood for important uses, such as the saliva, tears, milk, &c., some of which differ but little in their composition from that of the blood itself, and might be

retained in the blood with impunity; or the fluids selected are such as are positively injurious, and cannot remain in the blood without soon destroying life. These latter are usually termed excretions.

§ 410. As the weight of the body, except during its period of active growth, remains nearly uniform, it follows that it must daily lose as much as it receives; in other words, the excretions must equal in amount the food and drink taken, with the exception of the small proportion discharged by the alimentary canal. Some of the most important of these outlets will be now indicated.

§ 411. We have already seen that all animal tissues admit of being traversed by liquids and gases. This mutual transmission of fluids from one side of a membrane to the other is termed *endosmose* and *exosmose*, or imbibition and transudation, and is a mechanical rather than a vital phenomenon, inasmuch as it takes place in dead as well as in living tissues. The blood-vessels, especially the capillaries, share this property. Hence portions of the circulating fluids escape through the walls of the vessels, and pass off at the surface. This superficial loss is termed exhalation. It is most active where the blood-vessels most abound, and accordingly is very copious from the air tubes of the lungs, and from the skin. The loss in this way is very considerable, and it has been estimated that, under certain circumstances, the body loses, by exhalation, five-eighths of the whole weight of the substances received into it.

§ 412. The skin, or outer envelope of the body, is otherwise largely concerned in the losses of the body. Its layers are constantly renewed by the tissues beneath, and the outer dead layers are thrown off. This removal is sometimes gradual and continual, as in man; in fishes and many mollusca, it comes off in the form of slime, which is, in fact, a collection of cells detached from the surface of the skin; sometimes the loss is periodical, when it is termed moulting. Thus, mammals cast their hair, and the deer their horns, birds their feathers, serpents their skin, crabs their test, and caterpillars their outer envelope, with the hairs growing from it.

§ 413. The skin presents such a variety of structure, in the different groups of the animal kingdom, as to furnish excellent distinctive characters of species, genera, and even

families, as will hereafter be shown. In the vertebrata it is composed of three very distinct layers of unequal thickness (fig. 250); the lower and the thickest layer is the corium, (*c, c*), or true skin, and is the part which is tanned into leather. Its surface presents numerous papillæ, in which the nerves of general sensation terminate; they also contain a fine net-work of blood-vessels, usually termed the vascular layer. The superficial layer is the epidermis, or cuticle; the cells of which it is composed are distinct at its inner portion, but become dried and flattened as they are pushed outwards. It is destitute of vessels and nerves, and, consequently, is insensible. Between these two layers, and more especially connected with the cuticle, is the rete mucosum, a very thin layer of cells, some of which contain the pigment which gives the complexion to the different races of men and animals. The scales of reptiles, the nails and claws of mammals, and the solid covering of the crustacea are merely modifications of the epidermis; on the other hand, the feathers of birds, and the scales of fishes, are derived from the vascular layer.

[§ 413*. Dutrochet investigated the phenomena called *endosmose* and *exosmose* more carefully than had yet been done, and designated them by these names.*

Berzelius has given an excellent condensed view of the subject: "The phenomena exhibited by bodies in solution," he observes, "in traversing solid living parts, do not depend solely on the properties which bodies in solution have of diffusing themselves evenly through the fluids which are their menstrua; the animal membranes and the water contribute their share, inasmuch as the water passes with the dissolved substance, and from this results a phenomenon, which in its effects resembles in every respect an absorption. For the sake of illustration, let *a, a*, fig. 247, be a tube open at both ends, but having a piece of moist bladder tied around its lower extremity; let a solution of any salt be now poured into the

Fig. 247.

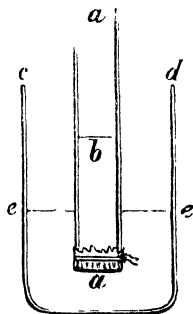

* Mémoires pour servir à l'Histoire Anatomique et Physiologique des Végétaux et Animaux, Paris, 1837.

tube, and this be plunged into a larger vessel, *c, d*, containing water, the tube being immersed till the solution, *a, b*, is at the same level, *e, e*, as the water in the outer vessel, *c, d*. After a little time it will be found that the fluid in *a, a* has risen, and got above the level, *e, e*, to *b*, for example, and that it is continuing to rise, and will go on rising until the two fluids, on the opposite sides of the bladder, are of the same density, so that, if the tube, *a, a*, be not of sufficient length, the fluid may even run over, having filled it completely. If the tube, *a, a*, instead of containing a saline solution, contain water, and the recipient, *c, d*, instead of water, contain a saline solution, things being disposed as before, the fluid in *a, a*, far from rising, will begin to fall, and instead of falling in *c, d*, it will begin to rise. When the tube and the recipient contain solutions of different salts respectively, but as nearly as may be of the same density, the level of the fluid in neither will be altered perceptibly; but, after a certain time, the two salts will be discovered mingled together in both the tube and the recipient, or in the fluid on both sides of the bladder. If the densities of the two saline solutions have been different, the surface of that which is the more dense will rise, that which is less dense will fall; but it will be found, nevertheless, that from the solution of greatest density a portion will have passed into that of least density; the penetration has not therefore been all one way, but reciprocally from each to the other, only in greatest measure from the less to the more dense fluid. This phenomenon does not take place only when moist animal membranes are the intermedia between the two heterogeneous but miscible fluids; it also occurs when the interposed body is of an inorganic nature, but thin and porous, and possessed of strength enough to support the increasing column of the denser fluid, such as thin slices of slate, earthenware, &c. In general it may be said that the power producing the phenomenon in question belongs to all bodies which can absorb and retain a fluid in extremely delicate pores."* The blood-vessels, especially the capillary vessels, share this property of permeability to liquids; hence, while the circulation goes on, portions of the circulating fluid, especially its watery parts, escape through the walls of the vessels, and pass off at the surface. This superficial loss, termed *exha-*

* Chimie, 4te. Aufl. B. ix. S. 161.

lation, is most active where vessels most abound, and accordingly most copious from the surface of the lungs. It has been estimated that, under certain circumstances, the human body loses, by exhalation, five-eighths of the whole weight of substances taken into it.

[§ 414. SECRETION is a more complicated process than exhalation. It is not a mere mechanical operation, but is accomplished by means of organs, called *glands*; which elaborate peculiar juices, such as the sweat, the tears, the milk, the saliva, the bile, the urine, &c.

[§ 415. At first glance there would seem to be nothing in common between the organs which secrete the tears and that which produces the bile, or between the kidneys and the salivary glands. Still they all have the same elementary structure. Every gland is composed of minute vesicles, or extremely thin membranous sacs, generally too small to be discerned by the naked eye, but easily distinguished by the microscope. Sometimes these vesicles are single, and open separately at the surface; they are then called *crypts* or *follicles*, but more frequently they unite to form clusters opening into a common canal, which itself unites with the canals of similar clusters to form trunks of various sizes, such as are found in the salivary glands (figs. 257 and 277), in the mammæ, or in the liver (figs. 265, 267), which is a very large gland receiving a great quantity of blood from the veins of the alimentary canal.

[§ 416. Sometimes the canals of the little clusters do not unite, but open separately upon the surface of the body or into its cavities, as in the intestinal glands or those from which the perspiration issues (fig. 250, e). Occasionally the canals themselves combine into bundles composed of a multitude of parallel tubes, as we find in the kidneys, figs. 260—262.—T. W.]

§ 417. The operation of the glands is one of the most mysterious phenomena of animal life. By virtue of the peculiar properties with which they are endowed, they select from the blood, which penetrates to their remotest ramifications, the elements of the special humours they are designed to elaborate. Thus the liver extracts the elements of the bile; the salivary glands the elements of saliva; the pancreas those of the pancreatic juice; and the sudoriferous glands those of the sweat, &c.

§ 418. Of the secretions thus formed by the different glands, some are immediately expelled from the body, as the sweat, the urine, &c.; these are denominated *excretions*. Others, on the contrary, are destined either to be used as food for the young, as the milk; or to take part in the different functions of the body, as the saliva, the tears, the gastric and pancreatic juices, and the bile, which are properly denominated *secretions*. Of all the secretions, if we except that from the lungs, the bile is the most important; and hence a liver, or some analogous organ by which bile is secreted, is found in all animals, while some or all of the other glands are wanting in the lower classes. In the vertebrata the liver is the largest of all the organs of the body. In the mollusca it is no less preponderant. In the gasteropoda, like the snails, it envelops the intestine in its convolutions (fig. 177); and in the conchifera, like the clam and oyster (fig. 176), it generally surrounds the stomach. In insects it is in the form of long tubes variously contorted and interlaced (fig. 179). In the radiata this organ is largely developed, especially among the echinoderms. In the star-fishes (fig. 36) it extends into all the recesses of the rays; and in colour and structure resembles the liver of the mollusca. Even in bryozoan polyps (fig. 175) we find brown cells lining the digestive cavity, which probably perform functions similar to those of the liver of higher animals.

STRUCTURE OF GLANDS.

[§ 419. The type or elementary form of every secreting gland is either a simple capsule, an elongated blind sac, or a rounded vesicle, upon the outer aspect of which vessels are ramified, and which on the inside generally exhibits numbers of small cellular projections or depressions, and an outlet through which the secreted matter escapes. Many of the cutaneous and mucous glands, as also the simple glands of the stomachs of birds (fig. 186, B. *a*, *d*), and the Lieberkühnian glands of the intestines, afford examples in point; but they soon begin to get more complex, coalescing, dividing, and sending forth new lateral lobules (fig. 185, B. *e*), and by repetitions of the same process even acquiring a pretty complicated mulberry appearance (fig. 184, B. *f*). The ventricular glands of mammals are already somewhat more compound (fig. 181, *et seq.*). The extent of secreting sur-

face can be increased without any additional external complexity, by a capsule or canal extended in length, and at the same time rolled up or convoluted upon itself. We have an example of this kind of gland in the ceruminous glands of the ear (fig. 248, A. B), and in the sudoriparous glands (fig. 249, A. B). We have only to conceive these two forms farther subdivided, ramified, and the several parts connected by means of vessels and cellular tissue, to have a perfect idea of the most complex parenchymatous gland. The skeleton of every gland is the ramified excretory duct, formed in the manner already described, to which are attached the secreting blind sacs, vesicles, or tubes, connected together by cellular tissue, and surrounded by net-works of capillary vessels.

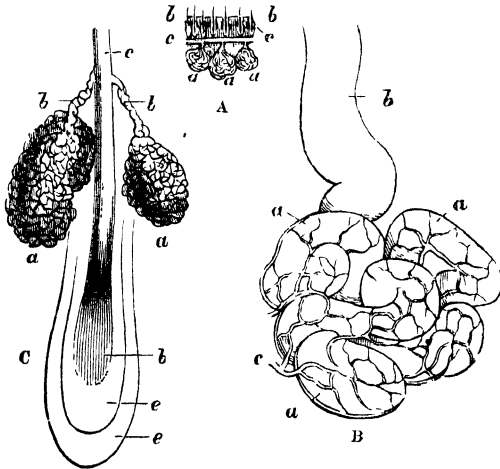

Fig. 248.—Glands from the meatus auditorius externus of a young female of eighteen. A, section of the skin, seen magnified three diameters; *b, b*, hairs; *c, c*, superficially situated sebaceous glands; *a, a*, larger and more deeply seated glands, which are coloured yellow, and appear to secrete the cerumen. B, a gland of this kind more highly magnified; *a, a*, the tortuous canal composing the gland and passing over into the excretory duct *b*; *c*, a small vessel, with its branches. C, a hair of the auditory passage, penetrating the epidermis at *c*, and at *d*, contained within its double follicle *e, e*; *a, a*, sebaceous follicles of the hair, with their excretory ducts.

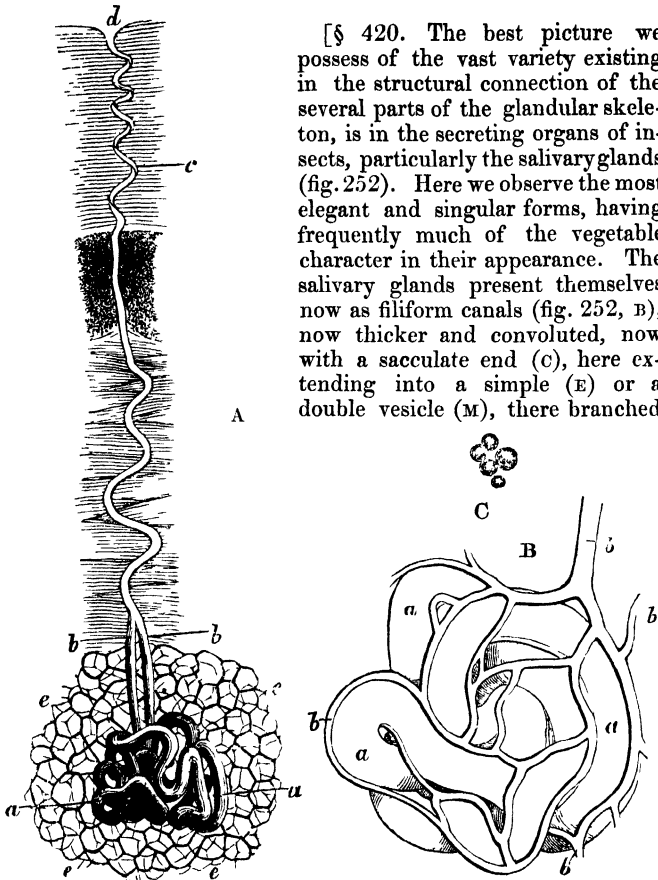

Fig. 249.—Sudoriparous gland from the palm of the hand of a young person eighteen years of age. A, a gland entire with its excretory duct, magnified forty times; *a, a*, the convoluted canals forming the gland, and from which two excretory ducts arise, *b, b*, which unite to form the single spiral duct, which, at *c*, passes through the laminæ of the epidermis, and opens on the surface at *d*; *c, c*, surrounding fat-cells. B, the same gland more highly magnified. Around the canal of the gland play the vessels, *b, b*. C, a few fat-globules from the emptied fat-cells.

[§ 420. The best picture we possess of the vast variety existing in the structural connection of the several parts of the glandular skeleton, is in the secreting organs of insects, particularly the salivary glands (fig. 252). Here we observe the most elegant and singular forms, having frequently much of the vegetable character in their appearance. The salivary glands present themselves now as filiform canals (fig. 252, B), now thicker and convoluted, now with a sacculate end (*c*), here extending into a simple (*E*) or a double vesicle (*M*), there branched

like the horns of a deer (α), or in the guise of a pair of long shaped canals ending in many smaller saccules, or forming a tuft or corymb of blind canals (Π), or a cluster of vesicles connected like a bunch of grapes or berries to a common duct (Λ , N).

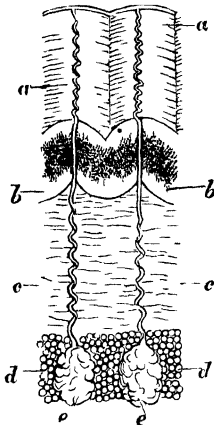

Fig. 250.—Two sudoriparous glands after Gurlt, *Magaz. f. d. gesammte Thierheilk.* 1835, Tab. 2, fig. 1. a , epidermis; b , tactile papilla; c , corium; d , adipose tissue; e , sudoriparous glands.

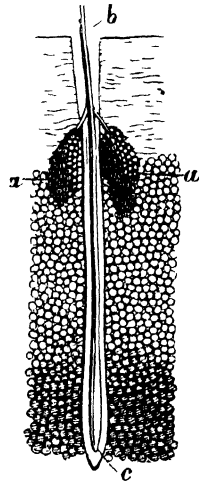

Fig. 251.—A thin layer from the scalp of the human subject. a , a , sebaceous glands; b , a hair with its follicle, c . After Gurlt, *Mag. f. d. gesam. Thierheilkunde*, 1835.

The varieties in form presented by the seminal organs or testicles are still greater, new inquiries constantly offering new shapes to our notice. From the simple, linear and filiform canal of *Julus* (fig. 253), to the highly complicated yet beautiful appearance, comparable to a leafy tree laden with fruit, which we observe in *Silpha obscura* (fig. 253, 10), there are forms of every intermediate degree of complexity, but always as varieties of the same elementary type. Even the simple canalicular or sacculate form presents numerous variations. In one case it is the straight pretty regular canal already indicated (1); in another the canal is irregular, of different thick-

nesses in different parts, and tortuous (2); in a third it is spirally twisted (3), or is rolled up into a skein simple or double, and with club-shaped ends (4), in every case for the

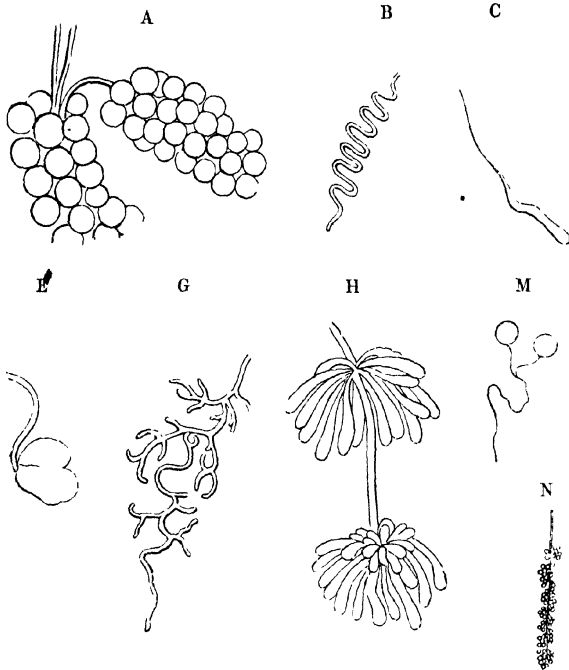

Fig. 252.—Salivary glands of insects, to show the variety in the form and combination of the secreting follicles, from the simple lobular or filiform canal and blind sac to the greatly complicated raceme.

A. Part of the salivary gland of *Nepa cinerea*. After Ramdohr.

B. Salivary vessel of *Asida grisea*. After Succow, *Anat. physiolog. Unters.*

C. Salivary vessel of *Musca deviens*. After the same.

D. *The same* of *Musca carnaria*. After the same.

E. *The same* of *Blaps gigas*. After the same.

F. *The same* of *Cicada ormi*. After the same.

G. *The same* of *Pulex irritans*. After Ramdohr.

H. *The same* of *Scolopendra Afra*. After nature.

(All these figures, with the exception of that indicated by N, are more or less magnified.)

obvious purpose of saving room ; in other instances, still, the organ presents itself in the shape of one or more club-like canals nearly straight (5), or bent at an angle with com-

Fig. 253.

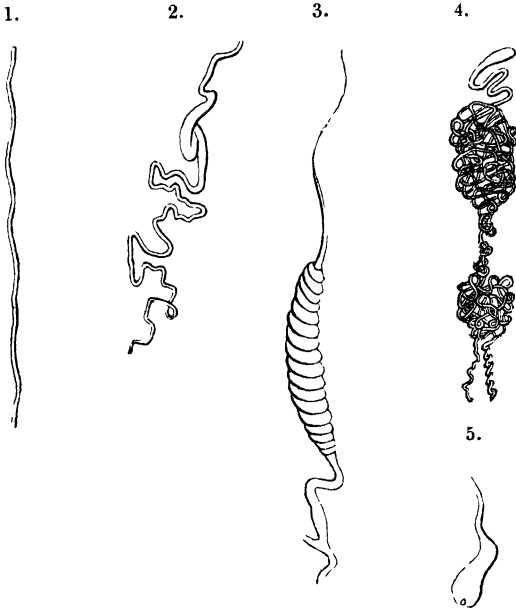

1. Testis of *Julus*.
2. *Tipula crocata*.
3. *Ranatra linearis*.

4. *Harpalus ruficornis*.
5. *Cercopis spumaria*.

mencing divisions at the end, or with the end forming a rounded vesicle ; or otherwise two cœcal canals are connected like hooks, or they are finger-shaped, or form tufts of different kinds—quiver-like, star-shaped (6), or like the flowers of syngenesious plants (7), or they form small saccules in the shape of pannicles (8), or they are clustered like grapes or berries, and attached to styles (9). In this way do the forms of this gland alter in nearly allied species in the insect world,

so rich in varied forms.* The peculiar constitution and mode of distribution of the blood of the insect division of the

Fig. 253 (continued).

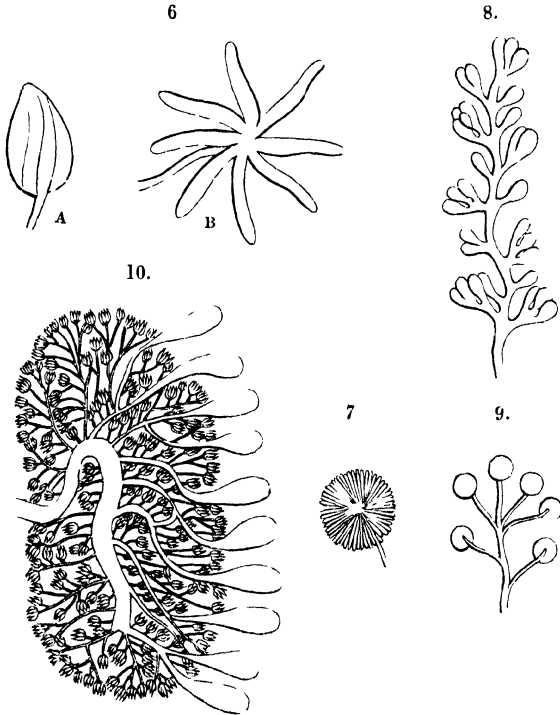

6. *Capsus tricolor*.
 7. *Bostrichus capucinus*.
 8. *Staphylinus maxillosus*.

9. *Prionus coriarius*.
 10. *Silpha obscura*.

* There are few divisions of comparative anatomy so much calculated to set in a clear light the importance of this science in connexion with the study of general morphology, as the sketch just given of the vast variety of form presented by the glandular system. If we would give plans or ideal outlines of the principal forms of the different elements of

animal kingdom (§ 370) probably required the singular unfolding of the glandular elements which we observe among its

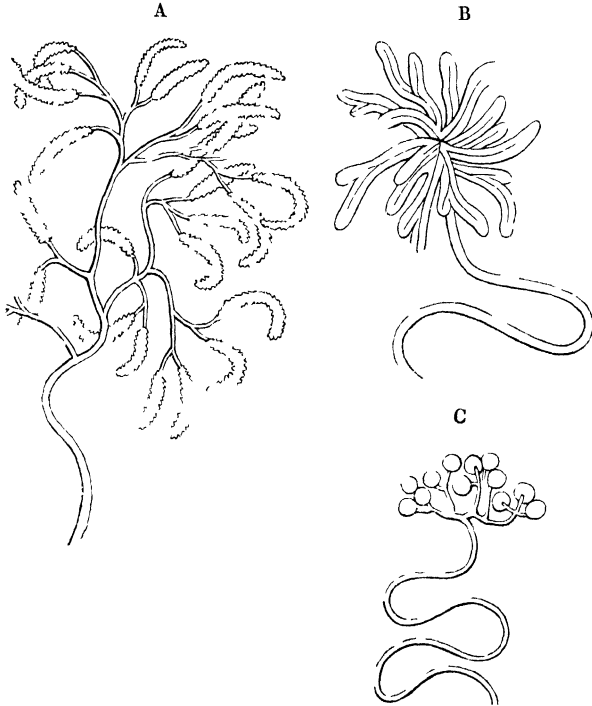

Fig. 254.—The glands of insects which secrete the acrid or corroding juice, after Leon Dufour, *An. d. Sc. Nat.* T. vii. pl. 19 and 20. A, of *Chlænus velutinus*. B, of *Biachinus crepitans*. C, of *Calathus fulvipes*.

the glandular system in man and the more perfect animals, no better method could be followed than to pursue a single gland through the class of insects. As supplementary to this part of our subject, the elegant forms which the clustered canals and vesicles of others of the special secreting organs of insects exhibit may be referred to in the subjoined figures.

members. The blind extremities of the glands are surrounded immediately by the blood, which is poured freely into all the interstices of the body, and so attract the substances from its mass which the glands of other and higher animals have brought to them by finely divided capillary reticulations, to be subjected to their peculiar elective attractions.

[§ 420*. It is infinitely more difficult to form an idea of the glandular skeleton of man and the vertebrata, in the fully formed condition, the composition of this being much obscured by the connecting cellular tissue and intermingled networks of vessels. Still there are cases even here, where, without peculiar difficulty, the two principal types in glandular architecture may be seized. As examples, the Harderian glands of birds generally (fig. 255), and the Cowper's glands of the hedgehog (fig. 256) may be quoted. Into both structures a quicksilver injection flows readily, and renders the arrangement of their parts perfectly distinct even to the naked eye. The gland of Harder of the pelican (fig. 255) is seen as a considerable lobulated body, each lobe being subdivided into smaller rounded or elongated or angular lobules, which again present themselves as small hollow pannicles or berries,

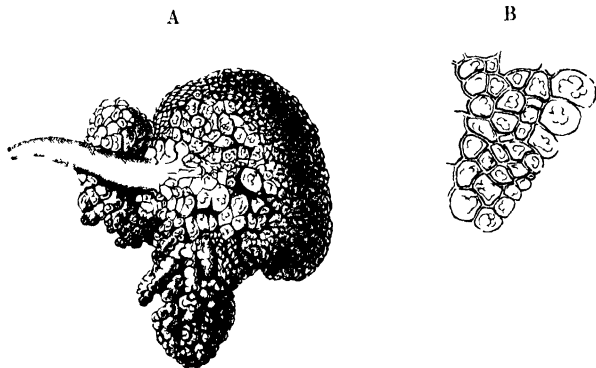

Fig. 255.—A, a Harderian gland of the *Pelecanus onocrotalus*, with the excretory duct of the natural size injected with mercury. B, a portion of the same slightly magnified. Some vascular ramifications are still apparent between the lobules.

attached to the enlarged excretory duct, these, in their turn, having still smaller, rounded blind cells (fig. 255, B) surrounded by vascular net-works attached to them, an arrangement by which the whole structure acquires a cauliflower appearance. The Cowper's glands of the hedgehog, on the other hand (fig. 256, A), afford an example of that form in which the ramified excretory duct divides into elongated, pretty even, and slender cœca, which subdivide at their ends into finger-shaped processes (fig. 256, B), partly straight, partly sinuous, which are then applied to one another in the form of flat lobules, these, in their turn, being connected by cellular tissue into larger lobes.

[§ 421. In man and the higher vertebrata, glands of the simple follicular form (as they exist in the Lieberkühnian glands of the intestines, for example) attain to the highest degree of complexity—in the liver, for instance. The compound glands may be arranged according to their structure into four groups. 1. *Compound follicles*, the short excretory canal passing without farther ramification at once into pediculated vesicles or racemiform lobules; or the outwardly simple sac exhibiting internally open cellular projections or shallow pits; to this head belong the larger mucous and cutaneous glands. 2. *Glands with tree-like ramifications of their excretory duct*, and enlargements of the terminal branches into racemiform or cauliflower-like aggregated vesicles, which are visible with the naked eye, and vary in magnitude from the 25th of a line to one line. To this group belong the lachrymal glands, the salivary glands, and

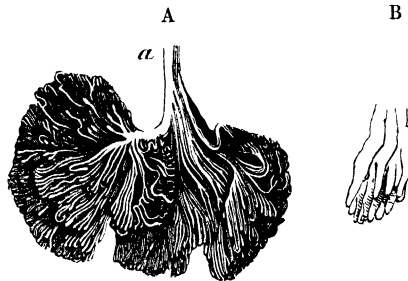

Fig. 256 —A, the Cowper's gland of the hedgehog, with the excretory duct, *a*. The cœca composing the gland are filled in the most beautiful manner with the mercury; the object is not magnified. B, a few of the blind sacs seen slightly magnified.

the pancreas. The lung of the mammal, with its terminal vesicles attached to the minute ramifications of the bronchi, may serve as a prototype of this form of gland, which is made up of repetitions of the same fundamental structure, as we have seen in the preceding paragraph to be the case with regard to the Harderian gland. 3. *Glands with a tubular structure*; the secreting canals are here extremely slender, of great length, convoluted, blind at the ends, not ramified, or only once or twice divided, not sensibly or but very slightly enlarged at the extremities, sometimes anastomosing by recurrent loops, or connected by cross branches, and from the tenth of a line to half a line in thickness; to this category belong the kidneys and the testicles especially. The Cowper's gland of the hedge-hog (fig. 256) may serve as a prototype of the form of which that of the organs just mentioned may be viewed as an extension. 4. *Acinous glands*. The excretory duct here ramified through the substance of the gland, divides at length into extremely minute branches; all the branches and twigs are beset with compact lobules, consisting of very small, firm, angular cells, which effect the secretion. To this division belongs the liver of vertebrate animals generally.

[§ 422. Compound follicles or glands of the first description, are progressive or more complex forms of the rounded or elongated inversion, which we have seen constituting the simple follicle of the mucous membrane and of the skin (§ 419); no precise line of demarcation can, in fact, be drawn between them and the simple follicle, or the sudoriparous or ceruminous gland. The large glands of the stomach and intestines may serve as types of this kind of gland (fig. 182), or the numerous glands which are in connection with the skin. All these glands consist of ramifications of the excretory ducts, which swell out into single saccules, that do not combine into true racemes or lobes. The glands which are connected with the hairs (fig. 248 c, a, a, and 251, aa) are small follicles, with rough external surfaces, and internally presenting the appearance of projecting parietal cells. To this division also belong the associated unbranched saccules arranged along the excretory duct like the grains of an ear of barley, which compose the Meibomian glands.* Among animals a multitude of variously formed

* Figured by Müller—*De Gland. structura*, Tab. v. figs. 1 and 2.

glands of the skin, other than the sudoriparous and sebaceous glands are encountered.*

[§ 423. The progressive development of the last form of gland is observed in the lachrymal, salivary and lacteal glands,† in all of which a greater amount of ramification, an increase in the quantity of vesicles and racemes produced, and a greater degree of separation of the individual parts into lobes, are observed. The lachrymal gland of man, of mammals and of birds, exhibits terminal cells, which in the latter class are large and conspicuous; in man, on the contrary, they are much smaller. The salivary glands of man are formed in the same way (fig. 257). The cells of the terminal vesicles of the parotid may still be readily filled with mercury in young subjects; they are two or three times smaller than the finest pulmonary cells, measuring no more than from the 30th to the 60th of a line in diameter. The structure of the pancreas is similar, and the terminal vesicles of this gland are very easily filled with mercury or with air, in birds especially, measuring when thus distended from a 50th to a 30th of a line in diameter!‡ The mammary glands in the ornithorhynchus are extremely simple, and exhibit the commencement of a series of evolutions that end with the most complicated raceme; the structure here consists of a con-



Fig. 257 —A very small piece of the parotid gland of a new-born infant, filled with mercury and magnified five diameters. After Weber.

* To this number belong, for example, the musk bag, and the anal sacs of many animals—the marten, the otter, &c., which exhale a peculiar odour or stench. They are, in fact, extensive involutions of the skin, of simple structure, occupied internally by shallow pits; these structures might be regarded as simple follicles, which, upon occasion, however, may become more complicated, as they do in the anal sac of the hyæna, for example, which is made up of several racemes clustered together.

† On the structure of the glands in general, and of each of those mentioned in particular, see the work of Muller, and the *Elementary Treatises on Anatomy* of E. H. Weber and of Krause.

‡ The pancreas of fishes has been very commonly quoted as affording an example or type of the successive evolution of glands from the simplest

geries of very large unramified cœca; * but in the higher mammalia and in man the wide excretory ducts pass over into finer branched canals, upon which the terminal cells form botryoidal clusters; the cells are on an average from 1-20th to 1-15th of a line in diameter.

[§ 424. Among the glands having tubular vessel-like secret-

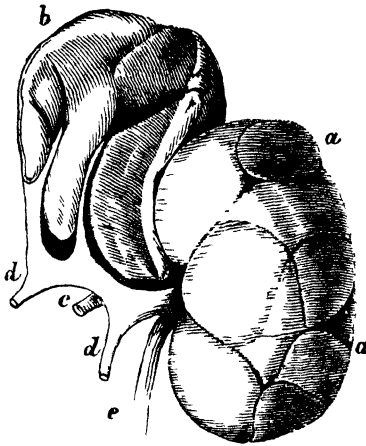

Fig. 258 —Kidney and supra-renal gland of the new-born child, of the natural size. *a*, kidney; *b*, supra-renal gland; *c*, artery; *d*, veins; *e*, ureter.

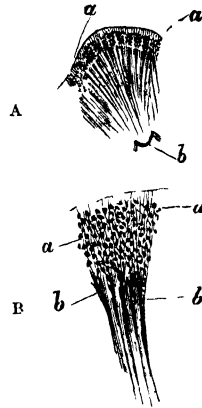

Fig. 259. —A, B, portions of the kidney represented in fig. 258 injected. A, of the natural size; the Malpighian bodies, *a, a*, appearing as points in the cortical substance; *b*, the papilla of one of the tubular pyramids. B, a small portion of A, seen under a simple lens and slightly magnified; *a*, Malpighian bodies; *b*, tubuli uriniferi.

cœcal tubes to the most complex form observed in the glandular system. Recent inquiries, however, rather lead us to conclude that the bony fishes in general have a pancreas, which is comparable in all respects to that of the other vertebrate animals; perhaps the cœcal appendages which were so long mistaken for the pancreas have a totally different function.

* See Meckel: *Ornithorhynchi paradoxu descript. Anatom.* Tab. viii. and Owen on the Mammary Gland of the Ornithorhynchus, in *Philos. Trans.*

ing canals, the KIDNEYS deserve particular notice. The development

Fig. 260.—A still smaller piece of the same kidney magnified about sixty diameters, and drawn in part as a plan, so that the relations of the tubuli to one another and to the vascular glomeruli may be distinctly seen and understood. *a*, a simple terminal tubulus uriniferus; *b, b*, tubuli, forming loops and returning; *c, c*, tubuli terminating in bifurcated points; *d, e, f*, points where the tubuli join, continuing their course towards the papilla; *g, g, g*, arterial glomerules or convolutions, connected with one another by a general vascular rete; *h*, a larger arterial trunk, which feeds this rete and the connected glomeruli (the Malpighian bodies).

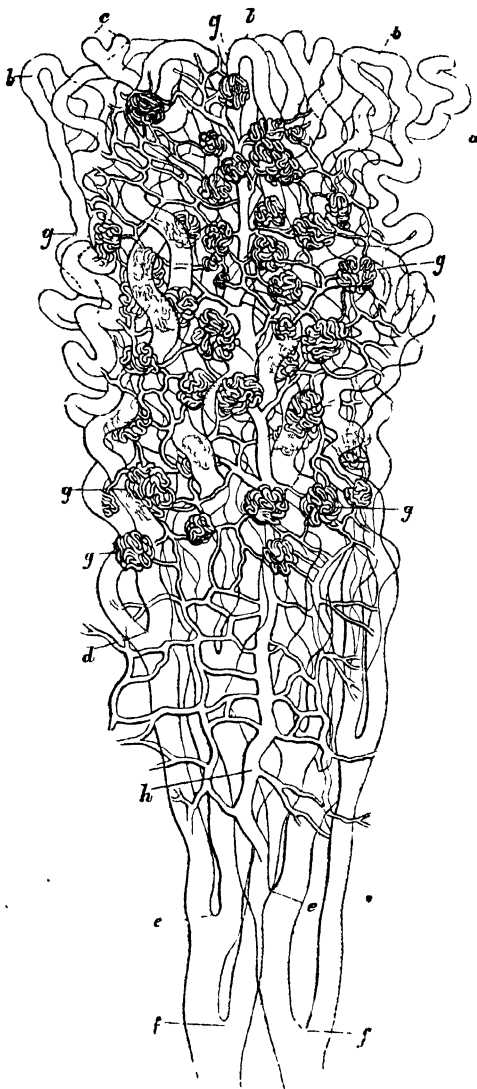

of the kidneys in the vertebrate series is of especial interest. In fishes and amphibia the entire tissue of the kidney consists of tortuous canals, which

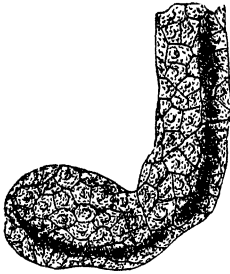

Fig. 261.—Termination of one of the tubuli uriniferi from the kidney of an adult, examined soon after death. The cellular structure is conspicuous. Magnified 250 times.

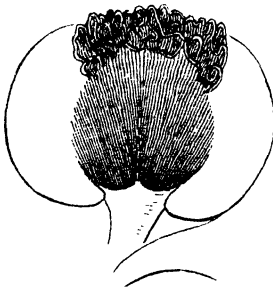

Fig. 262.—A lobe of the kidney of the adult porpoise (*Delphinus phocaena*). After Müller.

end partly in blind extremities, and partly pass into one another in loops, but which, from their great length and intimate connection, cannot be demonstrated singly. They are not divided into single pyramids or lobules, a peculiarity that first makes its appearance among birds. Here the highly tortuous uriniferous tubules are furnished with lateral branches, which come off like the tines of a stag's horn; in all probability they pass over the one into the other by means of loops. In the mammalia the tubuli uriniferi form many pyramids or lobes, each a system by itself (figs. 258 and 259, A). In the cortical substance of the human kidney the tubuli can be traced, although with difficulty, winding among the vascular plexuses or skeins, mostly looped towards the margin of the organ, and running into one another (fig. 260, *b, b*), or ending blindly (*a*), more rarely slightly enlarged and club-shaped (fig. 261), occasionally also cleft (fig. 260, *c*). The entire cortical substance consists of convolutions of the uriniferous tubules, which are found to present a very nearly uniform diameter, and which, on an average, may be from about the 50th to the 60th of a line. They unite two and two as they approach the tubular or medullary structure, becoming at the same time somewhat

thicker, and then they run quite parallel to one another to their termination (fig. 262).

[§ 425. Among the whole of the vertebrata, the parts which are the efficient agents of secretion in the liver are so intimately connected into a compact and little lobular organ, by means of the vessels and cellular substance, that it is extremely difficult to form a proper notion of its structure. Perhaps the following is the true account of the structure of the liver, when fully formed in man and the mammalia: It is easy to obtain conviction of the fact, that the ends of the secreting parts of the liver are leaf-like lobules with blunt projections, which, in preparations of the organ, are most apt to remain attached to the minute venous twigs (fig. 263, A, a, and 264, a, b, b). These lobules are composed of compact angular and rounded cells (fig. 263, B).



Fig. 263.—A, four lobules from the liver of a human subject forty years of age, magnified twice; a branch of the hepatic vein, *a*, receives a more minutely ramified twig from each lobule. B, some of the cells of which the lobules of the liver are composed, seen under a magnifying power of 200; in the greater number the clear nucleus is apparent.

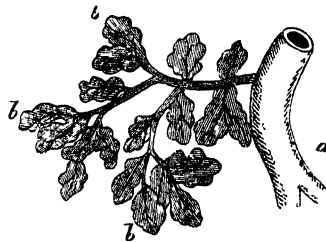

Fig. 264.—*a*, a branch of vein with the tributary twigs of which the lobules of the liver are connected, as leaves are with the final branches of a tree. The venous ramuscles (*venae intralobulares*) lie in the middle of each lobule, as is seen in the two next succeeding figures which represent transverse sections of the hepatic lobules magnified. After Kiernan.

Some observers describe the final ends of the secreting element of the liver of mammals as hollow acini or vesicles

with thin parietes, from the 40th to the 50th of a line in diameter, and capable of being distended by air, introduced into the gall-ducts with which they are connected.

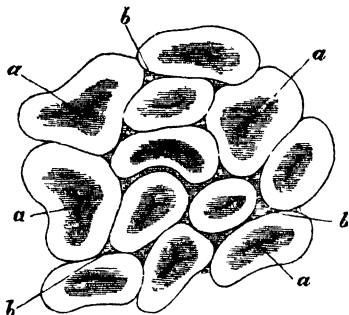

Fig. 265.—Lobules of the liver, superficially situated, divided horizontally; *a, a*, intralobular veins; *b, b*, clefts between the several lobules, in which cellular tissue, minute subdivisions of the hepatic ducts of the vena portæ and hepatic artery, are included; the middle portion of each lobule is here in a state of congestion. After Kiernan.

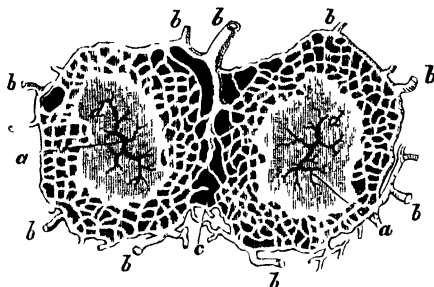
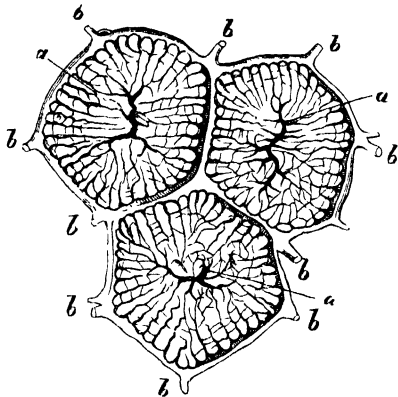

Fig. 266.—The intralobular plexus of biliary vessels, as figured by Kiernan—although the injection of these vessels was not so complete as it is here represented; *d, d*, two lobules divided across, with the ramifications of the hepatic vein, *a, a*, the twigs of which perforate their centres; *b, b, b, b*, branches of the hepatic duct, as they take their rise from the plexus of biliary vessels, which are here injected, and surround the uninjected portions of the substance of the lobules, *d, d, c*, cellular substance between the lobules.

For this structure we have the assurance of analogy, from what we witness in the constitution of the other glands, the mode of evolution of the liver itself, and the structure of the organ in the invertebrate series of animals; in fact, if we turn to the cray-fish and common garden snail, we find the precise structure in question. In the cray-fish the liver consists entirely of small pointed cæca, clustered like grapes; in the snail it is made up of blind, rounded, terminal vesicles, which may be blown up with

air from the biliary ducts. If we farther examine the liver of the larva of the water-newt (fig. 268, B) we see distinct clusters of cæcal canals, or round [terminal cells, like islets, surrounded by subdivisions of the hepatic vein; but these cæcal canals, at all events, are not thin-walled cells; they are almost as compact as the acini of the fully formed liver of the highest mammal.



ELEMENTARY PARTS OF GLANDS.

[§ 426. The proper substance of glands is not formed by or out of the ordinary cellular substance, but by and from other more or less distinctly cellular elements. This anatomical truth is particularly evident in the liver (fig. 263, A). Here the parietes of the acini consist entirely of compact, irregularly rounded or angular cells, of about 1-200th of a line in magnitude. The cells of the liver enclose a distinct clear nucleus and a yellowish-coloured molecular matter in their interior. The cells are like the stones of a piece of ancient masonry, irregularly applied to one another. Externally, where the blood-vessels play around them, fibres of cellular tissue are added. An epithelial covering of flat tessellated cells first makes its appearance in the larger branches and trunks of the gall-ducts. In other cases, as in the glands of the stomach, for instance (§ 329), the substance of the

Fig. 267.—View of three lobules of the liver cut across, the centre of each occupied by the ramifications of the intralobular (the hepatic) vein, *a, a, a*. *b, b, b*, Branches of the vena portæ which course in the spaces between the lobules, surrounding these and constituting the intralobular veins. Numerous ramuscles penetrate into the interior of the lobules and anastomose with the intralobular or hepatic veins. The rounded and oval interspaces or islets between these vessels are filled or possessed by the biliary vessels (fig. 266), and form the acini of Malpighi. After Kiernan.

glandular parietes consists of rounded dark granules, not obviously formed like cells, which appear to be arranged or

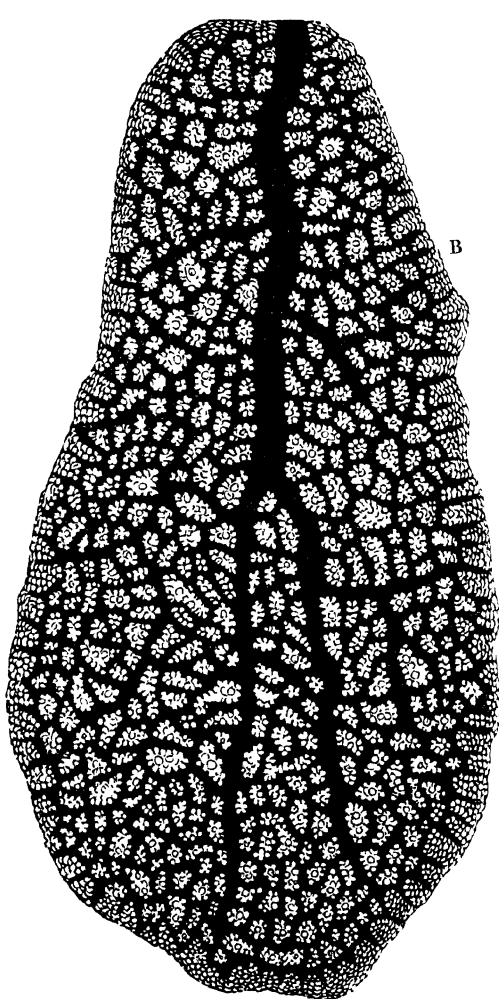

Fig. 268.—A, a larva of the water-newt of the natural size; *c*, liver; *b*, stomach; *c*, gall-bladder.

B, the liver of this larva magnified 40 times. The dark coloured streamlets of blood are seen surrounding the hepatic lobules, which consist of aggregated racemi-form cœca. The vascular channels represented are those of the hepatic vein.

packed between a very delicate external envelope turned towards the blood-vessels, and an internal epithelial investment. The cellular structure of the parietes of the ventricular glands is, however, very apparent in young birds (fig. 186, B). In other glands, moreover, we recognize the cellular structure with different degrees of distinctness—in the tubuli uriniferi, for example, where the cells have nuclei, but are far from being so compact, and are not nearly so readily isolated as in the liver (fig. 261). It is difficult to say in how far this cellular structure, which may be followed to the very ends of the canaliculi, belongs to the innermost layer of the glandular paries, or is connected with the epithelial investment, appertaining to the trunk and larger branches of the excretory duct of every gland. Apparently, however, there are always several layers of flattened cells placed one upon another, over which a structureless membrane is drawn externally, and this is the part that is surrounded immediately by the vascular reticulation. Certain it is, that wherever we find secreting follicles, they consist of a number of more or less distinctly cellular or fibrous layers, which lie as the proper substance of the gland betwixt the external net-work of blood-vessels and the inner wall whence the secreted matter distils away.

ORIGIN OF THE GLANDS.

[§ 427. The greater number of the secreting glands arise from



Fig. 269.—Rudiments of the liver formed by evolution from the tractus intestinalis in the embryo of the fowl of the fourth day. After Muller—*De Gland*, &c.

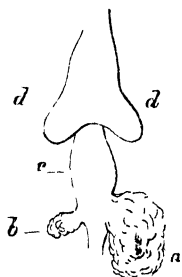

Fig. 270.—Liver and pancreas of an embryo of the fowl at the end of the fourth day, magnified twelve times linear. *a*, the liver; *b*, the pancreas; *c*, the stomach; *d, d*, the lungs.

the mucous lamina of the germinal membrane, and, like the salivary glands, the lungs, the liver, the pancreas, are to be regarded as evolutions of this membrane, or of the intestinal canal.

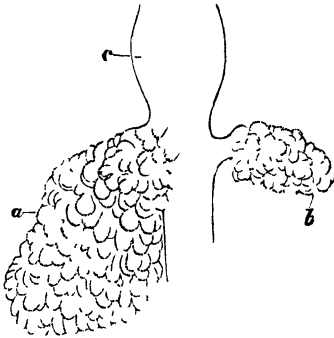

Fig. 271.—The same parts in another embryo more highly magnified, to exhibit the undoubtedly cellular and racemose structure of the liver and pancreas. The references are likewise the same.

This projection appears upon the intestine. This projection consists of a delicate, finely granular, and pale tissue—the *blastema*, as it is called, which was in former times looked upon as without structure. By watching this part we see how particular divisions make their appearance within it (fig. 272), which by and by form lobules or club-shaped bodies, and are the elements or groundwork of the future cæcal canals, where these are to appear. It is now that a kind of solution of the internal contents of the mass or masses takes place, or rather that distinct walls with double



Fig. 272.—The liver more advanced than in the last figure from an embryo of the fowl of the sixth day. It is not only divided into two lobes, but shows minute cæca in its interior. After Muller.

contours are produced. This is to be seen most beautifully displayed in the lungs (fig. 273).*

* The lungs are to be viewed as the prototype of all secreting glands.

true glandular skeleton, as it has been described in speaking of the conformation of the glands. Would we follow this generation of the glands step by step, a gland must be chosen in which the ramifications of the excretory duct can be seen amidst the clearer blastema, from the simple rudiment to the term of extreme complexity. In young embryos of the sheep (fig. 274) we can, by the aid of a simple lens, see the excretory duct of the parotid still simply branched, the several branches enlarged like buds at their extremities, and but seldom divided. The same thing may be seen in small human embryos (fig. 276). To follow the onward evolution, embryos successively more and more advanced must be procured, and, the parotid being removed, it is to be examined with a low power and as an opaque object (fig. 277). The clearer blastema of the gland now appears dark, and the excretory duct,

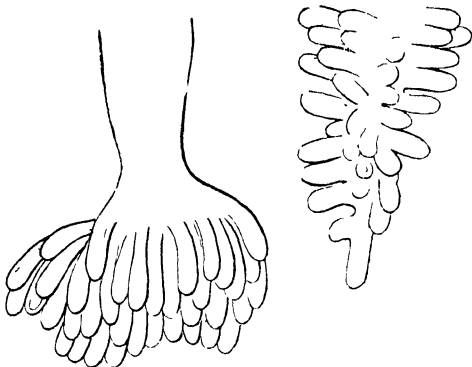

Fig. 273.—Ramifications of the bronchi from the embryonic *Falco tinunculus*, to show the way in which they sprout as blind canals. Both figures are magnified about 150 times.

we can, by the aid of a simple lens, see the excretory duct of the parotid still simply branched, the several branches enlarged like buds at their extremities, and but seldom divided. The same thing may be seen in small human embryos (fig. 276). To follow the onward evolution, embryos successively more and more advanced must be procured, and, the parotid being removed, it is to be examined with a low power and as an opaque object (fig. 277). The clearer blastema of the gland now appears dark, and the excretory duct,

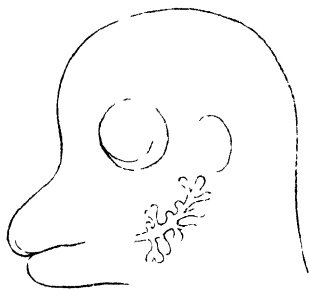

Fig. 274.—Rudiments of the parotid gland in the embryo of a sheep, two inches in length magnified. After Müller.

which consists of a firmer granular mass, appears white, and in



Fig. 276.—First appearance of the parotid gland in a human embryo of the seventh week ; magnified twice.

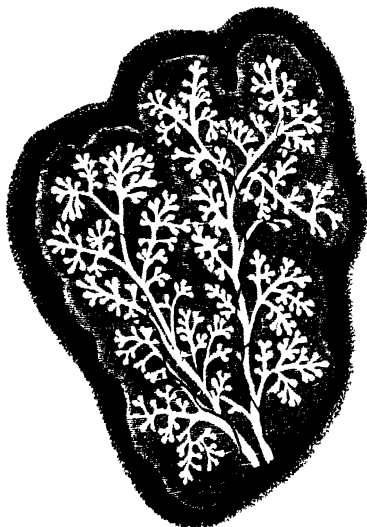

Fig. 277.—Lobules of the parotid gland with the excretory ducts from the embryo of a sheep four inches long, magnified eight times. After Müller

the form of an elegant and numerous branched tree. The leaf-like ends now undergo transformation into blind vesicles, whilst the branches and twigs of the tree become hollow, and unite themselves to the excretory duct (fig. 277). The blood-vessels are seen entering the blastema in the shape of dark ramifications (fig. 277), but of much smaller diameters than those of the ramified glandular canal. The finest elements of the secreting follicles do not consist properly of cells ; in the liver, for example (fig. 278), they are extremely soft, roundish, granular corpuscles, which give to the larger lobules (A) a racemiform appearance. It is betwixt these major divisions or lobules that the blood-vessels make their entrance (fig. 278, B, *a, a*), none ever penetrating betwixt the finest elements of all.

DISTRIBUTION OF THE VESSELS IN GLANDS.

[§ 428. Glands in general derive their blood from arteries, and all that is not used for purposes of secretion returns in the usual way through veins and lymphatics into the general current of the circulation. The lymphatics of glands are often very large and conspicuous; those of the liver are particularly so. Among vertebrate animals the liver receives but a small portion of its blood from an arterial source, and this appears to be exclusively expended upon the gall-bladder, the gall-ducts, and the coats of the larger vascular trunks, though branches of the hepatic artery can also be followed, entering along with the cellular substance of the organ between its several component lobules. The blood from which the bile is prepared is received from the portal vein, which ramifies through the substance of the liver, and at length anastomoses with the finest subdivisions of the hepatic vein, which spring from the deeper parts, and then flow round about the clusters of hepatic cells united into cœcal-looking lobules (fig. 267) In the two lower classes of vertebrate animals, there is an extension to the kidneys of the same system of circulation which we observe confined to the liver among the two higher classes. In amphibia and fishes a portion of the blood returning from the hind-legs, tail, abdominal parietes, and

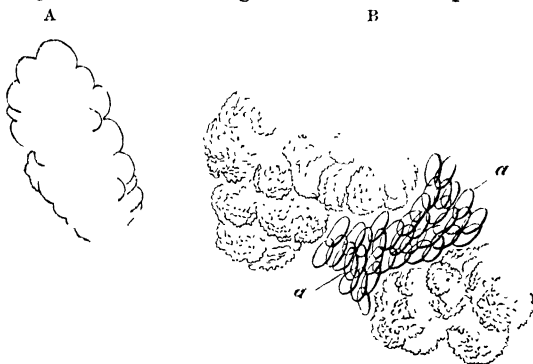

Fig. 278.—A couple of feathery lobules from the embryo of the *Falco tinnunculus* or Hobby, fourteen lines in length; the substance of the liver is seen composed of large pale granulated particles (cells); betwixt the lobules a blood-vessel is seen well filled with blood-discs.

even some of the viscera, is distributed to the kidneys. But whether the material for the secretion of the urine is afforded from this source or not is doubtful; for the kidneys here still receive arteries of considerable magnitude, the finer twigs of which form such tangled knots as we observe in the same organs of birds and mammals. These tangled knots of vessels, Malpighian bodies as they are called, constitute a form of



Fig. 279.—Malpighian bodies of the kidney of the water-newt (*Triton palustris*), after Huschke, in *Tied. n. Trevir. Zeitschrift*, B. 4, Tab. vi.

more thinly scattered in the medullary substance. The vessels

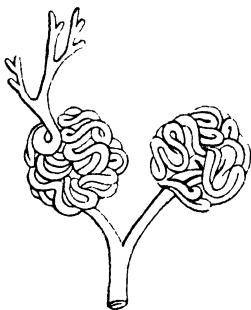

Fig. 280.—Malpighian bodies from the kidney of an owl (*Strix aluco*), fully injected and largely magnified.

of the most minute vascular net-works are everywhere much smaller—from twenty to thirty times smaller—than the finest cœcal and secreting glandular tubules, and never terminate in these, as they were once universally, and as they have even very recently, been supposed to do. They rather play round the individual terminal portions of the glandular skeleton, they never even penetrate between the constituent cellular elements of this. The parietes of the blood-vessels

* This admirable article on the structure of glands is from Professor Wagner's *Physiology*, pp. 384, et seq.

CHAPTER TENTH.

EMBRYOLOGY.

SECTION I.

OF THE EGG.

§ 429. THE functions of vegetative life, of which we have treated in the preceding chapters, namely, digestion, circulation, respiration and secretion, have for their end the preservation of the individual. We have now to treat of the functions that serve for the perpetuation of the species, namely those of reproduction (§ 308).

§ 430. It is a law of nature that animals as well as plants are the offspring of individuals of the same kind, and *vice versa*, that none of them can give birth to individuals differing from themselves ; but recent investigations have modified to a considerable extent this view, as we shall hereafter see.

§ 431. Reproduction in animals is almost universally accomplished by the association of individuals of two kinds, *males* and *females*, living commonly in pairs or flocks, and each of them characterized by peculiarities of structure and external appearance. As this distinction prevails throughout the animal kingdom, it is always necessary for obtaining a correct and complete idea of a species, to bear in mind the peculiarities of both sexes. Every one is familiar with the differences between the cock and the hen, the lion and the lioness. Less prominent peculiarities are observed in most vertebrata. Among the articulata, the differences are no less striking, the males being often of a different shape and colour, as in crabs ; or having even more complete organs, as in many tribes of insects, where the males have wings, while the females are deprived of them. Among the mollusca the females have often a wider shell.

§ 432. Even higher distinctions than specific ones are based upon peculiarities of sex ; for example, the whole class of mammalia is characterized by the fact that the female is furnished with organs for nourishing her young with a pecu-

liar liquid, the milk, secreted by herself. Again, the marsupialia, such as the opossum and kangaroos, are distinguished by the circumstance that the female has a pouch, into which the young are received in their immature condition at birth.

§ 433. That all animals are produced from eggs (*Omne vivum ex ovo*), is an old adage in zoology, which modern researches have fully confirmed. In tracing back the phases of animal life, we invariably arrive at an epoch when the incipient animal is enclosed within an egg. It is then called an *embryo*, and the period passed in this condition is called the *embryonic period*.

§ 434. Before the various classes of the animal kingdom had been attentively compared during the embryonic period, all animals were divided into two great divisions: the *oviparous*, comprising those which lay eggs, such as birds, reptiles, fishes, insects, mollusks, &c., and the *viviparous*, which bring forth their young alive, like the mammalia, and a few from other orders, as the sharks, vipers, &c. This distinction lost much of its importance when it was shown that viviparous animals are produced from eggs, as well as the oviparous; only that their eggs, instead of being laid before the development of the embryo begins, undergo their early changes in the body of the mother. Production from eggs should therefore be considered as a universal characteristic of the animal kingdom.

§ 435. FORM OF THE EGG.—The general form of the egg is more or less spherical. The eggs of birds have the form of an elongated spheroid, narrow at one end; and this form is so constant, that the term *oval* has been

Fig. 281.



Fig. 282.



Fig. 283.



constant, that the term *oval* has been universally adopted to designate it. But this is by no means the usual form of the eggs of other animals. In most instances, on the contrary, they are spherical, especially among the lower animals. Some have singular appendages, as those of the skates and sharks (fig. 281), which are shaped like a hand-barrow, with four hooked horns at the corners. The eggs of the *Hydra*, or fresh water polype, are thickly covered with prickles (fig. 282). Those of certain insects, for

vered with prickles (fig. 282). Those of certain insects, for

example, the *Podurella*, are furnished with filaments which give them a hairy aspect (fig. 283); others are cylindrical, or prismatic, and frequently the surface is sculptured.

§ 436. FORMATION OF THE EGG.—The egg originates within peculiar organs, called *ovaries*, which are glandular bodies usually situated in the abdominal cavity. So long as the eggs remain in the ovary, they are very minute in size. In this condition they are called *ovarian* or *primitive eggs*.

They are identical in all animals, being, in fact, merely little cells containing yolk-substance (*b*), including other similar cells, namely, the germinative vesicle (*d*) and the germinative dot (*e*). The yolk itself with its membrane is formed while the

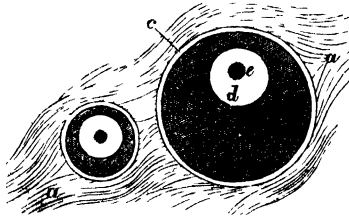

Fig. 284.—Primary ova of the bird, magnified; scarcely to be seen by the naked eye; *a*, stroma, or substance of the ovary, composed of thick fibres; *c*, chorion, or theca of the ovum, so thick as to be seen in the guise of a ring; *b*, yolk; *d*, germinative vesicle; *e*, germinal spot. The structure of the smaller ovum is the same.

egg remains in the ovary; it is afterwards enclosed in another envelope, the shell membrane, which may remain soft or be further surrounded by calcareous deposits, the shell proper (fig. 287). The number of these eggs is large in proportion as the animal stands lower in the class to which it belongs. The ovary of a herring contains more than 25,000 eggs; while that of birds contains a much smaller number, perhaps one or two hundred only.

§ 437. *Ovulation*.—Having attained a certain degree of maturity, which varies in different classes, the eggs leave the ovary. This is called *ovulation*. It must not be confounded with the laying of the eggs, which is the subsequent expulsion of them from the abdominal cavity, either immediately, or through a special canal, the *oviduct*. *Ovulation* takes place at certain seasons of the year, and never before the animal has reached a particular age, which is commonly that of its full growth. In a majority of species, *ovulation* is repeated for a number of years consecutively, generally in the spring, in

terrestrial animals, and frequently several times a-year; most of the lower aquatic animals, however, lay their eggs in the fall, or during winter. In others, on the contrary, it occurs but once during life, at the period of maturity, and the animal soon afterwards dies. Thus the butterfly and most insects die shortly after having laid their eggs.

§ 438. The period of ovulation is one of no less interest to the zoologist than to the physiologist, since the peculiar characteristics of each species are then most clearly marked. Ovulation is to animals what flowering is to plants; and, indeed, few phenomena are more interesting to the student of nature than those exhibited by animals at the pairing season. Then their physiognomy is the most animated, their song the most melodious, and their attire the most brilliant. Some birds appear so different at this time, that zoologists are always careful to indicate whether or not a bird is represented at the breeding season. Fishes and many other animals are ornamented with much brighter colours at this period.

§ 439. *Laying*.—After leaving the ovary, the eggs are either discharged from the animal, that is, *laid*; or they continue their development within the parent animal, as is the case in some fishes and reptiles, as sharks and vipers, which for that reason have been named *ovo-viviparous* animals. The eggs of the mammalia are not only developed within the mother, but become intimately united to her; this peculiar mode of development has received the name of *gestation*.

Fig. 285. Fig 286.

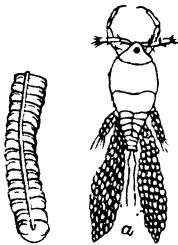

§ 440. Eggs are sometimes laid one by one, as in birds; sometimes collec-

tively and in great numbers, as in frogs, fishes, and most of the invertebrata. The queen ant of the African termites lays 80,000 eggs in twenty-four hours; and the common hair worm (*Gordius*) as many as 8,000,000 in less than one day. In some instances they are united in clusters by a gelatinous envelope; or are enclosed in cases or between membranous discs, forming long strings, as in the eggs of the *Pyruia* shell (fig. 285). The conditions under which the eggs of different animals are placed, on being laid, are very different. The eggs of birds, and of some insects, are deposited

in nests constructed for that purpose by the parent. Other animals carry their eggs attached to their bodies; sometimes under the tail, as in the lobsters and crabs, sometimes hanging in large bundles on both sides of the tail, as in the *Monoculus* (fig. 286, a).

§ 440*. Some toads carry them on the back, and, what is most extraordinary, it is the male which undertakes this office. Many mollusca, the *Unio* for example, have them enclosed between the folds of the gills during incubation. In the medusæ and polyps, they hang in clusters either outside or inside, at the bottom of the cavity of the body. Some insects, such as the gad-flies, deposit their eggs on other animals. Finally, many abandon their eggs to the elements, taking no further care of them after they have been laid; such is the case with most fishes, some insects, and many mollusca. As a general rule, it may be said that animals take the more care of their eggs and brood, as they occupy a higher rank in their respective classes.

§ 441. The development of the embryo does not always take place immediately after the egg is laid. A considerable time even may elapse before it commences. Thus, the first eggs laid by the hen do not begin to develop until the whole number which is to constitute the brood is deposited. The eggs of most butterflies, and of insects in general, are laid in autumn, in temperate climates, and remain unchanged until the following spring. During this time the principle of life in the egg is not extinct, but is simply inactive, or in a latent state. This tenacity of life is displayed in a still more striking manner in plants. Their seeds, which are equivalent to eggs, preserve for years, and even for ages, the power of germinating. Thus, there are some well-authenticated cases in which wheat taken from the ancient catacombs of Egypt has sprouted and grown.

§ 442. A certain degree of warmth is requisite for the hatching of eggs. Those of birds, especially, require to be submitted for a certain length of time to a uniform temperature, corresponding to the natural heat of the future chicken; and which is naturally supplied by the body of the parent. In other words, *incubation* is necessary for their growth. Incubation, however, is not a purely vital phenomenon, but may be readily imitated by artificial means. Some birds of warm

climates dispense with this task ; the ostrich, for example, often contents herself with depositing her eggs in the sand of the desert, leaving them to be hatched by the sun. In like manner, the eggs of most birds may be hatched, by maintaining them at the proper temperature, by artificial means. Some fishes are also known to build nests, and to sit upon their eggs, as the stickle-backs, sun-fishes, and cat-fishes ; but whether they impart heat to them or not is doubtful. Before entering into the details of embryonic transformations, a few words are necessary respecting the composition of the egg.

§ 443. *Composition of the Egg.*—The egg is composed of several substances, varying in structure, as well as in appearance. Thus, in a new-laid hen's egg (fig. 287), we have first a calcareous *shell* lined by a double membrane, the shell membrane (*c*) ; then an albuminous substance, the *white* ; in which several layers may be distinguished (*e, f*) ; within this, we find the *yolk* enclosed in its membrane (*h*) ; and before it was laid, there was in the midst of the latter a minute vesicle, the *germinative vesicle* (fig. 284, *d*), containing a still smaller one, the *germinative dot* (*e*). These different parts are not equally important in a physiological point of view. The most conspicuous of them, namely, the shell and the white, are not essential parts, and therefore are often wanting ; while the yolk, the germinative vesicle, and the germinative dot are found in the eggs of all animals ; and out of these, and of these only, the germ is formed, in the position shown in figs. 284—287.

§ 444. The *vitellus*, or *yolk* (fig. 287, *h*), is the most essential part of the egg. It is a liquid of variable consistence, sometimes opaque, as in the egg of birds, sometimes transparent and colourless, as in the eggs of some fishes and mollusca. On examination under the microscope, it appears to be composed of an accumulation of granules and oil drops. The yolk is surrounded by a very thin skin, the *vitelline membrane* (fig. 284, *c*). In some insects, when the albumen is wanting, this membrane, surrounded by a layer of peculiar cells, forms the exterior covering of the egg ; which in such cases is generally of a firm consistence, and sometimes even horny.

§ 445. The *germinative vesicle* (fig. 284, *d*) is a cell of extreme delicacy, situated, in the young egg, near the middle of the yolk, and easily recognized by the greater transparency of its contents when the yolk is in some degree opaque, as in

the hen's egg, or by its outline, when the yolk itself is transparent, as in the eggs of fishes and mollusca. It contains one or more little spots, somewhat opaque, appearing as small dots, the *germinal dots* (*e*). On closer examination, these dots are themselves found to contain still smaller nucleoli.

§ 446. The *albumen*, or white of the egg (fig. 287, *e, e*), is a viscous substance, generally colourless, but becoming opaque white on coagulation. Voluminous as it is in bird's eggs, it nevertheless plays but a secondary part in the history of their development. It is not formed in the ovary, like the yolk, but is secreted by the oviduct, and deposited around the yolk during the passage of the egg through that canal. On this account the eggs of those animals in which the oviduct is wanting, are generally destitute of albumen. In birds the albumen consists of several layers, one of which, the *chalcidæ* (*g, g*), is twisted.

Like the yolk, the albumen is surrounded by a membrane, the *shell membrane* (*c*), which is either single or double; and in birds, as also in some reptiles and mollusca, is again protected by a calcareous covering, forming a

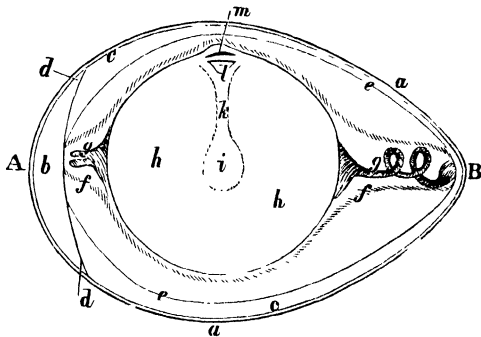

Fig. 287.—Ideal section of an extruded hen's egg, with slight alterations from Baër. (*Entwicklung. der Thiere*, B. I. Tab. III). A, blunt pole; B, sharp pole; *a, a*, shell; *b*, space filled with air; *c*, membrane of the shell, which, at *d, d*, splits into two layers; *e, e*, limits of the second and thicker albumen; *f, f*, limits of the third and thickest albumen clinging to the chalazæ; *g, g*, chalazæ; *h*, yolk; *i*, central cavity of the yolk, from which a canal or duct, *k*, leads to the cicatricula; *l*, cumulus proligerus; *m*, germ (blastos).

true shell (*d*). In most cases, however, this envelope continues membranous, particularly in the eggs of the mollusca, most crustaceans and fishes, salamanders, frogs, &c. Sometimes it is horny, as in the sharks and skates.

SECTION II.

DEVELOPMENT OF THE YOUNG WITHIN THE EGG.

§ 447. THE formation and development of the young animal within the egg is a most mysterious phenomenon. From a hen's egg, for example, surrounded by a shell, and composed, as we have seen (fig. 287), of the albumen and the yolk, with a minute vesicle in its interior, there is produced, at the end of a certain time, a living animal, composed apparently of elements entirely different from those of the egg. Endowed with organs perfectly adapted to the exercise of all the functions of animal and vegetative life, having a pulsating heart, a digestive apparatus ; organs of sense for the reception of outward impressions, and having, moreover, the faculty of performing voluntary motions, and of experiencing pleasure and pain. These phenomena are certainly sufficient to excite the curiosity of every intelligent person.

§ 448. By opening eggs which have been subjected to incubation during different periods of time, we may easily satisfy ourselves that these changes are effected gradually. We thus find that those which have undergone but a short incubation exhibit only faint indications of the future animal ; while those upon which the hen has been sitting for a longer period include an embryo chicken proportionally more developed. Modern researches have taught us that these gradual changes, although complicated, and at first sight so mysterious, follow laws which are uniformly the same in each department of the animal kingdom.

§ 449. The study of these changes constitutes that branch of Physiology called EMBRYOLOGY ; as there are differences in the four great departments of the animal kingdom perceptible at an early stage of embryonic life, quite as obvious as those found at maturity ; and, as the phases of embryonic development afford important indications for the natural classification of animals, we propose to give the outlines of Embryology, so far as it may have reference to zoology.

§ 450. In order to understand the successive steps of embryonic development, we must bear in mind that the whole animal body is formed of tissues, the elements of which are cells. These cells are more or less diversified and modified, or

even completely metamorphosed, in the full-grown animal ; but, at the commencement of embryonic life, the whole embryo is composed of minute cells of nearly the same form and consistence, originating within the yolk, and constantly undergoing new changes under the influence of life. New cells are successively formed, while others disappear, or are modified, and so transformed as to become blood, bones, muscles, nerves, &c.

§ 451. We may form some idea of this singular process, by noticing how, in the healing of a wound, a new substance is supplied by the transformation of the blood. Similar changes take place in the embryo, during its early life ; only, instead of being limited to one part of the body, they pervade the whole animal.

§ 452. The changes commence in most animals soon after the eggs are laid ; and are continued, without interruption, until the development of the young is completed ; in others, birds for example, they proceed only to a certain extent, and are then suspended until incubation takes place. The yolk, which at first consists of a mass of uniform appearance, gradually assumes a diversified aspect. Some portions become more opaque, and others more transparent ; the germinal vesicle, which was in the midst of the yolk, rises to the upper part of it, where the germ is to be formed. These early changes are accompanied, in some animals, by a rotation of the yolk within the egg, as may be distinctly seen in the eggs of some of the mollusca, especially the snails.

§ 453. At the same time the yolk undergoes a peculiar process of segmentation. It is first divided into halves, forming distinct spheres, which are again regularly subdivided into two more, and so on, till the whole yolk assumes the appearance of a mulberry, each of the spheres, of which it is composed, having in its interior a transparent vesicle. This is the case in mammalia, most mollusca, worms, &c. In many animals, however, as in the naked reptiles, and fishes,* this segmentation is only partial, the divisions of the yolk not extending across its whole mass.

§ 454. But whether complete or partial, this process leads

* In the birds and the higher reptiles, we find in the mature egg a peculiar organ called cicatricula, which may, nevertheless, have been formed by a similar process before it was laid.

to the formation of a *germ* comprising the whole yolk, or rising above it as a disc-shaped protuberance, composed of little cells, which has been variously designated under the names of germinative disc, proligerous disc, blastoderma, germinal membrane. In this case, however, that portion of the yolk which has undergone less obvious changes, forms nevertheless part of the growing germ. The disc again enlarges, until it embraces the whole, or nearly the whole, of the yolk.

§ 455. At this early epoch, namely, a few days, and, in

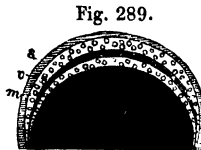

some animals, a few hours after development has begun, the germ proper consists of a single layer composed of very minute cells, all of them alike in appearance and form (fig. 288, *g*).

But soon after, as the germ increases in thickness, several layers may be discerned in vertebrate animals (fig. 289), which become more and more distinct.

§ 456. The upper layer (*s*), in which are subsequently formed the organs of animal life, namely, the nervous system, the muscles, the skeleton, &c. (§ 76), has received the name of *serous* or *nervous layer*. The lower layer (*m*), which gives origin to the organs of vegetative life, and especially to the intestines, is called the *mucous* or *vegetative layer*, and is generally composed of cells larger than those of the upper or serous layer. Finally, in the embryos of vertebrated animals, there is a third layer (*v*), interposed between the two others, giving rise to the formation of the blood and the organs of circulation; whence it has been called the *blood layer* or *vascular layer*.

§ 457. From the manner in which the germ is modified, we can generally distinguish, at a very early epoch, to what department of the animal kingdom an individual is to belong. Thus in the articulatæ, the germ is divided into segments, indicating the transverse divisions of the body, as, for example, in the embryo of the crabs (fig. 290).



The germ of the vertebrated animals, on the other hand, displays a longitudinal fur-

row, marking the position which the future back-bone is to occupy (fig. 291).

§ 458. The development of this furrow is highly important, as indicating the plan of structure of vertebrated animals in general, as will be shown by the following figures, which represent vertical sections of the embryo at different epochs.*

Fig. 292.

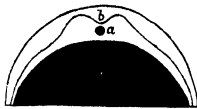

Fig. 293.



Fig. 294.



At first the furrow (fig. 292, *b*) is very shallow, and a little transparent narrow band appears under it, called the *primitive stripe* (*a*). The walls of the furrow consist of two raised edges, formed by a swelling of the germ along both sides of the primitive stripe. Gradually, these walls grow higher, and we perceive that their summits have a tendency to approach each other, as seen in fig. 293; at last they meet and unite completely, so that the furrow is now changed into a closed canal (fig. 294, *b*). This canal is soon filled with a peculiar liquid, from which the spinal cord and brain are formed at a later period.

§ 459. The primitive stripe is gradually obliterated by a peculiar organ of a cartilaginous nature, the *dorsal cord*, formed in the lower wall of the dorsal canal. This is found in the embryos of all vertebrata, and is the representative of the back-bone. In the mean time, the margin of the germ gradually extends farther and farther over the yolk, so as finally to enclose it entirely, and form another cavity, in which the organs of vegetative life are to be developed. Thus the embryo of the vertebrata has two cavities, namely, the upper one, which is very small, containing the nervous system, and the lower, which is much larger, for the intestines (§ 226).

§ 460. In all classes of the animal kingdom, the embryo proper rests upon the yolk, and covers it like a cap. But the direc-

* In these figures the egg is supposed to be cut down through the middle, so that only the cut edge of the embryo is seen; whereas, if viewed from above, it would extend over the yolk in every direction; and the furrow at *b*, of fig. 292, would be seen as in fig. 291.

tion by which its edges approach each other, and unite to form the cavity of the body, is very unlike in different animals; and these several modes are of high importance in classification. Among the vertebrata, the embryo lies with its face or ventral surface towards the yolk (fig. 295), and thus the suture, or line at which the edges of the germ unite to enclose the yolk, and which in the mammals forms the navel, is found in front. Another suture is found along the back, arising from the actual folding upwards of the upper surface of the germ, to form the dorsal cavity.

Fig. 295.



§ 461. The embryo in the articulata, on the contrary, lies with its back upon the yolk, as seen in the following figure, which represents an embryo of *Podurella*; consequently the yolk enters the body on that side; and the suture, which in the vertebrata is found on the belly, is here, as also in the worms, found on the back. In the cephalopoda the yolk communicates with the lower side of

Fig. 296.



the body as in the vertebrata, but there is no dorsal cavity formed in them. In the other mollusca there is this peculiarity, that the whole yolk is changed at the beginning into the substance of the embryo; whilst in the vertebrata and the higher articulata and mollusca, a part of it is reserved, till a later period, to be used for the nourishment of the embryo. Among the radiata the germ is formed around the yolk, and seems to surround the whole of it, from the first.*

§ 462. The development of the embryo of vertebrated animals may be best observed in the eggs of fishes. Being transparent, they do not require to be cut open, and by sufficient caution, the whole series of embryonic changes may be observed upon the same individual, and thus the succession in which the organs appear, may be ascertained with precision; whereas, if we employ the eggs of birds, which are opaque, we are obliged to sacrifice an egg for each observation.

§ 463. To illustrate these general views as to the develop-

* These facts show that the circumstance of embryos arising from the whole or a part of the yolk is of no systematic importance.

ment of the embryo, we shall briefly describe the principal phases, as they have been observed in the white-fish of Europe, which belongs to the salmon family. The following magnified sections will illustrate this development, and show the period at which the different organs successively appear.

§ 464. The egg when laid (fig. 297) is spherical, about the size of a small pea, and nearly transparent.

Fig. 297.



Fig. 298.

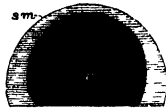
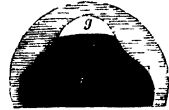

Fig. 299.



It has no albumen, and the shell-membrane is so closely attached to the membrane of the yolk, that they cannot be distinguished. Oil-like globules are scattered through the mass of the yolk, or grouped into a sort of disc, under which lies the germinative vesicle. The first change in such an egg occurs a few hours after it has been laid, when the shell-membrane separates from the yolk-membrane, in consequence of the absorption of a quantity of water (fig. 298), by which the egg increases the size. Between the shell-membrane (*s, m*) and the yolk (*y*) there is now a considerable transparent space, corresponding, in some respects, to the albumen found in the eggs of birds.

§ 465. Soon afterwards we see, in the midst of the oil-like globules, a swelling in the shape of a transparent vesicle (fig. 299, *g*), composed of very delicate cells. This is the first indication of the *germ*. The swelling rapidly enlarges until it envelops a large part of the yolk, when a depression is formed in it (fig. 300). This depression becomes by degrees

Fig. 300.



Fig. 301.



Fig. 302.



a deep furrow, and soon after a second furrow appears at right angles with the former, so that the germ now presents

four elevations (fig. 301). The subdivision goes on in this way during the second and third days, until the germ is divided into numerous little spheres, giving the surface the appearance of a mulberry (fig. 302). This appearance, however, does not long continue; at the end of the third day, the fissures again disappear, and leave no visible traces. After this, the germ continues to extend as an envelop around the yolk, which it at last entirely encloses.

§ 465*. On the tenth day, the first outlines of the embryo begin to appear, and we soon distinguish in it a depression between two little ridges, whose edges constantly approach each other until they unite and form a canal (fig. 303, *b*), as has been before shown (fig. 293). At the same time an enlargement at one end of the furrow is observed. This is the rudiment of the head (fig. 304), in which may soon be distinguished traces of the three divisions of the brain (fig. 305), corresponding to the senses of sight (*m*), hearing (*e*), and smell (*p*).

Fig. 303.

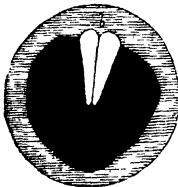

Fig. 304.

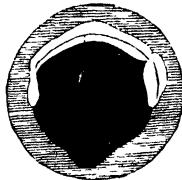
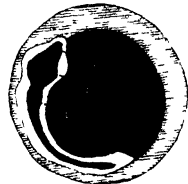

Fig. 305.



§ 466. Towards the thirteenth day we see a transparent, cartilaginous cord, in the place afterwards occupied by the back-bone, composed of large cells, in which transverse divisions are successively forming (figs. 306, 307, *c*). This is the dorsal cord, a part of which, as we have before seen, is common to all embryos of the vertebrated animals. It always precedes the formation of the back-bone; and in some fishes, as the sturgeon (fig. 374), this cartilaginous or embryonic state is permanent through life, and no true back-bone is ever formed. Soon after, the first rudiments of the eye appear, in the form of a fold in the external membrane of the germ, in which the crystalline lens (fig. 307, *x*) is afterwards formed. At the same time we see at the posterior part of the head an elliptical vesicle,

which is the rudiment of the ear. At this period, the distinction between the upper and the lower layer of the germ is best traced; all the changes mentioned above appertaining to the upper layer.

§ 467. After the seventeenth day, the lower or mucous layer divides into two sheets, the inferior of which becomes the intestine; the heart shows itself about the same time, under the form of a simple cavity (fig. 307, *h*), in the midst of a mass of cells belonging to the middle or vascular layer. As soon as the cavity of the heart is closed in, regular motions of contraction and expansion are observed, and the globules of blood are seen to rise and fall in conformity with these motions.

Fig. 306.

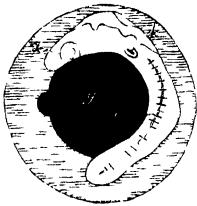

Fig. 307.

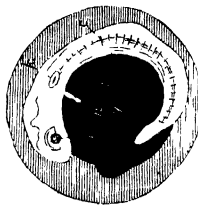
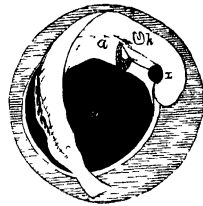

Fig. 308.



§ 468. There is as yet, however, no circulation. It is not until the thirtieth day that its first traces are manifest in the existence of two currents, one running towards the head, the other towards the trunk (fig. 308), with similar returning currents. At this time the liver begins to form. Meanwhile the embryo gradually disengages itself at both extremities from its adherence to the yolk; the tail becomes free, and the young animal moves it in violent jerks.

§ 469. The embryo, although still inclosed in the egg, now unites all the essential conditions for the exercise of the functions of animal life. It has a brain, an intestine, a pulsating heart and circulating blood, and it moves its tail spontaneously; but the forms of the organs are not yet complete, nor have they acquired the precise shape characterizing the class, the family, the genus, and the species. The young white-fish is as yet only a vertebrate animal in general, and might be taken for the embryo of a frog.

§ 470. Towards the close of the embryonic period, after the fortieth day, the embryo acquires a more definite shape. The head is more completely separated from the yolk, the jaws protrude, and the nostrils approach nearer and nearer to the end of the snout; divisions are formed in the fin which surrounds the body; the anterior extremities, which were indicated only by small protuberances, assume the shape of fins; and, finally, the openings of the gills appear, one after the other, so that we cannot now fail to recognize the type of fishes.

§ 471. In this state the young white-fish escapes from the egg about the sixtieth day after it is laid (fig. 309); but its development is still incomplete. The outlines

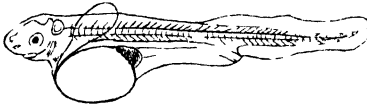

are yet too indistinct to indicate the genus and the species to which the fish belongs; at most we distinguish its

order only; the opercula, or gill-covers are not formed, the teeth are wanting, the fins have as yet no rays, the mouth is underneath, and it is some time before it assumes its final position at the most projecting point of the head. The remainder of the yolk is suspended from the belly, in the form of a large bladder, but it daily diminishes in size, until it is at length completely taken into the animal (§ 461). The duration of these metamorphoses varies extremely in different fishes; some accomplish it in the course of a few days, while in others months are required.

§ 472. In frogs, and all the naked reptiles, the development is very similar to that of fishes; it is somewhat different in the

Fig. 310

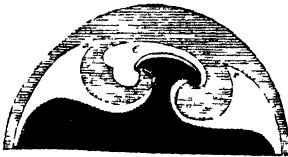

Fig. 311.



scaly reptiles (snakes, lizards, and turtles), which have peculiar membranes surrounding and protecting the embryo during its growth. From one of these envelopes, the allantois (fig. 311, *a*), is derived their common name of *allantoïdian vertebrata*, in opposition to the naked reptiles and fishes, which are called *anallantoïdian*.

§ 473. The allantoïdian vertebrata differ from each other in several essential peculiarities. Among birds, as well as in the scaly reptiles, we find at a certain epoch, when the embryo is already disengaging itself from the yolk, a fold rising around the body from the upper layer of the germ, so as to present, in a longitudinal section, two prominent walls (fig. 310, *x, x*). These walls, converging from all sides upwards, rise gradually till they unite above the middle of the back (fig. 311). When the junction is effected, which in the hen's egg takes place in the course of the fourth day, a cavity is formed between the back of the embryo (fig. 312, *e*) and the new membrane, whose walls are called the *amnios*. This cavity becomes filled with a peculiar liquid, the *amniotic water*.

Fig. 312.

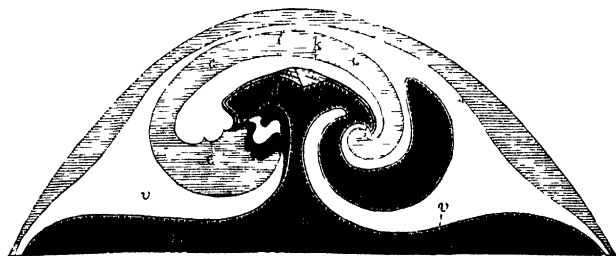

§ 474. Soon after the embryo has been enclosed in the amnios, a shallow pouch forms from the mucous layer below the posterior extremity of the embryo, between the tail and the vitelline mass. This pouch, at first a simple little sinus (fig. 311, *a*), grows larger and larger, till it forms an extensive sac, the allantois turning backwards and upwards, so as completely to separate the two plates of the amnios (fig. 312, *a*), and finally enclosing the whole embryo, with its amnios, in

another large sac. The tubular part of this sac, which is nearest the embryo, is at last transformed into the urinary bladder. The heart (*h*) is already very large, with minute arterial threads passing off from it. At this period there exist true gills upon the sides of the neck, and a branchial respiration goes on.

§ 475. The development of mammals exhibits the following peculiarities: the egg is exceedingly minute, almost microscopic, although composed of the same essential elements as those of the lower animals. The vitelline membrane, called *chorion*, in this class of animals, is comparatively thicker (fig. 313, *v*), always soft, surrounded by peculiar cells, being

Fig. 313.

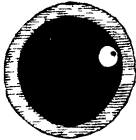
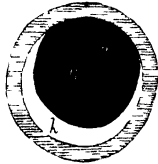

Fig. 314.



a kind of albumen. The chorion soon grows proportionally larger than the vitelline sphere itself (fig. 314, *y*), so as no longer to invest it directly, being separated from it by an empty space (*k*). The germ is formed in the same position as in the

other classes of the vertebrata, namely, at the top of the vitellus (fig. 315); and here also two layers may be distinguished,

Fig. 315.

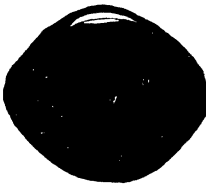

Fig. 316.



the upper, or *serous* layer (*s*), and the lower, or *mucous* layer (*m*). As it gradually enlarges, the surface of the chorion becomes covered with little fringes, which, at

a later epoch, become attached to the mother by means of similar fringes, arising from the walls of the matrix, or organ which contains the embryo.

§ 476. The embryo itself undergoes, within the chorion, changes similar to those described in birds; its body and its organs are formed in the same way, an amnios incloses it, and an allantois grows out of the lower extremity of the little

animal. As soon as the allantois has surrounded the embryo, its blood-vessels become more and more numerous, so as to extend into the fringes of the chorion (fig. 317, *p, e*), while, on the other hand, similar vessels from the mother extend into the corresponding fringes of the matrix (*p, m*), but without directly communicating with those of the chorion. These two sorts of fringes soon become interwoven, so as to form an intricate organ filled with blood, called the *placenta*, to which the embryo remains suspended until birth.

Fig. 317.

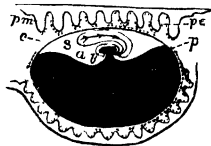

§ 477. From the fact above stated, it is clear that among the vertebrated animals there are three modifications of embryonic development, namely, that of fishes and naked reptiles,—that of scaly reptiles and birds,—and that of mammals, which display a gradation of more and more complicated adaptation. In fishes and the naked reptiles, the germ simply encloses the yolk, and the embryo rises and grows from its upper part. In the scaly reptiles and birds there is, besides, an amnios arising from the peripheral part of the embryo, and an allantois growing out of the lower cavity, both inclosing and protecting the germ.

§ 478. As a general fact, it should be further stated, that the envelopes protecting the egg, and also the embryo, are the more numerous and complicated as animals belong to a higher class, and produce a smaller number of eggs. This is particularly evident when contrasting the innumerable eggs of fishes, discharged almost without protection into the water, with the well-protected eggs of birds, and still more with the growth of young mammals within the body of the mother.

§ 479. But neither in fishes, nor in reptiles, nor in birds, does the vitelline membrane, or any other envelope of the egg, take any part in the growth of the embryo; while, on the contrary, in mammals, the chorion, which corresponds to the vitelline membrane, is vivified, and finally becomes attached to the maternal body, thus establishing a direct connection between the young and the mother: a connection which is again renewed in another mode, after birth, by the process of nursing.

STRUCTURE OF THE EGG AS JUST LAID.

[§ 480. The egg of the common fowl is surrounded externally with a hard calcareous *shell* (fig. 287, *a*), consisting almost wholly of carbonate of lime. It is, indeed, without obvious pores, but is nevertheless permeable to air: some part of its watery constituent escapes during the process of hatching, and eggs that are covered with a coat of varnish die. Internally the shell is full of pits or depressions, in which small warty or shaggy processes of the lining *membrane of the shell* (the *membrana testæ*) are implanted (fig. 287, *c, c*). This membrane consists of two laminæ, the outer of which is made rough and uneven by the processes just mentioned; the inner, which is turned towards the white, is smooth and polished. The two laminæ separate at the blunt end of the egg (fig. 287, *d, d*), so that here they are most easily demonstrated, and contain the air-space, or *air-chamber* (*folliculus aeris*) between them, which first appears shortly after the egg is laid, and is very much enlarged by keeping and the heat of incubation. The membrane of the shell is formed of a compact fibrous tissue, and shows the chemical properties of coagulated albumen. Betwixt the membrane of the shell and the yolk is interposed the *white* (*albumen ovi*), the outer stratum of which (fig. 287, between *c* and *e*) is extremely watery and fluent, and consequently readily drained off when the shell is pierced; the inner layer, again, or that which lies nearer the yolk, is more viscid and thicker (fig. 287, between *e* and *f*), clings more closely to the yolk, especially by its inmost stratum, which immediately surrounds that part and the chalazæ (fig. 287, *f, f*). The white of an egg shows alkaline reaction, and contains albu-

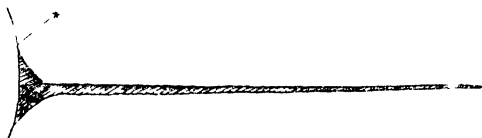

Fig. 318.—One of the chalazæ of the jackdaw's egg pulled straight. The way in which the twisted fibres of the part diverge into a funnel-shaped expansion as they approach the yolk, and so form the innermost stratum of the albumen, is displayed.

men, salivary matter, and the common sulphates and hydrochlorates in small quantity. The *chalazæ* (figs. 287, *g, g*, 320, *b, b*) are a couple of spirally-twisted ropes, composed of delicate fibres, or of a fine membrane, which, as the chalaziferous membrane (*membrana chalazifera*), closely surrounds the yolk, and then going off in the fashion of a funnel towards either pole of the egg, becomes twisted into a rope (figs. 287 and 318, 320). A white streak, in the shape of a band, may usually be seen extending over the yolk from one chalaza to the other; this is the zone or belt (*zona*), which, however, is not constant, and is of no particular importance. The *chalazæ* vary exceedingly in point of form and development; they appear to consist of coagulated albumen. The *yolk*, or *yolk-ball* (*vitellus*), is somewhat lighter than the white, so that, in whatever position the egg is held, it always rises towards the side that is uppermost. The *vitellary membrane* (*cuticula vitelli*) (fig. 319, *a*) is a perfectly simple, transparent, and slightly glistening membrane. It closely surrounds the yolk (fig. 287, *i*). Immediately under the vitellary membrane, and at a point which in an opened egg is always directed upwards, the *cicatricula* (fig. 320, *A, c*, and *B*), or tread, is seen shining through in the shape of a round whitish spot. The *cicatricula* consists superficially of a membranous stratum (*stratum proligerum*—fig. 320, *B*), from a line and a half to two lines in diameter, in which the germinal vesicle was imbedded at an earlier period. This is the *germ* from which in the beginning of the brooding the *germinal membrane*, blastoderma, is produced. The germ in recent eggs

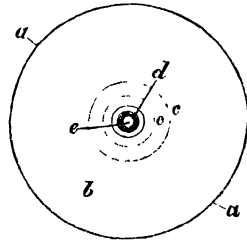
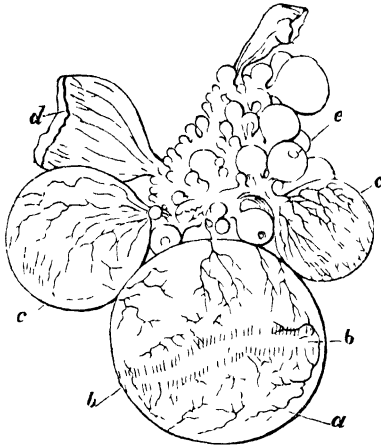

Fig. 319.—Vitellus, or yolk of a hen's egg, seen from above; *a, a*, vitelline membrane; *b*, vitellus; *c, c*, halloles; *d*, darker, more external part of the germ (the future area vasculosa); *e*, central transparent part of the germ (the future area pellucida). In the yolk here figured, the first slight effects of incubation are apparent—viz., in the separation in the germ, which often takes place from transient exposure of the egg to a high temperature (handling), or when the eggs have been laid some time, and the temperature of the air has been high.

cicatrice (fig. 321); the whole process is very similar to that which occurs among the mammalia when the Graafian vesicle gives way and the corpus luteum is formed. The



oviduct attaches itself, by a kind of suction, by its patulous infundibulum or bevelled abdominal end to the capsule which contains the ripest ovum, and receives this as it escapes. From this point the ovum makes its way moving spirally along the muscular oviduct, which is now very much enlarged, highly vascular, and pouring out from its mucous surface the albumen which is disposed around the yolk in the different layers but just described. The formation of the chalazæ is a consequence of the rotatory motion upon its axis which

the ovum receives in the oviduct, and of the setting of the albumen. The lower part of the oviduct is dilated into a receptacle for the egg, and here are added the membrane of the shell, and finally the shell itself, the milky calcareous fluid secreted by this part being precipitated upon the egg in crystals, which are at first isolated, but very soon run together and cohere. The egg remains over twenty-four hours in the receptacle. The germ at the first entrance of the egg into the oviduct has already assumed the appearance proper to it at any

upon its axis which

period anterior to the commencement of incubation, the germinal vesicle having burst; the upper disciform layers of the germ and germinal cumulus only separate more and more. After the egg is thus perfected, it is forced rapidly through the cloaca. In other birds, it is here perhaps that the egg receives, in part at least, the beautiful colours, red, green, yellow, brown, &c., in various shades, which are so frequently met with, and which appear to be so many tints of the colouring matter of the blood chemically altered.

EARLIEST PERIOD IN THE DEVELOPMENT OF THE CHICK,
FROM THE FIRST APPEARANCE OF THE EMBRYO TO THE
FIRST TRACES OF CIRCULATION.

[§ 482. The first period in the development comprehends about two days. In the first hours of incubation, the germ separates itself more from the vitellus and vitellary membrane, to which, however, it still continues in some sort attached; the germ acquires more of a membranous consistence, and the space between it and the germinal cumulus, which is filled with fluid, becomes somewhat larger. Towards the sixth, or between that and the eighth hour, a parting or resolution in the now foliaceous germinal membrane, which proceeds from the centre towards the periphery, is apparent; a clear rounded space, about a line in diameter, is produced in the middle, this is the *area pellucida* s. *germinativa*—the pellucid or germinal area (fig. 319, *e*); the germinal membrane at the same time becomes darker in the circumference, and surrounds the transparent pellucid area like a ring, which is also about a line in breadth (fig. 319, *d*); this is the future *area vasculosa*, or vascular area. The *cumulus proligerus* is seen in the deeper parts shining through the centre of the germinal membrane. At this time two or three annular lines appear drawn around the circumference of the germinal membrane—the *halones* (fig. 319, *c*, *c'*); these are circular ridges or walls formed in the vitellus, between which there are furrows filled with thinner fluid. Now also the germinal membrane may be observed to show a disposition to separate into two layers, which are, indeed, still intimately connected, but even at this early period are in point of structure different. They are always particularized as the *laminae* of the germinal membrane, the superior

lamina being entitled the *serous* or animal *layer*, the inferior the *mucous* or vegetative *layer*; the former is limited to the extent of the *area pellucida*, the latter extends farther in the periphery, stretching beyond the *area vasculosa*. The albumen disappears in a great measure over the germinal membrane, and the vitellus approaches the lining tunic of the shell more closely; in this situation, the vitellus becomes more prominent, forming a segment of a lesser sphere, like the cornea of the eye; a circumstance which may likewise be frequently observed in the egg before incubation (fig. 287, over *m*). It is not unimportant to observe that these, the earliest observable changes, not unfrequently take place in eggs that are laid in summer, and when the weather is very warm, though, of course, much short of brood-heat.

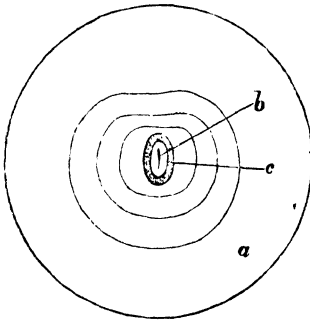

Fig. 323.—Vitellus or yolk after from twelve to fourteen hours' incubation, of the natural size (this and the other figures of the vitellus look larger than proper, from their having been placed in flat saucers to be drawn, by which they became somewhat flattened): *a*, the yolk; *b*, area pellucida, in the middle of which the *nota primaria*, or primary streak, the first trace of the embryo, is perceived; *c*, outer area pellucida, the future area vasculosa. The halones are indicated by the three concentric circles.

[§ 483. About the middle of the first day, after from twelve to fifteen hours of incubation, the *blastoderma*, or germinal membrane, is completely detached from the vitellary membrane, and may be cut out as a connected lamina, and washed away from the membrane of the yolk (figs. 323 and 324.) The *germinal area* (*area pellucida* s. *germinativa*) has now an elongated, often a somewhat pyriform appearance (figs. 323 and 325, *b*), and is two lines in length. The darker *vascular area* (figs. 323 and 325, *c*) has also lengthened out, and the germinal membrane extends as a foliaceous formation indefinitely over it into the halones, which now begin to look less regular than they were originally. This outer

portion of the blastoderma is called the *area vitellina*. About this period also the separation of the blastoderma, in the direction of its thickness, becomes more apparent; between the serous layer, which still continues limited to the germinal area, and the mucous layer, which extends into the vitelline area, there appears a new lamina, which, however, is only distinctly defined towards the periphery, where it approaches the limits of the *area vasculosa*; in the direction of the thickness this lamina lies in the blastoderma as if it belonged to both of the other layers, and penetrated into their substance; to distinguish this less separated lamina, it is spoken of as the *vascular lamina*, the blood and blood-vessels first making their appearance within its substance. This formation first becomes distinctly visible between the sixteenth and twentieth hour of incubation (fig. 329,

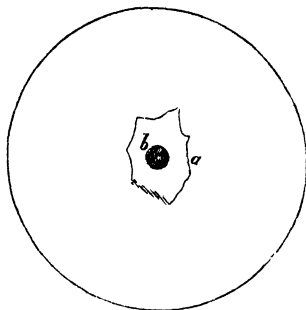

Fig. 324.—The same vitellus, but with a piece of the vitellary membrane and the subjacent blastoderma removed at *a*, by which the nucleus of the cicatricula, or cumulus proligerus, a dark disciform substance implanted in the vitellus, is brought into view.

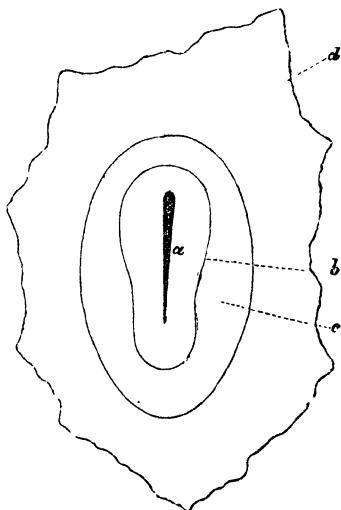

Fig. 325.—Magnified view of the portion of the blastoderma removed in fig. 319.—*a*, the nota, or primary streak; *b*, the oblong area pellucida; *c*, the oval area vasculosa.

A, B, *d*). Somewhat earlier than this, namely, about the fourteenth hour, the first rudiments of the embryo become distinctly visible in the middle of the germinal area, in the guise of a delicate white elongated streak, about a line and a half in length; it is designated *nota primitiva*—the primitive streak, and lies in the line of the long axis of the germinal area, which itself lies in the transverse axis of the egg (fig. 325, *a*). Under the *nota primitiva*, the cumulus proligerus, deeply seated, may still be seen very plainly glistening through (fig. 326, A, B, *d*). The *nota primitiva* rises slightly above the level of the germinal area (fig. 326, *b*); it is thicker and blunter anteriorly, or towards that end which becomes the head of the embryo, thinner, and tending to a point posteriorly. The *nota primitiva* is probably the groundwork of the brain and spinal cord.

[§ 484. The *nota primitiva*, an aggregate of dark granules in the first instance, becomes more fluent by and by, and presents itself as a layer of delicate, transparent masses, by the side of which, between the sixteenth and eighteenth hour, a pair of new formations arise symmetrically, near the middle line. These are the *laminae s. plicae dorsales*—the dorsal laminæ, two cylindrical rolls or enlargements, which arise parallel to the *nota primitiva*, and form a couple of cristae, or ridges, one on either side of it (figs. 327 and 328, *b, b*), which diverge anteriorly and posteriorly, being nearest about the middle of their length, and sloping somewhat from without inwards, or to-

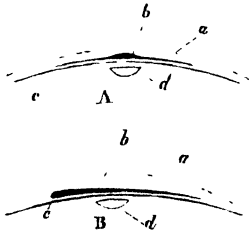

Fig. 326.—Ideal sections of fig. 323 (after Baër, with slight variations).—A, transverse section; B, longitudinal section; *a*, vitelline membrane, indicated by a finely dotted line; *b*, nota, or primitive streak, with the serous layer of the blastodermis, corresponding to the area pellucida; *c*, mucous layer of the blastodermis, corresponding to the area vasculosa; *d*, cumulus proligerus s. nucleus cicatriculæ.

wards one another. The angles of the ridges are softly rounded off; each ridge has the appearance of a clear broad line, which is included within two darker lines. The germinal

area presents a pyriform outline (figs. 327 and 328). Under the canal for the spinal cord, which is bounded by the dorsal laminæ, we observe the *chorda dorsalis*—the dorsal cord (figs. 330 and 332, *A*, *e*, and fig. 331, *f*), an extremely fine elongated streak, surrounded by a transparent sheath; both the dorsal cord and the sheath go to constitute the cartilaginous column which appears later, and out of which, by its becoming divided into pieces, the vertebral column is produced (§ 466). The embryo with its laminæ dorsales now bends itself forward, at the same time that it here forms a sickle-shaped transparent fold (fig. 328, *c*), the future *involutum capitis*—the cranial envelope or cap. From the twentieth to the twenty-fourth hour, the transparent germinal area is observed to become longer and more fiddle-shaped. The cristæ, or folds of the dorsal laminæ, where they run closest together, appear somewhat sinuously bent (fig. 331, *b, b*); here, too, in the pectoral region, on both sides of the dorsal laminæ, near their cristæ, there appear dark, four-cornered looking

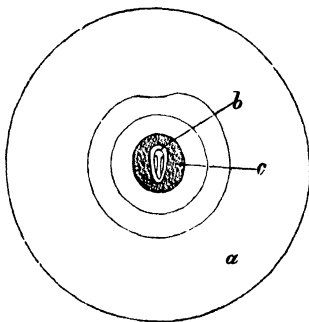

Fig. 327.—Yolk of the natural size, after eighteen hours of incubation: *a*, vitellus; *b*, area pellucida; *c*, area vasculosa.

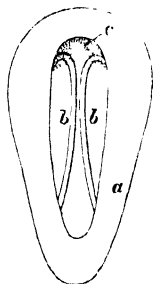

Fig. 328.—The pellucid area of fig. 327 magnified; *a*, the pellucid area, now become pear-shaped; instead of the nota, or primary streak, the two dorsal laminæ or folds (*laminæ s. plicæ dorsales*) *b, b*, are seen; the *involutum capitis*, or cranial envelope, *c*, a falciform fold, or kind of reflex blastoderma, begins to be developed.

plates, the future vertebral arches (fig. 331, *c, c*, fig. 332,

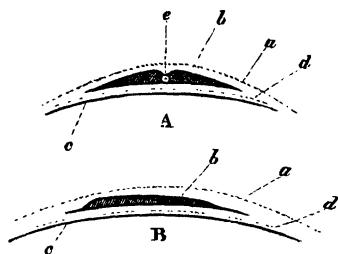

Fig. 329.—Ideal sections of figs. 327 and 328.—A, transverse section; B, longitudinal section; *a*, vitellary membrane; *b*, serous layer of the blastoderma, or germinal membrane, depressed in the middle by reason of the rounded elevations of the dorsal laminae on either side; *e*, chorda dorsalis; *c*, mucous layer of the blastoderma; *d*, vascular lamina, between *b* and *c*, indicated by a finely-dotted line.

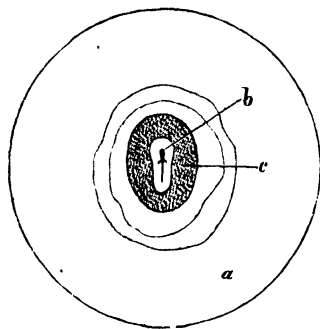

Fig. 330.—Vitellus of the natural size after twenty-four hours of incubation, the germinal membrane with the rudiments of the embryo farther advanced than in fig. 327. The references are the same in this as in figure 327.

A, f), which form at first but three or four pairs; the cristæ of the dorsal laminae are observed to approximate more and more, in order to close and complete the vertebral canal (fig. 332, A) over the chorda dorsalis (*e*). Anteriorly they separate to a greater extent from each other to form the head (fig. 331, *d*), and also posteriorly to form the future sacrum; the enveloping fold, the future involucrem capitis, is thrown farther back (fig. 331, *e, e*); the vascular and mucous laminae of the germinal membrane follow this bending in (fig. 332, *f*), by which the beginning of the intestinal canal is produced, which as yet is nothing more than a depression on the vitelline side of the serous lamina of the germinal membrane. The embryo lies like a flat-bottomed boat turned over upon the germinal membrane (fig. 332, B); the head is already strongly indicated (fig. 332, B, *e*).

[§ 485. With the se-

cond day of incubation the embryo disconnects itself even more and more from the germinal membrane and the yolk, and rises more distinctly over the germinal area. This takes place by the anterior plait or fold (*involutum capitis*) continuing to recede still farther backwards (fig. 334, *e*), and the development posteriorly of a second plait or fold, sickle-shaped or crescentic in the first instance also (fig. 334, *g*), the future *involutum caudæ*; the sides now begin to turn inwards also, by which the transparent germinal area is drawn in and bent laterally, and made to assume a complete fiddle-shape (figs. 333 and 334). The embryo is three lines in length; the broader and more strongly bent extremity, with its transverse plait or envelope, is visible to the naked eye. The cristæ of the dorsal laminae have become approximated through a larger space, touch each other (fig. 334, *b, b*), and finally coalescing completely, close the canal for the spinal cord (fig. 335, *A, g*), beneath which the more delicate *chorda dorsalis* with its sheath (*e*) extends. The four-cornered laminae, the future vertebral arches, have increased in number, new ones springing up in front and behind; and, about the thirty-sixth hour, as many as from ten

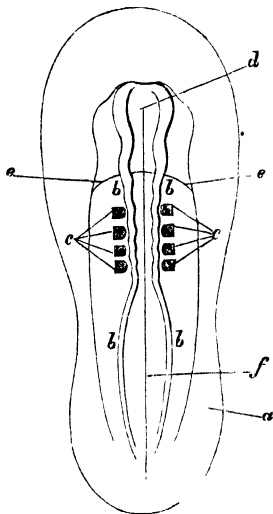

Fig. 331.—Magnified view of the pellucid area of the yolk, fig. 330; the area has now lost its pear-shape in a great degree, and become somewhat fiddle-shaped (biscuit-shaped in the original). In the middle are seen the slightly sinuous edges of the dorsal lamina, *b, b*, separating from one another anteriorly and posteriorly; on their outsides lie four square plates, *c, c*, rudiments of the vertebral column; *d*, anterior cerebral cell; *e, e*, transparent edge of the cranial involucrem, shining through; *f*, dorsal cord.

to twelve pairs may be reckoned (fig. 334, *c, c, c*). At this time the dorsal laminæ separate still more from one another in front, so that many spaces or cells become distinctly visible between them; the largest or most anterior of these cells (fig. 334, *d*)

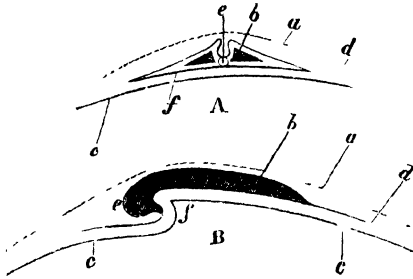

Fig. 332.—Ideal sections of fig. 331.—A, transverse section; B, longitudinal section. In A, *f*, section of the vertebral laminæ. In B, formation of the head by the reflection of the blastoderm; *e*, margin of the involucrem capitis, and entrance into the future intestinal canal (fovea cardiaca of Wolff). The other references are the same as in fig. 329.

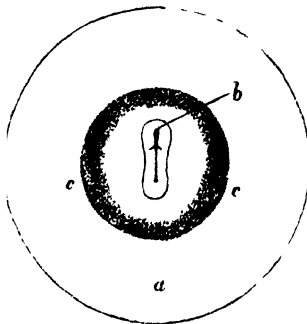

Fig. 333.—Yolk of the natural size after thirty-six hours of incubation; *a*, yolk; *b*, fiddle-shaped pellucid area, in the middle of which the embryo is seen. In the vascular area, *c, c*, the insulæ sanguinis, or blood islets, begin to appear.

has become somewhat pointed forwards, and curved underneath; laterally it presents wide bending inlets, which indicate the first formation of the eyes; it is the cell of the thalami and crura of the cerebrum; the second smaller cell (*d*²) is the cell of the corpora quadrigemina; the third, an elongated cell (*d*¹), belongs to the medulla oblongata. The transparent mass of the brain and spinal cord acquires greater consistency, and is covered with a firmer, but highly transparent layer, the future membranous in-

volucra of the nervous centres; the brain, and medulla oblongata, up to this time, are, therefore, in fact, shut vesicles, which, on account of their transparency only, appear as open spaces lying between the sinuous cristæ of the dorsal laminæ. Outwardly, from the cristæ of the dorsal laminæ, and the four-cornered laminæ of the vertebral arches, proceeds the serous lamina of the germinal membrane, thickening as it grows, and bending from both sides at the same time slightly inwards; in this part a number of small dark leaflets make their appearance simultaneously, which become particularly plain in the transverse section (fig. 335, A, and especially fig. 338, A, *b*²); these are the rudiments of the transverse processes of the vertebræ, and, farther out, of the

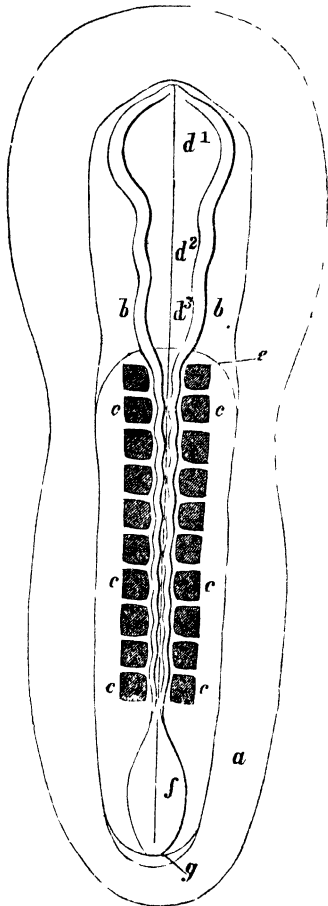

Fig. 334.—Magnified view of the area pellucida of the vitellus, fig. 329 —*b, b*, crests of the dorsal laminæ, receding from each other anteriorly to form the cerebral cells; *d*¹, cell of the eyes and thalami; *d*², cell of the corpora quadrigemina; *d*³, cell of the medulla oblongata; *c, c, c, c*, laminæ dorsales, of which ten are present on either side; *e*, anterior fold of the

ribs likewise; these lateral prolongations of the serous lamina

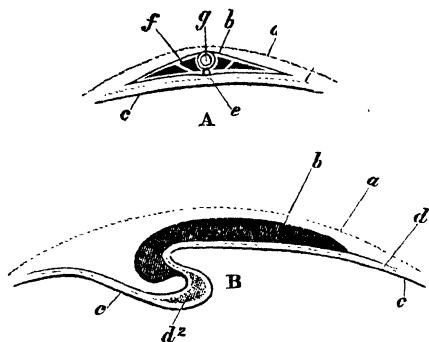

Fig. 335.—Ideal sections of the embryo of fig. 330; letters of reference as in fig. 329. A, over the chorda dorsalis, *e*, is seen *g*, the canal for the spinal cord, formed by the union of the cristæ of the dorsal laminae. B, longitudinal section. The heart, *d*², is evolved as a thickening of the lamina vasculosa.

mucous layers follow the turnings and general course of the serous layer, and decline anteriorly under the head of the embryo, by which the *fovea cardiaca*, the anterior depression which marks the commencement of the intestinal canal, becomes deeper (figs. 332, B, *f*, and 335, B). From this sinus the vascular and mucous layers turn more posteriorly, and immediately again proceed forwards, to be continued in the plane of the germinal membrane (fig. 335, B, where the heart, *d*², is indicated). This part of the germinal membrane, then, covers the head of the embryo when it is viewed from below, and on this account is called the *involutum capitis*—the cranial envelope or cap—among writers on development; it is not any independent formation.

Whilst these changes in the form of the serous layer are going on, others are proceeding, *pari passu*, in the vascular lamina, in the following order, from the end of the first day

blastoderma, from which the *involutum capitis* is formed, shining through; *g*, posterior fold of the blastoderma, still very narrow, from which is formed the *involutum caudæ*; *f*, chorda dorsalis.

are called the *laminae ventrales*, ventral laminae. As the dorsal laminae arise more perpendicularly in plaits, and converge to close the spinal canal, so the ventral laminae spread more in breadth, bend in inferiorly, and converge to form the lateral parietes of the abdomen, and finally to close this cavity.

The vascular and

to the middle of the second. The *area vasculosa* (figs. 330 and 333, c) has enlarged, and from a form rather elongated, has assumed one that is rounder. Its outer circumference is beset with darker aggregated-looking masses (fig. 333); single isolated points appear, and between these clefts are formed, that by and by run together and form channels, which unite in meshes with one another; in these channels a clear colourless or extremely pale yellow fluid can by and by be distinguished in motion—this is the blood. The halones (fig. 330), which had become more sinuous towards the beginning of the second day, now vanish entirely. Along with these occurrences in the periphery of the vascular lamina, the *development of the heart* has been advancing in the centre, under the transparent germinal area and the serous layer of the embryo. The vascular lamina becomes thicker, and appears darker in this point; the heart shows itself as a somewhat sinuous sac, interposed between and pushing apart the mucous and serous laminae (fig. 335, B, *d*²). As the development advances, the heart is observed from the under or abdominal aspect of the embryo as a sac, simple and undefined anteriorly, of greater

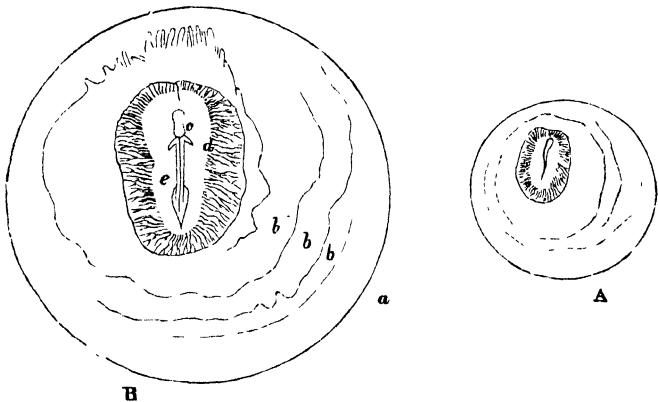

Fig. 336.—An incubated vitellus of the jackdaw's egg; A, of the natural size; B, magnified—*a*, vitellary membrane; *b, b, b*, halones; *c*, embryo; *d*, area pellucida; *e*, area vasculosa. (Compare with figs. 330 and 333.)

breadth posteriorly, and terminating in two (fig. 337, *d, f*)

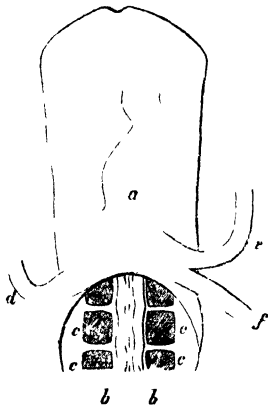

Fig. 337.—Anterior end of an embryo scarcely of greater age than that of fig. 330, seen from the abdominal (the vitellary) aspect, to show the first formation of the sacculate heart, *a*, with its immerging vascular (venous) trunks, *d, e, f*, *b, b*, crests of the laminæ dorsales seen shining through.

or three (fig. 337, *e*) crura; these are the future great *venous trunks*, which as yet are lost insensibly in the germinal membrane. Even at this period undulating motions, rhythmical contractions of the heart, may be perceived, by which the somewhat wavy appearance of the organ is produced; the same clear or nearly colourless fluid is in motion in the heart as in the vessels in the periphery. The heart occupies the whole space from the involucral point of the germinal membrane to the cranial end of the embryo, and is consequently, when the embryo is contemplated from below, covered by the part of the serous membrane which at the same time forms the involucrem capitis. The embryo, which at the end of the first day bore some resemblance to a punt or flat-bottomed boat, by the

middle of the second day has acquired the form of an ordinary small boat turned over, the sides of which (the ventral laminæ) converge, whilst the head is much curved or beak-fashioned (the bending down of the head), and furnished with a particular cover (the involucrem capitis); the posterior part is also somewhat recurved, but much less so than the anterior part, by the commencing development of the caudal envelope. The ventral channel extends from the posterior margin of the heart (fig. 337) to the crescentic plait of the caudal envelope (fig. 334, from *e* to *g*, seen through the back of the embryo).

[§ 486. The changes that occur during the second half of the second day, from the thirty-sixth to the fiftieth hour, are the following: the dorsal laminæ are closed along the whole

line of their course; the head curves itself more and more under the body, so also does the tail; and the involucre both of the head and tail again bend towards the dorsal aspect; the ocular sinuses are separated more distinctly from the anterior cerebral cell, which now lies completely underneath; the cell of the corpora quadrigemina is much enlarged; from the cell of the medulla oblongata the organ of hearing arises as a vesicular eminence, and in its anterior part, a particular contraction of the cerebellum is very commonly to be perceived; the spinal cord is now a laterally compressed tube. The blood collects in the periphery of the vascular lamina within a circular sinus or annular vessel, the future *sinus s. vena terminalis*. The heart soon parts the ventral laminae from one another, like a wedge, and so forms a hernia behind the point of reflection of the germinal membrane to the cranial involucre; it is here that the venous trunks penetrate which carry the blood from the periphery of the vascular lamina to the heart. The heart itself has now become a relatively narrower, and more curved or spirally twisted sac, which contracts with greater vigour than heretofore. The anterior extremity of the heart divides into two crura, which proceed to the cover of the future oral cavity, and run for a certain way under the vertebral column, where they blend into the future aorta, separate again, and give off two great transverse branches, which lose themselves in the germinal membrane towards the periphery of the vascular area. The blood by degrees acquires a red colour. The transparent germinal area continues fiddle-shaped. In the periphery the serous lamina recedes still more from the other laminae of the germinal membrane that lie under it, at the same time that it is raised round the whole circumference into a fold which grows with great rapidity in the beginning of the third day (fig. 338, A, B, f). The whole embryo is still more bent on itself; the cell of the corpora quadrigemina forms its anterior and superior end; the caudal end is turned in more than ever, and the mucous layer following the bending, a depression is here formed in the same way as we have seen one produced towards the anterior extremity, at the fovea cardiaca; the digestive cavity is now a channel of considerable depth; which, however, is still largely patulous towards the vitellus; from which undoubtedly it derives formative materials.

SECOND PERIOD OF THE DEVELOPMENT OF THE CHICK, TO
THE EVOLUTION OF THE SECOND CIRCULATION.

[§ 487. THE second period in the history of the development of the chick begins with the third day, in the course of which the circulation in the vitelline vessels is completely established (figs. 339 and 346), and embraces farther the changes that take place during the fourth and fifth days, till the allantois has appeared, the membrane of the shell has been attained, and the second circulation is established; the first, which had reached its highest development at the end of the fourth day, now beginning to suffer an arrest, and to decline in extent and activity (figs. 341 and 345). In the course of this period the embryo is completely detached from the germinal membrane, and becomes enveloped in peripheral productions of the same part. The third day is the most remarkable in the whole

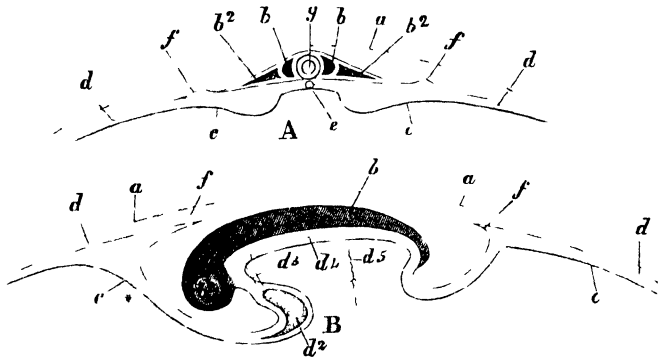

Fig. 338.—Ideal section of an embryo somewhat younger than that of fig 339. A, transverse section; *a*, vitelline membrane; *b, b*, laminae dorsales et vertebrales; *b², b²*, laminae abdominales and transverse processes; *c, c*, lamina mucosa, which is seen bending round under the chorda dorsalis (*e*), to form the intestinal canal; *d, d*, lamina vasculosa; *f, f*, peripheral portion of the lamina serosa, proceeding to form the lateral involucre and the amnion; *g*, medulla spinalis.—B, longitudinal section; *a*, vitellary membrane; *b*, lamina serosa, and dorsum of the embryo; *b²*, head of the embryo; *c, c*, lamina mucosa; *d*, lamina vasculosa; *a²*, heart; *d³*, branchial arteries; *d⁴*, aorta; *d⁵*, artery of the blastoderma (*arteria vitellina*).

history of the development, as, from the general vigour of the formative processes, all the organs now begin to be evolved,

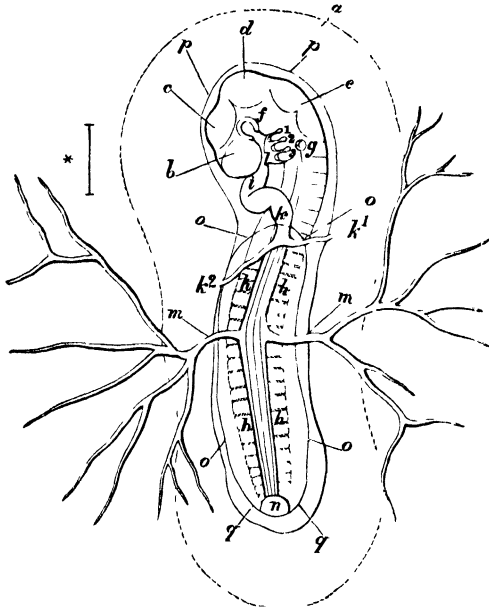

Fig. 339.—View of an embryo, four lines long, magnified about eight diameters. The embryo is seen from the abdominal surface; the time is the middle of the third day. *a*, Area pellucida; *b*, anterior cerebral cell (the hemispheres); *c*, cell of the thalami and crura cerebri; *d*, corpora quadrigemina; *e*, cerebellum and medulla oblongata; *f*, the eye, a wide cleft inferiorly; *g*, the auditory vesicle lying in front of the medulla oblongata; *h, h, h*, vertebral lamina; *i*, ventricle of the heart; *k*, atrium cordis; *k¹*, superior, and *k²*, inferior vein of the blastoderma; *l*, bulb of the aorta, giving off the four branchial arteries, over which lie three branchial arches, 1, 2, 3; *m, m*, arteries of the blastoderma proceeding from the divided trunk of the aorta; inwards from either aorta the bodies of the vertebral laminae are united by suture; *n*, the allantois just budding forth; *o, o, o, o*, margins of the abdominal cavity, reflected superiorly into the involucrem capitis, *p*; inferiorly into the involucrem caudæ, *q, q*. The mesentery, Wolffian bodies, &c., which have by this time begun to appear, are left out. The actual length of the embryo is indicated by the line with the asterisk.

and the characteristic form of the embryo to be more particularly declared. We shall speak of the different appearances in groups, as they are associated with the several laminæ of the germinal membrane, tracing each principal formation, and each individual organ, in progress from the beginning to the end of the period we are now considering.

[§ 488. The dorsal laminæ have increased in size, and the rudiments of the vertebræ within them (the vertebral laminæ) are growing both anteriorly and posteriorly (fig. 339, *h, h*); they surround the spinal canal on the sides, are also to be seen over the medulla oblongata, and several even exist anterior to the ear (fig. 340, at *d*). In the vicinity of the chorda dorsalis,



Fig. 340.—Anterior end of an embryo somewhat more highly magnified, and a few hours older than that of fig. 339. *a, a*, Cranial involucrem; *b, b*, vertebral laminæ near the crests of the now closed dorsal laminæ; *c*, spinal cord passing into the medulla oblongata, *d*, which in its turn passes by a depression (the fourth ventricle) into the corpora quadrigemina, *e*; *f*, mesocephalon (thalami and crura cerebri); *g*, hemispheres; *h*, superior maxillary bone; *i*, auditory vesicle; *k*, branchial arches; *l*, atrium cordis; *m*, the heart hanging forwards; *n*, bulb of the aorta.

outwardly, between it and the vertebral laminæ, arise the first cartilaginous rudiments of the bodies of the vertebræ, which blend superiorly with the laminæ of the vertebral arches, close in the canal of the spinal cord below, and surround the cartilaginous column (sheath) of the chorda dorsalis. Towards the fifth day the chorda dorsalis begins to disappear; the spinal cord is laterally compressed, and falls into two halves, each of which is again divided into an upper and an under fasciculus. It is on the fifth day that the rudimentary enlargements or processes, indicative of the position of the future *extremities*, make their appearance; the earliest traces of the cerebral envelopes were already conspicuous on the fourth day. The medulla oblongata (fig. 340, between *c* and *d*) is extremely flat above, in conse-

quence of the divergence of the superior fasciculi from one

another, and thus is the basis laid of the fourth ventricle, which appears to be covered with its own peculiar medullary and enveloping lamina. Anteriorly, the fasciculi of the medulla oblongata ascend towards the corpora quadrigemina in two perpendicular laminæ, which, on the fifth day, become applied to one another, and so cover the fourth ventricle superiorly and anteriorly; thus is the *cerebellum* produced, visible from the side as an enlargement (figs. 339 e, 340 d, 341 and 345 a²), behind which the fourth ventricle presents itself as a deep depression (figs. 341 and 345 d). The *corpora quadrigemina* form a simple and very considerable cell, which projects forwards in an arched or vaulted manner, but, with the increasing declension of the head, turns always more and more downwards (figs. 339 and 347 d, 340 e, 341 and 345 a, 343 B, a, 342 b, 344 c). The laminæ, which form the cerebellum, proceed upwards, blending in the corpora quadrigemina, under which the fourth ventricle is continued as the aqueductus. Anteriorly to the corpora quadrigemina lies the asymmetrical, smaller, middle cerebral cell (figs. 339 and 345 c, 340 and 341 f, 343 B, before r), formed by



Fig. 341.—Embryo of the fowl, nearly five lines in length, at the seventy-second hour of incubation (transition from the third to the fourth day). The abdominal surface is partly laid open, and the parts separated; the amnion is removed. *a*, corpora quadrigemina; *b*, the hemispheres; *c*, the nasal depression; *d*, the fourth ventricle, in front of which lies the cerebellum, *a*², which is now more distinctly defined; *e*, the ear; *f*, the eye, in the choroid of which, already furnished with its pigment, a cleft is seen; *g*¹—*g*⁴, the four branchial clefts; *h*, the heart; *i*, the liver; *k*, the intestinal canal, with its open vitellary duct *l*; *m*, the rectum still ending in a blind sac; *n*, the allantois; *o*, the anterior, and *p*, the posterior, extremity; *q, q, q, q*, Wolffian bodies; *r*, upper jaw; *s*, under jaw.

the advancing laminæ of the medulla oblongata as the *crura cerebri*; it is open superiorly, and extends, as the third ventricle, with a wide opening into the infundibulum, which on the second day was directed straight downwards, but which now, from the great bending in of the head, is turned backwards, and even upwards. In this cell, which was the first formed, and foremost cerebral cell (fig. 334, *d*¹), the *thalami* make their appearance towards the end of the period. The most

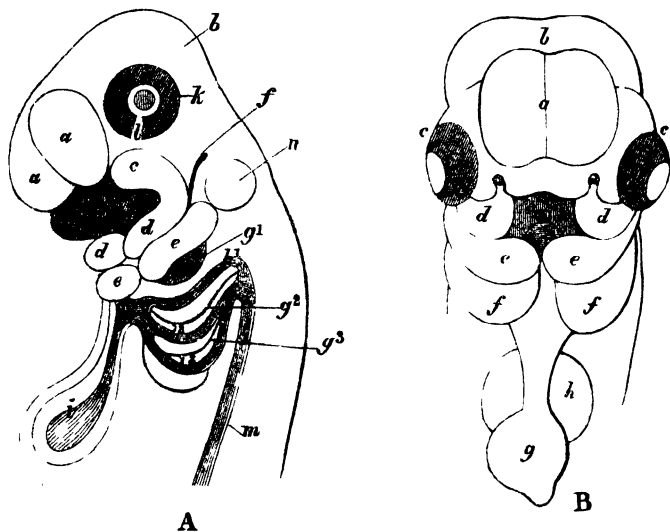

Fig. 342 A.—Embryo of the fowl of the fifth day, much magnified; after Huschke (*Isis*, 1828, § 163.)—*a*, *a*, hemispheres; *b*, corpora quadrigemina; *c*, upper jaw; *d*, under jaw; *e*, first branchial arch (*os hyoides*); *f*, meatus auditorius externus; *g*¹, *g*², *g*³, first, second, and third branchial fissures; *h*¹, *h*², *h*³, the three branchial arteries; *i*, the heart; *k*, the eye, with the cleft *l*; *m*, descending aorta; *D*, cavity of the mouth and fauces; *n*, acoustic pouch.

Fig. 342.—B (after Huschke), front view of the embryo of the fowl, of the fourth day; *a*, hemispheres; *b*, corpora quadrigemina; *c*, eye; *d*, upper jaw; *e*, lower jaw; *f*, enlargement of the *os hyoides*; *g*, ventricle of the heart; *h*, atrium cordis; *D*, oral aperture and faucial cavity.

anterior cerebral cell, at the present epoch, is symmetrical, and contains the hemispheres (figs. 339, 341, and 345 *b*, 340 *g*, 344 *d*, 343 *B*, *p*); according to the natural curvature of the embryo, it lies completely downwards. The *optic nerve* appears as a vesicle, betwixt the middle and anterior cerebral cell, in which the external envelopes (the outer portion of the serous membrane), preparatory to the formation of the *eye ball*, bend circularly inwards, in the shape of a sac, and externally form a projection, which opens downwards as a cleft; this is closed by degrees, and at length forms a colourless thin streak, whilst the rest of the bulb, from the deposition of the pigmentum nigrum, is dark or deeply coloured; the *lens* makes its appearance very early (on the third day), forming a particular closed capsule within the sac of the external envelopes (the ball of the eye), and lying in the midst of an albuminous ball, the *vitreous humour*.* The *organ of hearing*, at first a simple vesicle arising from the medulla oblongata, soon becomes a distinct sac, which, examined from behind, appears attached to the medulla oblongata by means of a pedicle—the *acoustic nerve* (fig. 340, *i*); distinct from it a cleft appears (fig. 342, *A*, *f*), which increases over against the acoustic sac, and sinking into it, forms the external *meatus auditorius*. If the embryo be lying upon its side, the acoustic sac, which subsequently forms the labyrinth, is seen as a rounded enlargement (figs. 339 *g*, 341 *e*, 342 *A*, *n*), which in the course of the period under consideration, comes continually forward. About the beginning of the third day, the *olfactory nerve* shows itself towards the basis of the cell of the hemispheres; at a later period the *nasal hollow* (fig. 341, *c*) is observed as a broad depression with puffed edges; on the fifth day both nasal hollows have become deeper, and are now distinct from one another.

§ 489. Very important metamorphoses go on during this period in the ventral laminae lying on either side of the dorsal laminae, or middle portion of the embryo; so far these ventral laminae are formed from the serous layer of the germinal membrane only; they separate into a superficial thinner layer (figs. 338 and 343, *A*, *b*² and *f*), which, like a cuticle, loses itself in the periphery of the embryo upon the deeper stratum; and, as it has already suffered a reflection anteriorly opposite the

* On the metamorphosis of the eye, consult figs. from 339 to 340.

heart, and formed the involucrem capitis; so, towards the posterior part, it has bent over as the involucrem caudæ, and been formed into plaits or folds laterally, as the lateral envelopes. Thus is the serous layer of the germinal membrane, or upper layer of the ventral laminæ, raised on every side to converge into an elliptical plat towards the back of the embryo, on the fourth day, these plaits have approached each other very closely,

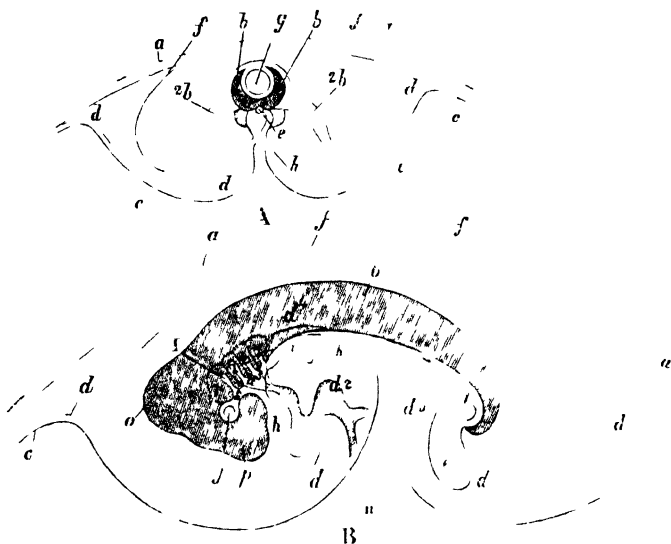

Fig 343—Ideal section of an embryo nearly at the end of the third day —A, transverse section, *a* vitelline membrane, *b, b*, lamina dorsales, &c, as in fig 338 B, longitudinal section The cranial and caudal involucre approximate, and at length meeting, they close the amnion, *g*, the eye, *h*, entrance into the mouth, or fovea cardiaca, *i*, the œsophagus, with the rudimentary lung budding out as a diverticulum from it, *k*, expansion of the alimentary tract, marking the seat of the stomach, *l*, posterior shut extremity of the intestine, from which proceeds the allantois, *e*, surrounded by the vascular lamina *d*, *m*, the mesenteric lamina, *n*, passage from the vitellus to the open abdomen, *o*, anterior part of the head (corpora quadrigemina), *p*, hemispheres, *r*, superior maxilla, *s*, inferior maxilla, *I*, oral cleft or aperture, *1, 2, 3*, three branchial clefts Other references as in fig 338

the anterior is now called the *vagina capitis*; the posterior *vagina caudæ* (fig. 343, B, *f*, backwards); the lateral folds may, in like manner, be entitled the *vaginæ laterales* (fig. 343, A, *f*, *f*); they coalesce at the end of the fourth day, and form a visible cicatrice over the lumbar region of the embryo. In this way we have a complete vesicular envelope thrown around the embryo,—the AMNION (fig. 344, *a*, *a*), which is filled with fluid. The upper layer of the fold (fig. 343, A and B, lying under the vitelline membrane, *a*), covers the whole germinal membrane, and grows around the yolk as a serous capsule or cyst, *vesica serosa*—the false amnion of Pander. At the place where the embryo lies, this layer is separated from the rest of

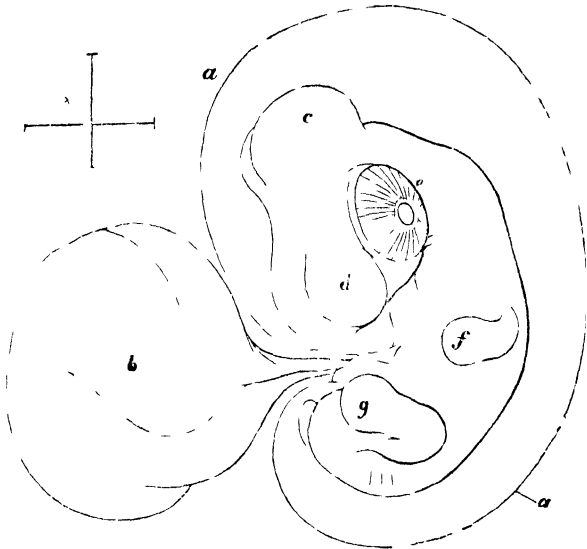

Fig. 344.—Outline of the embryo of the fowl, at the end of the fifth day, much magnified; *a*, *a*, amnion; *b*, allantois; *c*, corpora quadrigemina; *d*, hemispheres; *e*, eye; *f*, anterior; and *g*, posterior extremity. The natural dimensions of this, as of many of the other figures, are indicated by a line, or lines, with an asterisk.

the germinal membrane by a considerable space. The inferior layer of the serous ventral lamina forms the ventral paries, and gives origin to the bones and muscles which compose the neck and trunk. Inferiorly, the vascular lamina lies upon it, and this, with the serous lamina, evolves the formations which are now to be described. On either side, under the vertebral column, there is a lamina detached, which grows thicker, and increases in a direction perpendicularly downwards; these are the *lamina mesenterica*, between which there is, at first, an open triangular-shaped channel or cleft, the *foramen mesenterii*; both the mesenteric laminae push the mucous layer before them, and speedily unite, at an acute angle, in the suture (fig. 343, A, *h*, B, *m*). The furrow, or foramen of the mesentery, resembles an equilateral triangle, with one of its angles pointing directly downwards. After the union of the two mesenteric laminae, the resulting structure grows most rapidly posteriorly, opposite the middle of the body, and here forms a septum, dividing the abdominal cavity into two halves.

It is at the beginning of the intestinal canal, where the ventral laminae are converging, that the *branchial arches* are developed; the parietes of the body here become thinner; and in this, the cervical region, several clefts or fissures make their appearance, which sink downwards, and penetrate through the mucous layer; there are three pairs, or, with the oral aperture, four pairs of such fissures, but the posterior pair are extremely small; they are called the *branchial fissures*—*fissurae branchiales*; between them lie three segments, or divisions of the ventral laminae, which are blunt and rounded anteriorly, bevelled off towards the digestive cavity, and therefore sickle-shaped; these are named the *branchial arches*—*arcus branchiales* (figs. 339, 340, 341, 343, &c.); the fourth branchial arch is placed hindmost, and is not yet distinct from the ventral lamina. On the fourth day, the two most anterior branchial arches increase in thickness (fig. 341, between g^1 and g^2); a new fissure is formed posteriorly (fig. 347, g^1); on the fifth day, the foremost fissure closes (fig. 342, A, between *d* and *e*), and the foremost branchial arch unites with its fellow of the opposite side, and forms the *lower jaw* (fig. 342, A, *d*, B, *e*); the next in succession is transformed into the *os hyoides* (fig. 342, A, *e*, B, *f*). The two last branchial fissures close

up on the fifth day; at the same time the first is lost entirely; but the second continues longer open (fig. 342, A, g^1). On the third and fourth days, the part of the ventral lamina, which is situated in front of the lower jaw, thickens and resolves itself into the *upper jaw* (fig. 341, *r*, and 345, 1 above 2); this part is more strongly marked on the fifth day (fig. 342, A, *c*). The two sides of the upper jaw do not meet in the first instance; they coalesce at a later period, through the medium of the frontal process, which is developed betwixt the eyes (fig. 342, B, over D).

The rudiments of the *ribs* begin to be formed in the parts of the ventral laminae lying behind the branchial arches; the extremities show themselves upon the external aspects of the same laminae.

Of the *extremities* there is still no trace to be discovered in the first half of the third day (fig. 339), but in the second half of that day they arise on the sides of the ventral laminae as narrow edgings, which by the close of the day have turned more upwards, gained the outer margins of the ventral laminae, and changed into rounded offsets (fig. 341, *o*, *p*), the posterior pair being distinguished from the anterior by somewhat greater breadth (fig. 345, *o*, *p*); on the fifth day they recede still more up-

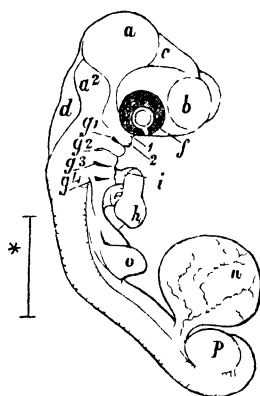

Fig. 345.—Embryo of the fowl of the first half of the fourth day; *a*, corpora quadrigemina; *b*, hemispheres; *c*, mesocephalon (thalami); *d*, fourth ventricle; *f*, eye, the cleft in the choroid beginning to close; g^1 , g^2 , the first and second branchial spaces still entirely open; g^3 , g^4 , the third and fourth spaces open behind only; *h*, the ventricle of the heart, now of a rounded form; *i*, aorta; *n*, allantois; *o*, anterior, and *p*, posterior extremity. 1, 2, Upper and under jaw. The line with the asterisk indicates the natural length of the embryo.

wards towards the dorsal laminæ, become pediculated, and present a broad shovel-shaped termination (fig. 344, *f*, *g*).

[§ 490. The *vascular lamina* in its development follows the phases of the first, or vitellicular circulation, which, as has been stated, attains its height on the fourth day (fig. 346).

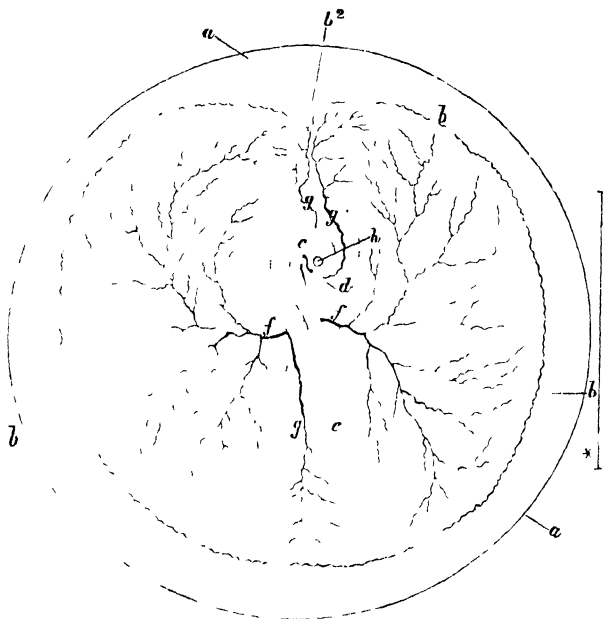

Fig. 346.—View of the vitellus, magnified rather more than two diameters, exhibiting the circulation of the blastoderma completely developed:—*a*, Vitellus; *b*, vena s. sinus terminalis; *b*², point of approximation to the embryo of the terminal sinus, and its communication with the veins, *g*, *g*; *c*, aorta; *d*, punctum saliens, or pulsating point of the heart; *f*, *f*, arteries of the blastoderma; *g*, *g*, veins of the same (one inferior, two superior; sometimes there is but one above as well as below); *e*, *e*, the fiddle or guitar-shaped area pellucida; *h*, the eye. (This figure will be found to correspond in almost every particular with that of Pander, tab. iv. fig. 1, of his well known work, *Entwicklungsgeschichte des Hühnchens im Eie*). The more delicate ramifications of the vessels and their numerous inosculations with the bounding sinus are omitted.

Immediately under the head of the embryo, three blood-red bounding points are seen (fig. 346, *d*), the expression of the alternating contractions of the three divisions of the heart, which are now in the course of formation,—the *sinus venosus* (fig. 339 *k*, 340 *l*), which receives the veins, and towards the end of the third day shows traces of the two auricles, the *ventricle* (339 *i*, 340 *m*), and the *bulbus aortæ* (339 *l*, 340 *n*), divided from the ventricle by a contraction. In this period the heart presents such diversities that it may be said to be in a state of ceaseless metamorphosis, both as regards form and position. On the second day, it is a somewhat spirally twisted canal lying under the brain (fig. 339, *i*); on the third day, it has drawn itself more backwards, become more concentrated, and bent round, as it were, into a kind of loop (fig. 340, *m*), when it appears to project in the form of a tumour between the ventral laminae (figs. 340 *m*, and 341 *h*), first inclining to the left and then to the right, and being all the while within the compass of the involucrem capitis (fig. 347, *f*). The ventricle, which during the third day is still canalicular, becomes more globular on the fourth day (fig. 345, *h*), and pointed underneath, so that it acquires the proper heart-shape (fig. 342, B, *g*); it then lies very much to the right, whilst the sinus venosus, which is become more distinct from it, lies more to the left (fig. 345, behind *h*). At the end of the third day, the constriction between the ventricle and aortal bulb is already well marked (fig. 340, *n*). On the fourth day, the muscular mass of the heart and the septum ventriculorum is produced; in the sinus venosus the septum is not begun to be formed till the fifth day, and the two apices into which the veins even on the third day were seen to plunge (fig. 340, below *l*), enlarge, and become the auricles. Some time before the bulbus aortæ becomes distinctly pinched off (fig. 347, *f*), it divides at the beginning of the third day into four pairs of vascular arches, which show themselves through the abdominal laminae, the most posterior of the four being the smallest (fig. 347, 1—4); after the formation of the branchial fissures they lie behind the sickle-shaped branchial arches (figs. 339, 340, 343, B); they unite on either side upon the vertebral column into an aortal root; the two roots blend more posteriorly, and form the common aorta (fig. 347, *h*). The vascular arches undergo considerable

changes in the course of the fourth day: the first pair gradually disappears and is at length obliterated, and the second becomes smaller; but on either side there is a fifth arch formed, which becomes larger on the fifth day, whilst the second now disappears; so that on this day there are three vascular arches present, all of nearly equal magnitude (fig. 342, A, h^1 , h^2 , h^3). The carotid, and by and by the vertebral, arteries now make their appearance, arising from the aortal roots,

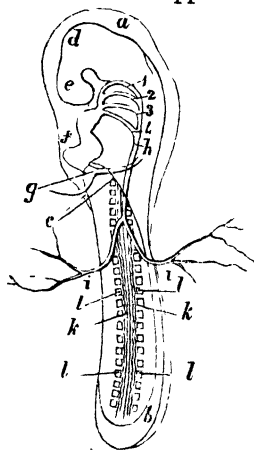

Fig. 347 — Embryo of the yolk depicted in fig. 348, seen from the abdominal aspect, magnified. *a*, Vagina s. involucrem capitis; *b*, vagina s. involucrem caude (*a* and *b*, folds of the germinal membrane enveloping the head and tail); *c, c*, anterior passage of the involucrem capitis into the lateral involucre; *d*, vault of the mass appertaining to the corpora quadrigemina; *e*, anterior cerebral mass or lobe; *f*, heart; *g*, termination of the venous trunks in the future atrium cordis; *h*, aorta; 1, 2, 3, 4, the four branchial arteries; *i, i*, arteries of the blastodermis; *k, k*, translucent crests of the dorsal laminæ, rendered somewhat wavy by the water in which the embryo is immersed; *l, l*, vertebral aminæ.

and the bulbus aortæ undergoes a division into two passages. On the fourth day the aorta gives off distinct vessels between the several divisions of the vertebræ; it then divides and furnishes two principal branches, which go off in transverse directions (figs. 348 *c*, 347 *i, i*, 339 *m, m*, 346, *f, f*), and splitting into branchlets, form an extremely beautiful network upon the outspread germinal membrane; the aorta afterwards proceeds, first divided and then single, along the vertebral column, gives off a mesenteric artery (figs. 338, 343, B, *d* 5), and finally splits into two branches that ramify upon the allantois (figs. 341, 345, *n*). Almost simultaneously with the formation of the arteries an accompanying system of veins is developed; the veins of the germinal mem-

brane, however, are so far in opposition to the arteries, that whilst these are directed transversely towards the sinus terminalis (fig. 346, *f, f*), those run parallel with the long axis of the embryo; one inferior, larger vein lying on the left (figs. 346, *g, g*, 339, *k*²), to which comes a second, smaller, often scarcely perceptible one, situated on the right, and either one or two superior veins (figs. 346, *g, g*, 339, *k*¹) bringing the blood from the vascular area to the heart. The system of the venæ cavæ is evolved in the body of the embryo at a still earlier period than the arterial system, and the portal system is distinctly separated on the fourth day, and ramifying

in the liver. The circulation upon the germinal membrane is, therefore, a vitellicular circulation; the blood courses from the embryo through the two arteriæ vitellinæ s. omphalo-mesentericæ (fig. 346, *f, f*), to the sinus terminalis or vascular circle, which on the fourth day appears quite full of blood; from this the blood is returned to the heart through the four venous trunks—the venæ vitellinæ s. omphalo-mesentericæ (fig. 346, *g, g, g*). The smallest arteries and veins also communicate with one another by their most delicate extremities, and form a beautiful rete with rhomboidal-shaped meshes.

[§ 491. There is a very peculiar formation belonging to the fœtus alone, and having a temporary or transitory character, which must now be mentioned, namely, the *Wolffian bodies*,—*corpora Wolffiana*, or primordial kidneys. These bodies are a product of the vascular membrane, though the serous layer would also seem to have some share in their formation. They make their first appearance in the second half of the third day, as a pair of narrow but thick striæ, which sprout

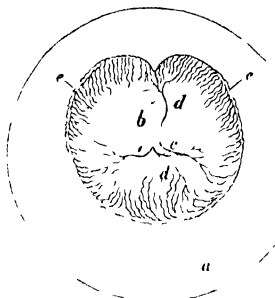

Fig. 348.—Yolk of the hen's egg, of the natural size, but flattened

showing on the same day of incubation, exhibiting the earliest traces of the circulation.—*a*, Vitellus; *b*, embryo; *c, c*, arteries of the blastoderma; *d, d*, veins of the blastoderma; *e, e*, sinus terminalis.

outwardly from each mesenteric lamina, in the angle formed between this and the ventral lamina in the line of the vertebral column, from the region of the heart as far as the allantois. Even at this early period they exhibit interchanging elevations and notches, and a canal or duct running in the line of their long axis. On the fourth day the corpora Wolffiana are recognized as being formed out of hollow cœcal-like appendages, which are attached along the course of the duct or canal (fig. 341, *q, q, q, q*); on the fifth day they look very broad and thick, and the cœcal appendages are convoluted. The germ-preparing sexual organs, the *testicles* and *ovaria*, make their appearance as delicate striæ on the inner sides of the corpora Wolffiana.

§ 492. The metamorphoses of the mucous layer of the germinal membrane begin, during this period, with the formation of the *intestinal canal*. After the mucous layer, above the involucrem capitis, has struck in under the head, and formed the *anterior access* to the intestinal canal, *fovea cardiaca*, the same layer also bends in at the opposite extremity, over the involucrem caudæ or caudal envelope, and here forms the posterior access to the intestine, *foveola inferior*; by the increased curvature of the embryo, and the growth of the ventral laminæ, these depressions form funnel-shaped hollows, which terminate, in blind extremities, towards the head and tail. Almost simultaneously with the formation of the branchial fissures, or perhaps a little earlier, the space between the fore end of the head and the heart grows thin, and the mouth and fauces break through, so that a free communication results betwixt the fovea cardiaca and the cavity of the amnion (fig. 343, *B, h*). The intestinum rectum, on the other hand (the posterior funnel-shaped involution of the mucous layer), continues longer closed. By the formation of the mesenteric laminæ the mucous layer is detached from the ventral laminæ, and pushed downwards (fig. 338, *A*, under *e*); as soon as the mesenteric laminæ have coalesced, the mucous layer also converges from both sides under the mesentery, and where it is accompanied by the prolongations of the vascular lamina, which proceed from the mesenteric laminæ, two new laminæ present themselves, the *intestinal laminæ*,—*laminæ intestinales*, which run perpendicularly downwards

(fig. 343, A, under *h*), and the mucous layer being thus bent inwards in a canalicular manner, forms the *intestinal cleft*—an open canal in communication with the yolk, running forwards funnel-shaped, towards the faucial cavity, and backwards in the same manner to the rectum. At the beginning of the fourth day the intestinal cleft has contracted, and exhibits but a very small opening, which, extending soon after into a canal or sac (fig. 341, *k, l*), passes over the peripheral mucous layer as the *intestinal canal* (fig. 343, B, *n*), and throws itself completely around the yolk. The oral and faucial cavity gapes widely, and extends into a narrower part or canal, the esophagus, from which, inferiorly and posteriorly, a diverticular sacculus sprouts (fig. 343, B, *i*), the first rudimentary appearance of the *lungs*; a little farther on, an elongated enlargement of the intestine is perceived, which indicates the situation of the future *stomach* (fig. 343, *k*); the intestine then expands, and goes off funnel-shaped towards the yolk (fig. 343, *n*, and in a later form, fig. 341, *k, l*), and in like manner towards the rectum, which still terminates in a blind sac; the limits between the small and large intestines are indicated by the evolution of a couple of diverticula—the *capita caeca*—towards the end of the third day. About the middle of the third day various other parts are indicated in connection with the intestinal canal, which enlarges in the places where these are to appear, and sprouts out towards or into the vascular layer; thus, two little hollow offsets show themselves as the rudiments of the *liver*, in which a venous net-work by and by appears, that resolves itself into the portal system. At the beginning of the fourth day the two lobes of the liver appear as lappets of some breadth (fig. 341, *i*), in which the composition, by means of an aggregation of blind sacs, is apparent somewhat later; another small offset, or bunch, also shows itself in the vascular layer, between the lobes of the liver; this is the rudimentary *pancreas*; it grows slowly, but, on the fifth day, when the *convolutions of the small intestine* begin to be formed, it has enlarged considerably; at this time the *spleen* also makes its appearance as a small red body. The pulmonic sac divides, and becomes more distinct, from the esophagus appearing first pinched off from that part, and then provided with a pedicle—the future *trachea*; on the fifth or sixth day the lung of the one side is completely distinct from that of the other, and each

is attached to the common pedicle by a particular branch, the future *bronchi*; the pedicle has farther extended, as the *trunk of the trachea*.

In the course of the first half of the third day, a small vesicular-looking protuberance arises from the *intestinum rectum* (fig. 339, *n*); this proves to be the *allantois*, which grows into the caudal involucre, and distends it. The allantois is covered externally with a stratum of the vascular layer (fig. 343, *B, e, d*), which it carries with it in its growth. The growth of this part is very rapid, in the course of the fourth day (figs. 341, 345, *n*) forcing its way through the caudal involucre, and the part by which it is attached being drawn out into a hollow pedicle. The external covering from the vascular layer shows ramifications of the aorta, which form a beautiful vascular rete. On the fifth day, the allantois presents itself as a large pedunculated bladder protruding from the umbilicus (fig. 344, *b*), which, bending to the right, has penetrated between the mesenteric and ventral lamina, and lies betwixt the amnion and the serous envelope. At this time, the allantois is nearly as large as the entire embryo (fig. 344), being almost five lines in diameter.*

THIRD PERIOD IN THE HISTORY OF THE DEVELOPMENT OF THE INCUBATED EGG: FROM THE COMMENCEMENT OF THE CIRCULATION IN THE ALLANTOIS TO THE EXCLUSION OF THE EMBRYO.

[§ 493. The third and last period comprises the interval from the sixth to the twenty-first day. The two first days, however, comprehend almost all of general physiological interest which happens in this period, so that a shorter review of the grand features of the changes which take place in the embryo and ovum through its course will be sufficient. If the egg be opened at the beginning of this period, it must be done with great care, as the albumen has now entirely disappeared, and the embryo lies close to the membrane of the shell; the vitellary membrane has become exceedingly thin, is very easily torn, and indeed is soon resolved entirely; the air-space at the blunt end of the egg has greatly increased in

* According to Rathke, the lungs are evolved from the first as a pair; he describes them, on the fourth day of the incubation, as two small, laterally compressed, thin laminae, tapering off from before backwards, and ending in a blunt point, which spring from the œsophagus.

size. The germinal membrane now extends over the whole of the yolk; or the mucous layer of this part has almost entirely grown around, and so given origin to a sac-like covering, the *vitellary sac* (vitelliculum, or vitellicle, Owen), which encloses the yolk; the vascular layer has grown around nearly two-thirds of the yolk. The sinus terminalis of this layer is now a mere seam in the periphery of the area vasculosa, and in the course of the next few days disappears entirely; the veins, and then the arteries of the vascular layer of the vitellary membrane, disappear somewhat later. On the other hand, the allantois is growing with great rapidity, and, on the

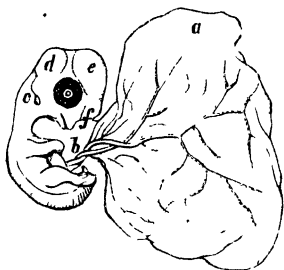

Fig. 349.—Embryo of the fowl with the allantois, *a*, already of great size, and depressed or flattened, the umbilical vessels, *b*, branching over it; *c*, external ear, indicated by a depression; *d*, cerebellum; *e*, corpora quadrigemina; *f*, hemispheres.

sixth day, forms a pretty large flattened bladder (fig. 349), which, however, in the course of the seventh day, acquires nearly twice its former size, and inclines so much to the right side, that with the amnion, it covers the embryo completely, and comes in contact superiorly by means of its most vascular side with the serous envelope, which is consequently now completely separated from the amnion, to the formation of which it had in the first instance contributed. After the rupture of the vitellary membrane, all that remains of the albumen collects at the sharp end of the egg, and is now much more consistent; the yolk, on the contrary, has become much thinner and more diffuent, and the number of its globules has very greatly diminished; the embryo lies more towards the blunt pole of the egg, and on the sixth day, after breaking open the shell, the first appearance of motion is observed in slight twitchings of the extremities.

[§ 494. The most remarkable metamorphoses of the individual organs on the sixth and seventh days are the following: the spinous processes are now formed on the vertebral arches;

the rudiments of the ribs become more conspicuous ; the immediate tegument of the brain and spinal cord is perceived to be

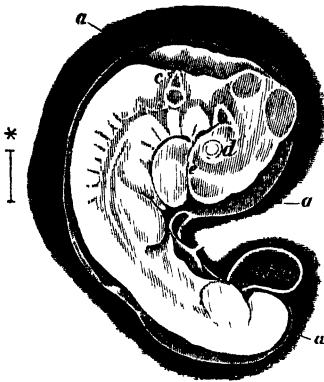

Fig. 350.—Embryo of the jackdaw (*corvus corone*) nearly four lines in length, drawn under the simple lens. The amnion, *a, a*, surrounds it closely on every side; the allantois, *b*, protrudes from the abdominal sulcus; the extremities are visible as simple lamellæ; numerous segments of the vertebræ and the several cerebral cells are conspicuous; behind the corpora quadrigemina appears the cerebellum, and then the depression for the fourth ventricle; the ear is seen as a pediculated vesicle, *c*, springing from the medulla oblongata; under it lie the branchial arches and fissures; *d* is the eye; *e*, the nasal fossa, behind which the heart is perceived.

composed of two layers; the largely developed corpora quadrigemina seem to advance with less rapidity of growth towards the end of the seventh day, and the hemispheres soon equal them in size (fig. 353, *c, c, d, d*); the fornix is evolved over the still open third ventricle; the corpora striata and thalami become conspicuous; the optic nerves, distinct from one another at first, now become connected in the chiasma; the infundibulum is still deep and wide; the pituitary body appears; the cerebellum is formed; but the fourth ventricle is still widely open, and passes over into a deep posterior furrow of the spinal cord. The eye is developed in every part, and is very large; the external opening of the ear is conspicuous, and in connexion with the auditory vesicle the semi-

circular canals and cochlea are formed; the nasal depression has lengthened downwards into a nasal passage, which runs between the superior maxillary bone and the frontal process, the opposite halves of which have now become united. In the extremities, the arm and thigh, both extremely short, can be distinguished; in the hand the rudiments of the three digits, and in the foot those of the four toes, can be made

out (fig. 352, B). The amnion is more and more distended, and at the umbilicus is brought more together, so that it becomes

drawn out into an umbilical cord, in which lie the peduncle of the allantois and a noose of the intestine (fig. 352, A, *b*); the neck advances in its evolution, and the lower jaw-bones

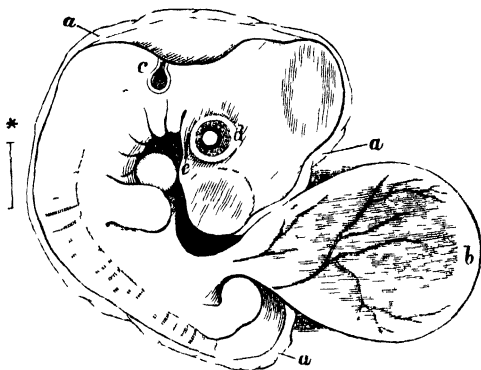

Fig. 351.—An embryo similar to the last, but somewhat further advanced. The references are the same as in fig. 350. The embryo is elongated and assume the fashion of a beak. The heart acquires the form it possesses in after-life, the several parts having approximated and become more closely conjoined: the auricles are divided, and cover the ventricles, which can now even from without be perceived to be double; the aortal bulb at the same time appears produced from both ventricles in an arched form, arising directly over the septum, and being divided into two canals, the separation between which becomes visible outwardly on the seventh day; the pericardium is formed. From the aorta there now arise but two vascular arches on either side, and to the right a middle third arch; this and the two anterior arches are the later chief divisions of the aorta, and are filled by the stream of blood transmitted from the left ventricle; the two posterior arches are supplied on the seventh day with blood exclusively from the right ventricle of the heart, and are the future pulmonary arteries; the arches all terminate in the descending aorta. The Wolffian bodies, and the formations that take place upon or in connexion with them, have many remarkable relations during this period. The shut sacs of which

they are composed become longer and more tortuous; they evidently secrete, and with their elongated common ducts, to

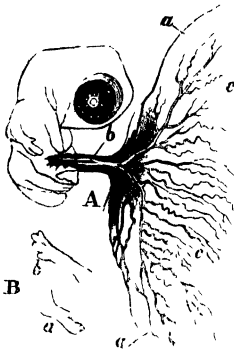

Fig. 352.—Chick with part of the yolk, *a, a*, which communicates, by means of the delicate vitello-intestinal duct, with the noose of the jejunum *b*, which at this time lies within the funis umbilicalis; *c, c*, vasa lutea. *B*, separate views of the anterior extremity, which shows a distinct division into three digits, *a*, and of the posterior extremity, which shows traces of four digits, *b*.

which they look as if they were attached, terminate in the cloaca; betwixt their component shut sacs numbers of small points, which consist of little convoluted hanks of vessels, in every particular like the Malpighian bodies of the kidney, may be observed. The kidneys show themselves behind and above the Wolffian bodies on either side of the spinal column; at first they are lobulated greyish masses, which sprout by the outer edges of the Wolffian bodies; this is plainly to be seen on the sixth day, perhaps even sooner; the ureters are formed afterwards as their especial excretory ducts. The kidneys arise as independent formations; and, independently of them, the capsulæ supra-renales are evolved on their upper or anterior edge. The reproductive organs, which had appeared as little marginal lappets, now form two longish-shaped white bodies, and lie behind the supra-renal capsules, at some little distance from these, on the inner edge of the Wolffian body; they are still of like size, and it is impossible to distinguish whether testicles or ovaria will be produced; so that of all the principal organs the genital are those that are the latest recognizable in their rudiments, and distinguishable in their future special forms. The vessels of the allantois are developed with great vigour; two arteries arise from the aorta, and a large vein runs on the under edge of the liver to the vena cava, along with the

to which they look as if they were attached, terminate in the cloaca; betwixt their component shut sacs numbers of small points, which consist of little convoluted hanks of vessels, in every particular like the Malpighian bodies of the kidney, may be observed. The kidneys show themselves behind and above the Wolffian bodies on either side of the spinal column; at first they are lobulated greyish masses, which sprout by the outer edges of the Wolffian bodies; this is plainly to be seen on the sixth day, perhaps even sooner; the ureters are formed afterwards as their especial excretory ducts. The kidneys arise as independent formations; and, independently of them, the capsulæ supra-renales are

hepatic vein. The vessels of the allantois become the umbilical vessels.

The alterations that transpire in the mucous layer are of less moment: the organs already formed increase in size; the faucial cavity is elongated as the oral cavity in the bill-shaped maxillæ; the esophagus extends; the division into crop and muscular stomach is distinguishable; behind the loop for the duodenum, and which encloses the pancreas, the jejunum forms a noose of the same length and tenuity, which lies completely out of the abdomen within the umbilical cord, where, by means of a delicate short

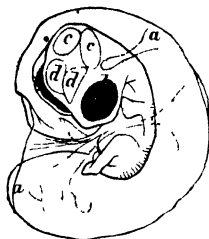

Fig. 353.—An embryo somewhat older than that represented in fig. 349, surrounded by the amnion as an ample vesicle; *a*, the amnion; the eyes, *b, b*, are very large; *c, c*, the corpora quadrigemina, now scarcely larger than the hemispheres *d, d*; the space between them is the third ventricle.

conduit, it communicates with the vitellicle or yolk-sac,—the *ductus vitello-intestinalis* (fig. 352, A, *a*). The liver is large and gorged with blood; the trachea and lungs are entirely separated from the esophagus; the larynx makes its appearance as a small enlargement upon the trachea.

[§ 495. The principal changes from the ninth to the eleventh day are as follow: the hemispheres of the brain enlarge greatly, at the cost, apparently, of the corpora quadrigemina, and span the third ventricle posteriorly; the cerebellum increases, particularly in its middle or vermiform portion, by which the fourth ventricle is now completely hidden; in the spinal cord the enlargements corresponding to the two pairs of extremities, become more conspicuous; the fibrous structure of the brain and spinal cord is apparent; the eyes proceed in their development, and attain still more colossal relative dimensions; the eyelids appear as a circular-shaped fold of the skin; the external organ of hearing increases in width and depth. The bulbs of the feathers become apparent in certain districts, first along the middle line of the back, upon the haunches, and over the rump; the joints of the extremities are more solidly

and distinctly evolved; the muscular parts are very apparent, and separated into bundles under the skin; the nerves are more conspicuous, and the motions of the embryo are stronger; the neck lengthens greatly. In the heart the external separation of the bulbous aortæ into two distinct canals follows; the vessel proceeding from the left ventricle gives off larger carotids from its anterior arches; on these appear the little thyroid bodies. These two aortal arches (*trunci anonymi*) represent the earlier third branchial vascular arch; the asymmetrical vascular arches appearing behind them, on the right side, is the future aorta descendens. From the stem arising out of the right ventricle proceed the two most posterior (the earlier fifth) of the branchial vascular arches; they do not yet give off any pulmonary branches, and still terminate posteriorly in the aorta; at a later period they become the proper pulmonary arteries. The corpora Wolffiana become shorter, and smaller every way, and their excretory duct longer; the kidneys increase in size. The germ-preparing sexual organs begin about this time to differ manifestly in their form: the testicles become elongated, cylindrical, and continue of equal size; the ovaries remain flattened, grow unequally, the right first ceasing to make any progress and then disappearing, the left enlarging proportionally with the other parts. The oviducts are distinct, but the right, like the ovary to which it corresponds, is arrested in its development. The gall-bladder becomes conspicuous as a diverticulum of the biliary duct. The *bursa Fabricii* emerges from the cloaca; the allantois grows still more over the embryo. The vessels on the vitellary membrane, especially on its under-surface, are numerous and large; the veins are turgid and tortuous (fig. 352, A, c), and appear stained of a yellow colour, whence they are often called *vasa lutea*.

[§ 496. It is in the course of the last days of the second week that the epidermic formations are produced—the feather bulbs, the nails, and the scaly coverings of the feet; ossification also begins in many bones, the muscular parts get stronger, the eyelids are well formed, and in the ear the tympanum has appeared. The Wolffian bodies are ever shorter and smaller; the testes acquire their excretory ducts; the left ovary is conspicuous, and the corresponding oviduct is hollow, whilst the same parts on the right side have shrunk entirely.

The intestine makes several turns outside of the umbilicus, and continues in communication with the vitellary sac by means of the vitellary duct; upon the inner surface of the vitellary sac, and over the tortuous veins, membranous productions—puckered or wrinkled folds—make their appearance; and at the same time similar formations occur upon the mucous membrane of the intestine. The allantois has now grown completely around the embryo, so that the ovum—the vitellary sac, the remaining albumen, &c. included—is completely enveloped anew as it were, and will now retain its form even after the shell is removed (fig. 354, *b*; from the Kestrel—*Falco tinnunculus*); the serous covering disappears.

[§ 497. In the beginning of the third week, the embryo, straitened for room, from the transverse axis of the egg comes more and more into the long axis, which it finally fills; the head is turned towards the breast, and mostly lies under the right wing; the allantois has inclosed the whole embryo and vitellary sac, and

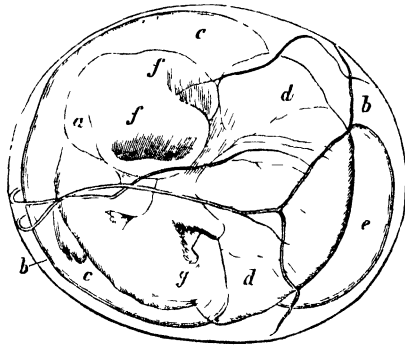

Fig. 354.—Embryo of the *Falco tinnunculus*, much farther advanced than that of the fig. 353. It is represented enclosed in its membranes, and of the natural size; but being removed from the shell, its weight has caused it to spread, and to look longer than it is in fact. The embryo of this falcon, by reason of the transparency of the membranes, is peculiarly fitted to serve for the demonstration of the relative position of the several parts: *a*, the embryo shining through the membranes; *f, f*, the eyes of great size, seen from above; *b, b*, the allantois, has grown completely around the embryo, and so forms a perfect envelope, the chorion, whose principal vascular branches are perceived; *c, c*, the amnion; *d, d*, the yolk-sac; *e*, the albumen; *g*, the coccyx, with the feathers beginning to sprout.

has inclosed the whole embryo and vitellary sac, and

having contracted adhesions with itself, forms an uninterrupted cyst or envelope for the entire contents of the egg, being everywhere in immediate contact with the membrane of the shell, from which it must be peeled when they are separated; in the interior of the allantois, white flocculent precipitates from the urine occur, and these accumulate at length to such an extent that they conceal the embryo in a greater or less degree. The allantois, as the complete foetal envelope, is entitled the chorion.

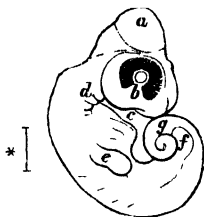

Fig. 355.—Magnified view of the embryo of the *Lacerta agilis*, two and a half lines in length, for contrast with the other embryos figured: *a*, corpora quadrigemina; *b*, cleft of the eye; *c*, olfactory depression; *d*, branchial fissures already disappearing; *e*, anterior extremity; *f*, hinder extremity; *g*, tail.

backwards under the hemispheres; the pineal gland and cerebellum increase; the latter becomes marked with deep scissures. Over the eye, the eyelids grow till they meet, but without uniting; the iris advances, the cornea rises, the lenticular prominence remains, whilst the lens recedes, and so the anterior chamber, which had hitherto been wanting, is produced; there is no appearance of pupillary membrane. In the ear, the labyrinth becomes osseous at the beginning of the third week. In the heart, the valvular system is evolved; the anterior arteries are detached more and more from the descending aorta, and disappear altogether towards the end of the period; the pulmonary arteries become much larger, and their terminations in the aorta have contracted and become mere anastomosing channels—*ductus arteriosi*. The kidneys grow rapidly. The corpora Wolffiana shrink continually, but in male embryos they may still be detected as rudiments near the testes, even after the epoch of foetal life is over. The right ovary, as has been stated, is arrested in its growth, and is soon after birth completely absorbed; the right oviduct also disappears, although a trace of it may be discovered in some birds at every period of their life. From

the testes delicate vasa efferentia are developed, which, after passing through the Wolffian bodies, unite into a filiform vas deferens, which in its turn is evolved out of, or, more correctly, into the excretory duct of the Wolffian body. The vitellary sac shrinks more and more, its contents diminishing in quantity, and becoming still more consistent. It is drawn into deep sacculated compartments by the main trunks of the umbilical vessels; the albumen and amniotic fluid are lessening continually in quantity. The tegumentary umbilicus is still freely open at the beginning of the last week; and with the advancing growth of the intestinal canal, a greater number of convolutions of the bowel pass out of the abdominal cavity; on the nineteenth day the prolapsed intestine returns in some degree into the abdomen again, and draws the yolk, with which it is still in uninterrupted connexion by means of the very considerable vitellary duct, along with it into the belly, upon which the mucous and vascular layers of the vitellary sac follow, whilst the serous layer increases, becomes thicker, and detaches itself from both the other layers. The whole vitellary sac is not thus taken up into the abdomen, only a part of it enters, and this expands in the cavity, whilst the part that is excluded is cut off by the contracting umbilical ring. The vitellary duct is of considerable width, and arises funnel-shaped from the intestine; long after birth there is still a little diverticulum of the jejunum to be discovered in its former situation; nay, in some birds this diverticulum continues through life as a normal feature in their structure. The communication with the vitellus is at length obliterated, becoming a mere thread, on which a yellow knot, the last remains of the yolk, may not unfrequently be observed.

BIRTH OF THE CHICK.

[§ 498. Two days before its exclusion, the chick may occasionally be heard chirping feebly within the shell, for the chorion (the allantois) is readily torn by the point of the beak, which then comes into contact with the air contained in the air-chamber; along with the imperfect respiration that now goes on, the circulation through the umbilical vessels proceeds unimpeded. The violent motions of the chick occasion cracks in the shell; the beak assists, and holes are produced. The bill, so soft in all other parts, is furnished at this period with

a very remarkable, hard, horny process near its point, evidently to enable the young creature to break through the shell, for the process in question falls off very shortly after the escape of the bird. The labour of getting free from the shell generally lasts half-a-day; at length the upper part is raised, the chick pushes out its feet, draws its head from under its wing, and erecting itself quits the shell completely. The remainder of the chorion and amnion, which, with the closure of the umbilicus, could no longer be nourished, shrivel, fall off, and are left behind in the shell.

PHYSICAL AND CHEMICAL CHANGES IN THE EGG DURING
INCUBATION.

[§ 499. Various physical and chemical changes take place in the egg during the period of incubation. It loses weight: in the first week, to the extent of five per cent.; in the second, the amount is thirteen per cent.; and in the third, sixteen per cent. So that an incubated egg, with an embryo ready to emerge from it, is altogether lighter than one that is just laid; a new-laid egg sinks in water,—an egg at the end of the period of incubation swims. The cause of this loss of weight lies in the evaporation of the watery part of the albumen; the same thing happens, though more slowly, in unincubated eggs from keeping; the greater rapidity of the loss in the incubated egg arises merely from the greater heat to which it is subjected. Another consequence of the evaporation is the formation and rapid enlargement of the air-space, which, as we have seen (§ 477), is first produced after the egg is laid. It is probable that the evaporation in question is connected with chemical changes, for the air contained in the blunt end of the egg is not simple atmospheric air, but contains a larger proportion of oxygen, the amount varying between twenty-five and twenty-seven per cent. This hyper-oxygenated air serves the embryo in the process of respiration, or aeration, that is carried on by the medium of the allantois; for eggs may be incubated to the perfect maturity of the embryo, even without the contact of the external atmospheric air, and may be hatched alike well in pure oxygen and in various irrespirable gases; for example, pure hydrogen, nitrogen, &c. At the beginning of the incubation the fluid albumen contains a small quantity of oil, apparently communicated

to it from the yolk ; when the incubation has advanced considerably, the albumen loses almost the whole of its water and salts ; these seem to be transferred to the yolk, which admits of explanation, for the vitellary sac bursts and draws the albumen, now changed into a thick mass, into it. By this accession of matter, the yolk enlarges during the first half of the period of incubation, but becomes thinner ; the incessant demand upon it, however, for materials for the growth of the embryo, causes it again to shrink and to become more consistent towards the end of the period (§ 494). The proportion of chemical elements of the vitellus and white vary considerably ; the quantity of phosphorus contained in the albumen lessens, but increases in the yolk, and again appears in combination with oxygen and calcium as a phosphate of lime, which in the period of ossification is plentifully required for the consolidation of the bones ; as the quantity of lime contained in an egg at the time it is laid is extremely small, and becomes very large at a subsequent period, the earth must be acquired in some way with which we are not at present well acquainted. As it is not very probable that the lime is derived from the shell, it may perhaps be produced from other matters under the influence of the organic agencies ; the same may be said of the iron, the quantity of which increases greatly during incubation.] *

* The whole of this article on the development of the chick is from Professor Wagner, Elements of Physiology, p. 84, *et seq.* It forms a valuable complement to the chapter on Embryology.—ED.

SECTION III.

ZOOLOGICAL IMPORTANCE OF EMBRYOLOGY.

§ 500. As a general result of the observations which have been made, up to this time, on the embryology of the various classes of the animal kingdom, especially of the vertebrata, it may be said, that the organs of the body are successively formed in the order of their organic importance, the most essential being always the earliest to appear. In accordance with this law, the organs of vegetative life, the intestines and their appurtenances, make their appearance subsequently to those of animal life, such as the nervous system, the skeleton, &c. ; and these, in turn, are preceded by the more general phenomena belonging to the animal as such.

§ 501. Thus we have seen that, in the fish, the first changes relate to the segmentation of the yolk and formation of the germ, which is a process common to all classes of animals. It is not until a subsequent period that we trace the dorsal furrow, which indicates that the forming animal will have a double cavity, and consequently belong to the division of the vertebrata ; an indication afterwards fully confirmed by the successive appearance of the brain and the organs of sense. Later still, the intestine is formed, the limbs become evident, and the organs of respiration acquire their definite form, thus enabling us to distinguish with certainty the class to which the animal belongs. Finally, after the egg is hatched, the peculiarities of the teeth, and the shape of the extremities, mark the genus and species.

§ 502. Hence the embryos of different animals resemble each other more strongly when examined in the earlier stages of their growth. We have already stated that, during almost the whole period of embryonic life, the young fish and the young frog scarcely differ at all : so it is also with the young snake compared with the embryo bird. The embryo of the crab, again, is scarcely to be distinguished from that of the insect ; and if we go still farther back in the history of development, we come to a period when no appreciable difference whatever is to be discovered between the embryos of the various departments. The embryo of the snail, when the

germ begins to show itself, is nearly the same as that of a fish or a crab. All that can be predicted at this period is, that the germ which is unfolding itself will become an animal; but the class and the group are not yet indicated.

§ 503. After this account of the history of the development of the egg, the importance of embryology to the study of zoology cannot be questioned. For evidently, if the formation of the organs in the embryo takes place in an order corresponding to their importance, this succession must of itself furnish a criterion of their relative value in classification. Thus, those peculiarities that first appear should be considered of higher value than those that appear later. In this respect, the division of the animal kingdom into four types, the vertebrata, the articulata, the mollusca, and the radiata, corresponds perfectly with the gradations displayed by embryology.

§ 504. This classification, as has been already shown, is founded essentially on the organs of animal life, the nervous system and the parts belonging thereto, as found in the perfect animal. Now, it results from the above account, that in most animals the organs of animal life are precisely those that are earliest formed in the embryo; whereas those of vegetative life, on which is founded the division into classes, orders, and families, such as the heart, the respiratory apparatus, and the jaws, are not distinctly formed until afterwards. Therefore a classification, to be true and natural, must accord with the succession of organs in the embryonic development. This coincidence, while it corroborates the anatomical principles of Cuvier's classification of the animal kingdom, furnishes us with new proof that there is a general plan displayed in every kind of development.

§ 505. Combining these two points of view, that of Embryology and that of Anatomy, the four divisions of the animal kingdom may be represented by the four figures which are to be found, at the centre of the diagram, at the beginning of the volume.

§ 506. The type of VERTEBRATA, having two cavities, one above the other, the former destined to receive the nervous system, and the latter, which is of a larger size, for the intestines, is represented by a double crescent united at the centre, and closing above, as well as below.

§ 507. The type of *ARTICULATA*, having but one cavity, growing from below upwards, and the nervous system forming a series of ganglions, placed below the intestine, is represented by a single crescent, with the horns directed upwards.

§ 508. The type of *MOLLUSCA* having also but one cavity, the nervous system being a simple ring around the esophagus, with ganglions above and below, from which threads go off to all parts, is represented by a single crescent with the horns turned down.

§ 509. Finally, the type of *RADIATA*, the radiating form of which is seen even in the youngest individuals, is represented by a star.

CHAPTER ELEVENTH.

PECULIAR MODES OF REPRODUCTION.

SECTION I.

GEMMIPAROUS AND FISSIPAROUS REPRODUCTION.

§ 510. WE have shown, in the preceding chapter, that ovulation, and the development of embryos from eggs is common to all classes of animals, and must be considered as the great process for the reproduction of species. Two other modes of propagation, applying, however, to only a limited number of animals, remain to be mentioned, namely, *gemmiparous* reproduction, or multiplication by means of buds, and *fissiparous* reproduction, or propagation by division, and also some still more extraordinary modifications yet involved in much obscurity.

§ 511. *Reproduction by buds* occurs among polyps, medusæ, and some infusoria. On the stalk, or even on the body of the *Hydra* (fig. 170), and of many infusoria (fig. 356), there are formed buds, like those of plants. On close examination they are found to contain young animals, at first very imperfectly formed, and communicating at the base with the parent body, from which they derive their nourishment. By degrees the animal is developed; in most cases the tube by which it is connected with the parent withers away, and the animal is thus detached, and becomes independent. Others remain through life united to the parent stalk, and in this respect present a more striking analogy to the buds of plants; but in polyps, as in trees, budding is only an accessory mode of reproduction, which presupposes a trunk already existing, originally the product of ovulation.

Fig. 356.



§ 512. *Reproduction by division*, or fissiparous reproduc-

tion, is still more extraordinary; it takes place only in polyps and some infusoria. A cleft, or fission, at some part of the body takes

Fig. 357

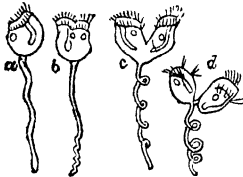
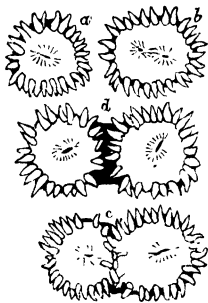

Fig. 358.



place, very slight at first, but constantly increasing in depth, so as to become a deep furrow, like that observed in the yolk, at the beginning of embryonic development; at the same time the contained organs are divided and become double, and thus two individuals are formed of one, so similar to each other that it is impossible to say which is the parent and which the offspring. The division takes place sometimes vertically, as, for example, in *Vorticella* (fig. 357, c, d), and in some polyps (fig. 358, a, d); and sometimes transversely. In some infusoria, the *Paramecia* for instance, this division occurs as often as three or four times in a day.

§ 513. In consequence of this same faculty many animals are able to reproduce various parts of their bodies when accidentally lost. It is well known that crabs and spiders, on losing a limb, acquire a new one. The same happens with the rays of star-fishes; the tail of a lizard is also readily reproduced; salamanders even possess the faculty of reproducing parts of the head, including the eye with all its complicated structure. Something similar takes place in our own bodies, when a new skin is formed over a wound, or when a broken bone is reunited.

§ 514. In some of the lower animals this power of reparation is carried much farther, and applies to the whole body, so as closely to imitate fissiparous reproduction. If an earth-worm or a fresh-water polype be divided into several pieces, the injury is soon repaired, each fragment speedily becoming a perfect animal. Something like this reparative faculty is seen in the vegetable as well as in the animal kingdom. A willow-branch, planted in a moist soil, throws out roots below and branches

above ; and thus, after a time, assumes the shape of a perfect tree.

§ 515. These various modes of reproduction do not exclude each other. All animals which propagate by gemmiparous or fissiparous reproduction also lay eggs. Thus the fresh-water polyps (*Hydra*) propagate both by eggs and by buds. In *Vorticella*, according to Ehrenberg, all three modes are found ; it is propagated by eggs, by buds, and by division. Ovulation, however, is the common mode of reproduction, the other modes, and also alternate reproduction, are only additional means employed by nature to secure the perpetuation of the species.

SECTION II.

ALTERNATE AND EQUIVOCAL REPRODUCTION.

§ 516. IT is a matter of common observation, that individuals of the same species have the same general appearance, by which their peculiar organization is indicated. The transmission of these characteristics, from one generation to the next, is justly considered as one of the great laws of the animal and vegetable kingdoms. It is, indeed, one of the points on which the definition of species is generally founded. We would, however, adopt the new definition of Dr. S. G. Morton, who defines species to be "primordial organic forms."

§ 517. But it does not follow that animals must resemble their parents in every condition, and at every epoch of their existence ; on the contrary, as we have seen, this resemblance is very faint in most species at birth, and some undergo complete metamorphoses before attaining their final shape, such as the caterpillar and the tadpole, the butterfly and the frog. Nevertheless, we do not hesitate to refer the tadpole and the frog to the same species ; and so with the caterpillar and the butterfly, because we know that there is the same individual observed in different stages of development.

§ 518. There is also another series of cases in which the offspring not only do not resemble the parent at birth, but moreover remain different during their whole life, so that their relationship is not apparent until a succeeding generation. The son does not resemble the father, but the grandfather ; and in some cases the resemblance reappears only at the fourth or fifth generation, and even later. This singular mode of reproduction has received the name of *alternate generation*.

The phenomena attending it have been of late the object of numerous scientific researches, which are the more deserving of our attention, as they furnish a solution of several problems alike interesting in a zoological and philosophical point of view.

§ 519. Alternate generation was first observed among the *Salpæ*, marine mollusca, without shells, belonging to the family tunicata. They are distinguished by the curious peculiarity of being united together in considerable numbers, so as to form long chains, which float in the sea (fig. 359), the mouth (*m*), however, being free in each. The individuals thus joined in floating colonies produce eggs; but in each animal there is generally but one egg formed, which is developed in the body of the parent, and from which is hatched a little mollusk (fig. 360), which remains solitary, and differs in many respects from the parent. This little animal, on the other hand, does not produce eggs, but propagates by a kind of budding, which gives rise to chains already seen within the body of the parent (*a*), and these again bring forth solitary individuals, &c.

Fig. 359.



Fig. 360.



§ 520. In some parasitic worms, alternate generation is accompanied by still more extraordinary phenomena, as shown by the late discoveries of Steenstrup, a Danish naturalist.

Fig. 361.



Among the numerous animals inhabiting stagnant pools, in which fresh-water-mollusca (particularly *Lymnæa* and *Paludina*) are found, there is a small worm, known to naturalists under the name of *Cercaria* (fig. 361). When examined with a lens, it looks much like a tadpole, with a long tail, a triangular head, and a large sucker (*a*) in the middle of the body. Various viscera appear within, and among others a very distinctly forked cord (*c*), embracing the sucker, and which is thought to be the liver.

§ 521. If we watch these worms, which always abound in company with the mollusks mentioned, we find them after a while attaching themselves, by means of their sucker, to the bodies of these animals. When fixed they soon undergo considerable alteration. The tail, which was previously employed for locomotion, is now useless, and falls off, and the animal surrounds itself with a mucous substance, in which it remains nearly motionless, like a caterpillar on its transformation into the pupa. If, however, after some time we remove the little animal from its retreat we find it to be no longer a *Cercaria*, but an intestinal worm called *Distoma*, with two suckers, having the shape of fig. 362. The *Distoma*, therefore, is only a particular state of the *Cercaria*, or rather the *Cercaria* is only the larva of the *Distoma*.

Fig. 362.



Fig. 363.



Fig. 364.

§ 522. What now is the origin of the *Cercaria*? The following are the results of the latest researches on this point. At certain periods of the year, we find in the viscera of the *Lymnæa* (one of the most common fresh-water mollusks) a quantity of little worms of an elongated form, with a well-marked head, and two posterior projections like limbs (fig. 363). On examining these worms attentively under the microscope we discover that the cavity of their body is filled by a mass of other little worms, which a practised eye easily recognizes as young *Cercariæ*, the tail and the other characteristic furcated organ (fig. 364, *a*) being distinctly visible within it. These little embryos increase in size, distending the worm containing them, and which seemingly has no other office than to protect and forward the development of the young *Cercariæ*. It is, as it were, their living envelope. On this account, it has been called the *nurse*.



§ 523. When they have reached a certain size, the young *Cercariæ* leave the body of the nurse, and move freely in the abdominal cavity of the *Lymnæa*, or escape from it into the

water to fix themselves, in their turn, to the body of another mollusk, and begin their transformations anew.

§ 524. But this is not the end of the series. The nurses of the *Cercaria* are themselves the offspring of little worms of yet another kind. At certain seasons, we find in the viscera of the *Lymnaea* worms somewhat like the nurses of the *Cercaria* in shape (fig. 365), but rather longer, more slender, and having a much more elongated stomach (*s*). These worms contain, in the hinder part of the body, little embryos (*a*), which are the young nurses of figures 363, 364. This generation has received the name of *grand-nurses*.

Fig. 365.



§ 525. Supposing these grand-nurses to be the immediate offspring of the *Distoma* (fig. 362), as is probable, we have thus a quadruple series of generation. Four generations and one metamorphosis are required to evolve the perfect animal; in other words, we find no resemblance to the parent in any of its progeny, until we arrive at the fourth generation or the great-grandson.

§ 526. Among the *Aphides*, or plant-lice, the number of generations is still greater. The first generation, which is produced from eggs, soon undergoes metamorphoses, and then gives birth to a second generation, which is followed by a third, and so on; so that it is sometimes the eighth or ninth generation before the perfect animals appear as males and females, the sexes being then for the first time distinct, and the males provided with wings. The females lay eggs which are hatched the following year, to repeat the same succession. Each generation is an additional step towards the perfect state; and as each member of the succession is an incomplete animal, we cannot better explain their office, than by considering them analogous to the larvæ of the *Cercaria*, that is, as nurses.*

* There is a certain analogy between the larvæ of the plant-louse (*Aphis*) and the neuters or working ants and bees. This analogy has given rise to various speculations, and, among others, to the following theory, which is not without interest. The end and aim of all alternate generation, it is said, is to favour the development of the species in its progress towards the perfect state. Among the plant-lice, as among all the nurses, this end is accomplished by means of the body of the nurse. Now a similar end is accomplished by the working ants and

§ 527. The development of the *Medusa* is not less instructive. According to the observations of M. Sars, a Norwegian naturalist, the *Medusa* brings forth living young, which, after having burst the covering of the egg, swim about freely for some time in the body of the mother. When born, these animals have no resemblance whatever to the perfect *Medusa*. They are little cylindrical bodies (fig. 366, *a*), much resembling infusoria, and like them covered with minute cilia, by means of which they swim with much activity.

§ 528. After swimming about freely in the water for some days, the little animal fixes itself by one extremity (fig. 366, *e*). At the opposite extremity a depression is gradually formed, the four corners (*b*, *f*) become elongated, and by degrees are transformed into tentacles (*c*). These tentacles rapidly multiply, until the whole of the upper margin is covered with them (*g*). Then transverse wrinkles are seen (*g*) on the body at regular distances, appearing first above and extending downwards. These wrinkles, which are at first very slight, grow deeper and deeper, and, at the same time, the edge of each segment begins to be serrated, so that the animal presents the appearance of a pine cone, surmounted by a tuft of tentacles (*h*);

Fig. 366.

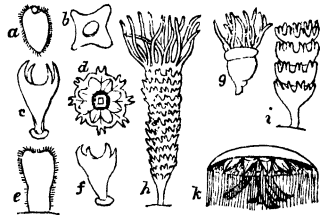

bees, only, instead of being performed as an organic function, it is turned into an outward activity, which makes them instinctively watch over the new generation, and nurse and take care of it. It is no longer the body of the nurse, but its own instincts, which become the instrument of the development. This seems to receive confirmation from the fact that the working bees, like the nurses of the plant-lice, are barren females. The attributes of their sex, in both, seem to consist only in their solicitude for the welfare of the new generation, of which they are the natural guardians, but not the parents. The task of bringing forth young is confided to other individuals, to the queen among the bees, and to the female of the last generation among the plant-lice. Thus the barrenness of the working bees, which seems an anomaly as long as we consider them complete animals, receives a very natural explanation so soon as we regard them merely as nurses.

whence the name of *Stroöila*, which was originally given to it, before it was known to be only a transient state of the jelly-fish. The separation constantly goes on, until at last the divisions are united by only a very slender axis, resembling a pile of cups placed within each other (*i*). The divisions are now ready for separation; the upper ring first disengages itself, and then the others in succession.* Each segment (*d*) then continues its development by itself, until it becomes a complete *Medusa* (*k*); while, according to recent researches, the basis or stalk remains and produces a new colony.

§ 529. It is thus, by a series of metamorphoses, that the little animal which, on leaving the egg, has the form of the infusoria, passes in succession through all the phases we have described. But the remarkable point in these metamorphoses is, that what was at first a single individual is thus transformed, by tranverse division, into a number of entirely distinct animals, which is not the case in ordinary metamorphoses. Moreover, the upper segment does not follow the others in their development. Its office seems to be accomplished as soon as the other segments begin to be independent; being intended merely to favour their development, by securing and preparing the substances necessary to their growth. In this respect it resembles the nurse of the *Cercaria*.

§ 530. The Hydraform-Polyps present phenomena no less numerous and strange. The *Campanularia*

Fig. 367.



has a branching, plant-like form, with little cup-shaped cells on the ends and in the axils of the branches, each of which contains a little animal. These cups have not all the same organization. Those at the extremity of the branches (*a*), and which appear first, are furnished with long tentacles, wherewith they seize their food (fig. 367). Those in the axils of the branches, and which appear late, are females (*b*), and have no such tentacles. Inside of the latter, little spherical bodies are found, each

* These free segments have been described as peculiar animals, under the name of *Ephyra*.

having several spots in the middle; these are the eggs. Finally, there is a third form, different from the two preceding, produced by budding from the female polyp, to which it in some way belongs (*c*). It is within this that the eggs arrive, after having remained some time within the female. Their office seems to be to complete the incubation, for it is always within them that the eggs are hatched.

§ 531. The little animal, on becoming free, has not the slightest resemblance to the adult polyp. As in the young *Medusa*, the body is cylindrical, and covered with delicate cilia (fig. 368). After having remained free for some time, the young animal fixes itself and assumes a flattened form. By degrees a little swelling rises from the centre, which elongates, and at last forms a stalk. This stalk ramifies, and we soon recognize in it the animal of fig. 367, with the three kinds of buds, which we may consider as three distinct forms of the same animal.

Fig. 368.



§ 532. The development of the *Campanularia* presents, in some respects, an analogy to what takes place in the reproduction of plants, and especially of trees. They should be considered as groups of individuals, and not as single individuals. The seed, which corresponds to the embryo of the polyp, puts forth a little stalk. This stalk soon ramifies by gemmiparous reproduction, that is, by throwing out buds which become branches. But ovulation, or reproduction by means of seeds, does not take place until an advanced period, and requires that the tree should have attained a considerable growth. It then produces flowers with pistils and stamens, that is, males and females, which are commonly united in one flower, but which in some instances are separated, as in the hickories, the elders, the willows, &c. &c.*

* Several plants are endowed with organs similar to the third form of the Polyps, as seen in the *Campanularia*: for example, the liverwort (*Marchantia polymorpha*), which has at the base of the cup a small receptacle, from the bottom of which little disk-like bodies are constantly forming, these, when detached, send out roots, and gradually become complete individuals. Besides that, we find in some polyps, as in plants, the important peculiarity, that all the individuals are united in a common trunk, which is attached to the soil; and that all are intimately dependent on each other, as long as they remain united. And if we compare, in this point of view, the various species in which alternate re-

SECTION III.

CONSEQUENCES OF ALTERNATE GENERATION.

§ 533. THESE various examples of alternate generation render it evident, that this phenomenon ought not to be considered as an anomaly in nature; but as the special plan of development, leading those animals in which it occurs to the highest degree of perfection of which they are susceptible. Moreover, it has been noticed among all types of the invertebrated animals; while among the vertebrata it is as yet unknown. It would seem that individual life in the lower animals is not defined within such precise limits as in the higher types, owing, perhaps, to the greater uniformity and independence of their constituent elements, the cells; and that instead of passing at one stride, as it were, through all the phases of their development, in order to accomplish it, they must either be born in a new form, as in the case of alternate generation, or undergo metamorphoses, which are a sort of second birth.

§ 534. Many analogies may be discovered between alternate reproduction and metamorphosis. They are parallel lines leading to the same end, namely, the development of the species. Nor is it rare to see them coexisting in the same animal. Thus, in the *Cercaria*, we have seen an animal produced from a nurse afterwards transformed into a *Distoma*, by undergoing a regular metamorphosis.

§ 535. In each new generation, as in each new metamorphosis, a real progress is made, and the form which results is more perfect than its predecessor. The nurse that produces the *Cercaria* is manifestly an inferior state, just as the chrysalis is inferior to the butterfly.

production has been observed, we find that the progress displayed in each type consists precisely in the increasing freedom of the individual in its various forms. At first, we have all the generations united in a common trunk, as in the lower polyps and in plants; then in the *Medusa* and in some of the hydraform polyps (the *Coryne*), the third generation begins to disengage itself. Among some of the intestinal worms (the *Distoma*), the third generation is enclosed within its nurse, and this in its turn is contained in the body of the grand nurse, while the complete *Distoma* lives as a parasitic worm in the body of other animals, or even swims freely about in the larva state, as *Cercaria*. Finally, in the plant-lice, all the generations, the nurses as well as the perfect animals, are separate individuals.

§ 536. But there is this essential difference between the metamorphoses of the caterpillar and alternate reproduction, that in the former case, the same individual passes through all the phases of development; whereas, in the latter, the individual disappears, and makes way for another, which carries out what its predecessors had begun. It would give a correct idea of this difference to suppose that the tadpole, instead of being itself transformed into a frog, should die, having first brought forth young frogs; or that the chrysalis should, in the same way, produce young butterflies. In either case, the young would still belong to the same species, but the cycle of development, instead of being accomplished in a single individual, would involve two or more acts of generation.

§ 537. It follows, therefore, that the general practice of deriving the character of a species from the sexual forms alone, namely, the male and the female, is not applicable to all classes of animals; since there are large numbers whose various phases are represented by distinct individuals, endowed with peculiarities of their own. Thus, while in the stag the species is represented by two individuals only, stag and hind, the *Medusa*, on the other hand, is represented under the form of three different types of animals; the first is free, like the infusoria; the second is fixed on a stalk, like a polyp; and the third again is free, consisting in its turn of male and female. In the *Distoma* also, there are four separate individuals, the grand nurse, the nurse, the larva or *Cercaria*, and the *Distoma*, in which the sexes are not separate. Among the *Aphides* the number is much greater still.

§ 538. The study of alternate generation, besides making us better acquainted with the organization of animals, greatly simplifies our nomenclature. Thus, in future, instead of enumerating the *Distoma* and the *Cercaria*, or the *Strobila*, the *Ephyra* and the *Medusa*, as distinct animals belonging to different classes and families, only the name first given to one of these forms will be retained, and the rest be struck from the pages of zoology, as representing only the transitory phases of the same species.

§ 539. Alternate generation always pre-supposes several modes of reproduction, of which the primary is invariably by ovulation. Thus we have seen that the polyps, the medusæ, the salpæ, &c., produce eggs, which are generally hatched within the mother. The subsequent generation, on the con-

trary, is produced in a different manner, as we have shown in the preceding paragraphs; as among the medusæ, by transverse division; among the polyps and the salpæ, by buds, &c.

§ 540. The subsequent generations are moreover not to be regarded in the same light as those which first spring directly from eggs. In fact, they are rather phases of development than generations properly so called; they are either without sex, or females whose sex is imperfectly developed. The nurses of the *Distoma*, the *Medusa*, and the *Campanularia*, are barren, and have none of the attributes of maternity, except that of watching over the development of the species, being themselves incapable of producing young.

§ 541. Another important result follows from the above observations, namely, that the differences between animals which are produced by alternate generation are less, the earlier the epoch at which we examine them. No two animals can be more unlike, than an adult *Medusa* (fig. 366, *k*), and an adult *Campanularia* (fig. 367); they even seem to belong to different classes of the animal kingdom, the former being an acaleph, the latter a polyp. On the other hand, if we compare them when first hatched from the egg, they appear so much alike, that it is with the greatest difficulty they can be distinguished. They are then little infusoria, without any very distinct shape, and moving with the greatest freedom. The larvæ of certain intestinal worms, though they belong to a different department, have nearly the same form, at one period of their life. Further still, this resemblance extends to plants. The spores of certain sea-weeds have nearly the same appearance as the young polyp, or the young *Medusa*; and what is yet more remarkable, they are also furnished with cilia, and move about in a similar manner. But this is only a transient state. Like the young *Campanularia* and the young *Medusa*, the spore of the sea-weed is free only for a short time; it soon becomes fixed, and from that moment the resemblance ceases.

§ 542. Are we to conclude, then, from this resemblance of the different types of animals at the outset of life, that there is no real difference between them; or that the two kingdoms, the animal and the vegetable, actually blend because their germs are similar? On the contrary, we think nothing is better calculated to strengthen the idea of the original separation of the various groups, as distinct and independent

types, than the study of their different phases. In fact, a difference so wide as that between the adult *Medusa* and the adult *Campanularia* must have existed even in the young; only it does not show itself in a manner appreciable by our senses; the character by which they subsequently differ so much, being not yet developed. To deny the reality of natural groups, because of these early resemblances, would be to take the resemblance for the reality. It would be the same as saying that the frog and the fish are identical, because at one stage of embryonic life it is impossible, with the means at our command, to distinguish them.

§ 543. The account we have given above of the development, the metamorphoses, and the alternate reproduction of the lower animals, is sufficient to undermine the old theory of *spontaneous generation*, which was proposed to account for the presence of worms in the bodies of animals, for the sudden appearance of myriads of animalcules in stagnant water, and, under other circumstances, rendering their occurrence mysterious. We need only recollect how the *Cercaria* insinuates itself into the skin and the viscera of mollusca (§ 520, § 521), to understand how admission may be gained to the most inaccessible parts. Such beings occur even in the eye of many animals, especially of fishes; they are numerous in the eye of the common fresh-water perch of Europe.

§ 544. As to the larger intestinal worms found in other animals, the mystery of their origin has been entirely solved by recent researches. A single instance will illustrate their history:—At certain periods of the year the sculpins of the Baltic are infested by a particular species of *Tænia*, or tapeworm, from which they are free at other seasons. M. Eschricht found that, at certain seasons, the worms lose a great portion of the long chain of rings of which they are composed. On a careful examination he found that each ring contained several hundred eggs, which, on being freed from their envelope, float in the water. As these eggs are innumerable, it is not astonishing that the sculpins should occasionally swallow some of them with their prey. The eggs, being thus introduced into the stomach of the fish, find conditions favourable to their development; and thus the species is propagated, and at the same time transmitted from one generation of the fish to another. The eggs which are not swallowed are probably lost.

§ 545. All animals swallow, in the same manner, with their food, and in the water they drink, numerous eggs of such parasites, any one of which, finding in the intestine of the animal favourable conditions, may be hatched. It is probable that each animal affords the proper conditions for some particular species of worm ; and thus we may explain how it is that most animals have parasites peculiar to themselves.

§ 546. As respects the infusoria, we also know that most of them, the *Rotifera* especially, lay eggs. These eggs, which are extremely minute (some of them only 1-12,000th of an inch in diameter), are scattered everywhere in great profusion, in water, in the air, in mist, and even in snow. Assiduous observers have not only seen the eggs laid, but, moreover, have followed their development, and have seen the young animal forming in the egg, then escaping from it, increasing in size, and, in its turn, laying eggs. They have been able, in some instances, to follow them even to the fifth and sixth generation.

§ 547. This being the case, it is much more natural to suppose that the infusoria* are products of like germs, than to assign to them a spontaneous origin altogether incompatible with what we know of organic development. Their rapid appearance is not at all astonishing, when we reflect that some mushrooms attain a considerable size in a few hours, but yet pass through all the phases of regular growth ; and, indeed, since we have ascertained the different modes of generation among the lower animals, no substantial difficulties any longer exist to the axiom "*omne vivum ex ovo*" (§ 433).

* In this connection it ought to be remembered that a large proportion of the so-called *Infusoria* are not independent animals, but immature germs, belonging to different classes of the animal kingdom, and that many must be referred to the vegetable kingdom.

CHAPTER TWELFTH.

METAMORPHOSES OF ANIMALS.

§ 548. UNDER the name of metamorphoses are included those changes which the body of an animal undergoes after birth, and which are modifications, in various degrees, of its organization, form, and mode of life. Such changes are not peculiar to certain classes, as has been so long supposed, but are common to all animals without exception.

§ 549. Vegetables also undergo metamorphoses, but with this essential difference, that in vegetables the process consists in an addition of new parts to the old ones. A succession of leaves, differing from those which preceded them, comes on each season; new branches and roots are added to the old stem, and woody layers to the trunk. In animals the whole body is transformed, in such a manner that all the existing parts contribute to the formation of the modified body. The chrysalis becomes a butterfly; the frog, after having been herbivorous during its tadpole state, becomes carnivorous, and its stomach is adapted to this new mode of life; at the same time, instead of breathing by gills, it becomes an air-breathing animal, its tail and gills disappear, lungs and legs are formed, and finally it lives and moves upon the land.

§ 550. The nature, the duration, and importance of metamorphoses, and also the epoch at which they take place, are infinitely varied. The most striking changes naturally presenting themselves to the mind, when we speak of metamorphoses, are those occurring in insects. Not merely is there a change of physiognomy and form observable, or an organ more or less formed, but their whole organization is modified. The animal enters into new relations with the external world, while at the same time, new instincts are imparted to it. It has lived in water, and respired by gills; it is now furnished with tracheæ, and breathes air; it passes by with indifference objects which before were attractive, and its new instincts prompt it to seek conditions which would have been most per-

nicious during its former period of life. All these changes are brought about without destroying the individuality of the animal. The mosquito, which to-day haunts us with its shrill trumpet, and pierces us for our blood, is the same animal that, a few days ago, lived obscure and unregarded in stagnant water, under the guise of a little worm.

§ 551. Every one is familiar with the metamorphoses of the silk-worm. On escaping from the egg the little worm or caterpillar grows with great rapidity for twenty days, when it ceases to feed, spins its silken cocoon, casts its skin, and remains inclosed in its chrysalis state.* During this period of its existence most extraordinary changes take place. The jaws with which it masticated mulberry leaves are transformed into a coiled tongue, the spinning organs are reduced, the gullet is lengthened and more slender, the stomach, which was nearly as long as the body, is now contracted into a short bag, the intestine, on the contrary, becomes elongated and narrow; the dorsal vessel is shortened. The thoracic nervous ganglia approach each other, and unite into a single mass. Antennæ and palpi are developed on the head, and simple eyes are exchanged for compound ones. The muscles, which before were uniformly distributed, are now gathered into masses. The limbs are elongated, and wings spring forth from the thorax. More active motions then reappear in the digestive organs, and the animal, bursting the envelop of its chrysalis, issues in the form of a winged moth.

§ 552. The different external forms which an insect may

assume is well illustrated by one which is unfortunately too well known in this country, namely, the canker-worm (fig. 369). Its eggs are laid on posts and fences, or upon the branches of the apple, elm, and other trees. They are hatched about the time the tender leaves of these trees begin to unfold. The caterpillar (*a*) feeds on

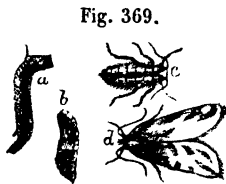

the leaves, and attains its full growth at the end of about four weeks, being then not quite an inch in length. It then descends to the ground, and enters the earth to the depth of

* In the raising of silk-worms this period is not waited for, but the animal is killed as soon as it has spun its cocoon.

four or five inches, and having excavated a sort of cell, is soon changed into a chrysalis or nymph (*b*). At the usual time in the spring it bursts the skin, and appears in its perfect state, under the form of a moth (*d*). In this species, however, only the male has wings. The perfect insects soon pair, the female (*c*) crawls up a tree and having deposited her eggs, dies.

§ 553.

Transformations no less remarkable are observed among the crustacea. The metamorphoses in the class cirrhipoda are especially

striking. It is now known that the barnacles (*Balanus*), which have been arranged among the mollusca, are truly crustaceans; and this result of modern researches has been deduced in the clearest manner from the study of their transformations. Figures 370, *a*—*f*, represent the different phases of development of the duck-barnacle (*Anatifa*).

§ 554. The *Anatifa*, like all crustacea, is reproduced by eggs, specimens of which, magnified ninety diameters, are represented in fig. 370, *a*. From these eggs little animals issue, which have not the slightest resemblance to the parent. They have an elongated form (*b*), a pair of tentacles, and four legs, with which they swim freely in the water.

§ 555. Their freedom, however, is of but short duration. The little animal soon attaches itself by means of its tentacles, having previously become covered with a transparent shell, through which the outlines of the body, and also a very distinct eye, are easily distinguished (*c*). Fig. 370, *d*, shows the animal taken out of its shell. It is plainly seen that the anterior portion has become considerably enlarged; subsequently, the shell becomes completed, and the animal casts its

Fig. 370.

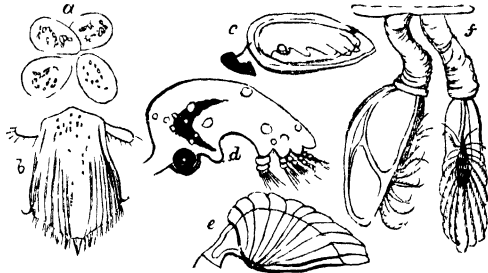

skin, losing with it both its eyes and its tentacles. On the other hand, a thick membrane lining the interior of the shell, pushes out and forms a stem (*e*), by means of which the animal fixes itself to immersed bodies, after the loss of its tentacles. This stem gradually enlarges, and the animal soon acquires a definite shape, such as is represented in fig. 370, *f*, attached to a piece of floating wood.

§ 556. There is, consequently, not only a change of organization in the course of the metamorphoses, but also a change of faculties and mode of life. The animal, at first free, becomes fixed; and its adhesion is effected by totally different organs at different periods of life, first by means of tentacles, which were temporary organs, and afterwards by means of a fleshy stem, especially developed for that purpose.

§ 557. The radiata also furnish us with examples of various metamorphoses, especially among the star-fishes. A small species, living on the coast of New England (*Echinaster sanguinolentus*), undergoes the following phases (fig. 371).

Fig. 371.

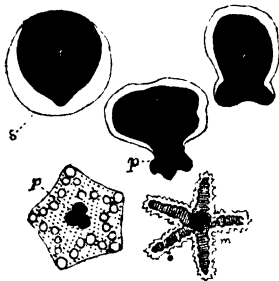

§ 558. If the eggs are examined by the microscope, each one is found to contain a small, pear-shaped body, which is the embryo (*e*), surrounded by a transparent envelope. On escaping from the egg the little animal has an oblong form, with

a constriction at the base; this constriction, becoming deeper and deeper, forms a pedicle, (*p*), which soon divides into three lobes. The disc also assumes a pentagonal form, with five double series of vesicles; the first rudiments of the rays, are seen to form in the interior of the pentagon. At the same time the peduncle contracts still more, being at last entirely absorbed into the cavity of the body, and the animal soon acquires its final form (*m*).

§ 559. Analogous transformations take place in the *Comatula*. In early life it is fixed to the ground by a stem (fig. 372), but becomes detached at a certain epoch, and then floats freely in the sea (fig. 373). On the other hand, the polypi

seem to follow a reverse course, many of them becoming permanently fixed after having been previously free.

§ 560. The metamorphoses of the mollusca, though less striking, are not less worthy of notice. Thus, the oyster, with which we are familiar in its adhering shell, is free when young, like the clam (*Mya*) and most other shell-fishes. Others, which are at first attached or suspended to the gills of the mother, afterwards become free, as the *Unio*. Some naked gasteropods, the *Acteon* and the *Eolis*, for example, are born with a shell, which they part with, shortly after leaving the egg.

§ 561. The study of metamorphosis is therefore of the utmost importance for understanding the real affinities of animals very different in appearance, as is readily shown by the following instances. The butterfly and the earth-worm seem, at the first glance, to have no relation whatever. They differ in their organization no less than in their outward appearance. But on comparing the caterpillar and the worm, these two animals are seen closely to resemble each other. The analogy, however, is only transient; it lasts only during the larva state of the caterpillar, and is effaced as it passes to the chrysalis and butterfly conditions. The latter becoming a more and more perfect animal, whilst the worm remains in its inferior state.

§ 562. Similar instances are furnished by animals belonging to all the types of the animal kingdom. Who would suppose, at the first glance, that a barnacle, or an anatif, were more nearly allied to the crab than to the oyster? And, nevertheless, we have seen (§ 553), in tracing back the anatif

Fig. 372.

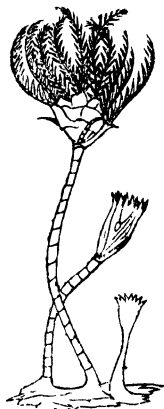
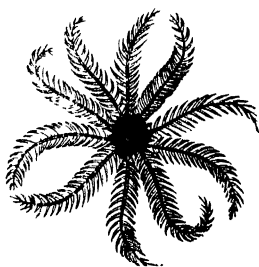

Fig. 373.



to its early stages, that it then bears a near resemblance to a little crustacean (fig. 370 *d*). It is only when full grown that it assumes its peculiar mollusk-like covering.

§ 563. Among the cuttle-fishes there are several, the *Loligo*, for example, which are characterized by the form of their tentacles, the two interior being much longer than the others, and of a different form; whilst, in others, as the *Octopus*, they are all equal. But if we compare the young, we find that in both animals the tentacles are all equal, though they differ in number. The inequality in the tentacles being the result of a further development.

§ 564. Among the radiata, the *Pentacrinus* and the *Comatula* exemplify the same point. The two are very different when full grown, the latter being a free-swimming star-fish (fig. 373), while the former is attached to the soil, like a polyp. But we have seen (§ 559) that the same is the case with *Comatula* in its early period; and that in consequence of a further metamorphosis, it becomes disengaged from its stem, and floats freely in the water.

§ 565. In the type of the vertebrata, the considerations drawn from metamorphoses acquire still greater importance in reference to classification. The sturgeon and the white-fish before mentioned (§ 463) are two very different fishes; yet, taking into consideration their external form and bearing merely, it might be questioned which of the two should take the highest rank; whereas, the doubt is very easily resolved by an examination of their anatomical structure. The white-fish has a skeleton, and moreover a vertebral column composed of firm bone. The sturgeon (fig. 374), on the con-

Fig. 374.



trary, has no bone in the vertebral column, except the spines or apophyses of the vertebræ. The middle part, or body of the vertebra, is cartilaginous; the mouth is transverse, and underneath the head; and the caudal fin is unequally forked, while, in the white-fish, it is equally forked.

§ 566. If, however, we observe the young white-fish just after it has issued from the egg (fig. 309), the contrast will be less striking. At this period the vertebræ are cartilaginous, like those of the sturgeon; its mouth also is transverse, and its tail undivided; at that period the white-fish and the sturgeon are therefore much more alike. But this similarity is only transient; as the white-fish grows, its vertebræ become ossified, and its resemblance to the sturgeon is comparatively slight. As the sturgeon has no such transformation of the vertebræ, and is in some sense arrested in its development, while the white-fish undergoes subsequent transformation, we conclude that, compared with the white-fish, it is really inferior in rank.

§ 567. This relative inferiority and superiority strikes us still more, when we compare with our most perfect fishes (the salmon, the cod &c.) some of those worm-like animals, so different from ordinary fishes that they were formerly placed among the worms. The *Amphioxus*, represented of its natural size (fig. 375), not only has no bony skeleton, but not even a head, properly speaking. Yet the fact that it possesses a dorsal cord, extending from one extremity of the body to the other, proves that it belongs to the type of the vertebrata (§ 458). But as this peculiar structure is found only at a very early period of embryonic development, in other fishes, we conclude that the *Amphioxus* holds the very lowest rank in this class.

Fig. 375.



§ 568. Nevertheless, the metamorphoses of animals after birth will, in many instances, present but trifling modifications of the relative rank of animals, compared with those which may be derived from the study of changes previous to that period, as there are many animals which undergo no changes of great importance after their escape from the egg, and occupy nevertheless a high rank in the zoological series, as, for example, birds and mammals. The question is, whether such animals are developed according to different plans, or whether their peculiarity in that respect is merely apparent. To answer this question, let us go back to the period anterior to birth, and see if some parallel may not be made out between the embryonic changes of these animals, and the metamorphoses which take place subsequently to birth in others.

§ 569. We have already shown that embryonic development consists in a series of transformations; the young animal enclosed in the egg differing, at each period of its development, from what it was before. But because these transformations precede birth, and are therefore not generally observed, they are not less important. To be satisfied that these transformations are in every respect similar to those which follow birth, we have only to compare the changes which immediately precede birth with those which immediately follow it, and we shall readily perceive that the latter are simply a continuation of the former, till all are completed.

§ 570. Let us recur to the development of fishes for illustration. The young white-fish, as we have seen (§ 471), is far from having acquired its complete development, when born. The vertical fins are not yet separate; the mouth has not yet its proper position; the yolk has not yet retreated within the cavity of the body, but hangs below the chest in the form of a large bag. Much, therefore, remains to be changed, before its development is complete. But the fact that it has been born does not prevent its future evolution, which goes on without interruption.

§ 571. Similar inferences may be drawn from the development of the chick. The only difference is, that the young chicken is born in a more mature state, the most important transformations having taken place during the embryonic period, while those to be undergone after birth are less considerable, though they complete the process begun in the embryo. Thus we see it, shortly after birth, completely changing its covering, and clothed with feathers instead of down; still later its crest appears, and its spurs begin to be developed.

§ 572. In certain mammals, known under the name of marsupials (the opossum and kangaroo), the link between the transformations which take place before birth, and those occurring at a later period, is especially remarkable. These animals are brought into the world so weak and undeveloped, that they have to undergo a second gestation, in a pouch with which the mother is furnished, and in which the young remain, each one fixed to a teat, until they are entirely developed. Even those animals which are born nearest to the complete states undergo, nevertheless, embryonic transformations. Ruminants acquire their horns; and the lion his mane. Most

mammals, at birth, are destitute of teeth, and incapable of using their limbs; and all are dependent on the mother and the milk secreted by her, until the stomach is capable of digesting other aliment.

§ 573. If it be thus shown that the transformations which take place in the embryo are of the same nature and of the same importance as those which occur afterwards, the circumstance that some precede and others succeed birth, cannot mark any radical distinction between them. Both are processes of the life of the individual. Now, as life does not commence at birth, but goes still farther back, it is quite clear that the modifications which supervene during the former period are essentially the same as the later ones; and hence that metamorphoses, far from being exceptional in the case of insects, are one of the general features of the animal kingdom.

§ 574. We are therefore perfectly entitled to say that all animals, without exception, undergo metamorphoses. Were it not so, we should be at a loss to conceive why animals of the same division present such wide differences; and that there should be, as in the class of reptiles, some families that undergo metamorphoses (the frogs, for example), and others in which nothing of the kind is observed after birth (the lizards and tortoises).

§ 575. It is only by connecting the two kinds of transformation—namely, those which take place before, and those after birth, that we are furnished with the means of ascertaining the relative perfection of an animal; in other words, these transformations become, under such circumstances, a natural key to the gradation of types. At the same time, they force upon us the conviction that there is an immutable principle presiding over all these changes, and regulating them in a peculiar manner in each animal.

§ 576. These considerations are important, not only from their bearing on classification, but not less so from the application which may be made of them to the study of fossils. If we examine attentively the fishes that have been found in the different strata of the earth, we remark that those of the most ancient deposits have in general preserved only the apophyses of their vertebræ, whilst the vertebræ themselves are wanting. Were the sturgeons to become petrified, they

would be found in a similar state of preservation. As the apophyses are the only bony portions of their vertebral column, they alone would be preserved. Indeed, fossil sturgeons are known, which are precisely in this condition.

§ 577. From the fact above stated, we may conclude that the oldest fossil fishes did not pass through all the metamorphoses which our osseous fishes undergo, and consequently that they were inferior to analogous species of the present epoch, which have bony vertebræ. Similar considerations apply to the fossil crustacea and to the fossil echinoderms, when compared with their living types; and it will probably be true of all classes of the animal kingdom, when they are fully studied as to their geological succession.

CHAPTER THIRTEENTH.

GEOGRAPHICAL DISTRIBUTION OF ANIMALS.

SECTION I.

GENERAL LAWS OF DISTRIBUTION.

§ 578. No animal, excepting man, inhabits every part of the surface of the earth. Each great geographical or climatal region is occupied by some species not found elsewhere; and each animal dwells within certain limits, beyond which it does not range while left to its natural freedom, and within which it always inclines to return, when removed by accident or design. Man alone is a cosmopolite; his domain is the whole earth; for him, and with a view to him, it was created; his right to it is based upon his organization and his relation to nature, and is maintained by his intelligence and the perfectibility of his social condition.

§ 579. A group of animals inhabiting any particular region, embracing all the species, both aquatic and terrestrial, is called its FAUNA, in the same manner as the plants of a country are called its FLORA. To be entitled to this name it is not necessary that none of the animals composing the group should be found in any other region; it is sufficient that there should be peculiarities in the distribution of the families, genera, and species, and in the preponderance of certain types over others, sufficiently prominent to impress upon a region well-marked features; thus, for example, in the islands of the Pacific are found terrestrial animals, altogether peculiar, and not found on the nearest continents. There are numerous animals in New Holland differing from any found on the continent of Asia, or, indeed, on any other part of the earth; if, however, some species, inhabiting both shores of a sea which separates two terrestrial regions, are found to be alike, we are not to conclude that those regions have the same Fauna, any more than that the Flora of Lapland and England

are alike, because some of the sea-weeds found on both their shores are the same.

§ 580. There is an evident relation between the fauna of any locality and its temperature, although, as we shall hereafter see, similar climates are not always inhabited by similar animals. Hence the faunas of the two hemispheres have been distributed into three principal divisions, namely the arctic, the temperate, and the tropical, in the same manner as we have arctic, temperate, and tropical floras; hence, also, animals dwelling at high elevations upon mountains, where the temperature is much reduced, resemble the animals of colder latitudes, rather than those of the surrounding plains.

§ 581. In some respects the peculiarities of the fauna of a region depends upon its flora, at least so far as land animals are concerned; for herbivorous animals will exist only where there is an adequate supply of vegetable food; but, taking the terrestrial and aquatic animals together, the limitation of a fauna is less intimately dependent on climate than that of a flora. Plants, in truth, are for the most part terrestrial (marine plants being relatively very few) while animals are chiefly aquatic. The ocean is the true home of the animal kingdom; and while plants, with the exception of the lichens and mosses, become dwarfed or perish under the influence of severe cold, the sea teems with animals of all classes, far beyond the extreme limit of flowering plants.

§ 582. The influence of climate, in the polar regions, acts merely to induce a greater uniformity in the species of animals. Thus, the same animals inhabit the northern polar regions of the three continents; the polar bear is the same in Europe, Asia, and America, and so are also a great many birds; in the temperate regions, on the contrary, the species differ on each of the continents, but they still preserve the same general features; the types are the same, but they are represented by different species. In consequence of these general resemblances, the first colonists of New England erroneously applied the names of European species to American animals. Similar differences are observed in distant regions of the same continent, within the same parallels of latitude. The animals of Oregon and of California are not the same as those of New England. The difference, in certain respects, is even greater than between the animals of New England and Europe. In like manner,

the animals of temperate Asia differ more from those of Europe than they do from those of America.

§ 583. Under the torrid zone the animal kingdom, as well as the vegetable, attains its highest development. The animals of the tropics are not only different from those of the temperate zone, but, moreover, they present the greatest variety among themselves. The most gracefully proportioned forms are found by the side of the most grotesque, decked with every combination of brilliant colouring. At the same time, the contrast between the animals of different continents is more marked; and, in many respects, the animals of the different tropical faunas differ not less from each other than from those of the temperate or frozen zones; thus, the fauna of Brazil varies as much from that of central Africa as from that of the United States.

§ 584. This diversity upon different continents cannot depend simply on any influence of the climate of the tropics; if it were so, uniformity ought to be restored in proportion as we recede from the tropics towards the antarctic temperate regions. But, instead of this, the differences continue to increase;—so much so, that no faunas are more in contrast than those of Cape Horn, the Cape of Good Hope, and New Holland. Hence other influences must be in operation besides those of climate;—influences of a higher order, which are involved in a general plan, and intimately associated with the development of life on the surface of the earth.

§ 585. Faunas are more or less distinctly limited, according to the natural features of the earth's surface. Sometimes two faunas are separated by an extensive chain of mountains, like the Rocky Mountains. Again, a desert may intervene, like the desert of Sahara, which separates the fauna of Central Africa from that of the Atlas and the Moorish coast, the latter of which is merely an appendage to the fauna of Europe. But the sea effects the most complete separation. The depths of the ocean are quite as impassable for marine species as high mountains are for terrestrial animals. It would be quite as difficult for a fish or a mollusk to cross from the coast of Europe to the coast of America, as it would be for a reindeer to pass from the arctic to the antarctic regions, across the torrid zone. Experiments of dredging in very deep water have also taught us that the abyss of the ocean is nearly a desert. Not only are no materials found there for sustenance,

but it is doubtful if animals could sustain the pressure of so great a column of water, although many of them are provided with a system of pores (§ 403), which enables them to sustain a much greater pressure than terrestrial animals.

§ 586. When there is no great natural limit, the transition from one fauna to another is made insensibly. Thus, in passing from the arctic to the temperate regions of North America, one species takes the place of another, a third succeeds the second, and so on, until finally the fauna is found to be an entirely new one, without its being always possible to mark the precise limit between the two.

§ 587. The range of species does not at all depend upon their powers of locomotion; if it were so, animals which move slowly and with difficulty would have a narrow range, whilst those which are very active would be widely diffused. Precisely the reverse of this is actually the case. The common oyster extends at least from Cape Cod to the Carolinas; its range is consequently very great; much more so than that of some of the fleet animals, as, for instance, the moose. It is even probable that the very inability of the oyster to travel, really contributes to its diffusion, inasmuch as having once spread over extensive grounds, there is no chance of its return to a former limitation, being fixed, and consequently unable to choose positions for its eggs, they must be left to the mercy of currents; while fishes, by depositing their eggs in the bays and inlets of the shore, undisturbed by currents and winds, secure them from too wide a dispersion.

§ 588. The nature of their food has an important bearing upon the grouping of animals, and upon the extent of their distribution. Carnivorous animals are generally less confined in their range than herbivorous ones; because their food is almost everywhere to be found. The herbivora, on the other hand, are restricted to the more limited regions corresponding to the different zones of vegetation. The same remark may be made with respect to birds. Birds of prey, like the eagle and vulture, have a much wider range than the granivorous and gallinaceous birds. Still, notwithstanding the facilities they have for change of place, even the birds that wander widest recognize limits which they do not overpass. The condor of the Cordilleras does not descend into the temperate regions of the United States; and yet it is not that he fears the cold, since he is frequently known to ascend

even above the highest summits of the Andes, and disappears from view where the cold is most intense. Nor can it be from lack of prey.

§ 589. Again, the peculiar configuration of a country sometimes determines a peculiar grouping of animals into what may be called local faunas. Such, for example, are the prairies of the West, the pampas of South America, the steppes of Asia, the deserts of Africa;—and for marine animals, the basin of the Caspian. In all these localities, animals are met with which exist only there, and are not found except under those particular conditions.

§ 590. Finally, to obtain a true picture of the zoological distribution of animals, not the terrestrial types alone, but the marine species must also be included. Notwithstanding the uniform nature of the watery element, the animals which dwell in it are not dispersed at random; and though the limits of the marine may be less easily defined than those of the terrestrial fauna, still marked differences between the animals of great basins are not less observable. Properly to apprehend how marine animals may be distributed into local faunas, it must be remembered that their residence is not in the high sea, but along the coasts of continents and on soundings. It is on the Banks of Newfoundland, and not in the deep sea, that the great cod-fishery is carried on; and it is well known that when fishes migrate, they run along the shores. The range of marine species being therefore confined to the vicinity of the shores, their distribution must be subjected to laws similar to those which regulate the terrestrial faunas. As to the fresh-water fishes, not only do the species vary in the different zones, but even the different rivers of the same region have species peculiar to them, and not found in neighbouring streams. The gar-pikes, *Lepidosteus*, of the American rivers, afford a striking example of this kind.

§ 591. A very influential cause in the distribution of aquatic animals is the depth of the water; so that several zoological zones receding from the shore may be defined according to the depth of water, much in the same manner as we mark different zones at different elevations in ascending mountains. The mollusks, and even the fishes found near the shore in shallow water differ, in general, from those living at the depth of twenty or thirty feet, and these again are found to be different from those which are met with at a greater depth. Their colouring,

in particular, varies, according to the quantity of light they receive, as has also been shown to be the case with marine plants.

§ 592. It is sometimes the case that one or more animals are found upon a certain chain of mountains, and not elsewhere; as, for instance, the mountain sheep (*Ovis montana*), upon the Rocky Mountains, or the chamois and the ibex upon the Alps. The same is also the case on some of the wide plains or prairies. This, however, does not entitle such regions to be considered as having an independent fauna, any more than a lake is to be regarded as having a peculiar fauna, exclusive of the animals of the surrounding country, merely because some of the species found in the lake may not ascend the rivers emptying into it. It is only when the whole group of animals inhabiting such a region has such peculiarities as to give it a distinct character, when contrasted with animals found in surrounding regions, that it is to be regarded as a separate fauna. Such, for example, is the fauna of the great steppe or plain of Gobi, in Asia; and such indeed that of the chain of the Rocky Mountains may prove to be, when the animals inhabiting them shall be better known.

§ 593. The migration of animals might at first seem to present a serious difficulty in determining the character or the limits of a fauna; but this difficulty ceases, if we regard the country of an animal to be the place where it makes its habitual abode. As to birds, which of all animals wander the farthest, it may be laid down as a rule, that they belong to the zone in which they breed. Thus, the gulls, many of the ducks, mergansers, and divers, belong to the boreal regions, though they pass a portion of the year with us. On the other hand, the swallows and martins, and many of the gallinaceous birds belong to the temperate faunas, notwithstanding their migration during winter to the confines of the torrid zone. This rule does not apply to the fishes, who annually leave their proper home, and migrate to a distant region merely for the purpose of spawning. The salmon, for example, comes down from the North to spawn on the coasts of Maine, Nova Scotia, and the British isles.

§ 594. Few of the Mammals, and these mostly of the tribe of rodents, make extensive migrations. Among the most remarkable of these are the Kamtschatka rats. In spring they direct their course westward, in immense troops; and

after a very long journey return again in autumn to their quarters, where their approach is anxiously awaited by the hunters, on account of the fine furs to be obtained from the numerous carnivora which always follow in their train. The migrations of the Lemmings are marked by the devastations they commit along their course, as they come down from the borders of the Frozen Ocean to the valleys of Lapland and Norway; but their migrations are not periodical.

SECTION II.

DISTRIBUTION OF THE FAUNAS.

§ 595. WE have stated that all the faunas of the globe may be divided into three groups, corresponding to as many great climatal divisions, namely, the glacial or arctic, the temperate, and the tropical faunas. These three divisions appertain to both hemispheres, as we recede from the equator towards the north or south poles. It will hereafter be shown that the tropical and temperate faunas may be again divided into several zoological provinces, depending on longitude or on the peculiar configuration of the continents.

§ 596. No continent is better calculated to give a correct idea of distribution into faunas, as determined by climate, than the continent of America; extending as it does across both hemispheres, and embracing all latitudes, so that all climates are represented upon it, as shown by the chart on the following page.

§ 597. Let a traveller embark at Iceland, which is situated on the borders of the polar circle, with a view to observe, in a zoological aspect, the principal points along the eastern shore of America. The result of his observations will be very much as follows. Along the coast of Greenland and Iceland, and also along Baffin's Bay, he will meet with an unvaried fauna composed throughout of the same animals, which are also for the most part identical with those of the arctic shores of Europe. It will be nearly the same along the coast of Labrador.

§ 598. As he approaches Newfoundland, he will see the landscape, and with it the fauna, assuming a somewhat more varied aspect. To the wide and naked or turfy plains of the boreal regions succeed forests, in which he will find various animals dwelling only therein. Here the temperate fauna



CHART OF ZOOLOGICAL REGIONS.

commences. Still the number of species is not yet very considerable; as he advances southward, along the coasts of Nova Scotia and New England, he finds new species gradually introduced, while those of the colder regions diminish, and at length entirely disappear, some few accidental or periodical visitors excepted, who wander during winter as far south as the Carolinas.

§ 599. But it is after having passed the boundaries of the United States, among the Antilles, and more especially on the southern continent, along the shores of the Orinoco and the Amazon, that our traveller will be forcibly struck with the astonishing variety of the animals inhabiting the forests, the prairies, the rivers, and the sea-shores, most of which he will also find to be different from those of the northern continent. By this extraordinary richness of new forms, he will become sensible that he is now in the domain of the tropical fauna.

§ 600. Let him still travel on beyond the equator towards the tropic of Capricorn, and he will again find the scene change as he enters the regions where the sun casts his rays more obliquely, and where the contrast of the Seasons is more marked. The vegetation will be less luxuriant; the palms will have disappeared to make place for other trees; the animals will be less varied, and the whole picture will recall to him, in some measure, the scene which he witnessed in the United States. He will again find himself in the temperate region, and this he will trace on, till he arrives at the extremity of the continent, the fauna and the flora becoming more and more impoverished as he approaches Cape Horn.

§ 601. Finally, we know that there is a continent around the South Pole. Although we have as yet but very imperfect notions respecting the animals of this inhospitable clime, still the few which have already been observed there, present a close analogy to those of the arctic region. It is another glacial fauna, namely, the antarctic. Having thus sketched the general distribution of the faunas, it remains to point out the principal features of each.

§ 602. I. ARCTIC FAUNA.—The predominant feature of the Arctic Fauna is its uniformity. The species are few; but, on the other hand, the number of individuals is immense. We need only refer to the clouds of birds which

hover upon the islands and shores of the North; the shoals of fishes, the salmon, among others, which throng the coasts of Greenland, Iceland, and Hudson's Bay. There is uniformity also in the form and colour of these animals. Not a single bird of brilliant plumage is found, and few fishes with varied hues. Their forms are regular, and their tints as dusky as the northern heavens. The most conspicuous animals are the white bear, the moose, the reindeer, the musk-ox, the white fox, the polar hare, the lemming, and various seals; but the most important are the whales, which, it is to be remarked, rank lowest of all the mammals. Among the birds, may be enumerated some sea-eagles and a few waders, while the great majority are aquatic species, such as gulls, cormorants, divers, petrels, ducks, geese, gannets, &c., all belonging to the lowest orders of birds. Reptiles are altogether wanting. The articulata are represented by numerous marine worms, and by minute crustaceans of the orders isopoda and amphipoda. Insects are rare, and of inferior types. Of the mollusca, there are acephala, particularly tunicata, fewer gasteropods, and very few cephalopods. Among the radiata are a great number of jelly-fishes, particularly the *Beroe*; and to conclude with the echinoderms, there are several star-fishes and echini, but few holothuriæ. The class of polypi is very scantily represented, and those producing stony corals are entirely wanting.

§ 603. This assemblage of animals is evidently inferior to that of other faunas, especially to those of the tropics. Not that there is a deficiency of animal life; for if the species are less numerous, there is a compensation in the multitude of individuals, and also in this other very significant fact, that the largest of all animals, the whales, belong to this fauna.

§ 604. It has already been said (§ 602) that the arctic fauna of the three continents is the same; its southern limit, however, is not a regular line. It does not correspond precisely with the polar circle, but rather to the isothermal zero, that is, the line where the average temperature of the year is at 32° of Fahrenheit. The course of this line presents numerous undulations. In general, it may be said to coincide with the northern limit of trees, so that it terminates where forest vegetation succeeds the vast arid plains, the barrens of North America, or the *tundras* of the Samoyedes. The uniformity of these plains involves a corresponding uniformity of plants and animals. On the North American continent it extends

much farther southward on the eastern shore, than on the western. From the peninsula of Alashka it bends northwards towards the Mackenzie, then descends again towards the Bear Lake, and comes down near to the northern shore of Newfoundland.

§ 605. II. TEMPERATE FAUNAS.—The faunas of the temperate regions of the northern hemisphere are much more varied than that of the arctic zone. Instead of consisting mainly of aquatic tribes, we have a considerable number of terrestrial animals of graceful form, animated appearance, and varied colours, though less brilliant than those found in tropical regions. Those parts of the country covered with forests especially swarm with insects, which become the food of other animals: worms, terrestrial and fluviatile mollusca are also abundant.

§ 606. Still, the climate is not sufficiently warm over the whole extent of this zone to allow the trees to retain their foliage throughout the year. At its northern margin the leaves, excepting those of the pines and spruces, fall, on the approach of the cold season, and vegetation is arrested for a longer or shorter period. Insects retire, and the animals which live upon them no longer find nourishment, and are obliged to migrate to warmer regions, on the borders of the tropics, where, amid the ever-verdant vegetation, they find the means of subsistence.

§ 607. Some of the herbivorous mammals, the bats, and the reptiles which feed on insects, pass the winter in a state of torpor, from which they awake in spring. Others retire into dens, and live on the provisions they have stored up during the warm season. The carnivora, the ruminants, and the most active portion of the rodents, are the only animals that do not change either their abode or their habits. The fauna of the temperate zone thus presents an ever-changing picture, which may be considered as one of its most important features, since these changes recur with equal constancy in the Old and the New World.

§ 608. Taking the contrast of the vegetation, as a basis, and the consequent changes of habit imposed upon the denizens of the forests, the temperate fauna has been divided into two regions; a northern one, where the trees, except the pines, drop their leaves in winter, and a southern one, where they are evergreen. Now, as the limit of the former, that of

the deciduous trees, coincides, in general, with the limit of the pines, it may be said that the cold region of the temperate fauna extends as far as the pines. In the United States this coincidence is not so marked as in other regions, inasmuch as the pines along the Atlantic coast extend into Florida, while they do not prevail in the Western States; but we may consider as belonging to the southern portion of the temperate region, that part of the country south of the latitude where the palmetto or cabbage-tree (*Chamærops*) commences, namely, all the States to the south of North Carolina; while the States to the north of this limit belong to the northern portion of the temperate region.

§ 609. This division into two zones is supported by observations made on the maritime faunas of the Atlantic coast. The line of separation between them, however, being influenced by the Gulf Stream, is considerably farther to the north;—namely, at Cape Cod: although there is also another decided limitation of the marine animals at a point nearly coinciding with the line of demarcation above-mentioned, namely, at Cape Hatteras. It has been observed, that of one hundred and ninety-seven mollusca inhabiting the coast of New England, fifty do not pass to the north of Cape Cod, and eighty-three do not pass to the south of it; only sixty-four being common to both sides of the Cape. A similar limitation of the range of fishes has been noticed by Dr. Storer; and Dr. Holbrook has found the fishes of South Carolina to be different from those of Florida and the West Indies. In Europe, the northern part of the temperate region extends to the Pyrenees and the Alps; and its southern portion consists of the basin of the Mediterranean, together with the northern part of Africa, as far as the desert of Sahara.

§ 610. A peculiar characteristic of the faunas of the temperate regions in the northern hemisphere, when contrasted with those of the southern, is the great similarity of the prevailing types on both continents. Notwithstanding the immense extent of country embraced, the same stamp is everywhere exhibited. Generally, the same families, frequently the same genera, represented by different species, are found. There are even a few species of terrestrial animals regarded as identical on the continents of Europe and America; but their supposed number is constantly diminished, as more accurate observations are made. The predominant types

among the mammals are the bison, deer, ox, horse, hog, numerous rodents, especially squirrels, and hares, nearly all the insectivora, weasels, martens, wolves, foxes, wild cats, &c. On the other hand, there are no edentata and no quadrumana, with the exception of some monkeys on the two slopes of the Atlas and in Japan. Among birds, there is a multitude of climbers, passerine, gallinaceous, and many rapacious families. Of reptiles, there are lizards and tortoises of small or medium size, serpents, and many batrachians, but no crocodiles. Of fishes, there is the trout family, the cyprinoids, the sturgeons, the pikes, the cod, and especially the great family of herrings and scomberoids, to which latter belong the mackerel and the tunny. All classes of the mollusca are represented; though the cephalopods are less numerous than in the torrid zone. There is an infinite number of articulates of every type, as well as numerous polyps, though the corals proper do not yet appear abundantly.

§ 611. On each of the two continents of Europe and America, there is a certain number of species extending from one extreme of the temperate zone to the other. Such, for example, are the deer, the bison, the cougar, the flying-squirrel, numerous birds of prey, several tortoises, and the rattle-snake, in America. In Europe, the brown bear, wolf, swallow, and many birds of prey. Some species have a still wider range, like the ermine, which is found from Behring's Straits to the Himalaya Mountains—that is to say, from the coldest regions of the arctic zone to the southern confines of the temperate zone. It is the same with the musk-rat, which is found from the mouth of Mackenzie's River to Florida. The field-mouse has an equal range in Europe. Other species, on the contrary, are limited to one region. The Canadian elk is confined to the northern portion of the fauna; while the prairie wolf, the fox-squirrel, the *Bassaris*, and numerous birds, never leave the southern portion.*

* The types which are peculiar to temperate America, and are not found in Europe, are the opossum, several genera of insectivora, among them the shrew-mole (*Scalops aquaticus*), and the star-nose mole (*Condylura cristata*), which replaces the *Mygale* of the Old World; several genera of rodents, especially the musk-rat. Among the types characteristic of America must also be reckoned the snapping-turtle among the tortoises; the *Menobranchus* and *Menopoma* among the Salamanders; the *Lepidosteus* and *Amia* among the fishes; and, finally, the *Limulus* among the

§ 612. In America, as in the Old World, the temperate fauna is further subdivided into several districts, which may be regarded as so many zoological provinces, in each of which there is a certain number of animals differing from those in the others, though very closely allied to them. Temperate America presents us with a striking example in this respect. We have, on the one hand :—

1st. The fauna of the United States properly so called, on this side of the Rocky Mountains.

2d. The fauna of Oregon and California, beyond those mountains.

Though there are some animals which traverse the chain of the Rocky Mountains, and are found in the prairies of the Missouri as well as on the banks of the Columbia, as, for example, the Rocky Mountain deer (*Antelope furcifer*), yet, if we regard the whole assemblage of animals, they are found to differ entirely. Thus, the rodents, part of the ruminants, the insects, and all the mollusks, belong to distinct species.

§ 613. The faunas or zoological provinces of the Old World corresponding to these are :—

1st. The fauna of Europe, which is very closely related to that of the United States proper.

2d. The fauna of Siberia, separated from the fauna of Europe by the Ural Mountains.

3d. The fauna of the Asiatic table-land, which, from what is as yet known of it, appears to be quite distinct.

4th. The fauna of China and Japan, which is analogous to that of Europe in the birds, and to that of the United States in the reptiles—as it is also in the flora.

Lastly, it is in the temperate zone of the northern hemisphere that we meet with the most striking examples of those local faunas which have been mentioned above. Such, for example, is the fauna of the Caspian Sea, of the steppes of Tartary, and of the Western prairies.

§ 614. The faunas of the southern temperate regions differ from those of the tropics as much as the northern temperate

crustacea. Among the types which are wanting in temperate America, and which are found in Europe, may be cited the horse, the wild boar, and the true mouse. All the species of domestic mice living in America, have been brought from the Old World.

faunas do ; and, like them also, may be distinguished into two provinces, the colder of which embraces Patagonia. But, besides differing from the tropical faunas, they are also quite unlike each other on the different continents. Instead of that general resemblance, that family likeness, which we have noticed between all the faunas of the temperate zone of the northern hemisphere, we find here the most complete contrasts. Each of the three continental peninsulas jutting out southerly into the ocean represents, in some sense, a separate world. The animals of South America, beyond the tropic of Capricorn, are, in all respects, different from those at the southern extremity of Africa. The hyenas, wild boars, and rhinoceroses of the Cape of Good Hope have no analogues on the American continent ; and the difference is equally great between the birds, reptiles, fishes, insects and mollusks. Among the most characteristic animals of the southern extremity of America are peculiar species of seals, and especially among aquatic birds, the penguins.

§ 615. New Holland, with its marsupial mammals, with which are associated insects and mollusks no less singular, furnishes a fauna still more peculiar, and which has no similarity to those of any of the adjacent countries. In the seas of that continent, where every thing is so strange, we find the curious shark, with paved teeth and spines on the back (*Cestracion Philippi*), the only living representative of a family so numerous in former zoological ages. But a most remarkable feature of this fauna is, that the same types prevail over the whole continent, in its temperate as well as its tropical portions, the species only being different in different localities.

§ 616. TROPICAL FAUNAS.—The tropical faunas are distinguished, on all the continents, by the immense variety of animals which they comprise, not less than by the brilliancy of their dress. All the principal types of animals are represented, and all contain numerous genera and species. We need only refer to the tribe of humming-birds, which numbers not less than three hundred species. It is very important to notice, that here are concentrated the most perfect, as well as the most singular types of all the classes of the animal kingdom. The tropical region is the only one occupied by the quadrumana, the herbivorous bats, the great

pachydermata, such as the elephant, the hippopotamus, and the tapir, and the whole family of edentata. Here also are found the largest of the cat tribe, the lion, and tiger. Among the birds we may mention the parrots and toucans, as essentially tropical; among the reptiles, the largest crocodiles and gigantic tortoises; and, finally, among the articulated animals, an immense variety of the most beautiful insects. The marine animals, as a whole, are equally superior to those of other regions: the seas teem with crustaceans and numerous cephalopods, together with an infinite variety of gasteropods and acephala. The echinoderms there attain a magnitude and variety elsewhere unknown; and, lastly, the polyps there display an activity of which the other zones present no example. Whole groups of islands are surrounded with coral reefs formed by those little animals.

§ 617. The variety of the tropical fauna is further enriched by the circumstance that each continent furnishes new and peculiar forms. Sometimes whole types are limited to one continent, as the sloth, the toucans, and the humming-birds to America, the giraffe and hippopotamus to Africa; and again, animals of the same group have different characteristics, according as they are found on different continents. Thus, the monkeys of America have flat and widely-separated nostrils, thirty-six teeth, and generally a long, prehensile tail. The monkeys of the old world, on the contrary, have nostrils close together, only thirty-two teeth, and not one of them has a prehensile tail.

§ 618. But these differences, however important they may appear at first glance, are subordinate to more important characters, which establish a certain general affinity between all the faunas of the tropics. Such, for example, is the fact that the quadrumana are limited, on all the continents, to the warmest regions; and never, or but rarely, penetrate into the temperate zone. This limitation is a natural consequence of the distribution of the palms; for as these trees, which constitute the ruling feature of the flora of the tropics, furnish, to a great extent, the food of the monkeys on both continents, we have only to trace the limits of the palms, to have a pretty accurate indication of the extent of the tropical faunas on all three continents.

§ 619. Several well-marked faunas may be distinguished in the tropical part of the American continent, namely :

1st. The fauna of Brazil, characterized by its gigantic reptiles, its monkeys, its edentata, its tapir, its humming-birds, and the astonishing variety of its insects.

2nd. The fauna of the western slope of the Andes, comprising Chili and Peru, is distinguished by its llamas, vicunas, and birds, which differ from those of the basin of the Amazon, as also do the insects and mollusks.

3dly. The fauna of the Antilles and the Gulf of Mexico. This is especially characterized by its marine animals, among which the *Manatus* is particularly remarkable ; an infinite variety of singular fishes, embracing a large number of plectognaths ; also mollusca, and radiata of peculiar species. It is in this zone that the *Pentacrinus caput-medusæ* is found, the only representative, in the existing creation, of a family so numerous in ancient epochs, the Crinoidea with a jointed stem.

The limits of the fauna of Central America cannot yet be well defined, from a want of sufficient knowledge of the animals inhabiting those regions.

§ 620. The tropical zone of Africa is distinguished by a striking uniformity in the distribution of the animals, corresponding to the uniformity of the structure and contour of that continent. Its most characteristic species are spread over the whole extent of the tropics : thus, the giraffe is met with from Upper Egypt to the Cape of Good Hope. The hippopotamus is found at the same time in the Nile, the Nigèr, and Orange River. This wide range is the more significant, as it also relates to herbivorous animals, and thus supposes conditions of vegetation very similar over wide countries. Some forms are nevertheless circumscribed within narrow districts ; and there are marked differences between the animals of the eastern and western shores. Among the remarkable species of the African torrid region are the baboons, the African elephant, the crocodile of the Nile, a vast number of antelopes, and especially two species of ourang-outang, the chimpanzée and the *Engeena*, a large and remarkable animal, only recently described. The fishes of the Nile have a tropical character, as well as the animals of Arabia, which are more allied to those of Africa than to those of Asia.

§ 621. The tropical fauna of Asia, comprising the two pe-

ninsulas of India and the isles of Sunda, is not less marked. It is the country of the gibbons, the red ourang, the royal tiger, the gavial, and a multitude of peculiar birds. Among the fishes, the family of chetodons is most numerously represented. Here also are found those curious spiny fishes, whose intricate gills suggested the name *Labyrinthici*, by which they are known. Fishes with tufted gills are more numerous here than in other seas. The insects and mollusks are no less strongly characterized. Among others is the *Nautilus*, the only living representative of the great family of large chambered-shells, which prevailed so extensively over other types in former geological ages.

§ 622. The large island of Madagascar has its peculiar fauna, characterized by its makis and its curious rodents. It is also the habitat of the *Aya-aya*. Polynesia, exclusive of New Holland, furnishes a number of very curious animals, which are not found on the Asiatic continent. Such are the herbivorous bats, and the *Galeopithecus*, or flying maki. The Galapago islands, only a few hundred miles from the coast of Peru, have a fauna exclusively their own, among which gigantic land-tortoises are very characteristic.

SECTION III.

CONCLUSIONS.

§ 623. FROM the survey we have thus made of the distribution of the Animal Kingdom, it follows :

1st. Each grand division of the globe has animals which are either wholly or for the most part peculiar to it. These groups of animals constitute the faunas of different regions.

2d. The diversity of faunas is not in proportion to the distance which separates them. Very similar faunas are found at great distances apart ; as, for example, the fauna of Europe and that of the United States, which yet are separated by a wide ocean. Others, on the contrary, differ considerably, though at comparatively short distances ; as the fauna of the East Indies and the Sunda Islands, and that of New Holland ; or the fauna of Labrador and that of New England.

3d. There is a direct relation between the richness of a fauna and the climate. The tropical faunas contain a much larger number of more perfect animals than those of the temperate and polar regions.

4th. There is a no less striking relation between the fauna

and flora, the limit of the former being oftentimes determined, so far as terrestrial animals are concerned, by the extent of the latter.

§ 624. Animals are endowed with instincts and faculties corresponding to the physical character of the countries they inhabit, and which would be of no service to them under other circumstances. The monkey, which is a frugivorous animal, is organized for living on the trees from which he obtains his food. The reindeer, on the contrary, whose food consists of lichens, lives in cold regions. The latter would be quite out of place in the torrid zone, and the monkey would perish with hunger in the polar regions. Animals which store up provisions are all peculiar to temperate or cold climates. Their instincts would be uncalled for in tropical regions, where the vegetation presents the herbivora with an abundant supply of food at all times.

§ 625. However intimately the climate of a country may be allied with the peculiar character of its fauna, we are not to conclude that the one is the consequence of the other. The differences observed between animals of different faunas are no more to be ascribed to the influences of climate, than their organization is to the influence of the physical forces of nature. If it were so, we should necessarily find all animals precisely similar, when placed under the same conditions. We shall find, by the study of the different groups in detail, that certain species, though very nearly alike, are nevertheless distinct in two different faunas. Between the animals of the temperate zone of Europe, and those of the United States, there is similarity, but not identity; and the particulars in which they differ, though apparently trifling, are yet constant.

§ 626. Fully to appreciate the value of these differences, it is often requisite to know all the species of a genus or of a family. It is not uncommon to find, upon such an examination, that there is the closest resemblance between species dwelling far apart from each other, while species of the same genus, living side by side, are widely different. This may be illustrated by a single example. The *Menopoma*, *Siren*, *Amphiuma*, *Axolotl*, and the *Menobranchus*, are batrachians which inhabit the rivers and lakes of the United States and Mexico. They are very similar in external form, yet differ in the fact that some of them have external gills at the sides of the head, in which others are deficient; that some have five toes,

while others have only two ; and also in having either two or four legs. Hence we might be tempted to refer them to different types, did we not know intermediate animals, completing the series, namely, the *Proteus* and *Megalobatrachus*. Now the former exists only in the subterranean lakes of Austria, and the latter in Japan. The connection in this case is consequently established by means of species which inhabit distant continents.

§ 627. Neither the distribution of animals therefore, any more than their organization, can be the effect of external influences. We must, on the contrary, see in it the realization of a plan wisely designed, the work of a Supreme Intelligence, who created, at the beginning, each species of animal at the place, and for the place, which it inhabits. To each species has been assigned a limit which it has no disposition to overpass so long as it remains in a wild state. Only those animals which have been subjected to the yoke of man, or whose subsistence is dependent on man's social habits, are exceptions to this rule.

§ 628. As the human race has extended over the surface of the earth, man has more or less modified the animal population of different regions, either by exterminating certain species, or by introducing others with which he desires to be more intimately associated,—the domestic animals. Thus, the dog is found wherever we know of the presence of man. The horse, originally from Asia, was introduced into America by the Spaniards ; where it has thriven so well, that it is found wild, in innumerable herds, over the Pampas of South America, and the prairies of the West. In like manner the domestic ox became wild in South America. Many less welcome animals have followed man in his peregrinations ; as, for example, the rat and the mouse, as well as a multitude of insects, such as the house-fly, the cock-roach, and others which are attached to certain species of plants, as the white-butterfly, the Hessian-fly, &c. The honey-bee also has been imported from Europe.

§ 629. Among the species which have disappeared, under the influence of man, we may mention the *Dodo*, a peculiar species of bird which once inhabited the Mauritius, some remains of which are preserved in the British and Ashmolean Museums ; a large cetacean of the north (*Rytina Stelleri*), formerly inhabiting the coasts of Behring's Straits, and which

has not been seen since 1768. According to all appearances, we must also reckon among these the great stag, the skeleton and horns of which have been found buried in the peat-bogs of Ireland, and those of the Isle of Man. There are also many species of animals whose numbers are daily diminishing, and whose extinction may be foreseen; as the Canadian deer (*Wapiti*), the ibex of the Alps, the *Lämmergeyer*, the bison, the beaver, the wild-turkey, &c.

§ 630. Other causes may also contribute towards dispersing animals beyond their natural limits. Thus the sea-weeds are carried about by marine currents, and are frequently met with far from shore, thronged with little crustaceans, which are in this manner transported to great distances from the place of their birth. The drift-wood which the Gulf stream floats from the Gulf of Mexico even to the western shores of Europe, is frequently perforated by the larvæ of insects, and may probably serve as depositories for the eggs of fishes, crustacea and mollusks. It is possible also that aquatic birds may contribute in some measure to the diffusion of some species of fishes and mollusks, either by the eggs becoming attached to their feet, or by means of those which they evacuate undigested, after having transported them to considerable distances. Still, all these circumstances exercise but a very feeble influence upon the distribution of species in general, and each country, none the less, preserves its peculiar physiognomy, so far as its animals are concerned.

§ 631. There is only one way to account for the distribution of animals as we find them, namely, to suppose that they are *autochthonoi*, that is to say, that they originated like plants, on the soil where they are found. In order to explain the particular distribution of many animals, we are even led to admit that they must have been created at several points of the same zone, an inference which we must make from the distribution of aquatic animals, especially that of fishes. If we examine the fishes of the different rivers of the United States, peculiar species will be found in each basin, associated with others which are common to several basins. Thus, the Delaware River contains species not found in the Hudson; but, on the other hand, the pickerel is found in both. Now, if all animals originated at one point, and from a single stock, the pickerel must have passed from the Delaware to the Hudson, or *vice*

versa, which it could only have done by passing along the sea-shore, or by leaping over large spaces of *terra firma*; that is to say, in both cases it would be necessary to do violence to its organization. Now such a supposition is in direct opposition to the immutability of the laws of nature.

§ 632. We shall hereafter see that the same laws of distribution are not limited to the actual creation only, but that they have also ruled the creations of former geological epochs, and that the fossil species have lived and died, most of them, at the place where their remains are found.

§ 633. Even man, although a cosmopolite, is subject, in a certain sense, to this law of limitation. While he is everywhere the one identical species, yet several races, marked by certain peculiarities of features, are recognised; such as the Caucasian, Mongolian, and African races, of which we are hereafter to speak. And it is not a little remarkable, that the abiding places of these several races correspond very nearly with some of the great zoological regions. Thus we have a northern race, comprising the Samoyedes in Asia, the Laplanders in Europe, and the Esquimaux in America, corresponding to the Arctic fauna (§ 602), and like it, identical on the three continents, having for its southern limit the region of trees (§ 604). In Africa, we have the Hottentot and Negro races, in the south and central portions respectively, while the people of northern Africa are allied to their neighbours in Europe; just as we have seen to be the case with the zoological fauna in general (§ 584). The inhabitants of New Holland, like its animals, are the most grotesque and uncouth of all races (§ 615).

§ 634. The same parallelism holds good elsewhere, though not always in so remarkable a degree. In America, especially, while the aboriginal race is as well distinguished from other races as is its flora, the minor divisions are not so decided. Indeed, the facilities, or we might sometimes rather say, necessities, arising from the varied supplies of animal and vegetable food in the several regions, might be expected to involve, with his corresponding customs and modes of life, a difference in the physical constitution of man, which would contribute to augment any primeval differences. It could not, indeed, be expected, that a people constantly subjected to cold, like the people of the north, and living almost

exclusively on fish, which is not to be obtained without great toil and peril, should present the same characteristics, either bodily or mental, as those who idly regale on the spontaneous bounties of tropical vegetation.

[§ 635. Many other causes still more intimately connected with the aspect of our globe have also a great influence upon the distribution of the animals and plants living on its surface. The form of continents, the bearing of their shores, the direction and height of mountains, the mean level of great plains, the amount of water circumscribed by land, and forming inland lakes or seas, each shows a marked influence upon the general features of vegetation. Small low islands, scattered in clusters, are covered with a vegetation entirely different from that of extensive plains under the same latitudes. The bearing of the shores, again, modifying the currents of the sea, will also react upon vegetation. Mountain chains will be influential, not only from the height of their slopes and summits, but also from their action upon the prevailing winds. It is obvious, for instance, that a mountain chain like the Alps, running east and west, and forming a barrier between the colder region northwards and the warmer southwards, will have a tendency to lower the temperature of the northern plains, and to increase that of the southern below or above the mean which such localities would otherwise present; while the influence of a chain running north and south, like the Rocky Mountains and the Andes, will be quite the reverse, and tend to increase the natural differences between the eastern and western shores of the continent, laying open the north to southern influences and the south to those of the north, thus rendering its climate excessive, *i. e.* its summer warmer and its winter colder.

[§ 636. Again, the equalizing influence of a large sheet of water, the temperature of which is less liable to sudden changes than the atmospheric air, is very apparent in the uniformity of coast vegetation over extensive tracts, provided the soil be of the same nature; and also in the slower transition from one season into another along the shores, the coasts having less extreme temperatures than the main land. The absolute degree of temperature of the water acts with equal power; as the aquatic plants of the tropical regions, for instance, those

of Guyana, differ as widely from those of Lake Superior as the palms differ from the pine forests.

[§ 637. But, however active these physical agents may be, it would be very unphilosophical to consider them as the source or origin of the beings upon which they show so extensive an influence. Mistaking the circumstantial relation under which they appear for a causal connection, has done great mischief in natural science, and led many to believe they understood the process of creation, because they could account for some of the phenomena under observation. But, however powerful may be the degree of the heat; be the air ever so dry, or ever so moist; the light ever so moderate, or ever so bright; alternating ever so suddenly with darkness, or passing gradually from one condition to the other; these agents have never been observed to produce anything new, or to call into existence anything that did not exist before. Whether acting isolated or jointly, they have never been known even to modify to any great extent the living beings already existing, unless under the guidance and influence of man, as we observe among domesticated animals and cultivated plants. This latter fact shows, indeed, that the influence of the mind over material phenomena is far greater than that of physical forces, and thus refers our thoughts again and again to a Supreme Intelligence for a cause of all these phenomena, rather than to the so-called natural agents.

[§ 638. The physical agents whose influence upon organized beings we have just examined, show a regular progression in their action, agreeing most remarkably with the degrees of latitude on one side, and the elevation above the level of the sea on the other. Hence the difference in the vegetation, as we proceed from tropical regions towards the poles, or as we ascend from the level of the sea to any height along the slopes of a mountain. In both these directions there is a striking agreement in the order of succession of the phenomena, so much so, that the natural products of any given latitude may be properly compared with those occurring at a given height above the level of the sea; for instance, the vegetation of regions near the polar circles, and that of high mountains near the limits of perpetual snow under any latitude. The height of this limit, however, varies, of course, with the latitude. In Lapland, at 67° north latitude, it is three thousand

five hundred feet above the level of the sea; in Norway, at lat. 60°, it is five thousand feet; in the Alps, at lat. 46°, about eight thousand five hundred; in the Himalaya, at lat. 30°, over twelve thousand; in Mexico, at lat. 19°, it is fifteen thousand; and at Quito, under the equator, not less than sixteen thousand. At these elevations, in their different respective latitudes, without taking the undulations of the isothermal lines into consideration, vegetation shows a most uniform character, so that it may be said that there is a corresponding similarity of climate and vegetation between the successive degrees of latitude and the successive heights above the sea. As a striking example, the fact may be mentioned of the occurrence of identical plants in Lapland in lat. 67°, at a height of about three thousand feet and less above the level of the sea, and upon the summit of Mount Washington, in lat. 44°, at a height of not less than six thousand feet; while below this limit, in the wooded valleys of the White Mountains, there is not one species which occurs also about North Cape.

[§ 639. There is, nevertheless, one circumstance which shows that climatic influences alone, however extensive, taking, for instance, into account all the above-mentioned agents together, will not fully account for the geographical distribution of organized beings; as their various limits do not agree precisely with the outlines indicating the intensity of physical agents upon the surface of the earth. A few examples may serve to illustrate this remark. The limit of forest vegetation round the arctic circle does not coincide with the astronomical limits of the arctic zone; nor does it agree fully with the isothermal line of 32° of Fahrenheit; nor is the limit of vegetation in height always strictly in accordance with the temperature, as the *Cerastium latifolium* and *Ranunculus glacialis*, for instance, occur in the Alps as high as ten, and even eleven thousand feet above the level of the sea. Again, eastern and western countries within the same continent, or compared from one continent to the other, show such differences under similar climatic circumstances, that we at once feel that something is wanting in our illustrations, when we refer the distribution of animals and plants solely to the agency of climate. But the most striking evidence that climate neither accounts for the resemblance nor the difference of animals and plants in different countries, may be derived from the fact, that the

development of the animal and vegetable kingdoms differs widely, under the *same* latitudes, in the northern and in the southern hemispheres, and that there are entire families of plants and animals exclusively circumscribed within certain parts of the world ; such are, for instance, the magnolia and cactus in America, the kangaroos in New Holland, the elephants and rhinoceros in Asia and Africa, &c., &c.

[§ 640. From these facts we may indeed conclude, that there are other influences acting in the distribution of animals and plants besides climate ; or, perhaps, we may better put the proposition in this form : that however intimately connected with climate, however apparently dependent upon it, vegetation is, in truth, independent of those influences, at least so far as the causal connection is concerned, and merely adapted to them. This position would at once imply the existence of a power regulating these general phenomena in such a manner as to make them agree in their mutual connection ; that is to say, we are thus led to consider nature as the work of an intelligent Creator, providing for its preservation under the combined influences of various agents equally his work, which contribute to their more diversified combinations.

[§ 641. The geographical distribution of organized beings displays more fully the direct intervention of a Supreme Intelligence in the plan of creation, than any other adaptation in the physical world. Generally, the evidence of such an intervention is derived from the benefits, material, intellectual, and moral, which man derives from nature around him, and from the mental conviction which consciousness imparts to him, that there could be no such wonderful order in the universe, without an omnipotent Ordainer of the whole. This evidence, however plain to the Christian, will never be satisfactory to the man of science, in that form. In these studies evidence must rest upon direct observation and induction, just as fully as mathematics claims the right to settle all questions about measurable things. There will be no scientific evidence of God's working in nature, until naturalists have shown that the whole creation is the *expression of a thought*, and not the *product of physical agents*. Now what stronger evidence of thoughtful adaptation can there be, than the various combinations of similar, though specifically different assemblages of animals and plants repeated all over the

world, under the most uniform and the most diversified circumstances? When we meet with pine trees, so remarkable for their peculiarities, both morphological and anatomical, combined with beeches, birches, oaks, maples, &c., as well in North America as in Europe and Northern Asia, under similar circumstances; when we find, again, representatives of the same family with totally different features, mingling, so to say, under low latitudes with palm trees, and all the luxuriant vegetation of the tropics; when we truly behold such scenes, and have penetrated their full meaning as naturalists, then we are placed in a position similar to that of the antiquarian who visits ancient monuments. He recognizes at once the workings of intelligence in the remains of an ancient civilization; he may fail to ascertain their age correctly, he may remain doubtful as to the order in which they were successively constructed, but the character of the whole tells him that they are works of art, and that men, like himself, originated these relics of by-gone ages. So shall the intelligent naturalist read at once in the pictures which nature presents to him, the works of a higher Intelligence; he shall recognize in the minute perforated cells of the *Coniferæ*, which differ so wonderfully from those of other plants, the hieroglyphics of a peculiar age; in their needle-like leaves, the escutcheon of a peculiar dynasty; in their repeated appearance under most diversified circumstances, a thoughtful and thought-eliciting adaptation. He beholds, indeed, the works of a being *thinking* like himself, but he feels at the same time that he stands as much below the Supreme Intelligence, in wisdom, power and goodness, as the works of art are inferior to the wonders of nature. Let naturalists look at the world under such impressions, and evidence will pour in upon us that all creatures are expressions of the thoughts of Him whom we know, love and adore unseen.*]

* Lake Superior, by Professor Louis Agassiz, page 104 *et seq.*

CHAPTER FOURTEENTH.

GEOLOGICAL SUCCESSION OF ANIMALS ; OR, THEIR DISTRIBUTION IN TIME.

SECTION I.

STRUCTURE OF THE EARTH'S CRUST.

§ 642. THE records of the Bible, as well as human tradition, teach us that man and the animals associated with him were created by the word of God ; “ The Lord made Heaven and earth, the sea, and all that in them is ; ” and this truth is confirmed by the revelations of science, which unequivocally indicate the direct interventions of creative power.

§ 643. But man and the animals which now surround him are not the only kinds which have had a being. The surface of our planet, anterior to their appearance, was not a desert. There are, scattered through the crust of the earth, numerous animal and vegetable remains, which show that the earth had been repeatedly supplied with, and long inhabited by animals and plants altogether different from those now living.

§ 644. In general, their hard parts are the only relics of them which have been preserved, such as the skeleton and teeth of vertebrata ; the shells of mollusca and radiata ; the shields of crustaceans, and sometimes the wing-cases of insects. Most frequently they have lost their original chemical composition, and are changed into stone ; and hence the name of *petrifications* or *fossils*, under which latter term are comprehended all the organized bodies of former epochs, obtained from the earth's crust. Others have entirely disappeared, leaving only their forms and sculpture impressed upon the rocks.

§ 645. The study of these remains and of their position in the rocks constitutes PALÆONTOLOGY ; one of the most essential branches of zoology. Their geological distribution, or the order of their successive appearance—namely, *the distribution of animals in time*, is of no less importance than the

geographical distribution of living animals, *their distribution in space*, of which we have treated in the preceding chapter. To obtain an idea of the successive creations, and of the stupendous length of time they have required, it is necessary to sketch the principal outlines of geology.

§ 646. The rocks* which compose the crust of our globe are of two kinds :—

1. The *Massive Rocks*, called also *Plutonic*, or *Igneous Rocks*, which lie beneath all the others, or have sometimes been forced up through them, from beneath. They were once in a melted state, like the lava of the present epoch, and, on cooling at the surface, formed the original crust of the globe, the granite, and later porphyry, basalt, &c.

2. The *Sedimentary*, or *Stratified Rocks*, called also *Nep-tunic Rocks*, which have been deposited in water, in the same manner as modern seas and lakes deposit sand and mud on their shores, or at the bottom.

§ 647. These sediments have been derived partly from the disintegration of the older rocks, and partly from the decay of plants and animals. The materials being disposed in layers or strata have become, as they hardened, limestones, slates, marls, or grits, according to their chemical and mechanical composition, and contain the remains of the animals and plants which were scattered through the waters.†

§ 648. The different strata, when undisturbed, are arranged one above the other in a horizontal manner, like the leaves of a book, the lowest being the oldest. In consequence of the commotions which the crust of the globe has undergone, the strata have been ruptured, and many points of the

* Rocks, in a geological sense, include all the materials of the earth, the loose soil and gravel, as well as the firm rock.

† Underneath the deepest strata containing fossils, between these and the Plutonic rocks, are generally found very extensive layers of slates without fossils (gneiss, mica-slate, talcose-slate), though stratified and known to the geologist under the name of *Metamorphic Rocks* (fig. 376, *M*), being probably sedimentary rocks which have undergone considerable changes. The Plutonic rocks, as well as the metamorphic rocks, are not always confined to the lower levels, but they are often seen rising to considerable heights, and forming many of the loftiest peaks of the globe. The former also penetrate, in many cases, like veins, through the whole mass of the stratified and metamorphic layers, and expand at the surface; as is the case with the trap dykes, and as lava streams actually do now (fig. 376, *T. L.*)

surface have been elevated to great heights, in the form of mountains; and hence it is that fossils are sometimes found at the summit of the highest mountains, though the rocks containing them were originally formed at the bottom of the sea. But even when folded, or partly broken, their relative age may still be determined by an examination of the ends of the up-turned strata, where they appear or crop out in succession, at the surface, or on the slopes of mountains, as seen in the diagram (fig. 376).

Fig. 376.

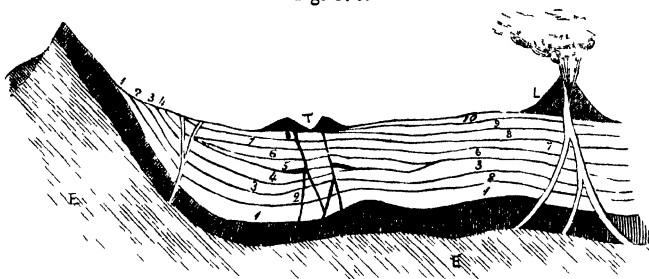

§ 649. The sedimentary rocks are the only ones containing animal and vegetable remains. These are found imbedded in the rock, just as we should find them in the mud now deposited at the bottom of the sea, if laid dry. The strata containing fossils are numerous. The comparison and detailed study of them belongs to geology, of which Palæontology forms an essential part. A group of strata extending over a certain geographical extent, all of which contain some fossils in common, no matter what may be the chemical character of the rock, whether it be limestone, sand, or clay, is termed a geological *Formation*. Thus, the coal beds, with the intervening slates and grits, and the masses of limestone between which they often lie, constitute but one formation,—the carboniferous formation.

§ 650. Among the stratified rocks, we distinguish ten principal formations, each of which indicates an entirely new era in the earth's history; while each of the layers composing a formation indicates but some partial revolution. Proceeding from below upwards, they are as follows, as

shewn in the cut, and also in the lower diagram in the frontispiece.

1st. The *Lower Silurian*. This is a most extensive formation, no less than eight stages of which have been made out by geologists in North America, composed of various limestones and sandstones.*

2d. The *Upper Silurian*. It is also a very extensive formation, since about ten stages of it are found in the State of New York.†

3d. The *Devonian*, including in North America no less than eleven stages.‡ It occurs also in Russia and Scotland, where it was first made out as a distinct formation.

4th. The *Carboniferous Formation*, consisting of three grand divisions.§

5th. The *Trias*, or *Saliferous Formation*, contains the richest deposits of salt on the continent of Europe, and comprises three stages,|| to one of which the sandstone of the Connecticut valley belongs.

6th. The *Oolitic Formation*, only faint traces of which exist on the continent of America. It comprises at least four distinct stages.¶

7th. The *Cretaceous*, or *Chalk Formation*, of which three principal stages have been recognized: two of these are feebly represented in the Southern and Middle States of North America.

* 1. Potsdam Sandstone; 2. Calciferous Sandstone; 3. Chazy Limestone; 4. Bird's-eye Limestone; 5. Black River Limestone; 6. Trenton Limestone; 7. Utica Slate; 8. Hudson River Group; being all found in the western parts of the United States.

† 1. Oneida Conglomerate; 2. Medina Sandstone; 3. Clinton Group; 4. Niagara Group; 5. Onondaga Salt Group; 6. Water Limestone; 7. Pentamerus Limestone; 8. Delthyris Shaly Limestone; 9. Encrinal Limestone; 10. Upper Pentamerus Limestone.

‡ 1. Oriskany Sandstone; 2. Cauda-Galli Grit; 3. Onondaga Limestone; 4. Corniferous Limestone; 5. Marcellus Shale; 6. Hamilton Group; 7. Tully Limestone; 8. Genesee Slate; 9. Portage Group; 10. Chemung Group; 11. Old Red Sandstone.

§ 1. The Permian, extensively developed in Russia, especially in the government of Perm; 2. The coal measures, containing the rich deposits of coal in the Old and New World; 3. The Magnesian Limestone of England.

|| 1. New Red Sandstone; 2. Muschelkalk; 3. Keuper.

¶ 1. The Lias; 2. The Lower Oolite; 3. The Middle Oolite; 4. The Upper Oolite.

8th. The *Lower Tertiary*, or *Eocene*, very abundant in the Southern States of the Union, and to which belong the coarse limestone of Paris, and the London clay in England.

9th. The *Upper Tertiary* or *Miocene*, and *Pleiocene*, found also in the United States, as far north as Martha's Vineyard, and Nantucket, and very extensive in Southern Europe, as well as in South America.

10th. The *Drift*, forming the most superficial deposits, and extending over a large portion of the northern countries in both hemispheres.

We have thus more than forty distinct layers already made out, each of which marks a distinct epoch in the earth's history, indicating a more or less extensive and important change in the condition of its surface.

§ 651. All the formations are not everywhere found, or are not developed to the same extent, in all places. So it is with the several strata of which they are composed. In other words, the layers of the earth's crust are not continuous throughout, like the coats of an onion. There is no place on the globe where, if it were possible to bore down to its centre, all the strata would be found. It is easy to understand how this must be so. Since irregularities in the distribution of water upon the solid crust have, necessarily, always existed to a certain extent, portions of the earth's surface must have been left dry at every epoch of its history, gradually forming large islands and continents, as the changes were multiplied. And since the rocks were formed by the subsidence of sediment in water, no rocks would be formed except in regions covered by water; they would be thickest at the parts where most sediment was deposited, and gradually thin out towards their circumference. We may therefore infer, that all those portions of the earth's surface which are destitute of a certain formation were dry land, during that epoch of the earth's history to which such formation relates, excepting, indeed, where the rocks have been subsequently removed by the denuding action of water or other causes.

§ 652. Each formation represents an immense period of time, during which the earth was inhabited by successive races of animals and plants, whose remains are often found, in their natural position, in the places where they lived and died, not scattered at random, though sometimes mingled to-

gether by currents of water, or other influences, subsequent to the time of their interment. From the manner in which the remains of various species are found associated in the rock, it is easy to determine whether the animals to which these remains belonged lived in the water, or on land, on the beach or in the depths of the ocean, in a warm or in a cold climate. They will be found associated in just the same way as animals are that live under similar influences at the present day.¹

§ 653. In most geological formations, the number of species of animals and plants found in any locality of given extent, is not below that of the species now living in an area of equal extent, and of a similar character; for though, in some deposits, the variety of the animals contained may be less, in others it is greater than that on the present surface. Thus, the coarse limestone in the neighbourhood of Paris, which is only one stage of the lower tertiary, contains not less than 1200 species of shells; whereas the species now living in the Mediterranean do not amount to half that number. Similar relations may be pointed out in America. Mr. Hall, one of the geologists of the New York Survey, has described, from the Trenton limestone (one of the ten stages of the lower Silurian), 170 species of shells, a number almost equal to that of all the species found now living on the coast of Massachusetts.

§ 654. Nor was the number of individuals less than at present. Whole rocks are entirely formed of animal remains, particularly of corals and shells. So, also, coal is composed of the remains of plants. If we consider the slowness with which corals and shells are formed, we may form some faint notion of the vast series of ages that must have elapsed in order to allow the formation of those rocks, and their regular deposition, under the water, to so great a thickness. If, as all things combine to prove, this deposition took place in a slow and gradual manner in each formation, we must conclude, that the successive species of animals found in them followed each other at long intervals, and are not the work of a single epoch.

§ 655. It was once believed that animals were successively created in the order of their relative perfection; so that the most ancient formations contained only animals of the lowest grade, such as the polyps and the echinoderms, to which

succeeded the mollusca, then the articulated animals, and last of all, the vertebrata. This theory, however, is now untenable; since fossils belonging to each of the four departments have been found in the fossiliferous deposits of every age. Indeed, we shall see that even in the lower Silurian formation there exist not only polyps and other radiata, but also numerous mollusca, trilobites (belonging to the articulated), and even fishes and reptiles.*

SECTION II.

AGES OF NATURE.

§ 656. EACH formation, as has been before stated (§ 649), contains remains peculiar to itself, which do not extend into the neighbouring deposits above or below it. Still there is a connection between the different formations, more strong in proportion to their proximity to each other. Thus, the animal remains of the chalk, while they differ from those of all other formations, are nevertheless much more nearly related to those of the oolitic formation, which immediately precedes, than to those of the carboniferous formation, which is much more ancient; and in the same manner, the fossils of the carboniferous group approach more nearly to those of the Silurian formation than to those of the Tertiary.

§ 657. These relations could not escape the observation of naturalists, and indeed they are of great importance for the true understanding of the development of life at the surface of our earth. And as in the history of man, several grand periods have been established, under the name of *Ages*, marked by peculiarities in his social and intellectual condition, and illustrated by contemporaneous monuments, so, in the history of the earth also, are distinguished several great periods, which may be designated as the various *Ages of Nature*, illustrated in like manner by their monuments, the fossil remains, which, by certain general traits stamped upon them, clearly indicate the eras to which they belong.

§ 658. We distinguish four Ages of Nature, corresponding to the great geological divisions, namely:

1st. *The Primary or Palæozoic Age*, comprising the lower

* See an important communication, by Mr. Logan, on the Footprints of Reptiles in the Potsdam sandstone of Lower Canada, Quart. Jour. Geol. Soc. vol. vii. p. 247.—ED.

Silurian, the upper Silurian, and the Devonian. During this age there were few air-breathing animals. The fishes were the masters of creation. We may therefore call it the *Reign of Fishes*.

2d. *The Secondary Age*, comprising the carboniferous, the trias, the oolitic, and the cretaceous formations. This is the epoch in which air-breathing animals more extensively prevail. The reptiles predominate over the other classes, and we may therefore call it the *Reign of Reptiles*.

3d. *The Tertiary Age*, comprising the tertiary formations. During this age, terrestrial mammals, of great size, abound. This is the *Reign of Mammals*.

4th. *The Modern Age*, characterized by the appearance of the most perfect of all created beings. This is the *Reign of Man*.

Let us review each of these four Ages of Nature, with reference to the diagram at the beginning of the volume.

§ 659. THE PALÆOZOIC AGE. *Reign of Fishes*. — The palæozoic fauna, being the most remote from the present epoch, presents the least resemblance to the animals now existing, as will easily be perceived by a glance at the following sketches (fig. 377). In no other case do we meet with animals of such extraordinary shapes, as in the strata of the palæozoic age.

§ 660. We have already stated (§ 655) that there are found, in each formation of the primary age, animal remains of all the four great departments, namely, vertebrata, articulata, mollusca, and radiata. We have now to examine to what peculiar classes and families of each department these remains belong, with a view to ascertain if any relation between the structure of an animal and the epoch of its first appearance on the earth's surface may be traced.

§ 661. As a general result of the inquiries hitherto made, it may be stated that the palæozoic animals belong, for the most part, to the lower divisions of the different classes. Thus, of the class of echinoderms, we find scarcely any but Crinoids (figs. 72 and 73), which are the least perfect of the class; of which there are some quite peculiar types from the Trenton limestone and from the Black River limestone.

§ 662. Of the mollusca, the bivalves or acephala are numerous, but for the most part belong to the brachiopoda, that is to say, to the lowest division of the class, including mollusks

with unequal valves, having peculiar appendages in the interior. The *Leptaena alternata*, found very abundantly in the Trenton limestone, is

one of those shells. The only fossils yet found in the Potsdam sandstone, the oldest of all fossiliferous deposits, belong also to this family (*Lingula prima*). Besides this, there are also found some bivalves of a less uncommon shape (*Avicula decussata*); [and in the upper stages of the Silurian group in England we find *Orthis or-*

Fig. 377.

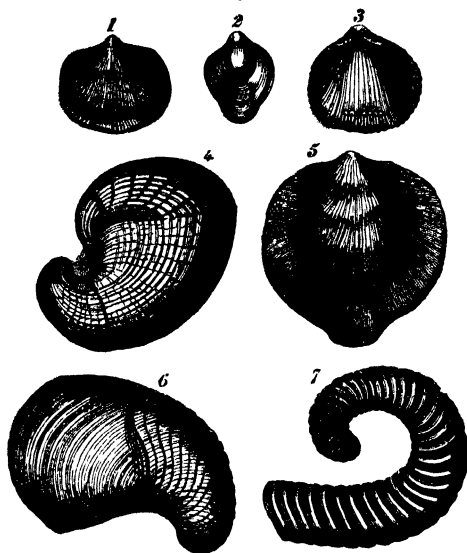

bicularis (1), *Terebratula navicula* (2), *Orthis navicularis*, (3) *Pentameus Knightii* (4), *Atrypa affinis* (5), fig. 377.]

§ 663. The gasteropoda are less abundant; some of them are of a peculiar shape and structure, as *Bucania expansa*, *Euomphalus hemisphaericus*. Those more similar to our common marine snails have all an entire aperture; those with a canal being of a more recent epoch.

§ 664. Of the cephalopoda we find some genera not less curious, part of which disappear in the succeeding epochs; such, in particular, as those of the straight, chambered shells called orthoceratites, some of which are twelve feet in length (*Orthoceras ventricosum*). There are also found some of a coiled shape, like the ammonites of the secondary age, but having less complicated partitions (*Lituites giganteus*, 7). The true cuttle-fishes, which are the highest of the class, are not

yet found. On the contrary, the *Bryozoa*, which have long been considered as polyps, but which, according to all appearances, are mollusks of a very low order, are very numerous in this epoch.

§ 665. The articulata of the palæozoic age are mostly trilobites, animals which evidently belong to the lower order of the crustaceans (fig. 378). There is an incompleteness and want of development in the form of their body, that strongly reminds us of the embryo among the crabs. A great many genera have already been discovered.



Fig. 378.—*Homalonotus delphincephalus*.—König.

The Silurian rocks of Bohemia have yielded upwards of two hundred species. *Homalonotus* (fig. 378), one of the family *Calymenidæ*, will give a general idea of the form of these palæozoic crustaceans. Some others seem more allied to the crustaceans of the following ages, but are nevertheless of a very extraordinary form, as *Eurypterus remipes*. There are also found, in the Devonian, some very large entomostraca. The class of worms is represented only by *Nereis* and a few *Serpulæ*, which are marine worms, surrounded by a solid sheath. The class of insects is entirely wanting.

§ 666. The inferiority of the earliest inhabitants of our earth appears most striking among the vertebrata. There are as yet neither birds nor mammals. The fishes, and a few reptiles whose fossil foot-marks we only know, are the sole representatives of this division of animals.

§ 667. The fishes of that early period were not like ours. Some of them had the most extraordinary forms, so that they have been often mistaken for quite different animals; for example, the *Pterichthys* (fig. 379), with its two winglike appendages, and also the *Cocosteus* (fig. 380), of the same deposit, with its large plates covering the head and the anterior part of the body. There are also found remains of shark's spines, as well as palatal bones, the latter of a very peculiar

kind. Even those fishes which have a more regular shape, as the *Dipterus*, have not horny scales like our common fishes,

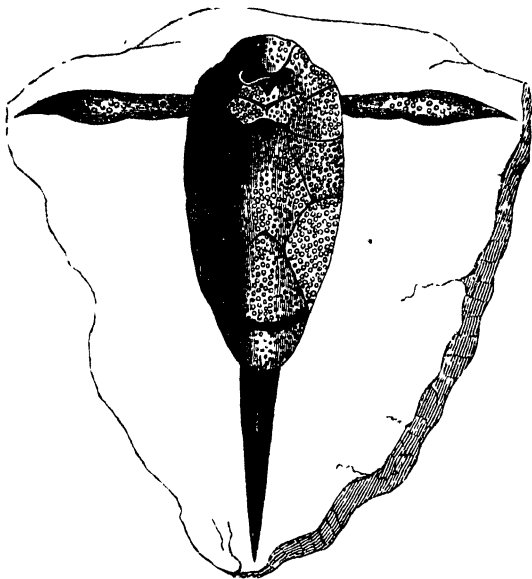

Fig. 379.—*Pterichthys*, from the Devonian rocks of Scotland.—Agass.

but are protected by a coat of bony plates, covered with enamel, like the gar pikes (*Lepidosteus*) of the American rivers. Moreover they all exhibit certain characteristic features, which are very interesting in a physiological point of view. They all have a broad head, and a tail terminating in two unequal lobes. What is still more curious, the best preserved specimens show no indications of the bodies of the vertebræ, but merely the spinous processes; from which it must be inferred that the body of the vertebra was cartilaginous, as it is in our sturgeons.

§ 668. Recurring to what has been stated on that point in Chapter Twelfth, we thence conclude that these ancient fishes were not so fully developed as most of our fishes, being, like

the sturgeon, arrested, as it were, in their development ; since we have shown that the sturgeon, in its organization, agrees, in many respects, with the cod or salmon in their early age.

§ 669. Finally, there was, during the palæozoic age, less variety among the animals of the different regions of the globe ; and this may be readily explained by the peculiar configuration of the earth at that epoch. Great mountains did not then exist ; there were neither lofty elevations nor deep depressions. The sea covered the greater part, if not the whole, of the surface of the globe ; and the animals which then existed, and whose remains have been preserved, were all, with the exception of the reptiles which have left their foot-marks on the Potsdam sandstone, aquatic animals, breathing by gills. This wide distribution of the waters impressed a very uniform character upon the whole animal kingdom. Between different zones and continents, no such strange contrasts of the different

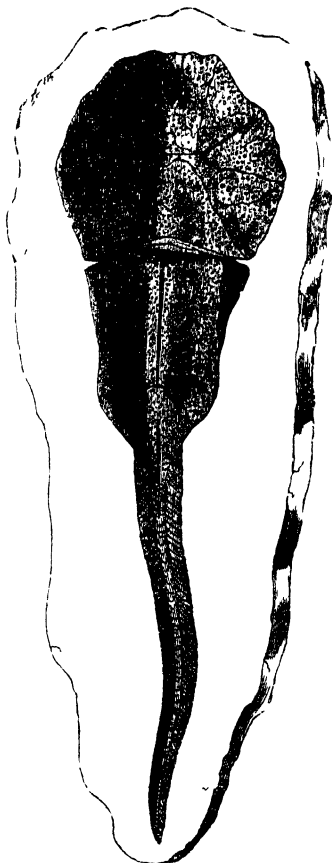

Fig. 380.—*Coccosteus cuspidatus*.—Agass

types existed as at the present epoch. The same genera, and often the same species, were found in the seas of America, Europe, Asia, Africa, and New Holland ; from which we must

conclude that the climate was much more uniform than at the present day. Among the aquatic population, no sound was heard. All creation was then silent.

§ 670. THE SECONDARY AGE. *Reign of Reptiles*.—The Secondary age displays a greater variety of animals as well as plants. The fantastic forms of the palæozoic age disappear, and in their place we see a greater symmetry of shape. The advance is particularly marked in the series of vertebrata. Fishes and a few reptiles are no longer the sole representatives of that department. Reptiles, birds, and mammals successively make their appearance, but reptiles preponderate, particularly in the Oolitic formation; on which account we have called this age the *Reign of Reptiles*.

§ 671. The Carboniferous formation is the most ancient of the Secondary age. Its fauna bears, in various respects, a close analogy to that of the palæozoic epoch, especially in its *Trilobites* and mollusca.* Besides these, we meet here



h d c g e b a f

Fig. 381.—The Flora of the coal period.

- | | | |
|---------------------|------------------|--------------|
| a Arborescent fern. | d Neuropteris. | g Araucaria. |
| b Pecopteris. | e Lepidodendron. | h Casuerina. |
| c Asterophyllites. | f Calamites. | |

* This circumstance has caused the coal-measures to be generally referred

with air-breathing animals, as insects, scorpions, and reptiles. At the same time, land-plants first make their appearance, namely, ferns of great size, club-mosses, and other fossil plants. Fig. 381 exhibits some of the most typical forms of the flora of this period. This abundant vegetation corroborates what has been already said concerning the intimate connection existing between the animals and the land-plants of all epochs. The class of crustaceans has also improved during the coal period. It is no longer composed exclusively of *Trilobites*, but the type of horse-shoe crabs also appears, with other gigantic forms. Some of the mollusca, particularly the bivalves, seem also to approach those of the Oolitic period.

§ 672. In the Trias period, which immediately succeeds the Carboniferous, the fauna of the Secondary age acquires its definitive character; here the reptiles first appear in considerable numbers, consisting of huge crocodilian animals, belonging to a peculiar order, the Rhizodonts (*Protosaurus*, *Notosaurus*, and *Labyrinthodon*). The well-known discoveries of Professor Hitchcock, in the red sandstone of the Connecticut Valley, have made us acquainted with a great number of birds' tracks belonging to this epoch, for the most part indicating animals of gigantic size. These impressions, which he has designated under the name of *Ornithichnites*, are some of them eighteen inches in length, and five feet apart, far exceeding in size the tracks of the largest ostrich. Other foot-marks of a very peculiar shape, have been found in the red sandstone of Germany (fig. 382), and in Pennsylvania. They were probably made by reptiles, which have been called *Cheiro-*



Fig. 382.—Line of footmarks on a slab of sandstone, from Hildburghausen, in Saxony.

to the palæozoic epoch. But there are reasons which induce us to unite the carboniferous period with the secondary age, especially when we consider that a luxuriant terrestrial vegetation was developed at this epoch; that here land animals first appear in any considerable number, whereas, in the palæozoic age, there were chiefly marine animals, breathing by gills, and a few reptiles known only by their foot-marks.

therium, from the resemblance of the impressions to a hand. The mollusca, articulata, and radiata approach those of the

fauna of the succeeding period.

§ 673. The Oolitic fauna is remarkable for the great number of gigantic reptiles it contains. In this formation we find those enormous amphibia, known under the name *Ichthyosaurus*, *Plesiosaurus*, and *Megalosaurus*. The first, in particular, the *Ichthyosauri*, greatly abounded on the coasts of the continents of that period, and their skeletons are so well preserved, that we are enabled to study even the minutest details of their structure, which differs essentially from that of the reptiles of the present day. In some respects they form an intermediate link between fishes and mammals, and may be con-

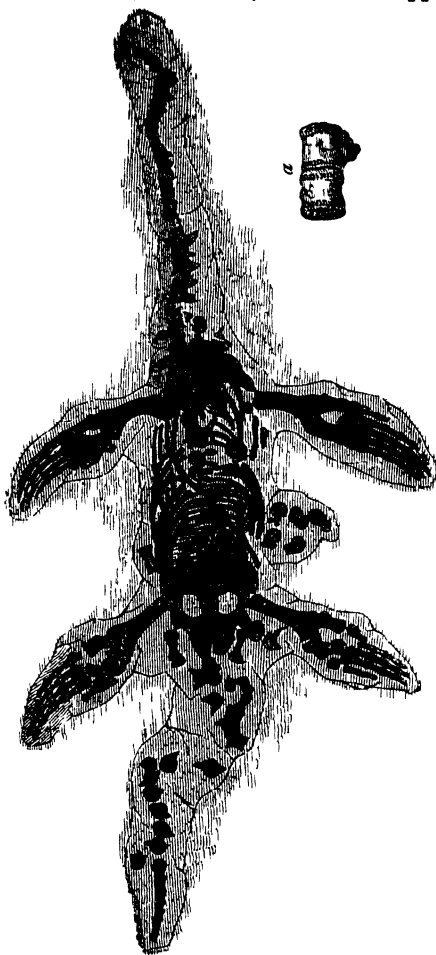

Fig. 383.—*Plesiosaurus rugosus* —Owen.

sidered as the prototypes of the whales, having, like them, limbs in the form of oars. The *Plesiosaurus* (fig. 383) agrees, in many respects, with the *Ichthyosaurus* in its structure, but is easily distinguished by its long neck, which somewhat resembles the neck of some aquatic birds. A still more extraordinary reptile is the *Pterodactylus* (fig. 384), with its long fingers, like those of a bat, for the support of wings, by which it was enabled to fly.

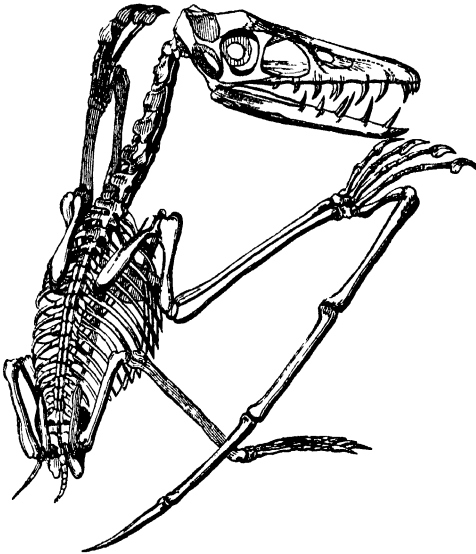

Fig. 384.—*Pterodactylus crassirostris*.—Goldfuss.

§ 674. It is also in the upper stages of this formation that we meet with the skeletons of tortoises. Here also we find the remains of several families of insects (*Libellula*, *Coleoptera*, *Ichneumons*, &c.) Finally, in these same stages, the slates of Stonesfield, the first traces of mammals are found, namely, the jaws and teeth of animals belonging to extinct forms of

Marsupialia, and having some resemblance to the opossum (fig. 385).



Fig. 385.—Jaw of the *Thylacotherium*, from Stonesfield.

§ 675. The department of mollusca is largely represented in all its classes ; some of the most common forms are sketched in fig. 386. The peculiar types of the primary age have almost disappeared, and are replaced by a greater variety of new forms. Of the brachiopoda only one type, namely, that of the *Terebratula* (10), is abundant. Among the other bivalves there are many peculiar forms, as *Gryphæa* (1 and 2), *Cardium* (4), *Trigonia* (5), *Goniomya* (6), and *Gervillia* (8). The gasteropoda display a great variety of species, and the genus *Nerinea* (11) is an abundant form. The Cephalopoda are very numerous, among which the *Ammonites* (9) are the most prominent. There are also found, for the first time, the representatives of the cuttle-fishes, under the form of *Belemnites*, an extinct type of animals, with an internal chambered shell, protected by a sheath, and terminating in a conical body somewhat similar to the bone of the *Sepia*, and which is commonly the only preserved part.

§ 676. The variety is not less remarkable among the radiata. There are to be found representatives of all the classes; even traces of jelly-fishes have been made out in the slates of Solenhofen, in Bavaria. The polyps were very abundant at that epoch, especially in the upper stages, one of which, from this circumstance, has received the name of Coral-rag. Indeed, there are to be found whole reefs of corals in their natural position, similar to those which are to be seen in the islands of the Pacific. [Among the most remarkable types

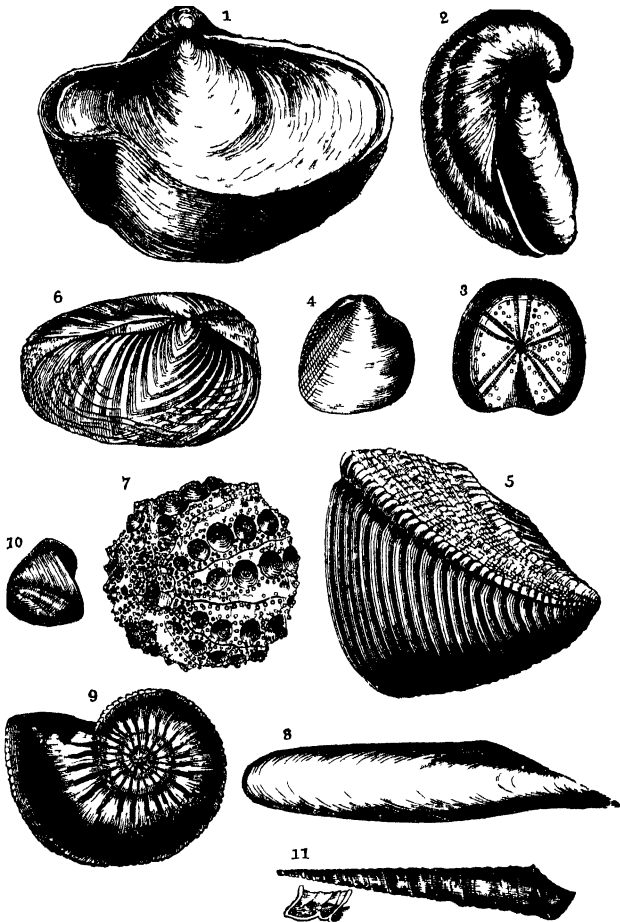

Fig 386 —Fossil Mollusca and Radiata of the Oolitic period.

- | | |
|--|---|
| 1 <i>Gryphæa dilatata</i> Sow —Kelloway rock and Oxford clay | 7 <i>Hemicidaris intermedia</i> Gt Oolite and Coral rag |
| 2 <i>Gryphæa incurva</i> Sow Lower lias | 8 <i>Gervillia acuta</i> Sow, Lower oolites |
| 3 <i>Nucleolites clunicularis</i> Cornbrash | 9 <i>Ammonites Calloviensis</i> Sow Kelloway rock |
| 4 <i>Cardium truncatum</i> Sow Lias marlstone | 10 <i>Terebratula acuta</i> Sow Lias marlstone |
| 5 <i>Trigonia costata</i> Sow Inferior oolite | 11 <i>Nerinea cingenda</i> Voltz Lower oolites |
| 6 <i>Goniomva V scripta</i> Agass. Inferior oolite. | |

of the family ASTERIDÆ the genera *Stylina*, *Montlivaltia*, *Thecosmilia*, *Rhabdophyllia*, *Cladophyllia*, *Goniocora*, *Isastrea*, *Thamnastrea*; and of the family FUNGIDÆ, the genera *Comoseris*, *Protoseris*, are found in the Coral-rag of Wiltshire. In the Great Oolite, besides species of many of these genera, others belonging to *Cyathophora*, *Convexastrea*, *Calamophyllia*, *Cladophyllia*, *Clausastrea*, occur. Similar coral beds exist in the limestones belonging to the Inferior Oolite, from whence the genera *Discocyathus*, *Trochocyathus*, *Axosmilia*, *Thecosmilia*, *Latomeandra*, *Anabacia*, with numerous species belonging to many of the Coral-rag genera, are found. The echinoderms present a great variety of forms. The crinoids are not quite so numerous as in former ages. Among the most abundant is the *Pentacrinus*. There are also comatula-like animals, that is to say, free crinoids (*Pterocoma pinnata*). Many star-fishes are likewise found in the various stages of this formation. Finally, there is an extraordinary variety of urchins, among them *Cidaris* and *Hemicidaris* (fig. 386, 7) with large spines, and several other types not found before, as, for example, *Pygaster*, *Dysaster* and *Nucleolites* (fig. 386, 3).]

§ 677. The fauna of the Cretaceous period bears the same general characters as the Oolitic, but with a more marked tendency towards existing forms. Thus the *Ichthyosauri* and *Plesiosauri*, characterizing the preceding epoch, are succeeded by gigantic lizards, approaching more nearly the reptiles of the present day. Among the mollusca, a great number of new forms appear, especially among the cephalopoda, as *Ammonites*, *Crioceras*, *Scaphites*, *Ancyloceras*, *Hamites*, *Baculites*, *Turrilites*, some of which resemble the gasteropoda in shape, but are nevertheless chambered. The *Ammonites* themselves are quite as numerous as in the Oolitic period, and are in general much ornamented. The acephala furnish us also with peculiar types, not found elsewhere, as *Magas*, *Inoceramus*, *Hippurites*, and peculiar *Spondyli*, with long spines. There are also a great variety of gasteropoda, among which some peculiar forms of *Pleurotomaria*, *Rostellaria*, and *Pteroceras*, are very characteristic. The radiata are not inferior to the other classes in the novelty and variety of their forms. In figs. 387 and 388, some of the most characteristic fossil shells from the lower greensand strata are represented.

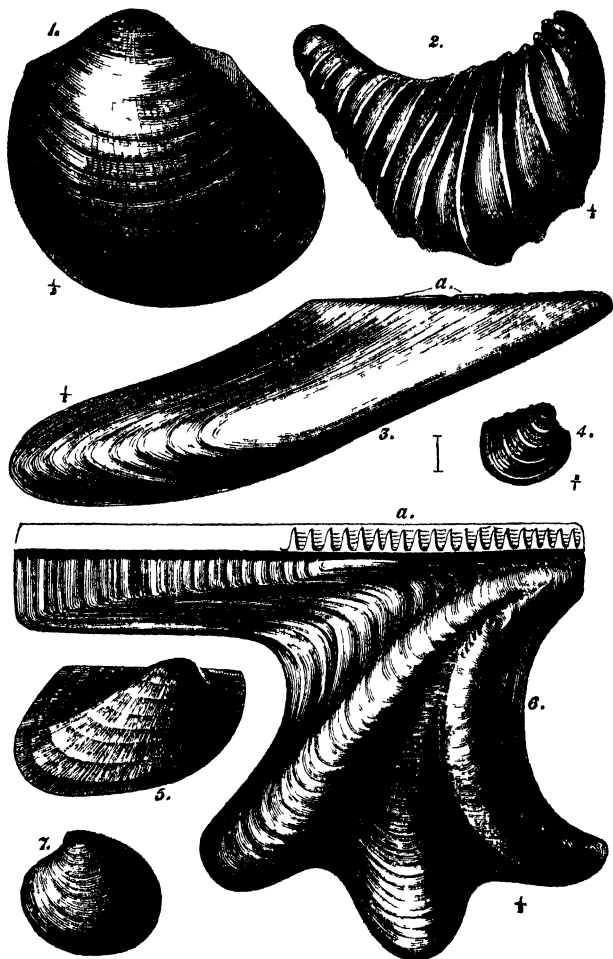

Fig. 387.—Fossil shells from the lower greensand of the Isle of Wight.

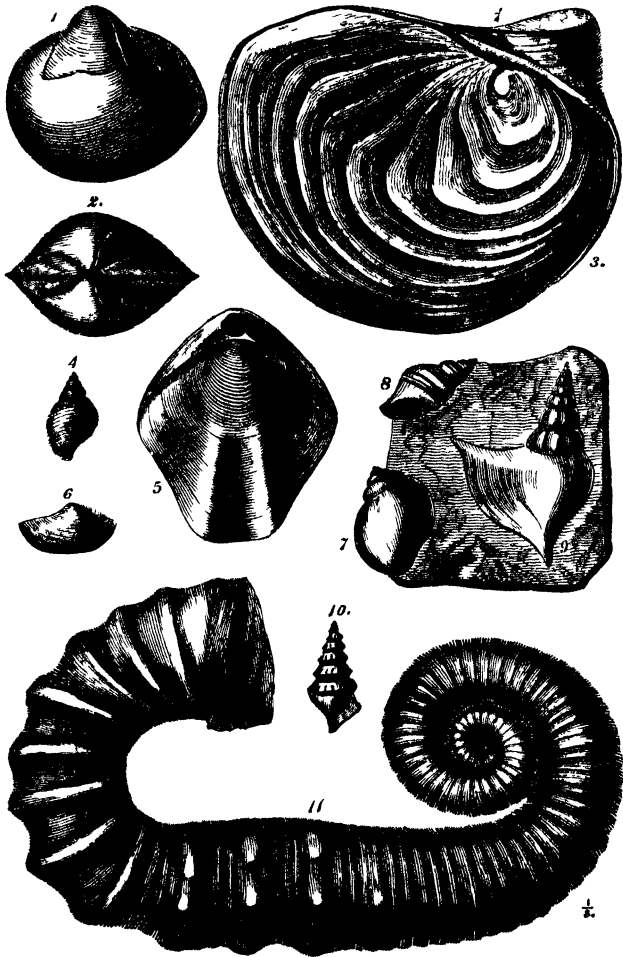

Fig. 388 —Fossil shells from the lower greensand of the Isle of Wight.

DESCRIPTION OF FIG. 387.

1. *Corbis corrugata*, from the sand-rock, Atherfield: the figure is one-half the size in linear dimensions of the original.
2. *Trigonia caudata*, from the sand-rock, Atherfield.
3. *Gervillia anceps*, from the Cracker Rocks, Atherfield; α denotes the markings of the hinge, which are seen in consequence of the valves being slightly displaced. It is represented half the size linear of the original. These shells are often much larger, and more elongated than in the figure.
4. *Venus striato-costata*; a small shell, common in the Cracker Rocks at Atherfield; the figure is twice the size of the original in linear dimensions.
5. *Arca Raulini*, from the sand-rock, Atherfield.
6. *Perna Mulleti*, from the lower beds of sand in conjunction with the Wealden, Sandown Bay; the figure is but half the size of the original: α , the structure of the hinge; by comparing this figure with α , No. 3, the difference of the hinge in the genera *Perna* and *Gervillia* will be recognized. This large and remarkable shell is highly characteristic of the lower beds of the greensand.
7. *Venus parva*, from Shanklin Cliff.

DESCRIPTION OF FIG. 388.

1. *Thetis minor*, from the ferruginous sand-rock at the base of Shanklin Cliff.
2. Another view of the same, to show the beaks and hinge-line.
3. *Exogyra sinuata*, represented one-fourth the natural size; it is often found much larger. From the greensand at Shanklin, Ventnor, Sandown, &c.
4. *Tornatella albensis*, from the Cracker Rocks, Atherfield.
5. *Terebratula sella*; an abundant shell in the sand at Atherfield.
6. *Nucula scapha*, from the sand-rock, Atherfield.

The three following shells are embedded in a fragment of the Cracker Rock, from Atherfield.
7. *Natica rotundata*.
8. *Pterocera retusa*.
9. *Rostellaria Robinaldini*.
10. *Cerithium turriculatum*, from Atherfield.
11. *Ancyloceras gigas*, from Atherfield. The figure is one-third the size, linear, of the original. This fossil is often found two feet in length, associated with *Ammonites* equally gigantic.

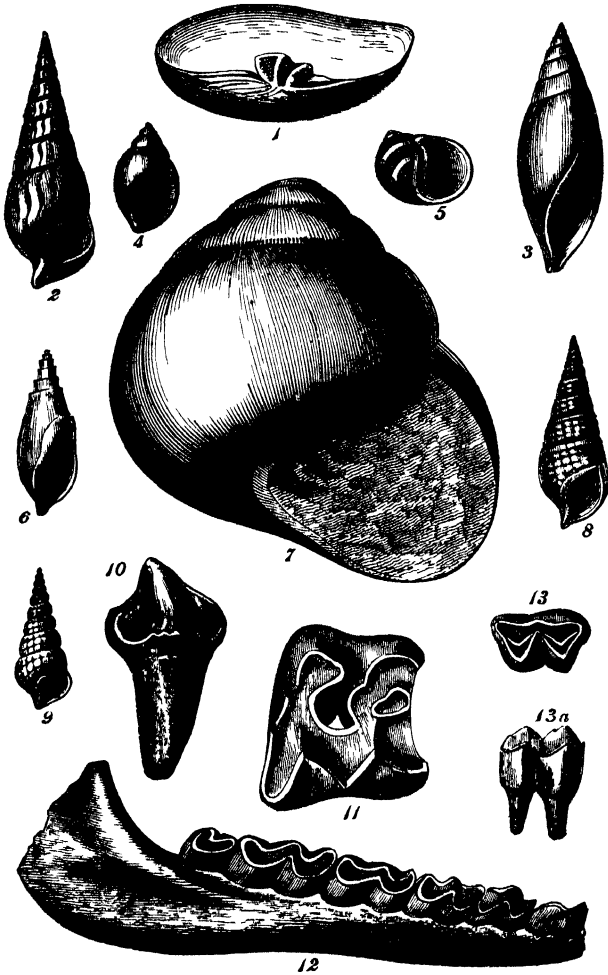

Fig. 389—Fossil shells and Mammalian remains, from the fresh-water strata of the Isle of Wight.

DESCRIPTION OF FIG. 389.

FOSSIL SHELLS AND TEETH OF MAMMALIA, FROM THE FRESH-WATER
Eocene STRATA OF THE ISLE OF WIGHT.

SHELLS.

Fig. 1.—*Potomomya gregaria*; from Headon Hill.

This shell is described by Mr. Sowerby in *Mineral Conchology* as *Mya gregaria*. The genus *Potomomya* (river mussels) comprises those species which inhabit rivers only, and are not found in estuaries and brackish waters.

- 2.—*Potamides concavus*; Headon Hill.
- 3.—*Melanopsis fusiformis*; Headon Hill.
- 4.————— *brevis*; Headon Hill.
- 5.—*Neritina concava*; Colwell Bay.
- 6.—*Melanopsis carinata*; Colwell Bay.
- 7.—*Helix globosus*; Shalfleet.
- 8.—*Potamides plicatus*; Headon Hill.
- 9.————— *ventricosus*; Headon Hill.

MAMMALIAN REMAINS. †

- 10.—Upper canine tooth of *Anoplotherium commune*; from Seafield near Ryde.
- 11.—The grinding surface of an *upper molar*, of *Palæotherium medium*; from Binstead.
- 12.—One side of the lower jaw of *Palæotherium minus*, with five teeth; from Seafield.*
- 13^a.—A tooth of *Dichobune cervinum*, from Binstead.
- 13.—The grinding surface of fig. 13^a.

With the exception of the gigantic snail-shell, fig. 7, the fossil shells here delineated are abundant at Headon Hill, and in the clays and marls at Colwell Bay. The Mammalian remains are of excessive rarity, and have hitherto only been found in the quarries near Ryde, and at Headon Hill. From the latter locality, Dr. Wright recently obtained a fine specimen of the jaw of a *Dicodon*, a new genus established by Professor Owen.

* See *British Fossil Mammals*, p. 323.

§ 678. TERTIARY AGE. *Reign of Mammals*.—The most significant characteristic of the Tertiary faunas is their great resemblance to those of the present epoch. The animals belong in general to the same families, and mostly to the same genera, differing only as to species. The specific differences, however, are sometimes so slightly marked, that a considerable familiarity with the subject is required, in order readily to detect them. Many of the most abundant types of former epochs have now disappeared. The changes are especially striking among the mollusca, the two great families of *Ammonites* and *Belemnites*, which present such an astonishing variety in the Oolitic and Cretaceous epochs, being now completely wanting. Changes of no less importance take place among the fishes, which are for the most part covered with horny scales, like those of the present epoch, while in earlier ages they were generally covered with enamel. Among the radiata, we see the family of crinoids reduced to a very few species, while, on the other hand, a great number of new star-fishes and sea-urchins make their appearance. There are besides, innumerable remains of a very peculiar type of animals, almost unknown in the former ages, as well as in the present period. They are little-chambered shells, known to geologists under the name of *Nummulites*, from their coin-like appearance, and which form in some countries very extensive layers of rocks.

§ 679. But what is more important, in a philosophical point of view, is, that aquatic animals are no longer predominant in Creation. The great marine or amphibian reptiles give place to numerous mammals of great size. For which reason we have called this age the *Reign of Mammals*.

§ 680. The lower stage of this formation is particularly characterized by great pachyderms, among which we may mention the *Palæotherium* and *Anoplotherium*, which have acquired such celebrity from the researches of Cuvier. These animals, among others, abound in the tertiary formations of the neighbourhood of Paris, and those of the Hampshire basin. The *Palæotheria*, of which several species are known, are the most common; they resemble, in some respects, the tapirs, while the *Anoplotheria* are more slender animals. In America are found the remains of a most extraordinary animal of gigantic size, the *Basilosaurus*, a true cetacean. Finally, in these stages, the earliest remains of monkeys have

been detected. In fig. 389 are figured the jaw and teeth of *Palæotheria*, from the tertiary strata of the Isle of Wight. 10 is the canine tooth of *P. commune*, and 11 the grinding surface of the molar tooth of *P. medium*; 12 is one half of the lower jaw of *P. minus*, and 13 are the molars of a *Dichobune*, another extinct genus of the PALÆOTHERIDÆ. The mollusca of the estuary beds of the same locality are figured in this plate. *Potomomya gregaria* (1), *Potamides concavus* (2), *Melanopsis fusiformis* (3), *M. brevis* (4), *Neritina concava* (5), *Melanopsis carinata* (6), *Potamides plicatus* (8) and *P. ventricosus* (9), *Helix globosus* (7).

§ 681. The fauna of the upper stages of the tertiary formation approaches yet more nearly to that of the present epoch. Besides the pachyderms, that were also predominant in the lower stage, we find numbers of carnivorous animals, some of them much surpassing in size the lions and tigers of our day. We meet also gigantic edentata, and rodents of great size.

§ 682. The distribution of the tertiary fossils reveals to us the important fact, that in this epoch animals of the same species were circumscribed in much narrower limits than before. The earth's surface, highly diversified by mountains and valleys, was divided into numerous basins, which, like the Gulf of Mexico, or the Mediterranean of our day, contained species not found elsewhere. Such was the basin of Paris, that of London, and in the United States, that of South Carolina.

§ 683. In this limitation of certain types within certain bounds, we distinctly observe another approach to the actual condition of things, in the fact that groups of animals which occur only in particular regions are found to have already existed in the same regions during the Tertiary epoch. Thus the edentata are the predominant animals in the fossil fauna of Brazil as well of its present fauna; and the marsupialia were formerly as numerous in New Holland as they now are, though they were in general of much larger size.

§ 684. THE MODERN EPOCH. *Reign of Man*. —The present epoch succeeds to, but is not a continuation of, the Tertiary age. These two epochs are separated by a great geological event, traces of which we see everywhere around us. The climate of the northern hemisphere, which had been, during the Tertiary epoch, considerably warmer than now, so as to allow of the growth of palm-trees in the temperate zone of our time,

became much colder at the end of this period, causing the polar glaciers to advance south, much beyond their previous limits. It was this ice, either floating as icebergs, or, as there is still more reason to believe, moving along the ground, like the glaciers of the present day, that, in its movement towards the south, rounded and polished the hardest rocks, and deposited the numerous detached fragments brought from distant localities, which we find everywhere scattered about upon the soil, and which are known under the name of *erratics*, *boulders*, or *greyheads*. This phase of the earth's history has been called, by geologists, the *Glacial* or *Drift period*, and is represented by the second circle of the frontispiece.

§ 685. After the ice that carried the erratics had melted away, the surface of North America and the North of Europe was covered by the sea, in consequence of the general subsidence of the continents. It is not until this period that we find, in the deposits known as the diluvial or *Pleistocene* formation, incontestable traces of the species of animals now living.

§ 686. It seems, from the latest researches of geologists, that the animals belonging to this period are exclusively marine; for, as the northern part of both continents was covered to a great depth with water, and only the summits of the mountains were elevated above it, as islands, there was no place in our latitudes where land or fresh-water animals could exist. They appeared therefore at a later period, after the water had again retreated; and, as from the nature of their organization, it is impossible that they could have migrated from other countries, we conclude that they were created at a more recent period than our marine animals.

§ 687. Among the land animals which then made their appearance, there were representatives of all the genera and species now living around us, and besides these, many types now extinct, some of them of a gigantic size, such as the *Mastodon*,* the remains of which are found in the uppermost strata of the earth's surface, and probably the very last large animal which

* The gallery of fossil remains in the British Museum contains a fine skeleton of the *Mastodon*, a splendid specimen of which, disinterred at Newburg, N. Y., is now in the possession of Dr. J. C. Warren, in Boston; the most complete skeleton which has ever been discovered. It stands nearly twelve feet in height, the tusks are fourteen feet in length and nearly every bone is present, in a state of preservation truly wonderful.

became extinct before the creation of man. In the continent of South America are found, in the drift of that region, the remains of another gigantic animal, the *Megatherium* (fig. 390), which resembles the armadillos of that country, but differs from all other quadrupeds in the colossal dimensions of its skeleton.

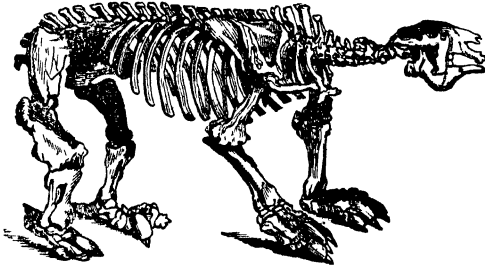

Fig. 390.—The *Megatherium*.

§ 688. It is necessary, therefore, to distinguish two periods in the history of the animals now living; one in which the marine animals were created, and a second, during which the land and fresh-water animals made their appearance, and at their head MAN.*

CONCLUSIONS.

§ 689. From the above sketch it is evident that there is a manifest progress in the succession of beings on the surface of the earth. This progress consists in an increasing similarity to the living fauna, and among the vertebrata, especially, in their increasing resemblance to Man.

§ 690. But this connection is not the consequence of a direct lineage between the faunas of different ages. There is nothing like parental descent connecting them. The fishes of the Palæozoic age are in no respect the ancestors of the reptiles of the Secondary age, nor does Man descend from the mammals which preceded him in the Tertiary age. The link by which they are connected is of a higher and immaterial nature; and their connection is to be sought in the view of the Creator

* The former of these phases is indicated in the frontispiece, by a circle, inserted between the upper stage of the Tertiary formation and the *Reign of Man* properly so called.

himself, whose aim, in forming the earth, in allowing it to undergo the successive changes which geology has pointed out, and in creating successively all the different types of animals which have passed away, was to introduce Man upon its surface. Man is the end towards which all the animal creation has tended, from the first appearance of the first Palæozoic fishes.

§ 691. In the beginning the Creator's plan was formed, and from it He has never swerved in any particular. The same Being who, in view of man's moral wants, provided and declared, thousands of years in advance, that "the seed of the woman shall bruise the serpent's head," laid up also for him, in the bowels of the earth, those vast stores of granite, marble, coal, salt, and the various metals, the products of its several revolutions; and thus was an inexhaustible provision made for his necessities, and for the development of his genius, ages in anticipation of his appearance.

§ 692. To study, in this view, the succession of animals in time, and their distribution in space, is therefore to become acquainted with the ideas of God himself. Now, if the succession of created beings on the surface of the globe is the realization of an infinitely wise plan, it follows that there must be a necessary relation between the races of animals and the epoch at which they appear. It is necessary, therefore, in order to comprehend Creation, that we combine the study of extinct species with that of those now living, since one is the natural complement of the other.* A system of zoology will consequently be true, in proportion as it corresponds with the order of succession among animals.

* In investigating the "*Ages of Nature*," much lasting and invaluable information will be derived from an earnest study of the magnificent collection of fossil remains contained in the palæontological department of the British Museum. The arrangement and naming of these monuments of nature, which mark the past revolutions of the earth, are now so far advanced by the great talents and zeal of Messrs. Waterhouse and Woodward, the present curators, that it has become a national educational saloon for this branch of natural history. In his visits to the gallery of organic remains, the student will obtain much aid and useful knowledge from Dr. Mantell's recent work, "*Petrifactions and their Teaching*; or, a Hand-book to the Gallery of Organic Remains of the British Museum." Bohn's Scientific Library, 1851.—EDITOR.

LIST OF THE MOST IMPORTANT AUTHORS

WHO MAY BE CONSULTED IN REFERENCE TO THE
SUBJECTS TREATED IN THIS WORK.

GENERAL ZOOLOGY.

Aristotle's Zoology ; Linnæus' System of Nature ; Cuvier's Animal Kingdom ; Oken's Zoology ; Humboldt's Cosmos, and Views of Nature ; Spix, History of Zoological Systems ; Cuvier's History of the Natural Sciences.

ANATOMY AND PHYSIOLOGY.

Henle's General Anatomy ; and most of the larger works on Comparative Anatomy, Physiology, and Botany, such as those of Hunter, Cuvier, Meckel, Müller, Burdach, Todd and Bowman, Grant, Owen, Carpenter, Rymer Jones, Hassall, Quain and Sharpey, Bourguery and Jacob, Wagner, Siebold, Milne Edwards, Carus, Schleiden, Burmeister, Lindley, Robert Brown, Dutrochet, Decandolle, A. Gray.

ON SPECIAL SUBJECTS OF ANATOMY AND PHYSIOLOGY MAY BE
CONSULTED

Schwann, on the Conformity in the Structure and Growth of Animals and Plants.

Dumas and Boussingault, on Respiration in Animals and Plants.

Valentin, on Tissues ; and Microscopic Anatomy of the Senses.

Sæmmering, Figures of the Eye and Ear.

Kölliker, Theory of the Animal Cell, and Mikroskopische Anatomie.

Breschet, on the Structure of the Skin.

Locomotion ; Weber and Dugés.

Teeth ; Fred. Cuvier, Geoff. St. Hilaire, Owen, Nasmyth, Retzius.

Blood ; Döllinger, Barry.

Digestion ; Spallanzani, Valentin and Brunner, Dumas and Boussingault, Liebig, Matteucci, Beaumont.

INSTINCT AND INTELLIGENCE.

Kirby, Blumenbach, Spurzheim, Combe.

EMBRYOLOGY.

D'Alton, Von Baer, Purkinje, Wagner, Wolfe, Rathke, Bischoff, Velpeau, Flourens, Barry, Leidy.

PECULIAR MODES OF REPRODUCTION.

Ehrenberg, Trembly, Rösel, Sars, Lovèn, Steenstrup, Van Beneden.

METAMORPHOSIS.

St. Merian, Rösel, De Geer, Harris, Kirby and Spence, Burmeister, Reaumur.

GEOGRAPHICAL DISTRIBUTION.

Zimmerman, Milne Edwards, Swainson, A. Wagner, Forbes, Pennant, Richardson, Ritter, Guyot.

GEOLOGY.

The Works of Murchison, Phillips, Lyell, Mantell. Hugh Miller, Agassiz, D'Archiac, De Beaumont, D'Orbigny, De Verneuil, Cuvier, Brongniart, Deshayes, Morton, Hall, Conrad, Hitchcock, Troost, and the Reports on the various local Geological Surveys.

Very many of the papers of the authors above referred to are not published in separate treatises, but are scattered through the volumes of Scientific Periodicals; such as the

Transactions of the Royal Society of London.

Annals and Magazine of Natural History.

Annales, and Archives, du Museum d'Hist. Naturelle.

Annales des Sciences Naturelles.

Wiegmann's Archiv für Naturgeschichte.

Müller's Archiv.

Oken's Isis.

Berlin Transactions.

Transactions of the American Philosophical Society.

Memoirs of the American Academy.

Journal of the Academy of Nat. Sciences, Philadelphia.

Silliman's Journal.

Journal of Boston Society of Natural History.

GENERAL AND GLOSSARIAL INDEX.

Note.—The Arabic figures refer, not to the pages, but to the numbered sections; the Roman numerals indicate the pages of the Introduction.

- A, a Greek prefix, signifying generally "without," as in *Abranchiata* (without gills, *βραγχια*), which see.
- Abdo'men (Lat. *abdo*, I conceal), the posterior and principal cavity of the animal, containing the bowels and many other viscera. The abdomen is distinct from the thorax in crustaceans, spiders and insects, 60.
- Abranchia'ta (Gr. *á*, without; *βραγχια*, gills), mollusks devoid of gills, xxii.
- Acale'pha (Gr. *άκαληφη*, a nettle), radiates with soft skins, which have the property of stinging like a nettle, xxiii.
- Acale'phæ, digestion in the, 315.
- Ac'arus (Gr. *άκαρι*, a mite), arachnides, as the cheese-mite and allied species.
- Aceph'ala, Aceph'alous (Gr. *ά*, without; *κεφαλή*, head), headless; animals in which a distinct head is never developed, xxii. 662.
- Acetab'ula (Lat. *acetabulum*, a shallow cup), fleshy sucking cups, with which many of the invertebrate animals are provided.
- Acetab'ulum, the, in man, 263.
- Ac'ini (Lat. *acinum*, a berry), the secreting parts of glands, which are suspended like grains or small berries to a slender stem.
- Acotyl'edons, plants without a distinct cotyledon, 69.
- Acous'tic (Gr. *άκουο*, I hear), appertaining to sound, or the organ of hearing.
- Ac'rita (Gr. *άκριτος*, confused), a term applied to the lowest animals, in which the organs, and especially the nervous system, were supposed to be confusedly blended with the other tissues.
- Actin'ia (Gr. *άκτιν*, a ray), polyps with many arms radiating from around the mouth.
- Actino'ceras (Gr. *άκτιν*, a ray; *κερας*, a horn), a generic term signifying the radiated disposition of the horns or feelers.
- Actin'oids, polyps, as the coral-polyps, xxiii.
- Adipose' (Lat. *adeps*, fat), fatty.
- Affinities and analogies, 16.
- Ages of nature, 656—690.
- Air, changes effected in, by respiration, 393.
- A'lar (Lat. *ala*, a wing), belonging to a wing.
- Albu'men (Latin), the white of an egg, 446.
- Albu'minous, consisting of albumen.
- Al'iform (Lat. *aliformis*), shaped like a wing.
- Aliment'ary canal, the, 312.
- Alimenta'tion, or nutrition, 62.
- Allan'tois (Greek), a vesicular organ

- in connection with the intestine, which makes its appearance during the development of the embryo, 472.
- Alliga'tor, teeth of the, 340.
- Allu'vium (Latin), sand, gravel, &c., brought down by rivers.
- Alter'nate generation, 518—547.
- Alter'nate reproduction, 516—532; consequences of, 533, 547; differences between, and metamorphosis, 536.
- Ambula'cra (Lat. *ambulacrum*, an avenue or place for walking), the perforated series of plates in the shell of the sea-star or sea-urchin.
- Am'bulatory (Lat. *ambulo*, I walk), an animal, or a limb for walking.
- America, distribution of the faunas of, 596—619.
- Am'monites, an extinct genus of mollusks, allied to the nautilus, which inhabited a chambered shell, called Ammonite, from its resemblance to the horns on the statues of Jupiter Ammon, xxii. 675.
- Amor'phous (Gr. *á*, without; *μορφή*, form), bodies devoid of regular form.
- Amphibious (Gr. *ἀμφί*, two, *βίος*, life), having the faculty of living both in water and on land, 306.
- Amphiox'us, a genus of fishes, peculiar structure of the, 567.
- Am'phipods (Gr. *ἀμφί*, on both sides; *πούς*, a foot), an order of crustacea which have feet for both walking and swimming.
- Amphisto'ma (Gr. *ἀμφί*, on both sides; *στόμα*, a mouth), suctorial parasitic worms, which have pores like mouths at both ends of the body.
- Amphiu'ma, a batrachian, 626.
- Ampul'la (Lat. *a bottle*), a membranous bag, shaped like a leathern bottle, 158.
- An'æma (Gr. *á*, without; *αἷμα*, blood), the name given by Aris-
totle to the animals which have no red blood, and which he supposed to be without blood.
- An'alogue, a part or organ in one animal which has the same function as another part or organ in a different animal; see HOMOLOGUE.
- Anal'ogy, distinguished from affinity, 16.
- Anas'tomose (Gr. *ἀνα*, through; *στόμα*, mouth), when the mouths of two vessels come into contact and blend together, or when two vessels unite as if such kind of union had taken place.
- Anat'ifa, or duck barnacle, metamorphoses of the, 553—556.
- Androg'ynous (Gr. *ἀνήρ*, a man; *ἡ*, a woman), the combination of male and female parts in the same individual.
- Anella'ta (Lat. *annelus*, a little ring), worms, in which the body seems to be composed of a succession of little rings, characterised by their red blood.
- Anel'lide, the anglicised singular of *Anellata*.
- An'enterous (Gr. *á*, without; *έντερον*, a bowel), the animalcules of infusions which have no intestinal canal.
- Animal heat, 399.
- Animal life, organs and functions of, 76—184.
- Animal and vegetable kingdoms, three great divisions of the, 67.
- Animal'cule (dim. of *animal*), a very minute animal.
- Animals, extinct, 629.
- Animals, geographical distribution of, 578—641; general laws, 578—594; the faunas, 595—622; conclusions, 623—641.
- Animals, geological succession of, 642—690.
- Animals, metamorphoses of, 548—577.

- Animals and plants, differences between, 57—74; resumé, 75.
- An'imate, possessed of animal life.
- Annel'ida, or Annel'ids, digestive organs of the, 322—324; respiration, 382.
- Annula'ted (Lat. *annulus*, a ring), when an animal or part appears to be composed of a succession of rings.
- Anoplothe'rium (Gr. *ἀνοπλος*, unarmed; *θηρίον*, beast), an extinct mammal, somewhat resembling the pig, but unprovided with tusks or offensive arms, 680.
- An'ourous (Gr. *ἀ*, without; *ουρα*, a tail), tail-less.
- Anten'na (Lat. *a yard-arm*), applied to the jointed feelers, or horns, upon the heads of insects and crustacea; and sometimes to the analogous parts which are not jointed in worms and other animals.
- Anthozo'a (Gr. *άνθος*, a flower; *ζῶον*, an animal), polyps (including the actinia and allied species), commonly called animal flowers.
- Antiperistal'tic (Gr. *ἀντί*, against; and *peristaltic*), when the vermicular contractions of a muscular tube follow each other in a direction the reverse of the ordinary one; see PERISTALTIC.
- Ant'lia (Lat. *a pump*), restrictively applied to the spiral instrument of the mouth of butterflies and allied insects, by which they pump up the juices of plants.
- Aor'ta (Gr. *ἀορτή*, the wind-pipe; and also the name of the great vessel springing from the heart, which is the trunk of the systemic arteries); it is exclusively applied in the latter sense in modern anatomy.
- Aphid'ian, belonging to the aphid.
- A'phis (Greek), the aphid, or plant-louse, one of the articulatæ, alternate generation of the, 526.
- Ap'ical (Lat. *apex*, the top of a cone), belonging to the pointed end of a cone-shaped body.
- Ap'odal (Gr. *ἀ*, without; *πόδι*, feet), footless, without feet or locomotive organs; fishes are so called which have no ventral fins.
- Apoph'ysis (Greek), a projection from the body of a bone.
- Apparatus of motion, 205—227.
- Ap'tera (*ἀ*, without; *πτερόν*, a wing), wingless insects, xxii.
- Ap'terous (Gr. *ἀ*, without; *πτερόν*, a wing), wingless species of insects or birds.
- Aquat'ic (Lat. *aqua*, water), living in water.
- Aquat'ic animals, water tubes of, 403.
- A'queous, like water.
- A'queous humour of the eye, 127.
- Arach'nida (Gr. *ἀραχνη*, a spider), a class of articulates; as spiders and allied animals.
- Arach'nidæ, or Arach'nids, digestive organs of the, 326; jaws, 337; respiration, 385.
- Arach'noid membrane, 85.
- Arbores'cent (Lat. *arbor*, a tree), branched like a tree.
- Arctic (Gr. *Ἄρκτος*, the Bear, a northern constellation, thus signifying northern) fauna, the, 602—604.
- Are'olar (Lat. *areola*, a nipple tissue, 41.
- Aristotle's lantern, jaws of the Echinidæ, so called, 335.
- Arm of man, 281; corresponding organ in other animals, 282—286.
- Ar'teries, 357.
- Arthro'dial (Gr. *αρθρον*, a joint); it is restricted to that form of joint in which a ball is received into a shallow cup.
- Articula'ta (Lat. *articulus*, a joint), a department of the animal kingdom, consisting of animals with

- external jointed skeletons or jointed limbs; as the leech, the spider, the gnat, xxii.
- Articula'ta, or Artic'ulates, 70; nervous system, 115; jaws, 337; of the trias period, 665, 670.
- Ascid'ian (Gr. *ἄσκος*, a bottle), shell-less acephalous mollusks, shaped like a leathern bottle.
- Assimila'tion, the change of blood into bone, muscle, &c. 401.
- Asteria'dæ (Gr. *ἄστρον*, a star), the family of star-fishes, xxiii.
- Astre'idæ, a family of polyps, found in the Coral-rag, 674.
- Au'ditory (Lat. *audio*, I hear), pertaining to the sense of hearing.
- Au'ricle (Lat. *auricula*), a cavity of the heart, shaped like a little ear, 301.
- Austra'lia, fauna of, 615.
- Autoch'thoni (Greek), Aborigines, or first inhabitants, theory of, applied to the distribution of animals, 631.
- Automat'ic (Gr. *αὐτοματός*, self-moving), a movement in a living body without the intervention or excitement of the will.
- Aves (Latin), birds; the second class of vertebrate animals, xxi.
- Axil'la (Lat. *arm-pit*), applied to other parts of the animal body which form a similar angle.
- Ax'olotl, a genus of reptiles, 626.
- Az'ygos (Gr. *ἄ*, without; *ζυγός*, yoke), single, without fellow.
- BA'CULITE (Lat. *baculus*, a staff), an extinct genus of mollusks, allied to the nautilus, which inhabited a straight-chambered shell, resembling a staff.
- Bal'anoids (Gr. *βαλανός*, an acorn), a family of sessile cirripeds, the shells of which are commonly called acorn shells.
- Bar'nacle; see Anatifa.
- Bas'ilar (Lat. *basis*, a base), belonging to the base of the skull.
- Bas'ilosaurus, an extinct cetacean, 680.
- Batra'chians (Gr. *βάτραχος*, a frog), the order of reptiles including the frog, xxi.
- Batra'chians, peculiar species of, 626.
- Belem'nite (Gr. *βέλεμνος*, a dart), an extinct genus of mollusks; animals allied to the sepia, and provided with a long, straight, chambered conical shell in the interior of the body, 673.
- Bi, or Bis, a Latin prefix, signifying "twice," as in the following words:
- Bi'fid, cleft into two parts, or forked.
- Bi'furcate, divided into two prongs or forks.
- Bi'lateral, having two symmetrical sides.
- Bi'lobed, divided into two lobes.
- Bip'artite, divided into two parts.
- Bi'peds (Lat. *bis*, two, *pes*, a foot), animals with two feet, as man and birds.
- Bird tracks, fossil, 670.
- Birds, the second division of the animal kingdom, xxi.
- Birds, muscular system of, 227; stomach of, 330.
- Bis (Latin), two, or twice; used in composition only.
- Bi'valve, a shell of two parts, closing like a double door, 662.
- Blas'toderm, the embryonic germ.
- Blood, the, and circulation, 350—375.
- Blood, the, its constituents, 350—351; corpuscles, 352; colour, 353; its presence an essential condition of life, 354; circulation, 361—375; changes that it undergoes in circulation, 395.
- Bone, analysis of, 238; basis, 239; microscopic structure, 240; the various bones of the human skeleton, 235, 241—278.
- Bot'ryo'i'dal (Gr. *βοτρυς*, a bunch of grapes), having the form of a bunch of grapes.
- Bould'ers, 684.

- Brach'ial** (Gr. *βραχιον*, the arm), belonging to the arm.
- Brach'io-pods** (Gr. *βραχιον*, the arm; *ποδα*, feet), acephalous mollusks, with two long spiral fleshy arms continued from the side of the mouth, xxiii.
- Brachyu'ra** (Gr. *βραχύς*, short, *ουρα*, tail), crustacea with short tails, as the crabs.
- Brachyu'rous**, short tailed, usually restricted to the crustacea.
- Brain**, 78; in man, 85—88; in fishes, 92; in the amphibia, 93; in scaly reptiles, 94; in birds, 95; in mammalia, 96.
- Bran'chia** (Gr. *βραγχια*, the gills of a fish), the respiratory organs which extract oxygen from the air contained in water.
- Bran'chifers** (Gr. *βραγχια*, gills; Lat. *fero*, I bear), univalve mollusks breathing by gills, xxiii.
- Bran'chiopods** (Gr. *βραγχια*, gills; *ποδα*, feet), crustacea, in which the feet support the gills.
- Bron'chi**, tubes branching from the windpipe in the lungs.
- Bron'tes**, a genus of the family Trilobitidæ.
- Bryozo'a** (Gr. *βρυον*, moss; *ζωον*, animal), a class of highly organized polyyps, most of the species of which incrust other animals or bodies like moss, xxiii. 661.
- Buc'cal** (Lat. *bucca*, mouth or cheeks), belonging to the mouth.
- CÆ'cum** and **CÆ'ca** (Lat. *cæcus*, blind), a blind tube, or productions of a tube, which terminate in closed ends.
- Calca'reous** (Lat. *calx*, chalk), composed of lime.
- Camel**, skeleton of the, 291.
- Campanula'ria**, alternate generation of the, 350—352.
- Canine'** (Lat. *canis*, a dog) teeth, 341.
- Canker-worm**, metamorphoses of the, 552.
- Can'non-bone**, the metacarpal bone of the horse and stag, 282, 286.
- Cap'illary vessels** (Lat. *capillus*, a hair), the minute vessels through which the arteries and veins are united, 358, 371.
- Carapace'**, the upper shell of the crab and tortoise, 318.
- Car'bon** (Lat. *carbo*), the basis of charcoal and most combustibles.
- Carbonif'erous**, or coal, formation, 650, 669.
- Car'dia** (Gr. *καρδια*, the heart or stomach), the opening which admits the food into the stomach; also the region called the pit of the stomach.
- Carniv'ora** (Lat. *caro*, flesh; *voro*, I devour), animals which feed on flesh, xxi.
- Car'pus** (Latin), the wrist, 275.
- Cartilag'inous**, or gristly, tissue, 42, 52.
- Cau'dal** (Lat. *cauda*, a tail), belonging to the tail.
- Cau'da Equi'na** (Lat. *horse-tail*), the leash of nerves which terminates the spinal marrow in the human subject, and the analogous part in the lower animals.
- Cell** (Lat. *cella*), the universal elementary form of every tissue, 56.
- Cellule'**, a little cell.
- Cel'lular tissue** (Lat. *cella*, a cell), the elastic connecting tissue of the different parts of the body which everywhere forms cells or interspaces containing fluid, 53, 56.
- Centipede** (Lat. *centum*, a hundred; *pes*, a foot), a genus of insects with very numerous feet.
- Cent'rum** (Gr. *κεντρον*, centre), the body or essential elements of a vertebra, around which the other elements are disposed.
- Cephal'ic** (Gr. *κεφαλή*, head), belonging to the head.
- Cephal'opods** (Gr. *κεφαλή*, head; *ποδα*, feet), mollusks in which

- long prehensile processes or feet project from the head, xxii, 663, 673.
- Cephal'o-tho'rax (Gr. κεφαλή, head; Lat. *thorax*, chest), the anterior division of the body in spiders, scorpions, &c., which consists of the head and chest blended together.
- Cerca'ria, alternate generation exemplified in the, 520—524.
- Cerca'riæ (Gr. κερκος, a tail), animalcules whose body is terminated by a tail-like appendage.
- Cerebel'lum, or little brain, in man, 87.
- Cer'ebral nerves, 97—114.
- Cer'ebrum, or brain, in man, 86.
- Cestra'cion Phil'lipii, a living representative of the fishes of a former age, 615.
- Ceta'cea, or Ceta'ceans (Lat. *cete*, a whale), marine animals, which nurse their young, like the whale, porpoise, &c., xxi. 304.
- Chala'za, the albuminous thread by which the yolk of the egg is suspended, 446.
- Chalk formation, 650.
- Chart of zoological regions, 595—622.
- Chelo'nia (Gr. χελώνη, a turtle), the order of reptiles including the tortoises and turtles, xxi.
- Che'le (Gr. χηλή, a claw), applied to the bifid claws of the crustacea, scorpions, &c.
- Chick, development of the, first period, 482—485; second period, 486—492; third period, 493—497; birth, 498; physical and chemical changes in the egg during incubation, 499.
- Chil'ognatha (Gr. χείλος, a lip; γνάθος, a jaw), the order of many-footed insects, typified by the gally-worm or julus.
- Chi'tine (Gr. χιτων, a coat), the peculiar chemical principle which hardens the integument of insects.
- Chol'edochus (Gr. χολή, bile; δοχε, receptacle), the tube formed by the union of the hepatic and cystic ducts.
- Cho'rion, from the Greek word signifying the membrane which encloses the fœtus, and applied generally to the outer covering of the ovum, 475.
- Cho'roid, one of the coats of the eye, 124.
- Chrys'alis (Gr. χρυσός, gold), the stage of the butterfly immediately preceding its period of flight, when it is passive, and enclosed in a case, which sometimes glitters like gold.
- Chyle (Gr. χυλός, juice), nutrient fluid extracted from digested food by the action of the bile, 333.
- Chylifica'tion, 332.
- Chyme (χυμός, juice), digested food which passes from the stomach into the intestines, 331.
- Chymifica'tion, 331.
- Cil'ia (Lat. *cilium*, an eye-lash), microscopic hair-like bodies, which cause, by their vibratile action, currents in the contiguous fluid, or a motion of the body to which they are attached, 216.
- Cil'iary motions, 211, 216, 217.
- Cilia'ted, provided with vibratile cilia.
- Ciliobrachia'ta (Lat. *cilium*, an eye-lash; Gr. βραχίον, the arm), polyps, in which the arms are provided with vibratile cilia.
- Ciliogrades' (Lat. *cilium*, an eye-lash; *gradior*, I walk), acalcephæ which swim by the action of cilia.
- Circulation, the, 350—375; its course in the mammalia, 364, 365; in reptiles, 366; in fishes, 367; in mollusca, 368; in crustacea, 369; in insects, 370; in cold-blooded animals, 373.
- Cir'ri (Lat. *cirrus*, a curl), curled filamentary appendages, as the feet of the barnacles.

- Cirrig'erous, supporting cirri.
- Cirrigrades', moving by cirri.
- Cirripeds, or Cirripedia (Lat. *cirrus*, a curl; *pes*, a foot), articulate animals having curled jointed feet, sometimes written *cirrhopedia* and *cirrhopoda*.
- Classes, a subdivision of the animal kingdom, xx; again divided into orders, xx.
- Clavate (Lat. *clavus*, a club), club-shaped; linear at the base, but growing gradually thicker towards the end.
- Clavicle, the, or shoulder blade, 271.
- Climatic, insufficient alone to account for the geographical distribution of animals and plants, 638—641.
- Climate, the polar, its influence on animals, 582.
- Climbing, 298.
- Cloaca (Latin, *a sink*), the cavity common to the termination of the intestinal, urinary, and generative tubes.
- Clypeiform (Lat. *clypeus*, a shield; *forma*, shape), shield-shaped, applied to the large prothorax in beetles.
- Coal period, flora of the, 669.
- Coc'costeus, an extinct genus of fishes from the Devonian rocks, 667.
- Coc'cyx, the, 258.
- Coch'lea, one of the divisions of the internal ear, 154.
- Cold-blooded animals, as reptiles, fishes, &c. 400.
- Coleop'tera (Gr. *κολεός*, a sheath *περόν*, a wing), the order of insects in which the first pair of wings serves as a sheath to defend the second pair, as the common dor-beetle.
- Columel'la (Lat. *a small column*), used in conchology to signify the central pillar around which a spiral shell is wound.
- Comat'ula, a genus of the family Crinoidea.
- Comat'ula, metamorphoses of the, 559.
- Commis'suræ (Lat. *committo*, I solder), belonging to a line or part by which other parts are connected together.
- Compa'ges (Latin), a system or structure of united parts.
- Con'chifers (Lat. *concha*, a shell; *fero*, I bear), shell-fish, usually restricted to those with bivalve shells.
- Cor'al rag, a stage of the oolite, 674.
- Coria'ceous (Lat. *corium*, hide), when a part has the texture of tough skin, 413.
- Cor'nea (Lat. *corneus*, horny), the transparent horny membrane in front of the eye, 123.
- Cor'neous, horny.
- Cor'neule (diminutive of *cornea*), applied to the minute transparent segments which defend the compound eyes of insects.
- Cor'nua (Lat. *cornu*, a horn), horns or horn-like processes.
- Cor'puscles (diminutive of *corpus*, a body), minute bodies.
- Cotyl'edon (Greek), a seed lobe.
- Creta'ceous (Lat. *creta*, chalk), belonging to chalk.
- Creta'ceous formation, 650, 675; fauna, 675.
- Crinoid' (Gr. *κρινον*, a lily; *είδος*, like), belonging to the Echinodermata, which resemble lilies; the fossils called stone lilies, or encrinites, are examples, xxiii.
- Crio'ceras, a genus of the family Ammonitida.
- Cru'ra (Lat. *crus*, a leg), the legs of an animal, or processes resembling legs.
- Crusta'cea (Lat. *crusta*, a crust), the class of articulate animals with a hard skin or crust, which they periodically cast, xxii.

- Crusta'cea, or Crusta'ceans, digestive organs of the, 325; jaws, 337; circulation, 369; respiration, 381, 405.
- Crypts, or follicles, 415.
- Crys'talline-lens, a transparent lenticular body, situated behind the pupil of the eye, 126.
- Cte'noids (Gr. κτενεις, a tooth), fishes which have the edge of the scales toothed, xxi.
- Cte'nophori, soft radiated animals moving by cilia, xxiii.
- Cuttle-fish, jaws of, 321; metamorphosis of, 563; mode of escape, 321; mode of swimming, 305.
- Cu'tis (Lat.), the true skin, the part which is tanned to form leather.
- Cy'clobranchia'ta (Gr. κυκλος, round; βραγchia, gills), molluscous animals which have the gills disposed in a circle.
- Cy'cloids, fishes with smooth scales, xxi.
- DEC'APODA (Gr. δεκα, ten; πους, a foot), crustaceous and molluscous animals which have ten feet.
- Decid'uous, parts which are shed, or do not last the lifetime of the animal.
- Deflect'ed, bent down.
- Degluti'tion, 345.
- Dendrit'ic (Gr. δενδρον, a tree), branched like a tree.
- Departments, primary divisions of the animal kingdom, xxi; subdivided into classes, xxi.
- Der'mal (Gr. δερμα, skin), belonging to the skin.
- Development of the chick, 482—499.
- Devonian formation, 650.
- Di'aphragm, the partition between the chest and abdomen, 209.
- Di'astole, the dilatation of the heart, 363.
- Di'branchia'ta (Gr. δις, twice; βραγchia, gills), cephalopods having two gills.
- Dicotyl'edons, plants with two seedlobes, 74.
- Di'dactyle (Gr. δις, twice; and δακτυλος, a finger), a limb terminated by two fingers.
- Digestion, 312, 349; in the infusoria, 314; acalepha, 315; echinoderma, 316; polypifera, 317; mollusca, 318—321; annelida, 322—324; crustacea, 325; arachnida, 326; insects, 327; vertebrata, 328; microscopic examination, 329; the stomach, 330; chymification, 331—334; mastication, 335—341; harmony of organs, 342—344; insalivation, 345; deglutition; 346—349.
- Digestive organs; see Digestion.
- Digitate' (Lat. *digitus*, a finger), when a part supports processes like fingers.
- Dilu'vium (Latin), a deposit from the water of a flood or deluge.
- Dimidia'te (Lat. *dimidium*, half), divided into two halves.
- Dimy'ary (Gr. δις, twice; μυον, a muscle), a bivalve whose shell is closed by two muscles.
- Dip'tera (Gr. δις, twice; πτερον, a wing), insects which have two wings.
- Dis'coid (Lat. *discus*, a quoit), quoit-shaped.
- Discopho'ri, soft radiates, or jelly-fishes, xxiii.
- Disk (Lat. *discus*, a quoit), a more or less circular flattened body.
- Disto'ma (Gr. δις, two; στομα, mouth), the intestinal worms with two pores.
- Dist'oma, alternate generation exemplified in the, 521.
- Distribution, geographical, of animals, 578—641.
- Distribution in time of animals, 642.
- Di'verticulum (from the Latin for a bye-road), applied to a blind tube branching out from the course of a longer one.
- Do'do, an extinct bird, 629.
- Dor'sal (Lat. *dorsum*, the back), towards the back.
- Dor'sal cord, in the germ, 459.

- Dor'sal vessel, in insects, 359.
- Dorsibranchia'ta (Lat. *dorsum*, the back; Gr. *βραγχία*, gills), mollusks with gills attached to the back, xxii.
- Drift formation, 650, 684.
- Duc'tus (Latin), a duct, or tube, which conveys away the secretion of a gland.
- Duode'num (Lat. *duodecim*, twelve), the first portion of the small intestine, which in the human subject equals the breadth of twelve fingers.
- Du'ra ma'ter, 85.
- E, Ex, a Latin prefix, signifying generally "without," or "from," as Edentata, Exomose; which see.
- Ear, the, 145—161.
- Earth's crust, structure of the, 642—655.
- Echinas'ter sanguinolentus, metamorphoses of the, 557, 558.
- Ech'ini, an order of Echinoderms, xxiii.
- Echin'oderms (Gr. *ἐχίνος*, a hedgehog; *δέρμα*, skin), the class of radiated animals, most of which have spiny skins, xxiii.
- Echin'oderms, 661; internal organs of the, 316; jaws of the, 335.
- Eden'tata (Lat. *ex*, without, *dens*, a tooth), a class of mammals, in which the teeth are in some degree incomplete; as in the armadillo.
- Eden'tulous, from the Latin word for toothless.
- Egg, the, all animals produced from, 433, 434; form, 435; formation, 436—446; development of the young, 447—479; structure as just laid, 480; changes in, during incubation, 499.
- Elementary structure of organized bodies, 35; of tissue, 56.
- El'ytra (Gr. *ἐλυτρον*, a sheath), the wing sheaths formed by the modified anterior pair of wings of beetles
- Emar'ginate (Lat. *emargino*, to remove an edge), when an edge or margin has, as it were, a part bitten out.
- Em'bryo (Latin), the earliest stage of the young animal before birth, 433.
- Embryol'ogy, 429—509; the egg, 429—446; development of the young, 447—499; zoological importance of embryology, 500—509.
- Enal'iosaur (Gr. *ενάλιος*, marine; *σαυρος*, a lizard), an extinct order of marine gigantic reptiles allied to crocodiles and fishes.
- Enceph'ala (Gr. *εν*, in; *κεφαλή*, head), molluscous animals which have a distinct head.
- Endog'enous, increasing by inward addition, as the palm tree, 72.
- Endosmose' and exosmose', 411, 413.
- Entomol'ogy (Gr. *έντομα*, insects; *λόγος*, a discourse), the department of natural history which treats of insects.
- Entomos'tracans (Gr. *έντομα*, insect; *οστρακον*, shell), small crustaceans, many of which are enclosed in an integument, like a bivalve shell, xxii.
- Entozo'a (Gr. *εντος*, within; *ζών*, animal), animals which exist within other animals.
- Eocene' (Gr. *ειως*, the dawn; *καινος*, recent), the stage of the tertiary period, in which the extremely small proportion of living species indicates the first commencement or dawn of the existing state of animate creation, 650.
- Epider'mal (Gr. *επιδερμικς*, the cuticle), belonging to the cuticle or scarf skin, 413.
- Epister'nal (Gr. *επι*, upon; *στερνον*, the breast-bone), the piece of the segment of an articulate animal which is immediately above the middle inferior piece, or sternum.

- Epithe'lium**, the thin membrane which covers the mucous membranes: it is analogous to the epiderm of the skin.
- Epizo'a** (Gr. *επι*, upon; *ζῶον*, animal), the class of low organised parasitic crustaceans which live upon other animals.
- Errat'ics**, rolling stones, 684.
- Eusta'chian tube**, the, 146.
- Excit'o-mo'tory**, the function of the nervous system, by which an impression is transmitted to a centre, and reflected so as to produce the contraction of a muscle without sensation or volition.
- Exog'enous**, increasing by outward addition, as in the case of most trees, 74.
- Exosmose'** (Gr. *εξ*, out of; *οθεο*, I expel), the act in which a denser fluid is expelled from a membranous sac by the entry of a lighter fluid from without, 411, 413*.
- Exuvium** (Latin, *the skin of a serpent*), the skin which is shed in moulting.
- Exu'vial**, any part which is moulted.
- Eye**, the, 121—129; dioptrics of the human, 130—134; simple, 135—140; aggregate, 141; compound, 142, 143; rudimentary, 144.
- Eye-lids and eye-lashes**, 129.
- FAÇ'ETTE** (French), a flat surface with definite boundary, 142.
- Fa'cial nerve**, 103.
- Families**, a group of the animal kingdom, xx.; divided into genera, xx.
- Fas'cicle** (Lat. *fasciculus*), a small bundle.
- Fau'na** (Latin), the animals peculiar to a country, 579; general considerations, 579—594; the arctic, 602—604; the temperate, 605—615; the tropical, 616—622; conclusions, 623—641.
- Fe'mur** (Latin), the thigh bone, 264.
- Fib'ula**, the smallest of the two bones of the leg, 265.
- Fil'iform** (Lat. *filum*, a thread; *forma*, a shape), thread-shaped, 420.
- Fishes**, the fourth division of the animal kingdom, xxi.
- Fishes**, 667; muscular system of, 227; jaws, 340; circulation, 367; respiration, 383.
- Fishes**, reign of, 659—669.
- Fissip'arous** (Lat. *findo*, I cleave; *pario*, I produce), the multiplication of a species by the cleavage of the individual into two parts, 510.
- Fissip'arous and gemmip'arous reproduction**, 510—515.
- Flabel'liform** (Lat. *flabellum*, a fan), fan-shaped.
- Flex'ors** (Lat. *flecto*, I bend), the muscles employed in bending a limb.
- Flex'uous**, a bending course.
- Flo'ra** (Latin), the plants peculiar to a country, 579; of the coal period, 669; of the oolitic period, 671.
- Flu'viate** (Lat. *fluvius*, a river), pertaining to rivers.
- Flying**, 300.
- Fœ'tus** (Latin), the animal in the womb, after it is perfectly formed.
- Folia'ceous** (Lat. *folium*, a leaf), shaped or arranged like leaves.
- Fol'licles** (Lat. *folliculus*, a small bag), minute secreting bags which commonly open upon mucous membranes, 415, 421.
- Food**, various methods of securing, by different animals, 346—349.
- Foot**, the, 266—268.
- Footsteps**. fossil, 672.
- Foraminif'era**, a class of microscopic radiated animals having many chambered shells, the septæ of which are perforated.
- Formations**, geological, 649—655.
- Fossilif'erous** (Lat. *fossilis*, anything dug out of the earth; *fero*, I bear), applied to the strata which contain the remains of animals and

- plants, to which remains geologists now restrict the term fossil.
- Fossil remains, 25, 652—682.
- Frontispiece, explanation of, xi.
- Function, the office which an organ is designed to perform.
- Fun'gidæ, found in the coralrag, 673.
- GALAPAGOS' islands, fauna of the, 622.
- Gan'glion (Gr. γαγγλίον, a knot), a mass of nervous matter forming a centre, from which nervous fibres radiate.
- Gan'glion'ic cells, 83.
- Gan'oids, fishes having large bony enamelled scales, mostly fossil, xxi.
- Gases, respiration in, other than atmospheric air, 394.
- Gaster'opods (Gr. γαστρο, stomach; πους, a foot), molluscous animals which have the locomotive organ attached to the under part of the body, xxii. 673.
- Gast'ric glands, 330.
- Gast'ric juice, 330.
- Gemmip'arous (Lat. *gemma*, a bud; *pario*, I bring forth), propagation by the growth of the young like a bud from the parent, 510.
- Gemmip'arous and fissip'arous reproduction, 510—515.
- Gemmule' (dim. of *gemma*), the embryos of radiated animals at that stage when they resemble ciliated monads.
- Gen'era (Genus, in the singular), a group of the animal kingdom, xix.; divided into species, xix.
- Genera'tion, alternate, 518—532; consequences of, 533—547; spontaneous, 543.
- Geograph'ical distribution of animals, 578—641; of vegetation, 639.
- Geolog'ical formations, 649.
- Germ (Lat. *germen*), the earliest manifestation of the embryo.
- Germ, first indication of the, 465.
- Gesta'tion (Lat. *gestatio*), the carrying of the young before birth, 439.
- Gla'cial (Lat. *glacies*, ice), or Drift period, 684.
- Glands, structure of, 419—425; elementary parts, 426; origin, 427; distribution of the vessels, 428.
- Globo'se (Lat. *globus*, a globe), globe shaped.
- Glob'ules (diminutive of *globe*) of chyle, 333.
- Glossopharyn'geal nerve, 104.
- Glot'tis, the, 180.
- Grallatores, or wading birds, xxi.
- Grand-nurses, what, 524.
- Granules' (dim. of *gratum*, a grain), little grains.
- Graniv'orous (Lat. *granum*, grain; *voro*, I devour), birds feeding on grain.
- Greyheads, or boulders, 684.
- Gul'let, the, 115, 345.
- HAND, the, 274—278.
- Hæmaphophy'sis (Gr. αίμα, blood; ἀπόφυσις, a process of bone); the vertebral elements which descend from the centrum, and enclose the blood-vessels in the cartilages of the ribs.
- Haversian canals, 240.
- Head, the, 241—251.
- Hearing, sense of, 145—161.
- Heart, the, 360; circulation of the blood, 361—375.
- Hemip'tera (Gr. ἡμισυ, half; πτερόν, a wing), the order of insects in which the anterior wings are hemelytrous; see Elytra.
- Hepat'ic (Lat. *hepar*, liver), belonging to the liver.
- Herbiv'ora (Lat. *herba*, grass; *voro*, I devour), animals which subsist on grass, xxi.
- Hermaph'rodite (ἑρμῆς, Mercury; Ἀφροδίτη, Venus), an individual in which male and female characteristics are combined.
- Hex'apod (Gr. ἕξα, six; πους, a foot,) animals with six legs, such as true insects.

- Hiberna'tion (Lat. *hyems*, winter), the torpid state of animals during winter, 402.
- Histological (Gr. *ιστος*, a tissue; *λογος*, discourse), the doctrine of the tissues which enter into the formation of an animal and its different organs, 210.
- Holothu'rians, soft sea slugs, bichele-mar, xxiii
- Homal'onotus delphinoceph'alus, 665
- Homoge'neous, uniform in kind.
- Hom'ologue (Gr. *ὁμος*, like; *λόγος*, speech), the same organ in different animals under every variety of form and function.
- Homol'ogy, or affinity, 16.
- Homop'tera (Gr. *ὁμος*, like; *πτερόν*, a wing), the insects in which the four wings have a similar structure, but restricted in its application to a section of Hemiptera.
- Hu'merus, or shoulder-bone, the, 272.
- Hy'aline (Gr. *ύαλος*, crystal) matter, the pellucid substance which determines the spontaneous fission of cells, 42.
- Hydat'id (Gr. *ύδατις*, a vesicle), a bladder of albuminous membrane, containing serous fluid; generally detached; sometimes with an organised head and neck.
- Hy'dra (Gr. *ύδρα*, a water-serpent), the modern generic name of fresh-water polyps.
- Hy'driform, similarly-formed polyps.
- Hy'drogen (Gr. *ύδωρ*, water; *γεννάω*, I produce;) a gas which is one of the constituents of water
- Hy'droids, fresh-water polyps, xxiii.
- Hydrozo'a (Gr. *ύδρα*, water; *ζών*, animal), the class of Polypi organised like the Hydra.
- Hymenop'tera (Gr. *ύμήν*, a membrane; *πτερόν*, a wing,) the order of insects, including the bee, wasp, &c. which have four membranous wings.
- Ichthyosau'rus (*ιχθυος*, a fish; *σαυρος*, a lizard), an extinct saurian, 673.
- Ide, idæ (Gr. *ειδος*, resemblance), a termination indicating likeness. As Acarus, a mite; Acaridæ, resembling the mite.
- Ig'neous (Lat. *ignis*, fire) rocks, 646.
- Iguan'odon, an extinct gigantic reptile, resembling in its teeth the iguana, an existing lizard.
- Il'ium, the, 263.
- Imbrica'ted (Lat. *imbricatus*, tiled), scales which lie one upon another like tiles.
- Inani'mate beings, plants, 75.
- Incesso'res, perching birds, like birds of prey, xxi.
- Inci'sor (Lat. *incido*, I cut), or cutting teeth, 341.
- Incuba'tion (Lat. *incubatio*), hatching of eggs by the mother.
- Incuba'tion, 442; physical and chemical changes in the egg during, 499.
- In'cus, or anvil, the, 149.
- Infuso'ria (Lat. *infundo*), microscopic animals, inhabiting infusions of animal or vegetable substances, xxiv.
- Infuso'ria, digestion in the, 314.
- Inoper'cular, univalve shells which have no operculum or lid.
- Inorgan'ic, not made up of tissues.
- Insaliva'tion, 345.
- In'sects, a class of the Articulates, xxii.
- In'sects, digestive organs of, 327; jaws of, 337; circulation, 370; respiration, 385.
- Instinct, 191—204.
- Intelligence and instinct, 185—204.
- Interambula'cra, the imperforate plates which occupy the intervals of the perforated ones, or ambulacra in the shells of the Echinoderms; see AMBULACRA.
- Interst'itial (Lat. *interstitium*), relating to the intervals between parts.
- Invertebra'ta (Lat. *in*, used in composition to signify *not*, like *un*;

- vertebra*, a bone of the back) animals without back bones.
- Pris**, the coloured part of the eye.
- Is'opoda** (Gr. *ισος*, equal; *πους*, a foot), an order of crustaceans, in which the feet are alike, and equal.
- JAWS**, of man, 251; of other animals, 334—344.
- Jelly-fishes**, fossil, 676.
- Judgment**, 188.
- KIDNEYS**, development of the, 424.
- LA'BIUM**, Latin for a lip; but applied only to the lower lip in Entomology.
- La'brum**, Latin for a lip, but applied only to the upper lip in Entomology.
- Lab'yriuth**, a part of the internal ear, 150.
- Labyrin'thodon**, an extinct reptile, 672
- Lacer'tans**, or lizards, xxi.
- Lac'teals** (Lat. *lacteus*, milky), vessels which take up the nutriment.
- Lamellibranchia'ta** (Lat. *lamella*, a plate; Gr. *βραγχτα*, gills), acephalous mollusca, with gills in the form of membranous plates, xxiii.
- Lamel'liform** (Lat. *lamella*, thin leaves), shaped like a thin leaf or plate.
- Lar'va** (Lat. *a mask*), applied to an insect in its first active state, which is generally a different form, and as it were masks the ultimate form.
- Lar'viform**, shaped like a larva.
- Lar'vynx** (Gr. *λάρυξ*), the organ of voice, situated at the top of the trachea, 180.
- Laying of eggs**, 439.
- Leaping**, 297.
- Leg**, the, 265.
- Lepidop'tera** (Gr. *λεπις*, a scale; *πτερόν*, a wing), the order of insects in which the wings are clothed with fine scales, as butterflies and moths.
- Life**, the distinctive characteristic of organic bodies, 32; animal life, 76; blood an essential condition of, 354.
- Lith'ophytes** (Gr. *λίθος*, a stone; *φυτόν*, a plant), a stone plant, or coral.
- Liver**, structure of the, in man, 425.
- Locomotion**, 228—307; plan of the organs of, 279—288; standing, and modes of progression, 289—307.
- Lower Silurian formation**, 650.
- Lower tertiary formation**, 650.
- Lungs**, the, 386*; their various forms, 387—391.
- Lymphat'ics**, 333.
- MALACOL'OGY** (Gr. *μαλακος*, soft; *λόγος*, discourse), the history of the soft bodied or molluscous animals, which were termed *malakia* by Aristotle.
- Malacos'tracans**, crustaceans, like the lobster, xxii.
- Mal'leus**, the, or hammer, 149.
- Mamma'lia**, or Mam'mals (Lat. *mamma*, a breast), the class of animals which give suck to their young, xxi.
- Mam'mals**, jaws of, 338; alone masticate their food, 341; circulation of the blood, 364, 365; structure of the liver, 425.
- Mam'mals**, reign of, 658, 678.
- Man**, nervous system of, 84—91; special senses, 120—184; skeleton of, 235—278; circulation of the blood in, 364—366; respiration, 386, 389, 390; structure of the liver, 425.
- Man**, reign of, 658, 684—686.
- Mandibula'ta** (Lat. *mandibula*, a jaw), the insects which have mouths provided with jaws for mastication; the term mandible is restricted in entomology to the upper and outer pair of jaws.
- Manduca'ta**, insects furnished with jaws, xxii.
- Man'tle**, the external soft con-

- tractile skin of the mollusca, which covers the viscera and a great part of the bodylike a cloak.
- Marl, earth principally composed of decayed shells and corals, a mixture of clay and lime.
- Marsu'pial animals found in the oolite, 674.
- Marsupia'lia (Latin, *marsupium*, a purse), an order of the Mammalia having a tegumentary pouch, in which the embryo is received after birth, and protected during the completion of its development.
- Massive rocks, 646.
- Mastication, 334; confined to the mammalia, 341.
- Mas'todon (Gr. *μαστος*, a teat; *οδον*, a tooth), a genus of extinct quadrupeds allied to the elephant, but having the grinders covered with conical protuberances like teats, 687.
- Ma'trix, the organ in which the embryo is developed, 475.
- Matter and mind, to be contemplated together, 29.
- Maxi'la (Lat. *maxilla*, a jaw-bone), in entomology restricted to the inferior pair of jaws.
- Me'dian, having reference to the middle line of the body.
- Medul'la oblonga'ta, the oblong medullary column at the base of the brain, from which the spinal chord or marrow is continued, 89.
- Medu'sa, development of the, 527—529.
- Medu'sa, a class of soft radiated animals, or aculephs, so called because their organs of motion and prehension are spread out like the snakyhair of the fabulous Medusa.
- Megalosau'rus, an extinct reptile, 673.
- Mergan'ser, an aquatic bird allied to the goose, 593.
- Memory, 188.
- Mes'entery (Gr. *μεσος*, intermediate; and *εντερος*, entrail), the membrane which forms the medium of connection between the small intestines and the abdomen.
- Mesotho'rax (Gr. *μεσος*, middle; *θοραξ*, the chest), the intermediate of the three segments which form the thorax in insects.
- Metacar'pus, the wrist, 276.
- Metamor'phic rocks, 647.
- Metamor'phoses (Gr. *μεταμορφωσις*, change of form). of animals, 548; of vegetables, 549.
- Metatar'sus, one division of the bones of the foot, 267.
- Metatho'rax (Gr. *μετα*, after; *θοραξ*, the chest), the hindmost of the three segments which compose the thorax of an insect.
- Migra'tion little prevalent among the mammalia, 594.
- Mil'lepedes (Lat. *mille*, a thousand; *pes*, a foot), animals with many feet, as the wood-louse.
- Millepores' (Lat. *mille*, a thousand; Gr. *πορος*, a minute hole), a genus of lithophytes, having their surface penetrated by numerous little holes.
- Miocene' (Gr. *μειον*, less; *καινος*, recent), the stage of the tertiary epoch in which a minority of the fossil shells are of recent species, 650.
- Modern age, the reign of man, 658, 684—686.
- Mo'lar (Lat. *molaris*, grinding) teeth, 341.
- Molecules' (of *moles*, a mass), microscopic particles.
- Mol'lusca (Lat. *mollis*, soft), or Mol'lusks, a primary division of the animal kingdom, xxii.
- Mol'lusca, 70, 662; of the trias period, 670; in the oolite, 673; nervous system, 116; digestive organs, 318—321; jaws, 336; circulation, 368; respiration, 380, 405.
- Mon'ad (Gr. *μονάς*, unity), the

- genus of the most minute and simple microscopic animalcules, shaped like spherical cells.
- Monocotyl'edons, plants with a single seed lobe, 72.
- Monoc'ulus (Gr. *μόνος*, single; Lat. *oculus*, an eye), the animals which have but one eye.
- Monomy'ary (Gr. *μόνος*, single; *μυον*, a muscle), a bivalve whose shell is closed by one adductor muscle.
- Monothal'amous (Gr. *μόνος*, single; *θαλαμος*, a chamber), a shell forming a single chamber, like that of the whelk.
- Motion, 205—307; apparatus of, 205—227; locomotion, 228—288; standing, and modes of progression, 289—307.
- Mo'tory, the nerves which control motion.
- Moult'ing, the shedding of feathers, hair, &c., 412.
- Mul'tivalve (Lat. *multus*, many; *valva*, folding doors).
- Mus'cular tissue, one of the primary forms of animal tissues having the power of contraction, 44, 54.
- Myri'apods (Gr. *μύριοις*, ten thousand; *πους*, foot), the order of insects characterized by their numerous feet.
- NA'CREOUS (Fr. *nacre*), pearly, like mother-of-pearl.
- Natato'res (Lat. *nato*, I swim), birds with webbed feet for swimming, xxi.
- Na'tatory, an animal or part formed for swimming.
- Natural history, extent of the study of, 30.
- Nature, ages of, 656—690.
- Nautilus, cephalopods with chambered shells, xxii.
- Nep'tunic, or water-formed rocks, 646.
- Nerves, structure of the primary fibres of, 80, 81; their termination, 82—119.
- Nerves, pairs of, their several offices, 97—114.
- Ner'vous system of man, 84—95; of other classes of animated beings, 92—119; special senses, 120—184.
- Nervous system, the, and general sensation, 76—79.
- Ner'vous tissue, 45, 55; its structure, 80, 81; termination, 82.
- Ner'vures (Lat. *nervus*, a sinew), the delicate frame of the membranous wings of insects.
- Neurapoph'yses (Gr. *νεῦρον*, nerve; *ἀπόφυσις*, a process of bone), those vertebral elements which enclose and protect the spinal cord and brain.
- Neu'ral-spine, the spinous processes of the vertebra.
- Neuri'lemma (Gr. *νεῦρον*, a nerve; *λήμμα*, a covering), the membrane which surrounds the nervous fibre.
- Neurop'tera (Gr. *νεῦρον*, a nerve; *πτερόν*, a wing), the order of insects with four wings, characterized by their numerous nervures, like those of the dragon-fly.
- Nodu'le (dim. of *nodus*, a knot), a little knot-like eminence.
- Nor'mal (Lat. *norma*, rule), according to rule, ordinary or natural.
- Notosau'rus, an extinct saurian, 672.
- Nuclea'ted, having a nucleus or central particle; applied to the elementary cells of animal tissues, the most important properties of which reside in the nucleus, 38, 56.
- Nu'cleus and nu'cleolus, 56
- Nu'dibrachiate (Lat. *nudus*, naked; Gr. *βραγχια*, arms), the polyps, whose arms are not clothed with vibratile cilia.
- Nudibranchiata' (Lat. *nudus*, naked; Gr. *βραγχια*, gills), an order of gasteropods, in which the gills are exposed.
- Nutrition, 308—349; digestion, 312—349.

- OCULI** (Latin), minute eyes, 138.
- Oc'topods** (Gr. *οκτο*, eight; *πους*, a foot), animals with eight feet; the name of the tribe of Cephalopods with eight prehensile organs attached to the head.
- Œsoph'agus**, the gullet, or tube leading from the mouth to the stomach, 345.
- Olfac'tory** (Lat. *olfactus*, the sense of smelling) nerves, 97.
- Omniv'ora** (Lat. *omne*, all; *voro*, I devour), feeding upon all kinds of food, 343.
- Oolite'** (Gr. *ωον*, egg; *λίθος*, stone), an extensive group of secondary limestones, composed of rounded particles, like the roe or eggs of a fish.
- Oolit'ic formation**, 650.
- Oper'culum** (Latin, a lid), applied to the horny or shelly plate which closes certain univalve shells; also to the covering of the gills in fish, and to the lids of certain eggs.
- Optic lobes**, in man, 88.
- Optic nerves**, 98, 99, 101.
- Ophid'ians** (Gr. *ὄφις*, a serpent), animals of the serpent kind, xxi.
- O'ral** (Lat. *os*, the mouth), belonging to the mouth or the speech.
- Orders**, a group of the animal kingdom, xx.; subdivided into families and genera, xx.
- Organism**, 36.
- Organized bodies**, general properties of, 30—75; organized and unorganized bodies, 30—34; elementary structure of organized bodies, 35—56; differences between animals and plants, 57—75.
- Ornithichni'tes** (Gr. *ὄρνις*, a bird), the fossil footsteps of birds, 670.
- Orthop'tera** (Gr. *ορθος*, straight; *πτερόν*, a wing), the order of insects with elytra and longitudinally folded wings.
- Os'eous** (Lat. *os*, a bone) tissue, 43.
- Otoliths** (Gr. *ους*, an ear; *λίθος*, a stone), the stony or chalky bodies belonging to the internal ear, 156.
- Ova'rium** (Lat. *ovum*, an egg), the organ in which the eggs or their elementary and essential parts are formed.
- Ovary**, detachment of the ovum from the, 481.
- Ovig'erous** (Lat. *ovum*, an egg; *gero*, I bear), parts containing or supporting eggs.
- Ovip'arous** (Lat. *ovum*, an egg; *pario*, I bring forth), animals which bring forth eggs, 434.
- Ovo-vivip'arous** (Lat. *ovum*, an egg; *vivus*, alive; *pario*, I produce), animals which produce living young, hatched in the egg within the body of the parent without any [connection with the womb, 439.
- Ovula'tion**, the production of eggs, 437, 438.
- O'vum** (Lat. an egg), detachment from the ovary, 481.
- Ox'ygen**, quantity consumed by various animals, 396*.
- PACHYDER'MATA** (Gr. *παχύς*, thick, *δέρμα*, skin), thick-skinned animals, like the elephant, hog, &c., 343.
- Palæontol'ogy** (Gr. *παλαιός*, ancient; *οντα*, beings; *λόγος*, discourse), the history of ancient extinct organised beings.
- Palæontol'ogy**, an essential branch of zoology, 645.
- Palæozo'ic age**, 658, 659—667.
- Palæothe'rium** (Gr. *παλις*, ancient; *θηρίον*, beast), an extinct genus of Pachydermata, 680.
- Pal'lial** (Lat. *pallium*, a cloak), relating to the mantle or cloak of the mollusca.
- Palpa'tion**, the act of feeling, 175.

- Papil'lae (Lat. *a nipple*), minute soft prominences, generally adapted for delicate sensation, 413.
- Pal'pi (Lat. *pāpo*, I touch), the organs of touch developed from the labium and maxillæ of insects.
- Parasit'ic (Lat. *parasitus*), living on other objects.
- Paren'chyma, the soft tissue of organs; generally applied to that of glands, 372.
- Pari'etes (Lat. *paries*, a wall), the walls of the different cavities of an animal body.
- Pas'serine (Lat. *passer*, a sparrow), birds of the sparrow kind.
- Patel'la, the, 265.
- Pectina'ted (Lat. *pecten*, a comb), toothed like a comb.
- Pectinibranchia'ta (Lat. *pecten*, a comb; *βραγχα*, gills), the order of gasteropods, in which the gills are shaped like a comb.
- Ped (Lat. *pes*), Poda (Gr. *πους*, a foot), a termination classifying certain kinds of animals by their feet; as quadruped, gasteropod; which see.
- Ped'iform (Lat. *pes*, a foot), shaped like a foot.
- Pedun'cle (Lat. *pedunculus*), a stalk.
- Pelag'ic (Gr. *πελαγος*, sea), belonging to the deep sea.
- Pel'vic arch, the, 263.
- Pe'lvis (Latin), the cavity formed by the hip bones.
- Pentacrinite' (Gr. *πεντα*, five; *κρινος*, hair), a pedunculated star-fish with five rays; they are for the most part fossil.
- Periph'eral circulation, 372—375.
- Periph'ery (Gr. *περι*, about; *φερω*, I bear), exterior surface.
- Peristal'tic (Gr. *περι*, about; Lat. *stello*, I range), motion, the vermicular contractions and motions of muscular canals, as the alimentary, the circulating, and generative tubes.
- Peritone'al (Gr. *περιτοναϊος*, the covering of the abdomen), restricted to the lining membrane of that cavity.
- Perpetual snow, limits of, 638.
- Phal'anges (Latin), the joints of the fingers and toes, 277.
- Phar'ynx, the dilated beginning of the gullet.
- Phytoph'agous (Gr. *φυτόν*, a plant; *φαγο*, I eat), plant-eating animals.
- Pia' ma'ter, 85.
- Pig'ment (Lat. *pigmentum*), a colouring substance.
- Pin'nate (Lat. *pinna*, a feather or fin), shaped like a feather, or provided with fins.
- Pisces (Latin), fishes; the fourth class of vertebrate animals, xxi.
- Pitu'itary (Lat. *pituita*, phlegm), membrane, 164.
- Placen'ta (Latin), the organ by which the embryo of mammals is attached to the mother, 476.
- Plac'oïds, fishes with a rough skin, like the shark or skate.
- Plant lice; see Aphides.
- Plants and animals, differences between, 57—74; resumé, 75.
- Plan'aria, a genus of worms.
- Plas'ma, the fluid part of the blood, in which the red corpuscles float, also called *liquor sanguinus*.
- Plas'tron, the under part of the shell of the crab and tortoise.
- Pleiocene' (Gr. *πλειον*, more; *καινος*, recent), the stage of the tertiary strata, which is more recent than the miocene, and in which the major part of the fossil testacea belong to recent species, 650.
- Pleistocene' (Gr. *πλειστος*, most; *καινος*, recent), the newest of the tertiary strata, which contains the largest proportion of living species of shells, 685.
- Plesiosau'rus (Gr. *πλησιος*, almost; , a lizard), an extinct marine

- saurian, remarkable for its long neck, 671.
- Pleurotomaria, an extinct genus of univalve shells.
- Plexus (Gr. *πλεκο*, I twine), a bundle of nerves or vessels interwoven or twined together. †
- Pli'cæ (Lat. *plicæ*, a fold), folds of membrane.
- Plumose' (Lat. *pluma*, a feather), feathery, or like a plume of feathers.
- Plutonic or igneous rocks, 646.
- Pneumat'ic (Gr. *πνευμα*, breath), belonging to the air, and air-breathing organs.
- Pneumoga'stric nerve, 105.
- Podure'la, a genus of insects, their mode of progression, 299.
- Polygas'tria (Gr. *πολυς*, many; *γαστερ*, a stomach), infusorial animalcules which have many assimilative sacs or stomach.
- Pol'ypi (Gr. *πόλυς*, many; *πους*, a foot), radiated animals with many prehensile organs radiating from around the mouth.
- Polypifera, digestion in the, 313, 317.
- Prehen'sion, act of grasping.
- Primary, or palæozoic age, the reign of fishes, 658, 659—669.
- Primitive fibres of the nerve, 80.
- Progression, modes of, 289—307.
- Prolig'eros, the part of the egg bearing the embryo.
- Protho'rax (Gr. *προ*, before, and *θοραξ*), the first of the three segments which constitute the thorax in insects.
- Protract'ile, capable of being extended.
- Pro'teus, a genus of batrachian reptiles, 626.
- Protosau'rus (Gr. *πρωτος*, first; *σαυρος*, a lizard), an extinct genus of saurian reptiles, 672.
- Protozoa (*πρωτος*, first; *ζωον*, animal), the, assumed, simplest forms of animal life, xxiv.
- Pterich'thys (Gr. *πτερόν*, a wing; *ιχθυς*, a fish), an extinct fish, of very peculiar form, 667.
- Pterodac'tylus (Gr. *πτερόν*, a wing; *δάκτυλος*, a finger), an extinct flying reptile, 671.
- Pter'opods (Gr. *πτερόν*, a wing; *πους*, a foot), mollusks, in which the organs of motion are shaped like wings. xxiii.
- Pul'mogrades (Lat. *pulmo*, a lung; *gradior*, I walk), medusæ which swim by contractions of the respiratory disc.
- Pul'monata (Lat. *pulmo*, lung), gastropods that breathe by lungs, xxxiii.
- Pu'pa (Latin, *doll*, or *little image*), the passive state of an insect immediately preceding the last.
- Pylo'rus (Gr. *πυλωρός*), the aperture which leads from the stomach to the intestine.
- Pyr'iform (Lat. *pyrum*, a pear), pear-shaped.
- Py'rule, a genus of univalve shells.
- QUAD'RIFID (Lat. *quatuor*, four; *findo*, I cleave), cleft in four parts.
- Quadruma'nous (Lat. *quatuor*, four; *manus*, a hand), four-handed animals, as monkeys.
- Quad'ruped (Lat. *quatuor*, four; *pes*, a foot), animals with four legs.
- RADIA'TA (Lat. *radius*, a ray), or Radiates, the lowest primary division of the animal kingdom, xxi.
- Radia'ta, nervous system of the, 117; jaws, 335; of the trias period, 670; of the oolite, 674.
- Ra'dius, one of the bones of the arm, 273.
- Ramose' (Lat. *ramus*, a branch), branched.
- Reasoning, 189.
- Relation, functions of, 76.
- Remak, band of, 55.
- Ren'iform (Lat. *ren*, a kidney), kidney-shaped.

- Reproduction, peculiar modes of, 510—547; gemmiparous and fissiparous, 510—515; alternate and equivocal, 516—532; consequences of alternate generation, 533—547.
- Rep'tiles or Reptil'ia, jaws of, 340; circulation of the blood, 366; respiration, 384.
- Rep'tiles, reign of, 658, 670—677.
- Reptil'ia (Lat. *repto*, I creep), or Rep'tiles; the third class of vertebrate animals with imperfect respiration and cold blood, xxi.
- Respira'tion, 376—405; in the echinodermata, 378, 405; in mollusca, 380, 405; in crustacea, 381, 405; in annelida, 382; in fishes, 383; in reptiles, 384; in insects and arachnida, 385; in man, 386; in birds, 388; lungs of man and the mammalia, 389, 390; two sorts of respiratory organs in articulata, 405.
- Rest, the distinctive character of inorganic bodies, 32.
- Re'te muco'sum, the cellular layer between the scarf-skin and true skin, which is the seat of the peculiar colour of the skin, 413.
- Ret'ina (Latin), the seat of vision, 125.
- Retract'ile, that may be drawn back.
- Rhizodonts, an order of extinct reptiles, xxi. 672.
- Rhizo'poda; see Foraminifera.
- Rocks, what, in a geological sense, 646; their different kinds, 646, 647.
- Rod'ents (Lat. *rodo*, I gnaw), quadrupeds with teeth for gnawing, 343.
- Rotif'era (Lat. *rota*, a wheel; *fero*, I bear), infusorial animalcules characterised by the vibratile and apparently rotating ciliary organs upon the head.
- Rotif'era, eggs of the, 546.
- Ruminants (Lat. *ruminus*), quadrupeds which chew the cud; as the bull and stag, 343.
- Running, 296.
- SAC'CIFORM, shaped like a sac or bag.
- Salif'eous, or salt-bearing formation, 650.
- Sal'pians (Gr. *σαλπη*, a kind of fish), tunicated mollusks which float in the open sea, xxiii. 519.
- Sau'rians (Gr. *σαυρος*, a lizard), a class of reptiles, including the existing crocodiles, and many species of large size, 673.
- Scan'sores (Lat. *scando*, I climb), birds adapted for climbing, xxi.
- Scap'ula, the, or shoulder blade, 270.
- Scap'ular arch, the, 269.
- Sclerot'ic, the principal coat of the eye, 123.
- Seba'ceous (Lat. *sebum*, tallow); like lard or tallow.
- Secondary age, the reign of reptiles, 658, 670—677.
- Secretions, the, 406—428; structure of glands, 419—425; elementary parts, 426; origin of glands, 427; distribution of their vessels, 428.
- Sediment'ary or stratified rocks, 646; alone contain fossils, 649.
- Seg'ment, portion of a circle or sphere.
- Segmenta'tion, the act of dividing into segments.
- Semilu'nar, crescent-shaped, like a half moon.
- Sensation, 76—119.
- Senses, the special, 120—184.
- Sep'ta (Latin), partitions.
- Se'rous, (Lat. *serum*), watery.
- Serrat'ed (Lat. *serra*, a saw), toothed like a saw.
- Ses'sile (Lat. *sessilis*), attached by a base.
- Se'tæ (Lat. *seta*, a bristle), bristles or similar parts.
- Shell, 218.
- Shoulder blade, the, 270.
- Sight, sense of 120—144.
- Si'lax (Latin), flinty rock.
- Sili'ceous (Lat. *silex*, flint), flinty.
- Silk-worm, metamorphoses of the, 551.

- Silu'rian formations, 650.
- Sin'uous (Lat. *sinuatus*, winding), bending in and out.
- Si'nus (Latin), a dilated vein or receptacle of blood.
- Siphon'ophori, soft radiates, xxiii.
- Skeleton, the, 225; of man, 235—278; corresponding organs of locomotion in other animals, 282—288.
- Skin, the, 412, 413.
- Smell, sense of, 162—168.
- Species, ordinarily the lowest term in the divisions of the animal kingdom, xix.; occurrence of varieties, xx.
- Species, living, their number, 7, and note.
- Speech, gift of, confined to man, 184.
- Spermatozo'o'a (Gr. σπέρμα, seed; ζῶον, an animal), the peculiar microscopic moving filament and essential parts of the fertilising fluid.
- Sphinc'ter (Gr. σφιγκτηρ), the circular muscles which contract or close natural apertures.
- Spic'ula (Lat. *spiculum*, a point or dart), fine pointed bodies like needles.
- Spī'nal cord, in man, 89; see Nervous system.
- Spī'nal nerves, 108.
- Spir'acles (Lat. *spiro*, I breathe), the breathing pores in insects.
- Sponges, doubtful nature of, 58, and note.
- Spontaneous generation, old theory of, unfounded, 543.
- Spores, the germs of sea-weeds, ferns, &c.
- Squa'mous (Lat. *squama*, a scale), arranged like scales.
- Standing, and modes of progression, 289—307.
- Stapes, the, or stirrup, 149.
- Ster'nal, the aspect of the body where the sternum or breast-bone is situated.
- Stig'mata (Gr. στίγμα, a mark), the breathing pores of insects.
- Stomach; see Digestive organs.
- Stra'ta (Latin, *beds* or *layers*), arrangement of, 648.
- Strat'ified rocks, 646.
- Sucto'ria (Lat. *sugo*, I suck), animals provided with mouths for sucking, and the appendages of other parts organised for sucking or adhesion, xxiii.
- Supra-œsopha'geal (Latin, *supra*, above), above the gullet.
- Supreme Intelligence, direct intervention of the, in the geographical distribution of organized beings, 641.
- Su'ture (Lat. *suo*, I sew), the immoveable junction of two parts by their margins.
- Swimming, 302.
- Sympathetic nerves, great, 109; opposite views regarding, 110—115.
- Sys'tole (Gr. συστολή), the contraction of the heart to force out the blood, 363.
- TARSUS (Gr. τάρσος, a part of the foot), applied to the last segments of the legs of insects.
- Tar'sus, the, in man, 266.
- Taste, sense of, 169—173.
- Tectibranchia'ta (Lat. *tego*, I cover; βραγchia, gills), mollusks in which the gills are covered by the mantle.
- Teeth, the, 339—341.
- Temperate fauna, the, 605—615.
- Temperature, equalizing effects of large sheets of water on, 636.
- Tem'poral (Lat. *tempora*), relating to the temples.
- Te'ntacle (Lat. *tentaculum*), the horn-like organs on the head of mollusks usually bearing the eyes.
- Terebrat'ula (Lat. *terebro*, I bore), a genus of brachiopodous mollusks.
- Ter'gal (Lat. *tergum*, the back), belonging to the back.
- Ter'tiary (Lat. *tertius*, the third) age, the reign of mammals, 658, 676—683.

- Test, the brittle crust covering the crustaceans, &c.
- Test, what, 218; in the echinidæ, asteriadæ, and crinoidæ, 219; in the mollusca, 220; in the articulata, 222.
- Tetrabran'chia'ta (Gr. τετρα, four; βραγχια, gills), cephalopods with four gills.
- Teuthid'eans, the family of cuttle fishes, xxii.
- Thorac'ic, belonging to the thorax.
- Tho'rax, the, or chest, 261, 262.
- Thigh, the, 264.
- Tib'ia, one of the bones of the leg, 265.
- Tissues, the various, 41—56.
- Toes, the, 268.
- Torrid zone, development of animal and vegetable life in the, 583.
- Tortoises, first traces of, 674.
- Touch, sense of, 174—176.
- Tra'cheæ (Gr. τραχεια, the rough artery or windpipe), the breathing tubes of insects.
- Trias formation, 650.
- Trias period, fauna of the, 670.
- Tril'obite (Gr. τρις, three; λοβος, a lobe), an extinct genus of crustacea, the upper surface of whose body is divided into three lobes, xxii. 665, 671.
- Tro'phi, organs for feeding, of insects, crabs, &c.
- Trop'ical fauna, the, 616—622.
- Trunk, the, 252—263.
- Tubulibranchi'ates, articulates, with gills about the head, xxii.
- Tunica'ta (Lat. tunica, a cloak), acephalous mollusks enveloped in an elastic tunic not defended by a shell.
- Tym'panum (Lat. a drum), the membrane separating the internal and external ear, 150.
- Type (Gr. τύπος), an ideal image, xx.
- Type of the vertebrata, 506; of the articulata, 507; of the mollusca, 508; of the radiata, 509.
- UL'NA (Latin), one of the bones of the arm, 273.
- Un'cinated (Lat. unguis, a nail or claw), beset with bent spines like hooks.
- Univalve (Lat. unus, one; valvæ, doors), a shell composed of one calcareous piece.
- Upper Silurian formation, 650.
- Upper tertiary formation, 650.
- VARIETIES, in the animal kingdom, on what based, xx.
- Vas'cular (Lat. vasculum), composed of vessels.
- Vegetation, geographical distribution of, 639—641.
- Veins, 357.
- Ven'tral (Lat. venter, the belly), relating to the inferior surface of the body.
- Ventric'ular (Lat. ventriculus, a ventricle or small cavity, like those of the heart or brain), belonging to a ventricle, 361.
- Ver'mes (Lat. vermis, a worm), worm-like animals: applied in a very extensive sense by Linnæus, xxii.
- Vermic'ular, or worm-like, motion, 331.
- Ver'tebrae, the, 259; number of, in different animals, 260.
- Vertebra'ta (Lat. vertebra, a bone of the back; from *vertere*, to turn), or Vertebrates, the highest division of the animal kingdom, characterised by having a back-bone, xxi. 73; digestive organs, 328. 329; jaws of, 338—344.
- Vesic'ulæ (Lat. vesica, a bladder), receptacles like little bladders.
- Ves'tibule (Lat. vestibulum, a porch), the entrance to one of the cavities of the ear, 158.
- Vi'bratile (Lat. vibratilis), moving to and fro.
- Vil'li (Latin), small processes like the pile of velvet.

- Vis'cus, Vis'cera**, plural (Latin), intestines, bowels.
Vitel'line (Lat. *vitellus*, yolk), of, or belonging to the yolk.
Vitel'lus, or yolk of eggs, 444.
Vit'reous humour (Lat. *vitreus*, glassy), the humour of the eye on which the retina or expansion of the optic nerve is extended, 127.
Vivip'arous (Lat. *vivus*, alive; *paric*, I bring forth), animals which bring forth their young alive, 434.
Vocal cords, 180.
Voice, the, 177—184; speech confined to man, 184.
Voluntary (Lat. *volo*, I will), under control of the will.
Voluntary and involuntary motions, 211.
WALKING, 293—295.
- Warm-blooded animals, as birds, mammals, &c. 399.
 Water, equalizing effects of large sheets of, 636.
 Water-tubes of aquatic animals, 403.
 Whales, mode of swimming, 304, 307.
 Worms, or Ver'mes, class of, xxii. .
Yolk of egg, 444.
 Young, development of the, 447—449.
- ZOOLOG'ICAL** regions, chart of, explained, xii.
Zool'ogy, its sphere and fundamental principles, 1—29.
Zo'ophytes (Gr. ζῶον, animal, φυτόν, a plant), the lowest primary division of the animal kingdom, which includes many animals that are fixed to the ground and have the form of plants, 68.

