

NATIONAL STANDARD
SQUAB BOOK

ELMER C. RICE

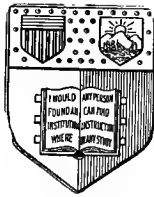

New York
State College of Agriculture
At Cornell University
Ithaca, N. Y.

Library

Cornell University Library
SF 467.R49 1911

The national standard squab book.



3 1924 000 029 748

mann

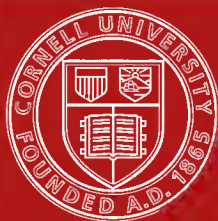

Cornell University
Library

The original of this book is in
the Cornell University Library.

There are no known copyright restrictions in
the United States on the use of the text.

<http://www.archive.org/details/cu31924000029748>

**The National
Standard Squab Book**

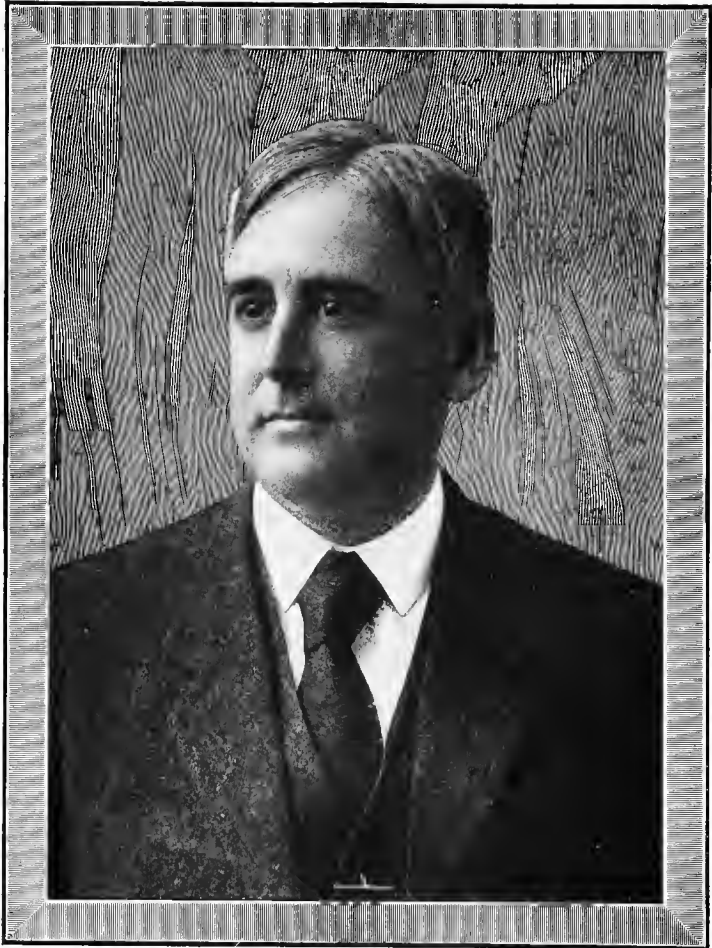

ELMER C. RICE

FOUNDER OF THE SQUAB INDUSTRY IN AMERICA

The National Standard Squab Book

By ELMER C. RICE

(Mail address, Post Office Box 175, Boston, Mass., U. S. A.)

A PRACTICAL MANUAL GIVING
COMPLETE AND PRECISE DIRECTIONS
FOR THE INSTALLATION
AND MANAGEMENT OF A SUCCESSFUL
SQUAB PLANT. FACTS
FROM EXPERIENCES OF MANY

HOW TO MAKE A PIGEON AND SQUAB
BUSINESS PAY, DETAILS OF BUILDING,
BUYING, HABITS OF BIRDS, MATING,
WATERING, FEEDING, KILLING, COOLING,
MARKETING, SHIPPING, CURING
AILMENTS, AND OTHER INFORMATION

Illustrated with New Sketches and Half Tone Plates
from Photographs Specially Made
for this Work

BOSTON, MASSACHUSETTS

1912

C)

Copyright, 1901, by Elmer C. Rice
Copyright, 1902, by Elmer C. Rice
Copyright, 1903, by Elmer C. Rice
Copyright, 1904, by Elmer C. Rice
Copyright, 1905, by Elmer C. Rice
Copyright, 1906, by Elmer C. Rice
Copyright, 1907, by Elmer C. Rice
Copyright, 1908, by Elmer C. Rice
Copyright, 1909, by Elmer C. Rice
Copyright, 1910, by Elmer C. Rice
Copyright, 1911, by Elmer C. Rice

All rights reserved.

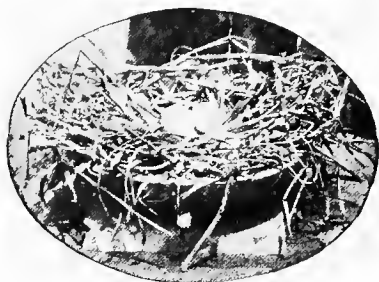

A WELL-BUILT NEST.

Press of
Murray and Emery Company
Boston, Mass.

CONTENTS

	Page
Preface	11
Chapter I. Squabs Pay	15
Chapter II. An Easy Start	21
Chapter III. The Unit House	37
Chapter IV. Nest Bowls and Nests	45
Chapter V. Water and Feed.	51
Chapter VI. Laying and Hatching	63
Chapter VII. Increase of Flock	75
Chapter VIII. Killing and Cooling	79
Chapter IX. The Markets	83
Chapter X. Pigeons' Ailments	89
Chapter XI. Getting Ahead	93
Chapter XII. Questions and Answers	101
Supplement	113
Appendix A	139
Appendix B	153
Appendix C	169
Appendix D	185
Appendix E	227
Appendix F	239
Plymouth Rock Carhomes	237
Carneaux and Homers Not in Same Pen	238
A Monthly Squab Magazine	239
More About How to Tell Sex	239
How to Keep Down an Excess of Cocks	241
Squab Houses of Two and Three Stories	242
Squabs Fed Artificially	244
Nests on the Floor	244
A Plan to Get Rid of Rats and Mice	245
How to Make Perches	246
Pittsburg Market	246
Low Quotations	246
How to Kill Cats	247
Breeding True to Color	247
Sulphur and Iron Water	248
Pigeons that Fly Away	248
No Coal Ashes	249
Temporary Pen and Breeding Pen	249
Twigs for Nesting Materials	251
Clamoring for Squabs in Washington State	253
Oklahoma and Indian Territory	254
Appendix G	303

ILLUSTRATIONS

	Page		Page
Portrait of the Author [Frontispiece]		Interior of Massachusetts Customer's House	210
A Well-Built Nest	8	Women Enjoy Squab Raising	211
Thoroughbreds	14	At the Back of a Barn	212
How a Back Yard may be Fixed for Pigeons	18	Shipshape Flying Pen	213
Cheap but Practical Nest Boxes	22	Nest of Straw and Feathers	214
How City Dwellers without Land may Breed Squabs	24	Different Sizes	215
Unit Squab House (with Passageway) and Flying Pen	26	An Inexpensive Start	216
Nest Boxes Built of Lumber	28	A Row of Beauties	217
Best Nest Box Construction	30	Eating from His Hand	218
Interior of Squab House Showing Perches	32	Ready to Kill	219
A Pretty Squab House and Flying Pen	36	Squabs 25 Days Old	220
Multiple Unit House	38	In the Snow	221
Interior of Multiple Unit House	40	Squabs Three Weeks Old	222
Multiple Unit House, Tea Units, Built according to our Plans	42	Squabs Twelve Days Old	223
Nest Bowl, Bath Pan, Drinking Fountain, etc	46	Squabs a Few Days Old	224
Berry Crate to Hold Nesting Material	50	Nest of Tobacco Stems	225
Scenes on the \$200,000 Farm of One of Our Customers	58	Raised from Plymouth Rock Extras	226
Eggs in the Nest, Squabs Just Hatched	64	Carneau	227
Squabs One Week Old, Squabs Two Weeks Old	66	Carneau Squab Compared with Homer Squab	236
Squabs Three Weeks Old, Squabs Four Weeks Old	68	Two and One-half Story Squab House	243
The Mating Coop	70	Plymouth Rock Extra Homer Male	250
Pigeons in St. Mark's Square, Venice	74	Plymouth Rock Extra Homer Female	252
Killing Squabs with the Hands	80	Flying Pen of a Barn	256
Killed Squabs Hung to Cool	82	Three Squabs Hatched in One Nest	257
Three Dressed Squabs	86	Any Old Place Fixed Over	259
Squab House Built of Logs	88	Squab Plant in Pennsylvania Protected by Hillside	262
Pair of Homers Billing	90	A New Jersey Plant	264
How We Ship Pigeons	98	Another View of New Jersey Plant	265
Self Feeder for Grain	108	An Attractive Minnesota Squab Plant	266
Machine for Killing Squabs	115	Hundreds of Squabs Eaten at One Banquet	268
Sprayer	116	Mississippi Squab House	269
Nest Boxes	118	A Massachusetts Plant	270
Pigeons in Corner of Flying Pen	138	Another View of Massachusetts Plant	271
Mating Coops in Mating House	140	California Squab House	272
Interior of Mating House	142	Small Openings under the Windows	273
Part of South Side of One of Our Houses	146	A Pair of Squabs from Plymouth Rock Extras	274
Dowel System of Feeding and Watering from Alleyway	150	Squab Building in British Columbia	276
Letter from A. Silz	188	A City Squab House	278
Letter from W. R. McLaughlin	190	A Pair of Big Squabs	280
Letter from Heineman & Co.	192	An Odd Squab House	282
Extra Plymouth Rock Homers	194	Tobacco Stems	283
A Good-Looking Illinois Plant	196	Lump of Rock Salt	284
Showing Construction in Florida	198	Head of Sorghum Seed	285
Homer Hen Sitting on Eggs	199	Health Grit	286
Lighted by Electricity and Heated by Steam	200	Red Wheat, Canada Peas, Hempseed	287
On a Pole at Top of Flying Pen	202	Screws, Kaffir Corn, Sorghum Cane Seed	288
Cheapest Possible Construction	204	Whole Corn, Coarse Cracked, Fine Cracked	289
The Start	206	White Wheat, Poor Red Wheat, Wheat Screenings	290
This Customer	206	Barley, Oats, Sunflower Seeds	291
Beautiful Pair of Splashes	207	American Millet, Siberian Millet, Golden Millet	292
Plymouth Rock Blue Bars and Blue Checkers	208	Rice Unhulled, Rice, Buckwheat	293
On a Running Board in the Sun	209	Granite Grit, Quartz Grit, Same Crushed	294
		Health Grit, Coarse Oyster Shell, Pigeon Oyster Shell	295
		Mixed Grain (three samples)	296
		A South Carolina Plant	298
		Ordinary Quarters	301
		Home Made	302

PREFACE.

This Manual or Handbook on Squabs is written to teach people, beginners mostly, not merely how to raise squabs, but how to conduct a squab and pigeon business successfully. We have found breeders of squabs who knew how to raise them fairly well and took pleasure in doing so, but were weak on the business end of the industry. The fancier, who raises animals because he likes their looks or their actions, or because he hopes to beat some other fancier at an exhibition, is not the man for whom we have written this book. We have developed Homer pigeons and the Homer pigeon industry solely because they are staples, and the squabs they produce are staples, salable in any market at a remunerative price. The success of squabs as we exploit them depends on their earning capacity. They are a matter of business. Our development of squabs is based on the fact that they are good eating, that people now are in the habit of asking for and eating them, that there is a large traffic in them which may be pushed to an enormous extent without weakening either the market or the price. If, as happens in this case, pigeons are a beautiful pet stock as well as money makers, so much the better, but we never would breed anything not useful, salable merely as pets. It is just as easy to pet a practical animal as an impractical animal, and much more satisfying.

This Manual is the latest and most comprehensive work we have done, giving the results of our experience as fully and accurately as we can present the subject. It is intended as an answer to the hundreds of letters we receive, and we have tried to cover every point which a beginner or an expert needs to know. It is a fault of writers of most guide books like this to leave out points which they think are too trivial, or "which everybody ought to know." It has been our experience in handling this subject and bringing it home to people that the little points are the ones on which they most quickly go astray, and on which they wish the fullest information. After they have a fair start, they are able to think out their operations for themselves. Accordingly we have covered

every point in this book in simple language and if the details in some places appear too commonplace, remember that we have erred on the side of plainness.

The customers to whom we have sold breeding stock have been of great help to us in arranging and presenting these facts. We asked them to tell us just the points they wished covered, or covered more fully, or just where our writings were weak. They replied in a most kindly way, nearly every letter thanking us heartily, and brimming over with enthusiasm for the squab industry.

It has surprised a great many people to learn that Homer pigeons are such a staple and workable article. They have been handled by the old methods for years without their great utility being made plain. When we first learned about squabs, we were struck by the impressive fact that here was something which grew to market size in the incredible time of four weeks and then was marketed readily at a good profit. The spread of that knowledge will make money for you. Show your neighbors the birds you buy of us, tell them the facts, and perhaps give them a squab to eat, then you will find a quick call for all the live breeders you can supply.

The procedure which we advise in this National Standard Squab Book is safe and sound, demonstrated to be successful by hundreds of our customers, many of whom started with no knowledge except what we were able to give them by letter or word of mouth. We have abandoned all instruction which does not stand the test of time and locality, and give only facts of proven value, of real, practical experience.

ELMER C. RICE.

Boston, August, 1902.

POSTSCRIPT.

This work has met with so much favor during the past year, and has sold so largely in excess of expectations, that we wish to thank our friends everywhere for their cordial support. The Appendix A which appears at the back of this edition was added last February, and it is our intention to keep the work up to date by revisions and additions at least twice yearly. The proof of the pudding is in the eating, and the

proof of these squab teachings is shown in the successes made by our thousands of customers with no other knowledge of squabs than this as a guide. Our correspondence, now having extended over a long period, shows conclusively that beginners find all questions answered in this book, and go forward confidently and surely to success.

E. C. R.

Boston, August, 1903.

1907 EDITION.

The old plates of this book have been fairly worn out by much printing, so great has been the demand for it, especially during the past five years. The sales have been larger than for any other work on birds or animals ever written. For this 1907 edition, the whole book has been reset in new type, and new plates made.

The outlook for the squab industry during 1907 and the years to come is of high promise. More people are eating squabs than ever before and more people are raising them. At no time within our memory has the market been overstocked with squabs, and prices have kept up all along the line. Only yesterday we were visited by a gentleman and his niece from New York City who stated that they had priced squabs there December 31 and found them seven dollars and fifty cents a dozen. The dealers who offered them at this price had paid the breeders for them from four dollars to six dollars a dozen, according to their postal card quotations sent out in December.

We shall be pleased to hear from our friends after they have read this book, and welcome any suggestions for its improvement, or for the betterment of the squab industry. The author will gladly answer all such letters and advise fully as to location and construction of buildings, and management of breeding stock.

E. C. R.

1912 EDITION.

Just a line to assure readers of this work that it is complete, up to date. Note particularly the new matter on the back pages.

E. C. R.

Boston, January, 1912.



BLUE-BARRED PLYMOUTH ROCK EXTRA HOMERS.

CHAPTER I.

SQUABS PAY.

Experience of a Customer who Started in January, 1902, Erected a Plant Worth Three Thousand Dollars and Made Money Almost from the Start—Settlements of Squab Breeders in Iowa, California, New Jersey and Pennsylvania—Large Incomes Made from Pigeons—Squab Plants Known to be Making Money—The Hard-Working Farmer and the Easy-Working Squab Raiser—No Occupation for a Drone—No Exaggeration.

“Will it pay me to raise squabs?” is the first question which the beginner asks. We take the case of a man who bought a Manual in January, 1902. His boys had kept a few pigeons but had never handled them in a commercial way, nor tried to make any money with them. The reading of the book gave him the first real light on the squab industry. Possibly he was more ready to believe because he knew from his own personal experience that a squab grows to market size in four weeks and is then readily marketable. He started at once to build a squab house according to the directions given. The ground was too hard for him to get a pickaxe into, so he laid the foundation timbers on bricks, rushed the work ahead with the help of good carpenters and sent on his order for breeding stock. In the course of a few weeks he ordered a second lot of breeders, followed by a third and a fourth, and he kept adding new buildings. When spring came and the ground softened, he jacked up his first squab house, took out the bricks at the four corners and put in cedar posts. By the middle of July he had five handsome squab houses and flying pens, all built by skilled labor in the best possible style at a cost of at least three hundred dollars apiece. With his buildings and their fittings and his birds, his plant represented an expenditure of between two thousand and three thousand dollars.

This gentleman lives in a locality where he had to put up nice-looking buildings, or the neighbors would have complained. He spent probably three times more money on his buildings

than the average beginner would spend. He is a superintendent of a large manufacturing plant, a man of push and energy, and he has four young boys in his family who have helped with the wife and grandfather to make the venture successful. It was a paying venture almost from the very start. Everything that we wrote about squabs as money makers came true in his case. One of the sons, a lad of nineteen, came on to see us the first summer and told us the story of their success. He was after more breeding stock. He said he had many calls from people who wished to buy stock of him, and he was unable to supply all of them, but he did not intend to have money offered him very long without being able to pass out the birds. In other words, they were going into squabs for all they were worth. They had not done any advertising, and had not sold live breeders to any extent, but figured their profits solely on the sale of squabs to commission houses, and they were getting for them just what we said the commission men would pay.

We have a great many visitors, some coming from remote points of the United States. One of our visitors in the summer of 1902 was Mr. A. L. Furlong, from a little town in Iowa. Mr. Furlong said to us: "Iowa is quite a squab breeding State. There are plants in Ruthven, Osage, Wallake and Estherville. The owner of a plant in Ruthven I know very well. He showed me his account books; he was shipping from seven hundred to eight hundred dollars worth of squabs last month. He is making a profit of three thousand to five thousand dollars a year. He ships to the Chicago market, as do nearly all the Iowa breeders. He never gets less than two dollars and fifty cents a dozen for his squabs. I am going to start raising squabs myself."

Mr. Furlong left an order for one of our Manuals, having given his first one to his friend. He said that his friend was breeding common pigeons and would like to know our methods. We discarded common pigeons some time ago. If our Iowa friends will use Homer pigeons instead of common ones, they will produce a much better squab and make more money.

We had a curious confirmation of the above in August, 1902, when Mr. E. H. Grice, who lives in the northern part of Vermont, visited us. Mr. Grice had just returned from a visit to the West, and stopped for a while at Ruthven, Iowa, where

he saw the plant above noted. The proprietor referred Mr. Grice to us and advised him to start with Homer pigeons, saying that, if he were to stock up again, it would be with Homer instead of the common pigeons. Before leaving, Mr. Grice gave us an order for one hundred pairs of our Homers.

The number of orders for breeding stock which we have received from Iowa is out of proportion to any State near it, showing that these squab plants are known throughout Iowa to be making money. The same is true of California. We visited many squab breeders in eastern States in June, 1902, noting the buildings and methods and finding out from them if they were satisfied with the financial returns. All were enthusiastic and said it was easy work, that squabs beat hens easily and were much less care. The methods of some of these breeders were extremely crude, the birds nesting in old boxes of all sizes nailed to the walls of the squab houses, and apparently never being cleaned. The Homers were small, not being able to raise squabs weighing over seven pounds to the dozen.

Somebody has said that a squab plant of one thousand pairs of birds will pay better than a farm. The contrast between the hard, grinding toil of the man who works a large farm and the "standing around" of the owner of a squab plant is indeed a striking one. However, we do not speak of this to give you the idea that money is going to flow into your lap just because you buy some squab breeders of us. It is no work for a drone or a "get-rich-quick" person whose enthusiasm runs riot for two weeks and then cools off. Our class of trade is men and women of experience and reliable common sense who have a knowledge of the world and understand that things come by work and not for the asking. The people who are able and willing to pay us from fifty to five hundred dollars for a breeding outfit, as hundreds do, are not caught by glittering promises, but have money laid by through exercise of the qualities of ability and shrewdness. The naturally careless, improvident person, who is generally in debt, should not start squab raising. It is a sensible industry for sensible people.

The profits to be made with squabs vary with the individual and with the management of the birds, exactly as with poultry. It is important to have only mated or even pairs in the pens and all birds not producing should be kept in a separate

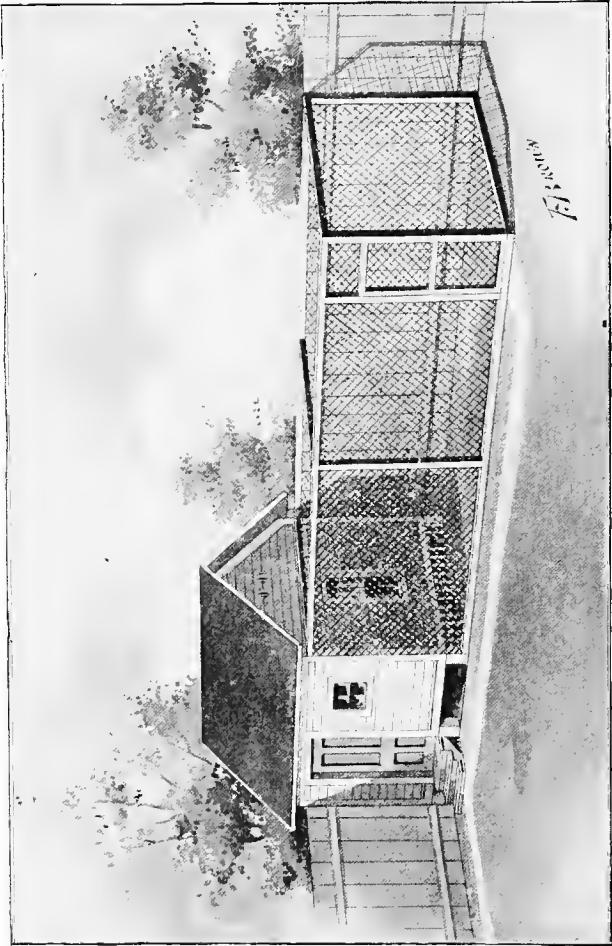

HOW A BACK YARD MAY BE FIXED FOR PIGEONS.

pen and removed to breeding quarters only after they have gone to work. The chief difficulty with a beginner is the matter of sex. The male and the female pigeon have no marks to distinguish them, and the beginner must determine their sex by observation. He must study his birds and come to know them. Some beginners will not equip themselves by study and observation to make a success and may breed in a hap-hazard fashion for a year or more without knowing the sex of the birds they raise. Birds which you raise will go to work more quickly, look better and breed better than any birds you can buy, because that is the temperament of the Homer, to be attached to his home, to love it, and to try to reach it if he can. Anybody who has doubts as to his ability to raise squabs should start with a small flock and breed up until he has acquired skill and experience.

As part of this Manual, in the supplement and appendices, we print many letters from customers who started with small flocks and won striking successes. It is not necessary to get a fancy price for the squabs to make the business a success. In confirmation of this we have in mind the work of two of our customers, young men named Lunn, who have received only two dollars to three dollars a dozen for their squabs, selling to dealers who retail them for four dollars to six dollars a dozen. These brothers have told their story in one of the poultry papers as follows:

“ In February, 1905, we got the idea of going into the squab business. We spent some time looking around and in March, 1905, we bought what we thought was the best stock, namely, the Extra Plymouth Rock Homers. We bought twelve pairs. The birds arrived on March 22, 1905, and were as fine a looking lot of birds as we had seen anywhere. We now (December, 1906) have three hundred pairs. One hundred and fifty pairs are well mated and working. The other one hundred and fifty pairs are all young birds. We raised all our young birds up until September, 1906, and since then have been selling squabs weighing from nine and one-quarter to ten and one-half pounds and receive twenty-three and twenty-five cents each. We feed the best of grain, using cracked corn, kaffir corn, red wheat, buckwheat and peas and a little hemp. We also give a little rice once or twice a week. During the moulting season we added barley to regular

rations, which was a great help to the birds all that time. We use the self-feeder as described by Mr. Rice in his Manual and we find with it the grain is always clean. We have made the feeding question one of the most important of all and find that the best results are obtained by keeping plenty of grain and good clean drinking water before the birds at all times. The drinking fountains used are automatic and are scalded once each week. About once a week we give a teaspoonful of gentian to a gallon of water. We keep fresh water in the flying pens for bathing purpose at all times during the summer, and in the winter we allow our birds to bathe twice a week at noontime. One thing that is very essential with pigeons is to be kept clean. Our houses and nests are cleaned every week and we also spray the floors, nests and walk with a liquid disinfectant. We have never been troubled with lice, vermin or any disease of any kind. For nesting material we use tobacco stems, cutting them into pieces of about six inches, which we consider the best material for the purpose, and also a safeguard against lice. We feel satisfied with what our birds are doing and have done in the past, so well satisfied, in fact, that we have now under construction buildings that will accommodate nearly one thousand pairs of birds. And the cost of keeping or feeding will not exceed one dollar a year per pair, so that squabs selling from two dollars to three dollars per dozen are sure to leave a good profit."

Looking at the financial showing of the Lunn boys, made in twenty-two months, we find that starting with twelve pairs, for which they paid us thirty dollars, they raised three hundred pairs, worth at the same rate seven hundred and fifty dollars. From this must be deducted the grain which they bought in that period. They start the new year with a fine plant capable of earning a big percentage of profit on its valuation.

CHAPTER II.

AN EASY START.

No Special Form of Building Necessary—Points to Remember—Shelter Adapted to the Climate—How to Use a Building which you Now Have—Squab House and Flying Pen—Lining the Squab House with Nests—Use of Egg Crates—How to Put up the Perches—Difference between the Nest Box, Nest Pan and Nest—How to Tell How Many Pigeons can Occupy a Certain Building—A Large Flock of Pigeons is Easily Cared for when Split up into Small Flocks—How to Use Your Time to Best Advantage.

Do not get the idea that any special form of building is necessary to raise squabs. We will tell you how to put up a structure that will make your work easier for you, and enable you to handle a big flock fast and accurately, but pigeons will work in almost any place, if it is free from rats, darkness and the musty dampness which goes with darkness. Any building, whether a woodshed, a corn crib, a barn, an outhouse of any description, or even a hog pen, can be made a successful home for pigeons with a little work.

The points to remember are these, first, that the building be on fairly level, sunny ground; second, that it be raised from the ground so that rats cannot breed under it out of sight and reach; third, that it ought to be fairly tight, so as to keep out rain and excessive cold. Pigeons ought to have sunlight and fresh air, like any other animal, and need protection from the elements.

In practice, therefore, most squab houses are found raised on posts a foot or two feet off the ground; they face the south (here in New England) because most of our bitter weather comes from the north and east. If you live in a State, territory or foreign country where conditions are different, adapt your squab houses to those conditions. In some localities, the fierce weather comes from the south and west, in which case your squab house should face the north or east.

Here in New England we build a tight house to withstand

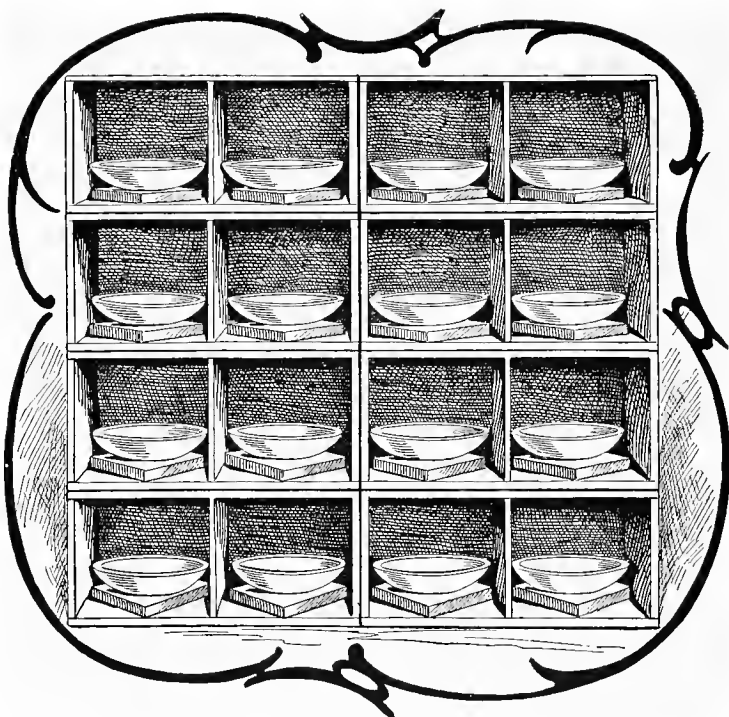

CHEAP BUT PRACTICAL NEST BOXES.

These are empty egg crates piled one atop another from floor to roof of squab house. Each egg crate is two feet long, one foot wide and one foot deep. The partition in the middle makes two nest boxes, each one foot square. Into each of these nest boxes a wood nest bowl is placed. The birds build their nests in these wood nest bowls.

the cold winters, but in the South the buildings are more open. Be guided by what you see around you in the place where you live. If the houses used by your friends and neighbors for hens and chickens are tight and warm, make your squab house tight and warm. It would be foolish for you, for example, if you live in Texas, to build a strong, tight, close squab house, for in that latitude, in a henhouse built tight and close, vermin would swarm and harass the chicks, and they would harass the squabs just as fast.

Some of our customers write from places like Oregon and Idaho, where there is a wet and a dry season, and are puzzled to know what to do. In such cases we say, arrange your buildings as you see poultry houses arranged. The pigeons will do as well under the same conditions as hens and chickens.

Suppose you have a vacant building or shack of any kind in which you wish to raise squabs. We will take for granted that it has either a flat roof or a ridgepole with sloping roof, and that it is built in rectangular form. Never mind what the dimensions are; our advice will apply to either the large or the small structure.

First raise it off the ground, or build a new floor off the ground, so that rats cannot breed out of your sight in the darkness and get up into the squab house. If there is an old floor, patch up all the holes in it. Now you need one door, to get yourself in and out of the squab house, and you need at least one window through which the pigeons can fly from the squab house into the flying pen and back from the flying pen into the house. You will shut this window on cold nights, or on cold winter days. You must cover the whole window with wire netting so that the birds cannot break the panes of glass by flying against them. If you have no wire netting over the window, some of the birds, when it is closed, will not figure out for themselves that the glass stops their progress, but will bang against the panes at full speed, sometimes hurting their heads and dazing them and at other times breaking the glass.

The flying pen which you will build on the window side of the squab house may be as small or as large as you have room. The idea of it is not to give the birds an opportunity for long flight, but simply to get them out into the open air and sunlight. They enjoy the sun very much, it does them good

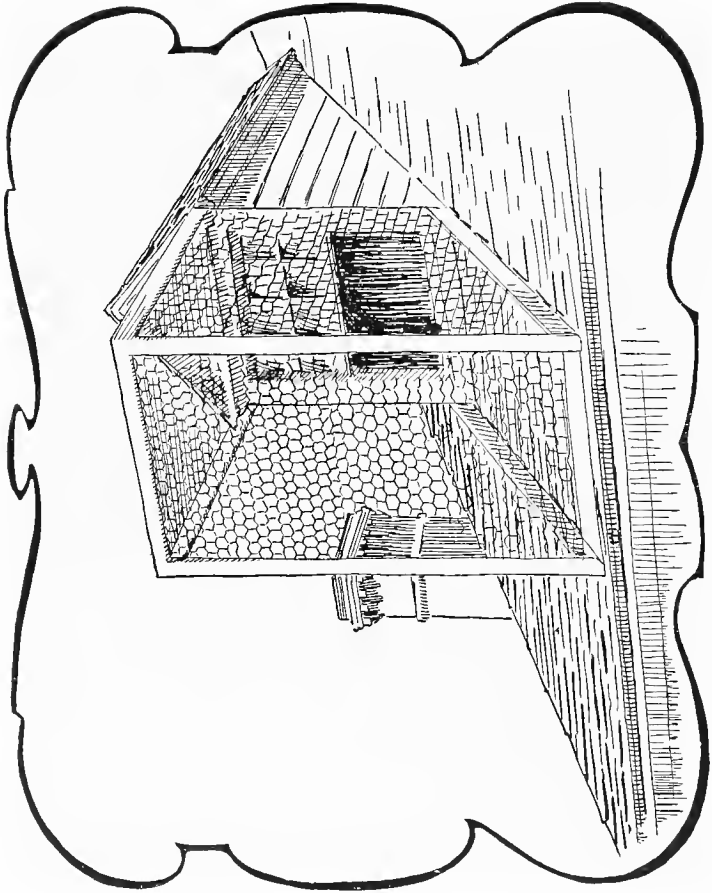

HOW CITY DWELLERS WITHOUT LAND MAY BREED SQUABS.

and they court its direct rays all the time. Build the flying pen, if you choose, up over the roof, so the birds may sun themselves there. If that side of the roof which faces the flying pen is too steep for the pigeons to get a foothold, nail footholds along the roof, same as carpenters use when they are shingling a roof, and the pigeons will rest on these to sun themselves. For the flying pen you want the ordinary poultry netting, either of one-inch or two-inch mesh. The two-inch mesh is almost invariably used by squab raisers, because it is very much cheaper than the one-inch mesh. The one-inch mesh is used only by squab raisers who are afraid that small birds (the English sparrows here in New England) will steal through the large meshes of the two-inch netting and eat the grain which you have bought for the pigeons. You can buy this wire netting in rolls of any width from one foot up to six feet. If your flying pen is twelve feet high, you should use rolls of the six-foot wire. If it is ten feet high, rolls which are five feet wide are what you want. If your flying pen is to be eight feet high, buy rolls which are four feet wide. In joining one width of wire netting to its neighbor, in constructing your flying pen, do not cut small pieces of tie wire and tie them together, for that takes too much time and is a bungling job, but buy a coil of No. 18 or 20 iron wire and weave this from one selvage to another of your wire netting in and out of the meshes, and you have the best joint.

You can line the three walls of the interior of your squab house with nest boxes if you choose. The fourth wall is the one in which the window or windows are. On this fourth wall you should not have nest boxes, but perches. These perches, or roosts, should be tacked up about fifteen inches apart, so as to give the birds room without interfering with one another. The advantage of the V-shaped roost which we advise is that a bird perched on it cannot soil the bird underneath. We sell for five cents each pigeon perches as illustrated on page 32 of this book, which is cheaper than they can be made of lumber.

Please note particularly at this point the following terms which we use, and do not become confused. The nest box is something in which rests the nest bowl in which the nest is built. Do not speak or think of nests when you mean nest boxes.

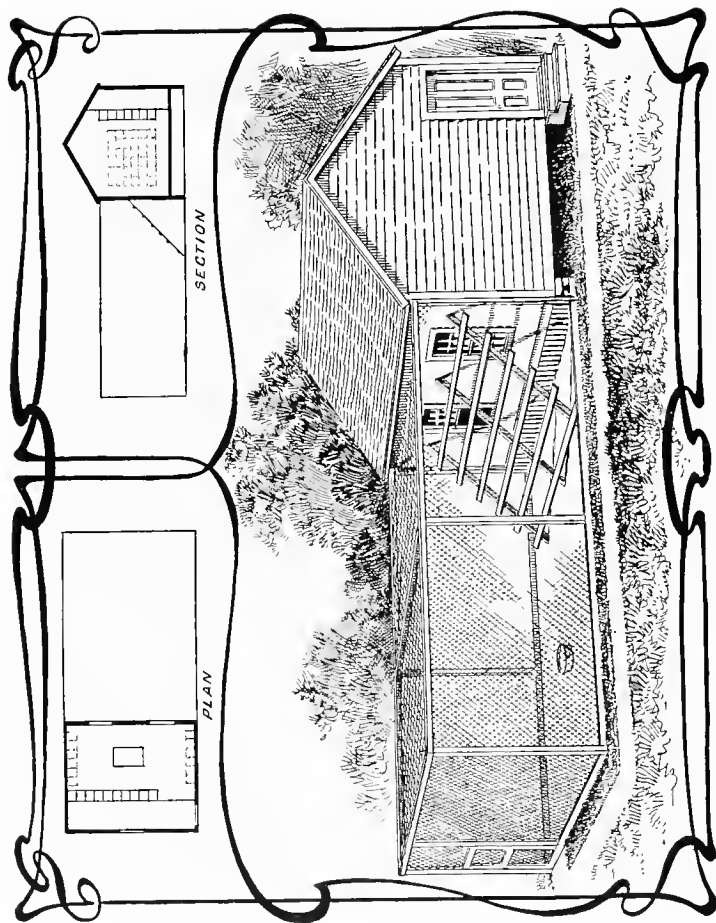

UNIT SQUAB HOUSE (WITH PASSAGEWAY) AND FLYING PEN.

The nest boxes, when done, should look like the pigeon-holes of a desk, and should be about one foot high, one foot wide and one foot deep. A variation either way of an inch or two will not matter.

One way to get these pigeon-holes is to build them of nice pine lumber, in the form of boxing one-half or five-eighths of an inch thick. Another way is to use hemlock or spruce boards one inch thick. The third way (which we think is the best for the beginner who wishes to start most cheaply and quickly) is to use egg crates, or orange boxes. These egg crates are two feet long, one foot wide and one foot deep, but they are divided in the middle by a partition, giving two spaces, each of a cubic foot, and this is just what the squab raiser wants. They are procurable almost anywhere in the United States and Canada new for ten or fifteen cents each, and if you buy them after the egg shippers are through with them, you can get them for three to five cents apiece. Some grocers will be glad to have you carry them away and will charge you nothing for them. The crates are built of thin, tough wood and usually are neat and solid. Take off the covers and throw the covers away,—you do not need them. Then put one egg crate on its side, open top out, place another egg crate on top of that, and so on until you have covered the three walls of your squab house from the floor to the roof. Do not use any nails, they are not necessary: the crates will keep in position by their weight. It is an advantage, also, to have them loose, for when you clean the nests, you can step up on a chair or box, take down the crates, commencing with the top, and clean each one with your feet on the floor. If you build a substantial set of nest boxes of boxing or hemlock lumber, you will have to stand on a chair and strain your arms in order to clean the top nest boxes, so you see there are points in the low-priced arrangement not possessed by the fancy kind. It is on the same principle by which a humble small boy with bent pin and worms and an old pole catches more fish than the city angler with a twenty-five dollar assortment of hooks, lines and artificial flies. It is the pigeons and the intelligence behind them which do the trick, every time. A fancy pigeon house with fancy trimmings cannot produce any better squabs than the home-made affair, provided the birds are the same in both cases.

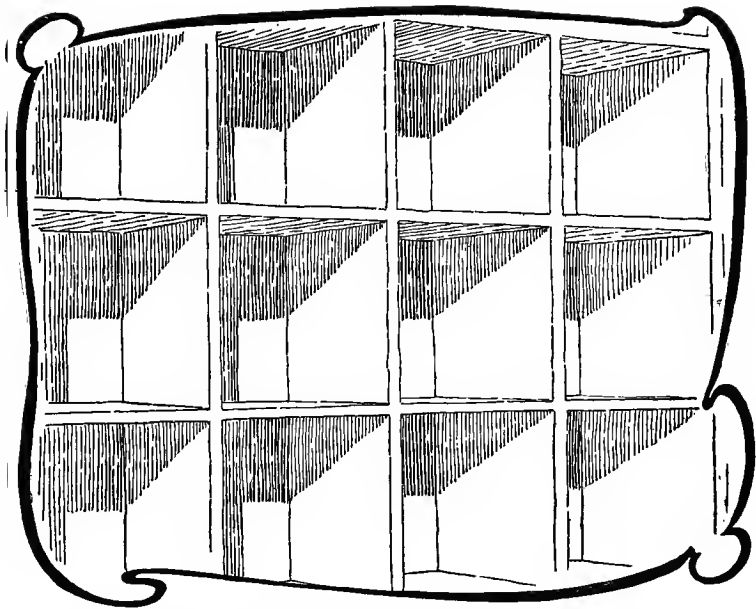

NEST BOXES BUILT OF LUMBER.

This shows the front of the nest boxes as they face the interior of the squab house. They are from ten to twelve inches square, and the same distance deep. A slight variation does not matter. The fronts of the nest boxes are perfectly plain, as shown. It is not necessary to nail up pieces of board to keep the squabs from falling out. They will not fall out.

You should have a pair of nest boxes for a pair of pigeons. By a pair of pigeons we mean two pigeons, a male and a female. By a pair of nest boxes we mean two nest boxes. We find that the word pair has a different meaning to people in different parts of the country, perhaps on the same principle that a pair of scissors or a pair of suspenders is one object, while a pair of something else, as in this case, means two objects. A pair of pigeons attend to a pair of squabs in one nest box, nevertheless for each pair of pigeons you need two nest boxes, for when the squabs are about two weeks old in one nest, the old birds will go to the adjoining nest box, or to a nest box in a distant part of the squab house, and begin housekeeping again, laying eggs and dividing their attention between the two families.

Count your nest boxes and you will know how many pigeons your house will accommodate. If your count shows ninety-six nest boxes (in other words, forty-eight pairs of nest boxes), you can accommodate (in theory) forty-eight pairs of pigeons. It is important to remember this: Never fill a house with pigeons to the uttermost limit of its capacity, as shown by count of nest boxes. If you have, for example, forty-eight pairs of nest boxes, do not put into that house more than thirty to forty pairs of pigeons. That will leave plenty of nest boxes for the birds to choose from. We have found by experience that thirty or thirty-five pairs in a ninety-six nest-box house will accomplish more than more pairs in the same space.

Do not write us and tell us that you have a house of a certain size and ask us to tell you how many pairs of pigeons it will accommodate. Put in your nest boxes as we have described and then count them, and you will know. Or you may figure it out for yourself on paper, allowing two nest boxes, each one cubic foot in size, for each pair of birds. To put it in another way, you should allow one cubic foot of nest box space for each breeding pigeon. Surely we have made this so plain now that you cannot go astray.

Perhaps your start will be made with so small a number of birds that you will not have to cover more than one wall of your squab house with nest boxes. Cover one wall, or two walls, or three walls, whichever the occasion demands. Have a lot of spare boxes, and let the breeding pairs choose where

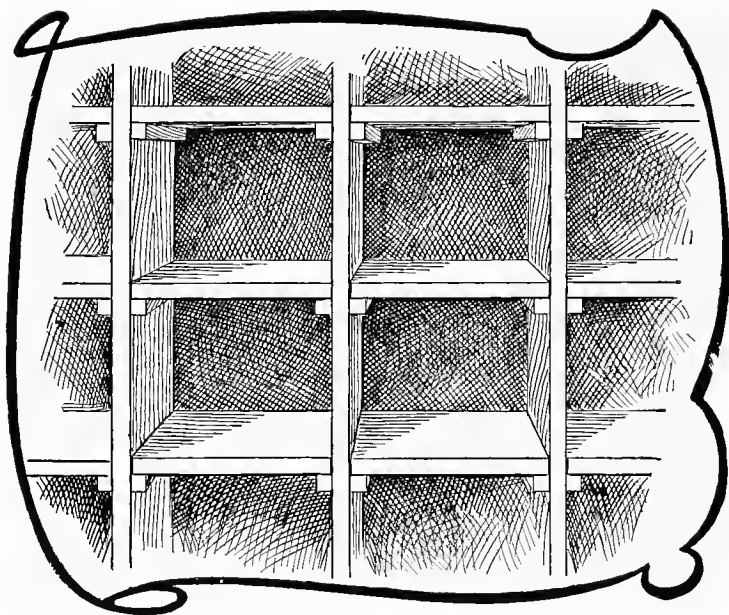

BEST NEST BOX CONSTRUCTION.

When the nest boxes are built of lumber (one-half an inch or five-eighths of an inch thick) the above construction should be employed. The bottoms are not nailed, but slide in on cleats, as shown. The result is a sliding shelf. This shelf may be pulled out at cleaning time and a better and quicker job of cleaning done.

The nest bowls may be screwed directly to the bottoms of the above nest boxes. If that is done, it will not be necessary to screw the nest bowls to blocks of wood, to give them stability.

The nest boxes should be from ten inches to twelve inches square.

The backs of the nest boxes in this and every case are solid wood, not of wire netting. The back, top, sides and bottom of each nest box are solid. Only the front is open.

they will. An extra number of nest boxes may be useful to you to accommodate the young birds raised to breeding age from the old birds which you buy of us, if you intend to raise your squabs to breeding age.

An expenditure of not over five dollars, and a couple of days' time, will transform the average old building into a habitation for squabs. Put on the finishing touches and add to the expense to suit your fancy. You may cover the outside of the building with building paper, and shingle or clap-board it. You may put a skylight in the roof for ventilation. Improve it all you wish. Use your own judgment.

To get at your pigeons in such a house, you walk in through the door and find yourself directly among them, the nest boxes all pointing at you. Go to the nest which you wish to investigate or from which you wish to take out the squabs and put your hand in the opening. The old birds will fly by your head, perhaps, and may strike you with their wings, but they will not fly into your face and eyes,—they are good dodgers. Don't be afraid that if you enter the house when the housekeeping is going on you will frighten the birds so they never will come back to the eggs or the squabs. They will seem timid at first, but they will get accustomed to you.

In the course of a few weeks, only a few will make a great hustle to get away from you. Many of them will continue to sit contentedly on the eggs and if you put up your hand to them they will not fly off in fear but will slap you with their wings, telling you in their language not to bother them. Carry some hempseed in with you and you will teach the birds to come and eat it out of your hand. You can tame them and teach them to love you as any animal is taught. The pigeon, particularly the Homer, the king of them all, is a knowing bird.

We sell perches of our own manufacture which are cheaper than they can be made at home out of lumber. Price, five cents each, ten for fifty cents, twenty for one dollar, one hundred for five dollars. Sample by mail for eight cents. These perches are pictured in position in the squabhouse on the next page (32). They are just screwed into the wall wherever convenient. Put up as many perches as you please about eighteen inches or two feet apart on the inside of your squabhouse, on the walls. The arrangement should be about

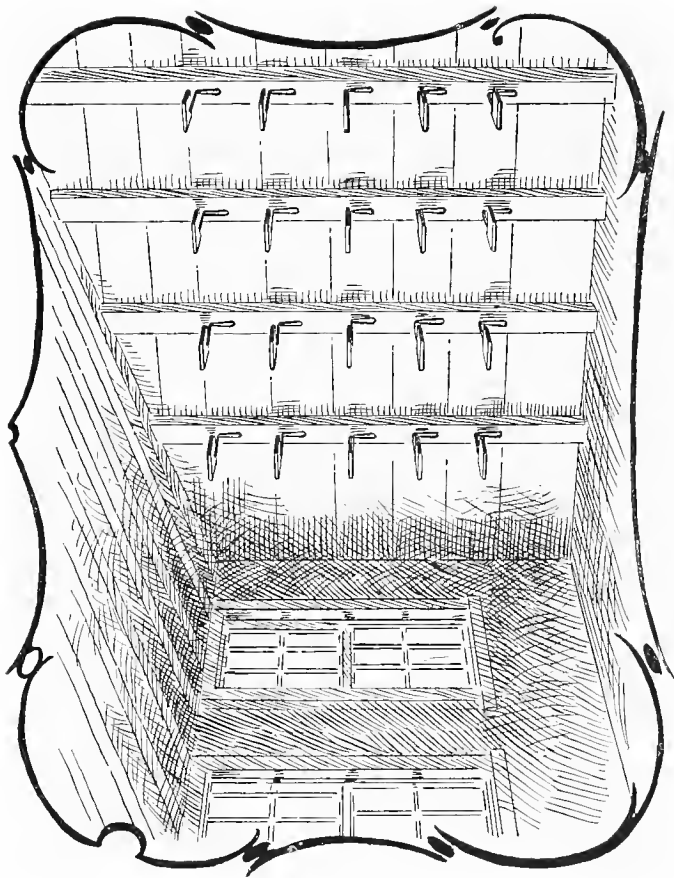

INTERIOR OF SQUAB HOUSE, SHOWING PERCHES.

as shown in the illustration. You cannot have one long pole inside the squab house for a pigeon perch. If you had such a pole, and your pigeons were perched on it, or some of them were, a bully cock would saunter down the line and push off all the others.

In the centre of the squab house you place an empty crate or overturned box. The object of this is to break the force of the wind made by the pigeons' wings as they fly in and out of the squab house. Otherwise the floor of the squab house would be swept clean by the force of the wind. It also forms a roosting-place for the birds, and, finally, it is a convenient resting-place for the straw, hay, grass or pine needles out of which the pigeons build their nests.

The floor of the squab house should be kept clean. We formerly advised that a layer of sand or sawdust half an inch thick be kept on the floor of the squab house, to absorb the droppings, but we have found a steady and profitable demand for pigeon manure, and this manure is worth scraping up and carefully saving, for its sale will pay from one-quarter to one-third of the grain bill. Use an ice chisel to scrape the droppings from the floor, and pack the manure away in barrels or bags. Clean the floor about once in three weeks, or oftener, depending on the size of your flock. Pigeon manure is in active demand all the time by tanneries. We send the manure from our pigeons by freight to tanneries in Lowell, Lynn, Peabody and Danvers, and are paid for it at the rate of sixty cents a bushel.

We have a building eighty feet long built especially for the drying and storing of the manure. During the years we have been in the squab business, we have sold enough pigeon manure to pay for nearly all the pigeon buildings on our farm. Some pigeon raisers with crude methods know nothing of the value of the manure and lose this by-product. They either ruin it by putting sand or sawdust on the floor of the squab house, or else waste it on their gardens. The pure manure is too valuable for home use. To fertilize our flower and vegetable gardens, and hay field, we scrape up from the flying pens, outdoors, the gravel which has become saturated with manure. It is surprising what an increase in vegetation this manure-soaked gravel will cause. Fresh gravel is put down in the flying pens.

A peculiarity about pigeon manure is that it is not foul-smelling like hen manure, and when it is mixed with water you get a kind of crude soap. In washing the old-style earthenware nest bowls, no soap was necessary. We used warm water in washing them and the manure caked to them formed a cleansing soap in conjunction with the water. If you have a basket in which you have transported pigeons, and whose bottom is caked with the hard droppings, lay the basket face down and sprinkle water liberally on the underside. The manure will drop off in large pieces from the inside and the basket will become perfectly clean.

In raising live-stock of any kind, arrange matters so the animals will look after themselves as much as possible. Aim to cut down the factor of personal drudgery, so as to leave your time clear to observe, plan, and execute intelligently. Beginners who load themselves down with a daily round of exacting duties soon lose heart, their patience gives out and they become disgusted. We have known breeders of rabbits to fail simply because they raised them in hutches. Each hutch had a door and two dishes, one for feed, the other for water. Every day, the door of the hutch had to be opened, the hutch cleaned, the dishes refilled (and often cleaned), and the door closed. It took fifteen or twenty motions to do this for each hutch. Multiply this by twenty to thirty (the number of the hutches), and the burden grew unbearable. It was not surprising that in three or four months the breeder's patience was worn out. The factor of personal drudgery had become greater than the rabbits. The thoughtful breeder would have turned his rabbits into two or three enclosures on the ground and let them shift for themselves. Then one set of motions in feeding would have answered for all, and there would have been no dirt to clean up. Infinite patience as well as skill is required to make a success of animals given individual attention. The aim of every breeder should be to make one minute of his time serve the greatest possible number of animals. When you think and reason for yourself, you understand how much more practical it is to give sixty animals one minute of your time than one animal one minute. Time is money and if you are too particular, and too fussy, and thoughtless about these details, it is a clear case of the chances being sixty to one against you.

At the start, the problem of breeding squabs for market is in your favor, because one hundred pairs of breeding pigeons may be handled as easily and as rapidly as one pair. Try to keep this numerical advantage in your favor all the time. Discard every plan that cuts down the efficiency of your own labor, and adopt every device that will give you control in the same time over a greater number of pigeons.

It takes brains and skilled labor to run a poultry plant successfully. Every poultryman knows that he cannot entrust the regulation of temperatures of incubators and brooders to an ignorant hired man, but even a boy or girl, or under-the-average farm hand, knows enough to fill up the bath pans and feeding troughs for squab-breeders, leaving the time of the owner free for correspondence and the more skilful work.

The primary object is to breed squabs for market as cheaply, as easily and as fast as possible, without the expenditure of a dollar for fanciful or impractical appurtenances.

Do not think it is necessary to heat your squab house. A squab house which has the chill of dampness taken off it by hot water or steam pipes will raise more squabs than a house not heated, but a flock of pigeons in a small house throw off considerable heat from their bodies and will breed in cold weather all right. After you have developed your plant and have a large business which you wish to keep at the highest state of efficiency, you may heat your squab house. The idea of heat in winter time is to keep the birds more contented and get more squabs out of them, and not at all to keep them alive. Do not be afraid that your pigeons will freeze to death. We have many customers in Canada. In coldest weather, the old birds hover the squabs more carefully.

City people can keep pigeons in the garret of a house, or the loft of a barn, without a foot of ground being needed. In such a case the flying pen, or place to which the pigeons go for sun and air, can be built out on a platform. The illustration (page 24) shows how to utilize a window of a garret. If you think that rats will trouble you in either a garret or barn loft, cover the floor inside, especially the corners, with fine wire netting through which it will be impossible for the rats to gnaw from below.

One of our customers in Illinois, a rich horse breeder having

a barn some two hundred feet long, turned the whole upper story into a loft for pigeons. The flying pen takes in the whole back of the barn. There are windows and no doors on this side of the barn, the horses using doors on the other side, so this leaves the upper story of the barn, and its whole back-yard, free for the pigeons.

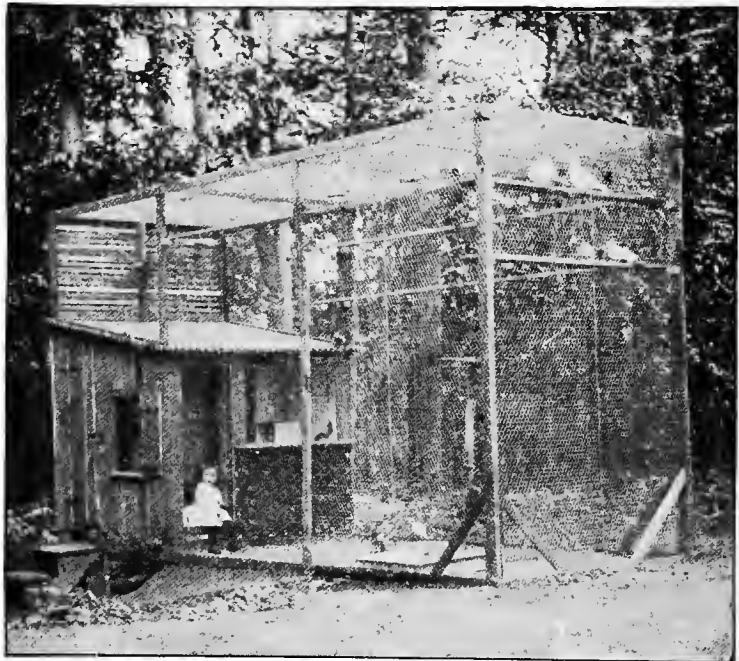

A PRETTY SQUAB HOUSE AND FLYING PEN.

CHAPTER III.

THE UNIT HOUSE.

Best Possible Construction for a Squab Plant—The Wind-Break Formation of Roof—Dimensions of the Unit—Multiplying the Unit to Increase the Capacity of Your Plant—A Passageway behind the Nest Boxes—Numbering the Nest Boxes, and the Management of a Card Index to Correspond—Cost of the Unit Construction is from Three Dollars to Five Dollars a Running Foot—Working Drawings—The Nest Bowls.

If you have no building already standing which you can fix over for pigeons, you may erect a simple rectangular structure and line it with nest boxes as we have described in the last chapter. We will tell you in this chapter how to put up the finest kind of a pigeon structure. It is at the same time the most expensive. It is the best, the most workmanlike. In saying that it is expensive, we do not mean that money is thrown away on its construction, for that is not so. It is a fit habitation for a money-making investment.

This best method of construction results in what we call the unit house. You can multiply this unit as many times as you please and get as large a house as you wish, or you may add a unit from time to time, just as you add unit bookcases to accommodate the growth of the modern library shelves. You can erect these units separately, or attach one unit to the other so that you have one long building.

The nest boxes are built of boxing and set in a vertical row at the back of the house, forming a wall between which and the north side of the house is a three-foot passageway. You can buy this boxing at a saw-mill all cut, ten by eleven inches, the dimensions of the nest, and if you get it in this shape you can put the boxes together with as much ease as a child builds a doll's house. You will have no doubts as to the squareness and plumbness of the structure when you have it up. Take long lengths of boxing eleven inches wide for the shelving which should form the top and bottom of the nest boxes, then set the ten-inch by eleven-inch pieces the proper distance

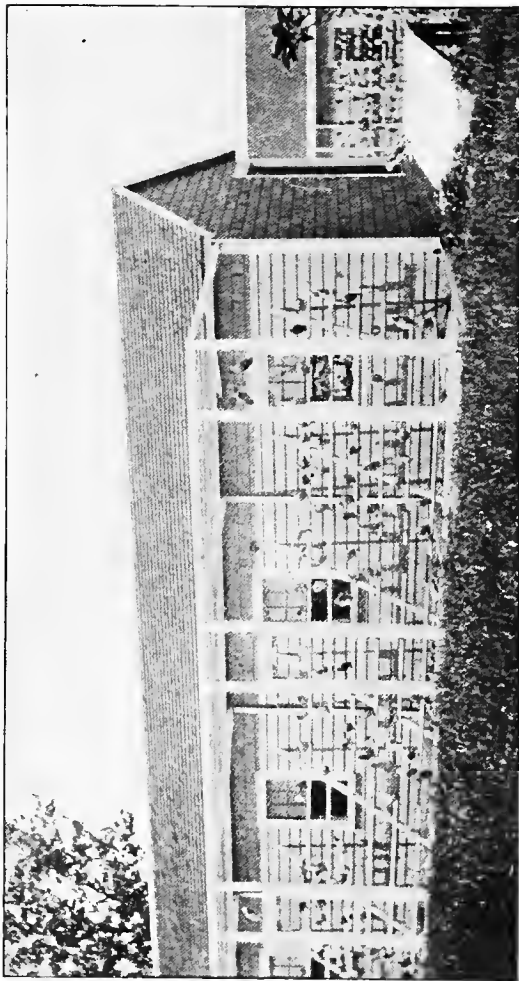

MULTIPLE UNIT HOUSE.

Extend this construction 100, 200, 300 or more feet to form a big plant.

part. The finished nest will be eleven inches from front to back, ten inches from top to bottom, and about ten inches from one partition to the other (or whatever distance the proper distribution of your nests in pairs permits).

We have found five-eighths-inch boxing to be the best suited. Build the nest boxes up from floor to roof perfectly plain, just as the pigeon-holes of a desk run.

The nest boxes should be perfectly plain, made of simple boxing in the manner described. Do not build up a piece of boxing at the front part of the nest to prevent the nest bowl from being pushed out. Early in our experience we built nests in this way, but soon changed them over to the simpler form, on account of the difficulty of keeping them clean. The droppings bank up at the front of such a nest box.

Pigeons, especially a new flock in a new home, breed best in a house which is somewhat dark, and not too glaring with light. If your window is situated so as to let in a flood of light, you will get better and quicker results by shading it so that the interior will be dim. Some breeders advocate that the nest boxes have fronts of wood (removable) so that the nest box will be darkened. The same result will be accomplished if the window of the house is shaded so as to temper the light and prevent it from streaming into the nest boxes.

The dimensions of this unit squab house are as follows: Length, sixteen feet; width, twelve feet; length of flying pen from end of house to end of yard, twenty feet; distance from floor of squab house to ridgepole, twelve feet; two windows in south wall of squab house, each two feet two inches wide and three feet ten inches high. One window in north wall of squab house, two feet two inches wide and three feet ten inches high. There is a passageway on the north side of the squab house three feet wide, separating the north wall from the vertical row of nest boxes. The door of the squab house opens into this passageway so that you can enter the house without being seen by the birds, and without disturbing them.

If you wish, you can set up rows of nest boxes on the east and west walls of the squab house and accommodate more pairs. You cannot have a passageway behind these nest boxes on the east and west walls, but will approach them from the front by entering the interior of the squab house through a wire door which leads from the passageway.



INTERIOR OF MULTIPLE UNIT HOUSE.

This is one of our houses. The drinking fountains stand in the passageway and their fronts project through the wire netting under the first row of nest boxes. The nest boxes are empty egg crates. The feed troughs are inside of each pen. In other houses, we set the feed troughs alongside the drinkers in the alleyway and cut away the netting so the birds can feed from them. We like the last arrangement best because the troughs can be filled more quickly from the passageway, and the time of opening and closing doors and going into pens is saved.

Build the first unit so that you can extend it either to the east or west (as your land lies) to increase your accommodations. Your squab house will always remain sixteen feet from north to south, but it may be either twelve feet from east to west, for one unit, or twenty-four feet for two units, or thirty-six feet for three units, and so on. Of course you can build one long house sixteen feet wide and in length any multiple of twelve, and keep all the birds you wish in it, but we do not advise such an arrangement. You can keep track of your pairs better if you split a big flock up into unit flocks.

Fanciers breeding flying Homers from our birds, or squab-raisers who wish to keep track of every pair of birds, can provide a card index (the cards being perfectly blank and three by five inches in size), number the cards to correspond with the nest boxes, and on these cards keep a record of what the birds in the nest boxes do. These cards, which are blank except for the numbers they bear, can be kept in a tray such as the manufacturers of card indexes advertise in the back pages of the magazines and you can pick out any card you wish, or turn to it, at once. It is much better than keeping a record in a book, for you cannot tear out the leaves of a book, as you can throw away a card, nor can you shift one page from one location to another, as you can a card in a tray.

The floor of the squab house rests on cedar posts and is two feet from the ground. The floor is built of two thicknesses of board, with building paper between. The walls of the squab house are built of boards which are covered with building paper and shingled. The roof is shingled. You can use clapboards on the sides, or common boards.

The cost of such a squab house, complete with flying pen and all inside fittings, built in the best possible manner, will be from three dollars to five dollars a running foot. That is to say, a unit plant twelve feet long will cost from thirty-six to sixty dollars. A plant consisting of three units, thirty-six feet long, will cost from one hundred and eight to one hundred and fifty dollars. We publish and sell for ten cents working drawings showing just how to build a unit in every detail. On the same sheet are working drawings for building a simple squab house (without passageway) to cost from fifteen to twenty-five dollars. Also on the same sheet we give data showing how one of our friends built a

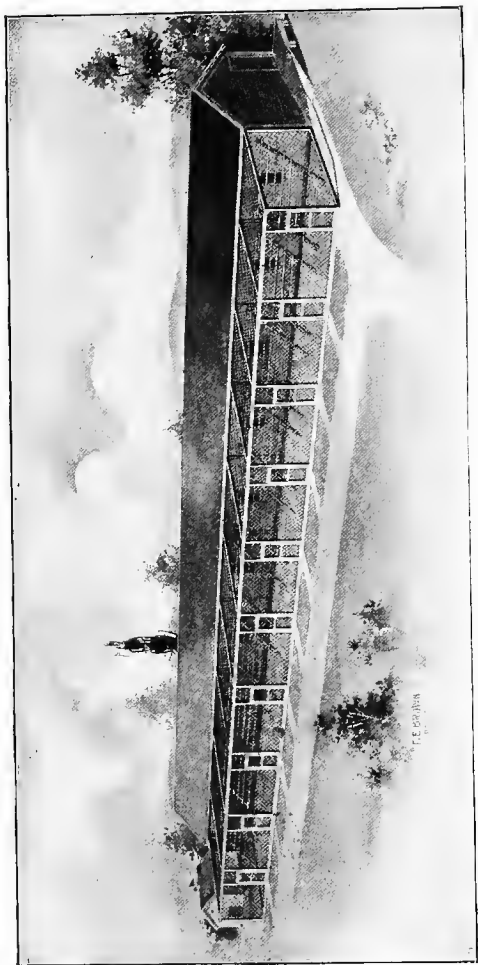

MULTIPLE UNIT HOUSE. TEN UNITS. BUILT ACCORDING TO OUR PLANS.

The construction is thorough but simple, handsome as well as practical.

squab house and pen capable of accommodating two hundred and twenty pairs of breeders at a cost of one hundred and thirty dollars. In ordering, simply say you wish plans and specifications for squab houses.

Some who wish the best construction write us to ask if a cement floor is not better than a wood floor. It is when properly laid, but not when laid thinly and poorly. A thin floor with a poor foundation looks good when freshly laid, but the first winter causes the dirt foundation to shrink and swell, then come cracks in the cement. Rats and mice burrow in the dirt up to the cement and find their way through the cracks to the squabs. In a short time, they are a nuisance. We have seen a squab house built with cement floor which cracked as described and every time the owner and his dog took a walk down the alleyway, they found rats to kill. Finally the whole lot of cement had to be pounded to pieces, shoveled up and carted off. The way to stop rats and mice is to erect the building on posts as we have described. Rats and mice live in the dirt and they cannot get up into the squab house. If a cement floor is properly laid of sufficient thickness on a good foundation according to our concrete block squab house building plans (see next page), it is proof against frost, will not crack, and will wear forever.

In our early plans for the unit squab house, we provided for a building with a "jog" in the roof, making a long, low slope for the south side of the roof, and on this slope the birds would sun themselves and make love. This "jog" construction is more expensive than is needed, and now we have a better way. We have an ordinary pitch roof, sloping equally from the ridgepole to both north and south. We run the flying pen out on the south side, not from the ridgepole, but from the eaves, and then out in the flying pen we erect perches as shown in the picture. The fact that the birds rest easily on these perches (as the photograph in Appendix A shows) is proof that they are contented and pleased by such an arrangement. We have found, too, that they can hear the squeaks of their young for food better than if they are up on the roof, and better attention to the squabs is the result. It was formerly thought unsafe to erect perching poles in the flying pen directly in front of the windows, the fear being that birds darting suddenly out of the windows

would strike the perching poles and become injured. Such a fear goes on the assumption that a pigeon cannot take care of itself in flight. They are quick of eye and quick of wing, and are intelligent to a high degree, and we never knew a bird to be injured by flying against horizontal perches in the flying pen. They never strike them but always fly between them or alight on them.

Please note particularly that if you erect one long building which will be a multiple of units, you separate these units, both inside and outside of the squab house, not by board partitions, but by wire partitions. For instance, if you have a building one hundred feet long, ten units, you will separate the units by nine wire partitions, these partitions being erected both inside and outside the house.

NOTE. On page 41 we tell of building plans which we sell for ten cents. Those plans show how to build the unit squab house of wood as shown on page 26 of this book, or, if the construction is extended, the multiple unit squab house of wood as pictured on page 42. Lately, on account of the increased cost of lumber and the wide spread of the use of cement, we have had calls for plans for a

CONCRETE BLOCK SQUAB HOUSE.

We now sell at ten cents plans for the unit squab house of concrete block construction. These show the perspective view as well as the ground floor plan and elevation. You will find probably in your town, or nearby, a dealer in the cement blocks of which this house is built. The general plan of this concrete block squab house is the same as our wooden squab house, with the exception that the south side has one large pivoted window frame to be covered with cloth (no glass) so as to accustom the pigeons to the prevailing temperature of fresh air at all seasons of the year, and to secure at all times good ventilation.

In ordering building plans, please specify whether you want the wood building plans or the concrete block building plans. They are ten cents each, or both for twenty cents.

CHAPTER IV.

NEST BOWLS AND NESTS.

Do Not Use the Old-Fashioned Nest Pans—Obvious Faults of the Earthenware Nappy—The Wood-Fibre Nest Bowl—How the Pigeons Choose Nest Boxes—What to Use for Nesting Material—How the Birds Manage their Nests.

For nest pans, do not use the heavy, deep, red clay, unglazed dishes which you may see offered for sale as pigeon nests. They are a relic of the past.

In our early experience we used for a pigeon nest bowl the common kitchen yellow earthenware nappy. We employed two sizes, the six-inch and the seven-inch, changing from the large one to the small one when the squabs were two weeks old. These earthenware nappies filled the bill in being cheap and shallow, and the pigeons deposited their manure in a circle outside and not inside the nest, but they have faults which are obvious. They are flat and not rounding on the bottom. When the female pigeon turns the eggs (as she does daily, same as a hen, in order to give the heat of her body to the whole shell and to give fresh albumen to the germ) the eggs are liable to roll apart, making it necessary for the bird to gather them together again, and after two or three mishaps like this she is liable to desert them. The earthenware is cold, breakable and can be kept clean only with water. The washing of the nappies becomes a tedious task and is often neglected. In winter weather, the earthenware dishes become so cold that one's fingers are numbed by handling them—and the squabs which sit in them are numbed, even frozen.

Later we perfected a nest bowl made of wood which met every objection raised against earthenware. We sold thousands of them during the two years we had them on the market and they gave good satisfaction except when some were made of improperly seasoned lumber, in which case they would crack and split after a few months' use. After study and experiment to remove this objection, we had expensive patterns and moulds made and began the manufacture of



OLD-STYLE NEST PAN. WATER DISH. LARGE NAPPY. SMALL NAPPY.

Do not use either the old-style pigeon nest pan or open water dish.

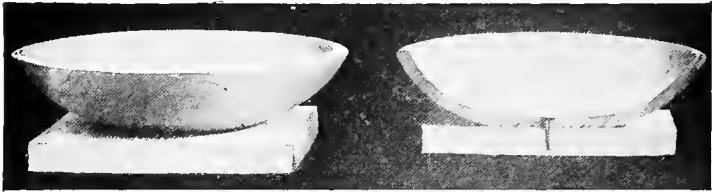

THE WOOD-FIBRE NEST BOWL.

This is made in one size (nine inches diameter of bowl). To give stability, the bowl may be fastened to a base by one screw. The first picture shows the perspective view; the second picture shows one-half cut away. This is the most practical nest pan for squab raising and is having an enormous sale. The bowl may be screwed directly to the bottom of the nest box. (See page 48.)



BATH PAN AND DRINKER.



HAND BASKET.

One bath pan to every twelve pairs of birds is necessary. The hand basket (price \$3.50) is used in large plants to carry the squabs from the nests to the killing place. The squabs should not be killed in sight of the parent birds.

these bowls out of wood fibre. Their success was quickly demonstrated and now we sell nothing else. These wood-fibre nest bowls have all the advantages of the wood bowls and at the same time are practically indestructible, cannot warp or split. The wood fibre of which they are made is thick and exceedingly tough, being solidified under many tons' pressure. After making they are treated with an odorless, anti-moisture compound and then baked to flint-like hardness. We sell these wood fibre nest bowls in one size only, nine inches in diameter. Price, eight cents each, ninety-six cents per dozen, eleven dollars and fifty-two cents per gross. We make prompt shipment from Boston same day order is received, in any quantity. No order is filled for less than one dozen. We have the exclusive manufacture and sale of these goods and they cannot be obtained elsewhere.

The advantages of this nest pan are these: (1) The eggs roll to the centre and are always close together under the birds. (2) It is warmer than earthenware and eggs are not chilled. (3) It is cleaned without water by means of a trowel, and may then be whitewashed, if desired. (4) The claws of the old birds and squabs do not sprawl, and no cases of deformed legs in the squabs are found. (5) It is unbreakable. (6) When shipped either short or long distances, no packing is necessary, they are lighter and the freight bill is smaller. (7) And finally the birds "take" to them more readily than to earthenware, getting to work more quickly and producing more squabs.

We make this wood fibre nest bowl in only one size as specified and illustrated (two sizes are not necessary because the feet of the squabs do not sprawl as in the case of the earthenware nappies). You will need one pair of nest bowls for every pair of pigeons (in other words, one nest bowl to every pigeon). If you order twenty-four pairs of breeders you will need forty-eight nest bowls. If you order ninety-six pairs of breeders you will need one hundred and ninety-two nest bowls.

We know our birds will breed more successfully in these nest bowls than in earthenware, and to make it an object for you to buy them, you may deduct the freight charges on nest bowls from your order for birds. First order your nest bowls sent by freight, then when you order your breeders.

send us your freight receipt and count the amount as cash. Or you may order your birds at the same time you do the nest bowls (and other supplies) and when you get your freight receipt send it to us. Orders for one dozen to four dozen bowls should go by express with the birds (tied to the basket), unless it is desired to have the bowls go with grain, grit, shells, etc., by freight.

Place one nest bowl in each one of your nest boxes. Let the pairs choose to suit themselves. At the end of the month, when you take out the squabs, take out the nest bowl, clean it and put it back.

Many customers who do not use egg crates or orange boxes, but build their nest boxes of half-inch or five-eighths lumber, have written us that they used the construction which we illustrate on page 30, and which is good, because cleaning can be better done. The bottoms of the nest boxes are removable and rest on cleats, as the picture shows. The cleats are seven-eighths or one inch square and are nailed to the uprights. When this construction is employed, it is not necessary that you have a block or base screwed to our wood-fibre nest bowl. The nest bowl may be screwed directly onto this removable bottom. If you use egg crates or solid-built nest boxes, you will have to give the wood-fibre nest bowl stability by screwing it to a base of wood seven inches square and about three-quarters of an inch thick.

When the squab house is ready for the birds, each of the nest boxes has one of these nest bowls. The pigeons build their own nests in them, taking the nesting material and flying to the nest bowl with it. The average nest has from one to two inches of straw compactly and prettily laid by the birds. Some birds use more nesting material than others. After the squabs are hatched, they quickly show that Nature never intended them to have a dirty nest. When they wish to make manure, they back up to the edge of the nest and "shoot" outward and over the edge of the nest bowl into the nest box, which is just where the breeder wants to find it. In a week or two there will be a circle of solid manure in the nest box, but it is out of the nest, and off and away from the feet of the squabs. As the squabs grow older, their claws tread and throw out the straw on which they were hatched, and the nest bowl gets bare again as it was in the first place. The small

amount of manure which then sticks to it is removed with a trowel.

The use of this wood-fibre nest bowl has lightened the work a great deal for they never have to be washed. They should not be washed, for water weakens them, particularly at the bottom, where the screw hole is. A washer should be put under the screw head to hold the bowl tight and to prevent its turning while being cleaned. We ship these washers and screws with the bowls.

The pigeons will not take with mathematical regularity pair by pair the nest boxes which you have provided. Some of them will take them in pairs, one adjoining the other. This makes it convenient for you in keeping track of them. Others will take one nest box in one part of the squab house but go to another part of the squab house for their second nest. Some will not take a nest box at all, but will build a rough nest on the floor of the squab house and rear their family there. Let them choose for themselves.

The nests are built by the birds of straw, grass, hay or pine needles. The birds fly to the pile, select what wisps they want, then fly to the nest boxes and arrange the wisps in a nest bowl to suit themselves. Tobacco stems are recommended for nesting material, because the odor from them will have a tendency to drive away lice, but they are not necessary if the nest bowls are used and ordinary cleanliness observed. The tanners do not want manure mixed with tobacco stems which have dropped down from the nests. The stems, when wet in the vat, stain the hides. When tobacco stems are used for nesting material, it is impossible to prevent many of them from dropping to the floor, where they are tramped by the birds into the manure. The tanners do not care if some straw and hay are in the manure. Before cleaning out the squab house, the loose straw and feathers should be swept out with a broom.

The best thing to keep the nesting material in is a berry crate. Fill it with straw and hay (use the fine oat, not rye straw, cut into six-inch lengths) and shut down the cover. Then when the birds want nesting material they will fly to the vertical openings in the sides of the berry crates, stick their bills in and make their selection. The cover of the berry crate prevents the birds from soiling the nesting material.

They will not build nests with dirty nesting material. It must be first-class, clean, dry and sweet or they will not use it.

Some of our customers use pine needles successfully for nesting material. We have never tried them because they are not plentiful around our farm. Where they are in abundance, we recommend that they be tried.

When a new lot of pigeons are placed in a squab house, they will cause annoyance, while they are learning their new home and getting ready to go to work, by making manure in the nest bowls, where they roost. This cannot be prevented. The remedy is, to clean once a week.

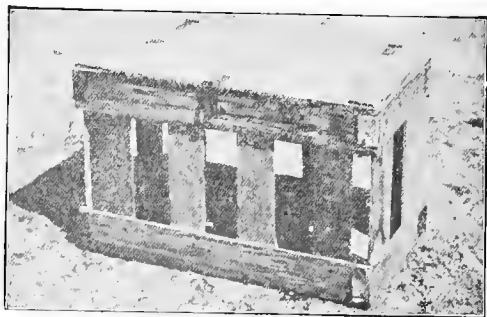

Fill this berry crate with nesting material (straw cut into six-inch lengths, and hay, mixed about equally) and place it in centre of squab house. The cover prevents the birds from fouling the nesting material. They stick their bills through the slats, select the wisps they want, and fly to nests.

CHAPTER V.

WATER AND FEED.

Necessity of Pure Water and Plenty of it—The Kind of Drinking Dish to Use and the Kind Not to Use—Management of the Drinking Fountain and Bath Pan—The Feed Trough and Self-Feeder—Feeding Habits—What Grains to Use—How to Mix Red Wheat and Cracked Corn—Use of Grit, Oyster Shell and Salt—How to Feed the Dainties—Keep Feed before Your Flock All the Time.

Pure water and plenty of it is good for pigeons. When the weather is not too cold, it is the custom of pigeons to get into water, wherever it is. When they cannot bathe in it, they will stick their dirty feet into it. When they cannot get in their feet, they will douse their heads. They are after water all the time. When feeding the squabs, the old bird will fill up its crop with grain, then fly to the water and take a drink, then return and dole out to the squabs the watery and milky mixture on which they fatten.

The source of drinking water should be separate from the bath pan. They will drink from the bath pan, to be sure, while the water remains comparatively clean, but after a few have bathed in it, it is unfit for any bird to drink, and inside of twenty minutes the pan is not only covered with a whitish, greasy scum, but is dyed greenish from the manure which has washed off their feet.

There should be drinking water inside the squab house, provided you have not a running stream or some such clean water device in the flying pen.

The kind of water dish you do not want in the squab house is the kind with the open top, into which the birds can wade, and which they can foul with their droppings. The best device we have found is the self-feeding fountain, such as we illustrate on page 46. This fountain is made either of crockery or galvanized steel, or iron. Galvanized iron or steel is better than crockery, because if water freezes in such a dish the dish will not be cracked. It will be seen by examination of the self-drinker that it is impossible for the pigeons to foul

the water. The reservoir holds quite a supply of water, which feeds down as fast as it is drunk by the pigeons. We have seen beginners puzzled by these self-drinking dishes; they cannot imagine why the water does not all run out at once by the bottom hole. It is a simple principle in hydraulics which you may demonstrate to your own satisfaction by filling an ordinary tumbler with water and then inverting it in a saucer of water. There is no way for the air to get to the inside of the tumbler except by passing under the rim at the points where it touches the saucer, consequently it does not flow down unless the water is removed from the saucer, and then it ceases as soon as the water in the saucer rises over the rim of the tumbler again. In fact, some self-drinkers for poultry are made of two pieces of pottery exactly on the principle of the tumbler and saucer. These fountains are not so practical as the fountain which we illustrate, because a pigeon can roost on the top of it and foul the saucer with its droppings. In the fountain which we picture it is impossible for droppings to reach the mouth containing the water, even if the pigeon is perched directly on top of the fountain. The barrel shape of the fountain makes it hard for more than one pigeon to perch at the same time on its top, but one pigeon usually is found there. He gets there, for the special purpose, it seems, of fouling the water, but the fountain beats him and he can't do it. Neither can he put his feet into the water unless he is an extraordinary gymnast capable of holding his body out at an angle to the perpendicular. The result is, that in actual practice the water keeps clean, and there is a supply of it ready about all the time. A fountain of a gallon capacity will keep two or three dozen pairs of breeders supplied all day. The fountain is filled by turning it on end and pouring water down into the opening. If you fill the fountain at the same time you fill the bath pan in the morning, you will have done your duty by the pigeons for the day.

✓ Cleanse these fountains at least once every two weeks with scalding hot water containing squab-fe-nol (pigeon disinfectant; see our price-list for description).

The best place for the bath pan is out in the yard of the flying pen. A pan fifteen inches in diameter is right for a flock up to twelve pairs of birds. The pan should be from four to six inches deep, not over six inches, for a pigeon will

not bathe in water where it would be likely to drown if pushed or sat on by its mates. Having the bath pan in position on the ground of the flying pen, you take to it once each day, in the morning, a bucket of water, and pour the water into the pan. Then you can go away to business, if you wish. The pigeons will fly to the pan from the interior of the house, or from the roof, wherever they happen to be. Some will splash right in. Others will perch on the rim and drink before they bathe. When the water gets dirty, they know enough not to drink, unless they are very sorely pressed indeed for water. The water gets quite dirty from the bathing. A thick, greasy, white scum forms. The pigeons do not rustle in the dirt, as a hen does, but rely on the water to keep them clean and dainty. They flap their wings in the water and enjoy it thoroughly. A pigeon will never run away from water, as you will discover if when you are watering your lawn you turn the hose on them.

Let the dirty water stand in the bath pan all day if you choose, or you may go to it an hour or two after you have filled the pan, and empty the water. One bath a day is enough.

If there is a stream of water running through your property handy to your squab house, build your flying pen out over it and you need never trouble with bath pans or drinking water. If it is a deep stream, you will have to contrive a shallow bath tub at the shore, or divert part of the stream into a shallow run. The squab raiser with a stream of water handy should by all means make use of it and save himself the work of carrying water in pails.

The bath pan may rest in a basin, if you choose, and the overflow caused by the splashing of the wings may be conducted to a sewer and drained away. You may conduct water in pipes and have a faucet opening out over the bath pan, which faucet you may control either directly or from a central station. An easy home-made arrangement to be used in conjunction with the bath pan consists of a wet-sink in which the bath pan sits, and out of which the splashed water runs. In the winter it may be advisable to give your pigeons their bath in the squab house instead of in the yard of the flying pen, in which case you should have some device on the wet-sink principle to prevent the floor of the squab house from getting damp.

In northern latitudes it is not necessary nor desirable for the pigeons to bathe on cold winter days. Wait until a warm and sunny day comes. It will do the birds no harm to go for weeks in the winter without bathing. Many of our customers write us that they allow their birds to bathe in the winter seldom or not at all.

Feed may be given to pigeons in a less guarded way, for they do not soil the feed dish so freely as they do the drinking dishes. You may put the feed in open troughs (or on a flat board with a rim around it) in the squab house. If you observe them when eating, you will notice that they stand up to the feed in a somewhat orderly manner and peck at its contents. They do not sit in the dish and roll around in the feed as they do in the water. But they have one fault when eating and that is, to scatter the grains. They will push in their bills and toss them around in a search after tidbits, and scatter out on the floor kernel after kernel, and it will make your bump of economy ache to see this grain scattered around. There do not seem to be any neat, saving pigeons which go to the floor in the wake of their prodigal brethren and eat the crumbs. They all have a fancy for the first table and they get right at it and scatter the grain like the rest of their fellows, and apparently the pigeon who scatters the most grain is the one which struts around with the biggest front. The way to fool them is to provide in the squab house a covered trough, that is, covered except at the slit or points where they stick in their bills for food. With a little ingenuity you can cover an ordinary v-shaped trough so that it will be hard for the pigeons to waste the grain. You may have a self-feeder made as big or as small as you choose and in which the grain will drop down as it is eaten.

We will try to present the matter of feed as clearly and fully as it seems to us to be possible. A woman in Santa Cruz, California, said she would like to raise squabs, and would begin by ordering her feed of us, exactly as we recommended, to be sent to her by freight from Boston via the Southern Pacific. A man in Cleveland ordered a quantity of red wheat and cracked corn to be sent by freight from us, when there were thousands of bushels of both staples in elevators in his city, in fact most of the Boston supply had passed through his city. We did not like to run the chance of

losing the order for breeding stock either of the woman in Santa Cruz or of the gentleman in Cleveland, but we wrote to both that they ought not to go into the squab-raising business if they were to be dependent on us for grain, that it was too far to send and that if they would look around home they could get what they wanted.

Here in New England we feed to pigeons cracked corn, red wheat, hemp-seed, Canada peas, kaffir corn, — the foregoing as a rule, and sometimes, when cheap, buckwheat, millet and barley.

It was formerly thought that whole corn was not a good food for pigeons, on the theory that the old pigeons would eat the large kernels and then, perhaps, feed them to squabs, choking them. In practice, not one case in one hundred like that will be found. Whole corn is much relished by pigeons. They will eat it before they will eat anything else, except hempseed, and there is no danger in using it. In many sections of the country, we find, good cracked corn is not so easy to procure as good whole corn. The grain dealers take their poor whole corn, sometimes, and work it over into cracked corn. Good whole corn speaks for itself and when you buy it there is no doubt about it.

All the time people write to us and say they never heard of red wheat. More write and say they don't know what kaffir corn is. Others are puzzled by hemp-seed, they have never seen any. That is surprising to us here in New England, but no doubt we would be just as surprised if we were in our customers' places.

Let us see if we cannot level up the whole country on this question of feed for pigeons. As a rule, we say, feed the grains which are nearest you. This country has its corn belt, its wheat belt, its section where millet is raised. Buckwheat is plentiful in another section. For your leading grain, your staple, feed corn. The point to remember is to feed a variety of grains. Keep this word variety in your mind all the time in dealing with your pigeons. Their appetites do not grow keen on a monotonous diet, they will not lay the eggs they should, and their health will not be good on it. Vary the diet.

In order to find out what grains are convenient to you, go to your nearest grain dealer or country general store. The

dealer in nine cases out of ten knows nothing about pigeons and their feed and if you give him the name of a strange grain, he will be liable to shy and say he never heard of it. The trouble with him is that he sells horse feed and is accustomed to handling only the grains which horses need. He can get the grains you wish by writing to his nearest port or railroad junction. There is nothing odd or out of the way about the grains. They are going from one point to another all the time. Sometimes they are scarce at certain periods of the year. For instance, nearly every fall there is no kaffir corn at a reasonable price obtainable in Boston, so we do not feed it to our pigeons then, but cut it out altogether in favor of the grains selling at a lower price. Most of the kaffir corn which we get in Boston comes from Kansas. It is a splendid feed for pigeons. It is small and comparatively soft, and their crops make easy work of it. It is nourishing and they like it. Maybe your grain man sells a mixture for pigeons. If you will look in this mixture you will find probably kaffir corn, as well as buckwheat (in black kernels), also red wheat and Canada peas.

A liberal supply of Canada peas and hemp-seed is necessary for a good egg production.

Do not feed a great excess of corn, in the summer time. (By corn, we mean common Indian corn, not kaffir corn. Kaffir corn is harmless, even when forced on the birds.) The effect of corn is to heat the blood. This is what you want in the winter time, but not in the summer.

Red wheat is better than white wheat to feed to pigeons because it is not so likely to cause diarrhœa. (See supplement of this book.)

Beware of feeding too much wheat. Pigeons fed on an excess of wheat are constantly out of condition with continual diarrhœa and will lay no eggs while in that state. We recall vividly cases of pigeons doing poorly caused by the owner's stupidity in feeding too much wheat. One customer in Kansas fed nothing but wheat and got his birds so weak that they could not fly off the ground. Another in California with a flock of over one hundred pairs had not been able in six months' time to get more than one quarter of his birds at work. He complained bitterly that his birds were "not mated," were all cocks, and so on, but after further correspondence

disclosed that he was feeding nothing but wheat, with the exception of a handful of peas in the middle of the week and a handful of hemp-seed on Sunday!

A properly balanced ration is necessary to egg production in the case of pigeons, same as poultry.

Wheat is a good regulator for pigeons but corn is the great fattener and the main staple.

When anybody fails with pigeons, if you pick up and handle the birds you will find in nine cases out of ten that they have sharp breastbones, which means that they are improperly nourished, out of condition, and of course cannot produce eggs because they have not the blood and fat to do it.

All the grains which you feed should be old, hard, dry and sweet. If they smell sour or taste bad to your own tongue, don't feed them to your pigeons. Above all, keep your grain dry. If you have the grain stored in bins which are damp from ground water, or which catch the drippings from the eaves, or through holes in the roof, first you will get sour grain and then some of the grain will sprout, and this sprouted grain will derange the bowels of your birds and bring on dysentery. Do not let rank little growths spring up in a dirty squab house or in the yard of your flying pen. Pigeons will peck at green leaves and grass and will not be harmed, but do not give them a chance to peck up sprouted grain and eat the sprout, grain and all, for if they do they will have diarrhœa. A pigeon in good condition and busy with a nest ordinarily will not touch a nasty little green sprout, but in the moulting season, when pigeons are in the dumps generally, and feeling like having a stimulant, they will experiment with these sprouts. Keep the floor of your squab house clean and the yard of the flying pen raked up and you need not worry about this matter.

Ground oyster shell should be placed in a box handy for the pigeons to get at. The purpose of this oyster shell is to provide the constituents of the eggshell. The female pigeon needs it in order to form the egg.

Grit is needed by the pigeons to enable them to reduce to powder the feed which they take into their crops. The muscles of the crop work the grit on the grains and reduce the grains so that they mix with the digestive fluids. Cart two or three bushels of gravel or sharp sand into your flying pen and cover the ground with it. It is not necessary to

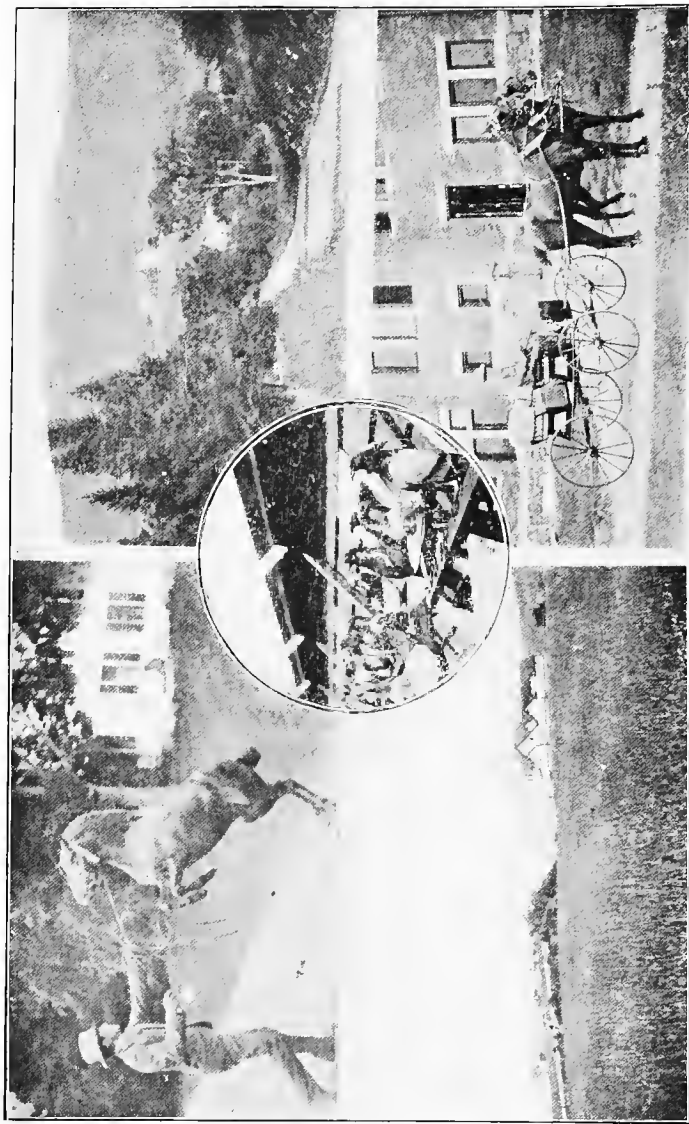

SCENES ON THE \$200,000 FARM OF ONE OF OUR CUSTOMERS.

We make a specialty of fitting up country estates with squab plants. There is more beauty and pleasure in pigeons than anything on the farm especially for women and children.

cover the whole space of the ground of the flying pen. For fuller discussion of shells and grit, see supplement.

It is poor policy to mix anything but wheat and corn together. If you make a mixture of peas and hemp-seed with cracked corn and wheat, you will find that the pigeons will dig down after the peas and hemp-seed and toss the other grain around and waste it. The only mixture, therefore, which we feed is a mixture of wheat and corn. Fill the self-feeder with whole corn and wheat, in the proportion of three parts of the corn to one of wheat.

We call the wheat and corn staples, because with us in New England they form the major part of the diet, and are the cheapest. The hemp-seed, buckwheat, Canada peas, kaffir corn, millet and barley we call dainties. We do not feed much millet, because we have the other grains, which are cheapest, but some of our customers in the millet sections of the country feed a good deal of millet. In such cases they look on millet as one of their staples, and the hard-to-get grains are classed by them as dainties. The staple grains of which you will feed the most to your pigeons are the ones which are the cheapest for you. The more expensive grains will be classed by you as dainties.

A good way to feed the dainties is to throw them out on the floor of the squab house by hand. You will see the pigeons make a rush for them and eat them with as much relish as a child eats candy. You should feed the dainties about three times a week, throwing handfuls on the floor until you see that the pigeons are satisfied and do not care for any more.

Do not throw any feed on the ground of the flying pen, for the earth is liable to be damp, and this dampness will sour the grain, especially cracked corn, and if the pigeons eat it, they will get sour crops, and the fluids from the sour crops of the parent pigeons will make the squabs sick and perhaps kill them. Do all your feeding in the squab house and your pigeons will not have sour crops.

Do not lay in a big stock of cracked corn at a time, for cracked corn exposed to sudden changes of the weather is liable to take up dampness, and sour. Smell and taste it once a week or so and determine to your own satisfaction that it is not sour.

Some squab breeders feed twice a day, as much as the birds will eat up clean, but we do not believe in that system of feeding. Our own success, and the success of our customers in squab raising, is based largely on the fact that we insist on a continuous supply of food for the pigeons, when they are breeding. Use the self-feeder only with birds that are producing squabs. A new flock should be fed by hand twice daily what they will eat up clean in ten minutes. Keep them eager, active and racy. Do not let them get too fat, for if you do they will not start laying. Some beginners will use up weeks trying to get their birds started, others get all their pairs going in a few days. It is a matter of skillful feeding, exactly as in the case of hens. The best of mated pairs will not produce eggs unless nourished, because the act of copulation, as in the case of hens and roosters, has nothing to do with the volume of egg production, but only with the fertility of eggs.

Food should be at hand in the self-feeder for birds which are breeding. They do not gorge, as a horse will if an unlimited supply of food is set before him. They are not gluttons, like pigs. They do not lose their racy shape. A squab when hungry will squeak loudly to inform its parents of that fact and if you observe a squab house where the two meals a day are in vogue, you will note quite a chorus of squeaks. In a house where there is feed always at hand, you will not hear many hungry squeaks. It is greatly to your interest that the crops of your young birds be filled with food. The more their crops are stuffed with food, the quicker they will fatten and the fatter they will get. The parent birds should at all times be able to fill up their crops with feed and water and then fly to the nest to disgorge for the benefit of the squabs.

Squab breeders differ concerning self-feeders, same as mothers differ about ways of bringing up babies. Each squab breeder thinks his method of feeding is the best. We speak not wholly from our own experience, but the experiences of thousands of customers extending over many years. There was formerly the same prejudice against self-feeders for poultry, until a man in Ohio, raising poultry with striking success by the aid of self-feeders, made his brethren sit up and take notice. In our stories of success printed at the back of

this book and elsewhere, are many cases of small flocks increased enormously, and the writers take pains to state that they are using the self-feeder. That is talk that means something. The loudest advocate of no self-feeder is the man who is trying hard to sell his Homers by some kind of a story different from what we tell. It does not matter to him what he says, so long as he combats us. It is the game of such chaps to contradict all others and pose as the only real, simon-pure know-it-all on pigeons.

Some small parent Homers are such good feeders, such good fathers and mothers, that they stuff their squabs with grain and bring them up to a surprising fatness. We have had pairs of squabs which actually at four weeks of age were bigger than their parents. This is not surprising when you think that the squabs sit in their nest hour after hour doing nothing but accumulate fat, and taking no exercise to train off this fat. The old birds are flying around and do not have much fat on them; they are trim and muscular, and hard fleshed. You can tell an old pigeon after it is cooked when you put your teeth into it, just as you can tell an old fowl.

Provide salt for your pigeons to keep them strong and healthy. The safest kind of salt for you to use is rock salt, such as is sold for horses. Put a couple of big lumps of it in the squab house and let the pigeons peck at it when they wish. Put two more lumps out in the flying pen. When rain comes the water will wash some salt off the lumps into the gravel. (Empty the bath pans upon the lumps of salt.) The pigeons will eat this salt-impregnated gravel all around the lumps for an inch or so down into the ground.

Do not feed powdered salt, for if you do the birds may eat too much of it and it will kill them. Coarse ground salt may be used, but the rock salt is best.

Some green stuff is much relished by pigeons. It is good for them and will increase the egg, and, consequently, squab production. They are very fond of cabbage now and then, which should be chopped fine before being fed. (We mean raw, not cooked, cabbage.) When vines grow over the flying pen, they will be seen pecking at the green leaves. Green clover may be cut up and fed to them in conjunction with grain. It should be remembered that green stuff, as enumerated in this paragraph, is fed only as a relish.

Table scraps, or what is commonly known as swill, should not be fed to pigeons.

Rice may be fed, if plentiful and cheap. It has a tendency to correct diarrhoea caused by too much wheat.

Some of our customers have been influenced by adverse criticism of our self-feeder to abandon it and feed in open troughs, but they have gone back to the self-feeder. One of these customers was Mr. Tyson, who started with several hundred pairs of our birds three years ago and now (1907) has the largest and best plant in the State of New Hampshire. His wife and son, with himself, have attained a high degree of skill and proficiency in the handling of their pigeons. The squabs they are breeding weigh at least nine pounds to the dozen. They ship to New York City, where they get very high prices. Mr. Tyson started by using the self-feeder for grain, as we advise, but being influenced by something seen in print, abandoned it and gave the open-trough method of feeding, twice or three times a day, a thorough trial. Immediately the birds began to fall off in production, and the squabs fell off in weight, some lots getting so skinny as to lose nearly two pounds to the dozen. That experience was enough. The Tysons went back to the self-feeder and now their squabs are plump, as they were in the first place, the old birds are in better condition, and breeding better.

Do not put into the self-feeder a great lot of grain, but only enough to last about two days. A great quantity is liable to take up moisture in a spell of rainy weather and go stale, and is not relished by the birds as if it were supplied fresh every two or three days.

CHAPTER VI.

LAYING AND HATCHING.

Laying an Egg is under the Control of the Pigeon's Mind—Fertile and Infertile Eggs—How the Cock Drives the Hen—One Day between Eggs—Hatch after Seventeen Days—How Squabs are Fed by the Paren' Birds—Mating Males and Females—Use of the Mating Coop—Determination of Sex—Color of Feathers Has No Effect on Color of Flesh—Pigeons Left to Themselves Will Not Inbreed—No Inbreeding Necessary even if you Start with a Small Flock.

The hen pigeon builds the nest. When the nest is built, the cock begins to "drive" the hen around the house and pen. In a flock of breeding pigeons you always will see one or two cocks "driving" their mates, pecking at them and nagging them with the purpose of forcing them onto the nest to lay the eggs. The cock seems to take more interest in the coming family than the hen.

The hen lays one egg in the nest, then skips a day and lays the second egg on the third day. Seventeen days after being laid the eggs hatch. The egg first laid hatches a day before the second, sometimes, but usually the parents do not sit close on the first egg, but stand over it, and do not incubate it. Sometimes one squab may get more than its share of food, and the younger one will weaken and die. This seldom happens but if you see one squab considerably larger than the other, the thing to do is to exchange with a squab from another nest that is nearer the size of the remaining squab. The old birds will not notice the change but will continue feeding the foster squab.

The process of laying an egg is a mental operation. We mean by this that it is not a process which goes on regularly in spite of all conditions. The hen forms the egg in her body and lays it when she is in condition to, and when she wants to, not when she is forced to. In other words, the hen lays when conditions are satisfactory to her. That she forms the egg at will is proven by many things, principally by the fact that she allows one day to come in between the first and

THE QUICK GROWTH OF SQUABS FROM EGGS TO KILLING AGE
IN FOUR WEEKS IS ILLUSTRATED ON THIS PAGE,
PAGE 66 AND PAGE 68.

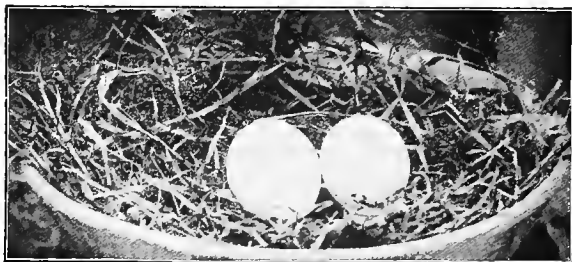

EGGS IN THE NEST.



SQUABS JUST HATCHED.

the second eggs. No doubt, after she has laid the first egg, she hurries the other along and lays it as soon after the first as she can, and it takes forty-eight hours for the egg, complete in its wonderful construction, to form. Hen pigeons in a shipping crate or close coop do not lay eggs, because they know that there are no facilities there for raising young. Once in a while you will find an egg in a shipping crate when the birds are taken out, but it is a comparatively rare occurrence.

Of course, in order to lay a fertile egg, the hen pigeon must have received the attention of the cock bird. It is common for a hen pigeon at five months, and sometimes four, to lay an egg, but as a rule those first eggs from a young hen are not fertile because she has not yet mated with the cock bird. You can tell by holding the egg up to the light after it is five or six days old. If no embryo shows, the egg may be destroyed. In starting a flock, always purchase the adult, mature breeders. We formerly repeated the statement from hearsay that the male pigeon may lose vitality when from six to ten years old, but this is not so, as we know now from experience that customers to whom we sold six to eight years ago are breeding at the same rate the same pigeons with which they started, and they were from one to two years old when sold.

From the day of its hatching to market time the squab is fed by its parents. The first food is a liquid secreted in the crop of both cock and hen, and called pigeons' milk. The parent pigeons open their bills and the squabs thrust their bills within to get sustenance. This supply of pigeons' milk lasts from five to six days. It gradually grows thicker and in a week is found to be mixed with corn and wheat in small particles. When about ten days old, the squabs are eating hard grain from the crops of the mature cock and hen. They fill up at the trough, then take a drink of water and fly to the nest to minister to the little ones. You see how important it is to have food available at all times.

In fourteen, fifteen or sixteen days after the first pair of squabs have been hatched, the cock begins "driving" the hen again. This shows the necessity of a second nest for the pair. In this second nest the hen lays two more eggs, and the care of the first pair of squabs, now between two and three weeks old, devolves upon the cock. When this pair is four



SQUABS ONE WEEK OLD.



SQUABS TWO WEEKS OLD.

weeks old, it is taken out of the nest and killed and both the mature birds are concerned then only with the new hatch. This sequence of eggs and hatches goes on all the time.

If there are not two nests, the two new eggs will be laid in the nest where are the growing squabs. The parents in their eagerness to sit on the new eggs will push the squabs out of the nest and they will die for lack of sustenance.

The hen lays the eggs about four o'clock in the afternoon. The cock and hen take turns at covering the eggs, the hen sitting during the night until about ten o'clock in the morning, when the cock relieves her, remaining on until the latter part of the afternoon.

When the squabs are taken out for market at the end of four weeks, the nest bowl and nest box should be cleaned. If this cleaning is done once a week, no trouble from parasites will result. In the summer it is well to add a little carbolic acid to the whitewash as an extra precaution. Sprinkle unslaked lime on the floor of the squab house and in the nest boxes, and spray squab-fe-nol freely.

One way of mating or pairing pigeons is to turn males and females in equal number into the same pen. They will seek their own mates and settle down to steady reproduction. Another method is to place the male and female which you wish to pair in a mating coop or hutch. In the course of a few days they will mate or pair and then you may turn them loose in the big pen with the others. The latter method is necessary when improving your flock by the addition of new blood, or when keeping a positive record of the ancestry of each pair. By studying your matings, you may improve the efficiency of your flock.

In the case of a new flock of pigeons shipped to a new home, all do not go to work at the same time. Those pairs which get to work first are bothered by the slower pairs. To judge from the advertisements of some breeders, anxious to claim everything for their birds and their wonderful matings, the beginner would think that all the birds he buys from them will go to work immediately when released in their new home. This is far from the truth. The pairs will go to work to suit themselves as to time. Some will be quick, others slow. As fast as each pair goes to work, it should be caught and placed in the breeding pen. The first pen, into which the birds



SQUABS THREE WEEKS OLD.

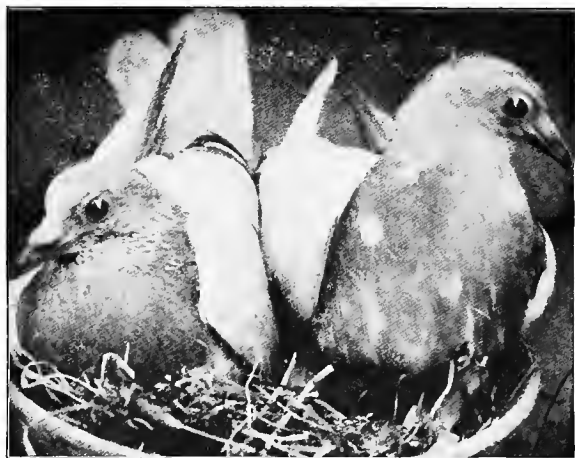

SQUABS FOUR WEEKS OLD.
Ready to be killed for Market.

were put on arrival, then can be used for the rearing pen for youngsters raised in the breeding pen.

In case a pigeon loses its mate by death or accident, the sex of the dead one must be ascertained. The live one should be removed from the pen and placed in the mating coop with a pigeon of the opposite sex.

The mating coop should have a partition of lattice work or wire. Place the cock in one side, the hen in the other, and leave them thus for two or three days to flirt and tease each other, then remove the central lattice work or wire and they usually will pair, or mate. If they show no disposition to pair but on the contrary fight, replace the partition and try them for two or three days longer. If they refuse to pair after two or three thorough trials, do not experiment any more with them, but select other mates.

The determination of the sex of pigeons is difficult. The bones at the vent of a female are as a rule wider apart than of a male. If you hold the beak of a pigeon in one hand and the feet in the other, stretching them out, the male bird usually will hug his tail close to its body—the female will throw her tail. The best way to determine the sex is to watch the birds. The male is more lively than the female, and does more cooing, and in flirting with her usually turns around several times, while the female seldom turns more than half way around. The male may be seen pecking at the female and driving her to nest. When one pigeon is seen chasing another inside and outside the squab house, the driven one is the female and the driver her mate.

Neither the squab breeder nor the flying-Homer breeder is much concerned about the color of feathers. There are blue checkers, red checkers, black checkers, silver, blue, brown, red, in fact about all the colors of the rainbow. Color has no relation to the ability of a pair to breed a large pair of squabs. We wish specially to emphasize the fact that the color of the feathers has no influence on the color of the skin of the squab. A white feathered bird does not mean a white-skinned squab. The feed affects the color of the meat a little. A corn-fed pigeon will be yellower than one fed on a mixture. Squabs with dark skins (almost black in some cases) are the product of blood matings. The trouble with a dark-colored squab is in the blood and the only remedy is to get rid of them



THE MATING COOP.

One way of mating squab breeders is to turn cocks and hens in equal numbers into the same pen. The mating coop is used when the breeder wishes to pair a certain male with a certain female. The above mating coop is divided by a partition. The cock is placed on one side of the partition, the hen on the other, as pictured. They are left thus for a day or two to tease each other. Then raise the partition, or take it out, and allow them to approach each other when they usually will be found to have formed an attachment. This being the case, they may be put into the large pen with the other birds, where they will find a nest box and go to house-keeping. If they fight when the partition is removed, try again, or try other mates. The coop pictured above is two feet long, one foot wide and one foot deep.

either by killing the parents or by remating. Usually the trouble comes from one parent bird, which you find by turning up the feathers and examining the skin. Having found the bird which is at fault, kill it. This point has come up continually in our correspondence. The erroneous belief that white-feathered birds produce the whitest-skinned squabs seems to be widespread and we are asked sometimes for a flock of breeders "all white." Our experience with all white Homers is that they are smaller and have less stamina than the colored ones. The marketmen will take two or three pairs of dark-skinned squabs in a bunch without comment, but an excess of dark ones will provoke a cut in price. Breeders who are shipping only the undressed squabs should pluck feathers now and then to see just what color of squabs they are getting. The dark-colored squabs are just as good eating as the light-colored ones, but buyers for the hotels and clubs, and those who visit the stalls, generally pick out the plump white-skinned squabs in preference to the plump dark-skinned ones. As a rule, squabs from Homer pigeons are white-skinned—the dark-colored squab is an exception.

Many beginners wish to know if it will be all right for them to buy a flock and keep it in one house for six months or a year, paying no attention to the mating or pairing of the young birds, but leaving that to themselves, so as to get without much trouble a large flock before the killing of the squabs for market begins. Certainly, you may do this, providing extra nest boxes from time to time until your squab house has been filled with nests; then you will have to provide overflow quarters. We are asked if the flock will not become weakened by inbreeding, that is, a brother bird mating up to a sister, by chance. According to the law of chances, such matings would take place not very often. Pigeons in a wild state, on the face of a cliff, or in an abandoned building, would pair by natural selection. The stronger bird gets the object of its affection, the weaker one is killed off or gets a weaker mate, whose young are shorter-lived, so the inevitable result is more strength and larger size. Nature works slowly, if surely. A lot of pigeons in one pen mating or pairing as they please when old enough is the natural way, and if you follow this, you cannot go very far wrong. We advocate matings by the breeder because it hurries Nature

along the path which makes most money for the breeder. We all know how Darwin studied natural and forced selection of pigeons. He took one pigeon with a certain peculiarity, say a full breast, and mated it to another pigeon with a full breast. The squabs from these birds, when grown, had breasts fuller than their parents. Then these in turn were mated to full-breasted pigeons from other parents, and the grandchildren had even larger breasts. Darwin's experiments covered a period of over twenty years and in this time he developed little faults and peculiarities to an amazing degree. Every intelligent, careful pigeon breeder is striving by his forced matings to push along the path of progress the peculiarity in pigeons which is his specialty. The breeder who selects most carefully and keeps at it the longest wins over the others. By selecting from your best and most prolific breeders the biggest and fattest squabs, keeping them for breeders and mating so as to get something larger and plumper, you are all the time getting bigger squabs. Every breeder of squabs has it in his power to increase the efficiency of his flock by studying his matings. There is commercial satisfaction in breeding for size and plumpness because it pays at once, and at the same time the breeder has the satisfaction of increasing the stamina and variety of pigeons.

To be master of the matings, the breeder should band his squabs. As soon as they are weaned (that is, as soon as the breeder sees them flying to the feed and eating it) they should be taken and put into one of the rearing pens. When about six months old, the breeder should begin mating them by selection, using the mating coop, then when they are mated turn the pair into a working pen with other adult birds. By looking at the number on the band of each bird, then on your record card, you know how to avoid mating up brother and sister.

When the young birds are just over four weeks old, or between four and six weeks, they are able to fly a little, and if they do not hop out of the nest (or are not pushed out by the parents) you may push them out yourself. They are now able to feed themselves. If these young birds are left in the squab house, they will bother the old birds by begging for food, and this infantile nagging will hinder the regular breeders in their next hatch, so the very best thing to do is

to put the young birds by themselves into a rearing pen, where they cannot bother anybody.

Of course there is likely to be a little inbreeding when you leave the birds to choose for themselves, but not much. If the breeder has not the time to make forced matings, then he may not care to make them. Remember in mating that like begets like. The parent bird that feeds its young the most, and most often, will raise the biggest squab. Sometimes a parent bird will have fine nursing abilities and will stuff its offspring with food. These good-feeding qualities are transmitted from one generation to another and are as much under the control of the breeder as size and flesh-color. Your biggest squabs will be found to have an extra-attentive father or mother, or both. A pigeon with a dark skin, if mated to a white-skinned bird will produce a mulatto-like squab. It is the large, fat, white-fleshed squab which you are after. Disregard the color of the feathers when mating. If when plucking your squabs you come across a "nigger," that is, a squab with a dark skin, find out what pair of breeders it came from and whether the cock or the hen is at fault, and get rid of the faulty one. It is important to start with adult birds that are not related, then you will not begin inbreeding. That is why we make a special effort with our adult birds to have them unrelated.

Some letters from customers make plain to us that a clear knowledge of what inbreeding means is not possessed by everybody. Several have written to this effect: "If I buy two or three dozen pairs from you to start, how can I increase the size of my flock without inbreeding?" When (1) a brother is mated to sister or (2) a father to a daughter, or (3) a mother to a son, or (4) a grandson to his grandmother, etc. that is inbreeding. We know it is forbidden by law for human beings to mate in that manner, because (a) God in the Scriptures has forbidden it, and (b) because the State does not wish to have to care for the puny, weak-minded offspring that would result from such unions. We all know that the marriages of cousins often result in demented, diseased children. Now suppose you buy two dozen pairs of pigeons of us, and number them pairs one to twenty-four. If you mate the offspring of pair two (or any other pair) to the offspring of pair one (or any other pair) that is outbreeding or cross-

breeding. What you do not do, and what you try to prevent, is the mating of the offspring of pair number one (or any other pair) to each other. So, you see, if you have a dozen or two pairs, you need never inbreed, for there is an infinite variety of matings possible. Breeders of animals sometimes inbreed purposely in order to get better color of fur or plumage, or finer bones, etc. There are no brothers and sisters in the flocks we sell. If you buy one dozen or twenty dozen pairs of breeders of us, the pairs will be unrelated, and you need never inbreed. We never heard a real pigeon breeder worry much about inbreeding, because the likelihood of it in a flock of even a dozen pairs is extremely remote, as we have demonstrated above.



PIGEONS IN ST. MARK'S SQUARE, VENICE.

Get acquainted with the pigeons which you buy of us, and let them get acquainted with you. They will work all the better for being tame and docile. These pigeons in Venice are fed by tourists on corn only. A peddler selling whole corn for two cents a package sits all day long on the steps at the base of the monument. Several photographers in the square make a specialty of taking pictures of tourists feeding the pigeons; snap shots by amateurs are constantly being made. In this city of canals, these pigeons get no grit, in fact nothing but the corn, and they would die if obliged to pick up a living for themselves. They are healthy, proving the incorrectness of the assertion that a feed of nothing but corn will cause canker. They are small, however, of stunted growth. They are so tame that they will perch on your hand and eat grains of corn held in your lips.

CHAPTER VII.

INCREASE OF FLOCK.

It is Possible to Breed One Pair of Squabs Each Month, but in Actual Practice this is Seldom Attained—The Squab Raiser with Pure Thoroughbred Homers should Count on Six to Nine Pairs of Squabs a Year—The Common Pigeon Breeds Only Four or Five Pairs of Squabs a Year, but Eats as Much or More than the Homer—Differences between the Homer and the Common Pigeon—Good Homers Scarce and the Market for them Firm and Steady.

It is theoretically possible for a pair of pigeons to breed twelve pairs of squabs a year, for it takes only seventeen days for the eggs to hatch, and the hen goes to laying again when the hatch is only two weeks old. So, if you start with twelve pairs of Homer pigeons, and they should breed one pair of squabs a month, at the end of the first month you would have twenty-four squabs; at the end of the second month, forty-eight squabs; at the end of the third month, seventy-two squabs; at the end of the fourth month, ninety-six squabs; at the end of the fifth month, one hundred and twenty squabs. Now the first lot of squabs which your birds hatched will be ready to mate and lay eggs, so at the end of the sixth month you should have one hundred and sixty-eight squabs; at the end of the seventh month, two hundred and forty squabs; at the end of the eighth month, three hundred and thirty-six squabs; at the end of the ninth month, four hundred and fifty-six squabs; at the end of the tenth month, six hundred squabs; at the end of the eleventh month, seven hundred and sixty-eight squabs, and at the end of the twelfth month, nine hundred and sixty squabs. Such figures are purely theoretical and are seldom attained in actual practice. You will have some pairs in your flock which will raise ten and eleven pairs of squabs a year, but the average will be seven to nine pairs of squabs a year. If you get less, your flock is not pure thoroughbred Homers, or your feeding and nesting arrangements are wrong. In our visit to squab breeders in 1902, we asked every one with whom

we talked how many pairs a year he was getting from his birds, and about all of them said seven to nine. This experience corresponds with ours. We remember particularly an old gentleman, Preacher Hubbell, in Vineland, who had been in the squab business for years but was just going out of it, having sold his place, pigeons and all, to a Swede farmer. He told us he had always made squabs pay him and that his birds, of which he kept a careful record, raised him nine pairs to the year right along.

It is a well-known fact that the common pigeon will breed only four or five pairs of squabs a year, and if handlers of big flocks of common pigeons, like Johnson of California, can make a net profit of one dollar per pair a year from such low breeders, we think anybody of no experience is justified in believing our statement that our Homers are capable of earning a net profit of from two to three dollars per pair a year, taking into account not only their fast breeding qualities, but the superior size of the squabs. Here in New England we consider the common pigeons inconstant and lappy-go-lucky breeders. They are not in the same class at all with the Homer pigeon.

The common pigeon, the pigeon which flies the streets of our cities and towns, is a mixture of all kinds of pigeons, and it partakes of the faults of each, and not of the virtues. Its outward appearance is large, but it is an effect of feathers and not of flesh. Its feathers are loose and fluffy and its muscles soft and flabby. Its head is smaller than that of a Homer, the deficiency being marked in the curve of the skull which covers the brain. The Homer has a white flesh ring around the eye, but the common pigeon has none. The Homer has the largest brain of any variety of pigeon, and discloses this fact by its behavior. It has more sense and behaves with more intelligence. Its wonderful homing instinct marks it above and beyond all classes of pigeons and it is this quality which gives it a commercial value all over the world. The feathers of the Homer are laid close like a woman's glove and the muscles under it feel as hard and firm as a piece of wood. Its breast is firm and well protected, with just the right amount of fullness. Its chest is large, indicating good lung power and staying qualities. Its wings are trim and shapely, in flight the poetry of motion. The poise of its body and head reminds one of a race-horse listening for the signal to speed over the

course. The lines from the neck to the body descend in a long, graceful sweep. Put a thoroughbred Homer into a flock of common pigeons and even a novice, if told to pick out the bird which would fly the fastest and furthest, would pick out the Homer. The Homer has a long bill (but not so long as the Dragoon pigeon). The bill of the common pigeon is short. Its bill is more hooked and is sharper pointed. Its head is shorter and more rounding on top.

The common pigeon is seldom bred in captivity, because it does not pay for the grain which it consumes. If bred in a wild state, it picks up a living in the neighborhood, the owner not keeping it wired in. It is the cheapest kind of a pigeon, and thousands of pairs are used by trap shooters. Undertakers sometimes buy the white common pigeons in order to liberate them at graves, to signify the ascent of the soul to heaven. Common pigeons will live anywhere, do not get attached to any home, but a Homer never forgets the place where it was bred and will search out its home in long flights. Common pigeons will alight on any building and will drink from different springs and wells, fouling them and making themselves a nuisance in a neighborhood. The Homer will alight only on its own squab house and drink only at its own home. Common pigeons sell for fifty cents a pair and are frequently offered as Homers. Do not start with common pigeons and think to learn the habits of squab breeders with them. If you cross a common with a Homer pigeon you will take away the good qualities of the Homer and add nothing. There is not one element in a common pigeon which if added to a Homer would improve the offspring. It is hard to convince some people that there is any difference in pigeons whose feathers are the same color. The result is they buy the cheapest they can get. After feeding them for a time and getting no profitable results, they are compelled to sell them to the first trap shooter who comes along, and they go among their townspeople declaring that the pigeon business is no good. Remember this point, that if you are going to buy grain and feed it to anything so as to get a profit, it is the best policy to feed it to that grade of animal which will show the largest profit. Very few people are satisfied with shoddy suits nowadays, even if they look almost as well as the all-wool garments. It is the wear which the customer is after.

Beware of shoddy pigeons. Buy the best Homers you can get, they will wear best and give you the most pride. Experienced poultrymen do not go here and there looking for fowls at cut prices. They buy breeding stock of a reliable breeder which is reliable and sold at a price which will enable the seller to deliver a high quality article. We can tell when an order for our breeding stock comes from an old poultryman, for they all write: "I want the best stock you can give me."

Good Homers do not glut the markets. They are always fairly scarce, and the price for them has always been well kept up. Beware of cheap Homers for sale at cut prices. There is always something the matter with such birds. They have been worked too long and are played out, or if a flock is offered "at a bargain," the birds do not produce the large, plump, No. 1 squab, but only culls. If a squab breeder is going to quit the business and offers you his flock of birds on the bargain counter, make him give a good reason to you for selling. If he has been unable to make the flock pay, you may be sure that you will be unable to make them pay. If he offers them to you without a good reason for selling, the chances are that it is a poor flock and he has got tired of buying grain for them, and wishes to saddle the burden upon you. We are always selling breeders and it is very much to our interest to protect our reputation by sending out only good Homers that will make money for their owners. This is what we do, and our large business has been built up by square dealing, and knowing the business thoroughly.

A pair of Homers capable of earning a pair of squabs in one month which will sell for at least fifty cents is worth more than one dollar or one dollar and twenty-five cents a pair. A pair of birds capable of earning only a ten-cent or twenty-cent pair of squabs once in two or three months is worth only fifty cents a pair. Jersey cows are worth more than common cows because they earn more. Good Homer pigeons, bred skilfully, are worth more than poor Homers because they earn more.

CHAPTER VIII.

KILLING AND COOLING.

Kill the Squabs in the Morning when their Crops are Empty — Not Necessary to Use a Knife, their Necks may be Tweaked — Drive the Animal Heat out of their Bodies by Hanging them from Nails — The Ideal Squab when Shipped has an Empty Crop, its Feet have been Washed Clean, and No Blood Shows — Sorting Squabs so as to Get the Highest Price from the Dealer.

The time to kill the squabs is in the morning, when the crops are empty. In killing them it is not necessary to use a knife. Hold each squab in the manner shown in the illustration and break the neck with a sudden pull and push. Do not pull too hard or you will sever the neck from the body. Some of our customers have hard work to get this knack of tweaking the necks and prefer to wring the necks, or to use a knife. To wring the neck, hold the squab by the head in the right hand and throw the body around in a complete circle, this act twisting and breaking the neck.

After the squabs are killed they must be cooled. In other words the animal heat must be driven out of their bodies. Provide a piece of board or studding eight or ten feet long and every four inches along this studding drive a couple of nine penny wire finish nails close together, but not so close that you cannot squeeze in the legs of the squabs. A finish wire nail has no large head like an ordinary wire nail. Suspend the studding from the ceiling by means of wire adjusted at both ends of the studding. This method of hanging it up is to prevent rats and cats from climbing up onto the studding, walking along it and eating the squabs. Place the feet of the squabs between the wire nails and let them hang downwards over night. In the morning the heat will be all out of their bodies and you can pack and ship them. If you are delivering plucked squabs to market, you do not need such an arrangement, but will throw the bodies into a tub of ice water (or cold spring water) after you have plucked them.

When plucking the feathers from the killed squabs, the



INCORRECT POSITION OF HANDS.

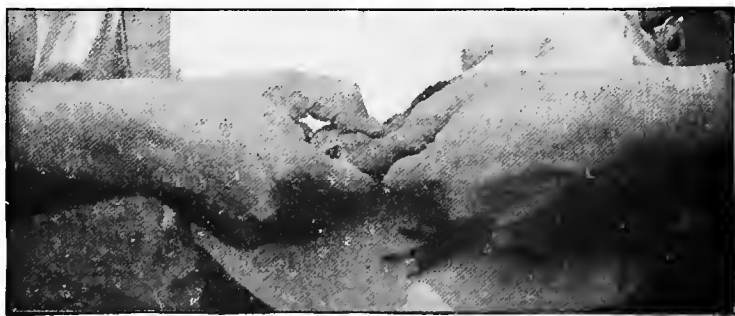

CORRECT POSITION OF HANDS.

A squab is killed for market when it is plump and well feathered, usually when four weeks old, although many are ready for market when a day or two over three weeks old. Hold the hands close together on the neck, as shown in the bottom picture and break the spine of the bird by pulling firmly and then pushing back. Do not put so much strength into the operation that you pull the head from the body. This method of killing is faster and neater than using a knife.

operator should moisten his thumb and forefinger in a basin of water, to give him a grip on the feathers. They come off easily and an experienced picker will work very rapidly. A sharp pen-knife, or knife such as shoemakers use, is necessary to remove some of the pin feathers. They should be shaved off.

Ignorance of how to cool the killed squabs properly has discouraged many a squab raiser. If you throw the squabs in a pile on the floor after you have tweaked their necks, you will have a fermenting mass and the following morning, when you are ready to ship, many of the bodies will be dark-colored at the place of contact with the floor, or with other squabs, and decay will start from such discolored places. Hang the bodies from the studding, as we have described, and you will cool them just right and you will be surprised that this part of the business ever could have discouraged anybody.

If you number the nails which you have driven into the studding you will know just how many squabs you hang up, and you will not have to handle the squabs a second time to count them.

The ideal squab which brings the highest price in the market is not only large and plump, but has a clean crop, so that no food will be left in it to sour. No blood shows anywhere on the body and its feet are clean. Ship in small quantities, especially in the summer. Do not pack in an enormous box, or the bottom layers will suffer.

A squab should be killed, as we have stated, when from three to four weeks old, most generally at four weeks. Do not wait until it is five or six weeks old, when it may have left the nest. As soon as a squab is old enough to get out of the nest and walk around on the floor of the squab house, it quickly trains off its fat and grows lean and slender. Its flesh also loses its pure white color and takes on a darker shade. You do not want either of these two conditions.

If you tie up your killed squabs by the feet when shipping to market, do not tie a lean with a fat squab, for if you do the dealer probably will give you the price of the lean one. Put the fat squabs in one bunch and the lean squabs in another bunch. If you are shipping to two dealers, you can very often get the top price from both by giving one your best squabs and the other your second best.



KILLED SQUABS HUNG TO COOL.

After the squabs have been killed they should be hung as this picture shows to cool. The wooden scantling or studding is several feet long and is suspended from the ceiling at its ends by wire, so that cats and rats cannot climb to the squabs. A pair of nails are driven in four inches apart and the squabs' legs set in between them

CHAPTER IX.

THE MARKETS.

Squabs with the Feathers on Taken by the Boston and Some Other City Markets—The New York Market Wants Them Plucked and Pays the Highest Price of Any Northern City—Interpretation of Quotations of Squabs as Seen in the Newspapers—White-Fleshed Squabs are Wanted, Not Dark-Fleshed.

The Boston market, and the markets in some other cities, will take squabs with feathers on. It is only necessary for you to tweak the necks of the squabs and send them to the train, after they have cooled over night. Some shippers do not take the trouble to box the killed squabs, but tie their legs together with string and send them along to market. In the baggage cars of the trains running into Boston you will sometimes see strings of squabs going in to the dealers in this way.

The New York market demands squabs plucked. The squab breeders who have large plants and who ship to the New York market employ pluckers and pay them by the piece. A skillful plucker will strip feathers from squabs at the rate of ten to twenty squabs an hour. The proper time to pluck the killed squab is immediately after killing. When picked clean, throw the squab into cold water and leave it there over night to plump out and harden the flesh. In the summer use ice water.

The squab puts on more feathers than flesh during the last few days of its growth and if you see squabs which are only three weeks old, but which are of good size, you may save a week on feed by killing the squab at that age and plucking it. When the feathers are off of it, it looks like the four weeks squabs which have not matured so rapidly.

If you are shipping to the New York market, you should pack your squabs in a neat white wood box, printed if you please. Do not use a pine box for if you do the odor of the pine will penetrate the squabs.

The New York market for squabs is the best in the North.

Squabs delivered by our customers there invariably bring from one to one dollar and fifty per dozen more than the Boston market. This is because there are more rich people in New York than there are in Boston, and they are more free with their money in providing luxuries for their table than Boston folks. We do not mean to disparage the Boston market for squabs, which is always good, averaging three dollars a dozen, but we wish to emphasize the fact that the New York market is a phenomenal one. Anybody living near New York can make a fortune raising squabs. Our largest orders have come from customers who are shipping to New York.

Not all the New York newspapers print market quotation of squabs. The *New York Evening Sun* is an exception. All through the winter squabs are quoted in the *Evening Sun* at five dollars a dozen. This means that a squab breeder shipping to New York should have got six dollars and seven dollars for a choice product, from private customers.

A correspondent in New York State sends a clipping from the *New York Tribune's* market columns and asks for an interpretation. We quote from it as follows:

"Pigeons, 20c.; squabs, prime, large, white, per doz., \$3.50 and \$3.75; ditto, mixed, \$2.75 and \$3; ditto, dark, \$1.75 and \$2."

The quotation, "Pigeons, 20 cents," means twenty cents a pair for common old killed pigeons. These tough old birds are occasionally found in the markets and are worth only ten or fifteen cents apiece. They are neither squabs nor the old Homer pigeons, but are common pigeons such as fly in the streets. A small boy might get a pair of these street pigeons and kill them and give them to a butcher who would pay him fifteen or twenty cents a pair. These cheap pigeons come into the eastern markets largely from the West in barrels and are sold to Boston commission men for five cents apiece, or fifty cents a dozen. They are retailed at from one dollar to one dollar and twenty cents a dozen. They are in the Chicago market masquerading as squabs. They have been killed with guns and have shot in their bodies. If you ask for pigeon pie at one of the cheap Boston restaurants, you will get a shot or two against your teeth with mouthfuls. After every trap-shooting contest some skulker goes over the

field and gathers up all the killed and maimed birds he can find, and sells them for two and three cents apiece, or for anything he can get, and these find their way into the markets. The cruel practice of pigeon shooting by mis-called "sportsmen" on Long Island is quite common, and the presence of these birds in the New York butcher shops accounts for the above quotation in the *Tribune*. It is unnecessary to add that such birds do not compete with squabs. They can be made palatable only by stewing for hours in a pie, which takes out a little of their toughness. There is now a law in New York forbidding pigeon shooting.

As to squabs, the quotation, "Prime, large, white, per dozen \$3.50 and \$3.75," is for the kind of squabs that are raised from our Homers, namely, No. 1 grade.

By the quotation, "Mixed, \$2.75 and \$3.00," is meant that these amounts are paid for lots of birds composed of No. 1 and No. 2 grades, mixed. If you sort up your birds carefully you will be able to get the No. 1 prices for all. Some people do not know how to sort them, and they have to be satisfied with the price of a mixed lot.

By the quotation, "Dark, \$1.75 and \$2.00," is meant the dark-fleshed squabs, as you have learned by reading our Manual. Squabs whose flesh is dark do not sell for as much as the white-fleshed squabs.

Pigeons are of all colors, *i. e.*, as you see their feathers, and the squabs likewise, but when you pluck the feathers off the flesh is either a pure white with a tinge of yellow, or dark like a negro's skin.

Quotations for squabs as found in the market reports in the newspapers are always lower than they really are. The writers of the market columns in the daily papers see only the commission men and cater only to them; they smoke the commission men's cigars and believe what the commission men tell them. They do not see the producer at all. The object of the commission men is to get the squabs as cheaply as they can. When you are breeding squabs make up your mind to get from twenty-five cents to one dollar or more per dozen than you see quoted in the market reports. The only way to find out the truth about the squab markets is to go into them and offer to buy squabs, not to sell them. Then you will learn the true prices.

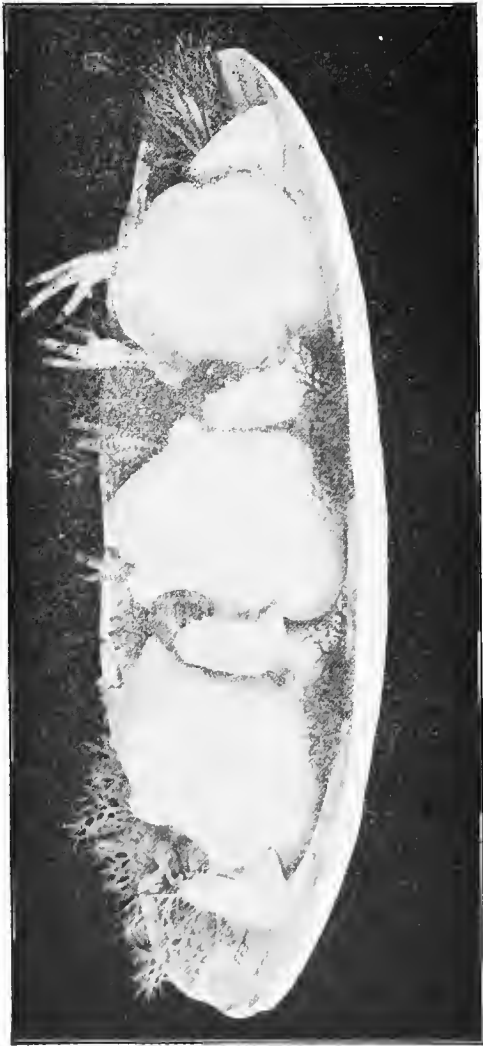

THREE DRESSED SQUABS.

This is a large turkey platter and the illustration gives a good idea of the remarkable size and plumpness of well-bred squabs at four weeks of age, with the feathers off. They are usually served broiled with roast and are most tender and delicious. The bones are very small. The squabs are nearly all meat.

At the same time the report quoted above was printed in the *New York Tribune* a breeder in Mauricetown, N. J., was getting from four dollars and twenty-five cents to four dollars and fifty cents a dozen for his squabs. (This was the last week in January, 1902.) You see, it does not pay to trust wholly to the market reports in the newspapers. The motive of the city men is to get their goods as cheaply as they can. It is your motive to get as much as you can, and don't be fooled by second-hand information. Go direct to headquarters yourself in person and learn the truth. If the middleman tries to hold down the price to you, go to a consumer and make your bargain with him at top prices.

A breeder in New Jersey writes that there are several squab breeders in his town, all of whom give their regular time to other businesses. He continues: "I am now (February, 1902), getting thirty-two cents each as they run, no sorting, for what few squabs I am now raising, and they are sold to a man who calls every Tuesday for them. When I have enough, I ship direct to New York by express. They sort them in New York."

This is doing extremely well for unsorted squabs. It is only another bit of evidence which proves the money-making condition of the New York market. (The above correspondent's breeders are not first-class, he admits, saying he has been breeding for seven years and his flock has run down.)

The Kansas City market does not yet know what a fat squab is. The only things obtainable there are the squabs of common pigeons, which are quoted low, as they are all over the country. A correspondent in Atchison writes: "I wrote to the Kansas City dealer again, telling him I thought his prices were pretty low for Homer squabs. He replied that they had so few Homers offered that they did not quote them, and they would be worth from two dollars to two dollars and fifty cents per dozen. He quoted common pigeon squabs at one dollar and twenty-five cents to one dollar and seventy-five per dozen, as I wrote you before. That is better, and I want to try raising them as soon as I can get into a place where I can handle them."

Fact is, the squabs that bring from three to five dollars a dozen east of the Mississippi will bring that (and more) as soon as the wealthy trade of Kansas City gets a taste of them.

Find out for yourself whether your market wants squabs with the feathers on or off. We do not know such details about the squab market in every city in the country and cannot advise you accurately on this point if you write to us from a distant town or city.

The best way to find out the facts concerning the squab market is to go from place to place, or to write, offering not to sell squabs but to buy them. The squab sellers are much more interested in a possible buyer than a possible seller. They receive letters from many inquirers about markets but as a rule pay scant attention to them unless the writer is really producing squabs and has them for sale.

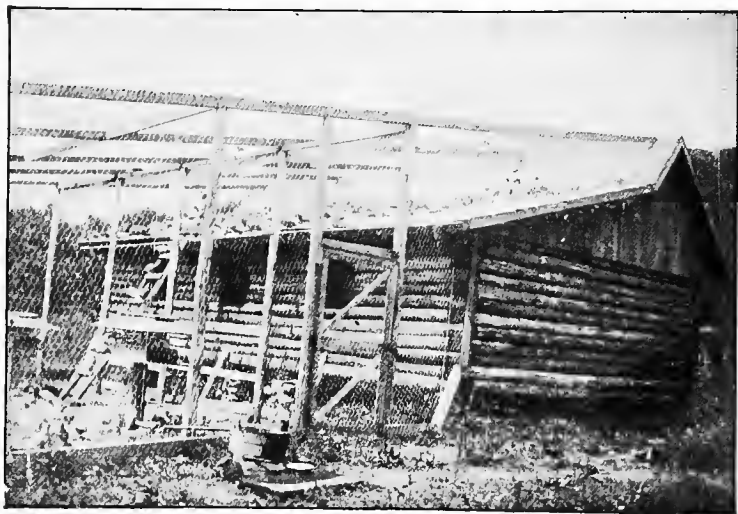

SQUAB HOUSE BUILT OF LOGS.

CHAPTER X.

PIGEONS' AILMENTS.

Canker a Filth Disease which Makes its Appearance in Nasty, Cramped and Crowded Quarters — It is a Captivity Disease and a Sure Cure for it is to Turn the Bird Loose to Get a Change of Food and Plenty of Exercise — A Flock Supplied with Pure Food and Clean Water Never will be Sick — Canker is Not Epidemic — It does Not Pay to Dose a Sick Pigeon, Better Turn it Out to Get Well.

The principal ailment met with by the squab breeder is canker. This ailment is a puzzle to some breeders and they are alarmed when it makes an appearance in their flock, as it does if the feed is poor or sour, the water dirty, or the squab house filthy. The advice which they give when they find a cankered bird is, "Kill it." That is the advice we used to give at first, but now we know better. First, what is canker? It is a disease of which you know the cause (filth, poor feed or dirty water) and whose symptoms you see in the form of a cheesy-like deposit in the mouth of the pigeon, and breaking out around the bill. Catch the pigeon, hold it in your lap and force open its bill and you will see a yellowish patch or patches in the mouth, and the mouth will usually be filled with a yellowish deposit which smells bad. The disease is not serious. The trouble lies with the feed and the filth and that is what spreads the same symptoms from one pigeon to another. A case of canker in your flock should be a warning to you that the feed or water is wrong, or that you have a filthy house. Do not get alarmed and kill the bird. Catch the affected pigeon, carry it out of your flying pen and squab house and throw it into the air. The bird may fly away and lose itself, and if it does you are out one pigeon just as if you had killed it. The chances are, however, as in the case of any sick animal, that it will linger around home. Now you will be surprised to see how quickly that pigeon's health will improve. Not having a steady supply of food before it, it will have to hustle for a living, and this exercise and the change of living, and the scanty living, will effect the

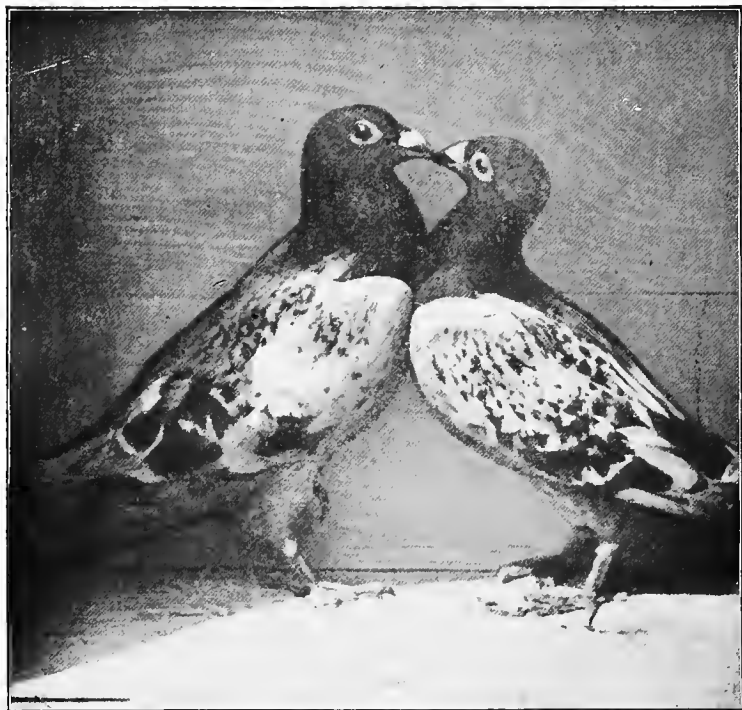

PAIR OF HOMERS BILLING.

This illustration is made from a photograph of a pair of our pigeons caught in the act of billing, or kissing. The pigeon on the left is the male and on the right the female. Billing is one of the acts of love making. Mounting and treading generally follow immediately after billing.

cure. It will get more fresh air, and a great deal more exercise, and more sun, than it would get if left in company with the other birds. In about a week you will notice that it will hold its bill tighter, and if there is a sore on the outside of the bill you will see this sore dry up. In two weeks the chances are that the yellowish deposit on the interior of the mouth will be entirely gone. The pigeon will hover around the other pigeons. It will fly to the outside of the netting and look at its fellows. Place a dish on the ground now and then with a little feed and you will attract it. Catch it when you have a favorable opportunity either with a net on the end of a pole, or with a broom, pinning it into a corner. You may have to try several times, but you will get it after a while. Its eye will be brighter and signs of disease will be gone, and you can put it back into the squab house with the others. The exercise, sunlight, change of food, and scanty food, have made the cure. There are few pigeons so bad with canker that they cannot be cured in this way. For that reason we have not much hesitation in saying that canker is a captivity disease, caused by lack of exercise as well as unavoidable filth and too much of the wrong kind of feed. We have observed wild pigeons in the streets and we never saw a case of canker among them. You may say to yourself that it is quite a risk to throw out into the open air a pigeon which has cost you from seventy-five cents to a dollar, but it is better to do this than to take the advice of all other breeders and books and kill it.

If you do not wish to throw a sick pigeon out into the air to get well, construct a box with wire netting over the front, and put the pigeon in there for special feeding and watering until it gets well.

Powdered alum sprinkled in the drinking water now and then will tend to ward off canker from a flock.

It does not pay to dose sick pigeons, because a cure seldom is obtained by dosing, and you are out your time.

The squab breeder who follows the advice as to feed and water, and cleanliness of squab house, given in this Manual, will not have any sick pigeons. It is so very easy to keep a pigeon in perfect health that the fear of disease is a bugbear not worth taking into account. The element of disease is a constant source of worry to the chicken breeder, and a source of heavy loss to the best of them. We wish to assure all who

contemplate starting in the squab breeding business that the pigeon naturally is a healthier and more rugged bird than the domestic hen and that positively you will not be fussing with remedies and cure-alls, in handling them.

“Going light,” or wasting away, is an ailment of pigeons occasionally met with. The cause of it is an absence of grit and salt. If your staples of feed are provided as we tell, and you give a variety of feed, and you provide grit and oyster shells, you will have no cases of “going light.” The disease is known by a steady wasting away of the pigeon. Catch it and you feel a prominent breastbone, and scanty flesh, showing that some element in the feed is lacking.

CHAPTER XI.

GETTING AHEAD.

Make your Birds Pay for themselves as they Go Along, unless you Wish to Wait Patiently until a Small Flock Increases to a Large One — Better to Take the Money Made from Sale of Squabs and Buy More Adult Birds than to Raise the Squabs, Because it is a Long Jump from Four Weeks (the Killing Age) to Six Months, at which Age the Birds Begin Breeding — Shipping Points.

It is the birds and not the buildings which count in squab raising and if you have fifty dollars to start, put thirty-five dollars or forty dollars into your birds and the balance into your building. We have had customers start with a hundred-dollar building and put a ten-dollar lot of birds into it, continuing to buy ten-dollar lots of us about once a month until they had their flock to a good size, but we believe it is best to let the buildings follow the birds, and not the birds the buildings. In other words, let your birds earn buildings as they go along. It is quite a drag on a small flock to weigh it down with an expensive building much too large for it.

Put this down in your mind solid, where you will not forget it: Make your pigeons pay for themselves as they go.

We sell to a great many poultrymen, and we like to get their orders, for they have been through the mill of raising feathered animals and are practical, and they are quick to see the money in squabs, and when their order for breeding stock comes along, it is in nine cases out of ten a large order, even if they have had no previous experience. They know that in order to sell squabs they have got to have birds enough to breed squabs and it is just as easy for them to spend fifty dollars or one hundred dollars at the start as it is for them to spend ten dollars or fifteen dollars and use up one hundred dollars' worth of time while waiting a year to begin selling squabs.

Many beginners are so skeptical that they do not believe squabs grow to market size in one month, or they have no confidence in their ability to feed the mature birds so as to keep them alive. They wish to make a start with a few pairs

and actually convince themselves. We do not believe in untried hands plunging into something of which they know nothing, and we commend the caution of the beginner with squabs who wishes to feel his way and "make haste slowly" as the saying is, nevertheless we know it to be a fact that our customers who started with large flocks are making splendid successes, and we are not so cautious as we were in former books in advising a small purchase, at the start. The rules for breeding we have given have stood the test of time; we have not had it said to us that they are misleading or erroneous; on the contrary, our customers write and tell us that their experience corresponds with ours, that the books are all right, and our business has increased right along. When a customer orders two hundred dollars' worth of breeding stock of us and two months later two hundred dollars' worth more (we sell to some customers month after month steadily, as their means or their inclination permit them to buy) we are given a large measure of confidence, first, that people (many of whom we never see and who are not experts) can start with our writings and our breeding stock and make a success; second, that all we have advised about the industry is of general and convincing application; and third, that it does not take extraordinary skill to make a success with squabs.

There are failures with squabs, even by college professors, because some beginners are unsuited to the business. Many are lured into it by get-rich-quick stories. It would amaze you to read the letters that some beginners write. You never can tell a man's pigeon and poultry ability by his orthography and grammar. Letters in crude spelling and crooked writing frequently come from the most successful squab raisers. The knack of caring for animals successfully cannot be acquired by some. Given two women, with cooking materials and the same cook books, one cooks splendidly, and the other miserably. Why? Well, it is the same with pigeons. Some can and some can't. However, the failures at squab or poultry raising seldom blame themselves.

There are many of the naturally careless, improvident persons who have turned to squabs to help them out of financial holes, and they have made a failure of squab raising. Many of us remember the furore over raising chicken broilers for market, which started a score of years ago. The fact that

some were making money at it started a burning hen fever in hundreds of young and old people anxious to make a lot of money quick. Clerks and society women from New York moved into the suburbs on small farms and began to try to make realities of their dreams. Not accustomed to manual labor, they made a sorry mess of it. Writers of that period tell of chicken gentlemen and ladies who went about their daily round of duties with their delicate hands carefully protected by kid gloves. It did not take long for the end for such experimenters to arrive. They returned to the great city sadder, but wiser. The squab industry has suffered also the past five years from such treatment. Many have played with it as a child would with a new toy, giving up their pigeons in a few months at the slightest discouragement.

The past six years are strewn with the wrecks of imitation squab advertisers and their guarantees. Every spring, when demand for breeders is greatest, some of these come to life again, or new ones crop up, and they get what harvest they can, many of them selling what they can pick up in the way of culls, such as we ourselves sell to Faneuil Hall marketmen to be killed. These advertisers start advertising in January and by June they have quit.

The following, from the pen of an old poultry writer, appeared in a farm periodical of large circulation in January, 1907: "So far, every attempt made in this country to establish a large poultry (chicken) farm has been met by failure. The extensive and successful plants of today are the outcome of a small beginning and a gradual growth. True, the main cause for failure has been the lack of experience; men have undertaken work for which they were not qualified."

So it is the rule with squab and poultry failures, especially women, to blame everybody but themselves. Such persons learn bitterly that experience is indeed a factor.

The place and flock of the one who fails with squabs tell their own story. The drinking fountains are seldom washed, the pen is seldom cleaned and the place has a run-down look generally, sometimes being positively filthy. The grain is bought and fed on the catch-as-catch-can principle with no provision for variety. The cheapest grain is bought, or it is ignorantly bought, and may be full of weevils, or sour. The owner of such a place generally matches the place.

Some advertisers selling breeding stock try to give the impression in their advertising that they control the matings and love affairs of the pigeons they sell, to the uttermost degree. "We are the ones who can start you right," they say, "with our guaranteed mated pairs." Their pigeons, however, behave just the same as all pigeons. You have just as much control over the minds of your pigeons as anybody. We have the finest equipment for mating in America, as it is the largest, a thousand mating coops being in constant use. One of the buildings is heated by a hot-water plant so as to get quick results in mating in the winter. It is natural for pigeons to breed, same as all animals. Do not believe that the man who offers to sell you pigeons has it in his power to control them after they have left his hands. The control of your pigeons is in your hands absolutely. If you raise an excess of cocks, or if you have an excess of either sex, for any reason, you should procure enough of the opposite sex to match up evenly. You should have some mating coops (ordinary boxes with wire fronts will do) and in them you should pair up birds to suit yourself as to color of plumage, or size, or special characteristics, as you raise them.

We fill all orders, large or small, with equal care and thoroughness, for it is just as much to our interest to please the customer and get more orders in the one case as in the other.

There is not much choice as to what time of year a start in squab breeding should be made. Our customers who start in the winter have been exceptionally successful because then prices for squabs are at the top notch, and it takes only a few sales to make a new breeder thoroughly convinced to go ahead to success. We ship breeders all the year round. A pigeon will not break down under either stifling heat or bitter cold, being different from other animals.

We fill orders in rotation and treat customers alike, and ship promptly. Frequently we get orders to ship by first returning express, and it is very difficult to do this. One customer in Chicago planned to start for Alaska with twelve pairs of our birds, but he held back his letter so that we got it with only two hours to fill crates and get birds to him before his departure. We filled his order as a matter of accommodation.

In ordering supplies to be sent by freight, remember that it takes a freight shipment some time to get to destination, especially when traffic is congested in the spring or in the harvest season. Give us your order for nest bowls and supplies before your house is ready.

The live breeders are shipped by us either in specially made pine crates or wicker coops. The wicker coops remain our property and are returned to us at our expense by the express companies after the customer has released the pigeons. These baskets are expensive and are fitted with large tin feed and water dishes. It is impossible to break them open with the roughest handling. The birds have plenty of room in them and arrive at their destination in fine condition.

The usual fault of inexperienced shippers is that the box or crate is too high, and too large, giving an opportunity for one bird to pass another by flying over its head. If there is too much room between the top and bottom of the crate feathers will be ruffled and pulled out, and the birds by crowding will suffocate one or two. A large, heavy crate also adds enormously to the express charges. It is not pleasant to buy pigeons and receive them in a cumbersome box weighing from twenty-five to seventy-five pounds, on which the express charges are more than double what they would be were the birds crated properly.

If the birds are going to a point only a day or a day and a night distant, they need no feed nor water. For a long journey, a bag of grain should be tied to the crate. It is the duty of the express messengers to feed and water the birds en route, and they are so instructed by their companies.

Do you know that pigeons are transported by the express companies at the rate charged for ordinary merchandise under the classification in force for 1907 on? The rate is found in every express book (ask your agent to show it to you if there is any dispute over charges) now as follows: "*Pigeons, homing, merchandise rate.*" Tell the agent to look in the P's for Pigeons and he will find it there.

For carrying most live-stock short distances, the animal rate (which is double the merchandise rate) is charged. This is a peculiar rule when it was formerly applied to pigeons, and it worked so that the buyer at a remote point got his shipment cheaper than the buyer nearer us. For instance, we

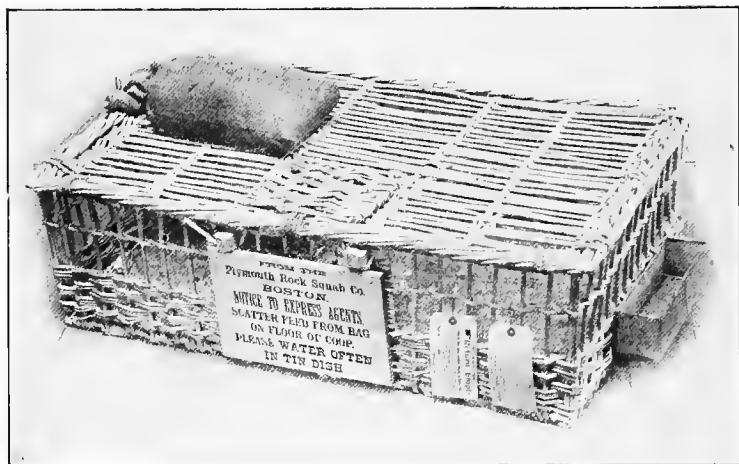

HOW WE SHIP PIGEONS.

Care and skill exercised in shipping live pigeons are large factors in satisfying customers. It is not a pleasant experience to send money away for pigeons and have them reach you in a home-made box, generally of enormous weight, and bearing enormous express charges.

We originated the above style of shipping and have two thousand shipping baskets in use. They are expensive but by their use we are able to guarantee safe arrival. The customer receives his shipment in faultless condition.

The small bag of grain on top of the basket, tied to it, is for the use of the expressman in feeding the birds en route. The tin water dish is at the end of the basket, outside, where it ought to be, not inside.

These shipping baskets remain our property and are returned to us empty at our expense after the customer has released his birds.

could ship a crate of pigeons to Chicago from Boston cheaper than we could to Buffalo. All the express companies doing business in the United States and Canada have the same rule, which is, that between points where the single or merchandise rate is two dollars or more per hundred pounds, live animals, boxed, crated or caged, are charged for transportation at the single or merchandise rate. Between points where the single or merchandise rate is less than two dollars per hundred pounds, live animals are charged the animal rate (which is double the merchandise rate). Poultry (not pigeons) are charged the one and one-half rate when the rate per one hundred pounds is less than two dollars.

In order to obtain the lowest rate of transportation, the value of each pigeon must be stated by the shipper at five dollars or less.

We have seen breeders who have been shipping live-stock for years and they never heard of the above rule of the express companies, and also we have seen scores of express agents who did not know of their own rule, but always charged the animal rate on animal shipments. But the rule is found in every graduated charge book of every express company and the experienced expressmen and experienced shippers know all about it. If the agent in your town is ignorant of the rule, ask him for his graduated charge book. Many express agents at local points seldom handle a pigeon shipment and do not know how to charge for it.

A live animal contract release, to be signed both by shipper and express agent, is needed in all cases where the value of each pigeon is more than five dollars. If pigeons which we ship are killed in a smash-up, we can recover from the company. We have no hesitation, therefore, in guaranteeing the safe delivery of our pigeons to customers. Our responsibility does not end when we have given them to the expressman. Our guarantee follows them as long as they are in the hands of the express company. We will put them into your hands safe and sound.

Once in a while you will read of live-stock and breeding associations getting together and complaining about the "exorbitant rates" charged by the express companies. The trouble is not with the rates of the express companies, but lies wholly in the ignorance of the breeders who meet to complain.

They simply do not know how to ship and how to talk to the express agents.

We never read the above advice as to shipping live-stock in any book or paper. It is the product of our own experience and the information cost us at least one hundred dollars in excess charges before we learned how to get the low rate. It is worth dollars to our customers, and that is why we have given it here in detail.

Killed squabs go to market at the rate charged for ordinary merchandise, no matter what the distance. Breeders having special customers who wish the squabs plucked should pack them in a clean white wood box (with ice in the summer) and nail the box up tight. Such shipments go through in splendid condition and if the breeder has a choice article, with his trade mark stamped on the box, he gets the fancy price. Squabs which reach the Boston market from jobbers in Philadelphia and New York are plucked and packed with ice in barrels. Breeders around Boston who reach the Boston market with undressed squabs send them in wicker hampers or baskets on the morning of the day after they are killed.

No express agent anywhere has a right to make any extra charges whatever on our pigeon shipments.

There is no duty on our pigeons to Canada, Cuba or Porto Rico, when we send with the pigeons and also to the customer, as we do, a certificate of purity of breed, declaring that the pigeons are for breeding, and not to be killed for market.

CHAPTER XII.

QUESTIONS AND ANSWERS.

Women and Squab Breeding — Attentions of the Male to the Female Pigeon — Equal Number of Males and Females — Birds Flying Wild — Sale of Birds for Flyers — Variation in Size of Nest Boxes — How Squabs are Artificially Fattened — Shipping to England — Training Flyers — A Remarkable Service for Messages between Islands.

Question. I am a woman who knows absolutely nothing of squab raising. Do you think I can make a success of it?

Answer. Our books are written and printed for the purpose of telling an absolutely ignorant person just how to proceed. If you will study this Manual, until you get the general plan and method of procedure in your mind, there is no reason why you cannot make a success of it. A woman is quick enough to puzzle out a new pattern of embroidery or a blind cooking recipe the terms of which are expressed in language utterly incomprehensible to a man. We find that our women customers are just as quick to comprehend pigeons as soon as they get started. It is necessary to have confidence, first, that the birds can make money, and second, that you are able to handle them right. Women succeed with hens quite as well as men. They "take" to animals fully as well as men. The fact that you, our customer, are a woman, ought to encourage rather than depress you, in the squab business.

Question. I have an old poultry house fifteen by twenty feet in size, ten feet high. How many pairs of pigeons can I accommodate? *Answer.* We have this question asked us many times, and our reply to all is the same. Sometimes the customer varies it by asking, How large a house do I need to accommodate one hundred pairs of breeders? Sometimes they say they propose remodeling a barn loft which is thirty by twenty feet in size. The dimensions of the building vary with the customer. You can always accommodate in theory as many pairs of breeders as you can make room for pairs of nest boxes. Fix up your building to suit yourself and put in

as many nest boxes as you wish. Then count your nest boxes and you will know how many birds you can accommodate. You must have two nest boxes for every pair of birds. Always allow more nest boxes than there are pigeons, and do not crowd the birds, as we have explained on page 29.

Question. How does the male bird impregnate the female bird? They do not seem to me to act as roosters and hens do.

Answer. The human eye is not sharp and quick enough to follow the actions of the male bird. He mounts the female in a manner which is called "treading." A female occasionally will "tread" the male bird, exactly as a female animal when in excessive heat sometimes will mount the male, or another female. Customers who had what they thought was a doubtful pair sometimes have written us saying that each would tread the other, and that of course both were males. After a while the same customer would write and say that the pair fooled him and that he had two eggs from them. The actions are in nine cases out of ten, of course, a positive guide, but there are exceptions to every rule.

Question. (1) The legs of the pigeon you sent me are red; are they inflamed? (2) The droppings are soft and mushy; I am afraid they have diarrhoea. What shall I do? (3) Most of my pigeons have a warty-like substance on their bills, varying in size with the pigeon; how shall I get rid of it?

Answer. (1) The red color which you see is perfectly natural. The legs of all Homer pigeons are red. (2) The natural droppings of the pigeon are soft and somewhat loose. When they have diarrhoea the droppings are extremely watery and the tail feathers are soiled. Your pigeons are all right and have no diarrhoea. (3) The growth of which you speak is perfectly natural. It varies in size with the pigeon, sometimes covering the base of the bill, in other cases clinging closely to it.

Question. Can I figure with certainty that of each pair of squabs which my birds hatch, one is a male and the other a female? *Answer.* Not with absolute certainty, but as a rule. It is Nature's way to provide for an equal number of males and females, for that is the way the species mates and is reproduced.

Question. Enclosed find ten dollars, for which please send me settings of pigeon eggs to that value, and send me the balance due, if any. *Answer.* We do not sell pigeon eggs.

It is impossible to use an incubator and raise pigeons successfully, because there is no way of feeding the young squabs when they are hatched. The life of squabs is nourished and prolonged from day to day by the parent birds, which feed them. To raise squabs, you must start by buying the adult breeders. You cannot start with the eggs.

Question. It seems to me that if each pair of squabs hatched consists of male and female, that this couple is likely to pair when grown, being well acquainted with each other. This would be inbreeding and would weaken my flock. What shall I do? *Answer.* It is not the plan of the species to mate and inbreed like this. If brother and sister mated as you describe, the species would be extinct after a while. They will look for new mates as soon as they get out of the nest and are of breeding age.

Question. When are the young pigeons old enough to mate? *Answer.* At from four to six months.

Question. My birds do not know enough to go in from the roof of the squab house when it rains. How shall I get them in? *Answer.* Let them stay on the roof in the rain if they wish. The rain will do them no harm.

Question. Must I heat the squab house in the winter time? *Answer.* No. The heat from a flock of pigeons in a well-built house is considerable. You will get more squabs from your pigeons in the winter time if you do heat your house slightly, not enough to cause much expense, but just enough to take the chill off. Do not let your birds out of the squab house on bitter cold days.

Question. I live in Texas and I think in this climate your squab house would be too warm and stuffy. *Answer.* You are right. Adapt the construction to your locality. The poultry houses in Texas as compared to those in the North are much less expensive and more open to the air, and your squab house should be built on the same principle.

Question. Suppose I cool the squabs as you direct and pack them into a box for shipment, shall I use ice? Is there any danger that the meat will be discolored when they arrive at market? *Answer.* Ice is not necessary in the fall, winter and spring. In the summer time you should use ice, although if the shipment is for a short distance, ice may not be necessary. In hot weather the squabs should not be killed until the night

before shipping. In the cool months you may keep them at home longer. If the squabs are cooled by hanging them from studding as we describe, there is no danger that the meat will be discolored. The object of hanging them from studding is to cool the carcasses properly so that the meat will not be discolored by contact.

Question. How shall I pack the killed squabs when I send them to market? *Answer.* Lay them in the box layer on layer, in an orderly fashion. Do not throw them in helter skelter.

Question. Can I hang the squabs to cool from studding suspended in the barn, in the summer time? *Answer.* It is better to use the cellar of the house, or the coolest room in the house.

Question. I do not like your idea of keeping the birds wired in. They are free by nature and it strikes me that they should have a chance to get exercise by long flights. *Answer.* You must keep them wired in, or they may leave you. Remember that the Homer is attached to the place where it is bred, that is the Homer instinct. If you buy birds of us and on opening the crate let them fly anywhere they choose, trusting to luck to have them come back to you, you may be disappointed and lose some of the birds. You must keep them wired in all the time.

Question. You say your Homers are fine flyers. What is the use of my buying them of you to fly in races or to sell again as flyers, if they may desert me when I let them out into the open air? *Answer.* The squabs which you breed from our birds will know no home but yours, and they will not fly away from you. You can send them away, when they are old enough, and time their flight back to your house, their home. When you sell these trained flyers to others, you do not expect that they will try to fly them, but that they will use them for breeders.

Question. How large are the mating coops? *Answer.* A convenient size is two feet long, two feet wide and two feet high.

Question. My birds seem timid and I am afraid to catch them. How shall I go about it? *Answer.* Do not be afraid of hurting them. Take a broom and drive one where you will, finally pinning it against the side of the squab house, or

in a corner. Grasp it and hold its wings firmly and it will not struggle. Or you may make a net on the end of a pole, like an ordinary fish landing net, and scoop the bird into it as it flies through the air.

Question. Suppose I have several squab houses, as you describe, but let all the birds together in one large flying pen, where they can bathe from one large fountain. *Answer.* This is all right if you do not wish to keep close track of your birds. If the birds can roam from one house to another, there is nothing to prevent a pair from building one nest on one house and then going to another house to build the second nest.

Question. I believe I will put a strip of wire or piece of wood across the front of each nest box so as to keep each pair more secluded, and to keep the nests from dropping out. *Answer.* Don't do it. Don't worry about the nests falling out. Build the pigeon-holes perfectly plain.

Question. How many squabs shall I pack in one box when sending to market? *Answer.* Having picked out the size of the box you wish, fill it up close with squabs, so they will not "shuck." As to the size of the box, make it as big or little as you please, but do not make it any bigger than one expressman can handle easily. A good size is two feet square and one foot deep.

Question. Send me two males and ten females. *Answer.* You must buy your birds in pairs. They pair off in this way, namely, one male to one female. One male does not have two or three females. We have heard pigeon breeders talk of having one cock which would attend two hens, but never had a case in our experience.

Question. After plucking the squab, and before sending it to market, do you remove the entrails? *Answer.* No.

Question. In order to avoid the trouble of using the mating coop, may I put an equal number of cocks and hens in the same pen? *Answer.* Yes.

Question. Can I discover the male and female organs by examination of the birds with a magnifying glass? *Answer.* No. You can discover them by dissecting the dead bird.

Question. Suppose I build the nest boxes larger, so as to give a shelf on which the birds can alight? *Answer.* Don't do it. The bird will fly directly into the nest, or onto the nest

box in front of the nest. You do not need an alighting place.

Question. Seems to me that if I start with forty-eight pairs of birds, I ought to have ninety-six perches. *Answer.* The birds do not all perch at the same time. While some are perching, others are on the nests, or walking on the floor, or are outside in the flying pen, or on the roof. Put up a few perches where you have room and let it go at that.

Question. I live in England; can you ship me twenty-four pairs of your breeders? *Answer.* Yes; the transportation charges will be four dollars. In addition you will have to pay the butcher or steward of the boat ten shillings for feeding and watering the birds. Send us six dollars and fifty cents in addition to the regular price of the birds and we will ship to you all charges prepaid. In shipping to Cuba and remote points in the United States and Canada, we do not have to pay anything extra for the feeding and watering of the birds; the express charges include the feeding and watering.

Question. What is a Runt pigeon? Please quote prices on a dozen pairs of Runts. *Answer.* A Runt pigeon is a special breed of pigeon, remarkable for its large size. They come all colors, as a Homer does. The white Runts are an exceptionally beautiful bird and command large prices, as high as six dollars to fifteen dollars a pair. The squabs which Runts breed weigh from eighteen ounces to one and one-half pounds at four weeks. If Runts bred as fast as Homers, they would be just the bird for squab breeders, but they are fatally slow in breeding, as a rule. The Homers raise two pairs of squabs to the Runts' one. Therefore it is of course more profitable to raise Homers. We do not sell Runts and do not advocate their use either as a separate breed, or crossed up with Homers. The large, plump, thoroughbred Homer is the best.

Question. What is the difference between the Homer and Antwerp breeds of pigeons? *Answer.* No difference. The name is used interchangeably to apply to the same breed of pigeon. In New England we speak of them mostly as Homers. In some places they are called more often Antwerps.

Question. Can I feed some of my squabs by hand if necessary? *Answer.* Yes. Mix up a mushy, soft handful of grain, hold the squab in the left hand, close to your body, and with the thumb and first finger of your right hand force the

mixture into the bill. The squab will swallow and fill its crop. A backward squab may be forced in this manner.

Question. Can you sell me twelve pairs of young Homers, about eight weeks old? *Answer.* No. It is impossible to tell the sex of pigeons of that age. Any breeder who undertakes to furnish squabs several weeks old in equal males and females cannot do so and is imposing on you.

Question. Please give recipes for cooking squabs. *Answer.* See the cook books. Squabs are generally served broiled. They should be drawn, singed and washed. Cut off the heads, split into two parts, season, put on a lump of butter and broil over a hot fire. Place close to the fire at first so as to brown the outside and retain the juices, then hold further away from the fire to complete the cooking. If roasted, leave them in a hot oven for thirty minutes. For roasting, squabs may be stuffed with cranberries or currants. Baste every ten minutes with spoonfuls of hot water and butter.

Question. How shall I train the young birds raised from your Homers to fly? *Answer.* There is a large business in flying Homers and if you have a pen or two of trained birds you can sell them at fancy prices. There are homing clubs all over the country which have contests and it is worth while for a breeder to work for a reputation of breeding and selling fast flyers. The young Homers when five months old are strong enough to be trained to fly. Take them in a basket (having omitted to feed them) a mile or two away, and liberate them one by one. They will circle in the air, then choose the correct course. You should have left grain for them as a reward for their safe arrival home, and an inducement for their next experience in flying. Two or three days later take or send them away five miles and repeat. Next try ten miles, and so work on by easy stages up to seventy-five or one hundred miles. If you have a friend in another city, you may send your birds in a basket to him with instructions to liberate certain ones at certain hours, or you may send the basket by train to any express agent, along with a letter telling him to liberate the birds at a certain hour and send the basket back to you. If you wish to have the birds carry a message, write it on a piece of cigarette paper (or any strong tissue), wrap the paper around the leg of the bird and

SELF-FEEDING GRAIN TROUGH.

It is quite difficult to devise a grain trough from which the pigeons cannot throw grain out, as they poke around in search of tid-bits. The trough illustrated at the top of this page is a good one. The grain falls down in each compartment as fast as it is eaten. The pigeons when eating stand in the front part of the trough and if they pull out any grain, this is not scattered on the floor of the squab-house but on the board front, from which it may be swept up as necessary. This pattern of trough was designed by Dr. F. D. Clum.

One sketch shows the box without cover and the other with cover in its proper place, protecting the entire box and contents from droppings of the birds. The dimensions do not matter. A good size would be about four feet long and two feet wide. This would allow for feed compartments about five inches wide, nine in number.

The trough for grain illustrated at the bottom of this page is for use when feeding by hand twice a day. It was devised by Charles W. Brown. It is simple and open, still the birds cannot foul the grain in it. The size shown in the picture is four inches wide and two inches deep inside, thirty-six inches long outside. Twenty birds can feed at once at this size. The ends are four inches high inside to centre of pivot.

These pivots are the feature of the trough and give it its novelty. The birds cannot get into the box and foul the feed because the bar is in the way. As the bar is pivoted and turns when they alight on it, they cannot roost on it. The pivoted wood bar is of one-inch square stock. The box also is of one-inch stock, so as to be heavy and strong. The box is deep enough to prevent birds from throwing out the grain when enough for twenty

birds for one meal is in it. There is space between the edge of box and the bar ample for the birds to feed, but not enough space for them to get into the feeder. The fact that the bar is pivoted does not prevent the birds from alighting on it but, being pivoted, the bar turns as soon as they alight on it and off they go. They soon learn to keep off it. The illustrations and descriptions of both these troughs are taken by permission from the *National Squab Magazine*.

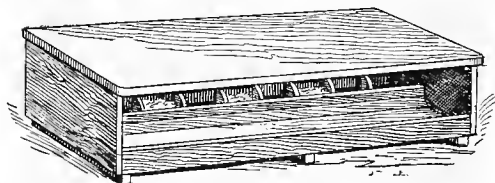
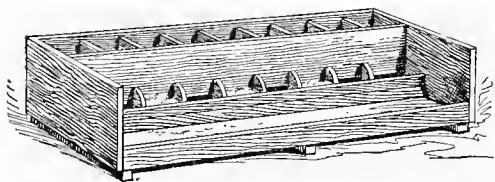

SELF-FEEDER FOR GRAIN

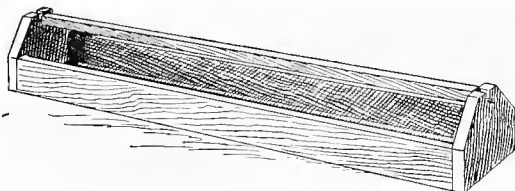

END VIEW

SIDE VIEW

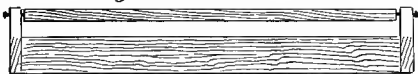

TOP VIEW



OPEN TROUGH WITH REVOLVING BAR

tie with thread, or fasten with glue or a stamp; or, you may tie the tissue around one of the tail feathers. A thin aluminum tube containing the message may be fastened to a leg, or to a tail feather. A trap window should be constructed to time the arrival home of birds. This is an aperture about six inches square closed by wires hanging from a piece of wood at the top of the aperture and swinging inward, but held close to the aperture by its own weight. The pigeon cannot fly out but on its return home (if you have sprinkled grain on the inside of the house, next the wires) the bird will push the wire door and go in. It takes only a day or two for the pigeon to become accustomed to the trap. If you connect the trap with a simple make-and-break electric circuit, the pigeon on its arrival home from its flight will ring a bell in any part of your house or barn. When you have a record of the flyers, you will have a guide for mating. The majority of fanciers recommend a medium-sized Homer. A large hen should be mated to a small cock, or a large cock to a small hen. What is perhaps the best pigeon service in the world has been in use for several years between Newton Roads, Auckland, New Zealand, and the Great Barrier and Maro Tiro Islands, some seventy-five miles distant. A boy of sixteen years worked up the service and makes a large income from it. About twenty messages an hour are carried back and forth by the Homers. A year ago the government declared its intention of laying a cable from Auckland to Great Barrier. The project was abandoned, however, as the residents of the little island decided that they were well pleased with the pigeons, and that a cable would not be patronized. The government offered to buy the whole pigeon outfit from the boy owner, but he refused. There are from four hundred to five hundred pairs of pigeons in the service.

Question. In the case of young birds mated up for the first time at five or six months of age, is it best to destroy the first eggs, or let them go ahead and hatch in the regular way?

Answer. Let them go ahead and hatch and learn to feed their young. It will improve them for the next hatch.

Question. Please describe the self-feeder more fully and explain its operation. *Answer.* The hopper of the feeder is V-shaped so that the grain will fall by its own weight to the centre at the bottom, which is cut away as shown in the

illustration so that as the birds peck up the grain, more falls from the hopper. The slit where the birds eat should be about an inch and a half in width, just enough to prevent the grain from running out faster than it is eaten. If the grain is pulled out on the floor, tack a strip of wood, like a lath, so as partly to block the holes.

Question. Should I cover the yard of the flying pen with your grit? *Answer.* No. Provide a box and keep our grit in the box. When the pigeons want grit, they will go to the box and get it.

Question. Are the carrier (flying) pigeons the same breed as your Homers? *Answer.* Yes. A flying or carrier Homer is a Homer that has been trained to fly a long distance.

Question. What are artificially fattened squabs? *Answer.* An artificially fattened squab is a squab which has been stuffed by hand. Take a syringe and fill it with fattening mixture of gruel-like consistency, open the mouth of the squab and force the contents of the syringe into the crop of the squab. Very few breeders take this trouble to bring their squabs to an extraordinary size.

Question. I wish you had shipped my breeders in one large crate, then the express charges would not have been so much as for the two crates which you used. *Answer.* You are mistaken. An express shipment goes by weight and not by number of packages. The express clerks put all the crates going to one customer on the scales together and weigh them all at once and on the total weight the charge is based. They prefer to handle a large shipment in small packages, rather than in one large package.

Question. Can I use the upper part of my henhouse for pigeons, and if so will the pigeons interfere in the flying pen with the hens? *Answer.* You may use the upper part of your henhouse and the pigeons will not be harmed by the hens, nor the hens by the pigeons. It is best to build the flying pen in two stories so that the pigeons cannot fly into the henhouse to try to nest.

Question. To save room, I would like to build my pigeon house in two stories. *Answer.* That is all right. Build the top flying pen out over and extending beyond the bottom flying pen if you wish to separate the flocks on the ground floor from the flocks upstairs.

Question. What are the bands for pigeons' legs and how are they applied? *Answer.* The seamless band is a ring of aluminum three-eighths of an inch in diameter and from three-sixteenths to one-quarter of an inch in width. You cannot apply it to an old pigeon. It is put on either leg of a squab when the squab is four or five days old, by squeezing the toes of the squab through the band. As the leg of the squab grows, it becomes impossible to remove the band except by cutting it off. On the band, before putting it on the leg of the squab, you may stamp year of birth and your initials, or anything you choose. We sell an outfit consisting of aluminum tubing, dies, etc., by which the squab breeder may make his own bands at a cost of two or three for a cent.

Question. Since I bought twelve pairs of you, I have kept a careful account of the feed, and find as you state that five cents a month for a pair of breeders is right. Grain has been much higher than usual this summer and it strikes me that under normal conditions of the grain market the cost of a pair of squab breeders would be less than five cents a month, or sixty cents a year. *Answer.* Our figures of cost were ascertained not by "skimping" the birds, but feeding them liberally, and an estimate of five cents a month for a pair is based on a low cost of grain, and on selling the manure.

Question. What pattern of trowel do you recommend for cleaning the nest bowls and nest boxes? *Answer.* The common trowel such as bricklayers use is too pointed. The best pattern has a square point and a stout blade with strong handle. With such a trowel you can clean out the nest bowls and nest boxes very effectively.

Question. Can pigeons be raised on the sea-coast as well as inland? *Answer.* Yes; the Homer pigeon is descended from a variety of pigeon which first bred among the cliffs bordering the sea-shore.

Question. Do the squabs fly out of the nest before they are four weeks old? *Answer.* No; they look old enough to fly at four weeks, and their wings seem all ready for use, but they stay in the nest and are fed by the parent birds, and when you wish to kill them you find both in the nest ready for you.

Question. Your book states that pigeons sometimes lay their eggs on the floor. But it does not say anything about taking the eggs and putting them in a nest bowl. Would the

birds follow their eggs and accept change of nest from floor to nest bowl? *Answer.* No; you must leave the eggs where they lay them. You can handle a nest and change eggs from one nest bowl to another, if you wish, but you cannot move eggs from one place in the squab house to another and expect the birds to find them and go on with their laying.

Question. Do all squab breeders heat their houses in the winter time, I mean those who do a large business like yourself. *Answer.* No; some breeders of many years' experience believe that a warm house is detrimental to the health of the birds, on account of the sudden change of temperature from a warm house to a cold flying pen. The object should be merely to take the damp winter chill off the air. If you have a warm, tight squab house which you will close when night comes, you will need no heat.

Question. In the case of a long house, say four units long, should there be wire netting partitions between the units, so as to separate the birds into four flocks? *Answer.* Such an arrangement is more practical than one long house. It is better to keep track of four small flocks than one large flock. You can keep account of the birds both on paper, and with your eyes, with more precision.

Question. How is salt cat made? *Answer.* Take sixteen quarts of sand, eight quarts of slaked lime, four quarts of ground oyster shells, one pint of salt, one pint of caraway seeds and mix with water into a stiff mud. Form into bricks and set away to dry. The water with which you mix should have a tablespoonful of sulphate of iron and a tablespoonful of sulphuric acid for tonic and disinfectant. The birds peck at this mixture and it is believed to have a tonic and strengthening effect on them.

Question. Shall I crowd one of the units with nest boxes, or would it be better to have a smaller number of nest boxes and build another unit to accommodate the new birds which I am going to buy? *Answer.* Better enlarge your squab house. In case of doubt, you will be on the safer side if you do not crowd the birds.

(See following pages for points which may occur to you and which are not covered in these questions and answers.)

SUPPLEMENT

NATIONAL STANDARD SQUAB BOOK

BY ELMER C. RICE

Every year shows a healthy growth in the squab industry and in our business, which has become **the largest and most successful in the world in the pigeon or poultry line**, and is expanding steadily, requiring every little while new buildings, larger business offices, more help—and the growth is going steadily on, with every prospect of a like increase the coming year.

On April 1, 1904, to get more room for the Boston office, we were obliged to move from No. 9 Friend Street, and are now located at **287 Atlantic avenue, Boston**, where in a new modern building and with our quarters fitted with every convenience for the rapid and accurate handling of business, we have the largest space in New England devoted to the pigeon or poultry or kindred trade.

Our **Manual, the National Standard Squab Book**, is the best-selling work on breeding or farm-life ever published in any country, and has been carried in the mails to every part of the civilized world.

We do not speak of these matters to magnify what we have done, but because they are an assurance to new customers that we are entitled to their confidence and patronage. We are grateful to the men and women who have favored us so bountifully with their trade, and intend to merit further confidence.

We have an extremely modern equipment in our Boston office for handling correspondence, including a **\$200 system of business phonographs**, Edison patents. Mr. Rice handles the important part of the large correspondence, dictating personal replies to phonograph cylinders which are taken by young women and transcribed on typewriters. By the use of this phonograph system, easy, full and correct replies for all letters are possible.

Our business is too much a matter of pride with us, too large, and too successful, to permit of a single patron being dissatisfied. We have spent **over \$100,000** to put our trade on a firm and successful footing and we cannot afford to run the risk of displeasing a customer. If resources, skill and experience count for anything, and we think they do, we intend to keep on furnishing the best Homer pigeons possible, and patrons can rest assured that they are getting for their money the greatest possible value. Moreover, we have **one price to all**; the customer in California can buy of us as cheaply as our next-door neighbors. Our farm is always open to inspection and customers may make their own selection of breeding stock, if they desire.

Our general advertising in the high-class magazines and other periodicals not only induces the breeding of squabs but also **leads people to eat squabs**. For every one who sees our advertising and writes for particulars and starts breeding, there are a score of men and women who inquire of their butchers or marketmen for squabs in order to eat them. Squab dealers in every section of the United States and Canada are reporting **an increased demand** with which the supply cannot begin to keep pace.

We take some pride in the squab industry. We were the pioneers in it and we put it on a commercial basis. We have fostered it on correct lines and according to sound business principles, and the growth has not been a

"boom," as some other things in the past have been boomed, but has been steady and sure and successful. We paint no extravagant picture as to the profits of squab raising, and **we show proofs every step of the way**—stories of success of our customers who started green and are making money.

That there are occasional failures is to be expected. We give no recipe and sell no machinery for transforming an incompetent person who fails at many tasks into a success. But the history of this industry and of our business demonstrates with a power that cannot be denied that squab raising is **right**.

No business climbs up the hill of profit steadily for any length of time unless it is absolutely fair, advertised by true statements, and giving a true money's worth. When we began to tell the country about squabs, people would come to our office and say, "Well, it reads pretty good, but is it true?" We did not have much evidence ready then, **but we have now**. Our answer is the present condition of the squab industry, forging ahead with giant strides to its place alongside of eggs and poultry, millions of dollars in value, and the unsolicited letters from our customers which we print, showing the most remarkable and convincing progress of this breeding.

We have already printed a great many of these letters in years past, and we print more in this **Supplement**. We have room here to show only a small part of such testimony. For every letter printed here we have scores just as convincing. These communications have come to us unsolicited, day by day, as the business brought them, and more are coming every day, and they are our answer to doubters. They are the proof that what we say about the business and what we teach in the **Manual**, is **true**, and is being worked out successfully. We do not print the names and addresses of the writers of these letters because many of them are regular buyers of our birds, and moreover, we cannot advertise other breeders free of charge. These letters and the testimony they give are valueless if they are not genuine. Each and every one is genuine, and moreover, we guarantee their genuineness, and will produce the originals at any time to satisfy anybody. In these days when many "testimonials" are unblushingly "worked up" without a shadow of foundation, there are skeptics, and to such who cannot come to Boston and see us, we recommend that they send one of the commercial agency men to make the inquiry and handle the evidence. We have never yet had the genuineness of our letters from customers questioned, for they "ring true," and are in the simple language of facts which cannot be counterfeited, but we are ready at any time for any doubter.

What others have done and are doing with our birds, you can do.

KILLING MACHINE. To kill squabs with extreme rapidity we have made a machine with which the operator can work with much ease and satisfaction. The method of **tweaking the necks** which we describe and illustrate in the **Manual** is slow when compared with the work of this machine, and is repugnant to many, especially women.

The illustration shows the construction

clearly. The neck of the squab is placed between the movable arm (or lever) and the lower arm, and the lever is brought down upon the neck, breaking the bones, crushing the spinal cord and **killing the squab instantly**. The operation produces no blood, nor does it break the flesh. The two edges of the upper and lower arms, where they come together against the neck of the squab, should

not be sharp so as to cut the flesh, but should be rounding, and slightly flat at the points of contact.

The base-board is made of three-quarters or one-inch lumber, twenty inches long and seven inches wide. The upper arm (or lever) is of half-inch stock, one and three-quarters

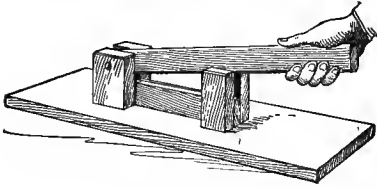

inches wide and fifteen inches long. The lower arm is of half-inch stock one and three-quarters inches wide and eight and one-half inches long. The two upright pieces in front, nearest the hand of the operator, are each of seven-eighths or inch stock, one and three-quarters inches wide and three and three-quarters inches high. The two upright pieces in back, furthest from the hand of the operator, are each of seven-eighths or inch stock, two and one-half inches wide and three and three-quarters inches high.

The pin at the back of the machine on which the lever turns is of one-quarter inch brass or iron rod two and one-quarter inches long.

The upper arm (or lever) is bevelled or cut off at an angle on lower corner (behind the uprights, and consequently invisible in the picture) so that the lever can be raised to an angle of forty-five degrees, thus permitting the neck of the squab to be inserted between the arms at a point just back of the farther uprights. When the upper lever is at rest upon the lower arm, there should be no space between the two; they should butt flush together.

The whole machine is built of wood with the exception of the metal pivot and the screws which hold the parts together. It is not necessary to mortise the uprights into the base-board. The screws which fasten the uprights are started underneath from the back side of the base-board and go through the base-board. Nails may be used instead of screws to hold the parts together, but the job will not be so strong. The base-board should be nailed or screwed to a bench or table so as to give firmness and solidity in operation. Carry the squabs in a basket to the machine and kill them there; do not take the machine into the pens and kill the squabs in sight of the other birds.

We do not sell this squab killer. It should be built by you or your carpenter.

Customers with large plants have told us that this tool is a handy article, and we

have found it indispensable. The squabs can be killed as fast as you can work the lever. The pressure is considerable and the cords are crushed at once. The squab is not strangled but is paralyzed, and made lifeless at once.

For those who do not care to build a wood squab-killing machine as described above, we sell pincers, to accomplish the same purpose in the same way; see our catalogue. These pincers should be oiled at the joint, and the joint worked so that they will open and close freely. When first purchased the joint is tight, and works hard.

For dealers who wish squabs bled, use the knife which we describe in our catalogue.

WEANING THE YOUNG BIRDS. If you are starting with a small flock with the expectation of raising your own breeders, do not take the young birds away from their parents out of the breeding pen until they are weaned. They are not thoroughly weaned until they are six or seven weeks old. It is true that many of them hop or fly or are pushed out of the nests when they are from four to five weeks old, but they continue to cry for food when they are hungry, and the old cock bird of the pair which hatched them will be seen feeding them on the floor. The youngsters at this time are feeding themselves, but to keep them strong and rugged they need the crumbs of parental food which they get as described, and for which they cry, or squeak. These crumbs have been moistened by the parent bird and consequently digest quicker and better.

When the youngsters are weaned, take them out of the breeding pen and put them in the rearing pen. (The rearing pen is fitted with nest-boxes, etc., exactly the same as a breeding pen.) You can tell by their looks when they are old enough to remove, even if you have not kept track of their age. The substance (called the cere) at the base of the bill of an old pigeon which is white will be a dark brown on a squab or young bird. A squab in the nest is so fat as often to be bigger than either of his parents, but after he has got out of the nest and hustled around on the floor he trains off that fat and becomes thin and rangy and can generally be told from an old bird, if in no other way, because he is smaller.

A poor beginner will sometimes be heard to say: "Many of my young birds are dying." When he says that, you may be sure that the trouble, every time, is with him, and not with his birds, provided, of course, his parent stock is rugged and handsome. It may be deduced, without asking any further questions, that he is taking his young birds away from the breeding pen before they have the strength to support themselves. The precarious period of all animal life is the weaning age. Some beginners who have had no difficulty in raising squabs to market

age have had losses because they supposed that a full-fledged youngster was able to take care of itself, but we never knew a case of this which we could not straighten out simply by recommending the breeder to keep his young birds longer in the breeding pen.

NEED OF HEALTH GRIT. It has been our experience in dealing not only with many thousands of beginners in the squab business, but also with a great many breeders of considerable experience, that comparatively few have a proper appreciation of the value of grit. Pigeons have no teeth and must have grit to take the place of teeth, otherwise they cannot prepare their food for their stomachs properly, and will not do well. We have had customers take the most extraordinary care with regard to the grain, but supply absolutely no grit, and then they complained because their birds were not breeding properly, and that the squabs were not plump.

Grit is not oyster shell, nor is oyster shell grit. You must have both. The grit is needed, as stated, to grind the grain, while the oyster shell is needed to supply the constituents out of which the female pigeon forms the egg.

The yard of the flying pen must be gravelled not grassed, and out of this gravel the birds get considerable grit. If you watch them, you will see them pecking at this gravel in the flying pen constantly. Beach sand, or sand of any kind, may be used in the flying pen instead of gravel. The flying-pen yard should be renewed with fresh sand or gravel every six weeks, for although it may look the same to you, you must remember that it does not look the same to the birds, for they have been going over it constantly picking out the particles which they liked. In the winter time when the flying pen may be covered with snow, it is well to keep a protected box filled with gravel or sand in the squab-house. By a protected box, we mean a box which the birds cannot foul, but which allows the grit to fall down as fast as eaten.

In a protected box in the squab-house there should also be fed the **Health Grit** which we sell. We have used all kinds of grits, and the grit we are now using and selling to the exclusion of everything else, is the only grit which pigeons will eat greedily (thus showing that it is good for them). It contains salt, and no salt need be provided in lump form if this grit is supplied. The grits commonly manufactured and sold for poultry, made out of granite, etc., are useless for pigeons, and it is a waste of money to buy them, for common gravel or sand would be fully as good, and cost nothing.

A flock of pigeons under any conditions and in any part of the country will do better when our **Health Grit** is fed. The squabs will be ready for market a few days earlier, they will be plumper, and both they and the old

birds will be in rugged health, and will keep so. We keep this grit before our own pigeons constantly, and consume and sell more tons of it every year than of any grit in the market. It is used by practically every large squab breeder of our acquaintance. We recommend it in the highest terms, knowing in our own experience that it pays for itself many times over.

We charge two dollars per 100 pounds for this grit. We do not sell less than fifty pounds. Price of fifty pounds, one dollar. We ship it in bags and it goes at a low freight rate. A hundred-pound bag will last a small flock for months. It is as good for hens as for pigeons. This grit should be kept in and fed from a wood box. Do not put it in a tin or galvanized iron box.

OYSTER SHELL. A great deal of oyster shell on the market is unfit for pigeons, not being ground fine enough. It is quite difficult in some sections of the West and South to get oyster shell, which has to be transported from the seaboard. The oyster shell which we supply our trade is put up in one-hundred-pound bags. Price 75 cents per 100 pounds. No order filled for less than fifty pounds; price of fifty pounds, forty cents. It is ground fine and is just right for pigeons. It should be fed to the birds from a protected box in the squab-house.

INSECT SPRAYER. Pigeons have a long leather louse which is not harmful. The mite which causes the only trouble is small, about the size of a pin-head, called the red mite, because after it has sucked the blood of the pigeon it is colored red. We have gone a whole season without seeing any of these mites in our breeding houses. If lice of this kind, or any kind, are discovered, the **insect sprayer** which we illustrate here will be found useful. The barrel is filled with kerosene (or water in which **squab-fe-nol** has been poured) and a fine spray driven against the nest-boxes and nest-bowls, or even against the birds.

These insect sprayers are well made of heavy tin. We sell them for fifty cents



each. They cannot be mailed, but should be sent by express, or with other goods by freight.

Birds which are lousy may be dusted under the feathers, next the skin, with any good lice powder, or with tobacco dust. The best time for such treatment is at night, when the birds may be readily caught and

handled. It is also a good idea to throw a pinch of tobacco dust in the nest, on and around the squabs, about once a month during the summer.

Lice are the terror of chicken raisers, but we never knew a squab raiser, if intelligent, to be troubled very much or very long with lice.

Once free of lice, the birds almost invariably keep themselves clean. It is only the loft where cleaning is badly neglected which is troubled with lice.

There is a light-colored grub which sometimes forms in the manure on the bottom of the nest-box, but no trouble comes from it and it does not get on the bird.

RED AND WHITE WHEAT. It is impossible for us to tell what is the difference between red and white wheat. We do not know the chemical constituents which color one kernel red and another variety white. This question is asked us by inquirers who have never heard of red wheat, yet it is a common and staple variety of wheat quoted daily in the Chicago and other grain markets. If you cannot get red wheat where you live, feed white wheat, which is fed regularly by nine-tenths of our customers. As we say in the *Manual*, we feed red wheat instead of white wheat because it is not so much of a laxative. When we cannot get red wheat, which happens at some periods of some years, we feed white wheat.

The effect of wheat is to keep the bowels of the birds open and regular. There is not much fattening substance in wheat. That function is performed by corn.

Birds fed on wheat and nothing else get so weak that they do no breeding. We have found this out by the experience of customers. Now and then a customer buys birds without thinking that they must eat to live. After he has got them he suddenly recalls that they must be fed and starts out to find something. We recall vividly one Kansas customer of this kind who was induced by some grain man to buy a lot of wheat and nothing else. After feeding his birds nothing but wheat for two weeks, he wrote us that they were dumpy and showing no inclination to build nests. "They are all the time on the floor," he wrote, "and cannot fly." He had made them so weak by feeding the wheat that they could not fly to their nest-boxes, to say nothing of building nests.

USE OF LEG BAND OUTFIT. The aluminum which we sell with our leg band outfit is seamless tubing and by the use of the outfit you produce a band which is seamless and which can be applied only to a squab, because, of course, the feet of an old pigeon are too large to be squeezed through the band as a squab's can be squeezed. To make an open band (which can be applied to the leg of a full-grown pigeon) out of the closed band, you simply make a saw-cut lengthwise the band, then open the band

with your fingers, put it around the leg of the pigeon, then close the band again. If any one has old pigeons which he wishes to band, he will find this band outfit quite as serviceable as if used only for banding squabs. We have sold thousands of these band outfits, and customers like them first-rate. We can furnish open bands (to be applied to the legs of full-grown pigeons) made of aluminum, V-shaped joint, each band numbered, a first-class band in every way, for two cents each, or two dollars for one hundred, postage paid.

MANAGEMENT OF BATH PANS. The sixteen-inch bath pan which we recommend and sell is better than a larger size, no matter what the capacity of your plant. It is easier emptied of water, there is less strain on the arms, and it is kept clean easier.

There should be one bath pan for every twelve pairs of birds. If you have about 48 pairs of birds in each unit, you should have four bath pans in that unit, outside in the flying pen. You can get along very well with one drinking fountain to a unit with that number of birds, or a less number of birds, but if you do not have bath pans enough the bathing water will get dirtier than it should and the birds should not be given an opportunity to drink this dirty water.

In the winter, when the birds are shut up in the squab-house frequently for days at a time, it is not necessary to bathe them every day. Bathe them once each week, taking the bath pans into the squab-house and letting the pans stand before them for about an hour. If you let the water stand in the bath pans in the squab-house in the winter time all day, they will splash too much out onto the floor, and the house will get damp.

If your plant is a small one, the best way for you to manage is this: At evening (sunset, sometimes before) your birds will all leave the flying pen for their nests and perches inside. Then fill the bath pans with water. When the following day dawns, and before you are up, the pigeons will fly out and take a bath. When you get up, go to your pigeons and empty the bath pans, turning them bottom side up and leaving them that way all day.

The price of these sixteen-inch bath pans is forty cents, crated ready for shipment.

KILLING WITH A KNIFE. Some dealers in squabs wish them to be killed with a knife as this gets out the blood and makes the flesh somewhat whiter. Find out whether or not the man to whom you are going to sell the squabs wants them bled. The way to kill them with a knife is to insert the knife inside the bill and cut the jugular vein. Then hang up the squab bill downward and let the blood drain out. By using the knife on the inside of the throat you do not make

a wound which is visible to the eye of the consumer. Use a knife with a long, narrow, sharp blade. We sell them for forty-five cents each, postage paid.

CONCERNING NEST BOXES. Many customers who do not use egg-crates or orange boxes, but build their nest-boxes of half-inch or five-eighths lumber, have written us that they have used the construction which we illustrate herewith and which is good, because cleaning can be better done.

The bottoms of the nest-boxes are removable and rest on cleats, as the picture shows. The cleats are seven-eighths or one inch square and are nailed to the uprights.

When this construction is employed, it is not necessary that you have a block or base screwed to our nappy or nest-bowl. The nappy or nest-bowl may be screwed directly onto this removable nest-box bottom.

It is not necessary to nail a strip of wood across the fronts of the nest-boxes, to prevent the squabs from falling out.

The squabs stay in the nest until they are ready to leave it, and it is very rare to find one on the floor. It will be noticed that in the cities, the street pigeons' nests in many cases will be found on the open cornices of high buildings, and if squabs

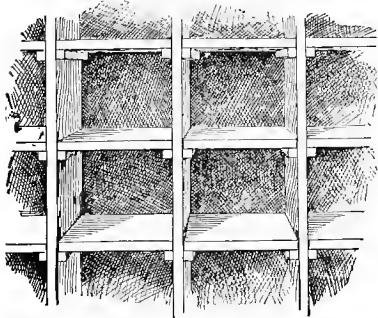

stay in such nests until they are able to fly, the beginner with squabs ought not to be worried about his birds' nests which are only a few feet from the floor.

SQUABS IN CHICAGO. The following article is taken from the *Chicago American*: Squab Farming is a new Chicago Industry. Little Capital is Required and Persons of good Judgment and Care can Realize Good Profits from Pigeon Culture.

If all the birds in all the pies were suddenly to lift their voices in song like those in the nursery rhyme, the chorus would be loud and long, for raising of squabs for food is a constantly growing and lucrative industry, and withal very fascinating.

A number of farms, each sheltering several hundred birds, are being conducted within easy reach of the Chicago market.

Such clubs as the Union League and Athletic are always ready buyers. Plump birds are readily sold for a dollar apiece for breeding purposes, and their squabs at \$4 a dozen for food. As in any field of labor, the best results come from studied and carefully planned effort. Utmost cleanliness in food and in the little compartments to which each bird comes with unerring instinct to nest enters largely into success.

Eggs of clear black or white birds are difficult to hatch because the birds of those colors are very restless and nervous, not caring for their eggs; sometimes only one in a dozen being matured.

In four weeks the young bird is ready for the market. Many of the squab farms are side issues of those employed at other vocations during the day, and bid fair to attract the attention of those seeking quick returns from a small outlay.

Attention to recognized habits of the birds, sanitary conditions and good breeds for parent birds are all that is necessary to success.

ACTUAL TESTS CONVINCED THEM.

In Appendix A in our *Manual*, we tell of a sale of our Homers which we made in February, 1903, to a ship captain, who intended to sail from Boston around Cape Horn to the Pacific coast, with stops, the whole voyage to be made in about a year, the pigeons to furnish fresh squab meat for the long journey. The ship went to Florida, from Boston, thence to Rio de Janeiro, Brazil, safely, and sailed from there October 1, 1903. Under date of June 22, 1904, the Captain wrote us as follows from New York City: "The birds proved all you claim for them, and even more. I put them in a small house I built, four by eight, and four by four flying pen, on March 7, 1903. (This was on the deck of the ship.) They all hatched before April 6, and up to June 5, 1904, every bird had hatched twelve times, and one pair thirteen times. I saved one pair of the first hatches, that were born about April 6, and in October they hatched their first pair, and up to June 5 had six hatchings, which I think was pretty good. I am satisfied that if the birds are taken care of there is big money in them, and just as soon as I can get a location in New Jersey, near New York City, I will send to you for two or three hundred pairs. I have an option on a place now and will know tomorrow. I am pretty sure I shall get it and by next Monday I am in hopes to begin my houses. As soon as I get them ready, I will send you a draft for what birds I want. As my houses are built I will order and fill them and I hope you will try and give me a good lot of birds. I will build for one thousand pairs this summer and increase next year if the birds are as good as these

you gave me. In two weeks you may expect to get an order for two hundred pairs, so you can begin to get them paired off. Any suggestion you can give me about the houses will be very acceptable, as I am going to begin to build at once."

Since the above was written, he has built his first house and we have shipped him the first large lot of birds. His experience is certainly convincing. Any one who has doubts can start with a small purchase of birds and find out the facts for himself, just as this customer did.

We are continually filling large orders for customers who started with a small purchase and did well. Why don't you start with two dozen or so pairs and have the experience of this Michigan customer whose order we received this summer: "A short time ago I received twenty-five pairs of your Homers. They are all doing finely, every bird being lively and full of vim. They are almost all at work now, nest-building, and I am more than satisfied with results thus far obtained. I am about to build two houses, each house to accommodate two hundred and fifty pairs, divided into five flocks of fifty pairs. Enclosed find New York draft to pay for four hundred and fifty pairs Extra Homers."

Under date of July 1, 1904, a customer writes us from an Ohio town: "The Homers I purchased of you two years ago this month have been doing very well, in short, their increase has been marvelous, averaging nine and one-half (9½) pairs per year for the two years I have had them. I now have quite a flock, bred exclusively from the three pairs of mated birds purchased from you, but think it is about time to get some new blood in the flock; therefore will you kindly quote me your prices for birds from one to three or four months old, equal parts cocks and hens, so that I may turn them in with my young birds to prevent as much inbreeding as possible in that way. I want to say that I at first had some doubts as to the profits of the business, but must confess that they are even more than you have ever claimed."

Some of our most successful customers are women. One writes us this summer as follows: "Enclosed find post-office money order for \$7.08, payment for the following order: three dozen wood nappies, three bath pans, four galvanized iron drinkers. Ship by freight or express as is cheaper. Something over a year ago I bought twelve pairs of pigeons of you. Imperative duties have prevented my giving them as much attention as I would wish, but they have increased and prospered with but trifling loss. There are now more than forty pairs nesting, and altogether a flock of something over one hundred and fifty. I have sold none, not having had time even to sort them out and send them to market. I hope soon to get into the lofts and put things in first-class shape and weed out all the culls. I

am very well satisfied with my experiment."

A customer in New York writes: "There have been two pigeon fanciers here this week who say they have no such fine stock as ours, nor have they seen anything like them."

BOSTON PRICES. The squab market is improving every year, and breeders everywhere are getting better prices, even right here in Boston, the centre of the section where our business is done, and where the interest in squabs is very great. The following quotations from the Boston Daily Globe cover a period of over five years, and, as will be seen, prices are firmly maintained. New York prices are better than these:

March 28, 1903.....	\$4.00 and	\$5.00 a dozen
Apr. 25, 1903.....	3.50 and	4.00 a dozen
May 23, 1903.....	4.00 and	4.50 a dozen
June 27, 1903.....	3.50 and	4.00 a dozen
July 11, 1903.....	3.50 a dozen
Aug. 22, 1903.....	3.00 and	4.00 a dozen
Sept. 19, 1903.....	3.50 and	4.00 a dozen
Oct. 24, 1903.....	4.00 and	4.50 a dozen
Nov. 14, 1903.....	3.50 and	4.00 a dozen
Dec. 5, 1903.....	4.50 and	5.00 a dozen
Jan. 30, 1904.....	5.00 and	6.00 a dozen
Feb. 20, 1904.....	4.50 a dozen
Mar. 12, 1904.....	5.00 and	5.50 a dozen
Apr. 30, 1904.....	4.00 and	4.50 a dozen
May 28, 1904.....	3.00 and	4.00 a dozen
June 11, 1904.....	3.00 and	4.00 a dozen
July 23, 1904.....	3.50 and	4.00 a dozen
Aug. 13, 1904.....	3.50 and	4.00 a dozen
Aug. 20, 1904.....	3.50 and	4.00 a dozen
Sept. 10, 1904.....	3.50 and	4.00 a dozen
Oct. 8, 1904.....	3.00 and	4.00 a dozen
Nov. 5, 1904.....	3.00, 3.50 and	4.00 a dozen
Dec. 31, 1904.....	4.50 and	5.00 a dozen
Jan. 7, 1905.....	4.50 and	5.00 a dozen
Mar. 25, 1905.....	4.50 and	5.00 a dozen
Apr. 1, 1905.....	4.00 and	4.50 a dozen
May 27, 1905.....	3.50 and	4.00 a dozen
June 3, 1905.....	3.50 and	4.00 a dozen
July 8, 1905.....	3.00 and	3.50 a dozen
Aug. 12, 1905.....	4.50 a dozen
Sept. 23, 1905.....	3.00 and	3.50 a dozen
Oct. 21, 1905.....	3.00 and	4.00 a dozen
Dec. 16, 1905.....	3.00 and	4.00 a dozen
Jan. 20, 1906.....	4.00 a dozen
Mar. 31, 1906.....	4.25 and	4.75 a dozen
Apr. 7, 1906.....	4.00 and	5.00 a dozen
May 26, 1906.....	3.50 a dozen
June 16, 1906.....	3.50 and	4.00 a dozen
July 28, 1906.....	3.50 a dozen
Aug. 22, 1906.....	3.50 a dozen
Oct. 20, 1906.....	3.50 a dozen
Jan. 5, 1907.....	5.00 a dozen
Jan. 19, 1907.....	3.50 and	5.00 a dozen
Mar. 9, 1907.....	3.00 and	3.50 a dozen
Mar. 23, 1907.....	3.50 and	5.00 a dozen
Apr. 6, 1907.....	4.00 and	5.00 a dozen
June 29, 1907.....	3.00 and	3.50 a dozen
Sept. 28, 1907.....	4.00 a dozen
Nov. 23, 1907.....	3.00 and	4.50 a dozen
Dec. 14, 1907.....	3.00 and	4.00 a dozen
Jan. 18, 1908.....	5.00 a dozen

Jan. 25, 1908.....	\$4.00 and \$5.00	a dozen
Feb. 8, 1908.....	4.00 and 5.00	a dozen
Mar. 2, 1908.....	3.50 and 5.00	a dozen
Mar. 21, 1908.....	3.00 and 4.00	a dozen
Apr. 11, 1908.....	4.00 and 4.50	a dozen
May 9, 1908.....	3.00 and 4.00	a dozen
June 6, 1908.....	3.00 and 3.50	a dozen
July 3, 1908.....	3.00 and 4.00	a dozen
July 18, 1908.....	3.50 and 4.00	a dozen

(This edition of this Manual went to press in August, 1908. If you write us in 1909 or later for Boston quotations we will give them to you by letter.)

Sometimes different newspapers published in the same city will give varying quotations for squabs, as it depends largely on the reporter who writes them. For example, in the Boston Globe for Feb. 8, 1908, squabs were quoted at \$4 and \$5 a dozen. In the Boston Herald of that same day is the following quotation: "Squabs are high at \$5 and \$6 a dozen." On March 14, 1908, the Boston Globe quoted squabs at \$3.50 and \$4 a dozen, while the Boston Herald quoted them at \$5 and \$6 a dozen.

In every large city are published trade bulletins known as "Price Current," "Boston Prices," "Market Bulletin," "Smith & Jones Price Current," etc. In some large cities one printer will furnish a great many middlemen with the same printed sheet, putting at the head of each the name of a dealer or firm. The prices given in these trade sheets are never the true prices, but are what these middlemen would like to pay to get the farm products quoted. This is quite an important subject to farm people but we do not remember ever having seen the attention of poultry and produce raisers called to this matter before. For example, these price current sheets in New York will quote squabs at \$2.50 a dozen when the leading squab buyers in that city, such as Messrs. Silz, McLaughlin, and Knapp & Van Nostrand are paying from \$4 to \$6 a dozen to squab breeders and reselling to their New York retail trade at \$5 to \$8 a dozen. These trade sheets and the trade columns in the daily newspapers (which are supplied with quotations by the dealers) not only quote squabs at prices which they would like to pay, but poultry and everything in the nature of farm produce. Their object, of course, is to get farm produce as cheap as they can. If a producer objects to the small price they offer him, they will send him their printed price quotation sheet and write, "You will find the market prices enclosed." The producer not only of squabs but of all kinds of farm produce should inform himself of the true market and the only way to do so is to go into that market by letter, telephone or in person and offer to BUY, not to sell. When you have found out, for example, that the dealer wants \$6 a dozen for squabs which he has for sale, you can go to that man with your squabs and get \$4 a dozen. Don't let him take more than his fair share of the profits. Some of the poultry

and produce buyers are not reliable. The Rural New Yorker is a farm paper which keeps its readers posted on unreliable and irresponsible middlemen in New York State. Assure yourself that the man or firm which is going to buy your squabs is not only prepared to pay you good prices but is able to give you cash returns promptly.

The best way to sell squabs is direct to the private trade at about double what the middlemen pay. A customer of ours in Illinois who is a printer gets at the private trade by the use of a handsome circular giving photographs of squabs and telling what they are, prices, etc. He circularizes the rich residents and also sends out the circular in reply to newspaper advertisements. His plan works well and gets him the top prices. We have told many of our customers of the plan and we tell it again here so that you may get up such a circular if you wish and go after the private trade.

It will be noticed, in the above table of prices, that although the supply of squabs has greatly increased during the past five years, the demand for squabs created by our advertising has more than kept pace with it. Prices at this writing (1908) are as high or higher than we have ever known them.

BUSINESS MANAGEMENT. Not a few breeders raise squabs by the hundred and are successful in every detail of the management of their plant except selling the product. Some beginners seem to think they will be perfectly helpless without the co-operation of some dealer.

It is a shame to raise fine squabs and then sell them to some commission man or other dealer who immediately resells them, in most cases for double what he pays you for them. It is the steady practice of the dealers in Chicago, for instance, to pay from \$2 to \$3 per dozen and resell them for \$3 to \$6 per dozen. If you don't believe this is true, drop your role of a squab seller and go into these markets to buy and you will see how much profit is being made off your goods.

The squab dealers and commission men do not advertise for customers. The squabs are just as salable in your hands as in theirs. Many people would prefer to buy of the producer, being surer of a fresher and more satisfactory product.

If you are producing squabs, by all means sell them to the consumer and get the price which the middleman is getting. It is essential, however, if you are going to do this, that you make it known in some way that you have good squabs to sell. Think of the rich people, the well-to-do people, the good diners around you or nearest you, and figure out for yourself a way of getting to them the information that you are selling something which they want and will buy steadily. Perhaps a neatly printed circular sent by mail will do it. Or an advertisement in the

newspaper in your territory which will produce results. Or you might pick out two or three likely families and make them a present of a squab or two to get them started.

The products of the plants of hundreds of our small customers are spoken for ahead of capacity all the time by a neighborhood trade, and this is what you should aim at. This is the way the finest butter and eggs and poultry are sold, and also squabs, and the plants of our customers who are selling squabs direct to the consumer are paying better than the plants of other customers whose product is marketed with poor judgment.

Don't be too fast to sell to a hotel. Some farmers and breeders get the idea that if only they can find a hotel to take all their goods, their fortune is made. In every city there are one or more first-class hotels which want the best of everything and pay accordingly. On the other hand, there are many hotels which do not care for the best. For example, few hotels care for the best ducks, because a single dinner order is half a duck, and half of the big, first-class, expensive ducks is more than a diner wants, so the hotel keeper of course prevents waste by buying a small duck. Same with squabs. The hotel buyers are sharp bargainers, and if they think that their trade will be satisfied with a seven or eight-pound squab, they will take such a bird rather than pay more for a ten or twelve-pound squab. The average squab breeder, like the average farmer and gardener, is content to sell to the middleman, and if you make the acquaintance of a good one, of course you avoid some bother, yet it has been our experience that it is just as easy to sell squabs to the consumer as to anybody else, in fact, after you have started with him he will come after you and pay you a great deal more than anybody else, still he is paying just what he always has paid, and he is better satisfied. Squabs are phenomenal sellers and it is well to take advantage of this condition, which is not always true of poultry.

MR. MCGREW CALLS. The following is from the pen of Mr. T. F. McGrew, associate editor of the *Feather*, poultry editor of the *Country Gentleman*, also a widely quoted writer for the government's bureau of animal industry, and a lecturer for the New York State Board of Agriculture. He is one of the best known judges of poultry and pigeons in the United States. The visit to our farm of which he speaks was made in November, 1903; since then our stock of Homers has been increased.

"It was our pleasure within the last two weeks to visit the home plant of the *Plymouth Rock Squab Co.*, at Melrose, Mass. We were beautifully entertained by Mr. Elmer C. Rice and his family. The buildings at the home plant are by far the best that we have ever seen for squab growing. Each building is

constructed for the best possible light, air, and sanitary conditions. Those who may be interested in squab growing will find it to their profit to communicate with Mr. Rice at Boston for the printed matter which gives a full description of his plant and methods of doing business.

"We saw at this plant 12,000 full-grown, well-matured Homing Pigeons ready for distribution for growing squabs. In all our experience we have never seen a better lot than these. They are large, vigorous, full-breasted, broad-shouldered specimens such as one would select for producing squabs of the best character. There are Blues, Blue Checks, Silvers, Reds, and mixed colors such as would naturally be produced through the cross mating of any of these varieties. While we were there Mr. Rice shipped from the plant between five and six hundred birds, all of which are sent out in large roomy baskets, the baskets returnable at the shipper's expense. So far as we can calculate, we are under the impression that Mr. Rice is doing a very large business. In addition to this we carefully perused a number of letters received by Mr. Rice from localities as far west as San Francisco, as far south as Florida, all of these communications speaking in the highest terms of the shipments made to them by Mr. Rice."

RUNTS NOT DESIRABLE. From the *Farm Journal*—"Our remarks in the October issue respecting the relative merits of large and small birds were put in a way to be easily misunderstood.

"By large birds we meant Runts and that class, usually found only in the hands of fanciers and experts in pigeon breeding. They are not at all desirable for squab breeding.

"Common pigeons are not hardy and prolific in proportion to their smallness. The largest of these should be selected for breeding always.

"There is a great difference in the size and quality of what are called common birds. Where they are chosen as the basis of a squab breeder's business a careful selection should be made.

"Of all the pure-bred types, we know of nothing superior or equal to the Homers for breeding squabs. They are hardy and prolific and rear large, meaty squabs. There is also room for selection in Homers, some being much larger than others.

"When a breeder already has a flock of common pigeons he can greatly improve it by the infusion of Homer blood."

USEFUL MESSENGERS. We have quite a call for our birds from physicians having a country practice. They leave two or three birds at a patient's house to be let loose when the doctor's services are needed. In cases of expected confinement at a distance of several miles from the doctor's home, our

birds are extremely useful. We earnestly advise country physicians with a wide territory to cover to look into this matter and communicate with us. It will be money in their pockets.

DEMAND IN COLORADO. We have had the same experience with the Western trade as the following writer in the *Western Poultry World*, of course excepting California, which is one of the best squab markets in the country. What he says is conservative and sensible and bears out what we have always maintained, that wherever there are men and women who are good eaters, there squabs will be eaten. If you live in a town where a squab never was seen, but where there are people who set a good table, to them you certainly can sell squabs:

"Having been asked by your editor to write an article on pigeons or squab raising and also having said I would, I commence by stating a few facts which I have gained from both practical experience and inquiries from Eastern breeders. In the first place, I want to say that little is known of this industry in the West, and in fact it has not been known in the East until about ten years ago, when they began to take it up about the same as the Western people are doing now. Many got discouraged at finding it was not a get-rich-quick scheme.

"I am constantly having letters from different parts of the country asking me if squab raising pays, and saying that from inquiries they have made at meat markets and of commission merchants, they are told that there is no demand for them. Of course there is not at the present time, for if there was they could not get them. No man can sell what he has not got. I once went to a gentleman and told him my plan of starting a squab farm, and he in turn went to his market man and asked him what he thought of it, and he said I was either lazy or crazy. Now this man knew absolutely nothing of squabs, and never had any in his store, and consequently, never had any calls for them. I dare say that if one were to go to every market in the city they would tell you the same thing, and nine out of every ten people would tell you they had never eaten a squab in their lives; still I have people—come right to my door—who come a good distance out of their way and want to buy squabs of me. The reason hotels and restaurants do not continually have them on their bill of fare is because they cannot be supplied at all times. Today they can get perhaps a dozen and tomorrow, if they wish any, they cannot get them, and even then they are obliged to take common squabs and not Homers. As to the demand, I want to say right here, that I know one concern that will contract to take **400 dozen a week** at good, fair prices. Two parties that I know of right here in this city are constantly in receipt of letters from hotels and clubs in Denver wanting to buy squabs.

In the East, where there are ten squab farms to one in the West, the prices are higher than here. It is because of the demand."

ELEGANT PROFIT. The following is from *Vick's Magazine*, an article on squab raising by a practical breeder:

"Of recent years the demand for the toothsome squab has been so great that the supply does not come up to the demand. Where years ago they were used only for invalids, now they are on the bill of fare in almost all restaurants and hotels. They command good prices at all seasons and an elegant profit is derived from them by the raisers. It used to be that pigeons could not thrive when housed up, but now the former obstacles have been overcome and better success is made where they are confined than where they have their freedom.

"The squab business if conducted properly will bring in a large percentage of profit considering the first capital invested. Only a few hundred dollars are required to start where such a sum would be nothing to commence in such a business as stock keeping, etc., and yet with a few hundred pairs of pigeons any one with a little judgment can make a living for himself and family. Many farmers' sons could make nice yearly incomes by stocking a part of their barn (not used for anything else) with pigeons. The risks are not so great as with chickens, but the birds must be attended to and not neglected.

"With chickens one must not only feed the old, but must also give the little ones their meals, but not so with pigeon breeding. You feed the old birds, and they feed their young. One person can feed a thousand pairs of birds in about a quarter hour, the rest is left for the old ones to do. The little birds are fed from pre-digested food from the crops of their parents, who by a sort of pumping force the food into the squab's mouths. It takes no longer time for a person to feed a lot of birds with young than it does without young.

"After the squabs are four to five weeks old they are ready for market. It costs but one and one-half cents per pair for feeding birds a week and their young also, so with the prices received for the squabs, which is forty cents per pair in summer to eighty cents per pair in the winter, one can imagine the percentage of profit.

"Squabs of the largest size demand the highest market prices, so it pays to commence right by buying only good large stock. The amount of labor required is almost nothing, in fact unless very large numbers are kept, one will have only a few hours' work daily. The writer has nearly 2,000, and it takes only fifteen minutes to feed and half an hour to give fresh water. Of course it takes a day or two a week for killing young ones, and a day or two each month for cleaning buildings, then the work is about done. One person can attend 1,000 pairs nicely and have ample

time to do other work around a place. The writer finds it a snap to other occupations and one is his own boss and can go or come when he pleases. It is the business for a young man; he can advance as he saves money. There are some who commenced on a few dollars and by careful saving now operate plants of thousands of pairs of birds.

"The larger the pigeon, the larger the squab, the higher the price. The breeding houses need not be heated artificially in winter as the birds can withstand any temperature and in cold weather sit upon their young until they are feathered sufficiently to stand the cold."

ENLARGED HIS PLANT WITH PROFITS. Experience of a Breeder who Made it Pay from the Beginning. In *Country Life*, a monthly magazine, one of the handsomest and highest-toned publications, the experience of a gentleman in squab raising gives the following facts: "Six years ago I did not have a bird, but I invested fifty dollars in purchasing twenty-five pairs of extra-choice Homer pigeons, remodelling a poultry house for their accommodation. I had kept pigeons for pleasure for five years, previously, and felt that I knew a little about them. In these six years I have not invested another dollar excepting the dollars the birds have earned, and my present establishment of five houses and fifteen hundred pigeons, which has cost me two thousand dollars, is all paid for. In addition, for the last three years, I have paid out from five to seven dollars each week for the wages of a helper, to dress the squabs and clean the houses, for my regular business would not permit me to attend to these duties myself.

"The consensus of opinion of all experienced squab breeders stamps the Homer as the best pigeon for this purpose. This variety is strong and vigorous; a hearty feeder and good worker; bright-eyed, alert, and active; stocky, symmetrical and full-breasted, which counts so much in squabs. They are also prolific, and their squabs are full-feathered and fit for market in four weeks.

"I was very fortunate in getting my first twenty-five pairs of birds. These were Homers, full-blooded, and had established records for flying, having taken first honors in several contests.

"They not only averaged me seven and one-half pairs of squabs a year, but stamped their vitality on the birds I have selected from their young.

"As my profits accrued I purchased straight Homer stock, picking from the best near-by breeders, as well as those of established reputation at a distance.

"I always put a lot of new birds in a clean coop by themselves, give generous supply of feed and water, and have plenty of nesting materials in the coop, and if they have come from a distance put a good poultry powder in their feed for the first meal, and let them

alone for a few days. If they are strong, healthy birds they ought soon to begin to carry materials and build nests. When nest building is fully under way I transfer each mated pair to permanent breeding quarters. When I find a pair of birds mated, I call my assistant and tell him which bird to keep his eyes on, and not to lose sight of it a single instant. At the same time I note the other bird and catch it. I pass the caught bird to the assistant. He points out the other bird and it is soon caught. I band all purchases as well as those I raise.

"My weekly expense for feeding my flock of fifteen hundred pigeons during the month of December, 1903, was eighteen dollars and thirty cents for the following: Three hundred pounds of cracked corn, three bushels each of wheat, peas and kaffir corn, one and one-half bushels of millet, one bushel of hemp and half a bushel of cracked rice. The rice I do not feed regularly, but give when the bird's bowels are loose, for which condition it is an excellent corrective. Feed is now much higher than last year.

"Pigeon-keeping for squabs may fitly be termed a twentieth-century industry, for only during the last five years has it by its rapid development attained to the dignity of a special business. The business will surely still more increase during the first decade of this century. The price of squabs has been strongly maintained during the five years just passed, notwithstanding the marvelous increase in the business. The business furnishes a way by which either men or women (for many of the latter have successfully taken up squab raising) can embark in an enterprise which does not call for severe bodily exertion and which if intelligently managed will yield good dividends."

SQUAB RAISING ON THE FARM. Pigeons Kept in the Upper Part of Duck and Poultry Houses.—The following is from an article in the *Country Gentleman*, entitled "A Combination Plant, Fruit, Bees, Fowls and Squabs":

"For growing squabs some have separate houses, some use the lofts of old barns, and many are so constructing their poultry buildings as to have quarters for growing squabs in the second story of the poultry houses. This is gained by laying a flat roof on top of the poultry house, on top of this a double thickness of tar paper well coated with hot tar, with a board floor laid over it. This provides the floor for the pigeon house, the roof for the poultry house, and makes it absolutely vermin proof both ways. A large duck grower of our acquaintance has squab houses of this character built over his duck brooder houses and his poultry houses. Several thousand pairs of breeding pigeons are kept in this way, with a hanging outdoor flying aviary for the pigeons. When it has been successful on so large a scale, smaller growers need not hesitate in adopting such a plan.

"Of course cleanliness, care and sanitary conditions about the plant are imperative. The most successful squab growers do not scatter sand or dirt of any kind on the floor or in nest boxes. Neither do they use anything but straw for the birds to build their nests. The droppings are all thoroughly scraped up from the board floor, from the nest boxes and under the perches once or twice a week with a hoe, and stored away in bags and sold at 50 to 60 cents per bushel. They are used by tanners in making the very best grades of leather. These droppings are of no value when mixed with tobacco stems, shavings, sawdust or sand. Grain or feed of any kind if mixed in with them will not injure their value, nor will some little straw or feathers count much against their value. Buy a good sharp hoe; floors constructed in this way can be thoroughly cleaned by scraping up once or twice a week, and in this way the sanitary conditions will be of the very best.

"Those who do not care to dispose of the droppings in this way in some instances spread from six to eight inches of soil from their land over the floor of the squab house. This is allowed to remain from three to six months. Usually at the end of the moulting season all the nest boxes and the whole house is thoroughly cleaned out and the entire contents of same dumped on the floor, scraped and hauled away and scattered over the land. This makes an excellent fertilizer. We know of one instance where a large number of squabs are kept in this way, and the house is cleaned but twice a year. In the spring all the cleanings from the house are hauled out and spread over the land for the growing of summer crops. After the fall moult, the place is thoroughly cleaned up for winter, the cleanings of the house are stored away in a dry place and retained until spring. Many persons would call this a filthy, unhealthful way to keep a squab house, but some of the most successful breeders follow this plan. The presence of the five or six inches of dry soil on the floor keeps it in good condition throughout the season. The cloud of dust that is raised at times by the pigeons flapping their wings and flying about is almost a certain guarantee against insect attack. However, we do not advise this method. We simply give the facts as we have seen them.

"The only limit to the extent of such a plant is the ability of those who possess it properly to care for and manage all its branches at a profit. Where there is a family of boys and girls it might be well to engage the attention of all in growing these several kinds of products, and to lend encouragement to each by giving him a share of the profits. Scattered all over the country are thousands of families in country places continually worrying and wondering why they cannot keep their children at home. The real reason so many of the young people

leave the farm is that they are compelled to work continually and never receive any portion of the income for their labor. If the parents would allow their growing families to make an equal sum of money or in proportion to what they can make by leaving home, there would be far less complaint on this score. All children wish to have the privilege of earning a few dollars that they may call their own."

The following paragraph is from the same paper in its report of the New York pigeon show, January, 1904:

"There seems to be a depression in the sale of high-class pigeons. Well-favored specimens of the highest character still sell at top prices, but the absence of any commercial value for a large number of pigeons that are grown detracts from the numerous sales that their producers might have. If producers of the hundreds of varieties of beautiful pigeons would turn into the market as squabs the greater part of all their product that was not valuable for the exhibition room; greater returns would come for those which were saved for exhibition purposes. There is a grand stride forward in growing squabs. The combination of poultry-growing with squab-growing works well, and is being adopted by so many small farmers as to create an unusual demand for all grades of pigeons that are good for this purpose.

"It is well for those who go into the squab business to remember that the price is graded by size and quality. During winter squabs that would average eight or nine pounds to the dozen have sold at retail in the New York market at from 35 to 40 cents each, while those which averaged two or three pounds less to the dozen sold at from 12½ to 20 cents. It takes quite as much time and as much care and food to produce the small specimens that bring the lower prices as it does to produce the higher grades which bring the better prices. People are beginning to find this out, and taking advantage of the knowledge, are looking about for the best quality of pigeons to produce the best market squabs."

SQUAB PIN-MONEY. The following paragraph appeared in the January, 1904, issue of the *Designer*, a monthly magazine for women published by the Butterick Publishing Company of New York City:

"A young woman of my acquaintance has kept herself supplied with hats, boots and gloves during the past year by selling the squabs of six pairs of Homer pigeons. They require very little care, and the young are ready for market when four weeks old. My friend is so well pleased with her success that she has added seven pairs to her stock, and confidently expects to dress herself completely on the sum derived from the sale of her squabs.—M. P."

THEY FLEW HOME. A dispatch from Paris, printed by the *Baltimore Sun*, says:

"A man named Maraud complained to M. Brunet, Police Commissary for one of the districts on the south side of the Seine, that he had been robbed of six valuable carrier pigeons and said that one of his friends had seen them at the house of another man.

"The magistrate went to the place indicated and there saw some birds. 'How did you come by them?' he asked of the man. 'Oh, I bought them months ago,' was the reply.

"Well, bring them to my office," said Mr. Brunet. There he had a wax seal attached to each bird's leg and the birds liberated.

"They flew back to Maraud's house and an hour later the thief was on his way to the police depot in the 'black maria.'"

SQUAB INDUSTRY'S GREAT GROWTH.
Address Delivered Before the New Jersey State Board of Agriculture. Years ago when poultry and egg production was being first advocated extensively, there were many fears expressed that the business would be overdone, that chickens and eggs would come to be common and low priced, and the fear that there would be no money in the business no doubt kept many out of it. Nevertheless, more and more have gone into poultry and eggs year after year, and millions of dollars' worth of both are marketed yearly. Whole communities, like Petaluma, California, are given up to poultry and eggs. Eggs got as high as sixty cents a dozen in the large cities the past winter (1904).

Some people not informed as to squabs think that if many go into squab raising the prices are going to drop until there is no profit in the business. On the contrary, prices for squabs have been increasing every year here in the East, and they are going to increase in the West in the years to come. Consumers who have read our advertising all over the country are eating squabs who never ate them before, and the effect of our advertising on the general squab market everywhere has been to boost prices. Well-to-do people who are led to get into the habit of having squabs on their tables keep on ordering them, and tell others, and thus the market grows.

If all the Homer breeders we have sold during the years we have been in business were concentrated in one plant, we could sell the entire squab output of that one plant to any one of a hundred commission men in one of the large cities.

New Jersey is doing well with squabs. Other States, notably California, Iowa, Wisconsin, Michigan and Massachusetts are producing a great many. Just what is being accomplished in New Jersey comes as a surprise to people who look upon this business as something new and untried. At the annual meeting of the New Jersey State Board of Agriculture in January, 1904, an address was given by Mr. G. L. Gillingham on squab raising, in the course of which he said:

"The production of squabs for the markets

of our large cities is an industry that is reaching considerable proportions in this State. And, although it is growing yearly, yet the prices seem to be advancing; showing that there is an unlimited demand.

"The great scarcity of game all over our country compels the keepers of first-class hotels and restaurants to look for something to take its place, and at the same time be sure of a supply at all seasons of the year. Therefore they have hit upon the squab to fill this void, and now when one calls for quail on toast, or order of a similar nature, it will very often be found that the quail was raised in a pigeon loft, and is much younger, more tender and juicy than the quail would have been, could it have been secured.

"This is a business that can be carried on in connection with poultry raising, and is one that may be conducted upon village lots by women and young persons, if need be, and by those whose other business takes their attention during the middle portions of the day, as the labor connected with it is not heavy. It is particularly adapted to women who wish to add something to their income. In fact, women are more apt to succeed in it than most men, as it requires close attention to the little things, as it is the many little things that go to make up the final profits at the end; as women are generally more patient and thorough with small details they will be more successful.

"The extent to which this business is conducted in some parts of our State may be shown by stating that in one town in Burlington County of about 3000 inhabitants, the purchase of one dealer the past year was 56,582 squabs, for which he paid \$16,400; while another dealer bought perhaps a little over half as many more, bringing the aggregate to 86,000 squabs, for which the people of that town received nearly \$25,000; while another single grower in the same county shipped from his own lofts between 13,000 and 14,000 birds.

"The cost of feed and care for a working loft of pigeons is about \$1 per pair per year (manure not sold). Some put it much lower, but at the present prices of feed, if proper care is given, we should not figure much lower than \$1. A good pair of birds will produce from seven to ten pair of squabs per year; generally an average of not over eight pair. The prices have ranged the past year from 25 cents for the poorest, to as high as 75, 80 and 90 cents for the best. Putting the number raised at the lowest (seven pairs) and the average price at 40 cents, we have \$2.80 for the \$1 invested yearly after the first cost of investment for buildings, etc., which need not be expensive, according to the taste and means of the builder and the amount of capital he wishes to put into it. The houses should always be placed where the drainage is good, preferably upon a dry knoll, facing the south or southeast. Some paying lofts have been made by fitting up unused wagon-

house or wood-house lofts, or over hen houses. Other houses have been constructed for poultry on the ground floor and the story above for pigeons. In this case great care must be exercised to have the floor well laid with planed and grooved flooring, to keep vermin from passing up from the poultry.

"Very large flocks should not be kept in one room. From 50 to 100 pairs are enough to keep together for the best results, preferably the former. A room 10 x 12 is ample for 50 pairs of working birds. A house may be built of any desired length, 12 feet wide and divided into apartments of the above size by wire partitions with doors hung on spring hinges, to facilitate passing through in feeding.

"These houses should have windows on the south, of sufficient size to afford ample light in all parts of the house and no more, as too much glass makes the house too cold on the winter nights.

"As each pair requires two nests, as they are generally sitting in one while raising young in the other, there should be twice as many nests as pairs of birds, with eighteen to twenty to spare, that they may take their choice.

"The period of incubation is eighteen days, the hen bird sitting on the eggs, excepting about four hours each day, when the male takes her place, while she is feeding and resting.

"During incubation a substance forms in the crop of both birds, known as pigeon milk or curd, on which the young are fed for the first five or six days, until they are old enough to digest the grain, which is carried to them in the crop of the old birds, and ejected from their mouths to the mouth of the young bird by the same process as the pigeon milk is fed in the first place. Hence it is important that the proper feed be given, which should consist of a variety of grain and seeds, the larger the variety, the better. These should consist of cracked corn, rather coarse (preferably about three or four pieces, from a single kernel), with the fine sifted out. This should be kept before them in troughs or hoppers, so constructed that they cannot throw it out and waste it, which they will frequently do in search of other grains of which they are more fond. The other seeds should consist of whole corn, Canada peas, Kafir corn, hulled oats, millet and hempseed. These should be fed on the floor twice daily, just what they will clean up quickly, feeding the hempseed but twice or three times per week, except in the moulting season, when a small quantity may be fed each day, as hempseed is very fattening, and when fed in excess bad results may follow. Do not feed wheat too liberally, and always mixed with other seeds, using the hard, red wheat and never new wheat, as it has a tendency to loosen the bowels of the young birds with sometimes fatal results. In connection with the feeds, the birds should be furnished with ground

oyster shell for grit, also a liberal supply of salt and small bits of charcoal and gravel. The salt is necessary to keep them in good health. These substances may be kept in small boxes around the house where the birds can have free access to them.

"A generous supply of pure water should be kept before them at all times near the feeding trough, and should be supplied each morning before feeding, that the old birds may have access to it immediately after feeding, before taking the feed to their young.

"In stocking the houses, always avoid using common breeders, as the results will be disappointing. They are not prolific and are more liable to produce dark squabs, which always bring the lowest price in market, and do not feed the young as well as the full bloods. The best all-round birds for squab raising are the straight Homers, as they are the most active, good workers, quiet disposition, and the best of feeders.

"The Runt is the largest of pigeons, but a very slow worker, seldom producing more than four pairs of squabs per year. It makes a good cross with Homer and Dragon, but even then will not produce as many birds as either of the others alone.

"The squabs are dressed for market once a week, on regular shipping days. They are dressed just before they are large enough to leave the nests, and when they are full-feathered, and should weigh at this time eight pounds per dozen, this size commanding the highest price, the prices falling off very fast as the size drops from this weight. The squabs should be dressed with empty crops. They may be caught in the early morning before feeding, and dressed, or caught the evening before, after the old birds have fed them for the night, and kept in hampers until morning, when their crops will be just in the right condition.

"After the young birds are two or three weeks old, the old birds build another nest and begin to sit again, the male bird taking most of the care of the young until they are ready to dress; hence the importance of supplying two nests for each pair. Thus a good pair of working birds have a pair of young and a pair of eggs a large portion of the time.

"During the summer months the birds should be furnished with a shallow tub of water in which to take a bath, two or three times per week, which will help them to keep free of vermin. These tubs should be emptied after they have bathed, as they should not be allowed to drink the water in which they have bathed.

"With good care, properly constructed houses, wholesome food, never sour or tainted, very little disease should be encountered. Prevention is better and more easily administered than cure. Some of these are dry houses, pure water, regularity in feeding and cleanliness. The water buckets should be washed out frequently with creoline water,

made by adding a teaspoonful of creoline to one quart of water. This will kill any disease germs that may be present, and is a good disinfectant.

"Give good care, not neglecting the small things, as it is the multitude of these wherein the profit lies.

"The demand for squabs is constantly increasing and any one entering into this business and willing to give it the attention it requires will always find a profit on the right side of the ledger. But remember this profit will be according to the care and intelligence put into the business."

NEW YORK MARKET. The following is taken from the New York World, an article on squabs, published in August, 1904:

Squab-Raising as a Fine Art.—Game Laws Make Propagation of this Small Bird a Remunerative Business.—Palates Demand Substitute for Quail and Other Morsels that Statutes Forbid.—Few persons, even among the devotees of late suppers in New York's high-priced restaurants, in looking over their elaborate menus and selecting, say, a squab on toast, realize what a tremendous industry the Broadway taste for a large cold bottle and a small hot bird has developed in the United States in recent years.

The industry may, indeed, be considered in itself in a squab state, but such has become the after-theatre demand for the tasty little birds that many business men have turned from less lucrative pursuits to devote their energies to their raising.

It would be impossible to state precisely how many squabs are annually bred in the United States, but it is estimated that hundreds of thousands reach the tables and tickle the palates of luxury-loving and extravagant people.

The best of judgment in regard to quality and quantity of feed is essential, cracked corn and red wheat being the staple food. Kaffir corn, Canada peas, buckwheat and millet comprise about 20 per cent of the food in winter, and in the summer less corn but more wheat. Grit and salt are before the birds always.

At the age of four weeks the squabs are ready for market and are deliciously tender, as they have never learned to fly, and their muscles have not had the hardening influence of exercise. The killers now get busy. With a slip-noose around the feet, and wings locked on the back, the squabs are suspended from a rack. A killing knife is inserted well into the mouth and a quick, deep slash made at the back of the throat, allowing the bird to bleed freely.

An expert can kill and rough pick about four birds before they get cold. The squabs are next dropped into a galvanized iron tub, through which a constant stream of water flows, which cools the birds. Then a small hose nozzle is inserted in the mouth and water allowed to fill the crop, after which it is with-

drawn and a quick pressure forces everything out. A second use of the hose thoroughly cleanses the crop. Two more immersions in iced water make the birds ready for local shipment.

In the Lenten season commission houses buy and ice thousands of dozens of squabs for winter trade. That is also the time squab raisers select and save the best stock for breeders.

Many of the live birds, especially the Homers and red Carneaux, cost from \$2.50 to \$6 per pair.

Prices for squab in New York City run from \$4 per dozen in the early season to \$5.50 and \$6 in the winter.

TWO YEARS' EXPERIENCE WITH OUR BIRDS.

Will you kindly send us price-list and such other printed matter as you have issued within the past year? You will remember we bought six pairs of you one year ago last July. We have about 124 now and are disposing of all the squabs we can raise at three dollars per dozen. All of our birds are not laying yet but will soon mature. We have lost several when they were young birds, then we had some stolen (one of which came back). One bird had a peculiar substance form around the outside under the bill. Will you tell us if this was canker? We disposed of the bird at once. We did not try to treat it at all. The people here know very little about fine squab, but I believe the market is growing better right along. Feed is much higher here than in the East. We have to pay \$1.75 per 100 for cracked corn, \$2.15 for red wheat, \$1.75 for Kaffir corn and about \$5 for hempseed, so that \$3 per dozen does not bring in a very large profit. Would you advise our raising the price? We hope to send you another order shortly. We have not tried to use the manure at all. We have had no trouble with our birds as to vermin. They seem to keep entirely free from it.—Mrs. H. D., State of Washington.

TO MONTANA IN GOOD ORDER. I received the crate of pigeons yesterday. They were all alive and in good health.—J. F., Montana.

FINDS OUR BIRDS FAST BREEDERS.

On September 16, 1902, I ordered six pairs Extra from you and now (August 30, 1904) have about two hundred old pigeons and squabs together, and will want to begin shipping a few before long. Wish you would please give me the names of a lot of desirable squab buyers in New York and other nearby cities. Do you think prices will be better later on in the fall, and which is the best way to ship them, dead or alive? Can I get shipping crates already made? If so, where, and at what price? Thanking you in advance for this information.—W. E. H., North Carolina.

HAD NO TROUBLE RAISING THEM. Last spring, in April, I think, we bought twelve pairs Extra for thirty dollars of you. At present we have eighty-five in all, or about sixty young birds that we have raised ourselves. We would not think of selling them as we have had very good success and are much interested in the business, but through sickness I lost my former position in this village and have now secured a permanent one in Chicago, and expect to move there in a few weeks. Expect to locate right in the city and consequently will have no facilities for keeping the pigeons, and so am anxious to sell. The birds are as healthy as when we received them, as we have followed very carefully the rules laid down, in caring for them, and have never seen any signs of disease among them. Have lost only comparatively few, and those were small ones which were neglected by mother birds, or by some accident. Quite a large number of our young birds have mated and have bred the latter part of the winter.—R. F. G., Michigan.

GETTING SIX DOLLARS A DOZEN. Two of the six pairs have now hatched out three squabs, two on February 4 and one on February 7 (the other egg evidently was chilled by the extreme cold weather). The market price in Newark is six dollars a dozen, and we have contracted to sell these three squabs at that price. They are fat and very satisfactory. We are very much encouraged and wish to increase our flock.—F. C., New Jersey.

THE TRUTH ABOUT THE MARKETS. I received your Manual and have read it through very carefully. I have found that it tells the very truth. I was in Washington Market and there they told me just the same. They will take all the squabs I can give them. I think I will give you an order next month for 48 pairs Homers and one gross nappies.—H. T., New York.

ATTRACT ADMIRATION IN CALIFORNIA. Birds arrived on the 11th safe and in first-class condition for the length of their trip. I am well satisfied with the birds and expect to give you an order for more before long. Every one that has seen them thinks they are fine.—E. J., California.

OUR METHODS IN SOUTH AFRICA. Enclosed find fifty cents for which please send me a copy of National Standard Squab Book. Perhaps it may interest you to know that this is to assist in the raising of squabs in South Africa.—L. E. D., Pennsylvania.

YOUNGSTERS ARE BEAUTIES. I have fifty or more pure Homers from the original old birds purchased from your concern. These youngsters are beauties between the ages of six months and one year.—B. R. D., Long Island.

IN PERFECT CONDITION. My mother bought one dozen pairs of your birds a year ago and now has about sixty in flock. They have been well cared for and are in perfect condition.—T. A. B., Kentucky.

A NEWS-AGENT'S SIDE LINE. I have been doing a little business that I did not have time to tell you about in my last letter. I have boys in several of the towns around here to get squabs for me and I have made arrangements with the above firm to deliver those that I don't sell myself, on commission. The hotel has an order for 150 per week. Besides this order I sell to several restaurants and let the market deliver to the houses. I am the only one here who buys squabs to any extent, and average 200 to 300 per week. I make from \$5 to \$7.50 each week this way, besides what I make on the train. How is that for a news-agent running a train every day from 11 p.m. to 1.15 a.m.?—B. D., Texas.

HAS OVERSOLD HIS SQUAB CAPACITY. Could you supply me with two dozen first-class squabs for shipment from Wooster on or about December 22? I have an order for that amount, and while the birds I purchased from you are doing fine, I will not have enough. Have orders for breeders and squabs enough to keep the flock working overtime until spring, at which time I expect to enlarge my plant to at least 500 pairs. I could of course fill this small order from nearby markets, but Homers are Homers, and I don't care to depreciate the value of my flock by shipping inferior squabs.—C. L. Z., Ohio.

THE MAN HE WORKS FOR IS MAKING MONEY WITH OUR BIRDS. I see in the Poultry Keeper that you offer a squab book free, so I would like to have one, for I have squabs myself and I would like to learn how to raise them. I am only a boy and I am working for Mr. Fairbanks on his farm. He told me that I could write to you and ask you for a book. I know the chicken business very well, but not the squab business. Mr. Fairbanks bought pigeons from you last year (eighty pairs Extra shipped August 4, 1902), and he is doing fine with them, so good-bye and don't forget the address. That penny is for a stamp, and the other stamp is for the letter.—W. H., Missouri.

A LONG SHIPMENT IN GOOD ORDER. Your two letters dated January 27 were received yesterday, February 1. I went to the express office early this morning and found the pigeons had arrived in the night. The birds are all alive and in fine condition but two, one of which was bruised and I fear its wing is broken. I thank you for the extra two pairs and for the crates. I have a fine new squab house built according to your plans, only the flying pen runs up to the top of the roof, which I think a better

plan for this damp climate. I may send for one or two dozen pairs more by spring.—Mrs. E. N., State of Washington.

A PERFECT SHIPMENT OF HOMERS TO FRANCE. The pigeons arrived this day in perfect condition, but I am sorry to say I have neither the nappies nor the bases. I duly received your letter of December 16 which I answered at once. I have this day written to Puritan Line of steamship asking for information concerning the non-arrival of the nappies.—G. D., France (Europe).

DOING WELL. The pigeons purchased of you last fall are doing well. Am in immediate need of more wooden nappies.—F. C. J., Massachusetts.

GOT ONLY TEN CENTS EACH FOR SQUABS BUT MADE MONEY. I built two rustic seats for a neighbor for three pairs of Homer pigeons, and put them in a pen eight by eight feet. They increased at about a pair of squabs a month. We turned the young ones out as soon as they were able to fly. We soon had a flock of pigeons of about fifty or seventy-five. Suddenly we found that we could sell the young ones for ten cents apiece and the butcher took them off the nest for us. We killed the three original pairs as we did not want any in coops. I built a pigeon house sixteen feet high and ten feet square on the ground, two stories. The birds come in at the top and nest where they please. I took up a homestead seventy miles north. On this my whole family lived for most of the time. While we were away from this place, the butcher came regularly and took away the squabs and left the money or his account with a neighbor. We never kept any account of the profit of these splendid birds except last year, when the profit was \$34.50, and the feed would not amount to a dollar, as they fly out and rustle their own feed. My wife feeds them a little to make them friendly. I have a large wagon shed and they used to nest in this. I shot some of them and they have never bothered me there now for two years. They are wise and I think they can talk. As a comparison of profit between chickens and squabs, we had a coop of chickens that required constant care. After deducting \$19 for chicken feed, the profit on them was \$33. The chicken coop and corral are quite a distance from the pigeon house and the pigeons never feed with them.—W. S. M., California.

NEVER LOST A BIRD BY SICKNESS. In June, 1902 I got twenty-four pairs of you, paying sixty dollars for them. I have never lost a bird by sickness. I killed one. He was ailing and did not look well, so I killed him. This was three or four months after I got the birds. Right off after I got them I raised twenty-five pairs, then I began to kill squabs, as I had no room. I sold

the first lot of squabs in February, 1903, and got 25 cents apiece at first (this was much too low), then I sold for 30 cents apiece until May, 1903. I should say I sold in all 150 squabs up to May 1. From that time on the marketman to whom I was selling refused to give me more than 18 cents apiece, so I rigged up a new place and put forty pairs in there, then I sold a few more. Since then to now (November, 1903) have sold about 60 to 75 squabs. I have sold only squabs, but the other day I sold six pairs of breeders for two dollars a pair. All the 24 original pairs I got of you have kept working. I have three or four pairs which have made a nest almost every month since I have had them. They had eleven nests, others four or five nests a pair. I have eighty-eight pairs of breeders now. I have got confidence now to go ahead and am going to start a large plant in the country and will buy some more birds of you.—H. C., Massachusetts.

A YOUNG WOMAN'S SUCCESS. A year ago last July I received from you one-half dozen pairs and paid you \$15. I have tried to take good care of them and they have increased till now I have some one hundred young birds. I did not try to sell any of them as I wanted to let the flock grow. I took good care of the young birds mating and so there are not any of them that are related to each other now that are breeding. I had built for them a good warm house according to your directions and they have done very well. Some few died during this winter, but I think they were crowded and so the older ones would push the little fellows out of the nest and they froze during the night.—Miss E. M. C., Kansas.

A GOOD HEALTHY FLOCK. I bought 24 pairs Extra of you a little over a year ago. I now have besides the 24 pairs about 40 pairs of mated birds, all leg banded. Also I have about one hundred young birds and all but about thirty of these will be old enough to mate by the first of April. All of these are leg banded and are good healthy birds in first-class condition.—E. A. H., Iowa.

GOING TO MAKE AN EXHIBIT. My birds that I received of you in July and August are doing fine, and as there is a poultry show here in this city next month, I thought perhaps I would show a few of them. Could you give me any pointers on putting them on exhibition?—E. G., Michigan.

EXPERIENCE DEARLY BOUGHT. You may possibly think I am doing considerable correspondence without doing much trading, but I wish to get your advice in regard to a little matter. Last April I purchased seventeen pigeons of a friend of mine for \$5.95. I knew nothing except what your Manual taught me about the business. I purchased in the fall of a Westerner what were supposed

to be twenty pairs of Al Homers, but they proved to be a poor mess. The Westerner also proved to be a dead beat. The next man I tackled was in your State, who shipped me twenty-four pairs Homers for \$36. Well, at present I have fifty-three to fifty-five pairs of birds and about thirty-five to forty head of young stock. Now I see where I am lame, and where I made a big mistake in not buying your best breeders, if I had only purchased one-half the number. I wish to get rid of what I have. I have a large house and wish to fill it with the best stock obtainable.—M. D., New York.

NEW JERSEY SEES WHAT REALLY PLUMP SQUABS ARE. The 400 pairs of pigeons I got from you are hale and hearty. By actual count I have ninety-eight pairs of eggs and squabs, besides the squabs ready to kill, which number is, however, very small. Taking the lateness of the season when I got the birds and the extreme cold we have here, I think the outlook all right. What do you say? Everybody is stuck on the plumpness of the squabs when dead and their bright and fine appearance when alive.—J. B., New Jersey.

OUR PROMISES MEAN SOMETHING. Thank you for prompt, kind and satisfactory way of settlement, in answer to our letter to you. If all dealers would as satisfactorily adjust claims similar to ours as you have done, there would be a much easier feeling among purchasers. This action on your part shows that your guarantee is just what it says. Again thanking you for your business-like settlement of our claim.—R. B. M., Pennsylvania.

BOUGHT BIRDS THAT NO ONE ELSE WANTED AND FOUND THEM INDEED CHEAP. About four years ago, my son, now 16 years old, got the pigeon fever, and I must admit I caught it myself. He first put up a dry-goods box and bought a few birds. He showed so much interest in them I thought it would be a good pastime and bought him more birds, and erected a house as per enclosed sketch. Like most beginners, we wanted a variety and we were foolish enough to buy them anywhere, and presume we got what no one else wanted. We spent quite a few dollars and our last purchase was from a fellow in Pennsylvania, who had "more than he wanted," and we bought them because they were cheap, and they were cheap, or I had better say they were mighty dear. The pigeons never had a nicer home or better feed. I try to do right what I undertake, every one of our friends said we would succeed, but we made a miserable failure indeed. My wife saw your advertisement, sent for some literature, we then sent for your squab book, which we just received, and read it with considerable interest. The fever has slightly returned, not as hard as at first, but I honestly believe that

had I your stock in the first place, we could now tell a different tale. After my wife read your book, she said, "I believe I can do all right with that kind of stock myself." So I have encouraged her, as she feels that it would be pastime for our two boys, and I was certainly fond of the birds when we had them. Send along the nappies and just as soon as we can get rid of the truck we have, and straighten house up, we will be ready for the **Extra Homers**. I believe there is a great opportunity offered in squab raising, and we are going to try it.—E. G., New Jersey.

READ OUR RULES TO THE EXPRESS AGENT AND GOT A REBATE OF ONE-HALF. The pigeons came to me Monday afternoon and seem to be none the worse for the long journey. They are beauties and I find it almost impossible to keep away from their pen, but I suppose the novelty will wear away. I should have written yesterday, but the express agent had overcharged me and I wanted to settle the matter, if possible, without bothering you. I am glad to say I was able to persuade him he was in the wrong, and after reading your card he refunded half my money. Thank you for the very prompt attention you gave my order.—Mrs. R. B., Florida.

STRAIGHT BUSINESS METHODS. The birds arrived (this order was the second order from this customer, six months after the first order) in good condition, and are now housed. The birds look fine. I thank you very much for the extra pair, something that I did not expect you to do under the circumstances, as it was no fault of yours of those birds going light. I also thank you for the information and will try and save the bird by your method. To get even with you I shall show my birds to all and mention E. C. Rice. Thanking you again for prompt shipment and straight business methods.—W. D., Ohio.

AN OLD CUSTOMER HEARD FROM. I am still raising squabs and like my pigeons better than ever (this customer has been with us going on three years). Am having good success raising them all through this awful cold weather, and they seem healthier than when it is warmer. I enclose check for which please send me wooden nappies. If you have anything new in the way of literature kindly send me some, as I want to keep in touch with you. Have you supplied birds to any one around here lately? Our visit to your squab plant last summer is pleasantly remembered by wife and I.—F. L. B., New Jersey.

NICE BIRDS. The pigeons arrived in fine condition and seem to like their new home very much. Thank you for selecting me such nice birds. Hope the baskets reached you safe.—Mrs. J. P. A., Virginia.

BEAUTIFUL BIRDS GOT TO HIM QUICK.

Birds received yesterday noon, all in fine condition. Put them in their house last night. All took a good bath this morning. I thank you for your promptness and for sending me such beautiful birds. I had not expected birds so soon, but was ready.—P. M. R., Kansas.

SQUABS SUPERIOR TO POULTRY. I am an old pigeon and squab and poultry man. I have made money with squabs, and I think they are superior to poultry.—H. S., Massachusetts.

FLORIDA PURCHASER DELIGHTED.

Pigeons arrived O. K. Saturday night. I am delighted with them, and as I have followed your instructions as to building house, pen and other articles, the birds seem to be at home.—M. F. B., Florida.

THEY ARE BEAUTIES. Received pigeons all O. K. They are beauties and have begun to nest.—F. M., Ohio.

A TEXAS CUSTOMER'S APPRECIATION.

Your second shipment of Homer pigeons was received yesterday and, like the first, in excellent condition, and I am more than pleased with them. Although my dealings with you, when compared to some of your large customers, are rather insignificant, I can't allow this opportunity to pass without expressing to you my thanks and appreciation for your filling of my orders. For square dealings, conducted solely along sound business lines, you are without a peer in the pigeon world today. I most heartily recommend you to all.—S. A. F., Texas. (The writer of this letter is a well-known Texas business man, connected with one of the largest corporations in that State.)

WON SUCCESS ALSO BY DOING AS WE DO; NEVER HAD A SICK BIRD. Some time ago I bought a dozen pairs of Homer pigeons from you and paid \$20 for them, and I want to get about four or five dozen more pair, and would like to know the price you ask for them at present, so I can send the money at once. I find your book on the pigeon industry covers the pigeon business in good shape. I have always found when you start to make a new pie or cake, follow the directions of the people that have made a success. Consequently, I have not had a sick pigeon since I received them some eight months ago. The only difference I made was in the house, and in that the only difference was not to make it quite as tight as they are made in your locality. Hoping to hear from you soon.—J. W. C., California.

ANOTHER WOMAN PLEASED. The birds came on the afternoon of the 6th. They are all very handsome. Some of them are beautiful. You will be surprised to learn

that in less than 24 hours two pairs were nesting. They have been very busy all day.—Mrs. R. L. U., New York.

INCREASING FAST. Enclosed find \$1.70 for leg band outfit. I am receiving excellent results from the birds and they are increasing so fast that I find it necessary to band them.—H. C. K., Maryland.

OUR HOMERS ADVERTISE THEMSELVES. For the enclosed \$15 ship by National Express six pairs Homers, equally as fine birds as you sent on August 3 last year, ten months ago, to Ben Barber of this place.—J. B. H., New York.

MANUAL WORTH FIVE DOLLARS. I am in receipt of your National Standard Squab Book and am very much interested in the work. I find that every time I pick it up something new seems to appear. In fact, the whole subject is covered, so far as I am able to judge, and I consider the work well worth five dollars instead of your dinky price of only fifty cents. There is a squab plant between here and San Francisco, four thousand birds. Their output of squabs, twenty dozen per week, all go to the Palace Hotel, San Francisco. I think prices for squabs are lower here than in the East, still I believe there is money in it.—J. L. S., California.

ONE YEAR'S SELECTION. The number of breeders has increased to about fifty pairs from those I purchased from you about a year ago (fifteen pairs) and all are good breeders, as I have been particular to raise those from the best breeders only.—H. W. C., Michigan.

BREEDING THROUGH THE WINTER.

Several months ago I purchased from you a number of your best Homers. They have been doing fine, breeding right along through this severe weather; in fact, my flock has more than doubled.—L. Z., Ohio.

OUR MANUAL OF GREAT HELP TO HIM. Some little time ago I sent for your National Standard Squab Book and afterwards for six dozen of your wood nappies. Since then I have been keeping my pigeons according to your instructions and with great success. I had some fine, pure-bred Homers and have been getting squabs at four weeks averaging twelve ounces. I have had them up to 13½ ounces. You strongly urge the adoption of all methods that will reduce the time necessary to look after the birds, and I heartily agree with you.—C. C. C., California.

FROM A NEW JERSEY CUSTOMER

Anything new in the pigeon line? If so send it to me. I am raising lots of squabs.—F. L. B., New Jersey.

SQUAB BUSINESS A SUCCESS. My father is in the squab business in a town in this State. His business is a success, but I would like to have him give your birds a trial and so have decided to make him a present of a dozen.—H. L. T., Iowa.

GOOD WORDS FROM A COMPETITOR.

We have associated your splendid achievements and capacity with our dogged determination to remain in to the death, and by elimination have differentiated both of our establishments from the pretentious and ephemeral plants that come and go. We are a long way from feeling otherwise than modest, and yet we realize that in about eight months we have got a good plant, a good stock, a good name and a good trade, and do not owe a dollar. All the same, this has been regretfully on our sole, unaided inexperience, and your skill has been a loadstar of hope, suggesting that perhaps some day we might hit upon the course which you have taken and follow it. If this business shall ever be trustified, we shall wish to be near you, and in any event we have nothing but desire for your continued brilliant success, and that we shall be worthy compeers.—C. F., New York.

WONDERFUL FECUNDITY. Here is \$3.84, for which please send me four dozen wad nappies by Barstow's express. My pigeons bought of you a year ago are doing fine. I bought six pairs of you a year ago and have now (July 5, 1904) 175 birds. I had 100 stolen. But for this misfortune I would now have 275. I have 400 or 500 hens as well as the pigeons.—N. J. G., Massachusetts.

RAISED A HUNDRED. Will you send me your prices on grain of all kinds? My birds are doing fine now. I have about one hundred birds raised from the ones I bought of you (twelve pairs). As soon as I get started in good shape I shall buy more breeders from you. I have not sold any yet as I have been raising them.—H. A. H., Massachusetts.

OTHER HOMERS NOT LIKE OURS. I enclose my check for \$1.50 to pay for leg band outfit, and 20 cents additional for postage. My birds are continuing to do fine, and I am more pleased than ever with them. I was out last night calling on a man who claimed to have Homers. They looked more like common street pigeons than my Homers. All these things tend to encourage me, when people can breed such birds profitably. I know mine will show up much better. Please give me a few names of New York dealers in squabs.—W. M. G., New York.

PERFECTLY SATISFIED. Pardon me for not writing before, but I have been away from home since the birds came, until within a few days. I am perfectly well satisfied with the Homers you sent me. They are as fine a

lot of birds as I could wish to see. Half of them are nesting now and I think that they went to work as quickly as could be expected. We have taken great pains to make their house warm, clean and convenient. I intended to order more birds before this time but have been unable owing to sickness in my family. However, as soon as I get straightened round again I intend to order more breeding stock and work my flock up to 150 pairs as soon as possible.—L. A. C., New Jersey.

ENCOURAGED TO GO ON AFTER EIGHT MONTHS' TRIAL. Kindly quote me price on leg band outfit. I have lost the circular which you sent me. The birds I got from you last fall (eight months ago) are doing fine, one pair especially, breeding regularly four weeks. I hope to have larger quarters and will then place order for more birds.—F. J. G., New York.

A PLEASURE TO DO BUSINESS WITH US. The two dozen pairs of Extra birds ordered Thursday night arrived Saturday morning. It certainly is a pleasure to do business with you. I am delighted with the prompt service you have rendered, for which I beg to thank you. The birds are a fine lot, and they arrived all in the best condition. I am convinced that you make a special thing of each order sent you. Will return the baskets tomorrow.—E. S. F., New York.

NEVER SEEN BETTER PIGEONS. Several men who have seen my birds have said that they have never seen a healthier or finer lot of pigeons anywhere. The reason they are in such healthy condition is simply this, that I have followed your method to the very letter, and hence the result.—E. W., New York.

SEVEN MONTHS OF STEADY INCREASE. In May last I bought of you a dozen pairs of Homer pigeons which proved a great success, as I now have thirty or forty young birds flying at large. What I want to know is, can I let out my old ones? I have a fine large flying pen for them, but if you think they will stay with me if I give them their freedom, I would like to do so. They have now been in their present quarters nearly seven months.—W. L. J., Maine.

THANKS FOR EXTRA HEN. This is to advise you that our second order of breeders was received on the morning of the 24th in prime condition. We wish to thank you both for your promptness in filling our order, and also for the extra hen sent to replace the sick one of our first lot.—W. E. M., Pennsylvania.

NEVER SEEN LARGER, FINER OR MORE VIGOROUS BIRDS. The Homer pigeons ordered from you on Saturday last arrived today, Tuesday, about noon, apparently in excellent condition, and I believe I have never

seen larger, finer or more vigorous-looking birds. Please accept thanks for your careful consideration and quick shipment. For promptness you are certainly a wonder.—J. H. B., Delaware.

SHIPPED IN EXTRA FINE SHAPE. I received from you last evening at 7 o'clock 208 birds, all alive and so far as I can see in good condition. This morning one is choked and stupid, but I think will come out all right later. I am very grateful for the extra fine shape in which you crated, labelled and fitted them for their journey. I will send back your baskets this date all in fine shape. I have received everything else ordered, all in fine condition.—J. C., Long Island, New York.

SENT HIS FRIEND TO US. Please send me a pass to visit your plant at Melrose February 27, and one for Mr. Burrows. Mr. Burrows intends buying birds soon. Mine purchased last April are doing nicely.—E. L. S., Boston.

HE IS RECOMMENDING OUR BIRDS. Enclosed you will find a money order for which please send me wooden nappies. I would like to have them as soon as possible for my birds are beginning to lay. I was over to your pigeon plant in Melrose and bought a few pairs and I think that they are the real stuff. They are doing fine. Please send me a pass for two, as I would like to visit your plant again, and I am recommending your birds.—A. L. R., Massachusetts.

STARTED SMALL AND IS NOW CONVINCED. Please give me your best price on 100 pairs, giving an estimate of the weight and express charges on same. My birds are doing finely. All young birds are larger than the parent birds and workers.—G. C. D., Michigan.

THE CHILDREN ARE BETTER THAN THEIR PARENTS. I have forty-eight birds raised from three pairs I bought of you, far ahead in looks and activity of those you sent me.—Mrs. C. L. P., Connecticut.

HAS RAISED SQUABS TEN YEARS. I have received your Manual and it is beyond my expectations. I have raised squabs for about ten years from common pigeons.—J. H. M., Pennsylvania.

EXPERIMENT A SUCCESS. My husband is going into the business. He bought some Homers of you last summer and intends buying more.—Mrs. G. W. P., Massachusetts.

THEY GROW UP IN INDIANA ALL RIGHT I now (December 1, 1903) have over eighty Homers from the eight pairs I purchased from you last spring. They are all in the very best of condition.—R. T. M., Indiana.

IN FINE SHAPE ALL THE WAY TO OREGON. I write you to acknowledge the receipt of the birds. They arrived on the morning of November 18 and were turned into their new quarters on the 19th, and I guess they were very glad to get out of the baskets and stretch their wings which they did in great shape and a number of them took a bath as soon as it was presented to them. They all seem to be in fine condition after their long journey.—H. J. T., Oregon.

GOOD RESULTS IN SIX WEEKS. By actual count I find we have the following results today, six weeks after the arrival of the pigeons: Forty-two pairs of squabs and sixty-seven pairs of eggs in the process of being hatched.—I. B., New Jersey.

VERIFIED STATEMENTS AS TO COST OF FEED. My little experience justifies the statement of your book as to cost of feed. If you will answer my query as to capacity of my house I shall greatly appreciate the courtesy.—F. B. S., Oregon.

COMMON PIGEONS DO NOT PAY FOR KEEP. I have studied squabs for two years and have had good luck with them. I have read your book and think it is good. If I had a price list I would get some Homers. I have always had good luck, but common pigeons do not pay for the keeping.—H. K., Michigan.

AN ALABAMA BOY PLEASSED. The birds arrived safely on the 24th and in good condition. We think they are a very nice lot of birds. As I am a boy of only fifteen years, I expect to follow your advice given in your magazines, and would appreciate any further advice you could offer me. As I have a little more money on hand, I may order some more birds soon. Thank you for your prompt delivery.—W. L., Alabama.

THREE HUNDRED BIRDS RAISED IN LESS THAN ONE YEAR FROM THIRTY-SIX PAIRS. Our birds shipped by you February 12, 1903 (thirty-six pairs), have done very well. We have now (January 12, 1904), over three hundred and they are laying and hatching all the time. We are going to buy some more before very long and move our plant out onto our thirty-acre farm. I think we will do some more business with you. Please give us the name and address of the people who buy pigeon manure. We have some to sell.—S. M. M., Indiana.

FIVE DOLLARS A DOZEN FOR THE SQUABS PROVE THE QUALITY OF OUR HOMERS. I wrote you the first of the week for price of fifty pairs of Homers ready for hatching. Not receiving any answer, I think you did not get the letter. Please give me figures by return mail, and if you

can ship at once. The Homers I bought from you two years ago are doing finely, also those I hatched from them. They are very large and handsome. Shipped some dressed squabs last week to New York and they returned five dollars per dozen, which proves the quality of the goods. Hoping to hear from you soon.—A. C., Connecticut

OUR STOCK THE BEST TO BE HAD.

I find I will not be in the market for more birds as expected, as my flock is in good shape, but have recommended your company to several prospective purchasers. Do not know, however, what result this will bring. I am glad to say that I have every confidence in your dealings, as I am much pleased with every article I have purchased from you from time to time and will not hesitate a moment to buy stock from you if in market for same, as I believe your stock to be the best that can be had.—O. C. S., Michigan.

IN FINE CONDITION, AND PERFECT BEAUTIES.

Please excuse delay in acknowledging receipt of birds. They were delivered to me in fine condition and certainly are perfect beauties. They seem to enjoy their new quarters. I must congratulate you on your promptness in shipping orders. With me it was the quickest move I have ever seen, considering the distance. The same day I ordered poultry from a breeder in Jamesbury, New Jersey. Both letters were posted late Friday afternoon. The pigeons arrived Monday morning early, while the poultry did not arrive until the following Thursday. I was much surprised at the difference.—J. H. B., New Jersey.

KINDNESS TO A BEGINNER.

We thank you for the kindness you have shown us in our inexperience.—F. H. W., New Hampshire.

PLEASED WITH HER INVESTMENT.

Last April I purchased of you some Homers. I have had good success with them as far as the laying and hatching are concerned, and am very much pleased with my investment.—Mrs. L. G. S., Ohio.

STOCK TO BE RELIED ON.

In talking with my friend, Mr. C. F. Peters, about going into the poultry business, he advised me to write to you about the squab business, saying he knew you would do as well if not better by me than anybody, and I could rely on your stock and what you might wish to tell me about the business. I have read your works and think you have the right idea about the business.—C. A. G., Illinois.

THREE WEEKS OLD AND WEIGHED OVER A POUND. We weighed one of the first pair of squabs from the birds bought of you when it was just three weeks old, and it held the scales at just seventeen (17)

ounces. Pretty good, was it not?—Mrs. E. K., State of Washington.

A FINE LOT OF BIRDS. The last lot of pigeons which I ordered from you were received Monday morning in splendid condition after their long journey, and are a fine lot of birds. I will send you in a few days another remittance, in addition to the one already sent.—J. L. Louisiana.

SEES THE IMPORTANCE OF KNOWLEDGE AND GOOD STOCK. Just read your book and saw how foolish we were. We had seven dozen mixed birds, some common and some Fantails, and some Runts and Homers. We were ignorant about the kind, and only had about eight or ten squabs in six months, so we sold them to the first person that came. Now I would like to start fresh again and get about a dozen pairs of your Homers. What would the express be to Alameda? Kindly let me hear from you immediately, as I would like to have some pigeons.—Mrs. M., California.

DOING BETTER AS HE GETS EXPERIENCE.

Enclosed find post-office money order for which please send me leg band outfit and extra tubing. From the twelve pairs of Homer pigeons I bought from you about May 1, 1903, nine months ago, I have seventy-two birds all told, old and young, and ten pairs setting. According to this rate I ought to have, I think, at least sixty pairs by May 1. That will be an increase of five to one. I have lost so far four young birds and four settings of eggs, but I hope to lessen this this year.—E. B. G., North Carolina.

PREFERS OUR HOMERS.

I am very proud of my birds, they are so tame and pretty. I can get Homers around here, but I would rather have them all from your place. Please send at your earliest convenience.—Miss B. D., New Jersey.

NO MORE CHEAP BIRDS FOR HIM.

Herewith I enclose fifty cents worth of stamps, being in payment for one of your Manuals. In May last I started in the squab-raising business and never owned a pigeon before. I naturally have made some few mistakes, both in building a house and selecting birds. I am going to sell out if possible, if not incurring too much loss, which, being a poor man, I cannot afford to do, and if successful I shall buy land and build, and also buy the best birds I can find, even though it be only a few pairs. I now have 150 pairs all mated, working nicely, stove in house, eight-pound squabs, seventy-five cents per pair Philadelphia market. As I said before, I am poor, but not a cheap man. I want the best, which of course after giving proper food and attention, I should be rewarded both in stock of squabs and prices.—S. B., Pennsylvania.

A FRIEND'S FLOCK DOING WELL. Enclosed find express money order. I am sure you will send the best birds. I find the *Manual* very instructive. Mr. Connelley's flock which he obtained of you is doing fine.—C. L., South Carolina.

STOCK THE FINEST HE HAS SEEN. My home is in Buffalo, N. Y. I am stopping in this city (Atlanta, Ga.), temporarily. It is my intention to establish a squab plant in the vicinity of Buffalo. I have been to look over Mr. —'s plant, which is very fine, and the stock is the finest I have seen. He informed me that you furnished the stock (five hundred pairs), an entire equipment. My present intention is to start with not less than 300 pairs.—P. H., Georgia.

IN FIRST-CLASS CONDITION. The birds arrived yesterday in first-class condition, all alive. Thanks for the extras.—R. W. B., State of Washington.

A NOVA SCOTIA CUSTOMER. The Homers arrived safely today, and I am very much pleased with them. They are a fine lot of birds.—J. H., Nova Scotia.

KIND AND CORDIAL METHODS. Many thanks for your kind and cordial methods of doing business, and if I find that the conditions here are suitable to squab raising, I shall be wanting some more stock before long. So far I am very well pleased, and the birds you sent are certainly well worth the prices you quote.—D. T. S., Kentucky.

CHICKEN INDUSTRY NEEDS A MANUAL LIKE OURS. The *Manual* sent me is the most complete and concise work on the subject of squab raising I have ever read. I doubt whether there is a book written on any subject of its kind so complete in all its detail. I would be willing to give most anything for a like account of how to succeed with chickens. If you know of any such work I would consider it a personal favor if you would kindly send me the title and where to get it. I am glad to have in my possession such a book as the *Manual*, it is a pleasure to read it. Of course it's business, but I think it wonderful that you should give such valuable information to the public.—J. H. J., Pennsylvania.

SAME AS YOU SENT BEFORE. Enclosed you will find \$15 for six pairs of your best breeding Homers that breed white squabs, the same as you sent before.—F. P., Virginia.

FROM FIFTY DOLLARS TO FIFTY CENTS. Please send to us as soon as possible 48 nappies. We shall want 48 of your *Extra Homers* as soon as these nappies reach us, and if conditions prove favorable, hope to buy a thousand birds. I think there must be money in this business. I wrote a squab raiser in Iowa, asking if he would show me through his farm,

and he replied that he would for fifty dollars. I enclose fifty cents for a *National Standard Squab Book*, which kindly send me.—A. D., Minnesota.

MAKING MORE MONEY WITH SQUABS. The nappies have not yet come. I have quit the railroad and gone into the squab business. We are going to send for some of your Homers soon and let what we have breed with a few additions occasionally until the Homer trade gets rooted. I am now making more with pigeons than while working for the company, or rather, I am making a good living and putting in a large stock of pigeons.—S. D., Texas.

OUR CLAIMS PROVEN TO HIS SATISFACTION. Last February, 1903, I bought a small lot of adult Homers from your company and am satisfied they are all you claim for them. Being desirous of getting along faster in the business, I have advertised for additional capital in a *New York City* paper, and have had nearly two dozen inquiries about the industry.—A. D., New Jersey.

A HUSBAND WAITS FOR THIS YOUNG WOMAN. November, 1902, I bought twelve pairs of your Homers; now I'm sorry to say I must give up the idea of the squab business, and wish to know if you care to buy them and what you will pay. I have ninety birds, and sold some last summer. I think your birds have done very well. I would not have anything but your *Plymouth Rock Homers*.—Miss E. J. D., New York.

A TEXAS WOMAN FINDS THEM EASY TO RAISE. I have now (January 7, 1904), raised one hundred from those I bought of you (six pairs *Extra* sold December 11, 1902).—Mrs. R. M. H., Texas.

ONE HUNDRED PAIRS IN MONTANA'S COLD WEATHER. The squab breeders arrived here all safe and well in spite of the cold snap Monday noon. We are much pleased with the flock. Number is correct, 208 birds (only two casualties). They certainly are having a fine initiation to Montana weather. The mercury stood thirty-two degrees below zero last night and has been below since their arrival.—W. H., Montana.

DEALERS ADVISE HIM TO BUY OF US. About a year ago I bought your *Manual* and plans for a squab house. I have been studying the book thoroughly and find it very complete in every detail and "out of sight" as compared with others I have seen. I am compelled to move to Southern California and will try squab raising. What discount do you give on 300 pairs of your best birds? I have been somewhat used to stock raising, including poultry. I am advised by dealers in Los Angeles to get my stock from Boston, even at the expense necessary. While no names were mentioned, I presume they referred to

you.—W. W. D., Minnesota. (Correct. We have shipped to California within the past few years thousands of pairs of Homers and at all places in California where squabs are sold and eaten, the product of our Homers is wanted because they are the best in the market there.)

USES THE HEALTH GRIT. Please send me by American express one hundred pounds Health Grit, for which find \$2 enclosed. My pigeons are doing finely and I now have 75 in addition to my original lot, and the young ones are hatching out squabs.—W. L. J., Maine.

HE IS PLEASED WITH US AND OUR BIRDS. I am so much pleased with the birds I got from you and the bright prospects of the squab industry, that I feel interested in getting some of my friends started in squab raising. The last shipment of squab breeders reached me in splendid condition and are very fine birds. I am very much pleased with the selection and your good judgment. All your stock, birds, supplies and dealings with me in the past have been so satisfactory that you may expect more orders from me and my friends in the future. I have raised and sold pigeons and pet stock for years, so of course am capable of judging good stock when I see it, and I consider your squab-breeding Homers the best that can be bred for successful market squab breeding. Trusting that you may continue to have much success in this worthy business.—L. E. Virginia.

THEY EAT OUT OF HER HAND. I enclose money order for more nappies. I like my pigeons better every day. They are so tame now they will eat out of my hand.—Miss L. V. P., New York.

THREE MONTHS' WORK. We are going to move this week to California. The six pairs I bought of you in March, three months ago, have all nested and done fine, and I have raised 24 young birds from them.—Mrs. H. B. S., Massachusetts.

ALL THE WAY TO VANCOUVER. I received my birds on June 8, and all of them were in fine condition except one hen, which seems to be a little stupid. My express charges were all right. Thank you for the free birds. Hoping that I will be able to send for a few more soon.—G. A. L., Vancouver.

HAS SEEN HOW OUR BIRDS WORK IN HIS TOWN. I am sending you herewith money order for \$31.50, for which please send me 12 pairs of your Extra Plymouth Rock Homers, and two of your drinkers, same as you sent me before. I have seen two different lots of your Homers in this city, and although I have some good ones that are rapid breeders and raise large squabs, I am so much impressed with the work that Mr. Barrett's Homers (purchased of you) are doing, that I have gone

to work and fitted up two more breeding pens to accommodate some of your stock.—W. H. M., Massachusetts.

ALL AT WORK IN SIX WEEKS. Whoever took the pair of pigeons from the basket must have been an expert in determining the sex and mates, as every one of them, that is, twelve females, have eggs and are setting. Don't you think this is strong evidence that two pigeons never were taken from the basket during transit? I will make no claim against the express company. I feel very positive they are not at fault. The shipment reached me six weeks ago.—C. S., Ohio.

INCREASING HIS FLOCK. The twelve pairs of breeders that I bought from you last fall are beginning to lay very nicely and I am very much pleased with them. Please send me six more pairs, in payment for which you will find money order enclosed.—H. W., New York.

A LARGE SHIPMENT TO CALIFORNIA. I received all the birds (312 pairs) without one being dead, and the lot seems to be in splendid condition, on the whole, after such a long journey. It seems wonderful to me that none were dead with all the rough handling they must have received on such a long journey. The birds are beauties and attract a great deal of attention.—P. W., California.

QUICK WORK HATCHING. The Homers I got of you are doing finely; received May 1, five weeks ago, and I have a dozen or more squabs from the dozen pairs.—J. F., New Jersey.

FINEST HE EVER SAW. The Extra Homers arrived today in first-class shape, and are the finest I ever saw.—L. C. Y., Maryland.

UNABLE TO FILL ORDERS FOR HOMERS. The writer has been engaged in selling Homer pigeons for squab breeders for the past several months, but my stock is now almost completely exhausted and I am unable to fill my orders. Have just received an order from Hot Springs, Arkansas, but as I make it a rule not to attempt to fill orders for birds which I do not have in my own lofts, have declined the order and referred the customer to your company. He wants fifty pairs, and would suggest that you get into correspondence with him. Trusting that you may be able to get the business.—G. C. S., Ohio.

OUR PIGEONS AT THIS LARGE SHOW IN 1906 MADE A CLEAN SWEEP OF THE PRIZES. Plymouth Rock Squab Co., Boston, Mass. Gentlemen: Pardon the delay in not answering about the safe arrival of the birds. The show was a big success and over nine hundred entries were registered. I had a nice coop fixed up and brought the entire flock of fourteen birds. They behaved fine

and did not mind the close confinement after the first day. One of the pairs laid two eggs. My flock took first, second, third and fourth prizes, also one for the largest flock of one exhibitor (which was \$3), and the white birds took first prize over three other pairs. The judge was high in praise of the birds and their markings. I understand you have sold some birds to Mr. Marsh, who has heard about my success and is to start with one hundred pairs. The pigeons sold several months ago to a doctor of Warren were through my recommendation. Thanking you again for past favors, I remain, etc.—Mrs. R. C., Pennsylvania. (The pigeon exhibition to which she refers was held in February, 1906.)

OFFERED FIVE DOLLARS A PAIR FOR THE BIRDS. Pigeons arrived August 29 in good condition and I thank you. I am well pleased with the birds; they are the finest flock I have ever seen. The teamster who brought them out from Seattle informs me a man on the way offered him five dollars a pair for the birds. Had I been with him, I surely would have taken him up, and made nearly \$100 by the bargain. You may expect another order from me in a month or six weeks for one hundred pairs, and then I shall have enough breeders to commence with.—C. C., State of Washington.

(We have had quite a number of letters similar to this one, and from other information which we have in regard to the Western market for breeders, we know it to be a remarkable one. Any one who buys our fine birds can find a purchaser who is willing to pay in many cases much more than the difference in express charges. We receive numerous requests from wholesalers who wish to sell our birds in their territory, but we sell all the birds we wish to at retail, to the extent of our capacity, at one price to all, and do not supply such dealers. We are shipping at least one order a day the year round to California or the State of Washington.)

OUR HOMERS ARE PRIZED BY FANCIERS AS WELL AS SQUAB BREEDERS. Our Homers sell on their merits as squab breeders, but they are first-class flyers, able to win in any company. At the New York and Chicago National Pigeon Shows in January, 1904, in competition with the whole country, Homers sold by us and exhibited by our customers were the best birds there. In awarding the first prize, New York show, class of Blue Homer Cocks, the judge said: "Grand one; the best bird in the ring today to my way of thinking. He is a large, fine-colored Homer with almost perfect head, broad shoulders and wedge-shaped body, nice eye and fine dark cere. This cock also won the cup for best Homer shown, and this honor was not new to him, as he did the same trick at Lawrence earlier in the season."

The class of Blue Checker Cocks at the New York show was the largest. "A finer class of

Blue Checker Homers we have never seen," said the judge. The first prize in this large class was awarded a Homer from our coops exhibited by one of our customers with the following comment by the judge: "Grand-bodied, up-standing bird, elegant head and eye, with the most perfect checkering I ever saw on a Homer, but for being a trifle light (in color) on rump he would be hard to find fault with."

In awarding the first prize in the New York show, class of Blue Hens, to a hen sold by us and exhibited by one of our customers, the judge said: "This class outside of the winner was not bang-up. Good blue hens are scarce, but the first bird is an exception, and probably one of the best hens going. She is extra large for a hen, almost over the limit in this respect, but she is built on the correct lines, very good color and smooth type of head. She would make a great mate for the first cock."

In the fall of 1903, one of our customers, with a Homer cock bought of us, won first prize every time exhibited, also special prize for best Homer in the show, every time exhibited at the pigeon and poultry shows at Taunton, Brockton and Hartford.

THIS COMMISSION FIRM IN NEW YORK CITY WANTS ONE THOUSAND DOZEN SQUABS DAILY, PAYING FROM \$4 TO \$6 A DOZEN FOR SQUABS BRED FROM OUR BIRDS. The large commission houses handle squabs by hundreds of dozens daily and firms which are known to furnish squabs of first-class size and weight, such as our birds breed, get more orders than they can fill. We received the following letter in January, 1904, from a well-known commission firm in New York City (whose name and address we give to customers who buy breeding stock of us):

Plymouth Rock Squab Co., Boston, Mass.:
Gentlemen: I am receiving quite a few letters from time to time from the different customers of yours that are starting in the squab trade. I wish if you see or write them, that you would advise them as I have done, to put themselves in a position to ship from 5 to 10 dozen squabs at a time, and if they intend to make a business of it, they might as well buy enough breeders in the start, so as to be able to ship a quantity at a time, as these little shipments of one or two dozen hardly pay one to handle, the expense eating up the commission. I have stated to them before, and you can also tell them, that the squab trade is in its infancy, and will certainly increase from time to time, and we are in a position to handle daily any part of 1000 dozen squabs, as we have a big outlet to place them promptly at top prices, with check to balance same day goods are received and sold. For the present, and until further notice, we quote you market as follows: Squabs weighing ten pounds to the dozen, \$5.50 per dozen; nine pounds, \$5.25 per dozen; eight pounds, \$5 per dozen; seven pounds, \$4 per dozen; six and one-half pounds, \$2.75 per dozen;

dark, \$2.10 per dozen. Would like to have all the squabs you can get. In case you have any good customers that are starting in, I wish you would send me a complete list of that trade, so that I can write to them occasionally, and post them on the condition of the market.

To our answer we received the following letter from the above firm:

Plymouth Rock Squab Co., Boston, Mass.:

Gentlemen: Your letter of the 1st duly received, and I am glad to hear from you so promptly. I have received quite a number of letters from small shippers who, judging by the way they write, must be beginners, and know but very little of the business. I have tried to make things as plain as possible to them, and encouraged them all to start in and increase the size of their purchases from you to such an extent that it will pay them to ship. Of course we are obliged to take these small shipments, and encourage them along as much as possible, but very often after we have got a man started, he would have made a pretty fair shipper, but some one gets hold of him in the meantime and makes him believe that he can do better than we can, which is one reason that I object to helping these small shippers along. As above stated, as soon as they get started they begin switching around, and the man who starts them has very little for his trouble and pains of putting them in the way of making money.

I wish if you have any shippers' addresses in the West or in Wisconsin (which seems to be quite a squab country) and also in either Illinois or Minnesota, that you would send them to me. They seem to be doing pretty well in that section, and are satisfied with the fair prices they get from our market,

on account of the poor prices they get in Chicago, or elsewhere nearer home.

At the present time, squabs are very scarce and very high. We are even returning more money than the last quotations I sent you, in order to get enough birds to supply our trade. So if you can put me in the way of increasing our squab supply, I would greatly appreciate it, and try in some way to reciprocate for same. Thank you for the information you have given me thus far in regard to shippers.

Under date of January 30, 1904, we have the following letter from a commission firm in St. Louis, showing that the demand in that section is becoming extraordinary:

Plymouth Rock Squab Co., Boston, Mass.:

Gentlemen: We are in the market for squabs and if you have any customers in this vicinity who are seeking a market for their squabs, we would be glad to be placed in correspondence with them. We will pay the highest market price for them, and feel confident that the service we will render your patrons will prove advantageous to you, to them and ourselves. Please let us hear from you.

We do not give the addresses of these firms, and other good squab buyers, until we have sold breeding stock to the customer. Commission men in all the cities are getting letters from curiosity seekers who are merely "looking up" squabs and to such letters the commission men pay scant attention, for lack of time, and as there is no money in it for them. Any one who doubts the genuineness of the letters we print should come or send a friend to our Boston office to see the originals.

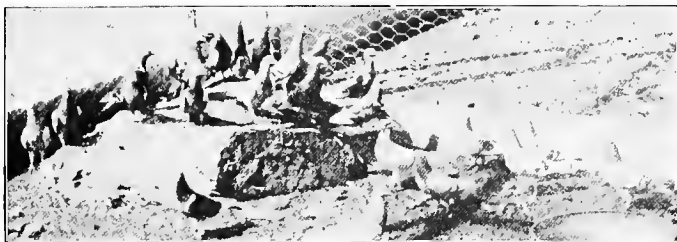

APPENDIX A

(Copyright, 1903, by Elmer C. Rice.)

CALIFORNIA MARKET. The California market for squabs is excellent, especially at the invalid resorts. In San Francisco it is not so good as at the Southern Coast places frequented by rich travelers. We print the following letter:

Poultrymen's Union of California, 413 Front Street, San Francisco (January 28, 1903): "Your valued favor just received and in reply would say that usually the quotations in the papers are close to being correct, but if you desire to call and see us at any time, we will give you exact quotations. There is always a good market here for large, fat squabs. They are readily selling today at \$3 per dozen."

SUMMER RESORT MARKETS. The pleasure and vacation resorts all over the country are good squab markets. Maine squab breeders ship to Boston in the winter but in the summer they get better prices at Bar Harbor and elsewhere along the coast. The White Mountain resorts in New Hampshire are a fine summer market, also the resorts along the eastern coast of Massachusetts. Newport, in Rhode Island, is a good summer squab market. Two or three of our customers in the vicinity of Lenox, Mass., and in North Carolina and Florida, are quite enthusiastic over the splendid market at their doors. Wherever the good eaters go, winter or summer, there is the demand for squabs.

HOSPITAL TRADE. A woman in the State of Washington wrote us that two big hospitals in a city near her had offered to take all the squabs she could supply. She moved out, bought a farm and in January, 1903, we shipped her four baskets. Under date of February 7, she replied: "Please pardon my delay in acknowledging the receipt of the shipment of fifty pairs Extra Mated Homers I ordered from you. I have been so busy with them that I have not really had time to write. Out of the whole lot there was only one dead one, which surprised us." (As we had shipped two pairs more than the order called for, or 52 pairs altogether, the customer had no complaint.) "The birds are perfect beauties and we are greatly pleased with them. They seem to like their new home. Thanking you for your kindness and with best wishes."

The hospital trade in squabs is worth catering to, for they are such a delicacy that they are greatly esteemed by physicians. There may be a suggestion in this for you if you do not care to deal with commission men.

BRANCHING OUT. We have put some of our best birds, in largest orders, for 300 to 1000 pairs, right into the heart of the squab country

around Philadelphia, showing that our ideas and our birds are all right. On February 9, 1903, we received the following letter from Heacock & Hokanson, architects, of Philadelphia:

"Enclosed please find 25 cents for a plan of your style of squab house. Our client informs us that you have prints showing the details of house, nests, self-feeders, etc. We have two clients who have been making somewhat of a success at this work and are now ready to build houses with every essential and practical feature necessary to make a success on a somewhat larger scale."

SQUABS IN UTAH. The following letter comes to us from James A. Hepburn, Utah, dated January 24, 1903:

"Enclosed find check for \$1.70 for which please send me postage paid your leg-band outfit. I recently received your book on pigeons and although I have been breeding Homers for flying for a long time, I learned many things of interest to me from the book. I intend now to increase my flock and raise squabs for the market also. I find I can sell all I can supply here to the local markets."

SQUABS NOT GAME. A correspondent writes us that she does not think she can market squabs in her State because the game laws are so strict. In reply we wish to state that squabs are not game, but are a domestic product same as chickens, and can be marketed in any State or Territory at any time of the year in any quantity without violating the game laws.

CHICAGO MARKET. The Chicago market for squabs is fairly good, but nowhere near so good as the markets of New York, Philadelphia and Boston, because the only squabs obtainable there in large quantities are the inferior squabs of common pigeons. We have customers in Illinois who have written us that their fat Homer squabs from our birds are salable at prices from \$1 to \$2 in excess of the prices quoted by the Chicago commission men. The Chicago market is an eager one, and the dealers are imploring squab raisers to sell, saying they will take all offered. We advise our customers in the Middle West to sell their squabs to the private trade direct over the heads of the Chicago commission men until the latter advance prices. We print herewith some letters from Chicago commission houses, showing that they want them both with the feathers on and off, depending on the dealer:

C. B. Hayden, Jr., & Co., 214 and 216 South Water Street, Chicago, Illinois (Jan. 26, 1903): "Your favor of the 24th inst. at hand and in reply will say, fat dressed squabs bring



MATING COOPS IN MATING HOUSE.

We have a thousand mating coops in our plant. This illustration shows how they are arranged in a house, several tiers high.

\$2 to \$2.25 per dozen. We handle them in any quantities."

Gallagher Bros., 191 South Water Street, Chicago, Ill. (Jan. 26, 1903): "We have your favor of the 24th to hand and noted. In regard to handling squabs will say, we are in a position to handle any quantity to good advantage. We are now getting fancy squabs from Wisconsin, which are selling at \$2.50 per dozen, about seven pounds to the dozen."

C. H. Weaver & Co., 129 South Water Street, Chicago, Ill. (Jan. 29, 1903): "Your favor of the 27th received. The market on squabs is \$2.25 per dozen for the weights you speak of. We can handle all that you will be able to ship us, but would advise making a small shipment at first, so that we will get an idea of your stock and dressing."

Theodore C. H. Wegeforth Co., 133 South Water Street, Chicago, Ill. (Jan. 28, 1903): "In reply to your favor requesting us to quote you prices on squabs will say that there is a very good demand for them on this market at present and when fine they will bring from \$2 to \$2.25 per dozen but in order to bring these prices, the squabs must be fat and weigh on an average about three-quarters of a pound each, and for such there is a ready sale. If you have any, or receiving, you can safely ship all you can get."

H. R. Waszko, 213 South Water Street, Chicago, Ill. (Jan. 29, 1903): "In reply to your letter of January 27, we wish to say that we can handle your squabs, in fact we can place any amount at the extreme top market price, for we are heavy receivers of dressed squabs, especially from South Dakota and Wisconsin. Squabs should weigh not less than six or seven pounds per dozen. Should be dry-picked as the trade that can pay fancy prices want them No. 1, and we quote them firm at \$2.50 per dozen, but they must be fancy. We think we can get you still higher prices but we can tell from your first shipment to us just where we can place them and what we can do. See that they are well cooled off before shipping. Trusting that you will favor us with a good shipment as soon as possible and also give us an idea of how many you can ship us daily or weekly."

Peter Britten & Sons, 2 and 4 Fulton Street, Chicago, Ill. (Jan. 30, 1903): "There is no limit to the amount of squabs we can handle, as we have inquiries for the same at all times. We assure you, and you can rely on us to obtain the highest possible price for your stock at all times."

Cougle Brothers, 178 South Water Street, Chicago, Ill. (Jan. 29, 1903): "Replying to your favor of January 27 will say that good fat squabs are worth from \$2 to \$2.50 per dozen. We can handle all of that kind you can get. The best way to ship them is just to pinch their necks, cool thoroughly and pack in a box. Do not bleed them nor take the feathers off. We hope you can ship us some of this kind of squabs as we need them."

F. W. Melges & Co., 100 South Water

Street, Chicago, Ill. (Jan. 28, 1903): "Replying to your favor of the 27th in regard to squabs we beg to say that there is a wide range of prices according to quality. If they are fine fat birds we can handle advantageously all you can ship us. We shall do all in our power to obtain the very top price for same at all times."

A. Booth & Co., 63-65 Lake Street, Chicago, Ill. (Jan. 25, 1903): "If squabs are well dressed and weigh eight to nine pounds to the dozen, we can use them at \$2.25 per dozen f.o.b. Chicago."

H. G. Lane, buyer for the Wellington Hotel, Wabash Avenue and Jackson Boulevard, Chicago, Ill. (Feb. 2, 1903): "In reply to yours of January 26 about squabs would say that we are buying the large white squab you speak of. We have them shipped with the feathers on and market price for the best squab is \$2.75 to \$3.00 per dozen."

William H. Taylor Co., 156 and 158 South Water Street, Chicago, Ill. (Feb. 4, 1903): "Your letter at hand in regard to squabs. Would say we could use all your squabs you can ship. We would just as soon have them with the feathers on as off. We can offer you \$2.50 now for good stock. Should at any time market do better, we should certainly give it to you. Please let us know how soon you can ship and how many each week. We have the trade for them and can do as well as any one for you."

Herman Weber Co., Inc., Union Hotel and Restaurant, 111-117 Randolph Street, Chicago, Ill. (Feb. 3, 1903): "Your favor of the 1st to hand. I am buying squabs fresh in the market all the time and am paying \$3 per dozen for same. You can bring in two dozen of your squabs and if satisfactory will buy same of you right along."

The letter last quoted above, that from Herman Weber, is an indication of what the consumer in Chicago is paying for inferior squabs. It rests with you whether you will be satisfied with breeding a product which commands a price of \$2 to \$3 a dozen, or \$3 to \$6. If you put squabs weighing ten pounds a dozen and over into the Chicago market, you can get from \$3 to \$6 a dozen.

NEW YORK MARKET. In the first part of January, 1903, we received the following letter from the manager of the squab department of a commission house in Washington Market, New York city:

"Your name and address as raisers of fancy squabs was given me by Mr. Howes of Detroit, Michigan, who was over to your place a few days ago. As I have heard of your plant before and have tried to get your address so as to write to you for squabs, I hope this letter will mean some business for us both. If you have any squabs to ship, I would like to get your output, and can use all you can ship at full market, and make you prompt returns day received and sold. This week I am returning the following prices:



INTERIOR OF MATING HOUSE.

This shows mating coops in use in one of our mating houses. This house is heated by hot water.

Squabs weighing ten pounds to dozen and up, **\$4.50 per dozen**; eight pounds and up, **\$4**; seven pounds and up, **\$3.50**; six and one-half pounds and up, **\$2.60**; dark, **\$1.80 per dozen**. If you will prepay charges, account of sales will be sent you same day goods are received, less five per cent commission."

Letters like the above come to us from all parts of the country, and squab breeders whom we have supplied get similar communications. The poultry and game dealers in all sections are after squabs all the time and could sell a great many more than they are now able to get hold of. The above letter is written notwithstanding the fact that in New Jersey and Eastern Pennsylvania alone are today four or five thousand squab breeders, many of them with large flocks of over one thousand pairs of birds each. In the town of Moorestown, New Jersey, to take only one case, are from **200 to 300 squab breeders**. As we say in our *Manual*, people in these sections keep hens for their own use, but not for market, for they know that squabs pay better than hens. Poultrymen in other sections of the United States are fast finding this out and are putting in squabs along with poultry, or giving up poultry altogether. In spite of the large output of squabs from the 4,000 to 5,000 breeders in New Jersey and Eastern Pennsylvania, which go into the Philadelphia and New York and Boston markets (for the squab raisers in New England supply only about one-tenth of the Boston demand), there is all the time a scarcity of squabs, as the above letter proves. This letter comes to us because we have the reputation for dealing in a fancy product. There are breeders of squabs who send to market an inferior product from small and cheap Homers, and such squabs are not the kind which dealers are anxious to get. Be sure you are able to breed a fancy squab by getting your breeding stock of us. Some beginners are anxious as to express rates, not comprehending that they can ship squabs long distances at a trifling cost. The express rate from Boston to New York is \$1 per 100 pounds. This means that an express team will call at our door, get a box of squabs weighing 100 pounds, transport it to New York, and in that city deliver it by team to the commission dealer for \$1. In the case of a box of our squabs weighing twelve pounds to the dozen, about eight dozen and the box would weigh 100 pounds. If we delivered them in New York at the price quoted, **\$4.50 per dozen** (or \$36 gross), we would net, deducting his five per cent commission and the \$1 express charges, **\$33.20**. The commission man would resell the squabs to his trade for \$5 to \$8 per dozen. By a dozen squabs we mean in this case and in all cases where prices are quoted, **twelve squabs**. We do not mean one dozen pairs of squabs. We mean six pairs of squabs. Squabs are always quoted at so much **per dozen**, not so much **per dozen pairs**.

On January 8, 1903, the New York squab buyer above quoted offered the following prices for squabs: For squabs weighing ten pounds to the dozen and up, **\$4.75**; eight pounds and up, **\$4.50**; seven pounds and up, **\$3.60**; six and one-half pounds, **\$2.75**; dark and No. 2 squabs, **\$2**.

On January 25th, 1903, he offered the following prices: Ten pounds and up, **\$5.50 per dozen**; eight pounds and up, **\$5.00 per dozen**; seven pounds and up, **\$4**; six and one-half pounds, **\$3**; dark and No. 2 squabs, **\$2.10**.

On February 6, 1903, he offered us the same prices as last quoted, adding that he would pay **\$3 to \$3.75 per dozen** for squabs of average weight and grade. In this letter he said: "As I have been getting quite a few letters from some of your squab customers of late, I want to thank you for same, and hope to get some of their birds and prove to their satisfaction by the prices large, fine birds will sell at, that squab raising if properly carried on is a **very profitable and paying industry**. The demand for squabs is **on the increase** and will be from now on, as the game laws of all the States are such as to prevent much small game from reaching the several markets, where there has been a big supply of such at low prices that squabs will now take their place, so that new beginners have nothing to fear from a glut by over-production of good-sized squabs. This we have proven to our own satisfaction when we introduced the large or royal squab to our best hotel and cafe trade in this market, during the past season, and it now looks as though our demand will be greater this coming season. The buyers of these large birds see they are worth the difference in price, that they have a better call for them once they introduce them to the consumer. Encourage all your buyers to invest in birds that produce large, plump squabs. It will pay them best in the end and make a better demand for their grade of birds."

On February 16, 1903, he offered us the following prices: Squabs weighing ten pounds to the dozen and up, **\$6 per dozen**; nine pounds, **\$5.50 per dozen**; eight pounds, **\$5 per dozen**; seven pounds, **\$4 per dozen**; six and one-half pounds, **\$3 per dozen**; dark, **\$2.10 per dozen**.

The above quotations are a good indication of what the New York market for squabs is.

One of the practical ways we have of helping our customers is to refer them to such first-class buyers of squabs as the firm above quoted. We will give the address of the above New York firm to you when you buy breeding stock of us.

SCRANTON MARKET. The following letter is from Chandler and Short, commission merchants, 15 Lackawanna Avenue, Scranton, Penn., dated February 15, 1903: "We have yours in regard to squabs. They are worth from **\$2.75 to \$3 per dozen**, dressed, on our market. Whatever you ship, we will

endeavor to get the very highest market prices for. All you have to do is to have the feathers picked off."

CLEVELAND MARKET. The steward's department of the Union Club, 158 Euclid Avenue, Cleveland, Ohio, sends the following letter under date of February 13, 1903: "I am in receipt of your letter of yesterday and beg to say regarding your questions about squabs, that they are worth to us from \$3 to \$3.50 per dozen for the best and largest squabs either dressed or in the feather."

W. H. Bennett, proprietor of Oyster Ocean Cafe, 368 Superior Street, Cleveland, Ohio (February 12, 1903): "I use about one and one-half dozen squabs a week. Price averages \$3 per dozen the year through."

W. H. Seager, Sheriff Street Market, Cleveland, Ohio (Feb. 12, 1903): "I purchase squabs when offered in this market and have sent to California for them on special occasions. The market price varies from \$2.40 to \$4 per dozen."

Gibson Pinkett Company, Fulton Market, 21-25 Prospect Street, Cleveland, Ohio (Feb. 12, 1903): "We buy squabs and pay what they are worth. Price runs from \$2.50 to \$4 per dozen. We could use fifty dozen or more today."

KANSAS CITY MARKET. The market for squabs here is steadily improving. Here are some letters bearing on the subject:

From James R. Peden & Co., 404 Walnut Street, Kansas City, Mo. (Jan. 26, 1903): "Send your squabs to me. I have good, steady demand for them and will take all you can offer. Top prices paid, or handled on commission." (Mr. Peden ships squabs to New York City and other points east.)

W. M. Woods, Produce Company, stalls 12 and 13 west side, City Market, Kansas City, Mo. (Jan. 26, 1903): "The market for squabs is good. Prices range from \$1 to \$1.50 for common stock and from \$1.80 to \$2 and \$2.25 for fancy. I am sure you will find a market for your squabs and if they come up to the mark you have set for them, will command a much better price. Kansas City market for squabs is growing. I will take your squabs at market price day received."

C. T. Wiggins, East entrance City Market, Kansas City, Mo. (Jan. 26, 1903): "It is only a question of how many you can supply. I can handle all the squabs you will offer and will pay you good prices for them. The demand is strong and increasing. Hope you will soon make a start with me."

George O. Relf, steward, Midland Hotel, Kansas City, Mo. (Jan. 27, 1903): "We can use squabs almost any time at \$2.75 per dozen. If you have some now we will take one or two dozen and if O. K. will very likely use them right along."

Ewins-Dean Hotel Co., proprietors Hotel Metropole (St. Joseph, Mo.) and Hotel Baltimore (Kansas City, Mo.) (Jan. 30, 1903):

"Kindly quote me prices on squabs by the dozen. I have been using about two hundred per month and expect to use more. If your prices are right you will hear from me in a few days." (Signed) E. G. Venable, steward.

E. Klidey, the New Coates House, Kansas City, Mo. (Jan. 29, 1903): "We are using a few squabs which we buy from the commission men here at \$2.50 per dozen. Let me know what price you want for yours and we may be able to use eight or ten dozen a week."

D. P. Ritchie, steward Hotel Baltimore, Kansas City, Mo. (Feb. 6, 1903): "Your favor of January 27 received. We pay \$2.75 per dozen for fancy squabs delivered, with feathers on."

OUR PIGEONS GOING AROUND CAPE HORN. We have sent our breeding stock about everywhere, but one of the most curious orders we ever had is from Captain Lane of the ship Kennebec, which arrived in Boston in November, 1902, from Seattle, with a cargo of lumber. At this writing (Feb. 18, 1903), Captain Lane is making arrangements with us to supply him with a breeding outfit of our Homers, which he will instal on his ship so that on his long return voyage to San Francisco (or Seattle) he will have fresh squab meat regularly. Captain Lane is part owner of his big ship and is accompanied by his wife and young son. He has visited our place and knows about our birds and our methods.

SQUABS IN NEW MEXICO. Here in the East we would not look upon New Mexico as a fancy market for squabs, but here is a letter from a customer in Abemarle, New Mexico, which proves that he is getting interested (Jan. 29, 1903): "The pigeons you sent me on the 20th were received yesterday in excellent condition, and am well pleased with them. Please find enclosed a money order for thirty dollars, for which send me twelve more pairs of your Extra mated thoroughbred adult pigeons." Ship as before by Wells-Fargo express."

SOUTHERN MARKET. Our breeding stock has gone to every State in the South. If you live in any part of the South, you can market squabs as readily as poultry is marketed. One of our Southern customers, who lives in Citronelle, Alabama, has been to Boston to see us. Under date of January 30, 1903, he writes: "I have received Homers from two others, but they do not compare with yours. I will build my second house very soon as the first one is filling up fast."

LONG DISTANCE SHIPMENTS. To all inquirers we wish to state again emphatically that we certainly do guarantee the safe arrival of every bird, no matter in what part of the world you live. We are learning all the time how to handle the long distance shipments best and experience has taught us little wrinkles about the baskets and the arrange-

ments of the feed and water dishes, which are valuable. The express messengers get their instructions not from gesswork or from written notices or tags, but from a board a foot square on which is printed in bold type the necessary directions. This winter (1903) we have shipped every week to California. One order of 200 pairs for Santa Ana, California, filled seventeen baskets. Of the 400 birds, **only one turned up dead**, but as we had sent along four more pairs than the order called for, we were seven birds ahead on the count. Another large shipment to San Rafael, California, in January, 1903, brought back by return mail the following letter, which we print exactly as we got it, word for word, and altogether it is one of the best recommendations for us to people who live at a distance that we ever received:

"Yesterday a.m. (January 20) at 8.30 we received your letter advising us of the shipment of 100 pairs of Extra Mated Homers, on January 14; advising also that the pigeons would reach us before the letter. Well, they did not arrive until 4.30 today, January 21 (7) seven days on the road. We notice that seven days are also required to get your shipments to Los Angeles; and when you assume that they will reach here at or before the receipt of notice of shipment we think you are mistaken. Nevertheless, be this as it may, the birds reached us tonight at 5.30, every bird in first-class shape—every individual one being in first-class shape; giving evidence of being shipped in perfect condition and having plenty of feed and water en route. Your feed ran short, as evidenced by charges of 40 cents made by express company for feed provided by them, which we are only too glad to pay, and at same time shows care and attention of express company messengers—a good fault. Every bird in the lot is bright and active, and they come into a first-class home, a fine house and flying pen, plenty of feed and a galvanized iron pan 6 inches deep with water 4 inches deep running constantly. Dimensions of pan, 4 feet 6 inches by 2 feet 10 inches, guaranteeing plenty of bathing facilities. They were liberated after dark, but the early morning will afford all the bathing facilities they will need, and we prophesy they will embrace the opportunities afforded at first opportunity. We wish to compliment you on your prompt methods of doing business, and on the superiority of the birds shipped us. They were indeed high-class birds, in fact, Mr. Rice, they are better stock than we expected to receive. Your sending us four extra pairs above order was a graceful act on your part, one which we fully appreciate, and thank you right here for it. Your shipment was nearly a week before we expected it by extra exertion we got all ready in time and they have a fine home. Express charges at \$14 per hundred Boston to San Rafael, 270 pounds weight of shipment, amounted to \$37.80 plus 40 cents for feed, \$38.20 total, at merchandise rate. Still at rate given in your circular \$4 for 24 birds (12

pairs), this is too much by a margin. \$4 rate to San Francisco per 12 pairs is not just correct, still we are not kicking, for the difference is not very much. Note this, 201 birds came out of those baskets. Now we are sure, absolutely sure of the count. Two people kept count as each bird was liberated and 201 birds came out of the crates. If 100 pairs are mated, what will we do for that poor lone bird? We wait for suggestions; pretty tough on that lone bird, 3500 miles from home, but he or she is here sure. In conclusion we thank you for your promptness, your honesty and your fair, square dealing and will keep you posted as to our progress as per your suggestion. We thank you for the crates; they are fine. We wrote you yesterday and look for reply in accordance with your usual promptness."

We sent the above letter to Mr. R. H. Dwight, agent for the Wells-Fargo Express Company in Boston, and he was quite as pleased as we were. Through Mr. Dwight's co-operation our through western shipments by the Wells-Fargo have been a remarkable success. The only difficulty we have ever had on account of long-distance trade came when we were shipping in crates, not baskets. We sent a large order into San Francisco and on the way four of the crates were broken into by rough handling and forty-two birds got away. The Wells-Fargo Express Company settled with us for the loss of those birds and we made good to the customer, sending the missing birds on, and the customer was out not a cent for further express charges, for the Wells-Fargo people carried the birds dead-head.

The baskets in which we now ship cannot be broken open except with the aid of an axe and they can be thrown ten feet across a depot platform without being injured.

There is a minor criticism in the above letter in the matter of express charges. According to the figures which we give in the circular headed "Express Rates," the customer should have been asked to pay about \$33, instead of \$37, as he did pay. We believe the figures which we give to be correct in every case—the slight variation which may come as it came in this case is due to the fact that no two persons will weigh up the same lot of goods exactly the same, and that, of course, the birds vary in weight. The weight when the shipment starts is less than when it finishes, because at the end the bottoms of the baskets are covered with manure. (The grain which we send for feed is not weighed in and charged for transportation.) If the waybill is lost or delayed, and the agent at destination weighs the shipment, he will get a greater weight, and consequently a higher rate, than the express employee who weighed the shipment here in Boston.

We wish to say further that if you think we have figured the express rates to you too low, send us money which we claim to be

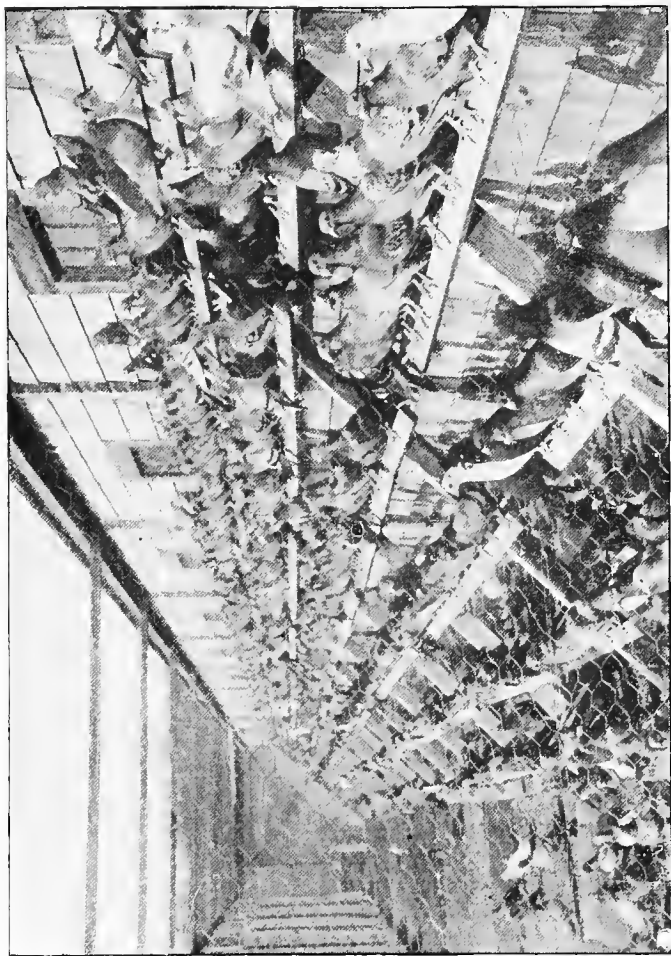

PART OF SOUTH SIDE OF ONE OF OUR HOUSES.

Note the arrangement of outdoor perches. This is better than letting the birds upon the roof. They can hear the squeaks of their young for food better. The top of the flying pen is strung from the eaves of the building, not the ridgepole.

correct and we will prepay all charges, thus putting on ourselves and not on you the difference, if there is any.

COMMON PIGEONS AGAIN. We have had some of the old-time raisers of squabs from common pigeons on the ranches in the Middle West write us for more proofs that Homers are ahead of common pigeons.

In reply we will print here the letter which we received in January, 1903, from a customer as follows:

"I have for sale between four and five hundred pen-fed common pigeons. Can you use them, and at what price? Should you not be in a position to use them yourself probably you can refer me to some one that is in the market for some fine pen-fed birds. The Homers which I purchased of you some time last summer are doing very nicely, and have to make more room for them is the reason of wanting to dispose of my common birds. Thanking you in advance for favor asked."

We asked him to tell us if he had not found our Homers more profitable than common pigeons. He replied as follows:

"In reply to yours will say that your statement of the Homers being more profitable than the common birds is true, as the fact has been demonstrated to me in the past five or six months, by my experience of having the two lots side by side in separate pens. My common birds referred to are fine birds and will sell them f. o. b. at \$2.50 per dozen, which, taking the plumpness of the bird in consideration, is very reasonable."

The above breeder lives in Missouri and we expect to sell a good many of our Homers to him and to those in his State who know of his experience. His letters are at our Boston office, where they may be seen. We will not give his name by mail because he is a customer, but if you think the above letters are made up by us, you write to the Boston office of Dun's or Bradstreet's commercial agencies and ask for one of their men to be sent to our office to investigate.

PIGEON MANURE. Our advice in the Manual as to pigeon manure has interested pigeon breeders all over the country, nearly all of whom say that they never have taken pains to save it, and when it got too thick they have scraped it up as best they could and used it for fertilizer. They want to know how we keep it pure, and all about the market, etc.

The pigeon breeder who does not make provision for the purity of the manure and the steady sale of it is just throwing bank-bills straight into the fire. We have erected two buildings at our place for the manure, and take every precaution to keep the manure free from straw, sawdust, sand, etc. The first building stands at the back of one of the long houses, and about halfway in the whole plant, so that we can reach it easily

with a wheelbarrow from the houses. There is a slide cut in the north wall of what we call No. 2 squab house, and through this slide the manure is shovelled from the wheelbarrow (standing in the passageway) directly into the manure house, where it stays until there is from \$50 to \$100 worth of it, when we bag it up and send it off. In the other building, which is larger, we dry and store a larger quantity of the manure.

We take the wheelbarrow empty down a passageway and stop at a unit pen, then go into the unit pen with a bushel basket and scrapers. We use a trowel to clean off the nest-bowls, a tree scraper to clean out the nest-boxes and a hoe or a floor chisel (same as is used to clean off snow and ice from city sidewalks), six inches wide at the blade and with a long handle so that it can be easily used while the operator is standing. In scraping the floor, the manure rolls up with little exertion off the blade of the chisel. It is shovelled into the bushel basket and the basket taken out into the passageway and dumped into the wheelbarrow. It takes one man not over thirty minutes to clean a pen thoroughly and the product of each pen is between two and three bushels, or from \$1.20 to \$1.80 for half an hour's work, which is pretty good pay. (We have been getting in the winter of 1903 sixty cents a bushel from the American Hide and Leather Company of Lowell, Mass.) We ship the manure by freight in bags. We buy these bags when we can from farmers who have large herds of cows and who use considerable grain, and they let the bags go for one and two cents apiece. Second-hand bags in the Boston junkshops cost from four to nine cents apiece. The leather people let the bags pile up and then send them back to us in a bunch. We are particular to save not only the manure in the unit pens, but in the sorting and mating cages and coops. We cover the floors of these cages with burlap, not tacking the burlap down, but stretching it over three finish nails tacked at the backs of the cages and two nails tacked at the front of the cages. The manure cakes and dries on the burlap as it would on the floor. When there is a layer about half an inch thick, all tramped hard, dry and odorless by the constant hammering of the feet of the birds, we take the burlap off the nails and stretch it outside, bottom up, then sprinkle water on the back and the manure drops off in large cakes. The burlap then is dried and replaced. This method saves an immense amount of time which otherwise would be consumed in scraping the floors of the cages. We have 108 of these cages at the farm and in our Boston shipping room, each capable of holding from 12 to 20 pairs of birds, and we have burlap carpets on all of them. We use a large amount of burlap not only for this purpose but for small grain bags to go with orders for breeders to distant points, and also for the floors of our

shipping baskets. We buy this burlap in large rolls weighing 150 pounds and containing from 300 to 320 square yards. We do not hem it or sew it in any way for the cages, simply cut it and in stretching it over the nails fold the raw edges under.

Having read the **Manual**, you know that we do not use sand or sawdust in our squab houses, so we are able to deliver manure which is absolutely pure. The tanneries do not like to get lots of impure manure and of course pay more for the unadulterated article. It is just as easy and more business-like to keep this by-product pure. Feathers and grain in the manure do not injure it for tanneries.

The manure in the houses has no odor, but when we have got it scraped up and banked in the manure house, it gives forth a pungent, ammonia-like smell. As the manure house is entirely cut off from the squab houses by the slide in the passageway, this pungency does not trouble anyone. It is not a nasty smell, anyway.

We have had customers from as far off as Illinois write that they were quite charmed with our story about the manure, and that they were saving up bags of it to ship by freight to the American Hide and Leather Company at Lowell, Mass. This tannery is a branch of the Leather Trust, which has other tanneries, so use your wits and find out which tannery is nearest you, and ship to that one. If you can find a tannery not in the trust, sell to that, if you wish to. If you sell to a trust tannery, the check which pays you will come from the New York office of the trust, same as ours do. We recommend our New England customers to ship to Lowell. We have always found the leather people square in measuring the manure, in fact they have given us credit on two or three occasions for more than we thought we had. They pay after you have sent your bill of lading and the report of the measurer has gone to the New York office. You need not be afraid of swamping the leather trust with pigeon manure. They will take all you can scrape up. Chemicals which are used as substitutes when pigeon manure cannot be had are said to be injurious to the hide.

We write the above to help you sell the manure from your squab houses. Do not ask us to advise you further on this point, for we cannot. If you cannot find a tannery within shipping distance, try the florists or market gardeners. We are informed that the florists' exchange in New York City is a good place to sell pigeon manure, and customers near that city have told us that they are selling there.

SQUABS IN THE POULTRY PRESS. The magazines devoted to poultry are beginning to take up squabs on account of the increasing interest shown by poultrymen in the subject. In the *Poultry Keeper* for November 15, 1902, appeared a contribution by A. P. Spiller.

After giving the general arrangements for caring for the birds, he says: "At about four weeks of age the squabs are ready for market. Some markets require them dressed, others only killed. Good breeding pigeons will hatch and rear from six to eleven pair of young a year. The cost to keep a pair of breeders, including the raising of the young, at the present time is about **eighty cents a year**, this, of course, varying some with location and cost of feeding stuff. Wild game birds are becoming more scarce each year. The properly raised squab pigeon comes nearer taking the place of these wild birds than anything else. That they make fine eating, those who have eaten them cannot deny. There is always a ready sale for good plump squabs at hotels, restaurants, markets and private families, prices ranging from **\$2.50 to \$4.50 per dozen**, depending upon quality and season. When one begins to raise pigeons it is better to try to secure strains from some reliable breeder who has stock bred along profitable lines. There is a difference in regard to breeding and feeding qualities and results obtained which warrants the paying of a little more at the start in obtaining more profitable stock. The writer is in favor of the straight **Homer**, carefully selected as to size, shape, breeding and feeding qualities, as it is well known that the **Homer** pigeon is one of the best feeders and breeders of any variety, and the numbers they will produce in a year more than balance any slight advantage that may be obtained in size. The breeding of pigeons is fascinating to most people. It is true there are some losses, but with care and some experience in management the few losses that occur to the beginner may be reduced to a very small percentage. The work is light and not as exacting as in some other lines, affording a lucrative employment almost from the start to those who are not strong, as well as to the most robust. A flock once mated will give but little concern to their owner, as they remain constant for life regardless of the numbers contained in the flock, and for years will amply repay in profit and pleasure for the feed and care given them."

We wish to call the special attention of our readers to that portion of the above article by Mr. Spiller where he says that the cost of a pair of breeders is **eighty cents a year**. We say the cost is sixty cents a year at the present prices for grain (1903). In his article Mr. Spiller says nothing about keeping the pigeon manure free from dirt and selling it to tanneries. This must be done in order to hold the feed bill down to its lowest notch. We say that the manure will pay one-third of the grain bill, and taking Mr. Spiller's figure of eighty cents, and deducting one-third from it, we have as the net cost **fifty-three cents**.

We asked one of our friends living in West Newton, Mass., to ask Mr. Spiller if his estimate of cost was made when he was saving the manure and selling it to tanneries. Mr. Spiller replied by letter as follows under date of February 16, 1903: "No, the manure was

not taken into consideration at all. I do not know what the tanneries pay for it."

The owners of large flocks of common pigeons in the West who are breeding squabs for market do not sell the manure and for this reason they lose an important source of revenue. It is remarkable to us that pigeons pay with them at all. Certainly the manure is a very important by-product, and you should figure on selling it just as you figure on selling the squabs.

NEWSPAPER MARKET QUOTATIONS.

Only a few of the daily newspapers of the country are in the habit of printing regularly market quotations on squabs. The Boston Globe has an article about once a week for the information of the household and in this article squabs are regularly quoted. At Thanksgiving time, 1902, the Globe quoted squabs at from \$4 to \$5 per dozen. In the Globe of February 14, 1903, squabs were quoted at \$4.50 and \$5 per dozen. If our New England customers will buy a copy of the Friday or Saturday Globe each week, they will probably find this household article containing the quotations for squabs on one of those days.

SQUABS IN THE STATE OF WASHINGTON. The squab raisers in New Jersey, New York and Pennsylvania are very well satisfied with the New York and Philadelphia markets for squabs, and we have done considerable talking about the New York market ourselves, but let us tell you that the market for squabs on the Pacific Coast is a fine one, too. Here in the East we think Seattle is a long way from home and you may find some city chaps around us who think that city is but just on the edge of the tall timber. If you live out in Michigan, Illinois, Minnesota, Indiana, Ohio, Kentucky, or any State in that section, you ought to feel pretty sure that the markets for squabs around you are good, after you have read what we are going to tell you here about the market for squabs in Seattle and its vicinity.

These letters were obtained for us by a customer who lives near Seattle:

Fulton Market, corner Second Avenue and Columbia Street, Seattle, Wash. (Feb. 11, 1903): "Yours at hand and will say that if your birds are as you say, we can use on an average of twenty dozen per week at \$2.50 per dozen, feathers on."

A. D. Blowers & Co., 817-819 Western Avenue, Seattle, Wash. (Feb. 12, 1903): "Your valued favor to hand regarding squabs. In reply will say that most of the squabs used in this city are brought from the East and held in cold storage, so that native birds will no doubt sell much better than this article. We have made some inquiry about them and find that there will be no trouble in selling four to six dozen a week, and no doubt many more, as the trade would open up. We do not think there is any one in this part of the country who

raises them for sale, and think if you can produce a good article that you will have no trouble whatever in selling them here. The price for eastern squabs is \$2.25 to \$2.50 per dozen. Some of the customers prefer to have them plucked, others alive. We think it would be better, perhaps, in the first shipment to send them alive until a regular trade is established. Our commission for selling them will be ten per cent of the gross sales. If you have any nice ones, it would be well for you to send two to four dozen along and see what we can do with them for you."

(It is better to ship squabs killed and properly cooled. Do not send them alive to your market. Few butchers in the commission men's employ understand how to kill and cool a squab right. Do your own killing and cooling and packing as we have given you precise directions and you will know, no guess, that your product is reaching the consumer in perfect condition.)

Palace Market Co., Second Avenue, Seattle, Wash. (Feb. 11, 1903): "Squabs such as you speak of would be worth 20 to 25 cents each. Would prefer the feathers on. We can use all you have."

California Commission Company, 923 Western Avenue, Seattle, Wash. (Feb. 11, 1903): "Your favor to hand and contents noted. In reply we beg to state that squabs are selling from \$2.50 to \$3.50 per dozen, according to the quality of the birds. We want them with the feathers on and not drawn. You may ship us two or three dozen for a trial and then we will be better able to tell what we can do for you and see how many we can handle at a time. Our commission is ten per cent, on all goods. We are certain that we can give you entire satisfaction and know that our business methods will please you. We make prompt returns and keep shippers well posted on the market conditions. Trusting to be favored with your further valued orders."

C. W. Chamberlain & Co., 905-907 Western Avenue, Seattle, Wash. (Feb. 13, 1903): "Yours of the 9th at hand and contents fully noted. Squabs, such as you mentioned, would sell here for about \$3 per dozen. Our selling charge is ten per cent. Twelve to fifteen dozen per week could be disposed of from present information at hand. They should be shipped alive."

J. F. Gayton, steward Ranier Club (this club is composed of the richest men of Seattle), Seattle, Wash. (Feb. 13, 1903): "I am in receipt of your letter with regard to squabs. Yes, I want some squabs at any time. Will be glad to have them. I will take a dozen at 25 cents each, either dressed or undressed, three dollars per dozen. After I see the first birds I can tell whether I can take them regularly."

Williams Bros., Gilt Edge Cafe, Everett, Wash. (Feb. 12, 1903): "In reply to yours will say, I cannot say at present how many



VIEW FROM PASSAGEWAY.

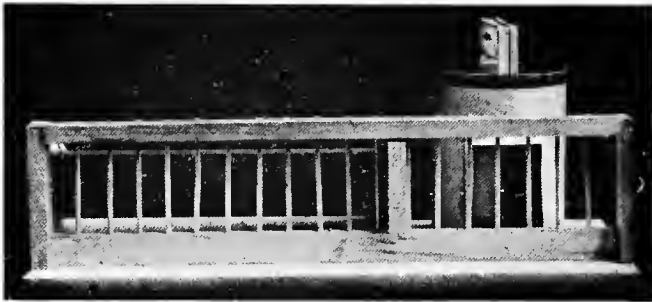

VIEW FROM INTERIOR OF SQUAB HOUSE.

Above are two views of a model made to illustrate what we call the dowel system of feeding and watering. It is a great time-saver in a long house. Between the floor of squab house and the lowest tier of nest boxes is one foot space. Fill this space with three-eighths inch doweling set one and one-half inches apart, as pictured. (This doweling comes in any length from a carpenter and is very cheap.) Set galvanized drinker and feed trough as shown. The trough has a three-quarter inch slot in its bottom so that the grains will fall into position ready for eating on the back side of the bottom strip into which the dowels are driven. The birds stick their heads through the dowels to eat and drink, and cannot foul either grain or water. Push a wheelbarrow with grain along the passageway and a house one hundred feet long can be attended to in fifteen minutes. Without this arrangement, if you go into each unit pen to feed and water, you will use up at least an hour, and it will be harder work. By this method you need enter the breeding pens only when killing or cleaning times come.

squabs I can use, but will start with two dozen a week, picked, at \$2.50 per dozen. Ship as soon as you please and will look the market up for you in the meantime."

Gordon & Co., commission merchants, 811 Western Avenue, Seattle, Wash. (Feb. 13, 1903): "Replying to your letter will say that we have telephoned to several of the hotels and restaurants here that would be apt to use squabs and we find that there are some places that make a specialty of using them and we do not believe we would have any trouble in disposing of them nicely. We would suggest that you send down a small box of them and let us show the customers just what they are and find out just what they will be willing to pay for them. They have been selling recently for 25 cents each. If you care to make this shipment, we will be glad to get it."

Seattle Market, Cor. First Avenue South and Washington Street, Seattle, Wash. (Feb. 10, 1903): "In reply to yours would say, it would be a good idea for you to ship us in two or three dozen squabs for sample. I could get the hotel and restaurant people's opinion on price and quality and be able to talk to you on quantity. Eastern frozen squabs are selling on this market for \$2 to \$2.25 per dozen. If your stock is as you say, I think it would be a better seller than frozen goods."

Maison Barberis, restaurant and dining parlors, 204-210 James Street, Seattle, Wash. (Feb. 11, 1903): "We will take thirty dozen squabs every month; have them plucked, and will pay you \$3 per dozen. Please answer and say about what day of the month you will send them in."

E. C. Klyce & Co., commission merchants, 906 Western Avenue, Seattle, Wash. (Feb. 13, 1903): "Yours regarding squabs to hand. We have investigated the market here and find a good many of the first-class hotels and cafes will take them at very fair figures. There seems to be a variance of opinion as to what they will pay, but we presume that the supply has been very limited, and they would pay just about whatever the seller would ask in order to get them. We think the average price would be about \$2.50 to \$2.75 per dozen. Of course there would be some bidding among the different buyers in case they were scarce, and we might get more for them. We have immediate access by 'phone and salesmen with all our customers who serve squabs for short orders or otherwise. By this means you would be in close touch with the people most in need of them and would always try to get you top-notch prices. We believe this is a good investment for you to grow them for this market. Of course you would have to start in and graduate up to find how large the volume of trade will be that we can command you on them. Anything in the way of game, fowls or meats are staple sellers at good prices."

Hamm & Schmitz, Hotel Butler, Seattle,

Wash. (Feb. 12, 1903): "In reply to yours, will say that we could use three dozen a week of the squabs and will pay three dollars per dozen for plucked birds, laid down here."

The above letters indicate to us that people in the State of Washington who eat squabs have to pay from \$3 to \$4 a dozen for the cold storage, frozen kind. Poor as these are (they are the lightweight squabs of common pigeons) they are in active demand. Of course the consumers would pay as much, and no doubt more, for fresh-killed squabs bred from our fine Homers. The commission men are certainly eager to get squabs. They are willing to pay from \$2 to \$3.50 per dozen. They resell them at a profit.

The above letter from **E. C. Klyce & Co.** is sensible and could well be written by any commission firm in any State in the Union, or by any commission firm anywhere that sells poultry, eggs and butter. Wherever there is a sale for hens and chickens, dressed or with feathers on, there is a sale for squabs at higher prices not only because they are a greater delicacy, but also because good eaters everywhere know they are a greater delicacy, and expect to pay, and do pay, more for squabs, pound for pound, than they pay for hens and chickens, geese and turkeys.

We ship to Seattle by the fastest express trains. The birds go from Boston to St. Paul (Minnesota) by the Wells-Fargo Express Company. At St. Paul the birds are taken by the Northern Pacific Express Company, which has charge of them to destination. Every express messenger in the employ of these two companies of this long route has handled our shipments and made a fine record, and is trained to the work of feeding and watering all sizes of shipments. Our Seattle trade can be sure that their shipments will be treated right and will reach them in perfect condition. That is what we guarantee.

MORE LETTERS. Here are more letters from squab buyers, unclassified, as they came to us in the first part of February, 1903:

Allyn House, Hartford, Conn. (February, 1903): "In answer to yours will say we are continually using squabs. We buy them plucked in all cases. We pay all prices, according to size, age, and condition when received. They run from \$2.25 to \$3.25 per dozen. Sometimes the market is a little higher."

Russell House, Detroit, Michigan (February, 1903): "In reply to your letter would say that we use quite a few squabs here. Am paying at present \$2.50 per dozen for splendid stock. If you care to send me any at that, you have to pay the express, I should be glad to have same."

Duquesne Club, Pittsburg, Penn. (Feb. 11, 1903): "Wish to know, if you have squabs of first quality. Should you have about three dozen on hand, I would pay you per dozen,

squabs plucked and delivered from \$3.59 to \$3.75 per dozen. If price suits you please let me know." Signed by E. Max Heinrich, superintendent.

Lincoln Hotel, Lincoln, Nebraska (Feb. 16, 1903): "Replying to your letter. We can use about two dozen squabs per week in our cafe at present. Will pay \$2.50 per dozen delivered here, feathers on."

Hotel Victoria, Pittsburg, Penn. (Feb. 18, 1903): "In regard to your letter, will say, we use about one dozen or one and one-half dozen per week, just depends on the business, and will pay \$3.50 per dozen delivered here at the hotel."

Fred Harvey, general office, Union Depot Annex, Kansas City, Missouri; Chicago office, corner 17th Street and Wentworth Avenue (Feb. 14, 1903): "We can use 15 to 20 dozen squabs per week if the birds are very nice and the price reasonable. Can use them with feathers on. Do not know what we can afford to pay, it depends entirely on the birds. If you will please send three dozen squabs by Santa Fe baggage car to Kansas City, charging them at such a price that you can afford to furnish them, I will use them as a sample. If the birds are not of the right quality and the price is too high, we will not need any more, but if the birds and price are right, we can use quantity given above. I enclose baggage car shipping bill; be careful to fill it out correctly. This bill is made in duplicate; you hold one copy as your receipt and the other goes with the birds. Please put the squabs in a small box with a little ice."

Hotel Savoy, Ewins-Childs Hotel Co., proprietors, Kansas City, Missouri (Feb. 16, 1903): "What is your lowest price on best squabs in five-dozen lots? We are not in the habit of sending out of town for our supplies, but if you have something better than we can get here, it is possible that we can do business with you." (Signed by George Thompson, steward).

Frank E. Miller, superintendent Dining Service, Missouri, Kansas & Texas Railway System, No. 707 Chestnut Street, St. Louis, Missouri (Feb. 16, 1903): "I have your favor relative to squabs. It is proper for you to state the price per dozen. We occupy eight or ten large dining stations and require a large number."

Hollenden Hotel, Cleveland, Ohio (Feb. 19, 1903): "In reply to your letter making inquiry regarding squabs I will state that we are paying \$3.00 per dozen for nice dressed squabs. We do not buy any unless they are fully dressed, no feathers on."

Louis A. Fisher, Manager Century Club, Cleveland, Ohio (Feb. 17, 1903): "We buy all our squabs in New York as the prices of three and four dollars per dozen prevailing in this city are too high—that is, we buy cheaper in New York than here."

A. S. Barnett, steward Morton House, Grand Rapids, Michigan (Feb. 11, 1903): "In

reply to your inquiry in regard to what we would pay for squabs such as you have, we are paying \$2.25 per dozen. Should you consider our price an object, would be pleased to learn how many you could furnish a week."

Hotel Schenlen, Pittsburg, Penn. (Feb. 10, 1903): "Your squabs must be according to the weight and you should find a ready market for such stock. Nice white squabs are bringing \$3.50 today."

Hotel Rider, Cambridge Springs, Penn. (Feb. 11, 1903): "We can pay you \$2.25 per dozen for genuine squabs (no pigeons) delivered here. Can use six or eight dozen at a time, but we do not want anything but young birds."

E. A. Goodrich & Co., commission merchants, 103 South Water Street, Chicago, Illinois (Feb. 13, 1903): "Your favor at hand. If you mean fat young pigeons that have left the nest and can fly, they are worth 75 cents to \$1 per dozen, and the trade wants them alive. (This is the way the trade in Boston wants them, but they pay more.) If you mean nestlings, or very young pigeons which have not left the nest and are unable to fly, we can get you \$2 to \$2.25 per dozen, dressed neatly. Either kind is good sale at prices named and can handle for you any quantity from five dozen to one hundred dozen. If nestlings, tie in one-half dozen bunches packed in ice and ship by express."

A FINAL WORD. Our object in printing the letters from marketmen and other squab buyers, in this appendix, is to convince any intelligent man or woman that there is a market for him, provided he goes to raising squabs, no matter where he lives. We have hundreds of similar letters on hand, but we have not room to print all, and we think we have printed enough. If you are not convinced by what we have printed that there is a paying market for squabs within five hundred miles of you, do not write to us and ask us to tell you the names and addresses of squab buyers in your town or city, or your county, for that we may not be able to do, but sit down at your writing desk, or go out in person, and find out for yourself.

It is unnecessary to argue the squab market with any one of common sense who lives east of the Mississippi and Missouri rivers, and on the Pacific Coast, and within shipping distance of Denver. If you live in a barren territory or a foreign country, and wish to take up this subject with us, we will reply to the best of our ability, but remember that you are on the ground, and can find out such facts for yourself better than we can tell you.

This Manual is intended to be a book of facts, backed up by evidence. If anybody has any additional facts as to squabs which will improve this Manual, we will be glad to consider same, and will pay for them if accepted.

APPENDIX B

Many interesting points with regard to squab raising, the management of a plant, and so forth, are disclosed by the letters which we receive from customers, and the following pages will repay reading as showing the practical side of the business.

The stories of success, letters from customers, which appear in this Appendix B, were received by us in 1905, along with hundreds of others of similar character. These show results duplicated over and over again by our customers, and they came to us in the ordinary run of business, day by day.

We do not print the names and addresses of these customers. Many of them are regular buyers of our birds. We would advertise them as breeders to our loss. We guarantee the genuineness of the letters here printed, and will prove it in any way desired. The originals are on file at our office at Boston and may be seen there.

Here are stories which tell of hardy, vigorous parent stock; of one-pound squabs; of quick results from a small purchase; of flocks from us bred for years without a single death; of remarkable breeding qualities; of handsome Homers which attract admiration wherever they go; of prizes won at fairs; of excellence demonstrated over Homers of any breeding in every State; of many women who are making success with our birds; of customers who started with small flocks and later bought of us by the hundred pairs; etc.

See page 153 for the difference between sand and grit. Same page also for conditions in Florida.

See page 155 for points about moulting.

On page 157 read what a correspondent says about inbreeding, and the author's reply; also causes of failure in squab raising.

More about the excellent market for squabs in the State of Washington is given on page 159.

Breeding without having any sickness or deaths is told on pages 159 and 160.

The experience of a squab breeder with five hundred common pigeons is told on page 164.

OUR PLYMOUTH ROCK HOMERS ARE STRONG IN AND AROUND BRIDGETON, NEW JERSEY, WHERE THERE ARE SOME CRITICAL BUYERS AND BREEDERS—READ THIS LETTER FROM A CUSTOMER IN SOUTH VINELAND. Will you kindly let me know when is the best time for me to buy more pigeons, as those I bought of you three years ago are doing finely, and I am perfectly satisfied with them and I tell people where I got them, and several persons told me they were going to send for some from you. There are lots of people come to see them, as they are fine birds, and when I send for more I want them mated like the ones I got before; but I will not send until I hear from you. I got twenty-four pairs the last time. There were two that died a little while after I got them, but that was all I lost.—O. W., New Jersey. (This customer lives in South Vineland, New Jersey, a few miles from Bridgeton, New Jersey, and in this territory are a

great many pigeon fanciers. We have sold more Plymouth Rock Homers in this [Cumberland] county, around Bridgeton, than any breeder or set of breeders in that county, and the reason for it is just what our customer in South Vineland states above.)

SAND IS NOT GRIT—CONDITIONS IN FLORIDA, AND SOMETHING ABOUT THE GREAT MARKET THERE. I have plenty of beach sand and would like to know if you really need to ship me the grit, for I am going to cover the ground of the flying pen with the sand.—J. S., Florida.

Answer: Gravel is grit, but sand is not grit. It is all right to cover the ground of the flying pen with sand and use sand generally about the squab house. In Florida there is nothing but sand, and this is true of other localities also. I wish everybody who has pigeons or poultry would read and remember what I say about sand and grit. Sand

LETTERS FROM CUSTOMERS RECEIVED BY PLYMOUTH ROCK SQUAB COMPANY

STORIES OF SUCCESS WITH PLYMOUTH ROCK HOMERS

is the product of the washing of the ocean's waters. This incessant beating and washing have worn off all the sharp corners. As a matter of fact (as skillful breeders of poultry in Florida know), if the birds can get no grit and are forced to eat sand, then the sand which they eat packs tight within them, and if you cut open one which has died from some inexplicable cause, you will find the bunch of sand. It is not grit at all, and does not cut and grind the grain as grit does. This is the cause for many failures with poultry in Florida.—lack of grit. The breeder thinks he has grit all around him, when he has none. It is all right to cover the flying pen with sand; it is clean stuff and the pigeons will not eat it unless they are forced to by their owner's failure to provide grit. Make no mistake, pigeons can tell grit from sand. For further remarks on grit see **Supplement to Manual**. It is fully as important as grain and grain is not good for anything without it. Just a word about the Florida squab outlook while I am answering this Florida query. I spent four months in the winter of 1905, in Dade County, three hundred miles south of Jacksonville, to get rid of a cough. I found three of my customers in and around Palm Beach. One lived in Jupiter and was raising them all right but the market was not to his liking, and he was a good man, too. Another at Mangonia, two miles from Palm Beach, was an experienced poultry man, and he was a good business man. Although well-to-do, he gets on his bicycle every day during the winter season and sells his poultry and eggs to the rich cottagers at first hand. You would not believe me if I told you what prices he gets. As for squabs, I state here with full knowledge of the facts, that any number of squabs may be sold in Palm Beach from January 1 to April 1, for \$1 apiece, \$12 a dozen provided they are good squabs, such as Plymouth Rock Homers breed. The Hotel Royal Ponciana at Palm Beach (called the largest in the world) the winter I was there had fifty-two thousand separate names on its register in its three months' season. These were the richest people in Florida for amusement, and accustomed to the choicest table delicacies. This is only one hotel; there are many others, including the chain of great Flagler hotels from St. Augustine to Miami and Nassau. Who also in Florida has the business sense to see an opportunity and follow it up by providing these tens of thousands of rich northern people every winter with squabs? I always considered California the ideal climate for breeding squabs, but Florida is just as good; it is perpetual summer there and the winter market beats anything I have ever seen or heard of. As for the summer and fall market, it is not good for much. If you must sell squabs and poultry then to keep a-going, you will have to ship North by the

Clyde line, or else sell your goods to native folks at about half the price you get from northern sojourners in the winter.

WOMAN HAS RAISED ONE HUNDRED PAIRS. Two years ago we bought some pigeons of you. We have some fine ones now, about two hundred, or one hundred pairs.—Mrs. W. B., Pennsylvania.

BRED SATISFACTORILY ALL WINTER. Enclosed find money order for supplies, etc. I have some stock whose parents came from you and can say they are certainly all you claim for them. They have bred satisfactorily all winter and bid fair to continue.—R. A. S., Massachusetts.

SYSTEM AND DIRECTIONS PERFECT. Your system and directions for handling birds are about perfect, and your Manual is almost indispensable for any one who is in the pigeon business. The drinking fountain, bath pan and nest bowls reached me. They are just what I have been looking for for a long time.—Mrs. H. J. S., Pennsylvania.

VIRGINIA WOMAN ORDERS A SECOND LOT. My pigeons came safely Saturday morning and are exceedingly fine birds. I like them so much that I enclose remittance for another lot.—Miss A. M. D., Virginia.

THEY PLEASE EVERYBODY. The one dozen pairs of Extra Plymouth Rock Homers I received from you on November 9 are all doing well. Quite a number of persons have seen the birds and all seem to think them fine.—W. B. R., New York.

RUGGED STOCK. HE HAS LOST BUT FEW EGGS AND BIRDS IN HIS EXPERIENCE. I now have in my flock about two hundred birds which are producing squabs rapidly and seem to be doing well. Have lost but few eggs or birds during my experience. I have two parties figuring to buy me out. I have been enlarging my plant and will divide the flock unless I sell. I will send for more nest bowls in case I do not sell out.—H. H. K., Missouri.

STRENGTH AND VIGOR OF OUR STOCK SHOWN BY AN EXCELLENT JOURNEY TO CALIFORNIA. The pigeons you shipped me on the 2d reached me the 9th in excellent condition. The first thing they had after being put in the squab house was a bath, and I never saw anything more grateful than they seemed to be. I am glad you sent the extra pair of birds. I think the way the birds stood the long, trying trip speaks volumes for the strength and vigor of the flock. Thank you for the promptness with which the order was filled.—Mrs. J. F. P., California.

LETTERS FROM CUSTOMERS RECEIVED BY PLYMOUTH ROCK SQUAB COMPANY

STORIES OF SUCCESS WITH PLYMOUTH ROCK HOMERS

SOON TO SEND FOR MORE BIRDS. Enclosed find money order for \$2.88, for which please send to my address three dozen nest bowls for pigeons. My birds that I got of you last fall are doing well. Thanking you for past favors, and that soon I am sending for more birds.—Mrs. M. H. P., Connecticut.

PIGEONS WERE MOULTING. Can you explain to me why my birds start in and make their nests and then stop? They have done very little since October (it is now December). They are looking fine. They are all mated. Their house is cleaned twice a week. They are free from lice. They have shell, salt and codfish in front of them all the time, no rats or mice to trouble them. I have about sixty. The house is twelve by thirty. The house is not cold. They have plenty of nest material. **Not a sick or dumpish bird in the lot.** If you can tell me what else I can do, you will confer a great favor. I bought my birds of you in May, twelve pairs. I have over sixty; do you think they have done well?—F. E. G., New York.

Answer: If you had applied to one of the know-it-alls (who know nothing about pigeons), he would have told you that your trouble came from the fact that you did not originally buy your birds from him, but the simple truth is that your birds were moulting late, and would not lay until through shedding their feathers and getting their new coats.

GOOD GRAIN NEEDED FOR GOOD BIRDS. Enclosed find remittance for one hundred pounds best red wheat and one hundred pounds hempseed. I have had hard work to get good red wheat lately, and I find it poor practice to feed the inferior grain, as the birds scatter it all over the house, so thought I would try and get some from you. I think my birds are doing first class, and I intend to put in two or three more lots as soon as I can arrange for them.—C. E. B., New Hampshire.

CONVINCED HIM THAT THEY ARE PROFITABLE. About a year ago I bought from you half a dozen pairs of Homer pigeons, and at present time they number over fifty birds. The way they have increased and the little, but necessary, care they need convinces me that they must be profitable. I enclose twenty-five cents for the working plans for enlarged house, which I intend to build as soon as the weather permits, with the idea of stocking it in the early spring.—H. B. R., New York

MORE THAN PLEASED IN ARKANSAS. The pigeons that you shipped arrived here O. K.—twenty-six in all. Many thanks for the extra pair. They are doing fine, and I am more than pleased with them, and hope to send for more soon.—A. H., Arkansas.

SATISFIED WITH SQUAB HOUSE AND BIRDS. The pigeons and also the letter stating they were shipped arrived yesterday morning at nine o'clock. This certainly was fast time from Boston as the stamp of your letter showed 5.30 p.m., forty-eight hours previous. To say that we are pleased with the birds does not express it. They are certainly fine birds, and we will try to do our part to make a success of the business. We built our houses after the plans given in your squab book, and are well pleased with them. As soon as we get them painted we will send you photographs of them so you can see where we keep our birds and how we care for them. The birds were all in good shape and seem to have received good care from the express company.—H. A. B., Illinois.

DOING NICELY. Enclosed find stamps for which please send me some aluminum tubing for leg bands. The birds we bought from you are doing nicely.—A. H. W., Pennsylvania.

GOING TO SELL HIS COMMON PIGEONS —EXTRA PLYMOUTH ROCKS THE BEST BREEDERS TO BE HAD. I have had pigeons only about a year. At present I have about seventy, half Homer and half common pigeons. I am going to sell the common pigeons, and in the fall you shall have my order for breeders. I think your Extra Plymouth Rock Homers are the best breeders that are to be had. Mrs. Street, who lives here has some of your Homers, and I think they are all you claim for them.—W. W. P., Arizona.

FINE AND HEALTHY. Enclosed find \$1.70 in two-cent stamps, for which please send me the leg-band outfit. My birds are doing very nicely. They look fine and are very healthy.—C. C. R., Pennsylvania.

FIRST SHIPMENT DOING WELL, SO HE ORDERS ANOTHER. Enclosed find money order for which send eighteen pairs and four dozen nest-bowls. The first order of mine was received O. K. The birds are doing fine.—N. S. R., Iowa.

FAST WORK—HAS NOT HAD HIS BIRDS A MONTH, BUT HAS PLENTY OF NESTS, AND SQUABS ARE DUE. I am very agreeably surprised with the pigeons which you sent me. I received them on May 18. They were so quiet and seemed so much at home that I let them into the fly on the 22d and had no trouble with them. They went in and out and did not have to bother with them. On May 24 I received the nest-bowls and put them in the house the same afternoon. The next day one of them commenced to make a nest and lay. She is setting now and should hatch about the 16th of June; so I think I will have some squabs before I have had the pigeons a month. I think this is pretty fast

LETTERS FROM CUSTOMERS RECEIVED BY PLYMOUTH ROCK SQUAB COMPANY

OUR PLYMOUTH ROCK HOMERS ARE BOUGHT AND BRED BY THE UNITED STATES GOVERNMENT AT WASHINGTON

The Plymouth Rock Homers are being bred by the United States Government at Washington successfully and satisfactorily, exactly according to our Manual and the directions which we give our thousands of customers. The Government buys our birds because they are the best.

The first lot of our Extra Homers which we shipped Uncle Sam brought us back a letter from the superintendent saying: "The birds were **in perfect condition** with the exception of a single individual whose eye had been injured. **I am very much pleased with the pigeons, which are certainly a fine lot.**"

The birds did well and a return order for more birds came to us later from the Government, the order stating: "Referring to my letter of March 24, I have the pleasure to inform you that the pigeons received from you have now become **satisfactorily established** in their new quarters, **and it seems that we can advantageously increase our stock.**"

To fulfil the United States Government specifications, breeding stock shipped as per orders given us had to be not only the best of its kind, but absolutely healthy. One pigeon in the first shipment died after a time and the remains were turned over to the biological department of the Department of Agriculture, for a microscopical examination to discover germs of contagion. None was found, and the flock continued in rugged health.

It is a compliment to us and a good advertisement for us, for the United States Government to buy our breeding stock.

THE STATE OF WISCONSIN

is another of our customers, having bought an outfit of both birds and supplies for its Northern Hospital for the Insane.

We have supplied many well-known American families with squab-breeding flocks and outfits, including the Rockefellers, Carnegies, Goulds, etc. These very rich people, accustomed to the best table delicacies, breed their own squabs from our birds, because in this way only can they be assured of a steady supply of unvarying excellence, the markets and the breeders of ordinary squabs not being dependable. Some of our customers have exclusive contracts with rich families who take all they breed. One customer, a woman, supplies the Brandegees, multi-millionaires of Boston. The Carnegies have a large estate in Florida. Three years ago we received a trial order for twelve pairs of our best birds from one of the ladies of this household. She did so well breeding squabs and was so well pleased with our birds, that the manager of the farm visited us in the summer of 1907 and gave us a large order for Plymouth Rock Homers and supplies which later we shipped to Florida.

STORIES OF SUCCESS WITH PLYMOUTH ROCK HOMERS

work. Several more are making nests and laying. I thank you very much for sending me the fine stock which you did. One of my friends told me the other day that he had written to you last fall about your pigeons but had never received an answer from you. I told him his letter must have miscarried. He is starting in the squab business with common pigeons, and they will be likely to fail. My birds have been greatly admired by all that have seen them, and I hope to interest some of my friends in your Homers. Thank you for fair treatment.—E. W. T., New Jersey.

BETTER HOMERS THAN THIS ILLINOIS CUSTOMER EXPECTED TO GET. My fifty pairs of pigeons arrived safe and sound yesterday. They are fine birds, better than I expected. The express was \$5.05, which was reasonable enough. If these birds do well will order fifty pairs more in December. Thank you for your prompt and square way of doing business.—C. D. P., Illinois.

HIS EXPERIENCE WITH RUNTS A FAILURE. I have been raising squabs from runt pigeons and have lost so much on them that I cannot afford to risk any more money on stock which may turn out to be as bad as some that has been passed off on me. Please give me your prices on your Extra Homers and nest-bowls.—G. W. M., Pennsylvania.

PRETTY BIRDS IN TEXAS, ALWAYS HEALTHY, NEVER SICK. You will remember that I bought six pairs of birds from you last July. I have now about twenty pairs on hand as nice and pretty birds as you ever saw, well marked. They are perfectly healthy, never sick.—Mrs. L. C., Texas.

PLYMOUTH ROCK HOMERS HAVE MORE THAN COME UP TO HIS EXPECTATIONS. My intentions are at present to give fifty pairs of your birds a thorough trial for one year, and if it proves successful I intend to move my place near New York City and then increase it to one thousand pairs to start with. The birds I received from you have more than come up to my expectations, and if the business moves along as it has I do not think I will hesitate one moment next spring to increase my flock to the amount stated. Thank you for past favors.—J. D., New York.

BREEDING WELL IN FLORIDA. Enclosed find money order for \$1.70 for which please send me by mail your leg-band outfit. My birds are doing finely. I wish I had twice as many, but must be contented with these at present. The young squabs are leaving the nests every day or so.—G. A. G., Florida.

LOUISIANA CUSTOMER BRED THEM. Enclosed herewith find money order for fifty cents, for which please send me your squab book also quote me your best prices on birds, drinking fountains, etc. You sold me twelve pairs of your pigeons and shipped them to Wilson, Louisiana, and I like them very much, and they did all you claim for them.—T. J. C., Louisiana.

QUICK WORK IN OHIO. The birds arrived Saturday, May 6, and on Saturday the 13th three had laid and were setting. Today, May 16, five are setting and one odd egg is in another nest without the nesting material.—C. G. A., Iowa.

NO AILMENTS AND BREEDING SATISFACTORILY. The birds ordered of you on the 13th were received on the 16th, and find them the same as the other order—satisfactory in every respect. I also wish to thank you for the extra pair. My first order of birds, which I received from you five weeks ago, are doing finely—no pigeon ailments. I have squabs, and the majority of them are hatching.—D. & S., New York.

SOMETHING ABOUT INBREEDING, TOGETHER WITH REMARKS ON WHY SOME PEOPLE FAIL AT SQUAB BREEDING. Enclosed find draft for \$40 for which please ship per Adams or Southern Express, to above address, twenty-four pairs Plymouth Rock Homer pigeons. Will want four times as many more if these prove satisfactory. I was quite interested in your National Standard Squab Book, but am a little inclined to criticize some statements. On page 41, it seems to me it would be well to substitute gizzard, for crop, when describing the necessity for grit in the digestive process, and in your comments on inbreeding, you evidently lose sight of the fact that in all doves and pigeons, in the wild or natural state, the young hatch in pairs, male and female, almost invariably, and that they almost invariably mate, and have done so for centuries without deterioration. The Gentry swine, which took about all of the high prizes at St. Louis, have been incestuously inbred for twenty-five years. The Hart herd of Jerseys, finest in the State of Ohio, have been bred sire to daughter, son to mother, brother to sister for ten generations, and have constantly improved in size, vigor and productiveness. The Bishop merinos started with three animals and never had a drop of outside blood in forty years, and were then the finest in the world. So there is nothing to be feared from inbreeding if stock is well cared for and ordinary intelligence is used.—H. R. C., Ohio.

Answer: Good; I am glad to get that kind of a letter because it shows that the writer is

LETTERS FROM CUSTOMERS RECEIVED BY PLYMOUTH ROCK SQUAB COMPANY

STORIES OF SUCCESS WITH PLYMOUTH ROCK HOMERS

able to think for himself. However, I do not inbreed pigeons, and I do not think you have authority for making the sweeping statement that in a wild state the pigeons almost invariably mate in pairs as they were hatched. I will prove that to you right now by asking you, Have you not seen male pigeons, both in a wild state and domesticated, fighting for the possession of a female? Certainly, we all have; it is an every-day occurrence among pigeons, depending on a hundred different notions which may form in the minds of the pigeons. This domination of the strongest and handsomest over the weakest and ugliest is the law of life among human beings as well as animals. This survival of the fittest would not be true if it was the law and the rule and the custom, call it what you will, for nest-mates to mate for the reason of propinquity alone. Now, as a matter of fact I know that there are a great many Homer fanciers in this country, mostly Englishmen, who have bred pigeons all their lives, who win prizes with Homers as well as other kinds of pigeons, which are the product of inbreeding. There are a dozen fanciers within fifty miles of my plant in Massachusetts who come to my place regularly and there pick out young birds which we band with seamless bands for them and sell them when weaned, and I know for a fact because some have told me so, that they take these birds and inbreed them. However, as a matter of business, it would not do for me or for anybody selling pigeons in the open market to inbreed them, because there is a sort of horror, a repugnance, among people generally, especially women, against that sort of thing. Nearly half my trade is among women, and I think that as a rule they master pigeons better than men, and I don't think I would sell to many women if I advocated and practised inbreeding. If you are a follower of poultry, you will read advice from many theorists and impractical men, who work eight hours a day at something else, but who will sit at a desk in their evening hours and with a pen direct breeding operations for anybody offhand, and one of the stock remarks of these folks, unable to follow their own ideas in breeding successfully is, when some one writes them that his or her pigeons are not raising young satisfactorily: "Your pigeons are probably inbred, and are worthless, being weak." It is a foolish and senseless remark, because it is a guess, and nothing more. In my *Manual* I decry inbreeding and, as I say, do not practise it, because I do not think it is nature's way. An animal wants a handsome and attractive, or otherwise satisfactory mate, and is willing to fight for it—this is nature's way. While I am on this subject, I will tell you people fail, as some do, with pigeons. There are generally men and women who have failed with poultry, and with everything. It is their fault, not the fault of the pigeons. If they start with pigeons, strong and rugged

birds, it is up to them to get results. I have seen people start with pigeons who absolutely could not get an egg or a squab to amount to anything for months, and then sell out to somebody of sense and gumption who inside of a month would be doing so well with the birds that he would buy more. Is this surprising? Not if you have had much experience with people and their habits. There is a large percentage of folks who cannot manage their own eating and drinking right; their bowels are always out of order; they are dosing with patent medicines; they seldom or never bathe. Others who look after themselves perhaps better cannot do the simplest things of life successfully; cannot write their names legibly; cannot compose a letter and address the envelope correctly; cannot manage their children so as to hold their respect; cannot keep friends with their neighbors; cannot earn money, or cannot save it; and so on. Yet many of these people (and there are hundreds of them who turn to a new thing like squabs for the long-sought touchstone) will take hold of animal breeding, requiring at the outset, and all the time, the sterling qualities of patience and common sense, not to speak of some degree of skill which must be acquired, and then wonder why they fail. From squabs they go to bees, or vice versa, or to ginseng or pecan nuts, or truck gardening, or poultry, but never back again to something at which they have failed. The Creator put these things into the world, and the devil has put many temptations along too, to winnow out people, to separate by their own acts the wise from the foolish, the skilful from the unskilful, the good from the bad, etc. The acquisition of a flock of pigeons, or anything else, will not turn a poor tool into a good one.

SPEAKS OF US IN HIGHEST TERMS.

Enclosed find draft on New York in \$10.25, for which please ship me four hundred pounds mixed pigeon grain. My Homers are doing nicely. I have only lost one more bird, two in all. Quite a number are laying, a few setting. It affords me pleasure to speak in the highest terms of the *Plymouth Rock Squab Company*.
—W. B. W., Arkansas.

ONE BIRD SICK, THE ONLY ONE IN A YEAR AND A HALF OF BREEDING. You no doubt remember me as one who purchased two lots of Homers from you a year ago last January. I am now prepared to sell squabs as my enclosed card will show you. I send you this card to show you that I have not been asleep in the business, and that I have given constant care to the flock ever since the first day I asked you, What is a squab? Ha, ha. It makes me laugh to think that I was so green. I now have one good customer here who gives me \$3 a dozen for them, but he says they are not selling very fast this time of year (May). Others said, when I presented

LETTERS FROM CUSTOMERS RECEIVED BY PLYMOUTH ROCK SQUAB COMPANY

STORIES OF SUCCESS WITH PLYMOUTH ROCK HOMERS

my card, that they would think it over and let me know. One fellow wanted to give me \$2.10 per dozen; what do you think of that? He did not get them, I assure you. I have no other birds except those I received from you, and I have not had a sick one among them in the year and a half, with the exception of one that had a large lump on its wing. I painted this with iodine. It moped around for six weeks or more but now it and its faithful mate are building a nest. Here is a strange freak of nature which puzzles me. I have a pair of young birds that always lay four eggs. The first four did not hatch. Out of the next four they hatched one bird. The third, also four eggs and one bird. I have separated them as I found them to be nest mates. My object in writing this letter to you, besides informing you of my success thus far, is to ask for the address of some one, not too far from me, to whom I can sell my squabs at this time of the year. One man wrote to me and said he would buy all I raised "if I bought the breeders from him." But my first thoughts were, of course, to see you first.—F. B., Ohio. (We told this customer where to ship in New York City, and he shipped accordingly and received satisfactory prices).

STARTED WITH 24 OF OUR BIRDS IN 1902, AND NOW HAS 700 OF THE FINEST EVER SEEN. In July of 1902 I bought twenty-four birds, Homer pigeons for breeders, from you. I now have seven hundred of as fine-looking birds as any one ever saw and all full blooded for which I thank you for the good stock sent me.—C. E. L., Michigan.

FIRST ORDER FOLLOWED BY A SECOND. The six pairs of pigeons were received O. K. Enclosed please find New York draft for \$21.92, for which please send me twelve pairs Homers and two dozen nest-bowls.—D. C. S., Minnesota. (A third order followed inside of a month from this customer.)

SQUABS SURPASSING ALL EXPECTATIONS AND BRINGING \$5.50 PER DOZEN. Could you furnish me with a price-list of breeding stock and supplies as I have misplaced the one you sent me last spring with my National Standard Squab Book. I desire to state that the Homers are surpassing all expectations along the line of squabs and I have been getting as high as \$5.50 for them in New York. Wishing you continued success in your honest dealings.—A. H. T., Ohio.

FIRST ORDER QUICKLY FOLLOWED BY ANOTHER. The twenty-four pairs of Extra Homers were received in good form as you know, and are so satisfactory that I desire to duplicate the order and enclose herewith an Adams Express money order. Please send us twenty-four pairs as good as the others as soon as possible.—G. P. W., Connecticut.

FLOCK DOUBLED IN THREE WINTER MONTHS. I bought some pigeons from you about Christmas. I am pleased more than I expected to be with them. They are doing nicely. I have doubled my lot with squabs from them. I want to ask you if it would be safe to let them out into the flying pen now. You see I have had them about three months now.—A. S., Virginia.

THE STATE OF WASHINGTON IS CERTAINLY ALL RIGHT FOR SQUAB BREEDING—WE ARE SHIPPING THERE STEADILY. Enclosed you will find a Great Northern Express money order for \$80, for which I want you to ship me forty-eight pairs of your thoroughbred Homers as soon as possible for you to do so. I sent some time ago to you for a free book on squab raising and since then have read up your National Standard Squab Book on squabs and looked up the markets in Seattle and Everett. I find that there is a better market for squabs than anything else I know of at present, and I am going to devote all my time to raising them. I have a building almost completed for the first forty-eight pairs. Just as soon as I get them settled to business I will send for forty-eight pairs more. I have seen two or three flocks of your birds near Seattle and must say they look like business if given half a chance. The owners seemed well satisfied with them, but I think they would be more so if the birds were given the right attention, which they did not look to have.—G. T., State of Washington.

BEST LOOKING BIRDS THE EXPRESSMAN HAD EVER SEEN. The birds arrived here yesterday in good order. They are beauties. The expressman said that they had lots of birds pass through here, but these were the best he had ever seen. Thank you for the extra two pairs which you sent, and for such fine birds. I shall build a fifteen or twenty unit house just as soon as it gets a little warmer, and I shall want a lot of your best Extras to fill it; none but the best for me.—H. A. D., Massachusetts.

WANTS THE PURE STOCK. You will soon get another order from me, because I want the pure stock and the Plymouth Rock Squab Company is the only place to get them.—A. C. F., Oregon.

MANUAL GOOD, SANE AND PRACTICAL—MODEL OF GOOD ENGLISH—GOOD WORK APPRECIATED. I have your favor of the 19th inst., also the Manual, and beg to thank you for both. I have read your book very carefully. It is not one of my habits to go out of the ordinary course in matters of business; but I think I know good, sane, practical work of almost any kind when I see it. If you will allow me to say so, your

LETTERS FROM CUSTOMERS RECEIVED BY PLYMOUTH ROCK SQUAB COMPANY

STORIES OF SUCCESS WITH PLYMOUTH ROCK HOMERS

Manual is, from every point of view, that is, as a business book, a model of the rare thing called "good" English, and almost as a Naturalist's standard work—the best thing I ever saw. This letter does not call for reply, but it does no harm to anyone to know that a good piece of his work is recognized and appreciated by some one else who believes in and strives to do good work himself. I wish you continued success.—F. G. A., San Francisco.

HIS NEIGHBOR HAS DONE WELL FOR NINE MONTHS AND WILL NOT SELL ANY. The pigeons came two hours ahead of your letter informing me of the shipment. They arrived in fine condition, had plenty of feed and water, and were delivered promptly, and I am pleased with them. They are beauties. My neighbor, Mr. Cole, bought six pairs from you last June and now, nine months later, has nearly fifty pigeons, and will not sell one of them at any price. I tried all over this city of sixty thousand people to buy six pairs of pigeons and could find only one pair for sale. I return basket today. Please accept thanks for your prompt delivery.—R. M. T., Ohio.

TREATED IN AN HONEST AND GENEROUS MANNER. My pigeons arrived yesterday morning in perfect condition and I am delighted with them. They are beauties, and I want to say you have kept your word to the letter and treated me in an honest and generous manner. Return basket today.—Mrs. A. L., Illinois.

HE IS PROUD OF HIS FIRST PURCHASE. My pigeons arrived safely Saturday in fine shape, not even soiled. I am very much pleased with them and thank you for the extra pair. They are a fine lot of birds, and I am proud of them. You will hear from me from time to time.—V. M., Virginia.

CANADIAN CUSTOMERS PLEASSED. I take pleasure in letting you know we received our stock in very good condition. We received them one day before we got your letter. We got them home and with much surprise we counted fourteen instead of twelve. We return many thanks to you for your kindness and liberality. They are doing nicely at present. They are lovely birds.—L. B. S., Ontario, Canada.

FIFTY PAIRS TO START—THESE DID WELL ENOUGH TO MAKE THE CUSTOMER RUN HIS ORDER UP TO THREE HUNDRED PAIRS IN THREE MONTHS. Enclosed find check for \$125, for which please send us fifty pairs of your extra breeding stock. Hoping same will be satisfactory, and if pleased with stock will probably want more soon. Please ship first of next week if

convenient. (Three months later.) Enclosed find check for \$385, for which please send me two hundred and fifty pairs Extra Homer breeding pigeons. I have taken credit of \$40 on the first order as I was informed at your office when down there, if the order was made three hundred pairs within three months I could have a rebate on them. Hope this is satisfactory.—C. W. P., Rhode Island.

BEST BIRDS EVER SEEN IN NEW JERSEY. The birds you shipped me are a fine-looking lot, and I think are the best I have ever seen.—H. J. F., New Jersey.

FILL REPRESENTATIONS TO THE LETTER. The pigeons arrived safe and sound. They fill your representations to the letter. I am more than pleased with them and wish you all the success that honest dealing entitles you to.—C. A. V., New York.

HE EXHIBITED HIS PLYMOUTH ROCK HOMERS AT THE FAIR AND WON WITH THEM. I took some of my pigeons bought of you to our Fair and got first and second premiums. I have taken good care of them.—W. A. C., New York.

"WHAT FINE BIRDS, AND HOW LARGE THEY ARE." I received the pigeons all right. Every one who sees the birds says, "What fine birds, and how large they are. I never saw such large pigeons before!" and it is just what I think. Thank you for sending such fine birds.—S. L., Michigan.

TO FLORIDA IN FINE CONDITION. I received the birds shipped by you to me last Friday, having made the trip in fine condition, and I feel proud of them. They are certainly beauties.—A. C. H., Florida.

HE HAS NOT LOST A BIRD, YOUNG OR OLD, IN BREEDING FROM PLYMOUTH ROCK STOCK. Will you please give me address of parties who buy pigeon manure? The birds purchased of you one year ago next month have done well. I have not disposed of any and have not lost one young or old. It has caused considerable talk hereabout, for many parties have pigeons and have lost many of them. Newcomb who bought a few of you on my advice, told me he wished he had bought all of you, but he bought of several other sources and has been dissatisfied. I have about completed my big house and shall soon call on you for more birds.—A. P., Massachusetts.

THIS WOMAN IN CONNECTICUT OUT-GREW ONE HOUSE AND BUILT UP INTO A FINE PLANT. It is some time since you heard from me and so I will write a few lines to show how I am getting along with my pigeons. They are doing fine. I have squabs all ages. I have about thirty-five pairs of old

LETTERS FROM CUSTOMERS RECEIVED BY PLYMOUTH ROCK SQUAB COMPANY

STORIES OF SUCCESS WITH PLYMOUTH ROCK HOMERS

ones. I have put up a large house for them. The other one was not large enough, so when I get them in a large place, I think I will have a fine plant.—Mrs. M. K., Connecticut.

ANOTHER WOMAN HAS INCREASED HER FLOCK FROM 25 PAIRS TO 275 BIRDS IN A YEAR. You will recall that I purchased twenty-five pairs of breeding stock from you about one year ago. They are all doing nicely now and I have about two hundred and seventy-five birds, all in fine condition.—Mrs. J. F., Connecticut.

GOING TO BRANCH OUT. My birds bought of you are doing fine and I am going to branch out into the business. I will move from New Hampshire to Bridgewater, Mass., in the spring and build a large house and put in all your birds.—H. G., New Hampshire.

LARGE FLOCK RAISED FROM A START WITH SIX PAIRS EXTRA. I would like one hundred bands from you, as I need them now for young birds. The six pairs Extra I bought of you March 23, 1903, have done fine, and I have a large flock raised from them.—L. B. R. B., Massachusetts.

BREEDING ALL THE TIME IN MAINE. I have got about one hundred birds now, all raised from those I bought from you last spring. They are all right, healthy and breeding all the time.—J. W. S., Maine.

GONE TO WORK IN A NEW HOME IN DEAD EARNEST. The nappies arrived all right, and we are well pleased with them. Our birds have gone to work in their new forty-foot house in dead earnest. Enclosed please find Pacific Express money order, for which please ship us by express No. 1 Plymouth Rock Homers and Extra Plymouth Rock Homers as specified. Kindly rush this order.—J. A. P., Missouri.

WORKING RIGHT ALONG IN ALABAMA. Enclosed you will find a post-office order amounting to \$15 for which please send me six pairs of Extra Homers. This is my second order and I will expect some extra fine birds. The birds purchased of you last February are working right along.—B. W., Alabama.

THIS MAN HAD SOME FINE HOMERS, BUT WHEN HE SAW THE PLYMOUTH ROCKS HE HAD TO WILT. Our birds are doing fine and breeding rapidly. There is a man about one and a half miles from our place who thought he could not be beat with his crowd of pigeons, but I invited him to my place and showed him my birds. He gave in right away; he was not in it alongside of my birds. The size of my squabs at three or four weeks set him a-guessing. He wanted to buy

of me right away, but no, I told him he should purchase from Boston, for I did not have enough myself yet. I have a pair I do not think four months old yet, and they set and have a pair of splendid squabs out just bursting with flesh. A person would be surprised to see the flock that I have out of the small number of birds that I bought last fall in September.—J. B., New York.

FOLLOWED DIRECTIONS AND THE BIRDS WERE QUICKLY NEST BUILDING. Please pardon my delay in not announcing the safe arrival of the thirteen pairs of fine Homer pigeons. I followed your directions as near as I could, and I am glad to say the birds are already laying and building nests. I returned the basket today. I understand that my brother ordered twelve pairs of birds for me, but thirteen came. Please accept thanks for the extra pair.—Mrs. D. W. S., Georgia.

STARTED IN 1902 WITH OUR BIRDS AND HAS A FINE FLOCK NOW. In October, 1902, you sent me at Oak Park, Illinois, forty-eight pairs. I came to this place two years ago and now have my lofts filled and am ready to sell. I have three hundred pairs mated and at work. They are as nice birds as you sent me.—H. W. C., Michigan.

BIRDS PROVING THEMSELVES VERY SUCCESSFUL. Being pleased with the Homers you sent us and finding we have room in our building for another dozen birds, we forward you an express money order for \$16.92, for which forward six pairs of Extra Plymouth Rock Homers and two dozen nest-bowls. The birds are proving themselves very successful. Already we have five pairs on nests.—I. D., New York.

INSTRUCTIONS CLEAR—AND PEOPLE WHO FOLLOW THEM ARE SUCCESSFUL. I have your instruction book, the National Standard Squab Book. It is the clearest thing in the way of a guide book that I have ever seen.—C. F. W., Oregon.

STARTED WITH EIGHT PAIRS EXTRA AND NOW HAS FORTY-FOUR. Enclosed find fifty cents for which please send me at once that much leg-banding material. I need the leg-banding material badly. My birds are just simply doing fine. I have eighty-eight fine birds now. I think that is doing finely for the time I have had them, and had such a few to start on. I started with eight pairs.—Miss S. S. G., Louisiana.

THE VERY FINEST. The pigeons arrived on time and in good shape. We had some very fine birds but no better than these. Thank you for your prompt attention.—A. E. B., Pennsylvania.

LETTERS FROM CUSTOMERS RECEIVED BY PLYMOUTH ROCK SQUAB COMPANY

OUR PIGEONS SHIPPED NINE THOUSAND MILES, ALL ARRIVING ALIVE; ONLY TWO OUT OF CONDITION

Elmer C. Rice, Esq., Treasurer,
Plymouth Rock Squab Co., Boston, Mass., U. S. A.

Dear Sir: On the 20th of this month I had the pleasure of receiving the fourteen pairs of Plymouth Rock Homer pigeons. They were in fine condition and had been well looked after on the voyage, which lasted fifty-five days, from New York to Colombo. There had been some wars amongst the pigeons on the voyage; and two were more or less mauled, but they had been kept separate and will, no doubt, do quite well. I am very much pleased with them and thank you again for your kindness.

Yours truly,
(Mrs.) F. I. SINCLAIR.

Colombo, Ceylon, September 28, 1907.

Note by E. C. Rice: With regard to the distance covered by the above shipment, the agents of the steamship company write me as follows: "The actual nautical miles from New York to Colombo are about 8600, and the SS. Swazi before arriving at Colombo stopped at Algiers, Port Said, Aden, Tuticorin and other ports, which brings the total nautical miles up to about 9000."

The following is from the Philadelphia *Saturday Evening Post*:

MONEY IN SQUABS—The Government gives a practical demonstration of what they can be made to pay.

It has long been known by practical breeders of poultry that there is money in raising squabs. Now the United States Government has given to this fact official confirmation, based on scientific tests.

The record of profit reveals the great opportunity awaiting those who engage in this industry. In the practical experiments conducted the diet of the birds consisted of wheat at eighty cents a bushel, sifted cracked corn at \$1 a hundred weight, Kaffir corn at ninety cents a bushel, millet at ninety cents, hemp at \$1.30 and peas at \$1.10 the bushel. At these rates the cost of feeding was one-seventh of a cent a day for each bird, or about fifty-two cents a year.

On that basis the net annual return was \$1.50 a pair. There were four hundred and twenty-five pairs of pigeons in the flock and they reared four thousand four hundred marketable squabs in twelve months.

This is a practical, conservative record, bearing the government's *bona fides*, and may be duplicated by any one who will carefully attend to the requirements of the birds.

STORIES OF SUCCESS WITH PLYMOUTH ROCK HOMERS

PLEASED, AND ORDERS MORE SUPPLIES. I herewith enclose \$2.46 in express money order for which send me by Adams Express two drinking fountains and one dozen wood fibre nest-bowls. The birds which I received from you last fall are doing fine. I am well pleased with them.—A. E. B., Pennsylvania.

SQUABS ARE HEAVY. I write you enclosing \$1.50, for which please send me your Manual and one dollar's worth of the best kind of leg-bands for pigeons. I have about four hundred pigeons. The stock came directly from the **Plymouth Rock Squab Company** by Mr. Hulst. He sold out and went East and I bought his entire stock. They are fine. The squabs get like stones. When people ask me about my stock I tell them they are from the **Plymouth Rock Squab Company**. Am I right? If I am not, tell me and I will quit it.—J. A. M., State of Washington.

SIX WEEKS' WORK. In taking account of stock today I find I have sixty-eight nests containing sixty-two squabs, the oldest just two weeks old, and fifty-six eggs. Do you consider this a fair showing for the one hundred and thirty-seven pairs of birds I received from you about six weeks ago? One female bird died. I wish to thank you for the extra birds sent along to cover this emergency.—E. E. T., New Jersey.

Answer: Yes, we consider this a fair showing for six weeks. Do not believe any stories you hear or see printed that the dealer or writer can sell pigeons which will go to work at once as soon as they reach their new home. Some may and some may not, but this is a matter which is settled by the pigeons themselves, and anybody attempting to control the matter is a pretender.

PLEASED WITH SECOND ORDER. The second order of pigeons came in good shape and the crate will be sent back today. We are very much pleased with the birds.—G. P. W., Connecticut.

SMALL SHIPMENT DOES WELL; HE ACCORDINGLY ORDERS 300 PAIRS OF EXTRA PLYMOUTH ROCK HOMERS. The pigeons you shipped me arrived in good condition with one exception, that is, one bird seems a little inactive or dumpy. Will advise you later if the bird does not pick up. (Later). Herewith please find check for \$67.17 for which you will send me by freight at once the following bird supplies: Six hundred and twenty-four wood fibre bowls, thirty bath pans, nine drinking fountains, one sprayer. You may expect an order from me July 15 for the three hundred Extra Homers as per yours of May 15.—J. R., Ohio.

HANDSOMEST LOT OF PIGEONS THIS

PENNSYLVANIA BREEDER HAS EVER SEEN. My flock consists of in the neighborhood of one hundred and fifty pairs, and includes twenty-four pairs of the best Homers, which I purchased of you in August, 1902 for \$60. The balance of the flock is bred from these birds, and they are the handsomest lot of pigeons I have ever seen.—C. L., Pennsylvania.

A LONG AND SUCCESSFUL RAIL JOURNEY TO NORTHWEST TERRITORY, CANADA. The thirteen pairs of Homers and one dozen nesting bowls you shipped May 27 arrived in condition June 2, being six days en route. They have a good home and I will send you another order soon. The barrel of freight shipped May 16 has not arrived yet. Thank you for prompt and courteous treatment.—E. L. B., Northwest Territory, Canada.

WHITE WHEAT AND RED WHEAT. Would it be all right to feed my birds white wheat? I have much trouble getting red wheat. I wish you would tell me, as I do not wish to run any chances, as my birds are doing fine. I have twelve youngsters. The first hatch is setting again, also the second and third hatch. If I would run any risk in feeding white wheat let me know.—W. G. S., Michigan.

Answer: White wheat is all right, and is fed by most of our customers. If there is any tendency to looseness caused by feeding white wheat instead of red wheat use it sparingly, or feed rice to offset.

CUSTOMER OF THREE YEARS' STANDING HAS RAISED THEM RAPIDLY. The original birds which I bought of you nearly three years ago have increased so rapidly that it has been quite a task to care for them and to dispose of the squabs. I have always spoken a good word for the business and your company in particular, and without doubt have made business for you.—H. C., Michigan.

HAS THE ADVANTAGE OF HIS FRIENDS. The five pigeons you sent to replace the four I returned and the one that died were received today in good condition, and I take pleasure in reporting that they are entirely satisfactory, unless one should prove to be a cock; but even if that is the case I shall enter no complaint, as you have been so entirely fair. I am very much pleased with the birds and expect good results from them. My friends who were not pleased with the first lot I ordered and received some white Homers from a dealer in your State, but are far from pleased with them. They now think that I have the advantage of them, and have been well treated by you. I shall

LETTERS FROM CUSTOMERS RECEIVED BY PLYMOUTH ROCK SQUAB COMPANY

STORIES OF SUCCESS WITH PLYMOUTH ROCK HOMERS

certainly have a good word for you when an occasion offers.—R. H. S., Kentucky.

STARTED WITH EIGHTY PAIRS EXTRA, BRED THEM TO FIVE HUNDRED PAIRS. What will you give me for my entire stock of Homer pigeons? I have from one thousand to twelve hundred birds, all strong and healthy, and from your best stock of birds. I am compelled to sell for the reason that I have taken this hotel and it takes all my time to look after it. Hope to hear from you by return mail.—H. C. F., Missouri. (This customer started with eighty pairs of our Extra Plymouth Rock Homers.)

HAS 150 PAIRS OF THE FINEST HOMERS IN THE STATE OF COLORADO. About a year and one-half ago I bought fifty pairs of your Homer pigeons. I have now one hundred and fifty pairs of the finest Homers in Colorado. Fifty pairs are the original ones that I got from you; the rest I have saved from my young ones.—D. L., Colorado.

BOTHERED BY MICE. I wrote you that my birds were not doing well. Since writing the same two hens are setting, and from the amount of driving going on I hope to have them all at work in a few weeks. Since my last letter to you I have been setting traps and have caught seven or eight mice. I suppose that is what has been bothering them.—F. H. M., Tennessee.

DEATH OF AN OLD AND VALUED CUSTOMER. My brother-in-law having died very suddenly in New York, three weeks ago, where he had gone a few days on business, his squabbery is left without any one to carry it on. The Homers he got of you two summers ago, in 1903, two dozen pairs, have done very well indeed, owing to the excellent care he gave them. They were for his own pleasure, so he has not sold any squabs, but used them for the table and to send to friends. I should think there are nearly two hundred birds in the two pens at present. What prices should I ask for them? I have written to you knowing what confidence my brother-in-law had in your judgment, and that under the circumstances you could help me dispose of the pigeons advantageously.—Miss G. M., Maine.

TREATED FINELY—SQUARE DEALING. In reply to my inquiry I received your answer which was very satisfactory, and have shown it to some of my friends who thought that I had been fooled in buying of you. They now think that I have been treated finely by you. I will say that I appreciate your square dealing and will speak a good word for you, as there are quite a number here that are going into the busi-

ness, who have been watching the results of mine.—W. W., Rhode Island.

STARTED WITH FIVE HUNDRED COMMON PIGEONS AND MADE A FAILURE. A short time ago we put up a building after the plans which I purchased of you, and put in five hundred and twenty common pigeons. Since then we have discovered that we made a mistake. The flock is a failure in more ways than one. We got one hundred and sixty-two pairs of birds from a party we did not know, and the birds were sick when we got them. We received them on a Saturday afternoon, and on Monday they were dying. After losing quite a few, the cause of which we were not able to ascertain, we have finally decided to start over again. We are going to put in Homers and start on a more cautious scale. We are going to get rid of all these birds, clean out the building and start anew. We have tried the common pigeons and have been convinced that they are not the right stock. As we are new in the business we have a great deal to learn, and will have to get our information from those who we are sure do know. Remember, we are willing to pay for the information. If there is any charge please name the price and we will remit. We are beginners and would like to make a success of the business, and do not expect to get for nothing information that has probably cost some one both time and money.—J. D. C., Pennsylvania.

Answer: We do not think you read our Manual before buying your common pigeons, or if you did, what we say about common pigeons there must have escaped your attention. Common pigeons are useless in comparison with Plymouth Rock Homers, and it is unwise to experiment with them.

GEORGIA PREACHER FINDS THEM SPLENDID. Enclosed I send you post-office money order, for which please send me one leg band outfit. The birds you sent me are doing splendid.—Rev. L. H. H., Georgia.

SECOND SHIPMENT—FIRST LOT IS HARD AT WORK. Enclosed find express money order for \$20. Please express to my address twelve pairs Homer pigeons. The first lot you expressed to me is hard at work and making fine headway.—G. F. T., Alabama.

INCREASED FROM TWELVE PAIRS TO TWO HUNDRED PAIRS IN TWENTY MONTHS. I have somewhat about four hundred pigeons that are most all bred from your best stock. They are a nice lot of birds. I started with twelve pairs of your Extra Plymouth Rock Homers twenty months ago.—G. P., Massachusetts.

LETTERS FROM CUSTOMERS RECEIVED BY PLYMOUTH ROCK SQUAB COMPANY

STORIES OF SUCCESS WITH PLYMOUTH ROCK HOMERS

THREE HUNDRED PAIRS SHIPPED TO THIS CUSTOMER, EVERY BIRD IN THE BEST OF CONDITION. Your favor of the 11th inst. received on my return home Friday night, and would have been answered but for the fact that I had quite a busy time, partially through outside business and partly on account of arrival of the birds. I wish to tender my most hearty thanks for the manner in which you have carried out your part of the transaction. Every one of the 312 pairs of birds seems to be perfect in every respect, and they have already been admired by every one who has seen them. The twelve pairs Extra which you so generously presented me for my nephew have been forwarded to him, and I feel sure will greatly please him. I shall see him possibly Monday next week on my next trip, and will thoroughly instruct him. Once in a great while I get to Boston. Next time I am there I shall do myself the honor of calling on you to see your plant, so I can enlarge mine on the same lines or at least get some ideas of that end. Thank you again most heartily — G. F., New York.

GOOD LUCK WITH THEM IN NEBRASKA. I bought twelve Homer pigeons, or six pairs, of you nearly a year ago, with which I have had fairly good luck, and I may order more birds of you in the future, as I intend enlarging my plant soon. But I want to ask a favor of you today. It is this: Will you give me, on the enclosed card, the name of the tanning company to whom you sell your pigeon manure? — L. S. M., Nebraska.

BIRDS BREEDING WELL. Please find enclosed express money order for \$5.34, for which ship me by Wells-Fargo Express four dozen nest-bowls and leg-band outfits. My birds are doing very well. I have twelve squabs. — H. H. S., New York.

SECOND ORDER TO COME BECAUSE OF GOOD WORK IN MARYLAND. We enclose you herewith check for \$11.52. Will you kindly send us your earliest convenience twelve dozen nest-bowls? We are glad to report that the pigeons received from you a few months ago are doing nicely and we expect to order more shortly. — M. P. F., Maryland.

THIRD ORDER FROM INDIANA MAN. Please ship me at once twelve pairs. I enclose draft for same. This is my third order. — V. N., Indiana.

SECOND ORDER FROM ILLINOIS WOMAN. Please find enclosed express order for \$30. Send me twelve pairs of Extra Plymouth Rock Homers. This is my second order. — Mrs. J. W. G., Illinois.

A MINISTER ENCOURAGED TO GO AHEAD. The pigeons I purchased of you

last August (nine months ago) are doing well, but I have so far found it impossible to go into the house for five minutes or so without all the birds leaving the nests. Can you tell me how to obviate this? Will you be kind enough to inform me about how much money it will take to build a house including heating plant and flying pens in first-class shape for fifteen hundred pairs of birds? You will greatly oblige me. — Rev. L. C. H. A., New York.

SECOND ORDER; FIRST SHIPMENT WORKING WELL. Enclosed please find Adams Express money order for \$15.96 to pay for six pairs Extra Plymouth Rock Homers for squab raising, and one dozen bowls. The birds first bought are doing well, and I am well pleased with them. — L. D. P., Illinois.

SECOND ORDER WITHIN ONE MONTH. Herewith find draft for \$40.75, for which please send me two crates of your Homer pigeons and one drinking fountain, by American Express, to my address. This is my second order within one month. I am well pleased with the first shipment. — L. D., Iowa.

GOOD SHOWING MADE BY OUR BIRDS IN ONE MONTH AFTER ARRIVAL. I am having such good luck I thought I would write you about it. Just one month ago today the 9th of May, I received my thirteen pairs of birds from you. I now have eight squabs from four pairs, and six more pairs setting. The two hens that were in bad shape upon arrival are getting better, but have not nested yet, and the thirteenth hen I think is going light from too hard driving by the cock. He drove her all the time and pulled out half her feathers, but he has mated with another hen now and doesn't bother any. What do you think of this for so short a time? I have as fine a home for them as can be built — built just as you say with a fly ten by ten by twenty feet, with a big load of lake sand for the floor, and keep the squab house cleaner than lots of kitchens I know of. — C. G. A., Iowa.

EXCELLENT BIRDS AND EXCELLENT CARE FROM MELROSE TO NEW MEXICO. The pigeons arrived safely last Saturday evening; each and every one of them was in perfect trim and must have had excellent care on the way, as not one seemed in the least decomposed by the six days' journey. Your kindness in sending us the extra pair I do assure you is most highly appreciated. We are delighted with the birds and as soon as I return from my summer and fall trip, will send you a large order. — Mrs. T. H., New Mexico.

IN THE STATE OF WASHINGTON. You will find stamps to the amount of \$2 for which kindly mail me one hundred aluminum V-shaped leg bands for pigeons. I am glad to tell you that the pigeons are doing nicely. — G. A. T., Washington.

LETTERS FROM CUSTOMERS RECEIVED BY PLYMOUTH ROCK SQUAB COMPANY

STORIES OF SUCCESS WITH PLYMOUTH ROCK HOMERS

THIS WOMAN IS POSTMASTER IN HER TOWN—SHE STARTED IN 1903 WITH OUR BIRDS AND THIS IS WHAT SHE HAS DONE. In July, 1903, I purchased a few birds from you. I have bought no others but have now got over a hundred and would like some advice relative to shipping squabs. Will it pay to ship one or two dozen at a time to Boston, and will you tell me who would be reliable parties to ship to? As I told you in my first letter, this is a somewhat isolated place; however, there are quite a number watching my experiment, as I have the only store here and have recently been appointed postmaster. Every one notices the birds and my success will probably bring you orders. I have lost only one bird and that one by accident; no sickness or lice in my flock at any time.—Miss L. K., New Hampshire.

PLEASED WITH FIRST LOT, WILL ORDER ANOTHER. I am so well pleased with the coop of birds shipped me that as soon as I get my house built and nappies in, will order another coop of your highest-priced birds.—R. H. N., Georgia.

AN IMPORTANT STORY TOLD IN FEW WORDS—THIS CUSTOMER IN PENNSYLVANIA FOUND A LARGE FLOCK OF PLYMOUTH ROCK HOMERS BY HIS EXPERIENCE BEYOND REPROACH. Please ship balance of my order of Extra Homers (one hundred pairs due me) at earliest moment. Kindly telegraph night of shipment. The first lot (two hundred pairs) are beyond reproach.—C. K., Pennsylvania.

REACHED TEXAS IN GOOD SHAPE—CUSTOMER SATISFIED. I beg to advise you that the pigeons reached here yesterday all in good shape. So far I am very much pleased with them and with your prompt shipment and good treatment. I hope to send you another order soon for a dozen pairs.—A. G. M., Texas.

ALL AND MORE THAN EXPECTED. On Saturday I went out to my country place and found the pigeons. They are all and more than I expected and are in every way satisfactory. I presume my man will return the empty pigeon crates this week.—H. A. K., Illinois.

SQUABS FROM OUR EXTRA PLYMOUTH ROCK HOMERS WEIGHING 10¼, 10½ AND 11½ POUNDS TO THE DOZEN. My first shipment of squabs will be made April 11. So far my squabs have averaged ten and one-quarter, ten and one-half and eleven and one-half pounds to the dozen. If you can give me any data necessary for spring and summer it will be appreciated.—C. M., Michigan. (This customer started with four hundred pairs of our Extra Homers.)

INCREASED FROM A DOZEN PAIRS TO 250. I bought a dozen pairs of birds from you two years ago, and now have two hundred and fifty. Is that doing well? Will you kindly inform me by return mail how you separate the pigeon dung from the other matter it gets mixed with, and I will be greatly obliged.—P. M. F., Iowa.

INSIDE TWO MONTHS HAS YOUNG BIRDS BEING RAISED IN A SEPARATE PEN. I bought a dozen pairs of Homers of you and received them March 1, two months ago. They have mated and produced quite a number of squabs. I have the squabs in a separate house, as I intend to raise them for a year or so until I increase my flock. I have been advised to pull out the tail feathers of the squabs when they are old enough to put into a house by themselves, as it would decrease the death rate among them, as all their vitality can go to the bird and not into the tail feathers. Is there anything in this advice?—J. W. W., Rhode Island.

Answer: We believe it is best not to pull the tail feathers out of the young. We have never done it ourselves. Certainly the Creator does not pull out the tail feathers from these young birds when they are weaned.

RECREATION FOR AN IOWA MINISTER. The twenty-six birds came in good shape, apparently no worse for the journey. Most of them are active. I am well pleased with the birds. We are making friends rapidly, some of them eating almost at once out of my hand. I wish them to do well, and as soon as I get accustomed to their ways it is my intention to put in enough stock to make their care worth while. I wish to show my appreciation of the way in which the order was filled.—Rev. N. F. D., Iowa.

IOWA LADY GREATLY PLEASED. I am greatly pleased with my flock and expect to send another order sometime later.—Miss A. A., Iowa.

PLYMOUTH ROCK HOMERS THE BEST IN COMPARISON WITH ALL OTHERS. I received the birds in good shape and the grain and gravel. The birds are doing well. I have got two sets of squabs and five more pairs on eggs. The reason I did not write you before is, I went around to different people that have had pigeons from other places and the same people have seen your stock; and they all say yours is the best. I shall give you more orders when my pocketbook will permit me. I think you do your best and I thank you again for the nice big birds you sent me.—J. H. H., Michigan.

MADE THEMSELVES AT HOME IN KENTUCKY. I received from you in March two dozen birds. They have been laying for over a month and I have now (May) four pairs of

LETTERS FROM CUSTOMERS RECEIVED BY PLYMOUTH ROCK SQUAB COMPANY

STORIES OF SUCCESS WITH PLYMOUTH ROCK HOMERS

young birds. I am very much pleased with them and the way they have taken to their new conditions.—R. F. W., Kentucky.

GET A GOOD START. The birds are doing fine now. I have seven pairs young and two on eggs since March first.—L. C. M., New York.

REMARKABLY WELL IN SHORT TIME. Several weeks ago I received one dozen of your Homer pigeons from you for which I paid \$10. These are all mated up and doing fine, except two. Four of them are setting and another one will be setting in two or three days. I think this is doing remarkably well for the short time I have had them, as I did not expect them to lay until at least three weeks after they had been here.—B. W., North Carolina.

SELLING SQUABS AS FAST AS THEY COME AND GETTING ORDERS FOR MORE—ANOTHER SMART WOMAN. Find enclosed post-office money order and send me eighteen pairs. The last lot I got were \$15 for six pairs; also want two extra hens for two extra cocks which I have. I have been saving up some of my young during the fall and winter months and have two extra cocks. Am selling everything as fast as they come and even engaging ahead most of the time. The Country Club manager spoke to me a day or two ago to try and have squabs for their little dinner parties, which will begin to be popular about June, and as I have two standing orders at present for all I have to spare I must put in some more breeders. I have about sixty birds now. Of the six pairs ordered last fall, one hen died within a week with diarrhoea.—Miss J. M., Illinois.

BIRDS BREED SO FAST THAT HE HAS NO MORE ROOM FOR THEM. I have about seventy pigeons. They are six months to one year old. What can you allow me on them toward more breeders? These birds are all raised from stock I bought of you. The reason I want to exchange them is because my house is too small for them and I have no more room. I am going to put up a large building in the spring and then I can take care of more. I am satisfied there is money in the business if any one can get started right.—H. A. M., Massachusetts.

A BRACE OF SQUABS BRED FROM PLYMOUTH ROCK HOMERS WEIGHED OVER TWO POUNDS. I weighed two squabs from your birds and they weighed just two pounds, two ounces.—J. A. O., New Hampshire.

BEST HOMERS IN HIS FLOCK—THEIR SQUABS BRING HIM THIRTY-FIVE CENTS APIECE FROM BOSTON

HOTELS ALL THE YEAR ROUND. The birds I purchased from you are the cream of the flock. I have been selling the squabs at the Boston hotels for thirty-five cents apiece the year round, and Nathan Robbins, at the Quincy Market, was glad to take them at \$3.50 per dozen. I have saved a few young birds, some of the very finest.—C. L. P., Massachusetts.

KANSAS MARKET IS LOOKING UP. The birds arrived in good order and I am today well pleased with them. I think some of them have as fine plumage as I ever saw on a pigeon. There is a party here in town that has a flock but they are not first-class birds, yet he gets \$2.50 per dozen for the squabs and could sell five times as many if he had them in Kansas City. We are favorably located here, sixty-five miles to Kansas City, forty miles to St. Jo., Missouri, and twenty-five miles to Topeka, and we ought to do well. If I can get hold of a place just out of town I will increase my flock next spring or possibly this fall.—C. H. K., Kansas.

RATS TROUBLED HIM. I have not bought a bird since you sent me one hundred pairs of Homers. At first they did not do much. The very hard winter we had and I being away in New York most of the winter, and the birds not having the proper care, of course they did not do much; but now they are raising "Cain," and they are chasing each other to the nests. I now have about two hundred young ones that escaped the rats, and two hundred and twenty-two eggs hatching. I am satisfied with them and they must have been strong and hardy birds to have lived. I have lost as many as one hundred birds by rats. I have tried everything, and am now laying cement floors on three barns, but guess I will have to build new buildings. I will mail you a photograph of the place in a week or so. I have not sold a bird as yet, but have had plenty of chances.—C. M. S., New York.

ATTRACTED MANY ADMIRERS IN THIS EXPRESS OFFICE IN THE STATE OF WASHINGTON. In acknowledging receipt of the six pairs Extra Homers I wish to thank you for the additional pair, and to say that they reached me in the pink of condition. My delivery man told me that many persons copied your address from the basket at the front of the express office, where they attracted considerable attention. The remarkably beautiful black bird I have named Black Champion and his consort Queen. She will hatch next week. At present I have five squabs, one egg failing to hatch. If beauty counts for anything, the birds are worth the price.—Mrs. P. M. V., State of Washington.

LETTERS FROM CUSTOMERS RECEIVED BY PLYMOUTH ROCK SQUAB COMPANY

STORIES OF SUCCESS WITH PLYMOUTH ROCK HOMERS

MANUAL PRACTICAL AND BEST. Your Manual came to hand and can see that it is a book everybody should have who may be interested in pigeons. I have had birds for eight years and read all kinds of books. I think yours is the best which can be had.—H. E. E., Pennsylvania.

HIGHLY SPOKEN OF IN VIRGINIA. Will you kindly send me your price list of books and circulars giving your prices, etc. Being very much interested in this industry and expecting soon to go into business, I wish to get your prices and information. I have heard your company spoken very highly of here in Virginia and wish to get acquainted with you.—J. W. K., Virginia.

A GUARANTEE WHICH GUARANTEES. The two sick birds are improving and are almost as lively as the others. Your offer to make them good in case they did not get better shows that your guarantee means something. A good many persons have seen them and all agree that they are far ahead of the ordinary run of pigeons, and any one who understands anything at all about livestock of any kind can see it at a glance.—J. G., Pennsylvania.

A CUSTOMER IN THE BERMUDA ISLANDS GETS HIS HOMERS IN GOOD ORDER. The pigeons arrived here all safe on Monday, December 5. One of them is a little dull, and we have separated it from the others and hope that it will get all right.—G. S., Bermuda Islands.

PLYMOUTH ROCK HOMERS HAVE THE CALL IN JERSEY CITY. Enclosed find remittance for which please send me six pairs Plymouth Rock Homers by Adams Express. If these are satisfactory and as nice as some of your birds I have seen in Jersey City, I will want more shortly, as I have accommodations for about one hundred pairs.—F. E. F., New Jersey.

BIRDS DID BETTER THAN HE FIGURED WHEN HE STARTED. Can you favor me with the address of some squab buyer in the vicinity of Syracuse, New York? The birds I got of you a year ago are doing finely and surpassed my expectations. Am having to enlarge again.—W. L., New York.

EXPRESS DELIVERY BEAT THE MAIL. Pigeons came yesterday in fine condition. I am more pleased. Thank you for filling the order so promptly. The birds were here three hours before your letter telling me that you had shipped.—C. M. G., New York.

HER SECOND ORDER FROM FAR-OFF WASHINGTON. Find enclosed \$68.17, for which please send me forty pairs Plymouth Rock Homers and supplies as specified. This is my second order.—Mrs. M. G., State of Washington.

GOT A DOZEN, NOW HAS 200. Please send me the names and addresses of some of the firms in New York City and other places which deal in squabs and pigeons. I have now about two hundred pigeons. I got a dozen pigeons from you to start with in June, 1903. What is the price of squabs and old pigeons now?—J. G. G., Pennsylvania.

SQUABS ARE A "TERRIBLE SIZE." My flock is increasing rapidly and I must provide for them. I also inform you that my birds are doing finely and breeding steadily right along and are very healthy. Our squabs are of a terrible size. Any one would be astonished to see them at four weeks old.—A. B., New York.

PLYMOUTH ROCK HOMER USED AT THE CHRISTENING OF A FOUR-MASTED SCHOONER DOWN IN MAINE. I write to say that the Homer pigeon which you sent to Mr. E. R. Chapman a few days ago, was used at the christening of the new four-masted schooner "Augusta W. Snow" which was launched at the yard of Messrs. E. and I. K. Stetson this forenoon, and was released at 11.20 a.m. today, and if she turns up at home I shall be very glad if you will inform me of the time, etc. The following inscription was attached to her leg, written in indelible ink on a piece of linen—"Bangor, Maine, Christening Pigeon from launching of Schooner Augusta W. Snow, May 6, 1905."—W. B. S., Maine.

WELL SATISFIED AFTER A YEAR OF BREEDING. It is one year ago last December that I received thirty-six pairs of your pigeons. I am well satisfied with the results. They have demonstrated without doubt they are breeders all right. I have sold a few dozen squabs, eaten a couple of dozen and increased our flock by many dozens. I have as fine lot of pigeons as one would wish and they are producing squabs right along. The pigeons I raised last year are producing birds and are an unusually fine lot of pigeons.—H. P., New York.

A GOOD START IN THE FIRST SIX MONTHS. The pigeons I bought of you in July have done finely. I think I got seven pairs and now (February) I have close to twenty-five pairs and the young ones have begun to lay now. I see that they will multiply very fast.—T. E. G., Alabama.

LETTERS FROM CUSTOMERS RECEIVED BY PLYMOUTH ROCK SQUAB COMPANY

APPENDIX C

(Copyright, 1906, by Elmer C. Rice)

In 1907, we expect our trade to be even greater. In 1906, we sold more birds and supplies than in any previous year. That our trade is **larger than that of all others combined** is not an idle boast, but is very much of a fact, due to this, namely, that we sell Homers which are **larger, more prolific**, and which **breed larger squabs, than any others.** **This supremacy we intend to maintain.**

We offer additional proof in the following pages. For every letter which we print here, we have a dozen just as good, or better. The following letters, only a part of many received in **nine months of 1906**, are not from customers merely pleased by the fine appearance of the birds on arrival, but are accounts of **breeding which has won success.**

There are some very strong letters here. All are worth reading for the practical information and news they give of the squab industry up to date. We do not print the names and addresses of these customers. Many are regular buyers of our birds. We guarantee the genuineness of the letters, and will prove it in any way desired. The originals are at our Boston office and may be seen there.

We ask your trade for 1907 by deserving it. If anybody tries to make a sale to you by "running down" competitors, insist that he or them demonstrate the worth of claims by furnishing proof in volume and character, concerning birds, matings and management, equal to the letters we print here and in our other publications.

OUR LARGEST 1906 ORDER. In looking back over our year of business, 1906, we recall first an order from a customer whom we started in 1905, with 120 pairs Extra, for which he paid \$300. We sent him 125 pairs, five pairs free. A year later we received the following telegram from him:

"Wire bottom prices for one thousand pairs Extra, including two thousand nappies and date you ship."

We quoted him our regular price for Extras, the same to all, namely \$1.70 per pair in large lots of 300 pairs and over. Our customer was a man of few words and knew what he wanted. Three days after sending us the above telegram he sent us the following letter: "Enclosed find draft for \$2111.25 as payment in full for 1150 pairs Extra and supplies. I trust you will exert every care in interest of shipment. You will please hold the birds until May 10, as it will crowd me to get my quarters ready before that time."

We shipped 1200 pairs, giving the customer 50 pairs free. He lives in the West and the

birds had a long trip to reach him. We expect to sell him more yet, judging from his last letter. We will be pleased to show the correspondence at our Boston office. The point we wish to make is, that we are the only firm anywhere actually filling orders this size, or able to fill them, and that we earned the confidence of this customer by giving him his first lot of birds so good that he kept on trading with us. More 1906 experiences follow.

STARTED WITH SIX PAIRS EXTRA AND IN TWO YEARS RAISED SIX HUNDRED AND THIRTY-SIX SQUABS. Nearly two years ago (in October, 1904), I purchased of your firm six pairs of your best Extra Homer pigeons, from which I have been breeding since, and it may be of interest to you to have some particulars as to results. I should premise by saying that I was, at the time, a novice pure and simple—as a matter of fact a lawyer by profession—and knew absolutely nothing of the care or culture of pigeons,

STORIES OF SUCCESS ON THIS PAGE ARE NEW. THEY WERE RECEIVED BY THE PLYMOUTH ROCK SQUAB COMPANY OF BOSTON IN NINE MONTHS OF 1906

However, study of your squab book, close and constant observation of the birds, their habits, etc., with the resultant experience, enable me to get along pretty well.

My pigeon house was not originally intended or constructed for that particular purpose, but had, hitherto, been used for a hen house. It is about 40 feet by 12 feet, with five windows. Along the whole of the west front and extending across the south end I built a fly 10 feet wide, 12 feet high and about 70 feet long. My flock has hatched, up to the time of writing this, **six hundred and thirty-six squabs (636)**, without those consumed at my own table, but I contemplate marketing the squabs this fall as the overcrowding stage is rapidly approaching.

If you can find time I shall be glad to hear whether or no, in your expert opinion and in the above circumstances, you think that I have been fairly successful. Although I feel reasonably satisfied with my progress, were I to start again, *ab initio*, I think that I should do so with a complete flock of fully matured birds rather than waste the time consumed raising stock, by breeding, to a business basis. Wishing you continued success.—W. C., Massachusetts.

DOING GREAT WORK. The Homers which you sold me two years ago are doing great work. I am perfectly satisfied with them.—F. S., New York.

TOOK FRIEND'S ADVICE. Enclosed find an order for birds and supplies with remittance. A friend here was much pleased with our birds from your lofts and decided to go into the business. We prevailed on him to order from you because we felt your birds were the best. He could have bought here in Illinois at a much cheaper rate but he took our advice. So we trust you will do well by him and trust you will send us another order blank like the one enclosed.—Mrs. K., Illinois.

MULTIPLIED SIX-FOLD. About two years ago next June, I bought of you 60 pairs of your Extra selected Homers and they were a very fine lot of birds, and I have raised a very fine lot of birds from them. I have about 400 birds now, and they are straight bar wing and mottle with the exception of about eight chocolate.—A. C., New Jersey.

GETTING THREE DOLLARS A DOZEN. Please send me your new literature on squabs. I bought 18 pairs of you in 1903 and now have a flock of 190 birds and am getting \$3.00 for my squabs in St. Louis. If any one in this section writes to you for squabs you may refer them to me.—F. L., Missouri.

NEIGHBOR PLEASED. Your favor of the 21st to hand, also price list of \$1.70 for Extra Homers in 300-pair lots. Mr. J. A. Westendorf, of this city, purchased of you on a trial order five pairs of Extra. Why cannot you make me the \$1.70 rate for 50, 100 or 200-pair lots? In going over my buildings I find that I cannot accommodate 300 pairs so would not like to order that number for fear of being too crowded.

Mr. Westendorf is pleased with his birds and if the birds you should send would be the equal of those I would be more than satisfied.—A. S., Missouri.

ENTIRELY SATISFACTORY. Please send me the feeding slip that you have published as your daily feeding ration. The birds we got from you are entirely satisfactory.—J. D., Pennsylvania.

RECOMMENDED BY ANOTHER. Will you kindly let me know how I can expect to receive birds ordered from you to be sent to the above address? I have been recommended to try your birds by Mr. R. Warner, of 9 DuBois Avenue, and if you can guarantee safe shipment I will place an order with you as soon as I hear to this effect. And if they are as you represent them, I shall be a regular customer of yours. If you will give me the desired information, you will greatly oblige.—G. S., New York.

THIS SHOWS WHAT A CUSTOMER DID WITH TWELVE PAIRS OF OUR BIRDS. My Extra Plymouth Rock Homers have done finely. I sent to Boston \$30 for 12 pairs. The birds arrived before I expected them and they all looked fine. I got my first egg March 21, 1905. I raised all of my young to increase the flock for one year and found at the end of the year that I had 271 young birds, all seamless banded, and as fine a lot as I ever have seen. This year I am selling squabs and mated pairs, raising my best young, and have already sold squabs and mated pairs which have to date netted me \$60. I have sold my squabs for \$3 a dozen, and mated pairs for \$2.50 a pair.

I now (September 10, 1906), have 400 birds that I have raised. A good lot of them are worthy to be put in the show pen, and if they were they would be among the winners.

When I went into the pigeon business I bought what I thought was the best stock to be obtained, namely, Extra Plymouth Rock Homers, and my flock shows that I did not go wrong, for every one that has seen my birds pronounces them the best lot they have ever seen together.

My birds now are in the midst of moult, but most of them are breeding right along.

These are strong letters. Read them over. You want some assurance, when you buy pigeons, that you will be treated right, as these customers were.

STORIES OF SUCCESS ON THIS PAGE ARE NEW. THEY WERE RECEIVED BY THE PLYMOUTH ROCK SQUAB COMPANY OF BOSTON IN NINE MONTHS OF 1906.

I now have 95 mated pairs at work and as soon as the moult is over I shall begin mating again. By November I expect to have 50 pairs more mated and at work.

I feed the best of grain, using cracked corn, kaffir corn, red wheat, buckwheat, a little hemp, and during the moult sunflower in the head, letting the birds pick off the seed as they like.

I use the self feeder Mr. Rice describes in his Manual and I find with it the feed is always clean. I never feed on floor. I use automatic water fountains and scald them out every two or three days. I give the birds a good clean bath every day.

I have trays to feed any dainty which I have, removing trays when seeds are eaten.

One thing that is essential with pigeons is cleanliness. I clean loft every Saturday, cleaning out nests that have young, putting in new straw, and spraying over lofts with liquid disinfectant.

I have followed the instructions of Mr. Rice's Manual and found it to be good solid advice.

In the past 18 months I have been in a good many pigeon lofts and have seen exhibits at New York State Fair and Rochester, N. Y., Pigeon Shows, and never have seen any better birds than I have raised from the Extra Plymouth Rock Homers.

I am perfectly satisfied with what my birds have done and when I buy more they will surely be Extra Plymouth Rocks.

The feed bill will not exceed eighty-five cents a year per breeding pair. I use tobacco stems for nesting material and like them. I shall always try and speak a good word for the Plymouth Rock Squab Company, for I have found them always ready to assist at any time.—W. R. R., New York.

THEY HAVE NOT LOST A BIRD. I wrote to you some time ago in regard to the squabs we got from you in the month of May, or rather pigeons, 50 pairs, and have yet to lose our first bird, which not only speaks well for your birds but it looks as if we are giving them the right attention.

There is one thing we wrote to you about, those not working—but they are doing fine and, counting your birds, we have 100 pairs, besides we have sold some which were greatly admired.

The hotel we take them to in Washington gives seventy-five cents a pair all the year round dressed, the commission merchants never higher than 60 cents a pair.—M. B., Maryland.

MANUAL INDISPENSABLE TO SUCCESS. In regard to the National Squab Book which you publish, would ask if you ever revise it.

The one I purchased of you in May, 1904, is all right and I could never have raised the number and quality of squabs I do without its guidance. Of course you are learning new points about your business and if you have a later edition than mine please let me know.

The Homers have started in on their annual spring campaign and from all appearances they are going to outdo their former productions. With best wishes for your continued success.—A. T., Ohio.

HIGHLY RECOMMENDED TO HIM BY OTHER CUSTOMERS. Some time ago I wrote your company for their free book on squab raising. Later I sent for your National Standard Squab Book. I have read each one from start to finish and am well pleased with them. I have made up my mind to give the squab business a trial as I am quite sure that there is money in it, if properly conducted.

I realize that to make a success of any business one must thoroughly understand it. As I have had no experience in this line I wish to start in with a small number and increase them as I grow to understand the business.

My plan is to buy 12 pairs of the very best breeders that I can obtain and keep only the best of their increase for breeders till I get my flock to the desired size. Now, from reading your books and having you highly recommended to me by other parties, I have made up my mind that you can give me what I want in this line.—H. B., Illinois.

FROM FOUR PAIRS TO THIRTY PAIRS IN NINE MONTHS. Nine months ago I bought of you four pairs of Extra Homers. I had to move them twice to make room. I have now 60 first-class Homers. I have had several chances to sell some of the squabs but I think too much of them. By studying your manual carefully I have not lost a bird. From a friend of your Homers.—W. M., New York.

NO DISEASE. You no doubt have my name on your books as a purchaser of 10 pairs Extra, which I purchased of you last winter. I am still enthusiastic over the industry. I have all the original 11 pairs you sent me and 33 young, all the offspring of your birds, 55 birds in all. They are every one in finest condition, disease has never touched my flock.—J. P., Virginia.

FIVE MONTHS IN CALIFORNIA. When I received those birds from you in March I turned them into a pen and have been so taken up with other work that they have been left to themselves until now. At present I am taking all the working birds out and banding, and when they have young squabs I have

Beware of anybody who tries to make a sale to you by running down the Plymouth Rock Squab Co. Insist that he show you letters like these in proof of his claims.

STORIES OF SUCCESS ON THIS PAGE ARE NEW. THEY WERE RECEIVED BY THE PLYMOUTH ROCK SQUAB COMPANY OF BOSTON IN NINE MONTHS OF 1906

moved them also, putting them in a corresponding section in the other pen, the arrangement of the pens being the same. I find that the old birds bring their young and go right on keeping house just the same as before they were moved. At present I have 100 young birds, the oldest being less than five months and already at work. The squabs are fully developed and out of the nest at three weeks. I expect to have about 80 or 90 pair of birds at work about the first of November. Then I shall begin to ship.—E. R. C., California.

GETTING ALONG IN VIRGINIA. Please ship by freight to us six drinking fountains and six bath pans. We got some birds of you last year. They have done very well. Thank you for the advice—P. N., Virginia.

GENEROUS TREATMENT OF CUSTOMERS. Your letter of May 21 was most satisfactory and certainly very generous. I hope I made it very plain to you that you were not at all to blame for the loss of one of my pigeons. Your offer to replace it free of charge was quite in keeping with my impression as to your very generous treatment of your customers. I have at last found that the lost pigeon was a female and if you think a white pigeon would be well received by my colony of three checkered, I would like to have a white female Extra Homer pigeon. My pigeons are in fine order and doing well.—Mrs. H. C., Georgia.

LOST ONLY ONE SQUAB IN FIVE MONTHS. Five months since, come the 12th, I received of you, by express, 13 pairs of your Plymouth Rock Homers. Up to date I have lost but one squab (and I think he was killed by a dislocation of the neck), possibly 10 eggs, several by frost. I have 54 squabs, most of them able to take care of themselves, and seven pairs of eggs. Three pairs of young ones have hatched and begun to build their nests. Now I wish to ask you if you think they are doing well. I do, and I am proud of my intelligent birds. I am now preparing to remove all young ones from the pen except those that are mated and then as fast as the others mate, to do as you say, put them into the breeding pen. I shall also build on another unit to my breeding pen in a short time, as I figure on 110 birds in my present house.

I wish I was financially able to put in a good plant as these birds have demonstrated their fecundity. I notice you say that there is little liability of nest-makers mating. I have not discovered any with the few I have. I have just gone through the nest boxes with whitewash containing a good per cent of

carbolic acid and vitriol solution. I clean out houses often and so far have not had a sick bird. Occasionally I put ginger in the drinking fount and I firmly believe it is by following your plain and definite instruction that they keep as well.

I hope I am not trespassing on your valuable time but cannot resist telling you how I am getting on with your stock.—W. G. P., Wisconsin.

CONVINCED AFTER TRIAL. I have delayed in writing you as I wanted to see how the birds were going to turn out. Can say now, I am more than pleased with the birds. I have now 18 squabs and five pairs of eggs. Three squabs died and six eggs went to waste. That is all over with now. Don't expect that to happen again. As far as I can see squab raising looks to be very simple and profitable. I have a nice clean house and running water so the time spent is nothing. Enclosed you will find my check for 12 pair Extra more.—J. S., Washington.

GETTING FOUR DOLLARS A DOZEN FOR SQUABS. Please send me as speedily as possible 25 pairs of Extra Blue Homer Pigeons. I have now about 125 pairs of birds bred from the original 20 pairs I bought from you about 18 months ago and am selling squabs at \$4.00 a dozen. I am building a coop 48 feet by 14 feet which will accommodate about 600 birds and if successful will enlarge my plant shortly.

Will you kindly supply me with the name of the large Commission house in New York mentioned in your circular? The original birds were bought from you in November 1904 and shipped to my partner in the business.—H. B., New Jersey.

QUICK TIME. I have read a large number of your testimonials, none like this however. Now I will make an affidavit that I received the 38 pairs Saturday morning, put them in the pen by ten a.m. I gave them a few tobacco stems from a crock on the floor in the corner. At five p.m. a hen laid an egg. She laid her second egg to-day, Monday, and is now setting. Can any of your customers beat this?—S. H., Illinois.

THINKS WE ARE TRUE BLUE. I am giving my pigeons occasionally lettuce or some raw cabbage, which they most heartily enjoy. Is this conduct prudent? The last batch of birds you sent me "Extra selected" were magnificent. You people (The Plymouth Rock Squab Company) seem to be "true blue." I like to deal with your kind; don't find them all the time. Please answer

Is there anybody in your town who has failed at squab raising? Some play at pigeons as they would with a new toy, then they give them up. If they bought of us, the trouble is with them and not with the pigeons.

STORIES OF SUCCESS ON THIS PAGE ARE NEW. THEY WERE RECEIVED BY THE PLYMOUTH ROCK SQUAB COMPANY OF BOSTON IN NINE MONTHS OF 1906.

the above and return to me. Yours will succeed with your treatment.—O. J., Illinois.

SUCCESS IN TEXAS. In October 1905 I purchased from you 25 pairs of birds and since that time I have had fair success in raising squabs. I have about 175 young birds on hand at present. They are all strong and healthy, having had the best of care, and a great many of them are mating now.—W. B., Texas.

THANK YOU FOR YOUR LETTER. I received the birds all O.K. The last ones were every one all right, as were the first. A thousand thanks for your kind, courteous, and prompt treatment in all our business dealings and you will be sure to hear from us again. If our letter will help you any, you are perfectly welcome to use it. Thank you again.—J. C. H., Michigan.

SELLING MANURE. Some time ago I bought 24 pairs Homer Pigeons from you. I have had fairly good luck with them, having increased my flock to about 200 pairs. I want to write you in regard the manure. You state in your National Standard Squab Book, that the Leather Trust used it for tanning purposes. Now I have considerable on hand and I wrote them. They said in reply, that they did not use it at all, which was a surprise to me as I have been careful in saving it.—W. H. H., Pennsylvania.

Answer. The trust does use pigeon manure or did, the last we knew. We shipped to one of the Lowell plants of the American Hide and Leather Co. for three years. Perhaps your letter was directed to one of the plants of the trust which does not use pigeon manure. We have printed so long the fact that pigeon manure is salable to tanneries of the trust that the New York office of the trust has been bombarded with pigeon manure letters for the last five years to such an extent that they are sick of the topic there and give an inquirer poor satisfaction. For some time we have been selling our pigeon manure to leather men whose factories are within ten miles of our Melrose plant. Their teams call for it and take it away with very little trouble to us. We get sixty cents a bushel for it, same as usual. If any customer of ours wishes to ship manure to New Jersey or New York, we will help him to find a buyer there, as we have letters from tanneries in both States on file asking us to sell them "pigeon pure."

HIS FLOCK GROWING. About a year ago I bought some birds from you, some \$2.00 per pair and some \$2.50. My flock is

growing and seems to be getting along pretty good, having now 180 birds—will soon have 200 birds. I thought I would try and sell some now. They are all good birds. I want to try and sell what I raise now and if possible make a business of the squabs if there is enough in it to warrant putting up more buildings and getting more stock.

It costs me about \$1.90 per week for feed for this amount. Am I feeding enough?—M. N., Massachusetts.

BUILT NEW HOUSE. I have built a new house for my pigeons. Have increased my flock from the original six pairs to 50, besides selling 30 pairs of squabs. Could I have done any better than that?

Have been having some trouble by a few going light and have followed your advice and think have got the better of the difficulty. I lay the trouble to the poor quality of wheat they have been furnishing me. It seems to be all shrunk up and they don't eat half of it.—A. D. V., Pennsylvania.

Answer. More pigeon troubles are caused by wheat, or too much of it, than almost anything else. Squabs which are thin and dark are caused by too much wheat in the ration. Pigeons fed on too much wheat get thin, with sharp breastbones, and will not lay as they ought to. A good ration of Canada peas and hempseed is necessary to bring eggs and keep the flock in condition. A pigeon will not thrive if not kept in condition by nourishing food. The results of too much wheat are loose droppings, stupid and non-productive birds. Pigeons should be active and eager.

IN FINE CONDITION. My birds I bought a little over a year ago (12 pairs) are still doing fine; have sold several small lots of squabs. I have been following your manual's instructions as close as possible. I have about sixty pairs. They are in fine condition and have lots of eggs and youngsters.—C. W. H., North Carolina.

SQUABS WEIGHING NEARLY A POUND APIECE WHEN ONLY THREE WEEKS OLD. Please send me your price list on birds and supplies as I intend to get about ten more pairs of Extra Homers and want to get them from you. The birds I have now, which I got from you, are doing fine and I have doubled my flock. I could sell all the squabs I have but want them for breeders.

Would you kindly advise me if oats are good for breeding pigeons if fed moderately. Also do you think it wise to sell my squabs when they are from two and one half to three weeks old, as some of them will weigh about fourteen ounces at that age.—A. P., Ohio.

Look up the standing and character of the concern with which you contemplate dealing. Your bank will find out the facts for you. Avoid advertisers whom you find out by investigation are worthless. Have their ratings looked up for you.

STORIES OF SUCCESS ON THIS PAGE ARE NEW. THEY WERE RECEIVED BY THE PLYMOUTH ROCK SQUAB COMPANY OF BOSTON IN NINE MONTHS OF 1906.

Answer. Pigeons do not care much for oats. Pigeons in the street eat them, as they eat peanuts or bread. Of course if you have oats handy and cheap, you can feed some, but pigeons will eat almost every other grain in preference. When squabs weigh 14 ounces they can be killed, no matter what their age.

MOVE THEM AS YOU PROPOSE. I have pigeon breeders in unit numbers one and three. Squabs in unit number two, from one to three months old. I wish to put number three with number one. Number three is breeding right along. Will it hurt to move nest, pigeons and squabs out of number three into unit number one? Will it damage eggs and squabs to do so? If not I can move them through unit number two, as I can let number two in flying pen while I am moving number three.

I shall want more pigeons by fall. I got 13 pairs from you last year, and I have 100 pairs in all now, so you see I have done well with them. I wish you would answer as soon as possible as I do not wish to molest them before I hear from you.—J. P. M., Michigan.

Answer. Move them as you propose, putting the nests in the same relative positions in the new nest-boxes. You will lose few, if any.

INCREASED STOCK. In May, 1903, you sent C. L. Bruce forty (40) pairs of your pigeons at \$2.50 a pair, and in 1904, twelve (12) females. We have sold and increased stock since then by breeding, until, at present, we have about three hundred (300) birds.—Miss H. J., Connecticut.

BEST HOMERS HE EVER SAW. You favor of the 12th June, answering my inquiry of the 9th June, was duly received. Thank for the information. I had fully intended to visit your plant, but, just as I am ready to start, my wife, who was to accompany me on a two weeks visit to the New England coast is taken sick. I have seen the birds which you sent to my neighbor, Mr. P. C. Evans, and they appear to be all you claim for them, the best specimens of Homers I have yet had the pleasure of seeing.

If you can let me have a small lot of one-half dozen pairs, at same price as paid by Mr. Evans, you may enter my order for same, with dozen bowls, for early delivery.—G. W. G., Pennsylvania.

FLOCK WENT TO WORK QUICKLY. Out of the seven pairs of Extra Homers you shipped me June 2, 1906, I have already (August 10) got twelve squabs. I am very much pleased over having such good success,

but I have no way of marking them. You will please send me an outfit for marking them by mail. Send about what you think a beginner ought to have. As the business grows, will send you a larger order.—L. L., Nebraska.

A WOMAN'S WORK. I have 90 pigeons on hand, bred from the 26 my husband bought of you a year ago last April.—Mrs. H. C., Illinois.

STRICTLY ALL RIGHT. A friend of mine of this city recommended you to me as being strictly all right. I will thank you to send me your literature explaining the cost of starting a squab farm of about 250 pairs, raising and marketing same, as I contemplate going in that business. Thank you in advance for any information that you may give me.—W. M. A., Alabama.

RESULTS TELL THE STORY. As all of my birds secured from you in May this year have their second pairs of young ones and I think will continue to multiply as fast, will you kindly forward me a list of commission men as stated in your letter of recent date, Am perfectly satisfied with the results obtained from your birds. If you have any inquiries for birds in this locality I will be glad to attend to them for you.—J. L. T., Indiana.

SIZE OF SQUABS A REVELATION. We are pleased to advise you that we ate our first squab from the lot of birds you shipped in May last Sunday and wish to state that the size of these squabs is a revelation to us, being almost twice as large as any we have ever been able to secure.

The enclosed list will give you an idea as to their productiveness. I also would like to have you answer the questions contained therein.—H. B. R. Illinois.

OUR BIRDS BETTER THAN WE CLAIM. My birds reached me in good order and was glad to see them when I got home from work safe and sound. I think the American Express Co. is about the best there is. Everybody that sees your birds say they are the finest they ever saw. I think when anybody is looking for good birds they don't need to look any further than your place and I know they will go ahead of any birds in this town for looks and flying. I think we will stay here till we get a good flock of birds then we will move outside of town. The next time I send for birds I will try and send you a bigger order.

Your birds are better than you claim for them. Some of them have eggs before their young ones are two weeks old. They get so

We were the first. Our birds and methods revolutionized the squab industry and are widely imitated. But imitators who copy or find fault with our printed matter cannot give you our birds. We have no agents.

STORIES OF SUCCESS ON THIS PAGE ARE NEW. THEY WERE RECEIVED BY THE PLYMOUTH ROCK SQUAB COMPANY OF BOSTON IN NINE MONTHS OF 1906.

big they just about can't sit in the nest. I think if you would put an advertisement in some of the evening papers you would get some more trade. I am advertising your birds to everybody I know.—J. S., Wisconsin.

COMPLIMENTED BY AN EXPERIENCED JUDGE. One of my hens made her nest and I thought she was ready to lay but she sat all one day and part of the next and did not, but had her mouth open panting and seemed very sick. I telephoned to Mr. M. to come and tell me what to do. When he came he held her in warm water for 15 minutes and then fastened her in her nest. In ten minutes she laid her egg and got all right.

Mr. M. holds the world's record for three hundred miles and has some of the most valuable birds in Chicago, and he said my birds were very fine, in fact he said he could have hardly told them from his own, they resembled them so much.

When so good a judge will compliment them so highly I feel very proud of them.—A. B., Illinois.

SQUABS WEIGHING ONE POUND AT TWO WEEKS. I thought you might like to hear from the birds you sent us a year ago. They have been working overtime since. We have 54 birds now with several nesting. Every one is a solid color the same as the old ones.

The squabs we have weighed have averaged a pound at three weeks old. One weighed a pound at two weeks.

There is a party here getting birds of all kinds and colors and claims they are better than what we got for Extras on account of the bands.—J. W., South Dakota.

Answer. It is quite common for parties selling poor Homers to put bands on their legs, some of them quite ornamental, in an endeavor to enhance their value, same as putting a gaudy label on cheap goods. It is the pigeons that count, not the bands. Bands are useful to number the birds, that is all.

NO. 1 PLYMOUTH ROCKS ARE GOOD HOMERS. It will probably be fall before I get my house built and give you an order for more birds. If money is not too scarce the order will be for your best birds, for the No. 1 Plymouth Rocks are doing even better than the Manual claims them to. Your Extra birds must be wonderful.—W. H. W., Massachusetts.

WE "SHOW THEM" OUT IN MISSOURI. I received the grits and oyster shell all O. K. My birds jump on to the grits and hemp seed in a hurry. They are doing well. I will have about sixty squabs this month and quite a

number mating this week. I had an order for 100 squabs this morning. It made me sick to think I could not fill it, but my time came after a while. I will build another house soon and I want 100 more of your birds. Mr. Hall's birds look well. They came through nice. He is well pleased and I think he will order more. There are two more people talking of going into the squab business. I will try to get an order for you.—J. W. H., Missouri.

HAS NEVER SOLD ANY SQUABS LESS THAN NINE POUNDS TO THE DOZEN.

About three years ago I purchased of you six pair of Homer pigeons for which I paid \$2.50 per pair. My flock are all from the stock I bought of you and I have some nice birds. I have never sold any squabs under nine pounds to the dozen at four weeks old. I never sell my birds after they have left the nest for squabs. Will you send me your price list for grains, that is, Kaffir corn and red wheat. I would like the address of Boston dealers.—C. E. W., Rhode Island.

LETTING BIRDS FLY. I would like to have your opinion and advice on a matter that is very important to me. I have a beautiful start with your birds, have followed your book exactly and the result has been very gratifying. Now what I want to do is to buy about three hundred more old birds from you and pen them. Will the young birds be as prolific, mate and hatch as well if properly fed, watered etc., exactly as my pens are, if I allow them to run loose on my farm? There is no danger of them being shot and I would much prefer allowing them the run of the farm. I have the buildings that I could convert into comfortable houses at once, and I will appreciate your thoughtful opinion and advice in the matter for I know you are headquarters.—T. W., Tennessee.

Answer. Birds which you raise you can let fly because they know no home but yours, but Homers which you buy you cannot let fly safely because they know another home (their old home) and their instinct and desire to go home may lead them to leave you.

NEW JERSEY NEIGHBORS ALL AGREED.

The six pairs of birds received from you the first day of May are still doing fine (July). One pair has her third pair of young at this writing—less than three months. The rest will hatch this week. Mr. Tevis (the neighbor I spoke to you about in a former letter) came over after me to see the birds that he had just received from you. They are fine birds and he is very much pleased with them and sorry that he did not take my advice and send

The squab industry is growing every year. More squabs were bred in 1906 than ever before. Prices were better and they are going to be as good or better in 1907. The habit of squab eating is growing in every section.

STORIES OF SUCCESS ON THIS PAGE ARE NEW. THEY WERE RECEIVED BY THE PLYMOUTH ROCK SQUAB COMPANY OF BOSTON IN NINE MONTHS OF 1906.

to you in the first place, but he bought about 60 pairs from a New Jersey dealer. He showed him a letter that was supposed to have come from a man that bought birds of you, saying that he didn't want any more of them. But now he sees the difference when he has them side by side. Mr. Webster, my next door neighbor, is so well pleased with the way mine are doing that he is going to send for a few pairs this fall. I would if I could, and had the room.

I now have 16 pairs of the Plymouth Rock birds. My pen is open to any one that wants to see the birds before they send to you for breeders. I thank you for the fine birds you sent to Mr. Tevis. It shows that I didn't exaggerate your ability, to send six pairs or 100 pairs of fine birds.—D. C. T., New Jersey.

FINEST FLOCK HE HAD EVER SEEN.

A year ago to-day we received eighteen pairs of your Homers. Our flock now numbers nearly 100 pairs and all are doing fine. We have sold a few pairs at \$1.25 per pair, and have had any amount of inquiries after squabs. We have had a number of fanciers up to look at the flock, and all seem to think they are an exceptionally fine lot of birds. One gentleman who keeps an excellent lot of imported birds said they were the finest flock he had ever seen, which speaks well for your birds.—B. B., Michigan.

BEST BIRDS IN HIS CITY. Find enclosed \$16.34 for which to send me a dozen of your Homers, a dozen of nest bowls, and two feet of aluminum tubing. Would have liked to send an order sooner but had no place to keep them. My birds are doing fine. We have moved into a larger place where I can let my birds out in a wire cage. Your birds are the best I ever saw and the only ones I ever intend to keep. I have sold off all my young stock so I have more room for the others.—J. B. T., Wisconsin.

SPLENDID WORK WITH SPLENDID BIRDS. I wish to advise you now (August, 1906) of the splendid luck I have had with the six pairs of birds purchased from you last May and which were received at my home on May 17.

These birds, within a week after arrival, commenced to construct their nests and, out of the six pairs, five began hatching within two weeks and every egg produced a squab. Two squabs weighed at the age of four weeks and two days, 16 ounces, after plucking, and the remainder weighed from eight to 12

ounces. The two squabs, weighing 16 ounces, were the largest I ever saw and I thought you would be interested in knowing the weights.

On account of not having room for any more birds, I am killing the squabs as they mature but would have liked to have mated the two large squabs, as I believe that their offspring would have averaged 16 ounces each.—S. P. N., New Jersey.

DOUBLED IN THREE MONTHS. Enclosed find money order for \$1.70 for which please send leg band outfit. The birds I bought of you in April are doing fine. They have doubled themselves.—W. A., Missouri.

DOING WELL IN CANADA. Saw your advertisement in R. P. Journal, "Squab book free." Anything new in it? I have your book of 1904 with two dozen your Homers. They are doing fine. What would you sell me one dozen more?—P. I. B., Quebec.

ORDERS FOR A FRIEND. I enclose you herewith a check for \$30. Please ship to enclosed address 12 pairs of your Extra Plymouth Rock Homers. Be sure to send him some nice ones.

Those we bought of you some time back are doing nicely and if these show up as well I think that I will be able to send you some more orders soon.—S. W. T., Georgia.

HAS DEALT WITH THE FAKIRS. The pigeons that you shipped to us have arrived in fine condition and the best of health. We are shipping back to you, via American Express the wicker basket in which you sent our pigeons. Also our many thanks for the trouble you took in selecting the different colored pairs.

I wish to say that the pigeons are beautifully mated, because one pair have started in business already, the hen having laid two eggs, and all the others have showed promising signs of mating.

After having dealt with poultry fakirs and receiving their treatment, I fully appreciate your kind treatment which is so unlike that of these fakirs, but your endeavors are not in vain, as I soon expect to order some more pairs. Your treatment has encouraged me. I have provided an excellent house and pen for them. Thank you for your interest shown in this matter.—L. J. H., Illinois.

IN THE BLUE GRASS STATE. Could you kindly tell me where I could get some white Homers? The Plymouth Rock Homers

New laws passed a year ago by the legislatures of Massachusetts and New York forbid the sale of quail except in the months of November and December. The penalty is a heavy fine for every quail found in the hands of any marketman or restaurant keeper. Quail are no longer found on bills of fare in these two states except around Thanksgiving and Christmas. Squabs are on the bills of fare all the year everywhere. Other states, it is said by sportsmen, will follow Massachusetts and New York with a similar game law.

STORIES OF SUCCESS ON THIS PAGE ARE NEW. THEY WERE RECEIVED BY THE PLYMOUTH ROCK SQUAB COMPANY OF BOSTON IN NINE MONTHS OF 1906.

I got from you are doing fine.—R. L. J., Kentucky.

HIS SECOND ORDER. Enclosed please find express money order for five dollars for which please send me three pairs of your No. 1 Plymouth Rocks at your earliest convenience. A previous order which I received from you has been doing fine.—J. E. D., Pennsylvania.

PROLIFIC BIRDS. I purchased 12 pairs Homers of you about 18 months ago and they have done fine work for me. I have 50 pairs mated birds, saved the best ones and sold the second class.—J. A. D., Pennsylvania.

SENT SISTER GOOD BIRDS. I enclose a money order for \$17.88 for which please send three dozen nappies and six pairs blue checkers. You sent my sister such fine birds that I would like the order duplicated.—H. S. B., New York.

RECOMMENDS OUR BIRDS TO EVERYBODY. The birds arrived in good order and I am pleased with them. I have 14 fine birds from the first ones I bought of you and I think the last four pairs will go to work soon. I recommend your birds to everybody.—J. M. M., Philadelphia.

HE KNOWS OUR TEACHINGS ARE RIGHT. I have read your Manual carefully, studied every point as I went, because I wanted to impress it on my mind. I have found in my own experience that pigeons do just as your Manual says. Your book is worth two or three dollars instead of 50 cents.

I want to thank you for the favor you did at finding the weight and charges of some things for me. Would you kindly tell me what would be the cost of freight charges on one hundred, two hundred and three hundred pounds of grain?—G. A. S., Georgia.

FIVE DOLLARS A PAIR WOULD NOT BUY HIS. Birds came Friday at noon, and accept many thanks for the fine birds you sent to me. My friend says \$5.00 per pair would not buy his.—J. P. B., Georgia.

PLEASANT BUSINESS FOR A WOMAN. You will possibly remember that a year ago last April I bought from you twenty-five pairs of your Extra Homers.

I now have some eighty pairs in my house and have used something like two hundred squabs. My birds have done well and I have lost only one of my original stock.

I am thoroughly convinced that there is money raising squabs and it is a very pleasant business for a woman, requiring only a little

time each day to attend to them and one soon becomes very much attached to them—Mrs. M. L., Kentucky.

GENEROUS TREATMENT. The pigeon that I wrote you about a few days ago has died. I think it must have been injured in shipping. It was a female. I think your promise to send another a very generous one, and I would appreciate it very much. In about two or three months I expect to order more birds of you. The others are doing excellently.—A. H. B., Massachusetts.

TRADE BEGETS TRADE. I have been instrumental in making some sales of pigeons for you. At least I have recommended you to several people who said they would buy of you. Did a doctor of Fairhope buy a lot of pigeons of you? He came over here to see me about what I thought of the business and I recommended you to him strongly. I just sold 30 pair of my pigeons to Dr. O. F. Cawthon and E. J. Buck and I recommended them to buy 10 or 12 pairs of you. I will continue to advertise you all I can. Later on I want to rearrange my house and build up a big place and I will send to you for what I need.—M. O., Alabama.

GOOD INCREASE IN SIX MONTHS. Yesterday I wrote you for the Manual or National Standard Squab Book, but I forgot to tell you of some of your birds I have seen. Last August or September a doctor friend of mine in Brunswick bought of you six pairs of Homers. In two or three weeks they began to lay and hatch. He sold four or five pairs at \$1.00 to \$2.00 a pair. He has now between seventy and eighty total. They are beauties and if mine are as pretty and do as well I don't think I will be disappointed. Please send Manual as quick as possible.—G. S., Georgia.

GOOD RECORD FOR FIRST MONTH. I deem it will be gratifying if you know how the 13 pair of Homers I received from you on May 3d are doing.

There has not been a sick one in the lot and they are very much admired by all who see them, and are pronounced first-class Extra stock.

They are contented and very busy all the time. Eight pairs are breeding now, with three nests each having a pair of nice healthy squabs. I think this a splendid record for the first month in a new home.—S. H. W., Pennsylvania.

LOST HIS TEXT BOOK. Please find enclosed 50 cents, and send me another National Standard Squab Book. I have mis-

Remember, these are stories told in 1906, by customers who are really raising squabs with our birds and not merely talking about what they are going to do. They are getting satisfactory results day after day.

STORIES OF SUCCESS ON THIS PAGE ARE NEW. THEY WERE RECEIVED BY THE PLYMOUTH ROCK SQUAB COMPANY OF BOSTON IN NINE MONTHS OF 1906.

placed my other one and can't find it. My birds are doing well. I have had 15 pairs of young birds since I had them. I sold one pair of old white birds for three dollars to a bird store.—H. K., Missouri.

ATTRACTING ATTENTION. Please to send some literature to address of gentleman enclosed, descriptive of the squab business, and give him prices on same. I have been talking with him in regard to the business and as he has a couple of farms over in Michigan, I have no doubt but what he will make an investment.

The pigeons that I purchased of you last spring are doing very nicely. Our pen is attracting considerable attention. We have about 75 in it now and we are about to build larger accommodations.—T. T., Illinois.

ENLARGING PLANT. Will you kindly advise the address of party who purchases pigeon manure?

My birds are getting along very nicely. Intend putting up a large house for them in the near future and will write you later regarding wire for flies.—B. T., New York.

SWAMPED WITH SQUAB ORDERS. It is impossible for me to fill the orders that I have for squabs. I am sending you an order. Please get them out as soon as possible. When I receive them, I will order another dozen Extras. I now have about 350 pair of breeders. They are doing fine.—H. S., Louisiana.

SATISFIED WITH ALL. I received the two baskets containing 36 birds on Thursday. Pardon delay in not answering sooner, as I was out of town. I am perfectly satisfied with all the birds I bought of you and hope to be able in the future to secure more. Am shipping the two baskets this morning by National express, homeward bound.—J. W., New York.

GOOD REPORT. Please find enclosed a money order for which please ship me 12 pair pigeons as I saw some birds which you shipped to Mr. Walter of this town. I received a booklet from your firm some time ago but did not order birds until I saw Mr. Walter report on his. I decided to give you an order if you can send me mixed colors. Ship via Adams express. Wishing you success.—L. D., Pennsylvania.

ONE YEAR'S GOOD TRIAL. Quote me prices on your No. 1 Homers. Those I bought of you one year ago are doing nicely.—C. M. R., Pennsylvania.

THIS LETTER WAS WRITTEN BY ONE OF OUR CUSTOMERS TO HIS FRIEND IN A NEIGHBORING TOWN. I am pleased to know that you are getting along so nicely with your squab house. Wish you could see the last consignment of birds I received from the Plymouth Rock Squab Co. of Boston. They are beauties, and they commenced building their nests the second day after they arrived. I have no idea where you are going to purchase your birds but I certainly think you will make no mistake if you get them from Mr. Rice, for the ones he sent me are the finest I ever saw.

I am confident if you buy your birds of Mr. Rice he will use you right for he has done the right thing by me.—F. B., New York.

WANTS 500 PAIRS IN THE SPRING. My pigeons are doing very well but they are shedding a great many feathers. I want to make arrangements early in the spring for 500 pairs of your best stock, but before building my houses I want to take a trip to Melrose and look your plant over, in order to get all the ideas about construction, maintenance, etc. I enclose separate slip with a few questions that I would like to have you answer if it is not too much trouble.—J. W., North Carolina.

LOST ONLY ONE BIRD, AND THAT BY ACCIDENT. I recently bought a few pairs of birds that you sold to a gentleman in this city about March 1st. He was moving to St. Louis and had to dispose of the birds. With what I got from you and the seven pairs I bought from him I now have 65 birds. **Have never lost but one bird and that was my own fault for I was experimenting on it and accidentally killed it.** I have a market in St. Louis for all I can ship at \$4.00 per dozen. If not asking too much would you kindly give me the address of a couple of Chicago and New York commission men that handle squabs.—W. E. T., Missouri.

STARTED WELL. I write you in regard to the pigeons you will remember we bought of you (24 pairs) about two years ago this month. Our Homers have done very nicely. I have about 200 pairs. We sold 40 pairs last year. We have quite a nice little plant started.—A. C., Wisconsin.

DOING WELL, GOING TO BUILD. Please send me a plan for your multiple unit house. My pigeons are doing fine.—D. B., Illinois.

STARTED IN TO MAKE REFORMS. Please find enclosed check for nine dollars

Somebody handling the small, stunted Homers may tell you that eight pounds to the dozen is good weight for squabs and that squabs are not bred to weigh more from Homers. That is true, from his Homers. In these pages you will find that eight pounds is low for Plymouth Rock Homer squabs.

STORIES OF SUCCESS ON THIS PAGE ARE NEW. THEY WERE RECEIVED BY THE PLYMOUTH ROCK SQUAB COMPANY OF BOSTON IN NINE MONTHS OF 1906.

for which kindly send us one dozen drinking fountains. We would like you to get these off as soon as possible.

I was very much pleased with my visit to your plant at Melrose which I made yesterday, especially with your facilities for mating birds up. Got some new ideas along with a lot of good advice from your superintendent, and to-day have started in to make a few new reforms here.—T. H. D., Connecticut.

KNOWS PLYMOUTH ROCKS BY EXPERIENCE. I saw your advertisement of Homer Pigeons in a magazine. I would like very much for your company to send me one of your catalogues, and how much you charge for Homers a pair. I know from experience that a Plymouth Rock Homer is a good breeder. A friend of mine got some from your people a short time ago, but I did not inquire as to the price of them. In answer to letter from you, I will send for some, and if they are satisfactory, I will be glad to get more, as I am a great pigeon fancier.—W. A., Illinois.

ONE YEAR'S SATISFACTION. Send one bushel of Kaffir corn and one bushel of Canada peas to me. It may interest you to know that the birds I bought from you a year ago are in every way satisfactory. I have doubled the number of workers in that time and have had all I wanted for my own table, and sold quite a number.—J. B. H., Massachusetts.

SOME WEIGH 14 OUNCES WHEN 15 DAYS OLD. I received your pigeons in May when I was in Longueuil. They have done well, as I have had some which weigh 14 ounces at 15 days old. What do you think of a mirror in my squab house? I will be very pleased to receive all your advertising booklets.—G. C., Canada.

SUNFLOWER SEEDS ARE GOOD. Your book doesn't say anything about feeding pigeons sunflower seeds. Will they eat them or isn't it good for them to have them? Please let me know. The pigeons I got from you are doing pretty well, I think. I may get more next year.—B. J., Vermont.

Answer. Sunflower seeds are a good pigeon food and are used by many of our customers. They are rich and oily and should not be fed in excess, but as a dainty. A good way to feed them is to throw the whole head in front of the birds and let them pick out the seeds themselves with their bills.

BREED WELL IN CALIFORNIA. Enclosed find money order for 40 cents for which

kindly send me two feet of your aluminum tubing for bands. Also send one of your price lists, as mine has been mislaid. Twenty-four pairs of Homers purchased of you one year ago are doing fine. Flock now numbers 150.—W. J. M., California.

CONTINUOUS SATISFACTION. Enclosed find check which is to cover enclosed order. All the birds which you have sent me so far are very satisfactory.—G. S., New York.

FINEST BIRDS AROUND. Your birds I bought of you a year ago are going fine—the finest birds around, so my friends say.—Mrs. J. J. M., Massachusetts.

HOTEL KEEPER RAISING HIS TABLE SQUABS. Am very glad to know that you were pleased with our menus and will continue mailing them to you from time to time if you do not object. I hope that the temptation will be strong enough to cause you to come to our city and look over our squab farm. I have been quite successful and have a fine lot of birds. It is more than likely, however, that I shall want some additional birds in the very near future. I would like a few show Homers, Dragoons and Runts' For squab raising purposes, I could not ask anything better than I now have. Will mail you an order for supplies in a few days.—W. S., Georgia.

BEAUTIFUL, HEALTHY BIRDS. Will you please quote me the price of your wicker shipping baskets, size for 12 pairs, or kindly forward me the address of the manufacturers of same. Also state in your letter if the droppings must be entirely free from straw and feathers, or reasonably so, to satisfy the purchasers at the tanneries. The six pairs I purchased of you two years ago have increased to 150 or 170, besides what I have killed, and the stock has proven entirely satisfactory in every way. I have taken pains to follow your instructions to the letter so now I have the above number of beautiful, healthy birds.—W. H. Y., New York.

Answer. It is impossible to get all straw and feathers entirely out of the manure. Sweep out what you can with a broom before cleaning the squab-house. The leather people do not care if some straw and feathers get in but they do not want gravel and tobacco stems. The latter discolor and stain when wet.

BIRDS THAT FLY AWAY. On about April 20, 1905, we bought of you six Plymouth Rock Homer pigeons. Since then they have

For six years we have had a complete monopoly of the fine trade of the United States. We sell more Homers every year than all other firms and breeders combined. The reason for this is that our birds demonstrate their value and make friends wherever they go. This supremacy we intend to maintain.

STORIES OF SUCCESS ON THIS PAGE ARE NEW. THEY WERE RECEIVED BY THE PLYMOUTH ROCK SQUAB COMPANY OF BOSTON IN NINE MONTHS OF 1906.

done exceedingly well, and we have got a pretty good start in pigeons now, but what I write you to-day for is this. This morning at 9 o'clock one of the birds we got of you got out of the flying pen. She flew into the air and started for Boston. This was a brown bird, and we thought she might arrive at her destination, so I wish you to keep a lookout for her and see if you can tell if she gets there. If she does arrive, would you mind letting me know? I am anxious to know if she gets there. This was a female bird and she left a young bird about a week old in the nest.—R. H., Iowa.

Answer. No Homer would fly that distance. We receive many letters like the above. Customers should watch the doors of squab-house and pens and not let their birds get away.

LARGE, HEAVY AND FULL-BREADED. Enclosed find money order for one more dozen pairs of your Extra Plymouth Rock Homers.

I did not rush a letter down to you the same afternoon I received the other birds for the reason that I wanted to try them out first. The dozen pair of Plymouth Rocks, on their arrival weighed exactly 22 pounds, while a few days later I received another dozen pair from another company and they weighed only 17 pounds. They were not full-breasted like your birds.

I received first shipment on the 2nd of March. They are now working like good fellows. Have three nests with eggs in.

You will hear from me occasionally with further orders.—A. P. S., Michigan.

WANTS TO BUY SOME GOOD ONES. Kindly send your catalogue and any other printed matter you have about pigeons. An acquaintance wants to buy some good birds and he is going to look at my lot that I received last Thursday. I feel sure I can land him as a customer for you.—H. D. C., Pennsylvania.

GOING SLOWLY. Please send free book, "How to Make Money with Squabs." The birds bought of you are doing well now and some of their young are hatching. Have enough now to ship a dozen a month now.—W. M., Maryland.

JUST THE BIRDS. I thought I would let you know how my birds are getting along. They arrived on Tuesday, May 1st, as I wrote you. Thursday of the same week one pair had commenced to build. At this writing four pairs have eggs. The others are building. That is what I call going right to work.

I am very much pleased with them. There was a party here this morning looking at them. He talks of putting in one hundred pair, and says they are just the birds that he wants. He is coming up to see your plant. Of course I showed him my birds and told him just what they were doing and where they came from so I think he will be a customer for you. I shall advertise the Plymouth Rock birds wherever I have a chance. Thank you for your kindness.—J. C., New Jersey.

SQUABS WEIGHING ONE POUND APIECE WHEN ONE MONTH OLD. I received my pigeons from you April 20, 1905. I have one pair that has hatched eleven (11) times up to the 22nd day of April, 1906, so you can see that they have had fairly good care. I now have 110 birds and am getting them fast now and will commence shipping when I get 70 or 80 pairs. I have weighed a number of birds four weeks old that weighed 16 ounces and I think that is very good.—L. F., Iowa.

QUICKLY AT WORK. Please pardon my delay in acknowledging the receipt (right side up) of the pigeons you shipped to me at Harpers Ferry, W. Va., which place I left before the shipment arrived. My wife informed me that they were all in good shape and the finest specimens she ever saw. Also thought they had returned the baskets to you. As soon as I go home, which will be in a few days, will send you another order. My wife's third letter tells me that 16 pairs out of the 18 have gone to setting. Don't think you can beat that at home. We have everything good to feed them peas, kaffir corn, wheat and millet, and we intend to make a success of the business.—W. S., Virginia.

SQUABS HAVE AVERAGED ONE POUND APIECE. Enclosed please find certified check for \$173.98 for which kindly send me birds and supplies as enclosed. Kindly send the shipment of birds as soon as possible as I would like to receive them before Tuesday. All my birds are doing nicely. My squabs, under your system of feeding, have averaged a pound apiece and I expect from the present outlook of things to make them average a good deal more.—E. H. M., Pennsylvania.

THIS WOMAN IN BRITISH COLUMBIA KNOWS WHAT A FINE HOMER IS. A week ago I wrote you complaining of non-acknowledgment of my remittance sent in with my order. As I was beginning to wonder if it had miscarried, I am pleased to be able to inform you that I received the best possible answer to my letter in arrival of the birds I ordered from you. They arrived

The equipment at our farm for mating birds cost \$2000 and no expense was spared to make it perfect. A thousand mating coops are in constant use. The principal mating house is heated by hot water so as to get the best and quickest results in the cold months.

STORIES OF SUCCESS ON THIS PAGE ARE NEW. THEY WERE RECEIVED BY THE PLYMOUTH ROCK SQUAB COMPANY OF BOSTON IN NINE MONTHS OF 1906.

about the same time as your letter (May 1st). All of them are in first-class condition and I am very pleased with them, as I consider that they are a fine lot of birds, and I think I know what a fine Homer is when I see it, as my father and brothers have bred and sold trained flying Homers for years in Lancashire, England, some of them worth twenty-five dollars a pair. Although I never heard of squab raising before I came to Canada three years ago, when I first saw your book advertised in *Munsey's* I thought it was some kind of game bird reared in captivity, and sent for your book more out of curiosity than anything else. I think I shall like the business very much and shall probably be sending another order in a month or two when I see how I go on with the birds I have got. Thank you very much for the two pairs extra you sent, also nest bowls. They were a very agreeable surprise to me as I did not expect anything like that on such a small order. The express charges were six dollars, and 25 cents duty on nest bowls. If you would write me from time to time giving me your prices I shall be much obliged.—Mrs A. R., Canada.

SQUABS WEIGHING FROM 13 TO 16 OUNCES. Please send me at your earliest convenience the names of reliable merchants to whom I can ship squabs, in New York. The 80 pairs I bought of you last fall are doing well. I sold squabs that weighed from 13 ounces to almost one pound apiece. I have over 100 pairs of young ones that I am saving for stock.—H. J., Ohio.

WORTH THEIR PRICE. Some time ago I sent you an order for three pairs No. 1 and three pairs Extra Homers, stating that I wished to compare with Homers a friend of mine was ordering at a very much lower figure. In a word, after due comparison, I order six more pairs Extras. Please send me fine birds.—C. J., Illinois.

SQUABS WEIGHING 16 TO 17 OUNCES EACH. Please find enclosed remittance for which send me 12 pairs and supplies noted. The dozen pairs you sent me started in to do business last month, having been moulting up to that time. The first two pairs squabs hatched, at one month old, weighed one pound each, with one that was 17 ounces. That is very good, is it not? I am well pleased with them. Make this dozen as good and I shall be more pleased.—C. B. G., Connecticut.

HIS FOURTH ORDER. Enclosed you will please find money order for which you will please send me as soon as possible one dozen

pairs Extra bred Homers (fourth order).—L. C., Louisiana.

SUPERIOR IN LOOKS AND WORKS. The birds (60 pairs) arrived on the late train from St. Paul on Sunday night last, and remained in the depot here until early on the following morning when we took them home. Outside of the injured ones mentioned, I will say that the birds arrived in perfect condition and are fully up to what we expected them to be. They are now "at home" and present a beautiful appearance. The birds which you sent me last November (nine months ago) are entirely satisfactory, and "out-class" any I received from the———or those which my friend here received from the same people. Mine are plump, his are "cranish," long-legged and long-necked. I would not keep that kind of birds. My friend has not accommodations for pigeons, and wanted to sell out. A doctor who for several years rented offices in my law office building here, looked them over with the view of purchasing the outfit, and I advised him to do so, to get a start in the business. He visited my lofts, and saw my birds, wanted to buy some from me, and after he saw mine, he would not buy of my friend. I gave him your address, but have not seen him since, and do not know whether he has made a purchase or not. I have none to sell at this time as we are trying to increase the flock to at least 1200, for which we have ample accommodations, then we will begin to sell.

There is no mistake in saying that the birds which I received from you, out-class those which the——— have sent here. If your Mr. Rice should ever come to this country I would be pleased to have him stay with me and look over the "greatest" farming country on earth.

My elder boy (17 years of age) visited the great Minnesota State Fair. Saw Dan Patch break his record, reducing it to 1.55 flat. He looked the pigeons over as a matter of course, and he tells me that he could find no Homers there which compared with ours. He intends to exhibit some at the fair next fall.—H. M., Minnesota.

MADE A SUCCESS AND GOING AHEAD ON A BIG PLANT. I have a party that wants to go into the squab business with me, and it is possible that I will call on you during November for 2000 breeders. I have done very well with the 800 I have, encouraging enough to put in quite an extensive plant. I would like to have your personal opinion as to whether 2000 birds will do as well in 20 units of 100 birds each with one fly 12x48x200 as they would in 20 units with 20 flies 10x12x48. On

Our whole time and energies are given to squabs. We handle trade as it ought to be handled—promptly, courteously and thoroughly, with every detail attended to. Letters are answered at once. It is a business with us, pushed steadily every day in the year except Sundays and holidays, and not a side issue or an amusement.

STORIES OF SUCCESS ON THIS PAGE ARE NEW. THEY WERE RECEIVED BY THE PLYMOUTH ROCK SQUAB COMPANY OF BOSTON IN NINE MONTHS OF 1906.

account of labor I would prefer the one large fly, but I want no experiments and leave the matter with you. I can get \$4.00 per dozen for a large portion of my squabs, and would like to have an opinion as to what 5000 of your breeders would net us yearly when we raise our own feed on the farm.

WE SUPPLY HENS TO THOSE WHO NEED THEM. After recommending your firm to A. F. Kennelley of this city and he being a purchaser from you recently, I find that he is well pleased with treatment accorded him. Enclosed please find \$5.00 for five female birds to be used as breeders. I bought some birds from a friend of mine and he had five odd cocks which I want to mate up. You will forward these by first express to my address.—H. E. W., Ohio..

BEST BIRDS HE EVER SAW. The Homers ordered from you reached me in due time and in excellent condition. They certainly are the finest birds I ever saw. I really believe they are a finer lot than the first consignment, if that be possible. The second day after their arrival they commenced building their nests, which I imagine is a pretty good record.

Some of my friends have secured birds from other parties and although I have not seen their birds, I am confident they can't tell me that they have a finer lot than mine.

If I have an opportunity of securing you any customers I shall be only too glad to do so.—B. Y., New York.

BEST HOMERS IN CALIFORNIA. Birds received in Al condition. Your birds have stirred up quite some interest here and what I hear from people who know is that your birds are the best in the colony. As it is I am well pleased with the bunch. I have a house 12 x 32 feet divided into four pens 8 x 9 feet with a three-foot passage running the length and everything up to date. That also has opened their eyes in the building and arrangements in an up-to-date squab house. I have had the birds less than a week and am pretty well advertised already. The market here is strong at \$3.00 to \$3.50 and the demand far exceeds the supply.—C. H., California.

SOLD YOUNGSTERS FOR \$2 A PAIR IN KANSAS. Enclosed find remittance for one leg band outfit. My pigeons have been doing fine, and are keeping busy all the time. Have sold off the young pigeons at eight weeks old for \$2.00 per pair. What is the difference in Canada peas and the peas we raise here? Will the common peas do to feed to the pigeons?—G. W. S., Kansas.

LATEST NEWS FROM THE NEW YORK MARKET; HIGH PRICES WHICH ARE GOING HIGHER BECAUSE OF THE NEW LAW FORBIDDING ENTIRELY THE SALE OF QUAIL EXCEPT IN NOVEMBER AND DECEMBER. I take the liberty of asking you for a little more advice for the birds I bought from you last November. Of sickness I have not seen any sign of it. I lost only two of them, one of apoplexy I think, because it fell like shot dead, the other one died of diarrhoea. Of the young squabs, the casualties have been a little higher, but out of 50 I did not lose more than six, or 12 per 100.

Now I wish you would give me your opinion how I have progressed, if I am on the regular average or if I am under it.

The prices for squabs on the New York market have been very high all winter—have reached as high as \$6.50 a dozen for squabs of over 10 pound a dozen, and \$4.50 for birds of near eight pound or so. Of course private trade is better and I have been able to sell squabs for 50 cents apiece easily.

I have a set of birds that give me three eggs and have hatched them successfully with three days late for the extra one. Does that happen often?—H. G., New York.

WILL NOT BUY ANY HOMERS BUT PLYMOUTH ROCKS. Last May I ordered from you twelve Plymouth Rock Homers. They arrived on the eighth of May and on the twelfth of the same month the first egg was laid. Five pairs of them went to work almost immediately and have been at work ever since. I raised the squabs during the summer. I have now 13 pairs of mature pigeons. Twelve pairs work constantly and I am very much pleased with them and want to thank you for them and as you are so kind as to offer to answer questions and to help we people who do not know all about raising squabs I shall be so much obliged if you will give me a little help. My present ambition is to increase my plant. I want to buy some Extras from you as soon as I can raise the capital. I can buy Homers nearer home but yours have done so well for me that whatever new stock I get I would like to get from you. You say in your book that you will give your patrons the address of a good New York buyer. Will you please send me the address?—C. O., New Jersey.

BRANCHING OUT. Please quote me your best figures on the following: Homer pigeons in pairs ready to go to work in lots of 20, 50 and 100 pair lots. Hemspeed in bushel lots. Health grit in 100 pound lots. I have your prices of last year but presume there are some changes. I purchased 12 pairs of Homers from you last spring and they raised me about

These are strong letters. Read them over. You want some assurance, when you buy pigeons, that you will be treated right, as these customers were.

STORIES OF SUCCESS ON THIS PAGE ARE NEW. THEY WERE RECEIVED BY THE PLYMOUTH ROCK SQUAB COMPANY OF BOSTON IN NINE MONTHS OF 1906

60 young ones by the first of November.—R. W. H., Iowa.

BLOOD AND HIGH BREEDING COUNT. Enclosed find draft for which you will send by Pacific express, Extra Homers, as per memorandum. Several weeks ago I ordered 15 pairs of—. When the birds came I did not think they were much more than common birds. A friend in our town wanted some breeders and I got him to try your birds. They came last night. There is a big difference between the birds. My first birds do not show any white on bill to amount to anything and they are most all white or very light color. Yours show their high breeding. Blood tells, when you put them together. I sold mine at half price to-day to get shut of them. What I want is blooded stock or nothing. Please send me a good collection of assorted colors, blues, reds and checkers. I ordered one of your squab books some time ago and I think it the best I ever read on pigeons.—J. A., Missouri.

TRIFLING DEATH LOSSES. In January of this year I purchased 12 pairs of your Extras. They are now (April) in fine condition and have hatched out 24 young ones, 22 of which are living and doing fine.—W. J., Massachusetts.

SEVEN PAIRS WORTH \$25, THIS ARKANSAS CUSTOMER THINKS. Writing you a few lines to let you know that I got the pigeons all O.K. They were all well. I got them two weeks to-day and out of the seven pairs, four pairs of them have built and are setting on eggs already. I would have written you sooner but wanted to see what they were going to do. I would not take \$25 for the seven pairs. Sending the basket back this evening with the letter. You can put this letter on your list. I think it is the only one from Arkansas.—C. W., Arkansas.

GOOD SHOWING AFTER THEIR 3000-MILE JOURNEY. Enclosed please find Wells Fargo Express money order for \$1.70 for which please send me by mail post paid, one leg band outfit at your very earliest convenience. My birds received from you March 17 are doing fine. They got right to work and one month from the day I received them I had three pairs of squabs hatch. Since then one more pair has hatched and two more pairs are setting and two pairs building. I think that is a pretty good showing in six weeks for 10 pairs after travelling 3000 miles. I lost one hen. She got sick and I could not find what was the trouble. She did not have diarrhoea, but just seemed to droop and die. The remainder of them are as fine as could be.

Will you please quote me prices on nine pair Extra Homers to be delivered in June or July. Can't tell yet just when I will be ready for them, but either June or July sure. Best wishes for your continued success.—E. M., California.

ARKANSAS CUSTOMER IS PLEASED WITH SQUARENESS. I received your Manual a day after I wrote that letter, and I received another one. I have sold both of them, and find enclosed \$1.00 to pay for your extra one and another one for myself. You people treated me so well I won't buy any Homers from anybody else. I was surprised at your squareness and have told every one about it and got them all a-going in the right direction. I was very, very much pleased with your Manual.—G. R., Arkansas.

HIS MONEY TALKS FOR HIM. Last August I purchased 124 pairs of your Extras and am now in the market for about 375 pairs more. I am also in need of some extra hens of the same quality. Can you supply same? Also let me know if you can furnish these birds in pairs in the following colors: blues, blue checkers and red checkers in any number I may desire. Please state your very lowest price on above number of pairs. Let me hear from you by return mail, as I am in a great rush for the birds.—S. T., Indiana.

CANNOT SAY TOO MUCH IN PRAISE OF OUR HEALTH GRIT. Enclosed find \$2.00 for 100 pounds of health grit. I find this grit the best on the market for pigeons. I cannot say too much for it as it keeps the pigeons in fine health. Although the price is high I would never be without it. I have quite a few people that want to get this grit from me. Can you let me have it cheaper, so that I can make something out of it? Answer and let me know.—R. O., New Jersey.

BIG SQUAB FARM WHOSE OWNER BOUGHT HIS BREEDERS OF US. I visited a squab farm last Sunday and before I left found that the owner bought his breeders of your company, five hundred pairs. He has 1100 pairs at present and is making a fortune. After seeing this farm I was more than convinced that the Plymouth Rock Squab Co. is O. K. If I get as good a lot of birds as he has I certainly will be pleased. I am sorry that I did not figure on handling more birds than I did. Have built house to accommodate 100 birds. Enclosed find stamps for which please send plans and specifications for squab houses. No doubt you will receive a larger order from me in a short time. Will notify you in a few days when to ship birds.

Beware of anybody who tries to make a sale to you by running down the Plymouth Rock Squab Co. Insist that he show you letters like these in proof of his claims.

STORIES OF SUCCESS ON THIS PAGE ARE NEW. THEY WERE RECEIVED BY THE PLYMOUTH ROCK SQUAB COMPANY OF BOSTON IN NINE MONTHS OF 1906.

I want to have everything complete before I have them shipped.—I. S., New York.

HAS TRIED THEM AND KNOWS. I am at present debating with myself and with some of my relations in regard to starting in the pigeon business. My folks are trying to persuade me that it is going to cost too much to start, and that I will not realize any great profits very soon. As I see, and at the best I can figure it out, it will take about \$100 to start in with fifty pairs of breeders and build a home to accommodate them, getting the price of building down as low as possible with lumber at its present price. What I want to know is, do you think it would pay me to start and about how long do you think it would take to get back the amount paid out if I relied entirely on the birds?

I think I could get it back in four months at the most, because I have three pairs I purchased of you in January, besides the young ones I have raised. I have watched and studied their ways and know something about them. I know how fast they breed, etc. Now am I right in my estimation as to the time it would take to regain my money and would you advise me to start if possible? My birds I have now are doing fine.—S. A., Massachusetts.

MANURE FOR SALE. Will you please give me the address of some firm to which I can sell my pigeon manure? My pigeons are doing well this spring.—T. O., New York.

RHODE ISLAND SUCCESS. I am enclosing money order for which kindly send me enclosed supplies. If this money order does not cover cost do not delay the grain but send me bill for extra. My birds are all doing finely.—B. O., Rhode Island.

THIS IS THE KIND OF PLAIN TALK ONE LIKES TO HEAR. I am finding out for myself if there was money in squabs and I have found it to be true by other squab breeders. I was to a man's place this afternoon and he said he had no trouble in selling his squabs for a good price. I guess the only trouble is people are sleeping half the time. That's why they don't know much about squab breeding. If a fellow doesn't believe in squab breeding, all he has to do is to open his eyes and look around. I've been to a couple of bird shows and have seen nothing to go ahead of your birds yet. My friend was saying what nice birds they had at the show, and I thought I would go down with him. We had to pay 25 cents to get in. After we looked at the birds, he said that mine would get the first prize if I would take them down. Then I found out that I have some of the biggest birds

in town. I would like to get some pictures taken and show you some of the birds I got from yours. I found your book to be a book anybody can read and knows what he is reading about. Everything is so plain—what a beginner wants to know about breeding birds. I was thinking of sending you my third order. If I do, it will be next week. Hoping you are doing a good business. My birds are doing fine. Your birds are the best breeders and I won't take any others.—S. C. H., Wisconsin.

NEST BOWLS ALL RIGHT. Please find a money order for one dozen more of your nest bowls. They are O. K. Put them in the house one evening and on going in the next found that a pair had already taken possession and started a nest. Have 11 pair setting on eggs and they are doing fine. I intend to purchase more from you later as I am going to build a unit to start this spring and enclose money for your plans for squab houses. Wishing you every success.—W. A., Massachusetts.

ENLARGING. Enclosed find check for which please send me seven pairs of your Extra Homers and one dozen fibre nests. Send by American express. This time I would like to have different colored birds. The birds and supplies you sent me in January came in good shape. I was well pleased with same. Am thinking some of putting in 50 or 100 pairs more this summer if I can arrange for another house.—H. B., Indiana.

BEST EVER SEEN IN OKLAHOMA. Enclosed please find money order for which send me your best Extra Homers as specified. Send all blue-speckled birds, as shown on right of special offer sheet. Your last shipment of birds are fine ones and every one that has seen them say they are the finest they ever saw. Trusting these will be the same or better and that I may receive them at your earliest convenience.—W. H., Oklahoma.

BUYING MORE AFTER ONE YEAR'S EXPERIENCE. A little over a year ago, I bought 24 pairs of your pigeons. Now I wish to buy 300 pairs of your Extra Plymouth Rock Homers and am fixing a house for them and will be in shape to receive 75 pairs a month, say March 1, April 1, May 1 and June 1. I see that \$1.70 per pair is your price in lots of 300 pairs and upwards. I should want the best birds as I believe they are the cheapest. Now if this arrangement is all right, you can let me know and I will send you \$127.50 for the first 75 pairs. I want your best birds.—E. F., Ohio.

Is there anybody in your town who has failed at squab raising? Some play at pigeons as they would with a new toy, then give them up. If they bought of us the trouble is with them and not with the pigeons.

APPENDIX D

(Copyright, 1908, by Elmer C. Rice)

Squab market prospects for 1908 and 1909 are excellent, as encouraging as they ever have been — always a hungry demand.

To keep the subject up to date we give on the following pages a fresh lot of facts bearing on the industry.

We have pictures mostly contributed by customers to whom we have sold breeding stock.

During the past ten years the demand for squabs has more than kept pace with the supply and this is true today (**January, 1908**) although the supply has been systemized by us and enormously increased, for in this period we have sold over half a million Homers, and we estimate that now there are breeding on the Western Continent, from these **Plymouth Rock Homers**, at least **two million pairs** of Homers. The squabs from these Homers bred from stock originally sold by us are in every market on this continent where poultry is sold.

These figures show what we have done for the squab industry, and they are conservative. In fact, before we began shipping breeding stock, the squab business was of no volume. Our methods and our birds have created this new vast industry. Our efforts, of course, would have been useless without the co-operation of a large and enthusiastic body of customers, whose loyalty is our pride and satisfaction.

Let the good work go on. More people are going to eat squabs. Squabs for dinner are now a settled habit with hundreds of thousands of families. Our advertising constantly in the best periodicals suggests every week to many new people that squabs are a new delicacy for their tables, and thus the demand grows.

We print on left-hand pages immediately following letters received in **December, 1907**, from three representative New York squab buyers, Messrs. **Silz, McLaughlin** and **Heineman**. We have selected these to show the present eager market for squabs bred from our birds. They were written by these dealers when prices for everything were temporarily set back by the short-term panic. Prices for squabs during **1908** and **1909** will be as high or higher than in any previous year.

We have selected these New York marketmen for reference because they have been largely instrumental in working with us to standardize and develop the national squab market. **Mr. McLaughlin's** system of grading by weight per dozen is now in common use not only in his own city but all over the United States. Refuse to ship your squabs to anybody who offers you a small price based on count. Grade your squabs by weight and get what you are entitled to for the big squabs bred from our birds. Weigh them yourself and you will know just what you will get from the dealer.

You will see in **Mr. Silz's** letter that he is pleased to get squabs from our birds because they are so much better. **Mr. McLaughlin** advises our breeders, and to keep free from other kinds. Messrs. **Heineman** advise the use of nothing but our best breed of birds. This is expert testimony by practical business men who control the squab trade in the largest city in America.

Knapp & Van Nostrand, 208 to 243 Washington street, New York City, write us under date of **December 4, 1907**, stating that they are paying the following prices for squabs. (This firm divides with the three others above mentioned the greater part of the enormous New York squab trade). "Ten to twelve pounds to the dozen, **\$4.50**; nine pounds to the dozen, **\$4.00**; eight pounds, **\$3.25**." Their letter continues: "We receive and sell hundreds of dozens every week. Squabs from shippers mentioning your company compare favorably with general receipts. Sales have increased in New York."

When customers of ours wish to begin shipping squabs to the four firms above mentioned, or any other New York squab dealer, we give letters of introduction which will smooth the way for them.

No matter in what part of the United States or Canada you live, we will put you in touch with your nearest best squab buyer, provided of course you have not a private trade of your own, which always pays best. In **Pittsburg**, for example, there is a concern which has a very large trade and is constantly after good squabs. They write us: "For eight-pound squabs we are paying **\$3.00 a dozen, nine-pound \$4.25 a dozen**. When communicating with your customers, kindly let them quote us price on the different sizes. We would like to get in touch with some shippers who can supply us the year around with what squabs we want. We can use 100 pounds to 150 pounds per week. Kindly put us in touch with some good shippers."

A correspondent living in West 36th street, New York, writes us under date of October 12, 1907, after personal investigation of the New York City markets: "I am studying up the squab business, with the intention of going at it up at my home in Pennsylvania, when I can conveniently see my way to it. Your statement about the market for the product in **1902-1903 still seems to hold good here in New York**. I was down at Washington Market not long ago to inquire of commission men how the call for squabs runs. **They all said that the supply hardly equals the demand**. Many of them were selling or offering for sale little bony, discolored carcasses that would hardly tempt a starved cat. So when I am ready I shall talk business with you."

In the first part of our **Manual** we quote prices in a great many cities in force in 1903 or thereabouts. We have not the space to follow the quotations in these cities year by year. What is true of New York is true of Chicago, St. Louis, Philadelphia, New Orleans, San Francisco, Seattle, Portland, all the large places. The demand everywhere continues eager at high prices as you can readily find out for yourself if you live near a city. In your nearest city you will find **Plymouth Rock squabs** going in regularly to the dealers there and dominating the market.

We quote as follows the prices prevailing in New York City from the summer of 1907 to the end of the year. These quotations are not retail prices, remember, but are what a dealer paid breeders for supplying him with squabs. The first quotation in each case, is for squabs weighing **ten pounds to the dozen**. The second figure is for squabs weighing **nine pounds to the dozen**. The third figure is for squabs weighing **eight pounds to the dozen**:

July	1\$4.50	\$4.00	\$3.20
July	224.40	3.75	3.15
August	124.20	3.50	3.00
September	24.25	3.50	2.75
September	304.50	3.75	3.00
October	144.75	3.85	3.25
November	45.00	4.00	3.50
November	184.75	4.00	3.50
December	24.40	3.60	3.25
December	94.20	3.40	3.25

The reader of all the quotations we print must be **impressed** that the chorus for the **big squabs** grows each year larger in volume and more insistent. **Dealers want the big ones** and to get them they offer the very attractive bait of substantially-increased prices. It is folly for anybody to start breeding squabs now with inferior birds, for his squabs (weighing six or seven pounds to the dozen) will be crowded to the back of the counter in every market and the breeder will have to be content with a price which will pay for the grain, perhaps, but little more. This is not unsupported talk by us, unfounded sayso, but, in the words of our ex-President, **is a condition and not a theory**. We have actually supplied the breeding stock whose squabs now constitute the squab markets of the country and are making the weights and prices. Before we introduced the **Plymouth Rock Extra Homers**, there were in the New York or Philadelphia, or any markets, no squabs weighing over **eight pounds to the dozen**. No such squabs were traded in because no such squabs existed, in commercial quantity. Now they are in the markets every day by thousands of dozens weighing from **eight to twelve pounds to the dozen**.

The letters which we print on the following pages are selections from a large number received by us in 1907. These show a great many facts bearing upon all sides of the industry and we recommend their reading for the news they contain. Many of the writers note ways of their own showing original thinking and adaptation. We withhold the names and addresses of the writers for the business reasons stated so many times by us, but we assure new friends as well as old, that all are genuine, every one, written by real customers not connected with us in any way except by the sale of our birds and supplies to them. The original letters are filed at our office in Boston, where we will show them to anybody. If some one is holding back an order from us thinking that any letter here is "made up," and cannot come in person to Boston to see these letters, as many do, we will pay the fee of his representative living in or near Boston for examining our files and reporting. Write us first, and we will convince you if given the opportunity.

READ THIS STORY OF SUCCESS BY A MAN 80 YEARS OLD. HE HAS DONE SOME ORIGINAL AND EFFECTIVE THINKING. NO BUILDINGS FOR HIM. HE USES AN ATTIC ROOM AND GETS THERE." Being old (80 years), failing sight drove me out of a mechanical business and the prospect before me was to live and lean on my children. I had always been a lover and keeper of pigeons from boyhood until a few years since when the telephone, etc. came, and I killed all off. My daughter saw your advertisement in a magazine and sent for your booklet. I saw at a glance the chance offered. I knew you were telling only what was the exact truth about pigeons, and the pictures showed them to be the best kind for the purpose. Had I been 20 years younger, I would have gone into it with all my means, so as it was I made a very modest beginning.

In February, April and June you sent me three small lots, 40 in all, not your Extras. I put them in an attic where I had birds before with nest boxes, some hung up, some on the floor, any way to keep them apart. They soon began to work. Six pairs had eggs in a week. When squabs began to come six, seven or eight at a time, a butcher took them, and since then we have given him over three dozen in one week. He first paid at rate of \$3 per dozen and has risen twice since to now, \$3.75, and has not been pushed. My daughter takes them in and gets the cash as if they were gold or wheat. The butcher says it is not the size but a plump breast that tells, so they go large and small many times, between seven and eight pounds to the dozen, bled and dressed. Of course my stock has been increased by some getting out of nest, or saving some peculiar color. I keep those with odd markings and know them personally.

The first year the 18 pairs averaged eight pairs each. I do not keep them to be a month old as they would all be on the floor then and butcher looks for wool on head. Seeing none he says: "How long has this been flying?" So I send them at 24 or 25 days. The younger they go, the faster the old ones breed, as well as saving of feed. So since May, 1905, when I began with 18 pairs, I have sold 805 squabs and increased stock from 18 pairs to 56 pairs, and no stint of feed. I sell no manure.

You are right on feed question. Cabbage is good. I give (when I have it) lettuce, parsley and even marshmallow weed and sunflower seeds, but my birds avoid wheat, eating very little. They know me personally, come in from outside when I go in and get down under my feet.

My attic where I breed is a queer shape, with two places for them to get outside, and feed boxes on floor to give them a chance to hide from the others at times. The other 20 pairs are in an old wagon-house with the boxes over head to be away from rats, and a cat there most of the time. I suffer some from the makeshift pens I have. I need the arrangement you have, though I have a third place for the young unmated. When a pair in that place gets young, say 14 days old, I move pair (box and all) at night into one of the regular units and that fetches them.

But here comes what few and those only that know me will believe. In the course of this April and May seven pairs have had three eggs each. Three pairs hatched all and are gone to butcher. Two more are hatched and doing well and of the two to come, all eggs are good. Some have had one smaller than other two, then I take the small one and give it to another which has younger or some of same size. I am raising them all. The books say pigeons often have only one, but nothing about three. Are we getting a new breed? I have none for sale alive so this is no advertisement.

For squabs I have received in money just double what I spend for feed.—D. G. L., New York.

Note. There is a great deal of sound sense and experience in the above story of this valued customer, written by himself. Eighty years old, and with failing sight! Not much; he is young and keen. First, he had confidence that he was being told the truth by us and would get good birds, for he had known pigeons all his life. That is half the battle. He sold his squabs when they were plump, even if only three weeks old, before they had a chance to walk around and train off fat. He treated his birds so that they loved him.

His butcher had customers which evidently did not weigh the squabs. A small plump squab is good but a big, plump squab is what 99 dealers out of 100 are after, because they get much more money for them. The educated markets once supplied with the big ones do not fancy the smaller ones. Our customer if he had started with our Extras would not have been content to sell to the butcher, but would have looked up the butcher's customers and received also the 50 per cent profit made by the butcher.

As to three squabs in a nest, this comes to pass, but we never knew so many cases in a flock of this size at the same time. That was extraordinary.

His practice of changing the smaller squab in a nest for a squab of size equal to the one remaining is common. With two squabs in the nest, if one grows larger than the other, this means he is stronger and is continually stealing the share of the parents' food belonging to the little one. Take the little one to another nest where there is a squab of its own size, bringing back a larger squab equal in size to the one in the first nest.

His story of success is that of a small flock. He simply makes a small lot, housed in a crude way, pay in profits a share of the running expenses of the home.

LETTERS RECEIVED FROM CUSTOMERS BY PLYMOUTH ROCK SQUAB COMPANY



Mr. Elmer C. Rice,
Plymouth Rock Squab Co.,
Boston, Mass.

Dear Sir:-

In reply to your letter of Nov. 27th, the present prices on Squabs you will find on the enclosed card.

There will not be any let-up in the demand for Squabs if the prices remain normal. The season for all game closes with the end of this month so there will naturally be a better demand for Squabs after that time to take the place of game. We use from 175 dozen to 200 dozen squabs each day.

Your Squabs are very much better than others, and I think you have accomplished wonders for the Squab industry, and every Squab raiser should feel grateful for your efforts in this line, and you could very appropriately be termed "KING" of the Squab business.

Wishing to assist you in your continued efforts to put the Squab business ahead, we are,

Very truly yours,

A. SILZ, Inc.,

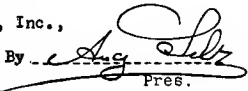
By  Pres.

M/E...

THIS IS THE BREEDER OF WHOM WE WRITE AT THE BOTTOM OF PAGE 56 OF OUR MANUAL. HE FED WRONGLY AT THE START AND BLAMED US FOR NO RESULTS, BUT HE IS A GOOD FRIEND NOW AND HAS SEEN A GREAT LIGHT. I received the new Manual O.K. Accept my thanks. I think that it is up-to-date in every respect and in no way far-fetched, nothing but sensible, hard, experienced facts. I notice that you speak of a California breeder using nothing but wheat and a handful of hemp with no return for six months. I presume it was me you refer to. Well, I deserve it, for "a guilty conscience needs no accuser." I did not feed them enough to keep them alive.

Now, Mr. Rice, money will not buy the birds. They are beauties, so plump, bright and active; working all the time. Even now (September 11, 1907) they are in full force nest building. I can point out lot of pairs which are now on their eighth lots of eggs. I would like to have any one show me that they have as good birds as I have. It would be a very hard matter to convince me that there are any birds as good as the Plymouth Rock Homers of Boston. In short, any one who fails with those birds should not blame the birds or Mr. Rice, for it is up to them to handle them right. Do not think, Mr. Rice, that I am "fishing" for something. Far from it. I am only speaking as my true conscience dictates, that there are no better birds than yours. We have just weighed six squabs and they tipped the scales at five pounds, 13 ounces. How is that? Some will say that Homers cannot do as well as that but I can show the goods. The only trouble is the best I can get is \$3 a dozen and a private trade at that. Have not had a chance to save over one dozen for breeders.

As regards more birds. I certainly want more of your birds and will want only Extras, as I will use the Extras exclusively for raising my breeding stock. I will not be ready until spring for them, as I am going to build four more houses. Then I promise you a picture of my house worthy to go in your book. All I ask of you is to wait until I have completed my plans.

Mr. Rice, I have some Maltese hen pigeons I wish to dispose of. There are about 20. Three are mated pairs and the rest young ones ranging from two months to seven months. If you could trade me your Homers for them, or find me a customer I should thank you. I have only kept them for fancy. Now I will close, wishing you the best of luck.—J. B. W., California.

GOVERNMENT OFFICIAL IN CALIFORNIA WELL PLEASED. The four pairs of Homers shipped to me on October 2, 1907, arrived to-day in apparently first-class condition. The birds appear to be satisfactory in every respect. I thank you for the extra pair; also for the supplies included. After the birds get to work I shall furnish you with a further report, and if I have occasion to order again, shall not forget your prompt and liberal treatment.—C. W. L., Register, United States Land Office, Department of the Interior, California.

BETTER AT \$1.50 A PAIR THAN WHAT HE PAID OTHERS \$2.50 A PAIR. SIX MORE ORDERS FOLLOW. I have received your Plymouth Rock pigeons which you sent me in perfect order. I am very much pleased with them. They are as good as the ones I bought of ——— for \$2.50 per pair.—P. P., New York.

Note. The above customer has sent us in 1907 up to date (November) six orders.

ONE HUNDRED MILES IN FIVE HOURS IN A STORM. Please send me one of your 1907 catalogues. The birds that I received in April, 1906, are doing finely. I broke them in at my loft. I flew one of them 100 miles, making the distance in five hours, in rain and storms. I will ship him 200 miles in a few weeks with others of my birds. I think he will do fine in his 200-mile race.—J. M., Texas.

SATISFIED AND BUYS MORE. Some time ago I ordered a half-dozen pairs of pigeons from you; at the same time I ordered six pairs from the———. I wish to say that I have now received all the birds and I have concluded that yours are the best. As soon as I get a little more ready money I expect to order more birds of you. It is my intention to build up a large flock just as soon as I can. I am perfectly satisfied in my dealing with you. You can publish any part of the above letter if you want to except the name of the other company.

(Later). Enclosed find check for \$18 for three pairs of your Carneaux.—L. T. P., New York.

FIVE PAIRS OUT OF SIX IN TWO WEEKS AFTER ARRIVAL PROVES FAST MATINGS.

Received pigeons two weeks ago. I think the Extras are far ahead of anything I have ever seen. I have had mine only two weeks and five pairs have already gone to work.

Enclosed please find stamps for 37 cents for which send me by mail two feet of aluminum tubing.—T. J. S., Iowa.

BREEDING WELL IN TEXAS. I am doing fine with my pigeons and I think they are the best kind. I started with 14 in November and now (June, 1907), I have about 66. They are doing fine. I have so many that I will have to order some wood-fibre nestbowls. Find enclosed \$3.84 for which send me four dozen wood-fibre nestbowls.—W. P. C., Texas.

Wm. R. McLaughlin
COMMISSION MERCHANT
Poultry, Eggs, Game, Squabs, Calves Etc.
362 GREENWICH STREET

NEW YORK November 29, 1907

Elmer C. Rice, Esq.,
Treasurer Plymouth Rock Squab Co.,
Boston, Mass.

Dear Sir:

Yours of the 27th duly received. I am pleased to hear from you once more. If beginners will stick to your breeders, they will have no cause to complain as to size, quantity and quality of squabs, and net profits they receive from same.

The demand is still good for all the fancy white large squabs we can get, and the market has kept at uniform price for a long time. In fact, since the new season started, there has been very little change in price.

The small and mixed lots we must sell to out of town trade where everything looking like a squab goes at a price; while the city trade want the larger bird and are willing to pay for them.

Many do not buy enough breeders at the start so that they can ship a fair sized lot.

I can use daily all the squabs I can get and do not look for prices to go any lower during the winter,--if anything, quite some advance.

I think if any two need any praising as to results brought about, and profits to raisers, it is you and myself, as I was the first to introduce selling by weight according to size, and was laughed at for trying, even by those who would not now admit the change more than doubled their output. The one who does not like the change is the speculator who got the large birds for nothing, and the small birds at their actual value, and made the extra profit when selling to consumers.

I would advise beginners to get a quantity of your breeders; keep free from other kinds. They will have no cause to find fault with results, and will always have a market and demand at good prices, for they can raise and ship at any time of the year. Send me the names of your customers yourself and I will post them as to the market, and send shipping cards.

Yours truly,

W. R. McLaughlin

STARTED WITH 12 PAIRS AND BRED THEM TO 100 PAIRS. ENLARGING BUILDINGS STEADILY. HAS COMPARED PLYMOUTH ROCKS WITH MANY AND FOUND NONE SUPERIOR. Your letter of October 24, 1907, received, and wish to thank you for the information furnished. Two years ago I built a pigeon house ten feet by 20 feet, nine feet high with a 20-foot fly, dividing the house and fly with wire screen, making two compartments. I purchased six pairs of your Homers in September and six pairs more of you in February. To my surprise, three of these pairs started building their nests the day after their arrival, and, in fact, the 12 pairs went into the business of raising squabs and have been in the business ever since. I now have 100 pairs of the finest birds in the country; no question about that, as I have made it a point to visit quite a number of places to compare birds, and I am satisfied with my birds, if they are with theirs.

Last winter I built another house of the same dimensions as given above, building at the lower end of the original fly. I took the wire screen from the end of the fly, and with it divided the fly into four parts, thus saving the expense of building a fly for the new house, and the birds do just as well with a ten-foot as with a 20-foot fly, I imagine. The total cost of the two houses and birds was about \$175.

It is my intention to sell squabs this winter (1907-1908) while prices are high, keeping the squabs hatched during the summer months for breeders, and saving the squabs from my best record birds as breeders, as I believe I will get even better results from them.

In my opinion the squab business is similar to other business enterprises, requiring patience and hard work at the start, and if a man is a "quitter" he will make no more money in the squab business than in any other line.

I started in the business for the reason that I think there is good money in it. My "feathered race-horses" look good to me, and I am placing my money so that they come under the wire winners.

My advice to one starting in the squab business is to secure your birds and your Manual and then they will have started right. Will try and send you a picture of my place in the near future.—F. B., New York.

MAKES HIS HOBBY PAY WITH TEN-POUND SQUABS. My success with your birds is the result of following the instructions in your Manual. When I enter my squab-house, I always whistle so as not to frighten them too suddenly, and do not often take strangers into the loft. Am not troubled with lice. I disinfect about every two weeks.

My squabs will weigh one pound apiece, or from 10 to 12 pounds to the dozen. Of course, I do not ever expect to be an extensive breeder, as I have not the room, but I can accommodate about 75 pairs, and make a little money on the side, and enjoy taking care of them. Pigeon keeping was always my hobby ever since I was ten years old. I will say a good word for you and your birds at any time.—D. E. A., Illinois.

SMALL ORDER JUSTIFIES A LARGER ONE. The 13 pairs birds that you shipped to me in May have done so well that I feel justified in ordering four dozen more of your Extra Homers and 17 1-3 dozen nestbowls for which I enclose check. Your birds have been here nine weeks last Saturday and I now have twenty-five squabs, one having died.—F. M. J., New York.

INTEREST SHOWN IN WELFARE OF CUSTOMERS. I am very much obliged for the information given me. Once again, I cannot too highly praise you for your promptness and interest shown in the welfare of your customers. I intend ordering some more birds from you and would like to know the best time to get them.—M. A. C., New York.

BETTER THAN ANY OTHER ST. LOUIS FLOCKS. I take this means to show you that I appreciate a fair, square deal such as you gave me. The birds are as you advertised them and are far superior in some respects to what you advertised. They are perfect pets and to my surprise they began building nests the second day after their arrival.

They are far superior to any flocks which I have seen in St. Louis and as soon as I can find a suitable site will erect some modern buildings according to your Manual and stock it with your birds. It will take several months to carry out my plans.—W. E. P., Missouri.

FOURTEEN-FOLD INCREASE IN ONE YEAR IN NEBRASKA. About a year ago my father, who lives in Crete, Nebraska, purchased ten pairs Extra Plymouth Rock pigeons from you. They have increased to over twelve dozen pairs. I wish to get the whole flock if it is practical to ship them here, so I am writing to you for advice on the subject. Can you furnish shipping crates?—C. B., Vermont.

HAS KEPT PIGEONS BEFORE AND KNOWS A GOOD LOT. The pigeons you shipped me arrived all right on Friday morning. I notice the pairs were broken up (from the separation, I suppose) for four days, but they are now mating again. As I have kept pigeons before, I know a little about them. This is a good lot of pigeons and I thank you for your promptness in shipping.—J. R. S., Maryland.

Telephone Call, 8261 Cortlandt.

Heineman & Co.,

COMMISSION MERCHANTS.

Fruits, Produce and Poultry,

Southern Vegetables a Specialty.

273 & 275 WASHINGTON STREET.

New York, December 4, 1907

Mr. Elmer C. Rice,
Plymouth Rock Squab Co.,
Boston, Mass.

Dear Sir,

We wish to advise you on prices and general run of squabs which a goodly number of breeders of your fancy Homer pigeons are shipping us. They are now selling from between \$3.75 to \$4.50 per dozen and, in all probability will go higher, as the winter advances. There is a good demand for this kind of birds and we are receiving quite a deal of them. We can handle anywhere from one thousand to two thousand dozen a week as our trade constantly inquires for them. We can assure you that the breed of birds we get from our shippers are very fine and we notice a large majority of these same shippers mention your name.

The market at present wants squabs weighing between 9 and 11 lbs. to the dozen, and we would advise any beginner to use nothing but your best breed of birds, as they are the cheapest in the end to him.

We thank you for your kind consideration and past favors. We are

Very truly yours,

Heineman & Co.

HOW TO PRESERVE, COLLECT, BAG AND SELL THE MANURE. HOW TO USE TOBACCO DUST FOR BOTH PIGEONS AND POULTRY. I have several hundred Homer pigeons raised entirely from stock purchased of you a little more than three years ago. I wish to write you to obtain information in regard to selling the manure. I have your **National Standard Squab Book** in which you say you ship to the tannery and obtain **60 cents a bushel**. I would like to know how you ship it. In bags or barrels? The manure has always been used on our farm, but I have recently been deprived of my husband and need the money very much, and as I cannot do the farming that he has done, feel obliged to sell the manure. It is free from sand or sawdust. The most foreign substance will be feathers and some little nesting material that they have scattered around, as of course I should not try to sell the old nests that would be nearly all nesting material. The packing will have to be done by my daughter and myself. I have been told that it is bought by the bushel, but it would be a hard task to measure it all, as I am considerably over 60 years of age and very lame. I find the freight will be 21 cents per 100 from here and if I ship by weight it will be easier to measure it all by the bushel and they would have to take the freight agent's figures instead of my measure. I have quite a quantity. Have measured up one bushel and found the weight 36 pounds, which at that rate would take only three bushels to weigh a little more than 100 pounds and I think I have 30 bushels or more.—Mrs. M. W., Rhode Island.

Answer. Feathers and common nesting material in the manure will not hurt it any in the estimation of the tanners, but they like it free from gravel and from tobacco stems. The stems will discolor the hides in the vats. The manure varies in weight according to the amount of moisture in it. It should be dried and then bagged, two bushels to a bag. Buy a bushel measure and use it. Always ship in bags and get the bags back empty. They are worth at least five cents apiece even if second hand, as burlap has gone up.

Squab raisers who use tobacco stems for nesting material cannot sell the manure to tanneries. The only reason for using tobacco stems is to ward off possible lice. The same result may be attained when straw or pine needles are used by dusting the nests now and then with tobacco dust. We sell tobacco dust for 11 cents a pound. It is equally good for poultry and is better than many fancy lice powders selling for two or three times that price. We will supply **25 pounds of tobacco powder for \$2**. In smaller quantities 11 cents a pound. The use of this powder will not injure the manure for tanneries.

SOME AGREEABLE DISAPPOINTMENTS

I have not written you since receipt of birds, consequently will send you a word at this time. My first agreeable disappointment was the **promptness** with which you filled my order. I live 500 miles from Boston. I mailed my order for the pigeons at eight o'clock Wednesday morning and at five o'clock Friday evening the birds were waiting for me at the express office, just about 53 hours from the time I mailed my order until shipment was received. I had not expected to receive the shipment before eight days. The birds reached me in first-class condition—except for a few broken tail feathers you would have thought they had never been out of their native loft. They lost very little time in getting climated, for three days after turning them loose they were nesting and soon all were hatching.

In comparison with other Homers I have seen, everything is in favor of the **Plymouth Rock** breed. They are cleaner, better proportioned and less shy than any others I have seen. The squabs from these birds are everything an epicure could desire, big, fleshy and meat the whitest. I have only words of commendation for the stock of breeders you handle. I can only wish you increased sales of your excellent money makers. You are at liberty to use this letter to interest prospective customers or my name as a reference.—P. F., Pennsylvania.

TEN PAIRS OUT OF THIRTEEN SPLENDID PAIRS QUICKLY AT WORK. Our cheese maker at Aldenville, Penn., ordered thirteen pairs of Homers from you. We have encouraged his going into the business for the reason that several months of the year they are not busy at the trade and could just as well care for a nice flock of Homers.

The thirteen pairs received from you a few weeks ago are splendid specimens and ten pairs are at work at present. Not being contented, we wanted to mix the blood and ordered thirteen pairs from an imitation squab company. The birds came yesterday and we are so badly disappointed in them that we would like very much to return them, and not mix with our high-class birds received from you. We want eventually to put in a few hundred pairs of the party and will want from twenty to twenty-five pairs of your selected birds in a few weeks time. What will be the price and can you give us a fine lot?—G. S., Pennsylvania.

RAPID BREEDING IN MICHIGAN. I purchased of you last year three pairs **Extra Plymouth Rock Homers** and at this writing I have had them just one year and seven days and instead of having three pairs I now have **24 pairs that can fly besides a dozen squabs and as many eggs**. What do you think about that? As I am in need of nestbowls, please send me three dozen of your wood fibre nest bowls.—R. E. F., Michigan.

LETTERS RECEIVED FROM CUSTOMERS BY PLYMOUTH ROCK SQUAB COMPANY

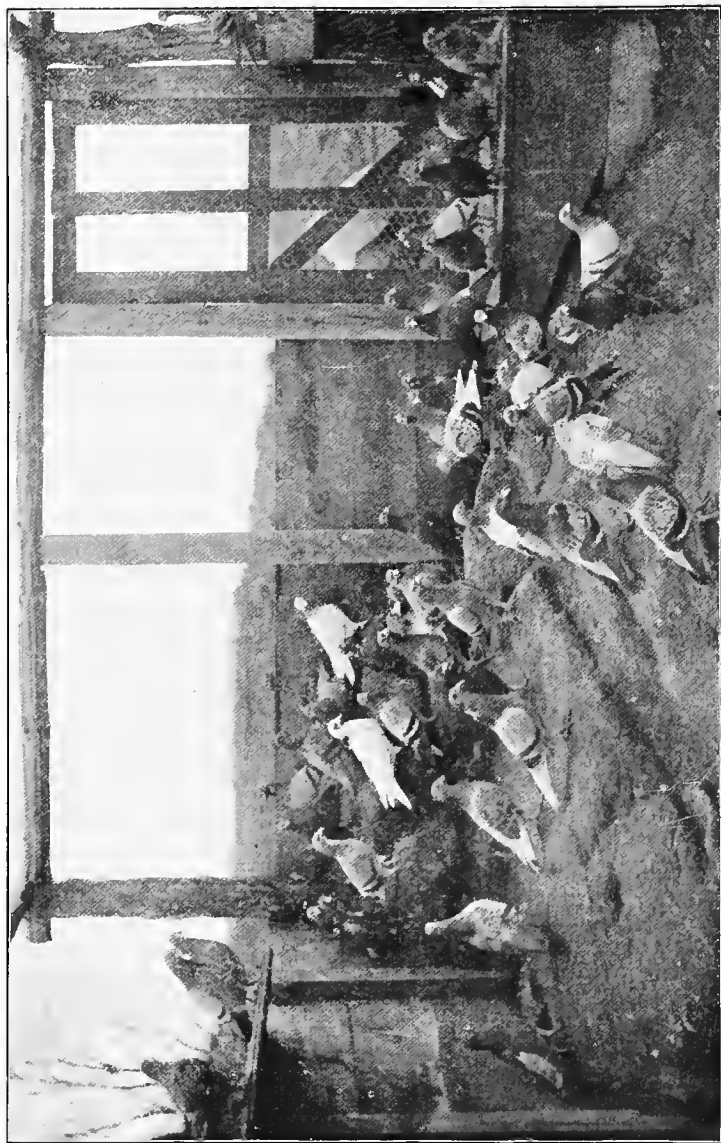

EXTRA PLYMOUTH ROCK HOMERS.

The extraordinary size and beauty of our strain are well shown in this picture. All the colors of these magnificent birds are here: blue bars, blue checkers, red checkers, silvers, blacks, splashes. These are the birds that bring out the beauty expressions of wonderment and pleasure printed in the letters on these pages.

HIS FRIEND PURCHASED 12 PAIRS OF US THREE YEARS AGO, IS NOW SHIPPING SQUABS FROM 300 PAIRS AND CLEARED \$1000 LAST YEAR, A HIRED MAN DOING THE WORK. You have been recommended to me by a friend who three years ago purchased 12 pairs of Homers from you and he has to-day 300 pairs and cleared \$1000 last year without any labor on his part. He simply instructed a common laborer.

I am very much interested in squab raising. I am now attending the Iowa State College of Agriculture and Mechanic Arts. I live in Chicago and it seems to me that would be a good market. The first six months I intend to raise for breeding purposes, and then if I succeed can put \$200 or \$300 more in squab raising. Do you consider this plan practical as I have outlined it?—G. C., Iowa.

Answer. Remarkable successes are being made by customers of ours who started with 12 pairs to 50 pairs and raised up their own birds. It is not wise, however, to start with less than 12 pairs of birds, unless your stock of patience is large and you can stand waiting for two or three years before getting returns for your money. The trouble with beginners who have failed is that they have tried to do too much too fast.

RATS AND DIARRHOEA. As I am sure you are very good authority on the pigeon question, being first in the business and revolutionizing it, I hope you will not count it amiss or intruding for me to appeal to you (to use court language) for help and advice. We have lots of mice in our pigeon house. What could one use or do to kill or frighten them away with perfect safety? The second troublesome thing is what I call the shivers. The pigeons get to shaking violently and seem to lose nearly all interest in everything.

Your birds beat anything we have from elsewhere at most every "turn." I might say. Indeed, some we have from another near by who gave us a written guarantee "for health, good workers, heavy squabs, no canker and all mated birds," proved in nearly every instance a sham, for they were not even mated except a few pairs, out of a hundred pairs, and died right along, and they were not mated for over a year after they came.

Yours are tame also, they will eat out of our hands. I think those broad-shouldered, thick-legged blue (with black broad bars over wings) are very good ones. We raised some nice breeders from them. A friend of ours at Marlton, New Jersey, spoke of getting nice birds of you. I have made interesting visits among the pigeon keepers in New Jersey.—Miss M. H. B., Pennsylvania.

Answer. Rats and mice, as we have explained so many times, must be kept out by elevating the building. If it is impossible to do this, take one-inch mesh wire netting and bury it completely in the dirt floor, six inches deep. At the sides and corners bring it up above the sills of the building and fasten it with staples. This will give you a wire-netting carpet for your squab house (buried six inches under the ground), and through this barrier it is impossible for rats or mice to get. It is a hard task to exterminate them by poison or traps after they have once got in to an improperly-arranged place, and if you succeed they are bound to come again. Do it right by elevating your building or burying wire netting and that will end the bother.

What this customer calls the shivers is diarrhoea caused by feeding too much wheat.

TWO PAIRS ONLY. I am going into the squab industry in a very small way to raise a few birds for our own use and find a pleasurable occupation as an aside. I shall later want a few pairs of your birds. I bought some time ago ten pairs of another company, but so far am sure of only two pairs in the lot and they have given me no little trouble.—Rev. G. B. L., Vermont.

NINE AND ONE-HALF POUNDS TO THE DOZEN AND SOLD FOR FOUR DOLLARS. Will you kindly inform me to whom to write about disposing of pigeon droppings. I made the first sale of squabs last week. They weighed nine and one-half pounds to the dozen, plucked, bled, empty crops. I received four dollars for them. How is that?—F. H. S., Ohio.

GENERAL VERDICT. Please send me addresses of New York squab dealers. I received the three pairs of Extra Plymouths; all were in fine condition. My friends all say they never saw a nicer lot of Homers. I also thank you for the prompt shipment. I expect to send for another lot in about a month.—J. B. S., Pennsylvania.

SQUABS TWO WEEKS OLD WEIGHING THREE-QUARTERS OF A POUND IN COLORADO. Birds ordered of you some days ago reached me in pretty fair shape, with the exception of one male dead. Thank you for your splendid treatment to my order. Squabs from the first lot at two weeks weighed three-quarters of a pound. How is that? Will return baskets in a few days.—J. F. B., Colorado.

BEST BOOK ON BIRDS HE EVER READ. I received your Manual and find it just what you say. It is the best book on birds I ever read. I have a large plant of common pigeons but since I read your book I have built one of the prettiest pigeon houses and flying pens in which to put the pigeons I am ordering of you to-day. If your birds are as fine as you say I will get rid of all my common pigeons.—C. E. G., North Carolina.

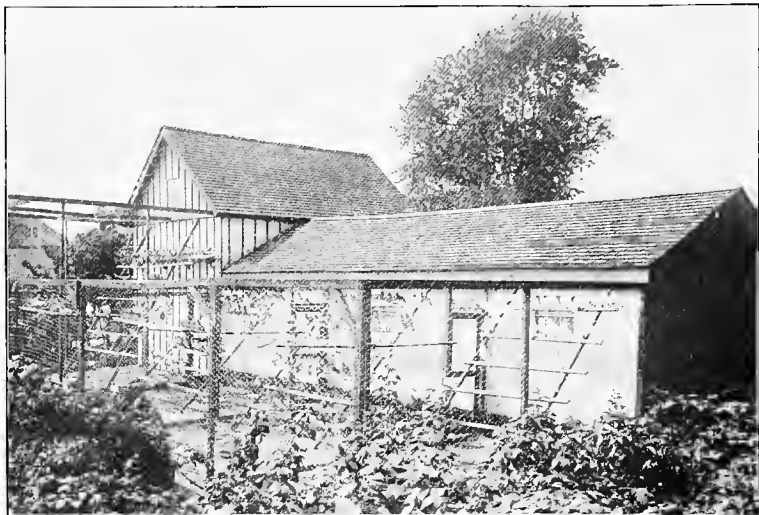

A GOOD-LOOKING ILLINOIS PLANT.

These are two of the buildings of the breeder whose letter is printed on this page. Notice his handsome white Homers.

LOST MONEY BY NOT KNOWING PLYMOUTH ROCK HOMERS. NOW HE IS ON THE RIGHT TRACK. HE IS A TRAVELING SALESMAN AND HIS DAUGHTER DOES MOST OF THE WORK ON THIS BIG PLANT. SQUABS WEIGH 11 POUNDS TO THE DOZEN. I have just completed my new squab unit according to your plans. Please find enclosed Adams Express money order for birds to fill same.

Other parties have been working on me for this order and I told them I would buy nothing but Extra Plymouth Rocks. (A burnt child dreads the fire.) I lost enough by experimenting with cheap birds when I began. Since I began buying of you I have had no trouble. The last three shipments I received from you cannot be beat for size, beauty and breeding qualities. About one-third of all the squabs I have sold in the past 12 months have averaged a little over 11 pounds to the dozen. We have quite a lot of squabs that weighed a full sixteen ounces each.

Now, Mr. Rice, as long as you continue to ship me in the future as fine stock as you have in the past, I am with you and the Plymouth Rock Co., and "the other fellow" might just as well save his postage stamps and breath.

I have not lost a single old bird by death or disease in 14 months. We had three or four squabs picked badly. I found by taking the squabs away at three weeks of age and placing them in a small feeding pen and feeding hempseed for a week that they fatten awfully fast. What is your idea about that?

I hope you will excuse this long letter. Every time I think about my experience at the start with all kinds of mixed up birds, I have "brain storms" and you can rest assured my talk over the country will be for nothing but Plymouth Rock birds. As you know I am a traveling man and ought to be a good talker. Consequently in order to repay you for favors in the past I often tell my experiences and how I lost money by not knowing Elmer Rice.

My oldest daughter does all our feeding and taking care of our birds and she is getting to be an expert pigeon keeper and delights in the pastime. We are figuring on increasing our flocks just as fast as we can until we get 2000 pairs.—S. S. H., Illinois.

LETTERS FROM CUSTOMERS RECEIVED BY PLYMOUTH ROCK SQUAB COMPANY

POOR WHEAT SET HIM BACK. HE SELLS ALL HE RAISES, THE SQUABS BEING ENGAGED BY CUSTOMERS EVEN WHILE THEY ARE ON THE NEST. I write to you for information concerning my flock of birds. I got my stock from you in 1904, and have been building up my flock. I got along finely with them until the latter part of last summer when I had the bad luck to lose about 20 or 25 of the old birds, which broke the mated pairs up. I would like to increase my flock to the full capacity of the house built from your unit plan, 12 by 16. I lay the loss of my birds to some poor wheat I got from the mill here that must have contained a good deal of ergot that caused the females to die. I wrote to Mr. Rice at the time and he told me it was the wheat, at least I have had no more trouble since I commenced feeding first quality grain. The squabs weigh 12 to 14 pounds a dozen.

I herewith send an order for 12 females to balance my flock.

My original purchase of you in 1904 was six pairs Extra Plymouth Rocks. The birds arrived all safe and in good condition and attracted a good deal of attention at the time, for some of my friends put on a broad smile and have been expecting me to bust up in the pigeon business, but have been at it now for over two years and the order accompanying this don't look much like it for I can sell all the squabs I can raise. They are even engaged before they are fit to take off the nest. I get 50 cents a pair just killed, and if I dress them ready for the oven I get 75 cents a pair in the local market. My squabs will weigh 12 or 14 pounds per dozen, and think it is on account of the way I am handling and feeding, for I find you cannot make meat unless you feed for it.

I make my own grit of glass and it has been very satisfactory. I keep a couple of bricks of salt cat in the house, also a codfish occasionally, and they are doing fine now, if I did have some bad luck, but then one must expect drawbacks in any kind of business.—A. D. D., Pennsylvania.

Note. You will never have sickness of any kind with pigeons if you provide sound grain and clean water. If your grain dealer needs watching, and has not your interests at heart, examine especially the wheat and corn, tasting both. Some grain dealers will take whole corn which has germinated and make cracked corn of it. You can always tell sour grain by smell, taste and sight.

It is quite true, as this customer states, that feed is a factor in the weight of the squabs. Too much wheat keeps the old birds thin, and the squabs dark and thin. Plenty of corn and peas makes the squabs fat.

DISPOSING OF THE SQUABS IN SOUTH CAROLINA WHEN THEY REACH THE AGE OF 23 DAYS, RECEIVING THREE DOLLARS A DOZEN. Our order for 17 pairs of Extra Plymouth Rock Homers was placed with you early in March (1907) and the birds arrived and were placed in our pen about the 20th. They were all in good shape, having stood the transportation well, and made themselves entirely at home in their new quarters. The day following their arrival one of the hens laid, and from that time until now (June 24) the flock, as a whole, has worked splendidly, and results have far exceeded our expectations. At the present time 15 of the 17 pairs are at work, having either eggs or young squabs. We believe that every pair would have been at work, but two of our hens escaped, and we had to order two more to replace these, and this accident upset our flock considerably.

We find that the squabs will weigh from three-quarters to seven-eighths of a pound when they are three weeks and two or three days old, and we have been disposing of them at that age. No doubt, this fast growing is due to the equable climate which we have in South Carolina. We have no trouble in disposing of all our birds at that age at 25 cents apiece.

The pigeons do not require much of our time, and we are so thoroughly satisfied with our experience that we are considering ordering 20 more pairs in the next few days.—Mrs. C. B., South Carolina.

SQUABS WEIGHING FOURTEEN TO SIXTEEN OUNCES.

It is now July, 1907, six months since we purchased from you 44 pairs of your Extra Homers. Seven pairs met with accidents, because they were disturbed several times on account of the plant not being finished. The remaining 37 pairs are in every way satisfactory. We have at present 11 pairs on eggs and 21 squabs. On account of not having too much room for the birds and also to answer the many demands of our sick, we are killing the squabs at three to four weeks when we find them to weigh 14 to 16 ounces, and at which time the mature birds are again breeding.—S. E., Illinois.

RECEIVES \$4.20 A DOZEN. My squabs from your birds weigh when dressed nine pounds to the dozen and I receive at the rate of \$4.20 per dozen for them. I have fed corn, wheat, peas and millet, buckwheat and bread. I have had success by letting the squabs on the floor when they are four weeks old, that is, when I am going to keep them for breeders. They are not troubled by the other birds and they feed themselves sooner and the old birds get to work earlier. I have had no sickness or lice. Your Manual is all right and is good for the starter and experienced.—P. E. D., District of Columbia.

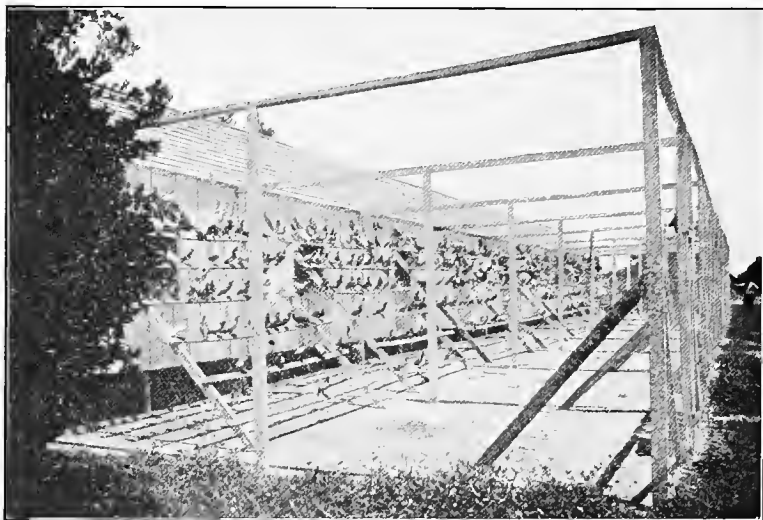

SHOWING CONSTRUCTION IN FLORIDA.

This building, part of the plant of a Florida customer, is built of only one thickness of lumber. Only the roof is shingled. No glass windows are needed. The climate of the South is exceptionally good for squab breeding.

SUCCESSFUL FLORIDA SQUAB FARMER SAYS THE CLIMATE OF HIS STATE CANNOT BE BEAT. LIKES THE CARNEAUX. The Carneaux arrived here yesterday. I am much pleased with them. They show more white than the birds which my mother sent me from France and are larger. The more I see of the Carneaux, the more I like them, and wish I had nothing but them in my squab farm. I believe there is going to be a tremendous run on them as breeders.

My Homers are mated and all hard at work. I was fool enough last spring of 1906 to band the mated birds of that season with colored bands, blue for cocks, red for hens. The bands I bought from ———, who guaranteed that they would last a lifetime. I note at least one-third have broken and come off. I shall have to reband 300 pairs over again. No more colored bands for me.

Enclosed find check, for which send as specified. You will be glad to hear that I am making a success of the squab business, and now have 700 mated pairs. As soon as the fall commences and the price of eight to nine pound squabs advances from its present low standing here, I am thinking of starting to ship to the New York markets. In this Southern climate our birds work better and faster, produce far better grade of squabs in the winter and spring months than in the summer; while I understand with you the summer is your best time. I believe our Florida climate cannot be beat for squab farming.

If I like and find out that the Carneaux is all it is cracked up to be, 50 per cent of my Homers will be replaced gradually by them.—W. B. W., Florida.

HEALTHY, RUGGED BIRDS. Enclosed please find draft for \$11.52 for one gross of your nappies. The birds I got of you last spring are all right. I have not lost a one with sickness or any other cause.—A. M. J., Iowa.

HIS FATHER IN IOWA LIKES THEM. My father at Des Moines, Iowa, is breeding your birds and likes them very much. Please send me present price on 10 and 20 pairs Homers. I want the best that I can get regardless of cost.—C. H. D., Illinois.

LETTERS FROM CUSTOMERS RECEIVED BY PLYMOUTH ROCK SQUAB COMPANY

KNOWS BY EXPERIENCE THERE IS MONEY IN PIGEONS. MANUAL "AWFUL GOOD." I trust you will pardon my tardiness in answering your letter with reference to the new **National Standard Squab Book**. Of course I want this book. I do not send for these books through any idle curiosity. **I have kept pigeons and I know there is money in them if they are properly looked after.** I want to get back in the pigeon business after the first of the year, and intend to do so, and **I want to start with the best birds I can get.** I think the **National Standard Squab Book** very fine. It is "awful good." More pleasure and satisfaction than I can express. Don't know of any improvements you could make, unless you went ahead and said the same thing over again. I enclose 20 cents in stamps for your new 1907-1908 **Manual**. I also send by this mail, under separate cover, the old **Manual**.

I intended to purchase some of your birds when I sent for your book, but conditions have been such that it has been impossible. Can't say exactly when, but will buy some of your birds soon.

The main reason I haven't bought some of your birds is because I haven't had any place to keep them. I have kept pigeons all my life, know a great deal about their habits, and above all, I am very fond of them. However, I had to dispose of all the birds I had about 18 months ago, and since that time I haven't had the room to keep them. I had to dispose of them on account of having to leave Atlanta. My lease on my present home runs out about January 10, 1908, at which time I expect to buy me a place with large premises, where I can keep pigeons, as I made a good deal of money on them during my school days, and believe I can do so now as a side line if nothing more.—M. R. L., Georgia.

PLEASED WITH YOUR BUSINESS METHODS AND BUYING STEADILY. I have never seen a more likely lot of pigeons, and as I have room enough for another 10 pairs, I enclose P. O. order and I hope that before the next batch arrives I shall be ready for fifty more pairs. I am very much pleased with the manner in which the **Plymouth Rock Squab Co.** does business.—R. W. J., Virginia.

MAKING THEM PAY AS HE GOES ALONG. I now have seventy. One year ago last March I bought six pairs from you. I want a better start before I sell very many, but I make them pay for their feed. Your **Manual** is "the goods."—D. E., Illinois.

HIS HOMERS LOOK LIKE PYGMIES ALONGSIDE PLYMOUTH ROCK EXTRAS. I have 60 Homers, but they look like pygmies alongside of your birds.—F. W. D.

OUR HOMERS MORE THAN WE CLAIM FOR THEM. Your Homers are more than you claim for them. At least mine are. They are models of beauty and are very large. I was skeptical at first, but I am thoroughly convinced that the Homer is the only bird. Some of my Homers are as large as the white Italian birds that I purchased from you. The squabs are fine large fellows and I am sure that a nice flock of Homers beats a **drove of chickens for meat**, either for home or market use. I shall take pleasure in recommending your birds to my friends and prospective buyers. Please find enclosed 50 cents for another **Manual**.—M. A., Kansas.



HOMER HEN SITTING ON EGGS.

PIGEONS CRAVE GREEN FOOD. I bought of you June 20, 1906, 24 pairs of your Homers. I have lost three birds, all of my raising, and now have 100 pairs (April, 1907). They all seem to crave something green to eat. What would you advise? Shall I feed them any green foods? I am giving them kaffir corn, a few peas, wheat and cracked corn.—F. M. P., Georgia.

Answer. Yes, throw some lettuce or any green leaves on to the squab-house floor occasionally, say twice a week, and let them peck away at them to suit themselves.

WISHES TO GET PIGEONS OF SUPERIOR QUALITY. You may hear from a gentleman, Mr. John Fyle. Send him some of your literature, as I will always recommend your stock to all who expect to go into the squab business. This Mr. Fyle has pigeons, but of an inferior quality, and having been told about mine, wants some like I have.—R. S., Maryland.

LETTERS FROM CUSTOMERS RECEIVED BY PLYMOUTH ROCK SQUAB COMPANY

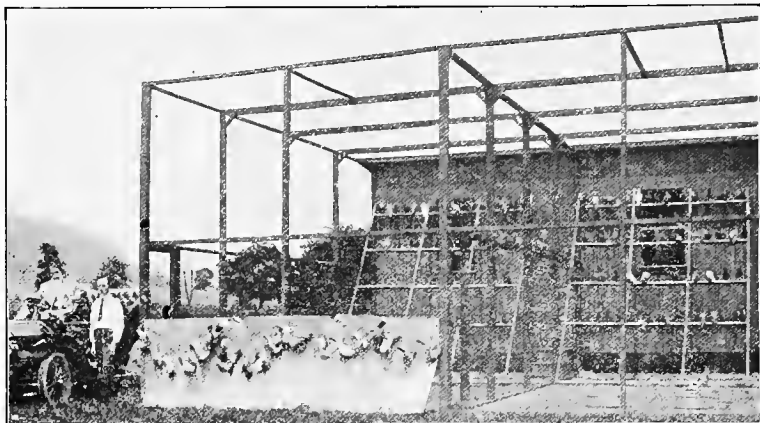

LIGHTED BY ELECTRICITY AND HEATED BY STEAM.

This shows part of the up-to-date plant of the customer in New York State whose letter is printed on this page. The birds hanging in front of the brown paper are squabs just killed to get them into the picture.

PAYING PLANT IN HANDSOME BUILDINGS. I enclose photograph showing my four units and office room. The building is made of matched lumber so that they are absolutely air-tight if so desired. It is equipped with steam heat, electric light, hot and cold water and both telephone systems. In the office room the grain bins are zinc-lined and moisture proof. The top is upholstered so that when the lid is down the room has a very pleasant appearance.

I have today broken ground for two more units, as my young birds are coming on so fast that I must make room for them. Besides supplying the Elmira market, I am saving my most promising young ones in order to increase my flock.

I have bought from you exclusively because I liked your business methods and believe you are fair and square. Your birds are good breeders and throw heavy, white-skinned squabs. Business is good and as fast as I make money I enlarge my plant.—L. S. W., New York.

SOME AT WORK AFTER LONG JOURNEY. The pigeons (dozen pairs) arrived, August 12, in good condition with the exception that two of them had each one wing hurt. I have waited to see how badly they were hurt before writing, but think they will pull through all right for one of them has taken a mate and is building on the floor of the pigeon house. Five pairs of them are building and three pairs are driving, while several others are paired off.—B. V., State of Washington.

FINEST BIRDS PERFECTLY MATED. CHANGED HIS HOUSES. I want to tell you about my birds. I received them the Saturday of the week you shipped them, turned them out on Monday and they went right to building. I have got three setting and I see the others are starting to build. They went right to work without any trouble. They go into the house every night just as if they were raised there. They are the finest birds I ever saw. I have just finished another large pigeon house and flying pen and I have put my white ones into it. Since I read your Manual I have changed most all my pigeon houses. I find they are so much better than mine. If any one is going into the pigeon business I would advise them to get one of your books on birds. I am sorry I did not get one long ago. Just as soon as I can get rid of my common pigeons I want to replace them with yours. I have got to build another pigeon house and it will be about October before I get through with it, and I shall need nestbowls and other supplies.—C. E. G., North Carolina.

SMALL ORDER FOLLOWED BY LARGER. Enclosed you will find an express money order, for which please ship me the following: 12 pairs Extra Homers, one dozen wood-fibre bowls, 25 pounds hempseed, 100 pounds Canada peas. Please ship as soon as possible. The three pairs of Extra Homers you sent Tuesday reached here Thursday in fine condition. Thank you for your prompt shipment.—G. J. A., New Jersey.

LETTERS FROM CUSTOMERS RECEIVED BY PLYMOUTH ROCK SQUAB COMPANY

NEW JERSEY WOMAN RECEIVES \$4.00 TO \$7.00 A DOZEN FOR SQUABS FROM PLYMOUTH ROCK EXTRAS. From the six pairs of birds I bought from you in 1905 and the extra pair you kindly gave me I have raised 215 birds. My squabs average 11 pounds to the dozen, sometimes more. The birds work all the time. They breed on the average of nine pairs every year.

I have never had to give them a drop of medicine since I have had them as they keep in perfect health.

I have lost about five pairs of squabs from the rats getting them, but never any from sickness.

I have built my coops after your suggestions in your book, *The National Standard Squab Book*, and am not troubled any more from rats. I have never seen any birds to compare with mine in size. I have seen hundreds of pigeons but every one praises mine up and remarks how large, full and broad they are across the breast.

So far I have been selling my squabs here in town. They bring from \$4.00 to \$7.00 per dozen, according to the time of year. This price I get for them right out of the nest without killing or picking.

I feed kaffir corn, cracked corn and wheat every morning, and every Monday, Wednesday and Saturday I give them hemp seed and Canada peas (on trays) as much as they will eat. They have fresh water twice a day in summer and once in winter and once every week I scald out their drinking fountains with hot water to keep them sweet and clean.

I have one box of grit and one of oyster shells in the coop all the time and instead of putting it on the yard floor I put it in boxes. I also have a lump of rock salt and a salt-cat in each coop made as directed in your *Manual*. Once a week I clean their coops and take the white-wash pail in with me and whitewash the boxes out and sprinkle slaked lime on the floors of the coops and the yards.

Your book has been a great help to me, and I have read it over many times and try to follow its directions in every particular.

I am thoroughly satisfied with my birds and feel I have had great success with them and would not have any other breed or kind were they to be given to me free. I am now ordering 30 pairs of Extra Plymouth Rock Homers, same as I got before in 1905, making \$75.00 worth, at the rate of \$2.50 per pair. I enclose check for same, \$75.00.—Mrs. S. V. F., New Jersey.

QUICK START BY A 700-PAIR FLOCK. In January and February, 1907, a customer in the Mississippi valley bought 700 pairs of Extra Plymouth Rock Homers. On arrival of the birds he wrote: "They are as fine a lot of thoroughbreds as I ever saw. You deserve the success you enjoy for your business methods."

The last consignment left us February 4 and reached him February 8. Nineteen days later he wrote us: "Our birds are doing very well. Have 400 pairs of eggs and squabs in the house, and probably 50 pairs driving. If the market will take all of our supply next month, we will put up another house at once and buy the birds of you, for you have always been fair and just with me."

On March 5 he wrote: "Our squab house is a mass of squabs and eggs. The birds were at work within three days after placing them in their rooms, which shows that the wood fibre bowls and surroundings suited them, and that they were properly mated. The special lot of 50 pairs is the most remarkable pen we have ever seen. In 30 days after their arrival, there were 40 pairs on eggs. We feel it our duty to compliment you on your fair, honorable and just dealings with us."

SIX DOLLARS A DOZEN IN CANADA FOR SQUABS WEIGHING NEARLY ONE POUND EACH. About two years ago I purchased from you 15 pairs of your Extra Plymouth Rock Homers. They have given excellent satisfaction in every way. All the squabs raised in two summers weighed 10-12 pounds to the dozen and at all times I was able to get \$6.00 per dozen for them, indeed, I could not nearly supply the demand. I had offers to supply one of the largest hotels in Canada if I had enough stock.

I think I am as enthusiastic a squab raiser as can be found. I have always kept fancy pigeons for pleasure, but never until I raised these from you have I raised squabs to sell.—A. M., Canada.

INCREASE TWENTY-ONE FOLD IN TWO YEARS IN OKLAHOMA. Would you please inform me where to ship the pigeon manure to a tannery? We have 200 pairs and we have burned 15 bushels this year. As I heard that you shipped the manure, I thought that I would write to you for my information. We are thinking of getting some more pigeons from you. Two years ago the 15th of February we got 11 pairs from your Company and now we have 231 pairs from those 11 pairs.—C. O. L., Oklahoma.

BIG FLOCK IN KANSAS BRED FROM SMALL BEGINNING. Some two years ago I purchased from you 38 Homer pigeons. I now have a pen of 500 of the nicest birds in this locality. I am expecting to build larger pens and divide the bunch, and I wish to get all the printed matter I can on the subject of squab breeding, also all the information you can give me by letter regarding the mating of birds, even if I have to pay a reasonable fee. Please let me hear from you by return mail and oblige.—G. G., Kansas.

LETTERS FROM CUSTOMERS RECEIVED BY PLYMOUTH ROCK SQUAB COMPANY



ON A POLE AT TOP OF FLYING PEN.

INDIANA WOMAN WON FIRST PRIZE AT HER FAIR. QUICK INCREASE IN SMALL FLOCK. HOW SHE FEEDS THEM AND CARES FOR THEM. In the spring of 1907 I bought 15 pairs of your Plymouth Rock Homers. In March they started to build their nests. At present (October) I have 82 young squabs with eight pairs on eggs. When the squabs are four weeks old they weigh 14 to 16 ounces apiece. They are very rich eating. One pair of birds raised me from six to seven pairs of young squabs (in less than eight months). When the squabs are two weeks old I clean their nestbowls out twice a week. Twice a week I sprinkle slaked lime around. I use tobacco stems. Also every day I give my coop a good cleaning. I have no kind of lice. I sprinkle a little slaked lime on the floor. I have a good many visitors. They say, how can you keep it so clean? Mr. Kline, Mr. Martin and several others were here to look at my birds. They thought they were fine. Some of my young birds are larger than some of the old birds. Some of the young birds have raised some young squabs for the second time, of which the first eggs were no good. I feed my birds in the morning. I give cracked corn, wheat, kaffir corn, buckwheat and barley, all mixed together and feed fresh water, plenty of it. Also their morning bath. This is their morning feed. At noon they get lettuce or cabbage leaves or Swiss chard. They are very fond of dry bread or cake. In the evening I feed the same as the morning feed except I scald a little oats; when cold, I mix it with the other feed. I put a teaspoonful of carbolic acid in their drinking water once a month. I am feeding sunflower seed once a week. When my young birds are six weeks old I pull their tail feathers out. I find out they do better. It seems to help them to shed their feathers quicker. I band my birds when four weeks old and place them in another coop. My coop is 16 feet long, 12 feet high, 10 feet wide, with a double floor with tar paper between, also it is lined with tar paper and has three large windows in it. I have 132 nest boxes. They are 12 inches square. I build them like you have them in your squab book. I would like to send you a picture of the squab house, but I planted lima beans and spun them up the wire. I will send you a picture later on. I got first prize at the fair. I have seen several kinds of pigeons but they don't compare with mine in size and weight.

We eat squabs about every Sunday. I make pot pie, also I have soup. I make what you might call noodle soup. They are the best stuffed with dressing made with one egg, one onion cut fine, little parsley, pinch of salt and pepper, a little grated nutmeg, the hearts and gizzards of the birds and bread broken in small pieces, water enough to moisten. This is enough for three birds to dress.—Mrs. S. B., Indiana.

MOVED HIS FLOCK, BUYING MORE. About a year ago, I purchased 12 pairs of Homer pigeons from you. At that time I was located at Lowder, Ill. About February 15 this year (1907) I moved them from Lowder to Waverly, which is about eight miles. I now have 34 pairs. Will be in the market for more birds at once. Also quote me prices on supplies.—G. C. H., Illinois.

ONE-POUND SQUABS. NEVER LESS THAN \$3 AND AS HIGH AS \$4.50 A DOZEN OBTAINED IN SOUTH DAKOTA. In September, 1905, I bought some Homer pigeons from you. Most all squabs that I have raised from your Extra Homers weigh one pound at five weeks old and I have got as high as \$4.50 per dozen for them, never less than \$3 per dozen. You may use this information as it is correct.—J. H. K., South Dakota.

NO AILING PIGEONS. Well, it has been some time since I received the 13 pairs pigeons from you and I will say I am quite well satisfied with them. They are all working but two pair and I have quite a bunch of good healthy young ones in my rearing pen and think I would have had more if I had given them more time and care, but I have too much other work.

I keep the house clean and have it white-washed, and don't believe I have an ailing pigeon in the loft. I think I have some lice but they are not bad. I spray my lofts once or twice a week, being careful to choose a bright, warm day.—C. R., Illinois.

VERY FINE FLOCK. I purchased some of your Plymouth Rock Homers a few years ago. I have a very fine flock of birds now.—J. M. W., Pennsylvania.

FIRST PRIZE ON ONE PAIR, FIRST PRIZE ON COOP OF FOUR PAIRS, COMPETITION LIVELY AMONG SEVERAL HUNDRED BIRDS. I promised to write you about the birds when the Fair was over. I will do so now. (September, 1907.) I took **first money on one pair**, the speckled wing birds, and **first prize ribbon on coop of four pairs**. Three of the pairs I secured from you and one pair from my pen. The judge said that the hen bird was fine, but cock not so good. Of course I did not have time to trim them or fix them up for the occasion. I had to go up against several pigeon fanciers but came out with flying colors all the same. We had several hundred birds of different kinds at the Fair. I informed several where those birds came from and how long I had them. Hoping this will be as satisfactory to you as it is to me.—A. C. M., Maryland.

TOOK ONE PAIR TO EXHIBITION, WON FIRST PRIZE, WAS OFFERED FIVE DOLLARS FOR THEM, TURNED DOWN OFFER. It has been a long time since you have heard from me. In the first place, I must let you know that my birds are getting along very nicely. I am very well pleased. I have 15 pairs of old birds and 75 young birds. I took **one pair to the County Fair**. They were red checkers. I received first prize. I was offered \$5 for the pair of birds. I told that man that I would not sell my birds and that if he wanted any birds I would give him your address so he could buy some.—Mrs. B. A., Indiana.

BEST PAIR OF HOMERS IN THIS ALABAMA COUNTY EXHIBITION. ORDERS MORE BIRDS. Your favor of October 19, 1907, was duly received. In answer to your query about our winning the prize on our Homers at the County Fair, we will state your information is correct. We won the prize for the best pair of Homers with a pair of blacks we got from you.

We expect to make a better display at the next Annual Fair and if we see that we have a lot of prize winners we will probably enter them at the State Fair at Birmingham. We hope you will assist us in our efforts by sending us extra good birds in our next order.—C. O., Alabama.

TOOK 18 TO THE CENTRAL MAINE FAIR AND WON 11 PREMIUMS. I have over 100 pigeons on hand. I purchased three pairs of you at \$2.50 per pair and bought two pairs of C. E. Melvin at \$2 a pair, and this is the product of the two kinds. I took 18 of them to the Central Maine Fair at Waterville the past week (September, 1907) and got 11 premiums on the 18 birds. The others are all about the same, good, healthy birds.—S. A. P., Maine.

FIRST AND SECOND PREMIUMS AND SPECIAL COMMENDATION AT THIS ILLINOIS POULTRY SHOW. The pigeons you sent me obtained the first and second premiums at the poultry show with special commendation. I was informed the judges stated that one pair in particular would be very hard to beat anywhere. I thoroughly demonstrated that "blood tells."—O. J., Illinois.

ANOTHER WON FIRST PRIZE AT AN ILLINOIS COUNTY FAIR. I have some of your Homers bought. They are fine. They have won first prize at the County Fair. Send plans for pigeon houses.—T. H. W., Illinois.

ONE CUSTOMER WON THE PRIZES AT THE FAIR WITH OUR BIRDS AND HIS NEIGHBOR WISHES TO GET SOMETHING TO BEAT THAT. Enclosed you will find money order for which please send me three pairs No. 1 Homers, one drinker and six bowls. Colors, one pair blue checkers, one pair reds and one pair blacks. Please send mated birds. Send some good birds because I want to beat your customer Mr. N. in the poultry show here soon. He got the prize at the Fair. I have some blue barred hens. Please send me all the circulars that you send out because I want to start in the business right.—B. R., Alabama.

COW PEAS SUBSTITUTED FOR CANADA PEAS. I enclose you what they call "cow peas" here to ask you if they are what you call "Canada peas." The pigeons I got of you are satisfactory in every respect. Will probably get more March 1.—D. H., Illinois.

Answer. Cow peas are not Canada peas but they are fed largely to pigeons and if they are plentiful in your State, feed them.

BETTER BIRDS THAN ANY IN THE BIG POULTRY AND PIGEON SHOW IN MONTANA. WANTED SOMEBODY HE COULD RELY ON FOR THE GENUINE. I am very well pleased with the stock I received to-day. They are the finest lot of pigeons I ever saw. I received your letter and directions this morning and the pigeons this afternoon. Thank you for the prompt and careful selection you gave me. Many thanks for the extra pair of pigeons. They seemed glad to get out of the box. They look fine for the long trip and all perfectly well. I did not expect to see such fine birds for I did not know how they would get through the snow blockade in the Dakotas. Although I have seen only one letter from your customers in Montana, I think that if I follow your directions closely, I can make a success of it. There ought to be a good market here and in the big poultry and pigeon show there were none could stand beside these. The "National Standard Squab Book" convinced me that I wanted somebody I could rely upon for the genuine.—M. G. S., Montana.

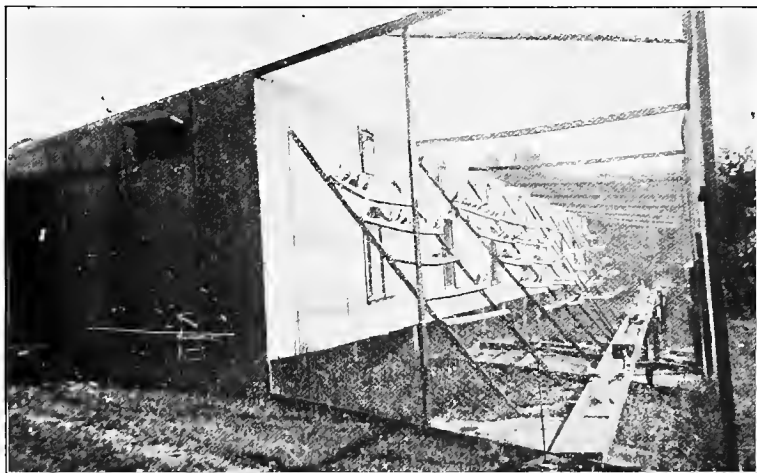

CHEAPEST POSSIBLE CONSTRUCTION.

Single boarding, covered with roofing, no shingles. The long, shallow wood trough is for the birds to bathe in. The water enters from a faucet in the foreground. After the birds have bathed, the water is emptied by pulling a plug at the end. The trough is cleaned with a broom. The man who sends this photograph writes: "I raised 1650 young ones from March 1, 1907 to July 1, 1907 (four months) from 450 pairs of breeders in this building."

MADE A TRIP SOUTH AS FAR AS VIRGINIA AND FOUND OUR BIRDS THE BEST ALL ALONG THE LINE. NONE OTHERS ANYWHERE NEAR THEIR EQUAL FOR SIZE AND QUALITY. I have sold lots of squabs this summer. I average about 800 a month. Besides that I have worked up a little side trade in selling mated birds, but only the very large ones, such as I raise myself. Such orders bring me \$3 a pair. I can't raise them fast enough to supply my trade, but I guarantee to do what is right by them all.

I can say the credit is yours for supplying me with the old birds, as you did, but I only wish I had sense enough to have held on to all I ever got from you. Mr. Rice, I claim to have raised the largest Homers that any man can raise.

I visited a plant in Pennsylvania. While I was there I was also down to Philadelphia and Delaware as far as Virginia and I saw your fine birds all along as I went, but none others were anywhere near their equal as far as size and quality went.

I will take the largest Homers you have to-day and breed them in my coops and raise the young ones myself, and the young birds will be larger than the old ones, but that is experience that does that.—L. Y., Connecticut.

WHY WE HAVE MADE A SUCCESS. I wish to thank you very much for the nice selection both in size and perfect marking. I readily see why it is you have made a success of Homer breeding. I have long since found a satisfied customer is by far the best advertising medium in building a substantial business. I will give you my future orders. I hope to add frequently to my nice loft of birds. No off-color or inferior birds can exist in my pens. Wishing you success.—W. B. T., Texas.

CANADA CUSTOMER FINDS PROFITABLE OCCUPATION. About six months ago I purchased from you seven pairs of your Extra mated adult Plymouth Rock Homer pigeons. Have had very good success with them. Starting with seven pairs, I have now (June, 4, 1907) fifty-six hardy Homers. I also got a Manual from you and find it very helpful. On the whole, I think squab raising is one of the most profitable industries pursued to-day. You can publish this letter if you wish.—J. M., B. C., Canada.

LETTERS FROM CUSTOMERS RECEIVED BY PLYMOUTH ROCK SQUAB COMPANY

CONNECTICUT WOMAN'S BIRDS BREED BETTER THAN MANUAL STATES. SHE HAS SEEN ONLY ONE LOFT OF BIRDS AS GOOD AS HERS AND THAT MAN BOUGHT HIS STOCK OF US. I will give you a statement of the birds I received from you the 23d of April, 1907. My birds do very much better than you state in your Manual.

They arrived in perfect condition and are very large and beautiful, have always been perfectly healthy. There has never been only one that was sick and that was caused from moulting and raising birds too fast. I took her away until she had recovered and her mate cared for the young birds. These birds lay when their young are from 12 to 21 days old.

Some of them are sitting on their fifth lot of eggs. They have hatched 48 young birds in four months and just three weeks, and expect more will hatch this week. Some of the young ones are beautiful.

I have never had young birds remain in their nests over three weeks.

One pair build on the floor and their birds leave their nest at 17 days old. These weigh at three weeks 14 ounces, others at ten days weigh one-half pound each, some at three weeks weigh one pound.

I have some that are very delicate from which I shall use for flying. These birds do not weigh but 14 ounces at four weeks old.

I have seen but one loft of birds as large and handsome as these birds, and those were owned by a Mr. Cornwell of Milford. He bought his first birds of you and claims that they raise 11 pairs of birds a year. One of my neighbors who was watching my birds said: "In all the birds I have ever seen these are the largest and most lovely."

I have followed your advice in the care of them and would like to know if mine are doing as well as the average you hear from. If I am successful in flying the birds will let you know. Enclosed you will find money order for 50 pounds of health grit.—Miss A. A. W., Connecticut.

CHAIR SEATS USED FOR THE BOTTOMS OF NEST-BOXES, CHEAPER THAN LUMBER. HOW TO CHOP UP STRAW FOR NESTING MATERIAL. I note you say use long boards for bottoms of nests and short pieces perpendicular. I reversed this before seeing your plans by standing up long boards 12 inches apart, toenailed to wall. These boards have three-quarter-inch by three-quarter-inch cleats for bottoms. I use 12-inch three-ply perforated seats. These seats are varnished, are light and strong, as your excellent bowls. They are slightly concave in center, just fitting the nestbowl, and the perforations do not extend beyond margin of bowl. I fasten bowls to them with stove bolts. I can remove nut in a moment and have bowl and base separate for cleaning, and they are cheaper than good lumber, which costs five to six cents a square foot. Seats 12 inches square can be bought for three cents each. They come 10, 11 and 12 inches square.

You suggest no easy way for chopping straw in proper length for nests. I have stumbled onto a cheap and easy plan for small fellows like me. Use a common mitrebox and saw. Place mitrebox on table near end and a receptacle beneath. One or two strokes will cut through a big handful of straws and as you move up for next cut, the short ends drop into receptacle.

I hope you do not consider all this didactic (or what not) for to tell the truth I have gotten more pleasure and information out of your Manual than I could have gathered with endless and expensive experimenting, and I want to help if I can in any small way.—P. O. L., New Jersey.

HIS BATH-PANS ARE MOUNTED ON A PIPE AND HE EMPTIES ALL WITH ONE TURN OF A CRANK. FILLS ALL BY TURNING ONE VALVE. My self-feeder is just perfect. Two of the ranches about here are fitting up with it. I also have all my windows raised or lowered at the same time and with only one motion. One or as many as you like can be detached and remain closed. I can stand in my feed room and do the whole thing without taking a step.

My bath-pans are all mounted on a one-inch pipe running through the flying pen. The crank is just outside the end of the pen. It locks when the pans are up for bathing. The water is turned on by a faucet outside the flying pens. Now to empty this, no going inside the pens, frightening the birds and swashing the dirty water onto your hands. You just unlock the crank, rock the pans to and fro two or three times, turn down your crank and every pan dumps its dirty water onto a drip board running outside the pen. Leave your pans down and no snow, ice, or droppings can get into them.

My drinking fountains all work from the passageway. Not a particle of filth can get into them.

Now I have not written this in any spirit of egotism. I consider it just common sense economy of my own construction.—J. W., New Jersey.

THIS FLORIDA CUSTOMER BEGAN WITH TWELVE PAIRS OF OUR EXTRAS IN 1903. We now (September, 1907), have about 400 to 500 birds and during winter and spring have killed on an average of 25 squabs per week. To be accurate in this I cannot, as no account was kept, but must say the birds have proven very satisfactory indeed. Will give Mrs. B. your letter upon her return and she can answer it also.—J. C. W., Florida.

LETTERS FROM CUSTOMERS RECEIVED BY PLYMOUTH ROCK SQUAB COMPANY

SQUABS SHOULD NOT BE SOLD DRAWN. THE COOK IS THE ONE WHO DRAWS THEM. The six pairs of Extra Plymouth Rock Homers have increased to about 60 since last May 20, breeding right on all the time, just the same now (January, 1907), as last summer, all large youngsters, which weigh with feet off, head off, entrails removed, just over half a pound. Please let me know whether commission men weigh them that way, or if they leave the feet and head on?—P. A. W., Pennsylvania.

Answer. Squab dealers always weigh them with the head and feet on and undrawn. Never draw your squabs before selling them. They will not keep so well in the markets, and the marketmen do not take them that way. The heads, feet and insides are removed by the cook.

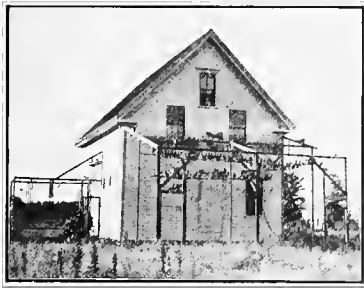

THE START.

In this barn, the customer whose picture is printed on this page made his start. It is still in use but the greater part of his breeding is done in a long multiple unit house nearby.

AFTER ONE YEAR'S SUCCESSFUL TRIAL HE BUILDS A HOUSE FOR THREE HUNDRED PAIRS. The pigeons I got you a little over a year ago have been doing finely. Am now (April, 1907) building a house to accommodate three hundred pairs. Enclosed find check for \$23.04 for which please send me two gross of the fibre nest-bowls. I will have a picture of my new house taken a little later on and send to you. I could not give you any definite figures as to what your birds have done for me, as I had some other birds in with them. However, the ones got of you are the best and largest. One pair especially has raised a pair of squabs almost every month. I expect to put some of your birds to themselves as soon as my new house is ready, and may be able to give you figures on them later on.—H. B., Indiana.

GRAIN AND SUPPLIES TO THE GULF STATES BY STEAMSHIP. Please quote me price on 200 pounds of mixed feed but without chops. I cannot get wheat or hemp seed, and I find my birds do better on your mixed feed. The birds I ordered from you some time ago are doing finely. I am very much pleased with them.—B. E., Mississippi.

Note. We ship a great deal of grain and other supplies to customers living in Gulf States by boat from New York to Mobile, New Orleans, Galveston and other ports, a quick and cheap route, much faster than rail, and more satisfactory. The shipments get less handling.



THIS CUSTOMER

Started with a dozen pairs of our birds and has run them up to 800 pairs, paying a handsome profit. This is spare time work for him, as he is regularly employed at his trade.

WONDERFUL MATINGS. MORE SALES PROMISED. I received the 12 pairs of birds O. K. in fine shape April 11, 7 p.m., 1907. They are a nice-looking lot of breeders and all you claim them to be, as two of them laid eggs while in transit and two more laid to-day, April 13, so you see there is something doing. The other six pairs are doing well. All laid but one pair, and I think they are coming along all right. I assure you that such fair treatment means a continuation of sales with me and I shall recommend the Plymouth Rock Squab Co. to those who are buying breeders. Will return baskets to-day. You can use this as a testimonial if you wish.—W. B. H., Massachusetts.

LETTERS FROM CUSTOMERS RECEIVED BY PLYMOUTH ROCK SQUAB COMPANY



BEAUTIFUL PAIR OF SPLASHES.

The second bird on the left and the last bird on the right are types of oddly-marked Plymouth Rock Homers

FEEDS HIS BIRDS LOCUST LEAVES AND PEPPER GRASS. BOSTON DEALER ALWAYS GIVES HIM MORE THAN THE MARKET QUOTATIONS BECAUSE HIS SQUABS ARE WORTH MORE. I purchased 12 pairs Extra Homers of the Plymouth Rock Squab Company, in February, 1906, the best stock I could buy. I saved all my squabs for breeders up to January 1907, when I began to ship the squabs. They average 9 pounds to the dozen, and I receive from \$3 to \$4 per dozen for them. I ship to the Boston market.

I feed my birds on wheat, cracked corn and kafir corn in equal parts, with peas and hempseed as dainties. I feed them in wooden traps, not finding any self-feeder which I like. A box containing grit, oyster shells and charcoal is kept before them all the time and the flying pen outside covered with coarse sand. I find pine needles to be the best nesting material, the birds building a small, neat, compact nest with them.

I sell the pigeon manure to parties in town at 50 cents per bushel. My squab house is 36 feet long by 14 wide, with a passageway three feet wide on one side. The birds are watered by fountains placed in the passageway. My flying pen is 36 feet wide, 18 feet long and ten feet high, divided into three parts.

I find my birds to be very fond of locust leaves and pepper grass, eating it like grain. They like peas and hempseed so well that they will fly on to my hand for them. My birds are mostly blue checkers, with a few reds and silvers among them.

I ship nearly every week to a large commission dealer in Faneuil Hall Market, who always gives me more than the market quotations. My birds are all in fine condition, no poor ones among them, and are raising big, fat squabs at the present time. (June, 1907.)—E. B. K., Massachusetts.

MOVING, GOING INTO THE BUSINESS ON A LARGER SCALE. Our Homers have done fine since we have had them. We have doubled. So far we have lost only one pair of squabs and we think the parents smothered them. Then one of our young birds of our first pair got out and away and we think he was frozen or caught by a cat, for the night was a cold one. Now we are going to move and take a place where we can go into the business on a larger scale, so we will hope to send for more birds as soon as we get coops ready.—Miss H. L. A., New Jersey.

PLYMOUTH ROCKS BEST IN MEMPHIS. I have lost only one bird from sickness. I have had no trouble with lice at all. My birds keep very clean and are also very tame. I go to see all the pigeons around Memphis but find none as fine looking as yours. Your Manual is a fine teacher, why it is worth a dollar. I hope to have success by following your Manual as I have done so far.—W. A., Tennessee.

SQUABS TEN POUNDS TO THE DOZEN. GOING TO SHIP TO NEW YORK FROM IOWA. If you remember I bought some fine Homers of you a year ago last September. They were the Extras. They have done well. Must have now 150 birds, fine large ones at that. I can send squabs to New York from here for \$1.50 per 50 pounds. That is what I want to do eventually. I weighed 12 squabs just as they came, one month old. They weighed a trifle over 10 pounds. One pair weighed two pounds exact.—J. C., Iowa.

SUPERIOR HOMERS BREEDING EXTREMELY LARGE SQUABS. Accept my thanks for your fair treatment with regard to my order of June. The birds are breeding extremely large squabs. Since then I have had given to me twelve pairs pedigreed Homers, but yours are superior in every way. Enclosed find P. O. money order, for which please send me six pairs Extra mated adult Homers and twelve wood-fibre nestbowls.—F. R. M., Massachusetts.

LETTERS FROM CUSTOMERS RECEIVED BY PLYMOUTH ROCK SQUAB COMPANY

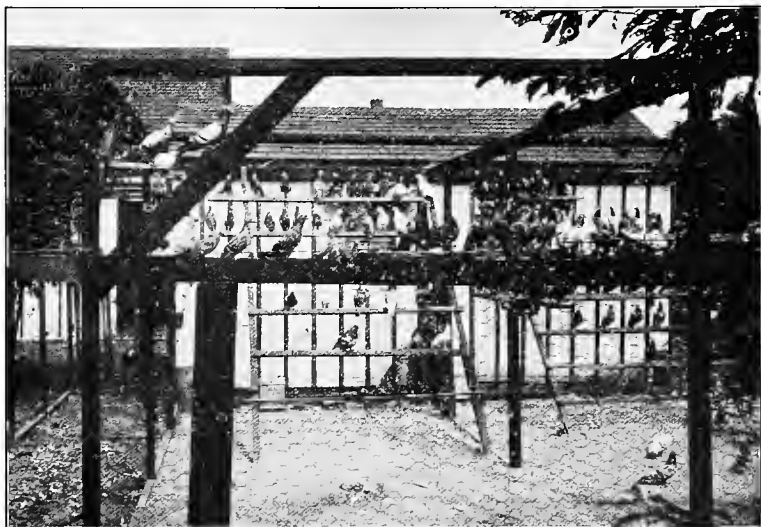

PLYMOUTH ROCK BLUE BARS AND BLUE CHECKERS.

BOY IN THE INDIAN TERRITORY 13 YEARS OLD GOT RID OF HIS FLOCK OF COMMON BIRDS AS SOON AS HE SAW PLYMOUTH ROCKS AND WHAT THEY WOULD DO. The nappies ordered of you came on time. My pigeons put them to use as soon as they arrived. I bought six pairs of your **Extra Plymouth Rock Homers** in January, 1907. I now (July) have 32 large, full-breasted birds. Some of the young ones are going to work now. I am 13 years old and was anxious to do something to **make a little money** while going to school, and saw an advertisement of your Homers and made up my mind to try them. I am more than satisfied with my investment and within the next year I expect to have a very nice little income.

In your Manual you show a diagram of a self-feeder, and I had one made which is very satisfactory, as it saves so much work and attention. I can get all the grain recommended by you except the buckwheat and hempseed, and I use red (instead of white) wheat, and my birds are thriving and doing well.

I hope to be able to dispose of all I can raise here in my home market, as they are so large and fine. In fact, there is all the difference in the world between my Homer squabs and the ordinary scrub squab, and it will pay any one wanting to go in the business to get the best to start on. I weighed some of my squabs this morning (just three weeks old) and they average one pound each, or two pounds to the pair. I had a flock of common birds and the squabs were dark skinned and weighed about eight ounces, and when I read of your birds I at once sold out and ordered from you, and I certainly feel that I made a good trade. I expect to order six pairs more soon. Thank you for the promptness and care taken of my orders.—L. G., Indian Territory.

THREE DOLLARS A DOZEN FOR PLYMOUTH ROCK SQUABS IN ARKANSAS. Please send six more pairs of your **Extra Plymouth Rock Homers** and one dozen nest-bowls. We are able to get \$3 a dozen for our squabs at the hotels here.—W. A. T., Arkansas.

LARGEST EVER SEEN IN ONTARIO. The weather has been very cold here, 30 degrees below zero, so I have kept a coal oil stove going most of the time. Your birds have been greatly admired. They are the biggest that have ever been seen here.—G. S. B., Ontario.

LETTERS FROM CUSTOMERS RECEIVED BY PLYMOUTH ROCK SQUAB COMPANY

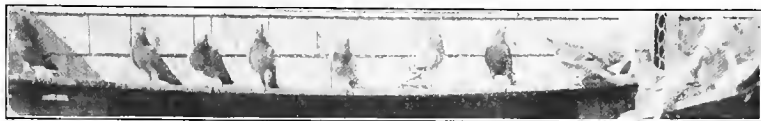

ON A RUNNING BOARD IN THE SUN.

NESTBOWLS VERY PRACTICAL AND ARE A NECESSITY. BUSINESS SHEET OF A BEGINNER WITH SQUABS IN CANADA. On May 5, 1906, I received your lot of seven pairs Extra Plymouth Rock Homers, one pair out of the seven being free, as some nestbowls were bought previously, to allow for the express charges on them. I may say that these bowls are very practical, as none of my squabs have suffered from sprawled feet as is noticed when earthenware nappies are used.

The breeders were put in the pigeon house the same night and it was not long before they became acquainted with their new home. Full instructions were sent before the pigeons reached here and as these were clear it was very easy to follow them. Sixteen days after their arrival there were two eggs in a nest. This was an event, as many friends were interested. They were much surprised to see these three-week-old squabs weighing 14 ounces and even more than 16 ounces at four weeks. Their common pigeons were looking very small against my Plymouth Rock Homers which were looking so fine. It was really funny to hear them taking notice of the wonderful difference. Mine were looking so fine with their large breasts, their bright-looking eyes, their wings which look to be detached from them. The opinion of my friends was that they were the finest birds they ever saw.

At the end of the first month there were four squabs and six eggs, at the end of October 12 pairs of eggs had been laid and hatched, making a total of 22 pairs of squabs at the end of six months. All the squabs of the first August were eaten at a family dinner and proclaimed the finest squabs that were ever served on such an occasion. Since that time we disposed of the squabs for breeding purposes and for eating. Last winter I had 15 pairs of squabs laid but as the winter was very cold some of the squabs died because the parents were not acclimated, but I am sure that this winter will not be so fatal as they will be acclimated. Since April, 1907, I have had 29 pairs of eggs, of which 26 pairs of squabs have been eaten. In consequence, pigeon keeping in Quebec has proved to be a success, a paying business, when proper birds are used—that is, the Plymouth Rock Squab Company Homers.

Business Sheet of an Amateur Squab Breeder.

May 5, 1906 to September 1, 1907.

Total of eggs laid, 66 pairs.

Total of pounds of grains, 638, at a cost of \$11.47.

Rations of Grains for Feeding Purposes.

	Winter	Summer
Peas	30 lbs.	30 lbs.
Red Wheat	15 lbs.	25 lbs.
Buckwheat	15 lbs.	15 lbs.
Cracked corn (not sifted)	40 lbs.	30 lbs.

During September and October I fed 30 pounds red wheat and 40 pounds peas.

The pigeons are sold in Montreal for: 50—70 cents per pair in winter, 45—55 cents per pair in autumn, 30—40 cents per pair in spring, 25—35 cents per pair in summer. Average price, 40 cents per pair—G. G., Canada.

KNOW WHERE TO BUY WHEN THEY WANT THE PIGEONS WHICH ARE THE VERY BEST IN EVERY RESPECT. In February, 1906, I bought pigeons from you from which I am raising the finest flock of pigeons that I ever saw. I am sending to you herewith with hopes of getting more from you that are equally as good if not better than the ones I got last year. The enclosed order is partly for myself and partly for Mr. Ritter, who has been corresponding with you recently. We want pigeons that are the very best in every respect.—W. A. G., Ohio.

BEAUTIES, EXCELLENT LAYERS, VERY HEALTHY. In September, 1904, I purchased from you 12 pairs of birds. We have increased our flock to over 100 pairs so at present (October, 1907) I am obliged to sell some of our young birds for the need of making room for others. They are beauties and give good satisfaction. They are excellent layers, hatching fine, large squabs weighing, from eight to 12 ounces and are very healthy. Perhaps next year I shall be situated so I can order about 50 pairs of your first-class breeders.—E. E. H., New Jersey.

LETTERS FROM CUSTOMERS RECEIVED BY PLYMOUTH ROCK SQUAB COMPANY



INTERIOR OF MASSACHUSETTS CUSTOMER'S HOUSE.

Wire netting is used always to separate the units, not board partitions. This breeder has not set nest boxes up against the wire netting, but this is done in almost every case.

NEVER HAD A SICK BIRD AMONG OURS, BUT BIRDS FROM ANOTHER SOURCE ARE WEAK AND POOR BREEDERS, HANDLED UNDER THE SAME CONDITIONS. You will probably remember me as having bought two dozen pairs of **Plymouth Rock** pigeons from you last November. Out of the 25 pairs you sent me, I have 20 pairs working. One bird died, one got away and one cock bird I killed. I thought I would try some one else's birds to see what they would do, so I bought two dozen pairs from _____. I built a new house exactly the same as I put your birds in, and have given them the same treatment, but they are not doing as well as your birds. They do not seem strong and vigorous like your birds.

I would like you to send me 24 pairs of your very best **Extra Plymouth Rock Homers**. I am not particular as to color so long as the quality is there.

I have kept the birds I got from the other man in a pen by themselves as I want to give them a fair chance. They may be young birds, as they do not seem to care for their eggs and young as they should do. I give them exactly the same treatment as I give the others, but they do not seem as vigorous as your birds. I have never had a sick bird among yours, since I got them, only the one that died soon after I received them.—J. W., West Virginia.

NEWS OF OUR SUCCESS CARRIED TO INDIA. Having heard something of your wonderful success in this business from a gentleman from America, I should very much like to hear full particulars. I have some young nephews in California whom I should like to help make a start in some way.—M. C. H., Bombay, India.

LOST ONLY TWO YOUNG SQUABS. Will you be so kind as to tell me where I can get a good cut of a pair of **Homer** pigeons? My birds which I bought of you are doing well. I have not lost any but two young squabs before they were grown. They are certainly nice.—L. L. D., Georgia.

GOOD MATINGS. FOUR NESTS SIX DAYS AFTER REACHING KENTUCKY. Homers received in splendid condition on March 8. They are surely a beautiful lot of birds. Am very much pleased with them and hope to duplicate order in a short time. They have built four nests already. (March 14.)—I. P. Y., Kentucky.

ONE HUNDRED SQUABS A MONTH WEIGHING ELEVEN TO FOURTEEN OUNCES. I have nothing but your **Extra** stock exclusively and am now turning out 100 or more fine squabs weighing 11 to 14 ounces and over every four weeks.—E. M., South Carolina.

LETTERS FROM CUSTOMERS RECEIVED BY PLYMOUTH ROCK SQUAB COMPANY

SIX SQUABS WEIGHED A LITTLE OVER FOUR AND ONE HALF POUNDS. I am sending you by mail a photo of one of my pigeon houses. I cannot have both houses taken in the same picture because they are too far apart. This picture was taken when I had only 25 pairs of birds in it. I now have 45 pairs in it, all your birds, and they are doing fine. The birds are not quite through the moult yet but they have been breeding right along. I killed six squabs to-day and they weighed a little over four and one-half pounds after they were picked; so that's not so bad, considering that they are moulting. Please let me know if you can let me have two pairs of good Carneau, something you can recommend, as I would like to get good ones.—W. I. L., West Virginia.



WOMEN ENJOY SQUAB RAISING.

HE HAS THE LARGEST HOMERS IN HIS PENNSYLVANIA TOWN. I think it is time to let you know about my birds which I got from you in April, 1906. Well, they are doing all right. You know I got three pairs. Now (May, 1907) I have 36. About 16 young ones died last winter on account of the very cold weather we had. I must thank you very much for the birds which you sold me. We have quite a lot of people that have Homer pigeons around here, but I have the largest of them all, so I am well satisfied and shall always recommend your squab farm and your Homers.—H. D. K., Pennsylvania.

EXTRA POCKET MONEY. I thought I would write and tell you how my birds are getting about. I have raised squabs enough to pay for their expenses and extra pocket money.—J. D., Massachusetts.

EXTRA PLYMOUTH ROCKS SUPERIOR TO ANY RUNT CROSSES AT MUCH LESS COST. I have been interested in your advertisements for some time, and if you will favor me with any suggestions regarding my own birds, I will be grateful. About two years ago, I got some Runt-Homer crosses of the best strain, thinking them best for heavy squabs. They are as prolific as can be, but the squabs weigh only 14 or 15 ounces at four weeks old. The surroundings, feeding, etc., are all right, as I am only keeping a few pairs for pleasure of it. Would like to be put aright.—P. A. R., California.

Answer. The strain of Extra Plymouth Rock Homers we have developed are superior in weight of squabs and rate of breeding to any Runt cross, at one-fourth the cost of Runts. The only birds superior to our Extra Homers are our Carneau. These breed squabs weighing 12 pounds and more to the dozen, and breed faster than Homers.

NO LET-UP IN BREEDING IN STATE OF WASHINGTON. FINE, FAT SQUABS. Since last August I have been a very sick man; in fact, came very close to the divide, but have not crossed over yet. (April, 1907.) About my pigeons, I have not noticed any let up about their breeding since they commenced last May. I have about 150 all told now, fine big fellows. I have fed them red wheat, kaffir corn, hemp seed and the small yellow seed you recommended, have forgotten its name, with grit, clam shell from the beach, salt and charcoal once in a while, fountain of water in the house and running water in the yard. The birds do not like strangers. They are not afraid of me. I have some fine fat squabs. You can improve on your hopper feeder by nailing a lath on the inch piece to which the feeding holes are nailed. Let it stand up one-half to three-quarters inches above the one-inch piece. It does not allow them to pull out the grain so fast. I send you a picture of the house and yard with a few of the pigeons on roosts.—G. H., State of Washington.

TWELVE PAIRS OUT OF THIRTEEN PAIRS AT WORK IN TWELVE DAYS AFTER RECEIPT. I thought it might be of interest to you to know how my little flock of birds are getting along. It has been just twelve days since they arrived and I now have twelve pairs out of the baker's dozen at work. It strikes me that there is "something doing." I have a nice, roomy home for them and do everything that I can to make them happy, and enjoy the care of them very much. I feel now as though I will succeed and if I do I will build me a unit plant next spring and will stock it with your Homers. I go East about once a year as far as New York, and the next time I go, I will go over to Boston and visit your plant.—B. A., Georgia.

LETTERS FROM CUSTOMERS RECEIVED BY PLYMOUTH ROCK SQUAB COMPAN

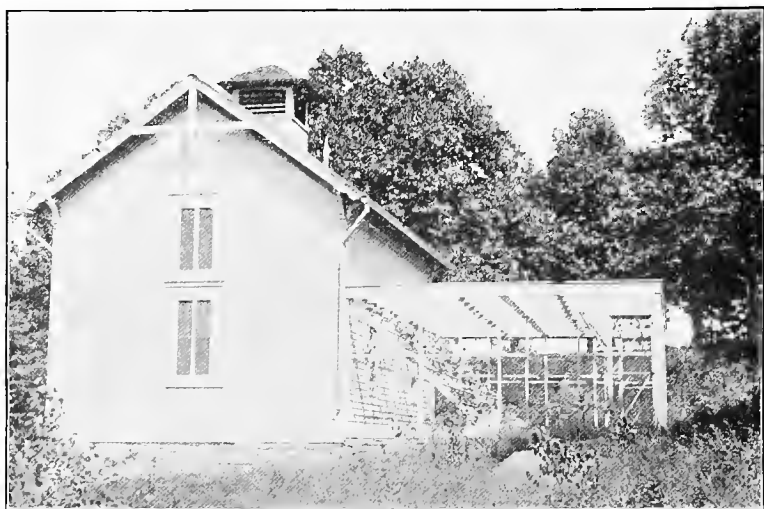

AT THE BACK OF A BARN.

Showing how a New York customer made a handsome home for his birds without doing any building. (This flying pen is shown in detail on next illustrated page.)

THAT THE WORK IS NOT BEYOND THE PERSON OF AVERAGE ABILITY IS PROVED BY THE SUCCESS OF THIS 15-YEAR-OLD BOY WHO HAD NO PREVIOUS EXPERIENCE AND NO GUIDE BUT THE MANUAL. Please send me prices on pigeon supplies, also prices on breeding stock, as I have mislaid those that I received from you about a year ago when I purchased pigeons of you. I am only a boy of 15 and must wait until I can earn enough from the ones I have. My **Extra Plymouth Rock Homers** have done very well. My brother bought six pairs of you and he sold them to me immediately after they began work before winter was half way begun. One pair died, so that left me only five pairs of breeders. I was so interested in these that I forgot about the pair that died. They worked fine until cold weather set in, having averaged a pair of squabs from each pair every seven weeks, but during the cold weather we raised less. Our loft being upstairs, in an old granary, was pretty cold.

This spring (1907) they began work in earnest again, laying their eggs again before the squabs were two weeks old. One young pair only four months old raised a pair of squabs weighing one and one-half pounds. I have now about seventy-five (75) birds old and young and lots of eggs.

We got 50 cents a pair for the squabs we sold, but I did not wish to sell many because I am to raise them for breeders.

It certainly pays to buy the **Extras**, for everybody who sees them says they are splendid, but I believe your Manual is just as necessary to make it a paying business. I do not see how I could raise them without it. Perhaps I will want some more breeders if I get the building ready this summer.—G. L. G., Wisconsin.

ONE SALE LED TO ANOTHER. No doubt you are acquainted with Carlton Daniel, who is a first cousin of mine. His pigeons looked so fine that they encouraged me to buy of you. I don't think mine can be beaten.—F. W., Indiana.

OUTGROWN THE COOP. Please send me five dozen nestbowls and one drinking fountain by express. My coop has got too small to hold the birds. The dozen pairs you sent me have increased to 125 birds.—F. C. W., Massachusetts.

LETTERS FROM CUSTOMERS RECEIVED BY PLYMOUTH ROCK SQUAB COMPANY

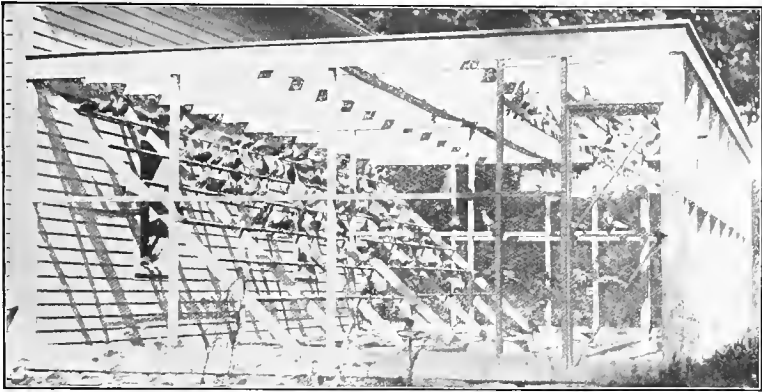

SHIPSHAPE FLYING PEN.

This is the flying pen of the place illustrated on preceding page. By the use of inch boards the owner has finished off the timbers so that the effect is permanent and beautiful.

THIS NEW JERSEY BREEDER RECEIVES \$4.50 A DOZEN FOR HIS SQUABS AND THE DEMAND IS SO GREAT THAT HE CANNOT FILL HIS ORDERS, SO BUYS MORE BIRDS In sending my second order (January, 1907) for your *Extra* mated birds, I would like to put in a few words in regard to the birds I received from you in 1904. My birds have done finely. I sent to Boston \$30 for 12 pairs. The birds arrived in the finest shape that was ever seen in this part of New Jersey. I received the birds in May, 1904, and had eight pairs of squabs in July. I then went to work and kept all the squabs for a short time until they got six to seven months old, then I went to mating them the way you show in your *Manual*. I now in January, 1907, have 200 birds which is only one-fourth of the birds I raised, but the demand for squabs was so great that I could not get the chance to save any for breeding. That is the reason why I send an order for 50 pairs of your best birds.

My house is 12 feet wide and 26 feet long with a hall three feet wide, one window on the north side and three windows on the south side, with 200 nests. My first house was 12 feet by 12 feet, but I found out that when handling **Plymouth Rock Homers** it does not take long for them to make money for a larger house, and to get a start in a business of our own.

I would like to tell you that I put one advertisement in a paper of our town some time ago, not to sell my squabs for I had more orders than I could fill, but to let my friends know that I meant that there was money in handling your birds. The advertisement brought me so many orders that I didn't know what to do.

The demand for squabs is so great that I get \$4.50 per dozen. My squabs average nine to 12 pounds to the dozen.

I am going to build house No. 3 this spring and then I will need more of your fine birds.

I would like to tell you a few words in regard to the *Manual*. It is the finest I have ever read for the reason you show how to run a successful squab business.

I use the self-feeder which you show in your *Manual*. I always find the feed clean and dry, which is the main part of the feeding part. I feed cracked corn, red wheat, Canada peas and hempseed. The feed bill will not exceed 85 cents a year per breeding pair. I can figure on nine pairs of squabs per year at 75 cents per pair, which leaves me a net profit of \$5.20 per year for each pair of breeders.

I am perfectly satisfied with the results obtained from your birds and wish you continued success.—A. N., New Jersey.

VALUES HIS BIRDS AT FIVE DOLLARS A PAIR. I would not sell my birds for five dollars a pair now.—C. E., New Jersey.

USUAL STORY FROM IOWA. The birds received from you last winter are doing finely.—E. R. W., Iowa.

BIRDS FED ONLY CRACKED BARLEY. BIRDS WHERE TO GET MORE BIRDS.

I have some fine birds and am stuck on that last basketful you sent—those nice dark checkers, and some of the nicest sky blue I ever saw. I have some young birds from the last ones you sent me that will mate in two or three weeks, so you can see they did not lose much time after shedding feathers. There was a man at my place, whose name I forget. He said his birds were from your place and that my birds were livelier than his. I told him if he would follow your book he would be all right. I told him he was feeding too much, or he was not giving them the right feed, and he said he was feeding cracked barley so he cannot expect much from his birds.

I went to the market to find out what they are paying for birds. They are paying 25 cents apiece for old common birds and he said that they pay more for Homer squabs.

My birds are getting along finely. I am going to get 60 cents a bushel for manure with straw in it, which I think is a good price.

If I want any more birds I know where to get them and that is from your place.—J. C., Wisconsin.

READY SALE IN LOUISIANA FOR ALL SQUABS THAT CAN BE PRODUCED. PRICES ARE GOOD, RANGING FROM \$2.50 TO \$4.00 A DOZEN.

I received your National Standard Squab Book on the evening of the 5th inst. and have studied same over carefully several times and will say that I am perfectly satisfied with it and consider your Manual one of much value and indispensable to one who intends to raise squabs. I expect to order from you in half dozen and dozen lots, until I get me a good flock of breeders. (This I will have to do on account of my limited means and again I am not at my home. I am employed by the railroad company as foreman and my house is 25 miles from my work. However, I am confident that I will be in a position to quit railroad in 12 months from now if I have good luck with birds.) I have an ideal place for a squab plant containing 12 acres of good land and nice dwelling and out buildings. I have also investigated the marketing of squabs in this territory and find that I can get ready sale for all that I can produce at from \$2.50 to \$4.50 per dozen, according to weight and plumpness.—T. H., Louisiana.

THIS ILLINOIS YOUNG WOMAN HAS GIVEN US HALF A DOZEN ORDERS FOR BIRDS BETWEEN 1903 AND 1908. Please find enclosed two post-office money orders for \$125 and send me 50 pairs Extra Plymouth Rocks. My mother's sickness interfered with my plans. I have lost many orders by not having enough breeders. I think it safe to try now.—Miss J. M., Illinois.

HAS KEPT PIGEONS FOR YEARS. PLYMOUTH ROCKS DO BETTER THAN ANY HE EVER BRED. I had 35 pairs of your Extra Plymouth Rock Homers to start with. They are fine birds and very good breeders. I have kept pigeons for years, but yours do as well and in some respects better than any I ever had. I intended to breed them for squabs, but there is such a call for good breeders that I have not had any chance to sell squabs.—A. T. K., Massachusetts.

FIFTEEN-YEAR-OLD BOY EARNING POCKET MONEY FOR TWO YEARS.

About two years ago I bought three pairs of your best Homer breeders and they are getting along very nicely. I am only 15 years old. I am running my business the way described in your National Standard Squab Book. Have you a 1907 copy of this book?—J. A. M., Wisconsin.

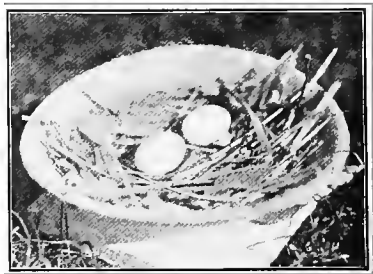

NEST OF STRAW AND FEATHERS.

Some birds build a scanty nest, using only a few wisps of straw, with perhaps a feather or two. A nestbox is an absolute necessity for such pairs, otherwise the eggs soon roll apart or out of the nest box. In April, 1907, a Missouri woman wrote us as follows: "Enclosed find draft for \$11.52, for which please send me one gross of nestboxes. One year ago I started with 40 pairs of Homers. Now I have something over 400 birds. I have lost a great number of eggs, and feel like I must have the nestboxes, as they prevent the eggs from rolling out. Send them at once."

GETTING RID OF COMMON PIGEONS AND PURCHASING PLYMOUTH ROCKS. THE MOST WEIGHTY BIRDS HE EVER SAW.

I have a number of common birds which I am either going to sell, or kill them for my own use, but I will exert every effort to sell them and purchase more birds of you, as I think yours are the most weighty birds I ever saw. As soon as I am rid of what common birds I have on hand now, you may expect my order for some more of your breeders.—T. W., New York.

LETTERS FROM CUSTOMERS RECEIVED BY PLYMOUTH ROCK SQUAB COMPANY

QUICK WORK BY THE NEW FLOCK OF A NINE-YEAR-OLD BOY. I should perhaps have written you earlier of my boy's success with the Plymouth Rock Homers which you sent. One pair were nesting in three days and inside of three weeks there are, I think, ten of the thirteen pairs at work, and if my recollection serves me, inside of four weeks he had ten or a dozen squabs hatched.

It is now nearly five weeks since he had them and some of the squabs are nearly large enough to market. I consider this a pretty good record.—H. C., New York.

Note. The above gentleman is a well-known business New Yorker. His boy is only nine years old.



DIFFERENT SIZES.

This shows two squabs, one of which is growing faster than the other. This means that it is pushing its smaller mate out of the way at feeding time and getting more feed from the parents. In such cases, the bigger one will grow fast and the smaller one will be stunted. The latter should be helped by being taken out of the nest and put alongside a squab of its own size in another nest, the larger squab there being brought back to grow up with a mate of its own size. The parents in both cases do not neglect the new comer.

MARYLAND CUSTOMER SATISFIED AND ENLARGING. On November 27, 1906, I received from you 50 pairs of Plymouth Rock pigeons. I put them into what I considered an up-to-date house, using nappies for nests. I am starting another pen and expect before fall to have 150 pairs of good stock. I feed cracked corn and wheat and I also give the Canada peas when I can get them, a little hemp and rice once in awhile. I am entirely satisfied and when I am in the market for more birds, Elmer Rice's birds will do for me. Thank you for your many kindnesses.—W. B. C., Maryland.

QUICK BEGINNING BY MATED PAIRS. ALL AT WORK WITHIN TWO WEEKS AFTER DELIVERY AND A PAIR OF SQUABS ON HIS TABLE WITHIN SEVEN WEEKS. MORE ORDERS FOLLOW. Within seven weeks from the date of receipt of the birds I ordered from you, I have had a pair of broiled squabs on my table, and such squabs I never saw before. A few days before they were four weeks old, they weighed a pound each.

Some of my pairs went to work within five days and all of them within two weeks after their receipt. It has been less than three months since I received the seven pairs, and I have killed two pairs squabs, and my flock has more than doubled. I think this is a good record. I can readily sell my young pigeons here for breeding purposes at good prices, but as I ordered them to raise squabs for my own table, have, so far, declined to sell any.

Two of my neighbors have duplicated my order since they have seen mine, and I am sure other orders will follow.

I am delighted with the business and take a great interest in my birds, which have learned my voice, and when I go out to the fly, come fluttering at my call. I prefer squabs to chickens, and they are much less trouble, and so much easier to raise.—J. M., Mississippi.

BEST THESIS HE EVER READ ON ANY SUBJECT. I have the pleasure of acknowledging receipt of your National Standard Squab Book and having read it once through and made notations of details (not indexed) at the sides of the pages, I can get the meat of any subject promptly. I want to say (which, of course, must have been said a great many times to you) that "it is bully," it is the best thesis I ever read on any subject. I have tried to think of questions that suggested themselves to me I would like answered, but in vain. You have answered everything. I want to state to any one interested in squabs, surely your Manual is worth its weight in gold.—W. C., Wisconsin.

NEVER WAS TREATED MORE FAIRLY. My birds arrived October 1 in first-class condition, earlier than I expected. Never spent money for anything better. They are regular beauties. I thank you for the extra pair; I never was treated more fairly. Hope to give you a larger order next time.—P. M., New Orleans.

MAN OF FORTY YEARS' EXPERIENCE HAS NEVER SEEN BETTER HOMERS THAN OURS. The birds came safe last night. I told you before, I had some of that sort (a few pairs) continuously, for over forty years. I never had any better and many inferior in fancy points. Accept my thanks.—L. O., New York.

LETTERS FROM CUSTOMERS RECEIVED BY PLYMOUTH ROCK SQUAB COMPANY

MATED PAIRS START QUICKLY. BEST BREEDERS IN A LIFE-TIME OF EXPERIENCE. SUGGESTION FOR CITY PEOPLE. SURE WAY OF MATING. I have received yours of the 18th and am following out your request. About the color, either a blue or a red checker cock will do. I should like to know how I am to get him. I started in just one month ago with my shipment of 12 birds and about five days later, in which time they had to pick up from the fatigue of the journey, a pair of blues were sitting on eggs. This was kept up at intervals by the others until now when I have ten young ones and two eggs, which are being hatched by a pair of flights.

Barring one sick one I can honestly call this a good investment because I have had pigeons since I was ten years old and in that time I have not seen any better done. Should they keep this up, I find the market good, I shall buy some more this spring. You said the *Eagle* and *Sun* had quotations on squabs, but unless it is somewhere else than on the market page, neither of these papers has them. They want a dollar a pair for them in butcher shops.

The Manual is all right, but if you want suggestions I should say that the way you describe for having pigeons in the city is very seldom used. The most popular way is putting a coop and screen on a flat roof or on poles in the yard. This is the way you will see most coops in Brooklyn and New York. However, the way you describe is a very good advice for those with peaked roofs, as I know many people would have pigeons if their roofs weren't peaked. On mating birds I should also tell of a very effectual way I have for mating stubborn pigeons who absolutely refuse to mate. This is to put them in a box or something so that they cannot get any light and leave them so until you think they ought to be taken out and then put them together and in most cases they will be so glad to get back to light and see another pigeon that they will mate right away. Should they still refuse repeat the method until they do, but this method has worked so that I have yet to come across the one I could not mate this way.—H. H., New York.

FIRST SQUABS WHEN TWO WEEKS OLD WEIGHED TWELVE AND FOURTEEN OUNCES. Perhaps you will be interested to know that the first pair of squabs at two weeks weigh 12 and 14 ounces respectively. Am pleased with the weight.—A. T. V., New Hampshire.

ONE YEAR OF PROGRESS. Enclosed find money order for which please send me six dozen wood fibre nestbowls by freight. The Homers I got from you about a year ago are working splendidly.—E. A., Pennsylvania.

MONEY-MAKING STORY BRIEFLY TOLD. BIG FLOCK RAISED FROM SMALL PURCHASE. PROLIFIC BREEDERS. If you remember, I bought from you in the autumn of 1906 12 pairs of squab breeders. One pair went to work the second day after arrival, the others following in close order. In two weeks every pair but one had eggs. I now have (October, 1907) 576 pigeons, two pairs having raised 11 pairs per year, the others nine and ten. I feed cracked corn, whole wheat, hemp seed, barley, kaffir corn and rice. During the moulting season I feed a good quantity of hemp seed. I think the squab business is a very good money making enterprise if well attended to.—R. F. S., New York.

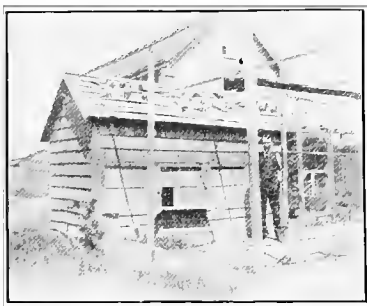

AN INEXPENSIVE START.

TWO YEARS' SUCCESS. GOING TO SHIP TO BIGGER MARKET. I am now raising more squabs than our local market demands at reasonable price and in order to obtain good prices must find market elsewhere. Can you put me in the way of same? I bought my first Homers of you in August, 1905, and have had remarkable success with pigeons, having lost but 15 that were able to fly, in all the time since then. I will feel very grateful for any information you may be able to give me. Also kindly quote me price on 50 pairs Plymouth Rock Homers, as I think of adding another loft.—C. H., Wisconsin.

ALL PAIRS AT WORK QUICKLY. PLYMOUTH ROCKS RECOMMENDED ABOVE ALL IN DELAWARE. My Homers arrived safe and I am certainly pleased with them. They are all mated and I expect eggs soon. I recommend your birds above all. I told several parties about my birds and I think they will give you an order.—R. W., Delaware.

LETTERS FROM CUSTOMERS RECEIVED BY PLYMOUTH ROCK SQUAB COMPANY

LAYING AND HATCHING WITH TEMPERATURE FIFTEEN DEGREES BELOW ZERO. My first pair laid and hatched out squabs which grew the fastest of anything I ever saw. When the eggs were laid and the birds were hatched it was 15 degrees below zero half of the nights (February, 1907) and the water in the fountain in the squab-house froze hard every night. My first young birds are about as large as the old birds (April) and are flying just as easily, I think, as the old birds.—M. S. B., New York.

Note. The old pigeons protect both the eggs and the squabs more closely in cold weather. They adapt their attention to the climate. Do not fear that you cannot raise winter squabs, even if you live in the coldest parts of Canada.

NOT ONE SICK. NO LICE. My pigeons are getting along very nicely. You sent me 13 pairs last December and now (July, 1907) I have about 30 pairs. Not a one has been the least sick, and have not been troubled with mites nor lice among them as yet. Will soon have to double the size of my house. I attend to them myself.—M. V. B., South Carolina.



A ROW OF BEAUTIES.

SELLING IN ST. LOUIS FOR \$4.50 A DOZEN. You will find enclosed herewith an order with remittance for 55 pairs of your Extra Homer pigeons, which I hope to receive as soon as possible. You will find also that I send order for various other supplies which, if you think it will be cheaper, you will please send by freight.

The pigeons I purchased of you last year are doing nicely and have produced some fine, large squabs. They are selling in St. Louis for \$4.50 per dozen. Thank you for fair dealing in the past and wish you success in the future.—R. C. H., Missouri.

THREE ORDERS FROM ONE TOWN. Enclosed herewith I send you check for which please send me seven pairs of Plymouth Rock Homers. I ordered seven pairs from you a short time ago, and also had Mr. McRaven duplicate my order.—J. B., Mississippi.

GOING TO TRY IT AGAIN. Please send me your printed matter as soon as you can. I had some of your Homers a year ago and they did very well. I expect to buy some more.—J. J. R., District of Columbia.

CHICAGO MAN REPLACING HIS FIRST BIRDS WITH PLYMOUTH ROCK HOMERS AND BUILDING A LARGE PLANT. Your letter of October 28 at hand. Please send me the female as soon as possible as I can mate her with the other male. I still have the birds in the crate but will empty it Saturday. I am building now to accommodate 500 pairs of birds and have torn down my old coop so I have not had place to keep my birds. I am building it in units of 50 pairs to each unit. Am getting rid of my common birds as fast as possible.

From March first to the present time (October) I have 38 youngsters from my original six pairs, three pairs of which were No. 1 and three pairs Extra. Both birds bred alike, with the exception of the Extras breeding a much larger squab. Eleven pairs of youngsters have eggs at present. I have lost none and with the exception of the moulting season, I think I have done fairly well. I have not sold any as yet, but have been asked to. Not wishing to sell any until I have 50 pair, I had to refuse the order, but referred him to you. People who have seen my Homers think well of them and I believe I have a few interested.—A. S. C., Chicago.

TRIED TO GET ALONG WITHOUT THE INSTRUCTION BOOK AT FIRST. I have bought two sets of Extra Homers of you, but have had bad luck. I do not have any now. I am going to read up on the care of pigeons before going into it again. I have your National Standard Squab Book of 1905 and think that it is very well written and it contains some very sound advice, which if I had followed I never would have failed. Is the 1907 edition different?—I. H. O., Iowa.

EVERY PAIR BREEDING SHORTLY AFTER ARRIVAL IN FAR WEST. I received seven pairs of Plymouth Rock Homers the first part of April and now (May 20) have five pairs of squabs a week old and the other two pairs are setting. I am well pleased. Strong, healthy birds. It is a wonder the way the young squabs grow.—R. R., State of Washington.

LITTLE LOT GAVE HIM CONFIDENCE TO BUILD AND ORDER MORE BIRDS. The three pairs of pigeons I received from you in January are doing finely (April, 1907), and I would like to have you send me one of your plans for building, and as soon as I have the plans I will send to you for some more pigeons.—R. S., Chicago.

EXACTLY AS REPRESENTED. The breeders I got from you are first-class and exactly as you said they would be, and are well. Please send me prices on grit and other supplies, also on 12 pairs breeders.—W. J. W., Pennsylvania.

TWO CUSTOMERS WHICH HAVE BRED LARGE FLOCKS FROM SMALL BEGINNINGS. Mr. Bartholemew of this place has about 250 birds which he has bred from six pairs of No. 1 Plymouth Rock Homers which he says he got of you. I notice the difference between the Extra and No. 1 Homers. Mrs. Virkler has about 150 birds of Extra Plymouth Rock Homers bred from six pairs.—C. W. B., New York.



EATING FROM HIS HAND.

The California man who owns these pigeons writes: "They are beauties and breed fine squabs. I have bred squabs from your Homers weighing a pound apiece. Your Manual is straight and true."

RECOMMENDED VERY HIGHLY BY A LOUISIANA FRIEND. Enclosed you will find a money order for which you will please send me by express six pairs Plymouth Rock Homers No. 1 mated. I trust you will make me a good selection, as I am expecting to raise pigeons and wish the best. You have been recommended very highly to me by Mr. Joseph Malbrough, as he has ordered the Plymouth Rocks from you.—H. H., Louisiana.

SQUABS WEIGHING FROM SIXTEEN OUNCES TO NINETEEN OUNCES EACH. OUR STOCK AND OUR SELF-FEEDER GET THIS RESULT IN TEXAS. I bought six pairs of Extra Plymouth Rock Homers from you last November, and I now (May, 1907) have 31 in all, and 17 youngsters. Four pairs have eggs. Out of the 17 squabs, I lost only one, the death of that being caused by one of the parent birds stepping on one the day he was hatched. My squabs have weighed one pound to a pound and three ounces.

I have built a pen for my young squabs as you advise to do, and I find that they do very much better.

The things that I find most necessary are, to have a clean house, water and feed, so I clean my squab house every two weeks, and have clean water and feed always. I use your self-feeder so the pigeons can feed their young whenever they choose.

The ground of my flypens is covered with sand, and I renew it every month. I also use oyster grit and rock. It is placed in the squab-house, where they can get it any time they want it. I feed wheat and kaffir corn and a little cracked corn now and then, but they do not need much corn as the weather here in Texas is warm nearly all the year around.

I think your Homers are the best I ever saw, and every one that sees them says the same thing about them.

Any one starting into squab raising should buy your Manual. I have been trying to follow it as nearly as possible and by doing so I think I will succeed in raising squabs.

I intend to order more pigeons of you at once.—F. S., Texas.

SUCCESSFUL BREEDING BY THE SISTERS OF A CHICAGO CATHOLIC HOSPITAL. Please send us 36 pairs (January, 1907) the same as you did the four pairs a short while ago. Kindly send the very best breed only.—Sister M. M., Illinois.

Note. In September, 1907, we shipped 36 pairs more Extra Plymouth Rock Homers to the above customer, who is the sister superior of a well-known hospital in Chicago.

NEW JERSEY FRIENDS SATISFIED. Enclosed please find check to cover order for 24 pairs Extra Plymouth Rock Homers and supply of feed. We know your dealings have been square with friends of ours in New Jersey. We have plenty of ground here and everything going right. Will soon have the other houses finished up.—G. M., Massachusetts.

INCREASED FIVE-FOLD IN SIX MONTHS. Regarding the ten pairs of birds I bought from you last spring, I now (November, 1907), have 52 pairs.—C. V., Ontario.

LETTERS FROM CUSTOMERS RECEIVED BY PLYMOUTH ROCK SQUAB COMPANY

WISCONSIN HOTEL PAYING \$3.50. SQUABS WEIGHING TEN AND THREE-FOURTHS POUNDS TO THE DOZEN. I thought I would write you a few lines. I want to buy some more birds from you, seeing I am getting along so nicely with the others you sent me. I am getting \$3.50 a dozen at the Plankaton House. They weigh ten and three-fourths pounds to the dozen. He said they were some of the best squabs he had ever seen. He wants me to come down some night to have a little talk with me. I want to get a basket of birds from you in about a week and about three dozen of nest bowls and a couple of weeks later, some more birds, if everything goes all right. I have some fine young birds, some of them weighing a pound apiece. I find out that you are a nice man to deal with and that everything you say is all right and that the birds cannot be praised too much. Guess I will close, hoping everything is going good.—S. H., Wisconsin.

STEADY GROWTH IN THREE YEARS. ORDERS FOR SQUABS OUTFRAN BIRDS, SO MORE ARE BOUGHT. I am going to send soon, before February (1907), probably in a week, for 50 pairs of Plymouth Rock Homer squab breeders, and want to engage them at once, before the February trade begins.

I bought of you six pairs three years ago, since then 12 pairs, 18 pairs and 12 pairs again. (Four orders.)

I do not yet have enough for the orders. The birds are doing better constantly. Their houses are better, and I know more how to care for them, and what things are important. Have almost finished a house—all but nests and a little finishing of yard. It seems as if it would be a good plan to get birds now before the really cold weather comes. I want the Extras, best you have.—M. I., Illinois.

LIVELY WORK IN MISSOURI AND THE LARGEST SQUABS EVER SEEN. I am in receipt of my six pairs Extra pigeons and am very thankful to you for the care you have taken in sending these to me. I had them just one week when two pairs had eggs, and I was so surprised, but yesterday I was still more surprised when I went into the pigeon house and found four pairs setting, and two of these had young squabs. Every one of my neighbors is surprised to see the nice pigeons you sent me. Mr E. C. Rice, I will in every respect recommend your goods very highly and I am sure that you will appreciate it. These squabs are the largest that I have ever seen. I will have one of my friends take a snap shot of my pigeon house and send you a picture.—E. B., Missouri.

MORE ORDERS FOR SQUABS THAN HE CAN FILL. HOW TO FEED SUNFLOWER SEEDS. I am thinking about planting a batch of sunflower seeds. Will you please let me know if this is a good feed for them, and how to feed it—either fresh from the stalk or pick it and let it dry. It would be a great saving to feed this during the winter for me. The pigeons bought from you are O.K., doing their duty. I have more orders for my squabs than I can fill and getting 35 to 40 cents apiece. I do not do any plucking. My pigeons are doing fine considering being locked in all the time.—W. S., New York.

Note. Sunflower seeds are good for pigeons, being used largely as a substitute for hempseed. Cut off the heads when grown and dry them. When you wish to feed a head, throw it into the pen whole and the pigeons will pick out the seeds.

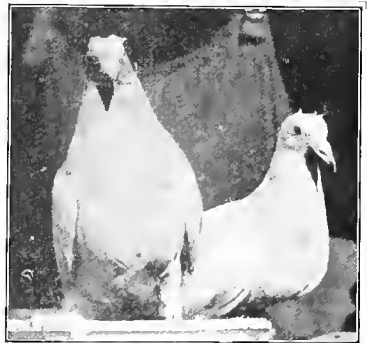

READY TO KILL

These squabs are four weeks old. See how plump and broad-breasted they are.

FLORIDA FRIENDS ENTHUSIASTIC OVER PLYMOUTH ROCKS. I have a friend who is very enthusiastic over my pigeons. He will send you an order the first of the coming week for 48 pairs of your Extra Plymouth Rocks such as mine. Do your best for him. Of course he expects to get two extra pairs thrown in as a premium. My birds are getting along very nicely.—W. J. D., Florida.

HAS HEARD FROM HIS FRIENDS. I have heard from several of my friends about your birds, stating they were very fine. I want to get some of your stock.—S. W. H., Kentucky.

WOULD NOT TRADE HIS PLYMOUTH ROCKS FOR ANY IN HIS MONTANA TOWN. I have had fair luck and in all the Homers in town from different companies, I would not trade the ones I got from you for any of them. Friday noon, April 12, by carelessness, some boy friends in going from the coop let one of my fine red checkers out, which I would not have parted with for \$2. He rose into the air and after circling once flew away faster than I ever saw a pigeon fly before. In discussing the matter with some people, they think he will come back, but he has not. Others think he has gone back to you.—M. S., Montana.

Note. Letters like the above come to us constantly. Guard your doors carefully. Have springs on them so they will close without attention. Homers which you raise you can safely let fly, because they know no home but yours, but Homers which you buy will fly off.



SQUABS 25 DAYS OLD.

Note that although they have been in the bowl since hatching, it is comparatively free from manure. They back up to the edge of the bowl and void into the nest box. It is the nature of pigeons to try to have clean nests, and they should be given a chance by the use of nestbowls.

NO CONCEPTION OF THE BEAUTY AND SIZE OF OUR EXTRAS. I received the birds last evening, just 24 hours after my order was sent in—prompt work, that. After having read your Manual and a great many testimonials, I was expecting some fine birds, but find I had no conception of the beauty and size of your Extras. The compact bodies, rich, healthy color and uniformity of size were a thorough surprise. I am going to follow your directions given in the Manual, and you may count on me as a customer to the extent of my means.—Mrs. M. F. C., Massachusetts.

PLYMOUTH ROCK HOMERS IN DEMAND IN THIS GEORGIA TOWN. Enclosed find my check. Send me by express six pairs Extra blue-barred Plymouth Rock Homers, mated. I have about got this town started on raising pigeons. Mr. Barnes, my brother-in-law, has just handed me your new circular. He tells me he has ordered 12 pairs from you. I hope you will ship him some nice birds. His son has just bought some birds from the _____ and I want the birds you ship me and his father to make him regret that he did not order them from you. I ordered blue-barred birds from another party some time back and they sent me checkers. If I did not think you would send the order as I am sending it in, I would not send it to you.

You remember I bought a few pairs of birds from you a little over a year ago. I have sold a great many birds and I have about 100 to 125 pairs of working birds on hand now. I am building me another pen that will hold about 200 pairs.—R. H. N., Georgia.

RAISING PLYMOUTH ROCK STOCK ONLY. BEST BIRDS EVER SEEN ANYWHERE. The birds came yesterday all O. K. and were fine birds, and the hen with a little age will also be on top. Please accept my thanks. What I especially wanted was solid reds and when you do get hold of such a pair that is A No. 1, send them to me and send me the bill. I am raising strictly Plymouth Rock stock and have developed some A No. 1 birds, the best I have ever seen anywhere, and so I swear by E. C. Rice stock. You state that not one in 100 birds are solid reds. I know this to be a fact. When I do go into the show I want to have the best of all colors and they shall be Extra Plymouth Rock stock.—R. B. W., New York.

OUR WHITE HOMERS COMPARED WITH OUR COLORED HOMERS. I do not know of a man I would trust any quicker than you. I would like to know if you have pure white Homers that are as large, plump birds as your colored ones are.—G. M. L., Vermont.

Answer. We charge \$2.75 a pair for our white Homers. They are fine birds, as large as any white Homers in existence, but are not so large as our Extra colored Homers and do not breed so large a squab. They cost more because they are scarcer; we sell a lot of them for pets, for their handsome plumage, and for undertakers.

PROLIFIC PLYMOUTH ROCKS HAVE BRED MORE SQUABS THAN ANY PIGEONS HE HAS. I came down to see you quite awhile ago and bought a pair of your Plymouth Rock Homers. Those Homers have bred more squabs than any other pigeons I have, and I have a good many. Will you please send me your catalogue of prices.—T. C., Massachusetts.

LETTERS FROM CUSTOMERS RECEIVED BY PLYMOUTH ROCK SQUAB COMPANY

FIVE MONTHS' WORK. SMALL FLOCK QUADRUPLED. ONE OLD BIRD AND TWO SQUABS ONLY LOST BY DEATH. BREEDERS OF COMMON PIGEONS MYSTIFIED.

I write you a sort of detailed statement of how my four pairs of pigeons have done, that I bought from you about the middle of May, 1907. One of my birds laid in about two weeks after her arrival, but the eggs did not hatch, and she laid again in about ten days after I found her eggs were not good, and that time she hatched all right. Two other pairs commenced work soon after the first, and both of them hatched all right and the first three pairs of squabs did well. I have lost one of the hens that I bought from you. She died after raising a fine pair of squabs. I have lost two squabs.

I now have 18 birds in all, after deducting the three that I lost. All of my birds are now (October) at work, some making nests and some sitting.

Mine are the only Homers in this part of the country that I know of, and every one who sees them is charmed with them.

There are one or two parties here who are trying to raise the common pigeons on the same plan, that is by confining them, but are not doing much, and cannot understand why my birds do so much better than theirs. They say that if I make a success of the business they will then try Homers.

I am very fond of the business and find it a great recreation, and very little trouble. I attend to my birds before breakfast in the morning and give them plenty of water, and then at dinner time I feed them again, and that does them until next morning. They are less trouble than anything of the kind that I ever had anything to do with, and I believe will be more profitable according to the amount of capital invested.—C. A. F., Mississippi.

SECOND ORDER, BIRDS DOING WELL, ANOTHER ORDER IN PROSPECT.

I herewith enclose you \$1 in currency, for which please send me 50 open legbands for grown pigeons, numbered one to fifty. The last shipment of pigeons came to hand on the second in good shape, and are a nice lot of birds. I am well pleased with them. My birds are all doing well. I think that I shall give you another order soon.—F. R., Mississippi. (The first shipment to this customer was made in April, 1907, the second in October of the same year).

GREAT DEMAND FOR PLYMOUTH ROCK SQUABS IN NEW JERSEY.

I received on May 27, 1904, one dozen pairs of your birds and I have 200 birds at the present time. There is a great demand for Plymouth Rock squabs in New Jersey. Please send me your price on 50 pairs of your best Extra mated birds.—N. L., New Jersey.

FAST START IN TWO WEEKS IN NEW JERSEY. On April 22 I wrote you informing you of the arrival of the birds. Now (April 29) there are two nests complete and six others being built, which I should think was pretty good work for birds not yet two weeks in a strange place. The birds have been highly praised for their fine appearance by a number of friends and acquaintances of mine, and of course the natural question was, where did I get them? And as I am a pretty good advertiser for any one that I consider to be worthy of such advertising, I have recommended your company as the right one to go to if they have any idea of investing.—J. H., New Jersey.

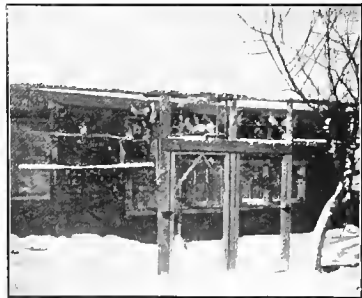

IN THE SNOW.

Let them out on sunny winter days. In cold, stormy weather they are better off inside.

FINEST BIRDS THAT HE EVER SAW IN LOUISIANA, RESULT, MANY MORE ORDERS. I received my birds Saturday evening, November 2, at 7 p.m. Found them all in A I shape and are the finest birds I ever saw. Please accept my most sincere thanks for the extra pair and for your nice selection. I will return your basket one day this week, will take bill of lading for same from express agent and forward to you date I return same. I will send you an order for 12 pairs more about the 25th of this month. I want to order a small shipment each month until I get about 100 pairs of breeders.—G. W. T., Louisiana.

PERFECTLY MATED IN WEST VIRGINIA.

I write to tell you how well my pigeons are doing. I am very well pleased with them as I believe they were perfectly mated and went right to work after they were in the loft not more than a week.—J. N. M., West Virginia.

EVERY PAIR AT WORK IN DOUBLE-QUICK TIME. BUILDING UP A PLANT. I think a few lines to you is my duty. I expected to be at your office and plant before now. My young son got struck by a trolley car about the time I was going to go to Boston, and just escaped very serious results, so I have stayed pretty close at home, but have a vacation in July and will call on you then.

About the birds, they are doing fine. They went to work at once and some of them are now on their third lot of eggs. They held their matings, every pair. I feel very much encouraged and appreciate your fair and honest business principles. You will receive orders from us in the future as we are going to build up quite a plant.—H. I. L., Massachusetts.



SQUABS THREE WEEKS OLD.

BRANCHING OUT FROM A SMALL BEGINNING AFTER SUCCESSFUL EXPERIENCE WITH PLYMOUTH ROCK HOMERS IN UTAH. I have decided to go into the squab business on a large scale and when my business interests are cared for will move to Salt Lake City where I hope to work up a good business. The birds purchased from you have been very satisfactory in every particular and my business in the future will be done direct with your good company. My health is poor through confinement and I am determined to try squab raising for the purpose of making a success and money.—W. B., Utah.

SQUABS AS A SIDE LINE. Please send me two dozen wood-fibre nestbowls by express. The birds I received from you April 1 are all working satisfactorily (May 13, 1907). I do this as a side issue. I work in the factory all day and take care of my pigeons nights and mornings, and find it very pleasant work.—E. D. D., Massachusetts.

TEN PAIRS OF SQUABS A YEAR FROM ONE PAIR. MARKET BROADENING AND DEMAND INCREASING. The pigeons that I bought from you are doing nicely. Most of them seem to be in good condition and keep steadily at work. One pair raised ten pairs of squabs a year and there are others that almost equal them. I began last fall to save those from the best breeders. I had to keep them in the house with the older birds because I had nowhere else for them to stay. They disturbed the pigeons through the winter, but they are mating and getting to work now.

I sell all the squabs I can raise to one of the local marketmen. At first there was no sale for them except in summer when wealthy people from the larger cities are sojourning here, but he bought all I had last winter. (See note below.)

When ready for market they weigh from two pounds to two and one-half pounds a pair. They are white and fat and the dealer has complimented me a number of times about them.

I find the business very interesting and would like to engage in it more extensively if I could get more time to devote to the birds, but it is impossible to do so at present.—Miss M. D., Connecticut.

Note. The squab market has broadened tremendously since we first began advertising in the high class periodicals advising people to eat squabs as well as raise them. This habit of eating squabs has a steady hold all the year round on thousands of families who ten years ago did not know what a squab was. This demand is increasing every year. In spite of the steady growth in production of squabs, the prices are as high, and in many cases, higher than ten years ago.

DELAWARE MAN FINDS IN OCTOBER, 1907, THAT NEW YORK MARKETS ARE HOLDING GOOD. PRICES ARE LIKELY TO GO HIGHER. I received your Manual yesterday and am very much pleased with it and stayed up until 1.30 last night reading it. I believe that if I follow your instructions and make up my mind to make a success of it, I will be able to do it. I knew a little about pigeons before, as my brother and I kept a flock of common pigeons when we lived in Long Island City, but had to move to New York City and had to do away with them.

I have a few mongrels on hand now and am experimenting a little, but as soon as able will send you an order. It will not be very large, but if your stock is as good as represented (like your Manual) it will be all right.

I have written to New York markets for prices and find they are still holding up good and I believe next year they will go higher. Hoping you the best of success.—N. H. C., Delaware.

LETTERS FROM CUSTOMERS RECEIVED BY PLYMOUTH ROCK SQUAB COMPANY

OTHER HOMERS HAVE NOT THE QUALITY OF PLYMOUTH ROCK. SQUABS WEIGH FIFTEEN OUNCES, FEATHERS OFF. On December 22, 1906, I bought three pairs of Extra Plymouth Rock Homers from you, and since then have had considerable luck with them. They are the best pigeons for breeding as well as for fancy I have yet seen. I've seen other Homers similar to those I have but they have not the quality of the Plymouth Rock. They weigh at the age of four weeks on an average 15 ounces, dressed, and are the finest pigeons for eating purposes that can be had. When I received the pigeons I knew but very little about them; but after following your Manual carefully I found results as stated, and will say it is worth double the amount I paid for it. I also made a feeder as shown in your Manual and think it is the proper thing for pigeons as there is but very little waste in feed. Out of the three old pairs I raised 28 squabs, losing but very few during the winter. I now have six pairs left which I am going to keep for breeders. The others I have been selling to friends here right along. I get from 50 to 75 cents a pair at the age of two months. I now (September, 1907) have a larger and better place for them and find they are breeding a little better. They require but little care and are a great pleasure for pastime.—E. W., Missouri.

NINE HATCHES IN TEN MONTHS IN BRITISH COLUMBIA. WOMAN HAS NOT LOST A BIRD, OR HAD ONE SICK. Please find enclosed the sum of \$2.90 postal note for which send me three dozen of your wood-fibre nestbowls by Dominion Express Co. Also if you would send me your price list I should be greatly obliged. I am quite well satisfied that your pigeons are all that you claim for them as to breeding qualities. I have one pair of the eight you sent me last May which have had nine hatches in ten months, and the others were never far behind them, and now I have quite a number of the young ones mated up and raising young. For a fine appearance I do not think there is anything in pigeons could beat them. Have followed the directions in your book and I have not lost one bird or had one sick. I quite expected to have sent you an order for more breeders before now, but I have had my husband sick a great deal this winter and funds would not permit of it, but I hope to send you one before long.—Mrs. A. O., British Columbia.

EVERY PAIR HAS EITHER EGGS OR SQUABS IN CALIFORNIA. I am more than pleased with the way my birds are turning out the squabs and intend placing an order for more breeding stock soon. Every pair has either eggs or squabs and some have both.—I. L. T., California.

EARNING POWER OF SMALL FLOCK INCREASING AT NO EXPENSE. We received our birds March 24, 1907. We had 25 pairs. They started to work in about three weeks and we had the first squabs about the 10th of May.

We have now (November 7, 1907) 120 young birds, and of these young birds we have five pairs that are working. Two pairs have already had young ones. Our entire expense for feed to date has been \$36.52.

Our expense for fitting up has been \$140, not including price of birds. We figure that we have not made any money this year, and still we have not lost any, and think with more birds and a better knowledge of the business there would be good money in it.—F. E. B., Connecticut.



SQUABS TWELVE DAYS OLD.

POSTMASTER'S GOOD PROGRESS IN TWELVE MONTHS. I felt like it was my duty to write you a few lines. Just one year ago to day since I received my birds from you, seven pairs Plymouth Rock Homers. I now have 18 squabs, and 40 birds that can fly around in the pen. That makes 58 in all. I think that is doing remarkably well for 12 months' time. I am also trying to raise poultry. I have a fine place here for that purpose and thought that I could attend to that between times. I am postmaster here. After I get started and there is good money in it, I will sell out my store and do nothing else but raise squabs and poultry.—F. L. H., Illinois.

USED GRAPE-VINE STICKS FOR NESTING MATERIAL. The pigeons bought are doing well. The flying pen is covered with grape vines. I neglected to put in any nesting material. All the pigeons have squabs, so they used great grapevine sticks, some as large as my finger.—W. E., Massachusetts.

LETTERS FROM CUSTOMERS RECEIVED BY PLYMOUTH ROCK SQUAB COMPANY

STRONG MATINGS LAST TO THE STATE OF WASHINGTON AND SEVEN PAIRS OUT OF FOURTEEN HAVE EGGS WITHIN TWO WEEKS, REST DRIVING. Received your shipment of 14 pairs of Homers about two weeks ago. There are seven pairs of them on eggs today and the rest are all driving. They were all in first-class condition except one cock, which seemed to have had his neck hurt, as he could not hold his head up nor eat anything, and he died. Thank you for your promptness and the two pairs free.—H. G. M., State of Washington.

VERY SUCCESSFUL WISHES TO BUY MORE. Could you tell us of a place where we could sell our pigeon manure? We have some four or five bushels. We have been very successful with our Homers. Starting with 12, we now have about 60 or 70. We want to buy some more breeders.—G. P., Missouri.



SQUABS A FEW DAYS OLD.

KENTUCKY WOMAN'S SUCCESS WITH FAST-BREEDING PLYMOUTH ROCKS. About 18 months ago we purchased from you six pairs of your Extra mated Homers, each pair a different color. These birds have done extra good work for us and have been more than satisfactory in every way. We have on hand now about 50 mated birds and about 100 youngsters; some of which ought soon to mate. The birds are all in good condition, moulting, but in spite of that some are still at work.—Mrs. C. P. M., Kentucky.

ALL MATED, QUICK IN GETTING TO WORK IN DISTANT TEXAS. The pigeons that I got from you last Thursday are getting along just fine. Two pairs have nests and as far as I can see they are all mated. The Extra hens, it took them just about a week, which is fine. The Wells Fargo would not ship the crate collect on delivery, so I paid them ten cents for shipping. I am well pleased with the birds.—G. J. W., Texas.

SQUABS TWICE AS LARGE AS THOSE FROM HOMERS FROM ORDINARY SOURCES. My birds purchased of you have been doing splendidly, under rather adverse circumstances because of the lack of care occasioned by my constant absence from home. Since entering into the business, I have taken special note of different pens in various parts of the State, of pigeons purchased elsewhere, and find to my entire satisfaction that none are as fine or finer than my birds. I have been unable to keep an exact tab on the rate at which they breed but I notice that certain pairs exceed others in this capacity and have been exceedingly satisfactory.

As to size of squabs, I can best tell you in the words of one of my customers upon her first purchase: "Why, Mr. Cantey, I never saw such large, fat things in my life. I had to stuff and bake them, instead of broiling. They are twice as large as any I have been getting elsewhere. I wouldn't mind if they were smaller." This is her unvarnished statement. I will send you a photograph of my pen in a few days.—H. C., South Carolina.

OUR MATED PAIRS GO RIGHT TO WORK IN KANSAS. I have delayed writing in order to see how the birds were going to turn out. Can say that I am very much pleased with them. They were delayed in Junction City from Saturday until Monday, but arrived in good shape. One male had its eyes pecked until it couldn't see, but I took it out and bathed the swelling and it was all O.K. in a few days. I have four eggs and three more nests are being built, so you see they are going right to work. I have them so tame that I can hardly keep from stepping on them when I go into the house. I will probably want more the first of the year and if I do I will certainly order from you.—C. E. T., Kansas.

VIRGINIA CUSTOMER A STEADY BUYER. I enclose check for ten pairs blue and blue checker breeding pigeons. Ship per Adams Express to me. I intend to order in lots until I have 300 pairs. My old birds are doing well. I now have 18 pairs including squabs.—H. T. I., Virginia. (This customer's first purchase was eight pairs, shipped in June, 1907. At this writing, November, 1907, he has sent in four more orders. His wife gave him a birthday surprise by ordering 20 pairs which we shipped so that they reached him on his anniversary.)

NO SUBSTITUTES WANTED, BUT SOMETHING JUST AS GOOD. I want to make another order by the 25th of this month (October, 1907). The last pigeons you shipped me were beauties and I would like to have some more just as good.—C. O., Alabama.

LETTERS FROM CUSTOMORS RECEIVED BY PLYMOUTH ROCK SQUAB COMPANY

BIRDS WELL-MATED, WENT TO WORK AT ONCE. ONE OF HER SQUABS WEIGHED ONE AND ONE-HALF POUNDS. HER HOUSE WAS ON THE GROUND AND RATS GOT AT THE SQUABS.

I bought my first pigeons of you and put them in my house on March 21, 1907. They were in fine shape and every one thought them the handsomest birds they had ever seen. I had 25 pairs. I think my first squab hatched April 21, and about all the birds were at work then, I think. I had my first two squabs on my own table and one of them when all dressed ready for baking weighed one pound and a half. Can any one beat that? I have not kept account of the number I have sold, but could have made a good thing of it if the rats had not got in. I sell them here in Scituate to the butcher for 20 cents apiece. While I was away this summer the one that took care of my birds for me sold a number of pairs of squabs to breed from for 50 cents a pair. I shall sell no more at that price. I have followed your Manual as nearly as I could in regard to feeding the birds and find my birds are big and fat and I have not had one sick one among them all. Neither have I been troubled with lice. When I came home this September I took account of stock and found that I had just 16 pairs of birds left. You see the rats did us great harm, but we had the house raised and now I am sending for ten pairs more of the Extra Homers and hope to make a good thing of the squab business after this. I shall keep an exact account of all my birds. There are a number of people around here that keep pigeons, but I think mine are the best birds of them all. Those that see mine want to have birds of the same kind. I think you will have some orders soon if you have not done so already from some that have seen mine and want birds like them. I got my birds to make money with and I am going to do it if it is to be done. And I am sure it is. I think your Manual is a fine thing to have if one is going to do anything in the squab business. When I want to know anything about the business I always look in the Manual and I can most always find my answer. I should not want to get along without the book.

Enclosed please find post-office money order for the ten pairs of Extra Homers and other goods I sent for. I wish to thank you for the extra pair of birds you so kindly offer to send. I hope to send for more birds before many months if these do well. I took a picture of my pen with some of the birds in it to-day, and if good will send you one.—Mrs. J. H. H., Massachusetts.

Note. Rats burrow in the dirt and raise their families in these holes. When the floor of the squab-house is on the ground, the rats breed out of sight and out of reach, then they

get into the squab-house quickly. As we say in the Manual, the floor of the squab-house must be elevated two feet, then there will be no rats, for they will not start breeding in the open air under such a house.

LOST ONLY ONE OLD BIRD AND ONE SQUAB IN FIVE MONTHS' BREEDING IN MISSISSIPPI. Please let me know what you will let me have about four pairs of first-class pigeons for. My pigeons are doing finely. I have 16 now (September, 1907), just twice the number I bought of you in April. I have lost one of the old ones and one of the squabs. I have enlarged my quarters and want to enlarge my flock somewhat. I have one pair setting and two pairs have just raised a pair each and are ready for business.—C. A. Mississippi.



NEST OF TOBACCO STEMS.

Some birds build a neat, compact nest like the above, and like tobacco stems to work with.

GENEROUS AND HONORABLE DEALINGS. I received to-day by mail a leg-band outfit complete, with which I am very much pleased, and wish to thank you very much for same. If at any time I can do anything for you, don't hesitate to acquaint me of it, as I would like to show my appreciation for your generous and honorable dealings with me. My pigeons are all doing finely and I have quite a bunch of fine young birds. Thanking you again for your kindness and extraordinary promptness.—W. G., New Jersey.

SICK BIRD REPLACED. I received your postal today and was agreeably surprised to hear that you are willing to replace our sick bird. I hardly expected to receive such honest treatment. It is a relief to find an honest man these days. That bird we wish to replace is a hen. All the other birds are getting along finely.—F.A., Massachusetts.

RAPID BREEDING, CONTENTED MIND AND A CLEAR RECOMMENDATION FOR PLYMOUTH ROCK HOMERS. This is the first time I have had occasion to write you for a year, so here it is briefly. Being a business man myself, I know the value of time. I put 21 pairs Plymouth Rock Homers in loft August 6, 1906. Have sold and eaten ten and one-half dozen squabs. Have on hand to-day, October 8, 1907, 80 pairs mated breeders and near the end of the moulting season. I have about a dozen not ready for market and about a dozen pairs of eggs, divided between two lofts, 40 pairs in each and outside of fear of rats. I have a contented mind and a clear recommend for Plymouth Rock Homers.—W. T. P., Ohio.



RAISED FROM PLYMOUTH ROCK EXTRAS.

In sending the above picture he writes: "The parents I got from you. I refused ten dollars a pair for one pair this winter. I have seen several large squab ranches in Delaware but on all of them I never saw any birds that could throw such birds as those sold by you."

MONTANA MAN LIKES OUR STYLE OF DOING BUSINESS. Received your notice of shipment of birds yesterday (Sunday 29) and received the four pairs of fine Extra Homers to-day (30th) all in good shape. They are all fine birds and we are much pleased with them. It was very kind and generous of you people to send an extra pair free of charge, and also drinker and bowls as we did not expect either. If this our first venture proves successful, you can rest assured you shall hear from us again. I like your style of doing business.—H. S. C., Montana.

A TREAT TO BE TREATED WELL. The eleven pairs of birds (second order) arrived here yesterday and all in first-class condition. I shall place another order shortly, as I have to complete the buildings, and I am highly pleased at the manner your firm does business. It is a treat to know that one's order is filled satisfactorily.—J. N., Virginia.

SQUABS SOLD TO HOTEL FOR FIFTY CENTS A PAIR IN KENTUCKY. I received your shipment of six pairs of Extra Homers, all in good condition; thank you for the Extra hen. This was the finest lot of Homers I ever saw in size and plumage, which is so uniform that it is hard to tell one from the other. I will send for another order some time next month. I sold three pairs of squabs this morning at 50 cents per pair to the hotel, and they say that my squabs are fine. (Later.) Find enclosed money order for which send me six pairs of your Extra nest-mated Homers, checked and uniform in plumage. Every pair I have are working and some have two nests; one has three young squabs, which I think is unusual.—A. H., Kentucky.

FIVE YEARS OF SUCCESS BY A NEW YORK STATE WOMAN. In October of 1902 I sent you a check for \$102.75 for pigeons. My pigeons have done very well. I ship to New York each week. I have just been reading your new squab book of 1907 and would very much like the address of the firm you quote in appendix on page 141 and top first column page 143. Kindly send it to me thereby helping an old customer. Also kindly send me price of the new drinking fountain spoken of in your Manual. I need three new ones and if satisfactory as to price will buy of you.—Miss O. W., New York.

STOCK DOUBLED IN MOULTING SEASON. We have sent you to-day an order for grain for which we hope you will send as soon as possible. We bought stock from you several times, the first order sent in about June 1. Since that time (three months) the stock has doubled. We expect to place a large order in the spring along about March. We have about 75 birds in stock at present and started with a stock of 32. We shall have to have a few white birds in our next order. What is the price of the white stock at present? Hoping you will send us the grain soon.—C. & F., Massachusetts.

FAST NESTING BY MATED PAIRS IN TEXAS. My birds received August 10 and turned into pen; the 17th they were building their nests, making sever. days from arrival—all the birds in good shape. One did not fly on perch for about two minutes, but after this time have nothing wrong with them. They have certainly proven all that you have recommended of them and as to nesting have beaten your figures quite a bit. Thanking you for your extra favor, will do more business as soon as I locate where I will make my squab farm.—G. R., Texas.

MANUAL WORTH TEN DOLLARS. I am very much pleased with your Manual and think it worth \$10. I shall send you an order for breeding stock some time this month, and grain and supplies, just as quick as I can get my house built.—T. H., Massachusetts.

LETTERS FROM CUSTOMERS RECEIVED BY PLYMOUTH ROCK SQUAB COMPANY

APPENDIX E

(Copyright, 1908, by Elmer C. Rice.)

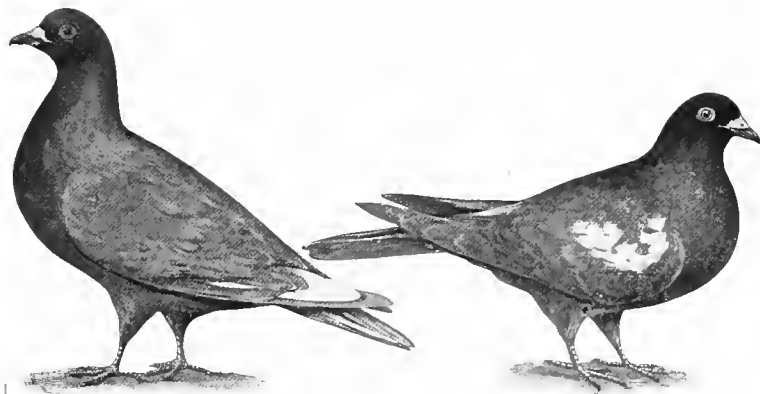

(Above pictures copyright, 1907, by Elmer C. Rice.)

CARNEAUX. BIG, RED PIGEONS.

The Carneau (pronounced *car-no*; plural Carneau, pronounced the same) breed is new to this country. These pigeons are larger than the Homers and breed squabs weighing over a pound apiece. Plumage almost invariably copper red (rare specimens yellow) splashed a little with white; long body; broad breast; shape of head and body, and poise of body, different from other varieties; quiet disposition, not so timid as other breeds; meat of squabs uncommonly white; have no homing qualities; they may be allowed to fly, if desired, after a fortnight's confinement, will stay around the place where they are fed, will not try to fly back to place where bred; feed their young steadily and well; breed nine to ten pairs of squabs per year; are housed, fed and handled same as Homers; strong, rugged build. The above pictures give a very good idea of this variety. A customer in Greensburg, Penn., writes: "This is the first time in my life to receive a circular picturing anything which gave a true picture; your picture is true to life in every detail. Everybody who sees my Carneau is greatly taken with them. In every way they are doing splendidly."

I spent several months in Europe in 1906, partly to study in their home the Carneau pigeons, which then were just becoming known in America and were recommended in sensational terms. It was my purpose to see the evidence at first hand and find out if the claims were founded on fact. My investigations were favorable to this breed but I have waited two years to see how the birds would breed in our own lofts and in the lofts of customers. At this writing we have sold about a thousand pairs of Carneau and orders for more are coming in fast. Previous to our importing this breed, there were about 600 pairs of Carneau in America.

In our long experience with pigeons, we have never known such a demand

as there is for **Carneau**s. **Six dollars a pair** may be obtained by anybody who has the breeders for sale. Youngsters weaned and able to stand shipment sell for **three dollars a pair**. The squabs sell alive for **ten dollars to twelve dollars a dozen**. It costs no more to feed and raise these birds than other pigeons. The selling price both for squabs and breeders being so much larger, **that is why the profit is larger**. On account of the tremendous demand for these birds for breeders, nobody is selling the squabs from them killed, but if they ever get so numerous that squabs are marketed from them, the price will be the very top notch.

This breed has been developed by the pigeon breeders of Belgium. There are some **Carneau**s in France and Germany, but they are inferior in size and beauty to the Belgian birds, and few in number.

They are not very plentiful in Belgium. We have made arrangements for the output of all the adult, perfect pairs of **Carneau**s the breeders of Belgium can furnish, fit for breeding, but so far they have not been able to furnish us more than 200 pairs a month, so scarce are the birds. We hope to get more from them. We have saved out 500 pairs **Carneau**s and are breeding them at our farm. We can supply **Carneau**s imported by us, or (in limited number) bred by us from birds of our importation.

Why is the demand for **Carneau**s so much greater than the supply? Just this: **They eat no more than Homers, but breed faster, and breed bigger squabs.**

In other words, they not only produce more squabs than the Homers, but the squabs bring at least one-third more money. The breeder making a profit from Homers will make more than double his profits with **Carneau**s.

For years, the study has been to produce a pigeon larger than the Homer which would breed faster than the Homer. This has been accomplished in the **Carneau**s. We know it by our own investigation and actual breeding of this variety, and we know it by the experiences of our customers.

The big breeds, all of which we have tried, such as Runts, Maltese, Italians (personally selected in Italy), breed big squabs, but they breed with exasperating slowness. Crossed with Homers, the rate of breeding is improved, but the squabs are no larger than from our **Extra Plymouth Rock Homers**, so it is far better to breed the straight **Extra Homers**.

The **Carneau**s breed squabs weighing a pound or more apiece and they breed **nine pairs to ten pairs of squabs a year**. For these two reasons, we believe that the **Carneau**s will displace the Homers in time. It will take many years because the Homers have a strong hold now and the **Carneau**s are scarce. Nevertheless, the cash returns from squabs weighing 12 pounds and 14 pounds to the dozen give a great profit to the breeder, and profits are what all squab breeders are after.

Any one who has both Homers and **Carneau**s can get in a year from each pair of **Carneau**s **15 or more pairs of squabs**. Theoretically this is impossible for any pigeons. However, the **Carneau**s have help from the Homers. Just how this done is fully explained by us at the end of this article in the paragraph headed, "**How to Breed Fifteen Pairs of Squabs from One Pair of Carneau**s in One Year."

One of our customers, a Southern gentleman, visited our farm in the fall of 1906. He liked the looks of the **Carneau**s and on returning home later sent for three pairs, which we shipped him December 26, 1906. On February 13, 1907, he wrote us asking how many pairs we could give him. He took all we could then supply at \$6.00 a pair, giving the following endorsement of his first

purchase: "The three pairs I got December 28 have raised six squabs and are setting again (February 20), and I have not had them 60 days yet. So far they beat the Homers." Under date of April 29, he wrote us: "I have now, in my lofts, between 800 and 900 birds. Have Maltese, Mondaines, Carneaux and Homers, but the Carneau is the favorite bird with everybody that sees them. Have nearly 100 of these now and they are very rapid breeders, raising squabs that weigh from **one to one and one-half pounds** each. Have not sold any yet, but have enough orders on hand for them, at **\$6.00 a pair**, to take all that I can raise for some time to come. Think at the present rate I can get eight to ten pairs a year from them." Under date of December 13, 1907, he wrote us as follows: "I have now something over 100 pairs of Carneaux. Have sold a few pairs and could have sold many more, but wanted my stock to accumulate and get as many breeders on hand as possible. **They are the best birds for squab raising that I have ever seen, and I believe I have seen them all.** They breed faster, eat less, are hardier, better setters and feeders, and gentler than any of the other breeds, and for beauty they are unsurpassed. I have all told now about 3000 birds in my lofts. Have been very successful with my plant so far. May want some more Carneaux from you later on."

A customer in Missouri bought four pairs of **Carneaux** and liked them well enough to buy six more pairs three months later, saying: "I am keeping an accurate record, which promises to be something startling for the year. Two pairs went to work (laid eggs) within 10 days. The third pair went to work in 26 days. The fourth hen was not so well along in the moult and did not lay until November 8. The average weight of squabs at four weeks old has been **17.6 ounces**, weighed without crops filled with feed. The four pairs have made nine nests in less than 90 days, or a total average production of better than **nine pairs a year**. The actual average production is better than this, of course, as it wouldn't be fair to count an average until all birds are at work. I have found them to be all that is desirable in a pigeon. They are good feeders and do not use more feed than the Homers."

In November, 1907, we shipped 21 pairs of our **Carneaux** to a Philadelphia breeder, who replied: "To say I am pleased, these words do not express it. They are the finest lot of birds I have seen anywhere. My friend, who imported 25 pairs of **Carneaux** some time ago from Belgium, is very much disappointed with his **Carneaux** since he has seen the shipment you sent me. I shall endeavor to do all I can for the interest of your house in the way of orders. I received the 21 pairs of **Carneaux** Saturday, 8.30 p.m. On Monday, at 10 o'clock in the morning, **nine pairs** of the birds sent had almost completed **nine nests** in their new home (in a little over one day). This seems remarkable to me and I write you these few lines to get your opinion of the work they have done."

Other breeders, not our customers, who have bred the **Carneaux**, praise them as follows:

"They will easily average three squabs a year in excess of select Homers. A conservative estimate of squab weight under favorable conditions is 18 ounces."

"They average nearly a pair of squabs per month. For fancy and squab producing qualities, the **Carneaux** easily lead all."

"No question about **Carneaux**. They are it."

"I have only two pairs. Results are so satisfactory that I am clearing lofts to devote exclusively to **Carneaux**."

"The Carneaux boom has struck this country for fair."

"The Carneaux exceed all others in point of squab producing, not only in numbers and weight, but also in the clarity of the skin, the palatableness of the flesh, and prolific nature."

"The consensus of opinion seems to be that the Carneaux will produce 10 pairs, or 20 pounds of squabs per pair to the year, while some place the average higher. Few place it lower."

"All I have read has been substantiated by my own personal experience. Their yearly yield is from 10 to 11 pairs of squabs."

"My experience with Carneaux is limited to two years. They are great. The Carneaux will occupy the place of honor in loft and showroom. Ten pairs of squabs is the yield per year."

"I have bred them two years. Carneaux are as superior to the Homer as the Homer is to the common pigeon. It is the rule rather than the exception for the Carneaux to produce nine pairs of white-meated squabs a year which will average one pound each. My experience proves conclusively that they will produce twice as many pounds of squabs in a year as the ordinary birds now generally used as squab breeders, and one of the most conspicuous points in their favor is the fact that the cost of keeping them is no more."

A few advertisers of pigeons who live inland, not in a seaport city, may "run down" imported pigeons, saying they are no good, culls, not acclimated, poor breeders, and so forth, *ad nauseam*. The reason why these soreheads fret so is, that it is impossible for them to import pigeons successfully. To do this successfully, steadily, profitably, one must live on the seaport, close to where the Antwerp steamers come, and must have a personal acquaintance with the officers of the steamships, and see them at every sailing, and pay them for their work in caring for the birds. The reason why those who decry imported pigeons do not sell them is simply that they cannot get them, or, if they think they can get them, they wish to sell something in which there is a greater profit. We have seen not much talk of this kind, in opposition to imported pigeons, but it will be indulged in more or less as the traffic in **Carneaux** increases. The trade calling for **Carneaux** in America must be supplied with imported birds or go without them, for nobody can ship day by day, steadily, **Carneaux** of his own raising. You should be sure and get **Carneaux** which have been in this country at least one or two months, and have got their sea-legs off, for it is our experience that the long voyage results in a goodly percentage of dead and injured birds, depending on the weather and the caretakers.

That imported **Carneaux** go to work quickly is indicated by the letter of the Philadelphia gentleman above quoted, nine pairs out of 21 pairs having built nests within two days after delivery to him.

Our trade in **Carneaux** is increasing every month and we expect to sell many thousand pairs in 1908 and 1909. We recommend them to our customers. We do not wish anybody to take our word for their excellence. Try them alongside of your Homers and form your own opinion. Anybody who buys **Carneaux** of us and is not perfectly satisfied with them, and that all we say here is true, after six months' trial, may exchange them for our **Extra Plymouth Rock Homers** at the rate of three pairs of Homers for one pair of **Carneaux**.

HOW TO BREED FIFTEEN PAIRS OF SQUABS FROM ONE PAIR OF CARNEAUX IN ONE YEAR.

(Copyright, 1908, by Elmer C. Rice).

During the first eight months of the year, January to August, the **Carneaux** may be robbed of their eggs twice a month and they will lay again about 10 days later.

A pair of **Carneaux** build a nest, and the two eggs are laid. On the day they are laid (or the second or third day, if the first day is not convenient for you) you take away the two eggs from the **Carneaux** nest and carry them in your hands to the pen where you have Homers breeding. You look around in the pen until you find a nest with Homer eggs. You throw these Homer eggs away, putting in their place the two **Carneaux** eggs. The Homers keep right on sitting and hatch out, not their own eggs, but the two **Carneaux** eggs, and raise the two **Carneaux** squabs.

Meantime, the pair of **Carneaux** from which you took the eggs wish more eggs, and within 10 days to 14 days the hen lays again. Now, as you did at first, you take away these two eggs from the **Carneaux** and put them under Homers.

Do not take away the third setting of eggs from the **Carneaux**. Let the eggs stay in the **Carneaux** nest and the **Carneaux** will hatch and raise them.

For example, a **Carneau** hen lays two eggs June 1. Take them away and substitute them for the eggs in a Homer nest. The **Carneau** hen will lay again June 10 to June 15. Take the two eggs away and substitute them for the eggs in a Homer nest. The **Carneau** hen will lay again June 25 to July 1. This will give you three settings of eggs from one pair in 30 days. Let the **Carneaux** raise the third setting and then repeat the process.

During the last four months of the year, take away the eggs only once and let the female **Carneau** set on the second pair of eggs.

From 15 pairs to 18 pairs of squabs from one pair of **Carneaux** may be produced in one year by the above method. With **Carneaux** selling for six dollars a pair, of course it pays to use Homers to increase the supply of **Carneaux**. With ordinary success, in following this method, the capacity of a pair of **Carneaux** may be doubled.

COMMENT ON ABOVE.

We do not think this forcing method would have the slightest effect on the health of the **Carneaux**. Hens and ducks lay a great many more eggs than

pigeons. It is not much strain on the female pigeon to lay four or six eggs a month instead of two. The strain of production comes from setting on the eggs day after day, not in laying the eggs, we should guess.

Why not take away all the **Carneaux** eggs and hatch them under Homers, some may ask. We do not believe in this, as far too unnatural. The **Carneaux** should be given an opportunity to raise the third setting, for that is what they are striving for.

This method has been tested thoroughly with birds purchased from us and it works all right. There is nothing far-fetched about it. You simply take the eggs away and let Homers hatch them out. At the same time, simple as this plan is, it has never been published before, to our knowledge, nor has it ever been tried except by a few breeders of our acquaintance. It is not uncommon for breeders of fancy pigeons of poor feeding and raising qualities to put their eggs under Homers, but no motive for doubling the squab production from certain pigeons has ever existed until today, when it is money in the breeder's pocket to turn out all the six-dollar pairs of **Carneaux** he can in the shortest space of time.

In following the above directions the breeder should realize that the **Carneaux** eggs must replace Homer eggs laid within two days of the same time, otherwise the bird milk of the Homers will be too old and thick, and the young **Carneaux** cannot assimilate it and may die.

(Later. January 1, 1909.)

Another year of breeding and shipping the **Carneaux** has substantiated our opinion of them, and the orders from customers have been added proof. On page 229 we mention a Western customer who started with four pairs of our **Carneaux**, then added six pairs. He was so pleased with results that in 1908 he ordered 30 pairs more, then again 35 pairs, and finally in November, 1908, an order for 150 pairs amounting to \$900. No more comment concerning his opinion of our **Carneaux** is needed—his money tells an eloquent story. This customer is an experienced pigeon breeder.

From the letters of other customers to whom we sold **Carneaux** in 1908, we make the following extracts. The full letters are on file at our Boston office, where they will be produced at any time to satisfy anybody as to their genuineness:

Enclosed find check for \$30 for which please send me five pairs of your **Carneaux** birds. I bought one pair of you some time ago and am much pleased with them.

Please ship me two more pairs of **Carneaux** as soon as possible. The other two pairs you shipped are doing nicely.

The eight pairs of **Carneaux** received from you April 25 have behaved beautifully with the exception of one pair. Nine days from date of arrival one pair had a nest and two eggs. Today (May 26) I have four pairs of squabs and expect three more pairs the last of this week. They surely have followed President Roosevelt's prolific policy. I am greatly pleased and am becoming interested in the possibilities of squab raising with the **Carneaux**. Regarding the pair that have not turned out right, I will ask your advice. The female (the smallest bird of all) laid two eggs in a bowl without any nesting material and left them to spend her time with her male partner in the flying pen. I will thank you in advance for any advice you can give regarding this negligent pair.

I thought it might interest you to know how the **Carneaux** have done that I bought of you in 1907. In June, 1907, I bought of you two pairs, in September one pair, in December, 1907, one pair, and I now (December 17, 1908) have 21 pairs mated and working. I have 114 birds not yet mated, and have sold \$44 worth of mated pairs and young not mated. Do you not think I have done well? I find the **Carneaux** a most charming bird, very tame, and they never leave the

nest when setting when you approach them. They feed their young fine, and raise squabs that weigh from 12 to 18 and 20 ounces at one month old. I have one pair of young mated last January that I have been offered \$10 for. I find much pleasure in mating up these birds, and I think I have got as good foundation stock as I could get anywhere. The Carneaux judge at the show told me that one of the hens purchased from you was as good a Carneau hen as he had ever seen. I have one young pair that have been breeding several months and they are averaging a pair of squabs a month, and have never lost a single squab. Their hatches are usually one or two days inside of a month. My Carneaux are very fast breeders, and I find by mating rightly I can increase their speed in breeding. They are everlastingly at it. I have got so much attached to the Carneaux that if there was no money in raising them I still would want a good flock of them. What could you sell me 100 pairs for, and how soon could you deliver them to me?

The birds which you sent me on Monday arrived here Wednesday at 10 o'clock in good condition. The Carneaux are great and I wish to thank you for the extra Homer hen. It is a dandy. My other two pairs of mated Homers have eggs now and my first pair of Carneaux have young ones. I am delighted as your birds and dealings are first class. You can bet that I'll be writing for more as soon as possible.

I have now over 150 pairs of Carneaux. Your birds (Carneaux) have done well. I am now shipping 20 dozen per week and getting \$4 per dozen. If it would keep up that way all the year here (Florida) I would ask for no better business. I shall be in Boston later on in the year and will call on you. I much want to see your Carneaux.

The Carneaux birds arrived in noble condition. We are very much pleased with them, and every one here that has seen them cannot get through talking about them. We certainly appreciate your promptness and methods in doing business and must say that you do more than you promise to. Will in a few days write you for more supplies that we will be in need of. Again thanking you for the way you have treated our order, we can give you our hearty support in any way that the buying public may demand of you, and you are at liberty to use this letter wherever it is of any value to you.

We received the three pairs of Carneaux April 27. They were in good condition, only one seems a little dull, but I think it will be all right. They are the largest pigeons I ever saw and are all that you claim them to be. When we have room we want to get more from you. One of our neighbors is going to start raising pigeons and wants me to sell him my squabs. I had to refuse and told him I thought Mr. Rice would furnish him with all the birds he wants, so I give you his name.

My Carneaux birds are doing fine, in fact, I am more than pleased with them. I have had ten settings and have just weighed a squab at one week old and it weighed a pound. We could hardly believe our eyes, but it is true. I am delighted with them. Any time I can help you in any way in regard to using my name you are welcome in regard to your Carneaux, as we think they are the only kind of pigeons to raise and we will get rid of all our Homers and raise only Carneaux.

I have been so very busy with Carneaux, chickens, hens, etc., that I have found no time to write before. I think the birds are very handsome and on May 8, every pair (16) had nests and eggs. I expect they will begin to hatch the first young ones about May 14, tomorrow.

I would like to ask you whether you have three pairs of Carneaux mated, as I am very much pleased with my first pair. They are all you claim them to be in size and have just finished building their nest.

The Carneaux arrived all O.K. on the 12th. Yesterday four of them built nests and laid one egg each. I call this fast work. Accept my thanks for quality of birds.

Some months ago I wrote you in regard to the pair of solid red Carneaux which I purchased of you last December to show at the Rochester Pigeon Show last January. The cock took first prize and the hen second prize. My Carneaux are doing fine and I find much in them that is very interesting. I have raised a fine lot of young Carneaux this year and they are all from your stock. My squab Homers are doing fine and I still have every one of the original 12 pairs I purchased of you November 9, 1904, and they are all working right along.

I have received your Carneaux in fine shape, and they are as fine birds as I have. I am very much pleased with them.

I wish to say that the four pairs of Carneaux my brother got of you last November have raised 16 fine birds.

I am more than pleased with the pair of **Carneau** which I got from you and send another order for two more pairs. I have the finest Homers I have ever seen but they look very small beside the **Carneau** and if the **Carneau** breed well I will send for more orders.

I am very much pleased with my **Carneau** and will be glad to send you photographs as soon as I get some. I had the address of a man in this State who claims to be an importer and breeder of **Carneau** and Homer pigeons. I wrote him for a price on red, and red and white birds, just in those words, and he said, yes, he had just what I wanted at \$2.50 each, three for \$6, and he would make a personal selection of the birds, which were second prize winners. But you ought to have seen the birds he sent me, not near as good as my own. I returned them to him, but he said they were just what I ordered and that I expected to get show birds under the pretence of ordering breeding birds, also he did not ship birds on approval at this time of year. He had the advantage as he held my money. He said show birds demanded a big price. He refused a price of \$150 for one bird in his exhibit at State Fair. Now, I saw those **Carneau** and they were no better than some of mine. One of the pairs I bought from you last Spring throw some elegant birds. As I am an amateur I suppose I must learn that all pigeon dealers are not white. I had no idea of showing my birds, but as this dealer seemed to be afraid I would, I think it would be a good idea to go in and show him that "there are others." If I have as good luck next season as I have this year, I think I can do it. Three of the females are from this best pair I mentioned. All three pairs hatched seven pairs young, working right through the moult.

The shipment of **Carneau** arrived just a month ago and is very satisfactory. Nine of the ten pairs are mated, and seven have squabs. The birds arrived several days before the nappies, but they adapted themselves to circumstances. One pair nested in a grit box, another pair in the oyster-shell box and three pairs on the floor. The nest bowls arrived just in time to save the drinking fountain.

The pair of **Carneau** received in good shape, and am well pleased with them. Think they will soon be at work, have commenced to drive. Will want another pair in a few weeks. Every one that has seen them says they beat everything they have ever seen.

The three pairs of **Carneau** and seven pairs of Homers arrived here March 25. The **Carneau** are very large, fine birds. There are several squab raisers here (California). One man has 8000 birds and another has 5000, mostly Homers, but when they saw my **Carneau** they nearly went wild. I am going to order more **Carneau** in a few days but not until I see what they will do. I will clear my lofts of Homers as fast as I can and stock up with **Carneau** if they prove to be even as good a breeder as the Homer.

The **Carneau** are doing fine. One pair went to setting within 24 hours after arrival. The other pair laid two eggs without building a nest so of course are not setting, but I believe they are building now as they stay indoors a great deal of the time. Am writing you this as I thought it might be of interest to you to know how your birds are doing that you sold. I brought the doctor with whom you have been corresponding in regard to the **Carneau**, around to see my birds and told him of the very good work they have done and he seemed very much pleased with them. What are 100 of these birds worth? I believe in time they will take the place of the Homers.

The three pairs of **Extra Homers** and three pairs **Carneau** arrived this morning in fine condition, and are a fine lot of birds. I am well pleased with them. They seem to be in a hurry to get to work, as one of the **Carneau** laid this afternoon. I think all of them will be on eggs in a few days. Will want more breeders later, when you will hear from me. Thank you for sending me such good birds.

As I have promised you, this lady has ordered me to get more **Carneau** for her. She is very proud of the five pairs you sold her. She has got the **Carneau** fever for fair. So here you are, kindly have ready for next Saturday afternoon, we will call for them, five pairs of your best **Carneau**. Kindly note, she will want more in about two weeks. She has given me the money already, so it is up to you to do your best. In her name I thank you. I will call next Saturday about 1 p.m. for them if you can get them ready.

Please advise me if the **Carneau** pigeons purchased from you November 23 are imported birds, or are they bred by you from the imported stock. The birds are doing excellent work. I purchased 20 pairs and at this writing have 20 nests. Every bird in the loft has eggs or squabs, of the lot purchased, 20 pairs.

I am well pleased with the pair of **Carneau** which arrived Saturday in good condition. Please send me three more pairs of same on the same conditions, for which I enclose herewith \$18.

I thank you for your compliments regarding my success at recent leading shows with my **Carneau**. Three years ago in one of my consignments of pigeons from abroad, I received a few pairs of **Carneau**. I kept them and bred several fine specimens. I am not a regular pigeon dealer. I am a fancier more. I work every day at my trade. Pigeons with me are a side issue. I have bought of you since December last over \$148 of **Carneau**, all for a few customers. Now, these exhibitions in different cities I made have created a furore and everybody is after me for **Carneau**. One party says, "A man like you that exhibits such fine **Carneau** must have some fine ones at your lofts. I want your **Carneau**," etc. I will send you an order for five pairs and I can guarantee you more orders next week.

I received my last order of pigeons two or three days ago; which was my third order from you. The Homers were very fine and the **Carneau** were the finest pigeons I have ever seen. They are simply grand and if I could not get any more like them I would not take one hundred dollars for them. They were driving the hens and feeding in one minute after I turned them out. They all have nests now. You have treated me very nicely and I like to do business with you. You have always treated me right. I had a letter from a pigeon man yesterday, about 150 miles from here, but I did not know how they would use me and so I give my order to you. Enclosed find check for \$50 for which please send me three pairs of your very best **Carneau**, and the rest, a nice assortment of best Homers. (This is the fourth order from this customer.)

The eight pairs of **Carneau** which you sent me last Friday arrived Saturday morning at 9.30, making seven and one-half hours better time than the shipment of Homers you made me on November 1 last. They are certainly beautiful birds. I tried putting each pair in mating coops immediately on their arrival, having previously removed the partitions, and by four o'clock that afternoon six pairs had mated. The other two pairs mated the following morning.

I was going to go to see you last Saturday but it was so cold I postponed it. Kindly fill my order for five pairs of **Carneau**. All **Carneau** bought of you are entirely satisfactory. It is a pleasure to deal with you. I will have the money ready when I call for them. Kindly advise when you can fill my order.

The **Carneau** were in fine shape and I am well pleased with them. I am enclosing money order for \$12 for which please ship, at once as per my other order, two pairs more of mated **Carneau**. Please give the filling of this order careful attention, as it means a great deal to me. If these birds do as well as I hope they will, I shall place an order for about 50 or 75 pairs in the near future.

I am in receipt of the four pairs of **Carneau** which were shipped on June 1. The birds are doing nicely, all four pairs having nested and laid.

The **Carneau** came to hand last Tuesday and to say I am pleased with them is putting it entirely too mild. They are the prettiest, biggest things in the pigeon line I ever saw. Every one that sees them says that they are stunners, they are the talk of the town. Will do as you suggest about the plan and photo of the house I built for less than \$20, and it is a dandy for this climate, too. If you wish to refer any one to me or have me show any one the **Carneau**, just say so and I will be only too glad to do it. Thank you for the prompt and careful attention given my order.

Our two crates of birds arrived two weeks ago. We thank you for the fine lot you sent. They are certainly as fine as any one can hope to possess. We have the room now for 700 or 800 pairs and we intend to fill this up with **Plymouth Rock Extra Homers** and **Carneau**. We are "stuck" on the **Carneau** but they are nearly out of our reach. Please give us all the information you can about selling squabs. Can we reach New York? We understand that we can. We raise more squabs in the winter than we can easily handle in this city. We note the markets in the *Packer* but they are always just as you say, below the actual market prices. Our birds will win all the prizes at the County Fair again this year.

The **Carneau** arrived Monday morning and were O.K. and to say I am pleased with them does not express it, as I think the pair of yellows are the best I ever saw. I was surprised to find the extra hen, as I did not expect you to make good the loss of the other one. I thank you very much for the nice way you have treated me in our dealings, and hope to do more business with you later.

In regard to our conversation of last week about the **Carneau**, will state that I like the birds much better than the Homers, as both squab raisers and show birds. Every one who has seen my birds says they are the largest and finest birds they ever saw. From the one pair of **Carneau** I purchased of you in March, 1908, I have raised five and lost three. They laid in

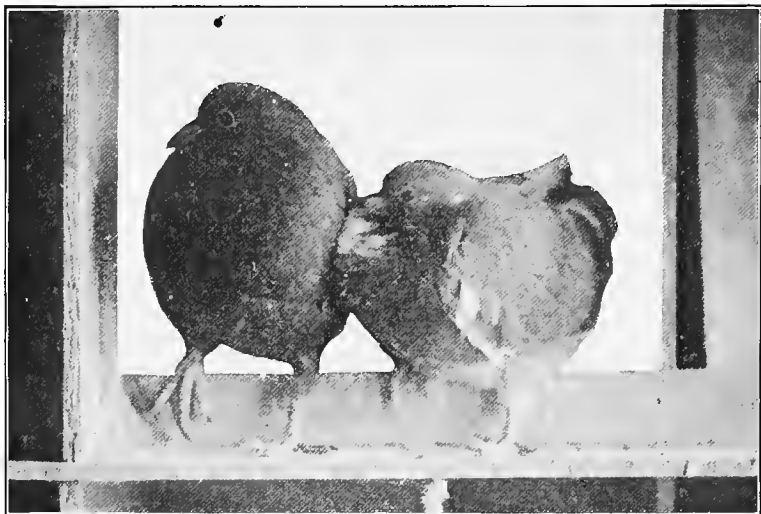

CARNEAU SQUAB COMPARED WITH HOMER SQUAB.

The Plymouth Rock Carneau squab at the left of the above photograph weighs $17\frac{1}{2}$ ounces. The Homer squab alongside at the right weighs twelve ounces.

about three weeks after arriving here, so you see they have been at work nearly all the time and are now setting. I have entered five of them at our County Fair, New York, and expect to capture all the prizes as I have no competition and had to enter them in a special class. I have a pair of yellow birds which I prize highly. The Carneaux should make a great showing in the squab industry.

I received your special offer on your Plymouth Rock Homers, but I don't see any reference to your Carneaux. I have made up my mind to discard all birds except the Carneaux. I have had one pair from you and I am well satisfied. Now what are your lowest terms, say for five or ten pairs, express paid to my address? Mr. Rice, I want them in time so I can show them at our fair in September. So far I am the only one in Colorado who has a pair of Carneaux, and I believe I could get quite a few orders for you if I put good birds on exhibition.

The three pairs of Carneaux are doing well. The squabs are very large. One pair of squabs especially, I feel sure, will weigh a pound and a quarter each at about a month old.

We purchased from you Homers about six months ago and Carneaux about three months ago. Both are satisfactory and we like the work very much. We are going to build a house for them this fall so as to make room for more stock.

The pigeons you shipped me last week arrived this morning in fairly good condition, considering the long distance they travelled. The Carneaux were extra lively. They mated in less than an hour after being taken from the crate. I am more than pleased with the Carneaux and think they are the finest birds I ever saw and shall take great pride in showing them to my friends.

I have 50 pairs of Plymouth Rock Homers which we bought of you. They are doing all right but I like the Carneaux better. The worst thing about the business is the killing part. If I

could get around that part I would enjoy it better. That is the reason I would like to get started with the **Carneaux**.

The **Carneaux** are beyond my expectations. I have bred all kinds of pigeons, but have never seen such breeders in my life. I have bred youngsters from them weighing 19 $\frac{3}{4}$ ounces at 20 days old. Can you beat that? Enclosed please find order for six dozen nest bowls.

I suppose you may be interested to hear about the breeders you sent me last spring. The two pairs of **Carneaux** are doing fine. They have hatched five pairs of squabs since.

The **Carneaux** I bought from you are coming along finely now. I have had luck with two or three settings and now have ten young pigeons from two pairs.

I bought four pairs of **Carneaux** of you last November and now (October) have 37 birds.

I am going to order some more **Carneaux** sure. As far as I have seen they are the bird. My neighbors here say that mine look more like turkeys than pigeons.

Some time ago I ordered of you five pairs of **Plymouth Rock Carneaux** at \$6 per pair and am very much pleased with same. I am particularly interested in the building up in point of weight in this particular bird. Hence I beg to be advised whether you would select shipment of extraordinary size at increased price and if so, extent of increased size or weight as compared with the general run of this bird, and at what cost? (Later we received an order from this customer for five pairs more.)

The **Carneaux** were purchased of you some time in December last, I think, first three pairs. Then later my partner went over and purchased of you three pairs more, making six pairs of imported birds purchased of you. The balance are the offspring of the original six pairs. I shall have no hesitancy in recommending the **Carneaux** to any who may inquire. They have proved more prolific than the **Homers** and much heavier birds.

The **Carneaux** proved well. Enclosed find \$6 for another pair. We are slowly selling off our **Homers**. (This customer has bred **Homers** for many years.)

We started with six pairs of your **Carneaux** shipped March 26, 1908. We have divided our loft into two pens, one for the breeders and one for the young. At this time, October 23, we have forty birds altogether, which we consider a good increase. The young birds are beginning to mate. Our flock worked right through the moulting season. We enjoy the birds and the work among them very much. (Later—November 23.) We now have forty-five **Carneaux** all told and eight pairs at work.

The above letters from customers give a clear idea of how our **Carneaux** are getting along in the United States and Canada. Our trade in them increased in 1908 steadily and we are going to ship thousands of pairs in 1909.

PLYMOUTH ROCK CARHOMES.

The crossing of a **Plymouth Rock Carneau** cock to a **Plymouth Rock Extra Red Checker Homer** female produces a splendid squab and we recommend this cross if you wish to save a little money on your first purchase. If you have some of our **Extra Plymouth Rock Homer** females now in your flock, red checkers, we will ship you our **Carneaux** males to mate with them at \$2.50 each. Or, if you so instruct us, we will mate a **Carneau** male to a red checker **Homer Extra** female and sell the pair to you for \$3.50—as many pairs as you wish at \$3.50 a pair. The price of our **Carneaux** is \$6 a pair, one price only. (No special offers made on this breed.) So in buying the **Carneau-Homer** combination of us instead of the pure **Carneaux** you will save \$2.50 on every pair you buy.

We call this combination **Carhomes**, taking enough of each word to make the desired meaning. We advocate red-checker **Plymouth Rock Extra Homer** females instead of the other colors because the color combination

is the prettiest and also because the resulting squabs have red plumage closely resembling the pure **Carneau** squabs. Of course they cannot be sold for breeders as pure stock **Carneau** but these **Carhome** squabs can be put on the market in competition with pure **Carneau** squabs and will sell up to them surprisingly strong. One of our customers who is producing these **Carhome** squabs writes the following emphatic words: "The results of my breeding one of your **Carneau** cocks to a red-checker **Extra Homer** female are more than satisfactory. First, it is impossible to tell the difference in color and size. Second good result, it makes the young ones very hardy. I made other experiments by crossing a **Carneau** cock with an **English** hen **Homer** (carrier). The results are not so good because you can tell the **English** blood in the squabs and it destroys the beauty of the **Carneau** head."

We do not breed **Carhomes** at our farm because our reputation has been built up and will be continued on pure stock. But if you wish to breed squabs for market, then you can go ahead with confidence on this cross. We sell them at the price formerly charged by some for **Homer** pairs, and they are superior to any **Homers** for producing big squabs and breeding fast. Understand, there is nothing to prevent you from building up a business in the **Carhomes** for breeders but you cannot sell them representing them as pure **Carneau**. The blood of the young will be half **Carneau** and half **Homer**. You sell them on their merits as squab-breeders.

For our customers of many years' standing who are shipping steadily in to the markets of all the cities on this continent not only the best **Homer** squabs, but three-fourths of all the squabs sold, we recommend our **Carneau** cocks to be crossed with their red-checker **Homer** females as the best means of increasing the weight per dozen of their output and the quantity of squabs produced; and bettering both the appearance of the squabs and the quality of the meat.

We do not advocate the crossing of a **Homer** red-checker cock to a **Carneau** hen (or, to coin a word, **Homecarnes**) because (1) the cock should be master in fact as well as name, (2) the female likes a large male better than a small male, (3) the female is not so likely to break her mating to secure a more vigorous helpmate, (4) the male is better able to defend his mate and family from other males or females, (5) the male **Carneau**, the best of his kind, is larger and better than the male **Homer**, the best of his kind. (The female **Carneau** is inferior to the male **Carneau**.)

CARNEAUX AND HOMERS NOT IN THE SAME PEN.

As a rule, each breed of pigeons should be kept in a pen separate from other breeds. If different breeds are kept in the same pen, the breeds may mix, no matter how carefully the pairs are mated, and of course the young are liable to mix. There is nothing about a **Homer** pigeon which keeps it true to its own species. If **Fantails** or any other fancy breeds of pigeons are kept in the same pen with **Homers**, there is nothing about the **Homer** which would lead it to be true to its own species. He or she is just as liable to seek a different breed for a mate. As to the two kinds we sell, the **Homers** and the **Carneau**, if they were kept in the same pen, it is quite possible that an attachment for a **Carneau** cock or hen might form with a **Homer** of the opposite sex. So if you are breeding both the **Carneau** and the **Homers** for the pure stock you should keep them separate.

APPENDIX F

(Copyright, 1909, by Elmer C Rice.)

Letters from customers which we print on the following pages are a few of those received lately. From a pile of manuscript some **three feet high** we have selected enough letters to make a proper setting for the pictures. Many customers have sent in letters which ought to be printed for the news in them, but in this book, now grown to quite bulky proportions, we have run up against the limit of space.

A MONTHLY SQUAB MAGAZINE.

The best outlet for suggestions, experiences, market reports from all over the country, etc., constantly being sent in, would be a **monthly squab magazine**, printed and illustrated in the best style, capably edited and written by experienced and industrious men and women who have ability as well as good intentions, who know what they are doing, and **who know squabs**. Such a magazine, creditably gotten up, with money behind it, and money coming in from subscribers really pleased because they would be getting full value, would be a power in the squab industry. Properly managed, it would not only be a clearing house for ideas and a monthly entertainment, but of assistance in actually making market prices for squabs, **bettering them**. Breeders of squabs should be organized for better prices and other ends. A **first-class monthly squab magazine would be cheap at a subscription price of \$1 a year**, issued on time each month, and containing nothing but original matter at first-hand (no politics or cheap wrangling, but plain and thorough business all the time.) There is a demand for such a **national squab magazine** and thousands of breeders would subscribe for it.

MORE ABOUT HOW TO TELL SEX.

A good proportion of our letters, month after month and year after year, inquire how to tell the sex of pigeons. People ask us this question before they have read this **Manual** and after they have read the **Manual**. We should like to write this down to the remotest detail so that even a child could tell the sex of a pigeon by looking at it, but this is impossible. There is no language which can convey the secret of telling absolutely the sex of pigeons. You can tell only by watching them and by experience gained by this watching. You become more expert in determining the sex as you go along. There are no marks on either male or female by which you can distinguish them at any age. Some large male pigeons act the same as roosters do and can be told almost at a glance. On the other hand, some female pigeons are large and coarse, like a male bird, and the secret of their sex is disclosed only by their actions in conjunction with birds of the opposite sex.

The birds we ship are banded cocks on right leg and hens on left leg. You must watch these birds and see how they act. By the location of the band you will know the sex and by their actions you will learn to connect what you see with the specified sex. Sometimes customers will write to us and state that they have raised birds and are puzzled about the sex of them. In that case you must watch their actions or you can turn such birds in with

some of our birds and watch their behavior in connection with our birds. You will know the sex of our birds by the bands on their legs, and when you have determined by the actions of your birds what the sex of them is, catch them and band them, putting a band on the right leg of the cock and a band on the left leg of the hen. It is impossible to band a squab four or five days old with a seamless band so as to designate the sex. You cannot tell the sex of a squab or young pigeon until it discloses by its actions at mating age, four or five months, what it is. If you put a seamless band on a young squab, the object is to show the age, not the sex. The best way for the business squab breeder is to put an open band on the leg of the squab, showing its age, by its date, and bearing a distinguishing number which you refer to in your records. You can put this band on either the right leg or the left leg of the squab. When the young bird grows up to mating age and you find out its sex, then change the band to either the right or left leg to suit the case.

It is not a difficult matter to determine the sex of a pigeon by watching, for sooner or later you will see actions that will tell you. You must not be guided much by a little quarrelling which you sometimes see going on. Two hens will quarrel the same as two cocks. If two or three pigeons are extremely puzzling to you, handle them in this manner: Take them out of the breeding pen and put each pigeon in a small coop or box in the dark and keep them there for two or three days, each pigeon in a separate box or coop. Feed and water them regularly, then take them out of their little coops and put them into mating coops with other birds. They will generally disclose their sex as they are anxious for companionship after being shut in so long. Another way to do this is to take two birds and put them into a mating coop, one on each side of the partition, and put a bag or other covering over the coop so that the place will be darkened for two or three days. Feed and water daily. Then take off the covering and take out the partition in the middle of the mating coop and watch the two birds as they come together.

The beginner should familiarize himself with the billing, treading and driving as he sees the birds. We have had customers write us and declare that we had shipped them squabs because they had seen what they thought young birds taking nourishment from the older birds. What they really had seen was a male bird kissing or billing with a female bird, a matter entirely different.

The male and female mates not only bill, tread and drive, but they nestle close at times, each running his or her bill through the feathers on the neck and head of the other.

Pigeon breeding is an ancient hobby and pastime in England. An English writer, Dixon, years ago described their love affairs in choice words. It is a pretty sight, said Dixon, to see pigeons at liberty when "courting." They begin to go together in pairs, except while associated with the flock at feeding-times; and when they are resting on the roofs, or basking in the sun, they retire apart to a short distance for the purpose of courtship, and pay each other little kind attentions, such as nestling close, and mutually tickling the heads one of another. At last comes what is called "billing," which is in fact a kiss, a hearty and intense kiss. As soon as this takes place, the marriage is complete, and is forthwith consummated. The pair are now united, not necessarily for life, though usually so, but rather *durante bene placito*, so long as they continue to be satisfied with each other. If they are

Tumblers, they mount aloft and try which can tumble best; if they are Pouters, they emulate one the other's puffings, tail-sweepings, circlets in the air, and wing-clappings; while the Fantails and Runts, and all those kinds which the French call *pigeons mondains*, walk the ground with conscious importance and grace. But this is their honeymoon—the time for the frolics of giddy young people. The male is the first to become serious. He foresees that "the Campbells are coming" better than his bride, and therefore takes possession of some locker or box that seems an eligible tenement. If it is quite empty and bare, he carries to it a few straws or light sticks; but if the apartment has been already furnished for him, he does not at present take much further trouble in that line. Here he settles himself, and begins complaining. His appeal is sometimes answered by the lady affording him her presence, sometimes not; in which case he does not pine in solitude very long, but goes and searches out his careless helpmate, and with close pursuit and a few sharp pecks if necessary, insists upon her attending to her business at home. Like the good husband described in Fuller's Holy State, "his love to his wife weakeneth not his ruling her, and his ruling lesseneth not his loving her." And so the hen obeys, occasionally, however, giving some trouble; but at last she feels that she must discontinue general visiting and long excursions, and enters the modest establishment that has been prepared for her performance of her maternal duties. A day or two after she has signified her acceptance of the new home, an egg may be expected to be found there. Over this she (mostly) stands sentinel till, after an intervening day, a second egg is laid, and incubation really commences, not hotly and energetically at first, as with hens, turkeys, and many other birds, but gently and with increasing assiduity. And now the merits of her mate grow apparent. He does not leave his lady to bear a solitary burden of matrimonial care. He takes a share, though a minor one, of the task of incubating; and he more than performs his half-share of the labor of rearing the young. At about noon, sometimes earlier, the hens leave their nests for air and exercise as well as food, and the cocks take their place upon the eggs. If you enter a pigeon-loft at about 2 o'clock in the afternoon, you will find all the cock-birds sitting—a family arrangement that affords an easy method of discovering which birds are paired with which. The ladies are to be seen taking their respective turns in the same locations early in the morning, in the evening, and all the night. The older a cock-pigeon grows, the more fatherly does he become. So great is his fondness for having a rising family, that an experienced unmated cock-bird, if he can but induce some flighty young hen to lay him a couple of eggs as a great favor, will almost entirely take the charge of hatching and rearing them himself. We are possessed of an old Blue Antwerp Carrier which by following this line was, with but little assistance from any female, an excellent provider of pie materials, till he succeeded in educating a hen Barb to be a steady wife and mother.

There was a good deal of observation put into pigeons by Mr. Dixon before he expressed the above sentiments and what he saw you will see when you watch your flock.

HOW TO KEEP DOWN AN EXCESS OF COCKS.

One of our customers in Connecticut of considerable experience and original thought has tried out our Homers with birds from other sources, and

has found them superior to all he has tried. He had no culls among the squabs. He has bought largely of our Homers and **Carneaux**. He had been trying on some white Homers our plan for getting 15 pairs from one pair of breeders in a year and thought the plan was original with him. This is an indication of the careful attention he has given to the details of the business. Here is another plan he has been working. An excess of cocks seems to be one of the troubles of some in raising young birds and for that reason we have requests for single hens. This customer proceeds on the theory that the second egg is said to hatch a hen, so he goes among the nests every day and marks all single eggs **1** with a pencil. Then in a couple of days when the second egg has come he marks it **2**. Then he puts both the **2** eggs in one nest and both the **1** eggs in the other nest, making a memorandum of the nests and what he has done. When killing day arrives for these nests he saves the **2** squab and kills the **1** squab, thereby hoping to raise two hens. How this will work out in actual practice he does not know, because he has not been doing it long enough. We speak of it here so that our customers may try it if they wish and see how they come out.

While in some lofts there may be an excess of male birds caused by continuous breeding, it is true that the law of the species is to hatch out equally. Otherwise in time, and a comparatively short time too, the entire species would be extinct. It is absolutely not true that more cocks than hens hatch out. The law is that equal numbers hatch out, for this law is necessary to the propagation of the species.

We have had thousands of customers start with three pairs or six pairs or twelve pairs and increase from that small beginning to 200 or 300 pairs or more, as our letters from customers show. This is proof that the law of equal sex holds fairly good even in the restricted confines of a small squab house.

Squab raising for profit is a new business for the Connecticut customer above mentioned. He is well up on pigeons as a fancy or rather amusement, having kept in Europe at one time or another a few pairs of all breeds. He has been getting **\$4.50** for his squabs all summer in Connecticut, with some at **\$3.50** to his local butcher who retails them at **\$4.50**, unsorted, running over eight pounds to the dozen. He says the more he sees of this business the more he is convinced that conducted right there is big money in it; but conducted wrong it is a poor business. This is certainly correct, and is why we insist upon our birds being used and managed in the way we tell both in this book, and the special instructions which we send out with every shipment.

SQUAB HOUSES OF TWO AND THREE STORIES.

We have been asked by customers whose ground is limited or who happen to have a certain plot, if a two-story house would not be all right in which to raise squabs. Some of these customers have figured out carefully and thoroughly that the construction of the two-story house is cheaper than two one-story houses. A two-story house certainly may be built. We print on the opposite page a photograph of a two and one-half story pigeon house. This breeder is a good customer who has bought about \$2000 worth of Plymouth Rock birds of us during the past four years, and he understands what he is about. We asked him to describe his plant. He says this house, which is part of his large plant, was not transformed from an old place, but



TWO AND ONE-HALF STORY SQUAB HOUSE.

This was built to utilize to best advantage a small plot of ground. For description see this page and the opposite page.

was built especially for pigeons. It was almost a case of necessity with him, as all the plots of ground near him were owned by one man who stood out for a stiff price. The customer accordingly built this house and says he has never regretted it. After it was built he was able to purchase all the land he ever should need, and he bought it right. This three-story house is 54 feet long and 20 feet wide, 14 feet to top flat, 14 feet rafter with one foot projection. The third floor is laid on a level with top flat. The third floor does not extend across the entire width of the building, but drops back five feet from each side, giving room for three nests from floor to roof. The four sides of these pens are lined with nests, and the pens are 10x10 feet. Single dormer window on north and two dormer windows on south (this is shown in photograph). No hallway on third floor, but steps from second floor go up near the center of the building, making it unnecessary to pass through all pens to reach the end pens. First and second floors alike have a four-foot hallway on the north side, and each floor has six pens 9x16 feet. The partitions between these pens are formed by the nest boxes. Feed and water from the hallway. The floors are of matched lumber and the first floor is double with paper between. The frame of building was first covered with heavy roofing of a popular brand and sided with ship-top lumber. Under the west end of this building is a basement 20x20 feet, cement floor, used for

picking and packing squabs. The building has 17 pens, and each pen has its flying pen which reaches the ground. For the first floor, the flying pens are nine feet wide and seven feet high, and extend out 20 feet from the building. Beyond the south end of flying pen for first floor, the flying pen extends another 20 feet. This extended pen is divided into two pens 10x9 feet on the ground. The birds from the second and third floors reach these pens through a fly-way above the flying pen of the first floor, one-half as wide. You will notice a tank (shown in photograph) on the roof. Water is forced from a cistern into this tank. All pens outside are connected with water main, making it easy to give the birds a bath.

SQUABS FED ARTIFICIALLY.

Sometimes it is desirable or necessary to feed a squab artificially, introducing the right kind of a mixture with the fingers or with a syringe. These efforts are more or less crude. The best way is as it is done in Italy, but it is doubtful whether our squab raisers would employ it. We first saw this done in Bologna, Italy. The squabs are shipped into Bologna from the outlying country when they are about the same age as our squabs, four weeks. They are always shipped in alive in common slatted coops. It is quite necessary that the squabs be fed before they are re-shipped alive as they always are to Paris or Monte Carlo or Aix-les-Bains. They are fed in the following manner: The workman mixes up a sort of thick gruel with grain and water. All the grain which he uses is quite fine, such as the finest size of cracked corn. Then he fills his mouth with a quantity of this mixture and begins feeding the squabs. He takes up a squab in his two hands and holds the bill of the squab to his mouth. The squab is hungry and naturally open its bill, or if not the operator opens the bill of the squab for him. The operator then with his tongue forces into the mouth of the squab a quantity of the mixture, and the squab fills its crop. Immediately another squab is taken and handled in the same manner. This process is done with great skill and rapidity. We watched one operator feed a coop of 24 squabs in five minutes. This artificial feeding of squabs is very common in Bologna and in other European cities, where it has been going on for years. The operators show no repugnance, but keep at the work as part of their daily round of duties month after month.

NESTS ON THE FLOOR.

It is impossible to prevent some pairs from building on the floor of the squab house. Squab breeders who have a large bump of system and order are cast down because all of their pairs do not stick to the nest boxes all the time. You cannot force certain pairs to breed in the nest boxes. They will pick out a corner on the floor or alongside of the crate containing the nesting material or under a tier of nest boxes. There they will build their nest and rear their squabs and they are generally left alone. Do not take their nests and eggs and put them in one of the nest boxes, for if you do it is not likely the birds will follow.

Squabs from such nests should be carefully watched and should be taken away to be killed before they are strong enough to walk around on the floor. You will have to take away such squabs when they are full and plump at three weeks of age. If you leave them in the nest too long it is quite usual for them to get up and walk around on the floor and as soon as they do this

they are no longer squabs, but have trained off their fat and become young pigeons. Squabs in the nest boxes do not walk around like these because they realize that they are somewhat weak and will not take the flight to the floor.

It is troublesome when cleaning to avoid some nests on the floor. When the young birds leave the nest boxes above they are quite helpless and will rest on the floor. The old birds which have built their nests on the floor will peck the young birds and give them no rest. The cocks especially will do this.

A customer has found out a way which he has had in use for some time to keep pairs off the floor and induce them to build in the nest boxes. When he finds a new nest on the floor, he lets the hen lay both eggs there and sit on them for one or two days. Then he makes a nest box about twelve inches square and six inches high and places the nest, eggs and all, into this box and allows the nest box to stand on the floor of the squab house in the same spot where he found the original nest. He reports that nine times out of ten the hen will sit on the nest as before. He lets her sit on the eggs for three or four days more, then he takes the nest box, eggs and all, and screws or nails it to the side wall as near as possible to the spot where the nest was on the floor. Sometimes he raises the nest box from the floor a small distance at a time, one inch one day, another inch the following day. He says that although this is quite a trouble it seems to break the hen of the habit of building on the floor and the next time she is more than likely to build the nest off the floor.

A PLAN TO GET RID OF RATS AND MICE.

One of our customers gives us the following idea: Make a rough table of matched board with joists for legs, about three and one-half or four feet high and the same shape as the feed box, only have it three feet longer and three feet wider. This will allow for a platform 18 inches wide around the feed box for the birds to stand on and eat the grain; next make a rim, high enough so that when the pigeons are getting grain they will not scatter any on the floor. Do not be afraid of having the rim too high, eight inches will be all right. Have this eight-inch rim all around. The last thing is to buy some smooth, glassy tin plate and wrap a piece around each leg. It is not necessary to cover the whole leg, 12 to 18 inches will be enough. This will make it impossible for rats or mice to climb up over the tin and eat the grain. The legs should be 18 inches or two feet high.

Another way to manage instead of using the tin is to put the feed box up on a platform and support this platform with four legs made of iron pipe. Generally there is a joint in the tin, and some mice may run up a joint or seam of this kind, putting their feet into the crack in the seam. If you use iron pipe to support the platform it will be impossible for the rats or mice to climb up this iron pipe to the feed box. You should use four pieces of piping, one at each corner.

Here is another way to clean out the mice: Take a small tight box, say six inches by six inches in size. Bore an inch or two-inch hole at one side near the bottom, put in a handful of feathers or cotton and lay the box on the floor in a secluded part of the squab house. In about two weeks go to the box quietly in the daytime, put your hand over the hole, and carry the box to a barrel or tub half full of water. The mice will jump out faster

than you can count. One customer got 48 at the first trial, and about ten the next time. This took them all and he was no longer troubled by mice.

HOW TO MAKE PERCHES.

In making perches, one of our friends has a plan that may be of use to some beginner. Take a square tobacco caddy with dove-tailed corners, such as can be had at any tobacco counter. Remove the bottom and saw the sides in two half way. A small block of wood nailed in the angle furnishes an easy way to fasten the perch to the wall.

PITTSBURG MARKET.

Our customers repeatedly call our attention to the fine market for squabs in Pittsburg. They are quoted at **\$4 a dozen** in the newspapers there, and we have customers in that city who are getting as high as a dollar apiece, or **\$12 a dozen**, for first-class squabs bred from our birds, weighing a pound apiece. It is quite true that Pittsburg is an excellent squab market, in fact, one of the best in the country, as there are so many rich people there. We have also some good, live, wide-awake customers who are shipping squabs to Pittsburg, and they have shown Pittsburg squab buyers the superiority of well-bred squabs. The result is that they have worked up an insistent demand which must be satisfied. What our customers have done for Pittsburg anybody can do living near a city, or a town. This work of letting your nearest market know what you have, and then showing what you have to the market must be done by you. Nobody can do it for you. The prices you can get for your squabs, and the demand for your squabs, which you can create, rest entirely with you. Nobody can do this from a distance—you are on the ground and such work must be done by you.

LOW QUOTATIONS.

Beginners may find in the newspapers or in letters from commission men a low quotation for squabs. Some will write to commission men and dealers asking them what they will pay for squabs, etc. In nearly every case the commission man or dealer will write back an absurdly low price. It is to his advantage of course to buy squabs as cheap as he can and sell as dear as he can. The most peculiar feature of such matters to us is that the breeder or prospective breeder of squabs apparently takes the matter for settled and writes us that he can get only \$1.50 or \$2 a dozen for squabs. Such people seem to be lacking entirely in any business ability. An eight-year-old boy who is accustomed to selling newspapers has enough business judgment to prevent him from writing such a letter. Of course the commission men or squab dealers start with a very low price. If the breeder will sell to him at this very low price, that is so much more to the advantage of the commission man or dealer. He is writing to feel out the breeder. If the breeder writes back to him and says, "Your price is too low, you will never get my squabs for this figure," then the commission man or dealer will raise his prices. The dealer who is selling squabs for from \$3 to \$6 or more a dozen (as they all are) will pay from \$2.50 to \$4 a dozen, no matter who he is or where he lives, in any part of the United States or Canada.

The only way for you to determine the true market price of squabs wherever you live is to go into the market or apply by letter and offer to buy squabs and not to sell them. In all the letters you write and all the talk

you make, offer to **buy** all the time and then the dealer will disclose to you the true prices. Then you will know what to sell your squabs for. If you find that he is selling squabs at \$3 a dozen, he should pay you \$2.50 a dozen. If he is selling squabs for \$4 a dozen, he should pay you \$3 a dozen for them and so on.

Once more, be on your guard against market quotations. If you see squabs quoted in a newspaper or anywhere else at low prices it does not follow by any means that that price is the true one. Such figures are put in because they are the prices of the commission men or dealers, which they want to pay.

No successful squab business can be built up if you allow a middleman to run your plant for you. You are simply buying grain and working for him. He has no trouble or expense to amount to anything but he takes the profits and you do all the work. When grain is high you must get more for your squabs than you do at other times. The trouble with many squab raisers we have found is that they have no actual knowledge of what it costs them to raise a dozen squabs. You must arrive at your cost of product absolutely and when you do it is folly to sell squabs for that figure or less. You must put them out at a profit or else go out of the business. Our best customers are those who have sense enough to sell to a private trade or to first-class wholesalers, and this must be your goal in every case. If you wish to make the most money, get right after your private trade until you secure it, as this is unlimited. People who are accustomed to eating chicken, as they are in every part of the country, will eat squabs. If they do not, it is your fault. You must tell them what a squab is and show them, and induce them to buy and eat them. If they do not know what a squab is, you must demonstrate.

HOW TO KILL CATS.

A kitten brought up in a squab house will make no trouble. We raise two or three kittens every year at **Melrose** and give them the run of the pigeon houses, and such cats are intelligent enough not to try to reach the squabs. Of all the cats we have raised we have had only one which we were obliged to shoot because of squab stealing.

Cats belonging to the neighbors may cause some trouble in your squab house if you give them a chance to get in. A customer in Ohio has found a way to kill visiting cats. He does not like to have them around the squab house trying to get in so he puts exposed wires on the top of the flying pen and when the cats walk around on the top of the pen, looking for a chance to get at the pigeons inside, he throws a switch in the basement. A strong current of electricity shoots through the wires. The body of the cat makes a short circuit from one wire to the other so the charge of electricity passes through the cat. The result is that the cat tumbles off in double quick time and starts for the tall timber, if alive. He says he has electrocuted two and still has his hand near the switch.

BREEDING TRUE TO COLOR.

No colored Homers breed true to color. We mean by this that if you start with the blue-barred Homers, for example, and breed them, you will in time get from these blue-barred birds all the other colors, such as blue-checkers, red-checkers, silvers, etc. All these colors are in the blood and

they will come out in time if you give them time enough. Some pairs are eccentric in their breeding. A certain pair of blue-barred birds may breed blue bars, whereas another pair of blue bars may breed one blue-barred squab and one blue-checked squab, or any other color, and this variation may be characteristic of this breeding for quite a period. It is impossible to predict absolutely.

Our white Homers breed true to color. If you buy white Homers of us and breed them, the squabs will be white-feathered constantly and will not be blue barred or blue checked, or any other color, except very rarely.

SULPHUR OR IRON WATER.

Parties write us from different sections of the country stating that the water where they live contains sulphur and others write that the water contains iron. For example, on the East coast of Florida about half-way down, all the water is strongly impregnated with sulphur. Breeders write us to know if this sulphur water is all right for pigeons. To this we reply yes, when they get accustomed to it. If when you get your pigeons you find that this sulphur or iron water is affecting them, stop it and give the birds rain water. Rain water is absolutely pure water containing no mineral substances whatever, except the trifling amount of dust which may get in as the rain water runs down a roof before it gets into a rain-barrel or cistern. It is always safe to give this rain water to pigeons and you can introduce them to your sulphur or iron water as slowly as you please, by adding the sulphur or iron water to the rain water from day to day until the mixture is finally all sulphur or iron water. This will accustom the birds to the new water and before long you will have no need of using the rain water.

PIGEONS THAT FLY AWAY.

In every day's mail, two or three letters and often more recount the story that the writers have accidentally left open the doors of their squab houses or the doors of their flying pens; or that some other accident has happened so that some of the pigeons have flown away from the premises. Customers writing from as far as California tell us this and sometimes telegraph us and wish us to catch these birds as soon as they reappear at Melrose and send them back by express. The capacity for flight of a Homer does not seem to be a matter of well-defined knowledge, so we will say here that flights of over 500 miles for a homing pigeon are very rare. We have no cases on record of flights of homing pigeons even from Ohio or Illinois to New York or Massachusetts. It is incredible that a homing pigeon would get back to its native place after a flight of two or three thousand miles. Birds which have been imported would make no attempt to fly back across the ocean or to the shipping point, so if you lose any of your pigeons out of your coop, the best you can do is to hope that they will return, as quite often they do. Recently we recall a case where a customer lost nine birds which flew away but five of them returned and went inside the house.

Once again we repeat, hoping it will catch the eyes of so many who write us, that any Homers which you buy you must keep wired in all the time, otherwise they will fly away and leave you. By all the time we mean day after day, week after week, month after month, year after year, continually and perpetually, as long as the pigeons live. You cannot feed them for a month or so and then let them out and think that they will stay with you.

They have a yearning and a longing, the homing instinct, to try to get back to the place where they were bred.

Any Homers which you breed yourself you can safely let fly because they know no home but yours and will stay with you. If you have a mixed flock of Homers including not only those which you have raised but some you have bought, you cannot let them out with any certainty that those you have raised will hold on your premises those which you have bought. It is quite possible that those which were raised elsewhere will leave you.

NO COAL ASHES.

About every household here in the North burns coal and the problem of getting rid of the ashes is considerable to many people who do not live in the city where the city wagons call to take them away. The result is that we have hundreds of letters asking if coal ashes can be put in the flying pen of the squab house.

Coal ashes should not be put in the flying pens where the birds can peck at them, because they are irritating to the mouths and other insides of the birds. It is all right to put down a layer of coal ashes in a pen for the foundation if you want to get rid of a lot of coal ashes, but on top of these ashes a layer of gravel should be put down from four to six inches thick and the top of this gravel should be renewed every three or four months.

TEMPORARY PEN AND BREEDING PEN.

It is very necessary to avoid having odd or unmatched birds at liberty in the loft during the time the other birds are either mating or breeding. If there be but one such bird in the loft, be it male or female, it will be sure to cause disturbance among the mated birds, either by getting mated to some bird you have had great trouble to get mated to your wishes, or by causing continual fighting, resulting in many broken eggs or dead young ones. All odd birds should therefore be either kept up in pens or in a loft by themselves during the breeding season. For the same reasons, three or four pairs of newly-mated birds should not be turned into the loft together. If they are, there will certainly be quarreling, as two or more pairs will want to take the same nest box, which will often be the cause of pairs getting unmatched, and remated in a manner which is not desirable. To avoid this, each pair as they are mated should be turned into the loft singly, when they will select one of the unoccupied boxes, and go on quietly. It is very rarely necessary, if this plan be pursued, to adopt any measures for inducing a pair to take a proper nest, supposing there be one at disposal; but if any trouble be anticipated, any kind of a cage of lath or wire may be fixed to the front of the breeding box, and the birds then confined for a few days in sight of the rest of the loft, till they have got thoroughly used to their new abode. We can hardly remember an instance, however, where such a plan was necessary, unless the breeding places were so numerous and so much alike as to puzzle the birds. In this case the plan we prefer is to make some distinction at the entrances: thus, a half-brick may be placed at one hole; and passing the next, something else at the next alternate one, by which the birds will readily learn their proper breeding-places. One more caution must be added in regard to mating the birds. It frequently happens that, on account of proved sterling qualities, it is desired to breed from an old pigeon as long as any fertile eggs can be obtained from him; and this can only be done by matching him with

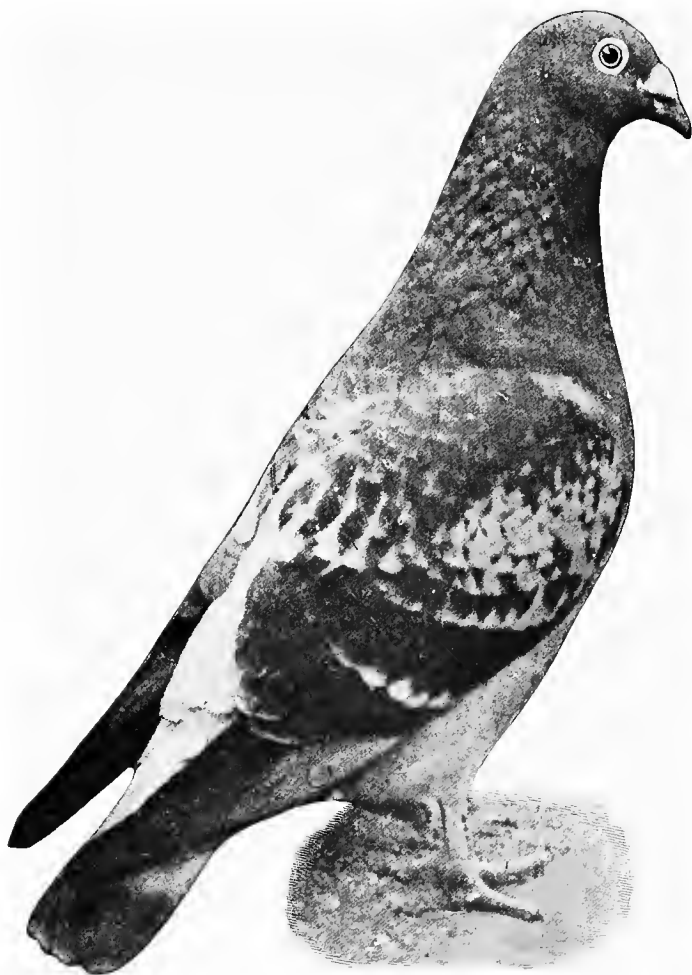

PLYMOUTH ROCK EXTRA HOMER MALE

a very young hen. Such a pair will frequently breed well; and we have had fine strong young ones from an old Barb over ten years of age, which won many prizes. But it is in such cases particularly needful to avoid having in the same loft any lively young cock with a strong voice, for if this be the case, the young hen will frequently leave her eggs to reach and pair with the young bird, even though he be already mated, and thus all the owner's plans are liable to be frustrated. For although pigeons as a rule pair with great fidelity, exceptions are by no means rare; and cases have been known in which a cock has mated with two hens, and even assisted both in hatching and rearing their young; while we once possessed a cock which, though he never aided them in family duties, regularly paired with no less than five hens. This case being so very remarkable, we took particular notice of it, and can vouch for the truth of what we state. To the naturalist such instances are particularly interesting; as showing that, under some circumstances, pigeons might possibly become gregarious like poultry.

The above paragraph we have taken word for word from the writings of Mr. Fulton, the best English authority, to which our attention was first called in December, 1908. Readers of this **Manual** will note that his ideas correspond with ours—indeed, such things are not a matter of opinion, they are a matter of **fact**. What one observer sees, another will see. In the light of the above, how absurd it is for a pigeon tradesman to represent in his advertisements or printed matter that he controls the matings or love affairs of his birds to the extent of assuring the probable purchaser that they are absolutely and irrevocably "married for life," "mated absolutely-never-to-be-changed." The object of such representation is to convince the probable purchaser that the pairs will go to work in a new home exactly according to schedule or pre-arrangement, and that all he has to do is to take feed and water to them, and exchange the squabs at intervals for half-dollars. Such claims are made with the intense anxiety of consummating a sale by assertions just a little more plausible, regardless of the habits of the pigeons.

TWIGS FOR NESTING MATERIALS.

Some pairs will build their nests entirely or partly of **twigs**, if given the opportunity. A customer in New York read of pine needles in this book, so thought of twigs. He put in half a bushel or so of dry old hemlock twigs. All used them and one pair made their nest wholly of them.

Another of our friends states that he has solved the nesting material proposition, as far as his own squab raising is concerned (pleasure and hobby). Instead of providing the birds any tobacco stems, or other nesting material, he does not give them anything, except to fill their nappies (or the little two-inch deep by 15-inch square boxes that he has for them to build in) with sawdust, or fine shavings from the local saw mill. The birds do well in them, and when he takes out a pair of squabs for the nippers, he empties out the sawdust, which nearly cleans the nappies and what does remain is very easily removed with trowel and brush. He then refills them with fresh sawdust or fine shavings, and they are ready for use again. He has found this very successful. New birds have to get used to the change but it does not take them long to take to it. Young birds of course, raised in them, do not know anything else.



PLYMOUTH ROCK EXTRA HOMER FEMALE

CLAMORING FOR SQUABS IN THE STATE OF WASHINGTON.

The squab market in the Northwest corner of the United States at this writing (1909) continues to be wonderfully strong. Our attention is called to this from time to time by correspondents in the State of Washington. Apparently there is no limit to the demand there, as in the other great States. We were surprised in September, 1908, to receive the following letter from the president of a hotel company in Seattle, proprietors of one of the best hotels west of the Mississippi river:

Kindly send me a half dozen of your pamphlets, covering the growing of squabs. I wish to send these to the small towns contiguous to Seattle—that is to the Chamber of Commerce of each town, to be directed to the right parties who would want to engage in this business. Quite a number have expressed their desire to do so. **We are anxious to receive nice squabs and will pay a good price.** Thanking you in advance for the pamphlets.

We thought it surprising that a hotel man should be inquiring for squabs in such an insistent manner and asked him for details. He replied under date of September 26, 1908, as follows:

I am in receipt of your treatise on squabs, likewise the booklets. **I have advertised in a number of country papers where the farmers are liable to take up this matter, informing them that they can increase their income and to write me and that I will send them a booklet.** I will send you later on a copy of the advertisement. There is no reason that a number of farmers should not take up this work, as I should think the extra grain they would have around for food would practically cost them very little.

Under date of October 9, he wrote us again the following letter:

Inasmuch as your circulars have all been used, we would ask you to send us about a couple of dozen more. We are advertising in the papers as per enclosed clipping, and have received many responses, which we think should bring you results.

The newspaper clipping showing how this hotel man was trying to stimulate the squab production was as follows:

WHY DON'T YOU RAISE SQUABS?

You have enough waste feed to do so without extra cost. We will tell you how and buy all you have—it will add largely to your income.

In a letter dated October 24, he explained his intentions more fully as follows:

In response to your recent favor, I beg to state the only object that we have in securing persons to raise squabs is that we may get sufficient to meet our demands. At the present time we find it difficult, just when we want squabs, to receive as many as we have a demand for.

My idea in advertising this in the paper was to not alone derive a personal benefit, but to help the country along in general. **We should all be up-builders, particularly in the West.**

We give this correspondence here the publicity it deserves and hope that our friends, old and new, in the State of Washington, will take hold energetically and give this hotel man, and the other squab consumers in Seattle, the **Plymouth Rock** squabs for which they are so eager. Evidently the State of Seattle is so prosperous with big enterprises that squab raising has to wait its turn and now is a sort of spare time money-maker. We feel confident, however, that there must be a large number of people in the State of Washington who are not too busy to overlook a good thing of such promise, and they will be encouraged to go ahead after reading the above correspondence.

Our shipments of breeding stock in 1908 to this State were quite large, fully as much volume as to California.

A correspondent in Acosta, Washington, wrote us in November, 1908:

I am going into the squab business in Washington (Lewis County). Squabs sell in Seattle and Tacoma markets at \$2.50 and \$3.50 per dozen, and the market is not supplied ten per cent of the demand. I have 15 acres to devote to this business.

OKLAHOMA AND INDIAN TERRITORY.

If a stranger to the poultry and squab industry were asked to name a section of the United States where chickens and squabs probably would sell the slowest, he might name Oklahoma and the Indian Territory. In this judgment he would fall into considerable error, for the people there are just as enterprising and just as fond of good things to eat as they are in the East, although there may not be so many of them. Witness the following letter to us dated June 27, 1908, from a prospective customer in a small city in the Indian Territory:

Some few weeks ago I wrote you for catalogue, now I want your squab book and you will find enclosed 50 cents in stamps to pay for same. How many pairs would you advise me to start with? The Almeda Hotel says they can handle from four to ten dozen a day. This hotel is the leading hotel of my city.

Four to ten dozen squabs daily is going some for one hotel in the Indian Territory.

Concerning Oklahoma, one of the leading poultry, butter, eggs, etc., houses in Oklahoma City wrote the following letter to one of our friends under date of March 14, 1908:

In regard to squabs, will say, that there are not any handled around here to speak of. There is no reason why it should not be a paying business, if some one would start here who understands it fully, and turned out a good article, just at proper age and of good quality, etc. No reason why a good demand could not be worked up for them here. If at any time you should raise more than you could put out locally, we could undoubtedly find a good market for them, as we are shipping out of here in carload lots weekly to New York City and California. Will be glad to give you any further information and have you write us.

In other words, the demand waits on the supply. Get busy, Oklahoma folks. Grain is cheaper for you than for us here in the East and if you may not succeed in getting New York prices for your squabs, you will make as much money as squab farmers here.

TWO YEARS' WORK IN MAINE. From 18 pairs of your Extra stock that I bought a little over two years ago, I now have 300 mated pairs and at least 50 pairs that will be mated very soon.—F. R., Maine.

GREAT SATISFACTION. I am pleased to be able to advise you that the pigeons which I purchased from you are giving me great satisfaction, as they have really doubled in number and the squabs have been very heavy, healthy, delicious. I am sure that you will be pleased to hear the above report—F. J., New York.

MINNESOTA GROWTH. I have a nice little plant of about 250 pairs from the stock I bought from you some two years ago.—M. H., Minnesota.

MOST PRACTICAL BOOK SHE EVER READ. The National Standard Squab Book is a most satisfactory treatment of the subject of squab raising. It seems to me to be the most practical book I have ever read on any subject.—Mrs. E. G. W., Washington.

HOW A RETAIL TRADE GROWS. My Plymouth Rock Homers are doing well. I am selling some of the squabs. One customer gets another, so I have orders for all I can spare at present.—G. R., Michigan.

TWO YEARS' BREEDING IN IDAHO. We take advantage of the present (February, 1908) to thank you again for the excellent quality of birds sent us in June, '06.—J. W., Idaho.

MORE STORIES OF SUCCESS

THIS CUSTOMER IS A TIN ROOFER AND MAKES GOOD WAGES BUT HAS FOUND OUT THAT HIS TIME IS WORTH MORE RAISING GOOD SQUABS. I will try and give you an account of how my birds are doing in the State of West Virginia. About 18 months ago I saw the advertisement of the Plymouth Rock Squab Company in a magazine and I decided to try a small lot of birds. I first wrote for literature, then sent fifty cents for a Manual, which I got by return mail, and would not take \$5 for it now. As soon as I got my book I sent for six pairs of Extra Homers, and to say they were fine would not begin to express my opinion of them. They were the finest birds I ever saw and every one says the same. I built a small house 6 by 6 feet for them at first, but soon had to build a larger one. I have a house 10 x 12 with a 12 x 20 foot fly, but this is too small now. I am trying to get a place in the country near town and will go into the squab business right. I have had my birds about 15 months, have had 180 birds hatched and have about 30 mated pairs now. I have sold all my squabs since March 1 at \$3 per dozen. One hotel takes all I have and could handle three or four times as many. I sell about a dozen a week. Feed is very high here, but there certainly is money in them anyhow. I have one pair that I bought of you that I have kept careful account of since they started to work. They went to work the week after I got them, and have laid and set every month since. They have hatched and raised 26 squabs, having lost two eggs, and today are building for the 15th time. If all were like them, I certainly would make the best record ever known. I have lost a few eggs and three or four young birds that were two or three days old, but I think that is a very small loss. I hope to get a location soon for I am convinced that there is good pay in raising squabs. I advise any one who is thinking of going into the business to buy their stock of Mr. Rice, for I consider him a perfect gentleman and as for the Extra Plymouth Rock Homers, I cannot say too much for them. They beat anything I ever saw. My birds are producing about nine pairs of squabs per pair, per year. The average weight of the squabs is ten pounds per dozen, which I consider very good. I hope to be able to send an order for more breeders before the fall and they certainly will be Extra Plymouth Rock Homers. I am a tin roofer by trade and make very good wages, but a squab plant of a thousand pairs I know will pay me much better. I use the self-feeder and your drinking fountain and find them perfectly satisfactory. I use tobacco stems and straw for nesting material.—W. M. C., West Virginia.

FOUND INSTRUCTIONS CLEAR AND CONVINCING. I thank you for your courtesy of September 22, and it is just what I wanted to know. I am so situated in regard to my present occupation that I cannot do anything before this time next year and then I hope to place my order with you for 300 pairs of your Extra Plymouth Rock breeders and 10 pair of the red Carneaux. I know you must be a busy man, but I wish to tell you I have been looking over every field that I know of for a man with \$1000 to \$1500.

I spent \$10 for poultry information which was so contradictory that I threw them all into the Atlantic and vowed never to have one near me. I then got your information, and everything has been so clear and concise that I have no hesitancy in knowing what I will do. The plans enclosed from you were about what I had figured out for myself, only I had given more room and consequently would have made the cost more if I had not spent 50 cents for your Manual and 10 cents for your plans. By so doing I consider I saved, or rather, will save, from \$75 to \$100 on my pens and buildings.

Pardon this long-winded letter, but I feel that apart from your trying to sell your stock to a probable customer I think all the more of you and your business methods, and know you will give me all you represent your stock to be when the time comes. Wish you and the Plymouth Rock Squab Company all the success you deserve, and that squabs will be eaten by a larger number of people.—R. H. W., New York.

MARKET FOR SQUABS IS LOW IN HIS PART OF TEXAS BECAUSE BREEDERS DO NOT PUT UP PRICES. "I got my pigeons from the Plymouth Rock Squab Co.," is the proud answer I give to any one asking me where I got my pigeons. When I tell them that I started with only 12 and have raised about 150, they say I have done wonderfully. Some other squab raisers around me have not raised half that many in twice that time. (They have common pigeons, that is the secret of it.) My pigeons have fully repaid me. I think they are 25 per cent better than any Homers around me. My birds raise from seven to nine pairs per year and I can sell all I can raise. I have about 100 breeders and they keep me stocked very well. The market prices down here are very low. They have been used to common squabs and do not know what is good, but I am going to raise the price all I can. It is only \$1.25 to \$1.50 and I hope to raise it to \$2.50. My squabs weigh from 10 to 12 pounds to the dozen. I have a self-feeder like the one in your Manual. I feed them a mixture of wheat and corn. I have followed your Manual strictly and have not departed from it in any way, and let me say right here that any one (even of those who do not know a thing about squabs) can take your Manual and read it through, follow it carefully and make a success. They are bound to make a success. I think the squab business is a great one and is increasing every day. I have not had sickness of any kind. I can sell at home all I raise.—W. P. C., Texas.

LETTERS FROM CUSTOMERS RECEIVED BY PLYMOUTH ROCK SQUAB COMPANY

MORE STORIES OF SUCCESS

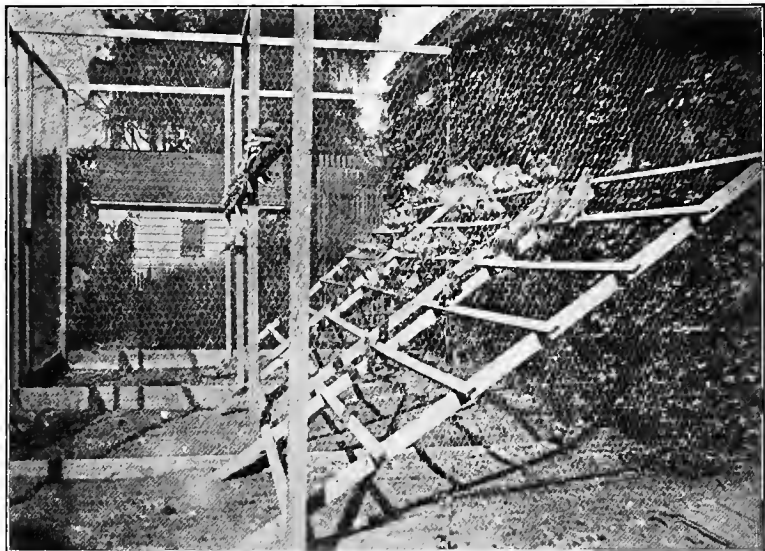

FLYING PEN OF A BARN.

This New Jersey breeder's story is on this page. At the top of the next page one of the ladies of his household is shown holding a nest bowl in which are three squabs from one hatch, two days old.

LOST ONLY ONE OLD BIRD AND THREE SQUABS IN FIVE MONTHS' BREEDING. I have had, I think, remarkable success with the birds so far, and thought possibly you would be pleased to hear it. The loss of one bird in the first lot shipped has been my entire misfortune, with the exception of three squabs, which I think the parent birds neglected. I have in the neighborhood now (August, 1908) of about 200 birds. Kind regards to your Mr. Rice.

For breeding my flock, I have used about half my stable and have not been troubled with either mice or rats, as I built another floor over the old one, raising the same about 18 inches, and do not think that there is any way for the rats to get at the birds; besides I have three cats that spend part of each day under the floors. You will see from the pictures that I have five units. They measure 10 by 12, with a three-foot passage in the centre. Watering, but not feeding, is done from this passage.

You are very welcome indeed to use my name, and you cannot write a letter too strong for me to endorse, referring to the treatment, etc., received at your hands, also the quality of the birds delivered me and the results obtained from them.—J. W. H., New Jersey.

HIGH-PRICED MARKET IN SARATOGA SPRINGS, NEW YORK. I like the National Standard Squab Book very well, as it plainly but fully tells everything necessary to know in the squab business and it becomes very useful to the pigeon fancier. There are boarding houses here in Saratoga Springs that pay \$6 a dozen for squabs from common pigeons, for I have sold them.—C. N. G., New York.

SQUAB BUSINESS IN MONTANA IS ALL RIGHT. Please find enclosed ten cents in stamps, for which mail me one copy of your plans and specifications for squab house. I am building new and larger quarters in the country and wish to build right. Seven of the Homers I obtained from you escaped from my pen in town, five returned. I have raised some beauties from my original stock. The squab business is all right.—R. C., Montana.

LETTERS FROM CUSTOMERS RECEIVED BY PLYMOUTH ROCK SQUAB COMPANY

MORE STORIES OF SUCCESS



THREE SQUABS HATCHED IN ONE NEST.

BUILT HIS OWN HOUSE IN WASHINGTON (D. C.), FOR TWENTY DOLLARS LESS THAN OUR ESTIMATE. I have a house constructed of all new material 12x16 and nine feet to peak, seven feet to eaves, divided into two rooms 8x9, a fly 8x16x18 divided down the center (doing all the work myself). Everything, including birds from you, cost me just \$47.58 or about \$20 less than your estimate, not so bad for a starter? I had a party call at my house, he hearing that I was going to raise squabs, offering me \$3 per dozen the year round. He will have to come again, as \$3 will not get mine.—C. C. B., District of Columbia.

CATHOLIC SISTERS RAISING SQUABS FOR THE PATIENTS IN THEIR HOSPITAL IN CHICAGO. We do not sell any of the squabs we raise, we use them all for our patients. We intend to have a photograph of our coop taken in order to let you see it and get your opinion about it.—Sister M., Illinois.

SELLING OUT IN TEXAS TO MAKE ROOM FOR PLYMOUTH ROCK HOMERS. Some time ago I purchased a Manual from you and received a Special Offer on your Extra Plymouth Rock Homers. As it was the best thing I heard of, and as I know your birds by their reputation, I got busy and began selling my stock off so as to make room for a sample shipment of your birds. I sold one customer in an inland village \$10 worth of my birds and when he remitted it was the whole amount in two-cent stamps. What I wish to ask, Mr. Rice, is will you take, say \$5 worth of them off my hands?—L. S., Texas.

ENLARGING TO A TEN-UNIT HOUSE. Last September I bought some breeders from you and same are doing nicely. As I want to enlarge my house, having bought a new place, I would kindly request you to send me as soon as possible a set of plans as per your offer in your Manual for a ten-unit house. Also send me some of your grit as per enclosed memorandum.—C. R., Conn.

LETTERS FROM CUSTOMERS RECEIVED BY PLYMOUTH ROCK SQUAB COMPANY

MORE STORIES OF SUCCESS

COMMON PIGEONS A FAILURE. REMARKABLE DEMONSTRATION OF WHAT FOUR PAIRS PLYMOUTH ROCKS WILL DO IN TEXAS. In February, 1907, I purchased 12 pairs of common pigeons from a friend, expecting to clear as large a profit from them as I could from the Homers. However, we soon found the difference for when we sold out about six months later, I am positive we did not sell more than 15 pairs altogether, that is to say, most of our squabs died or did not hatch. About the end of October, 1907, I received **four pairs of Number One Homers** from the **Plymouth Rock Squab Company**. About November 15 I got two pairs started and later on the other two started. I now (May, 1908) have 50 squabs and breeders and all our pairs are setting again. I have 15 pairs mated. I never saw anything like it. I have never seen any birds to equal ours in any respect. Our squabs are large and healthy, weighing not less than **eight pounds to the dozen**. I keep a careful record of the breeders and they average eight or nine pairs to the year. We do not know the price of them, as we have never sold any, but a friend of ours sold them at **\$4.80 a dozen**. These were common and Homers mixed and I am sure that if he makes money off of those poor breeders, we ought to make more off your prolific birds. We have fed corn, Kafir corn, wheat and a little millet. As we have followed your **Manual** as closely as possible, we have had no trouble with lice. We had two cases of canker, but we did what you advised and had no further trouble. I have not kept account of expenditures, but I know that the birds have well paid for themselves. My ideas of the birds and the business are O. K., and in the future I expect to raise more pigeons. You may be sure they will be **Plymouth Rock Homers**, as they are the best. I would have had no idea of the pigeon business had it not been for your **Manual**. I can tell you that it is all right and any one would be lost without it. I will always praise the **Plymouth Rock Squab Company** in the highest terms. (I forgot to mention above that on account of our house being improperly built some small animal got through a hole and took eggs and squabs. This happened three times but not any more).—E. G. R., Texas.

SMALL FLOCK PAYING A GOOD PROFIT. In April, 1906, I bought six pairs of your **Plymouth Rock Homers** and in just one year I had raised **85** birds. In May, 1907, 17 months after my first purchase, I had **110** or **55** pairs. I then began selling squabs, and in the eight and one-half months I have sold **228** squabs at **25 cents each**, which is **\$57**. I kill them with your killing machine, hang them up as your **Manual** teaches and bleed them. I do not have time to dress them, or I could get better prices. I have had none that weighed less than **eight pounds**, and many that weighed **10 pounds to the dozen**. The expense of feeding them the eight and one-half months has been **\$33.15**, a profit of **\$21.35**. I think there is big money to be made raising squabs. I keep this small flock in connection with 35 chickens, and only have time outside of business hours to look after them, which is ample.

I have seen lots of Homers, nice-looking ones too, but they do not breed as fast as mine. I follow your **Manual**, in fact, all I know about them is what the book says. I have had no sickness nor lice, simply kept them clean and fed red wheat, cracked corn, Kafir corn, buckwheat, hemp-seed, millet, oyster shells and plenty of good sand. My idea of successful squab raising is cleanliness, pure feed and water, and attention to business.—C. H., New York.

RAISING TOBACCO AND PLYMOUTH ROCK SQUABS. We grow 30,000 pounds of tobacco per year and make fresh stems constantly, bales run about 125 pounds. We have bought our first **Homers** from you and have done well. I am glad to hear from you on stems.—C. H. W., Connecticut.

PERSONAL INQUIRY AND ITS RESULTS. I am a member of All Souls Unitarian Church of Washington, made up of New England people largely, and many of them Bostonians. Also I go to Greenacre (Eliot, Maine), occasionally in the summer to speak on Emerson and his philosophy, therefore I have a large acquaintance up your way. I mentioned my intention in a social group of going into squab raising and asked incidentally about your place. They offered to get me the report and did so, but I do not know the channel. I did not care to know of your financial condition, but I was anxious to learn of your character and reputation. The report was very gratifying. In it was stated that you were "gilt-edged as to character and reputation." It made me feel good to get such a report, for I knew I could safely go on and enlarge under your counsel and advice. Thank you for your offer to assist me whenever I may call on you. If you happen down this way, try to see me either at the Bureau of Immigration or at my country home in Maryland, half-way between Washington and Baltimore, where we shall establish our plant. We are looking for a suitable piece of ground, say 10 or 20 acres, where we shall plant a good German and his wife and make it pay in other respects.—J. A. C., District of Columbia.

SQUABS WEIGHING OVER ONE POUND WHEN THREE WEEKS OLD. I have received the female **Homer** in good shape. It was a pretty bird. I just weighed some of my squabs which are not quite three weeks old and they weigh over one pound. I expect to order some more birds some time in spring.—H. S., Pennsylvania.

LETTERS FROM CUSTOMERS RECEIVED BY PLYMOUTH ROCK SQUAB COMPANY

MORE STORIES OF SUCCESS



ANY OLD PLACE FIXED OVER.

Results which are really surprising may be accomplished in quarters such as these, with good birds. (See the letter from the North Carolina man printed below.)

NO BIRDS ON EXHIBITION AT THIS NORTH CAROLINA FAIR COULD TOUCH HIS PLYMOUTH ROCKS. I received from you April 2, 1908, 13 pairs of Extra Plymouth Rock Homers. I have raised 60 birds, have sold 12 squabs and have lost 23, and I think that is doing well for six months' work. They have bred at the rate of four pairs per month. Some are slow, others are very fast indeed, and I have lost about 18 eggs on account of not having enough nest bowls, but have since put in more and will soon have to build. My house is of my own construction, very rough indeed, but I think answers the purpose very well, but in the future will build according to your plans except without the passageway.

The birds I received from you and those I have raised and mated are indeed hard to beat. I have not seen any here that can touch them, in fact, none on exhibition at the fair here held October 13 to 16, could touch mine. The squabs at killing age weigh about three-quarters of a pound each. Have sold only one dozen squabs to people who are sick at \$2.50 per dozen. I have fed whole corn, cracked corn, Kaffir corn, Canada peas, a little red wheat and a little green clover, cabbage cut very fine, and some rice and hemp seed about three times a week. Cannot say that I have followed your Manual in every detail. Please ship at once the enclosed order for feed. My birds are doing exceedingly fine and I am in hopes of being able to keep them so. I am well pleased with the squab business and intend to go into it for a living.—J. A. P., North Carolina.

A WOMAN WHO GETS HER PRICE FOR SQUABS ALL THE YEAR. The people who have eaten my squabs say they are delicious, plump, and so much better than the market ones. I am getting \$4.80 a dozen for them. That is my price no matter what they are in the market. They weigh over three-quarters of a pound each.—Mrs. E. G. A., New Jersey.

LOST ONLY ONE BREEDING PIGEON IN THREE YEARS. I have had my Plymouth Rock pigeons three years in July and have had splendid luck, having lost only one banded pigeon by death, and one flew away. I have studied the Manual and got lots of help from it. I only wish I had more room to keep more birds.—M. H., New Jersey.

LETTERS FROM CUSTOMERS RECEIVED BY PLYMOUTH ROCK SQUAB COMPANY

MORE STORIES OF SUCCESS

NINETEEN PRIZES WON ON 21 ENTRIES AT THIS LARGE WORCESTER COUNTY EXHIBITION. I have been breeding your Plymouth Rock Homer stock for several years. I have been a breeder of pigeons for a long time and enjoy the work very much and I want to tell you that I have never seen better Homers anywhere, nor do I believe that better stock exists than the strain you sell.

At the Worcester poultry show held in December, 1907, in Mechanics Hall, I entered 21 birds, nearly all your Homers, or bred from Homers sold by you. I had a few pigeons of another fancy variety in the show along with your Homer stock, but the Homers did nearly all of the prize winning. On the 21 birds I won 19 prizes, made up of 10 first prizes, five second prizes, three third prizes and one fourth prize.

The birds were very much admired by the people in attendance at the exhibition. On one white Homer which came from you and on which I won first prize I was offered \$5, but declined the offer. For another beautiful red checker Plymouth Rock female Homer which won me a first prize I was offered \$5 by another exhibitor, but I declined the offer. The judge of the pigeons told me I ought to send these two birds to the Boston show in January, as they were "world beaters." Sometime I am going to enter my birds at the Boston show when I get around to it and can spare the time from my regular business. I am confident that I will make them "sit up and take notice."

Your Homer stock is distinguished not only by the large size (which I have never seen equalled anywhere) but by their prolific breeding qualities.

A good proportion of my birds are the red checkers, and I value them highly. None of the Worcester pigeon men has birds approaching mine. In fact, there are two Englishmen in this city who have been breeders of birds all their lives and they told me that they never saw any that could equal my stock. A professional man of this city is a breeder of fancy pigeons well known over the United States. He entered some white Homers in competition at the Worcester poultry show mentioned above but my white Homers went way over anything which he had.

These large Plymouth Rock Homers of which you have sold so many during the past ten years have completely driven the small native American Homer out of the market. The old breeders of these small native Homers have hated to admit that your Belgium stock was better than theirs, but anybody with half an eye can see that a Homer which is almost half as large again as were the best American Homers is to be preferred, not only for squab raising but for fancy breeding, for anybody who wants the best. The enormous popularity of your business in handling this magnificent strain is well accounted for.—H. M. W., Massachusetts.

FIRST AND SECOND PRIZES AT THIS WISCONSIN COUNTY FAIR. It was February 1, 1907, when I got my first lot of Homers. They were the Extras. The pigeons are the largest and the best of their kind I ever saw. I would advise every new beginner to study the Manual before starting. I feel my birds two-thirds cracked corn to one-third red wheat in winter, two-thirds red wheat to one-third cracked corn in summer; dainties such as hemp seed, rice, peas, Kaffir corn and vetches. I have invented a little mill to crack corn. I bought some cracked corn but it was not half cracked. I can adjust my mill to crack any size corn I want it to. I have chickens in the same yard with the pigeons and they get along good. Your Manual is the best it could be. I don't think it could be improved much. I haven't had any trouble with lice or sickness. I think we will send another order as soon as we can get a place ready for them. The squab business is O. K., as well as a paying business. My pigeons took first and second prizes at Ocotno County Fair, September 3, 4, 5.—E. G., Wisconsin.

WON FOUR FIRST AND SECOND PRIZES AT TOPEKA, KANSAS, EXHIBITION. My birds that I got from you are doing very nicely. At the Topeka show I was awarded four first and second prizes out of 16 birds shown. I would have gotten another first, but I classed the bird wrong. The judge gave her first, but they looked on the judge's card and she was not under that class. At the show, two of my Homers got out of the cage and also out of the hall. They were fine-looking birds and built for flying. They started east and that is the last I have heard of them.—F. L. K., Kansas.

FIRST AND SECOND PRIZES WON BY PLYMOUTH ROCKS IN FLYING COMPETITION. I bought several pairs of your Homer stock about a year ago and am raising, and also flying those which I raised. I have also Belgians which I fly, but the young of your stock are equal. I can recommend your birds to anybody, and the flying club which I am in also know what they are. The last fly I made was 300 miles, at which I took first and second prizes on your stock. I thank you for sending me such quality of birds. W. J. K., Michigan.

AGAIN A SWEEP OF PRIZES AT ANOTHER NEW YORK COUNTY FAIR BY PLYMOUTH ROCK HOMERS. We had a county fair here and there was quite a large exhibition of fancy pigeons and a few Homers, but not any as nice as the ones that I had on exhibition. I took six pairs of old ones and five pairs of young about eight weeks old to match the old ones. I got first and second premiums on all.—F. S. S., New York.

LETTERS FROM CUSTOMERS RECEIVED BY PLYMOUTH ROCK SQUAB COMPANY

MORE STORIES OF SUCCESS

NINETEEN PRIZES WON BY PLYMOUTH ROCK HOMERS AND CARNEAUX BY ONE CUSTOMER AT THE GREAT ROCHESTER (N. Y.) EXHIBITION IN 1908. I am flat in bed with pleurisy but I want to let you know about the Rochester Show. I got fifteen out of sixteen prizes, and also four specials; losing only one third prize to a cock from the New York Show. All of my prizes were won from adult stock bought of you, and young raised from them last year. As soon as I am able to be up and out I will write you more fully. Excuse looks of letter as I am writing in bed. (Later). There were three old cocks and three old hens which were recently bought by a Rochester man in New York. The birds were said to have been in the New York Show and this man made his brag, that he got the birds to turn down the Lyons man, but my birds were cooped first and when he brought in his Carneaux and cooped them near mine, he told the president of the show that he guessed he did not have much chance. He got one third prize. All the rest were thrown out. I got four first, four seconds, three thirds, four fourths and four specials. (One special on best cock in show, a pair of record Homers, one special on best hen and two minor specials.) The last pair you sent me got, cock first, hen second. My Carneaux are doing fine and I have quite a number of young mated and at work.—R. I. C., New York.

PLYMOUTH ROCKS THE BEST HOMERS IN THREE STATES AT THIS BIG EXHIBITION. A NOVEL USE FOR PIGEON FEATHERS. I wish to thank you for suggestions offered, which enabled me to win first prize on Homer pigeons at the Tri-State Exposition and Livestock Show held at Chester, West Virginia, just across the Ohio river from our city. This was considered the best poultry and livestock show in this section of the country this season. Our local fanciers came out fairly good considering the opposition we had. Three of the largest breeding farmers in this section sent in a carload of poultry apiece. The second prize in Homers went to an Ohio man, one of the above mentioned breeders. I also got second on White Leghorn cockerel. My birds were shedding considerable, but I made good use of the long feathers as you will see by some enclosed advertising for the firm by which I am employed as well as for myself. They went like hot cakes after we got them started. Every one wore a feather. I don't know whether the value of this ever appealed to you or not, but I think that you could find ready sale for the light-colored feathers for this purpose.—S. E. A., Ohio.

Note. What he did was to gather up all the good-sized feathers lost in moulting and print them in red ink with a rubber stamp, "Welcome at Smith's," giving the name of the store where he worked. These stamped feathers were treasured as souvenirs. This idea could be used in other ways by squab breeders and the feathers handed out as advertisements.

VICTORIOUS AT TWO NEW YORK STATE EXHIBITIONS. When I was in Boston a few months ago, I promised you I would let you know how I made out at our County Fair, but for some unknown reason I did not get at it. I entered at the fair six birds. Four Carneaux took four first prizes, two Homers two second prizes.

I entered at Hudson Valley Pigeon and Poultry Association at Poughkeepsie, N. Y., seven birds, and won three firsts on Homers, two seconds on Carneaux. Did not enter my old Carneaux or would have taken first on them. I have a fine Carneaux cock that I think would be hard to beat, but the hen is not up to the mark. I think I will show the Carneaux at the New York Show.—J. R. V., New York.

TOOK EVERYTHING IN SIGHT. WON EVERY PRIZE OFFERED FOR HOMERS WITH HIS PLYMOUTH ROCK HOMERS AT NEW YORK COUNTY FAIR. The Homers that I bought of you last September are doing fine. I would like to visit your plant a little later if it would be convenient for you. I am going for the purpose of looking over your plans and to purchase some more breeders. I have now about 60 pairs and want to get enough to make 125 pairs. I entered those that I got of you at the Clinton County Fair at which I got every prize that was taken on Homers.—E. R. G., New York.

ONE PAIR OF PLYMOUTH ROCKS GOOD ENOUGH IN VIRGINIA TO BEAT PROFESSIONAL SHOW FOLLOWERS. The Plymouth Rock Homers you sent me have all been working. I carried one pair to the Roanoke Fair and received first premium over some Homer dealers from Pennsylvania.—F. E. H., Virginia.

TOOK FIRST, SECOND AND THIRD PRIZES IN WEST VIRGINIA. My birds are beauties, and took first, second and third premiums at the Poultry Show here, and I have been selling squabs right along that are fat and nice.—Miss G. E. K., West Virginia.

WON THE SILVER CUP AT THIS MICHIGAN SHOW WITH HIS PLYMOUTH ROCK HOMERS. I have had six pairs in the show and won the silver cup. People said they were the best they ever saw. I sold two pairs for \$5.—J. F. F., Michigan.

LETTERS FROM CUSTOMERS RECEIVED BY PLYMOUTH ROCK SQUAB COMPANY

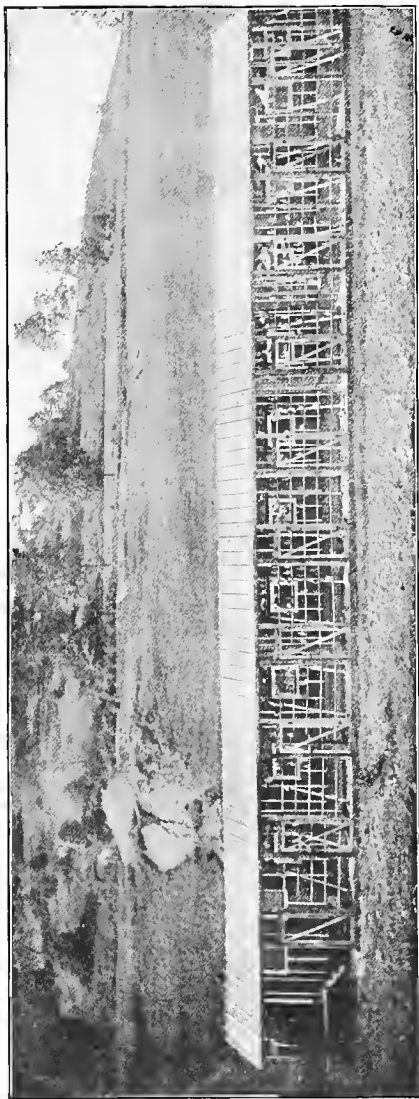

SQUAB PLANT IN PENNSYLVANIA PROTECTED BY HILLSIDE.

The hill at the back of this house keeps off the winds. The construction is quite simple and inexpensive, our roofing having been used instead of shingles. This customer started with 100 pairs of our Extra Plymouth Rock Homers which we shipped him January 23, 1908. On February third he ordered 200 pairs more and on November 14, 1908, 70 pairs more. He has another house in addition to what is shown in this picture.

MORE STORIES OF SUCCESS

FIVE PRIZES TAKEN BY PLYMOUTH ROCK HOMERS AT TENNESSEE POULTRY AND PIGEON SHOW. It would probably be of interest to you to know of my success with your Plymouth Rock Homers in our recent Poultry and Pigeon Show. I entered six of the eleven pairs that you sent me. I won two firsts, two seconds, and one third prize. The fine Homers I purchased from you won one, two, three, while two pairs of colored Homers that I raised from some birds bought of you won one, two.

Those grand white Homers you shipped me attracted more attention and were admired by more people than all of the other birds in the show put together. They are superb.

I placed the birds in my breeding pen at noon on Monday and on Friday afternoon four pairs had built nests and one pair had laid two eggs.

The youngsters raised from some of your birds that I referred to before are only eight months old and have been at work three months. I am enthusiastic over Plymouth Rock Homers.—E. D. R., Tennessee.

WON TEN PRIZES, TAKING ALL BUT ONE (A THIRD) WITH TEN PAIRS. At the North Adams Poultry Show I entered ten pairs of "exhibition Homers" made up largely from Plymouth Rock stock and was awarded five firsts, three seconds, one third, one fourth. I was "headed" but once and that was for a third place. The entries were made up of one pair reds, one pair red checkers, two pairs silvers, three pairs blue checkers and three pairs blue bars.—J. T., Massachusetts.

PAIR OF PLYMOUTH ROCKS THE BEST PAIR OF HOMERS IN THE 1908 TORONTO EXHIBITION. Only one pair of those Plymouth Rock Homers which I purchased from you were exhibited at the fair but they took first prize. The judges in examining them commented on the perfect wings, only one little feather being wrong. I know nothing of the standard but you will doubtless know what they meant.—T. S. C., Ontario, Canada.

PLYMOUTH ROCKS FIRST AS WELL AS SECOND AT THIS IOWA EXHIBITION. Our blue Plymouth Rock Homers took first and our silvers second at the show here.—C. D., Iowa.

HAS BRED THOUSANDS OF SQUABS IN INDIA FROM PIGEONS POORER THAN OURS. About a month ago when staying in Chicago I made an inquiry for your catalogue and about a week later I sent you 50 cents for your National Standard Squab Book. I read your book with great interest and must say it is the best written instruction to the beginner that I ever saw. I have bred thousands of squabs in India, where I was born and came to America to start a squab farm here. Of course, the kind of pigeons we use over there is not as good as what we use here. I have succeeded in getting a fine farm in Missouri, a very dry, healthy climate. Tomorrow I am going to the place and when settled there about a month (this time I want to make the squab houses) I will send you an order.—V. K., Missouri.

LONG SHIPMENT OF PLYMOUTH ROCK HOMERS ACROSS THE CONTINENT TO BRITISH COLUMBIA AND FROM THERE TO AUSTRALIA. I duly received your letter of May 12, and the birds came safely and in good order by the Dominion Express Company to Vancouver. You will be glad to know that they arrived safely at Melbourne on June 27. The Carneauux pecked three or four Plymouth Rock Homers, but today they are in splendid condition, having gone through the long, hot voyage very well. We, of course, looked after them on the steamer to see that the cage was kept clean and followed your instructions as to food, grit, etc.—Mrs. A. B., Australia.

SQUAB MARKET WAITING TO BE DEVELOPED IN THE PROVINCE OF ONTARIO. The National Standard Squab Book has given me much satisfaction, pleasure and also a longing to get into the business. I am a poultry plucker, bench-hand, feeder, etc. employed by the largest wholesale live and dead poultry handlers here. I originally sent for your Manual not with the idea of starting to breed squabs, but to add to my knowledge of feathered life. I found the book so interesting I have read it through several times and could answer correctly any question asked me from it. It is the most exhaustive treatise on the subject imaginable and I now consider myself an authority on pigeons. To show you how undeveloped the squab trade is here: I may say we do not receive proportionately one squab to every 100 chickens.—J. E., Ontario, Canada.

IMITATION NEST BOWLS. I must say my Plymouth Rocks are the best Homers I ever saw. Are the bowls as seen on page 48 of the Manual what are known as the Rice Wood Fibre Nest Bowls? I must say that I like them very much better than what are sold here as "Rice Wood Fibre bowls," as the ones here are almost flat.—M. R. K., Tennessee.

Note. The genuine wood fibre nest bowls can be obtained only direct of us from Boston. We do not supply stores with them. If bowls are offered you in stores as ours, they are not.

LETTERS FROM CUSTOMERS RECEIVED BY PLYMOUTH ROCK SQUAB COMPANY

MORE STORIES OF SUCCESS

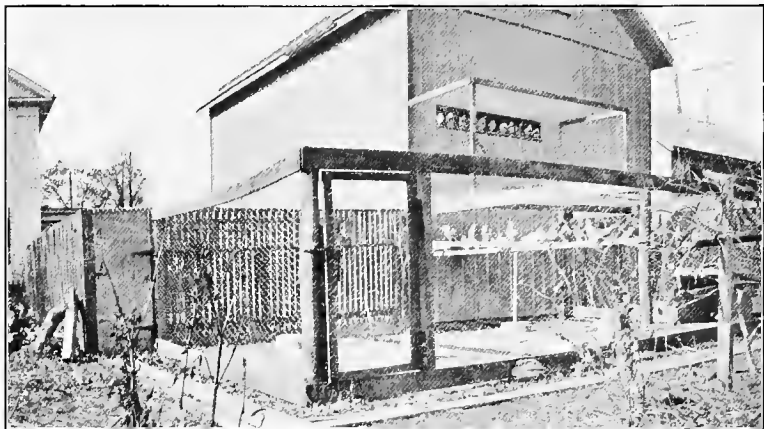

A NEW JERSEY PLANT.

This picture and the picture on the opposite page are both photographs of the same plant.

HIS BROTHER-IN-LAW IS HAVING A PROFITABLE EXPERIENCE WITH PLYMOUTH ROCK HOMERS. Yours dated November 20 was received this p.m. I shall be very much pleased to have the pair of birds as you suggest and will gladly pay transportation on the same. I do not consider you are under any obligation to "make good" under the circumstances, as I appreciate accidents will happen in transportation, but since you make this offer I will greatly appreciate the favor.

My brother-in-law, Mr. Merritt, has been telling me fabulous things of the squab industry, and I propose starting with the 12 pairs, allowing them to accumulate for two years, and determine positively the percentage of increase, profit, etc.

The birds Mr. Merritt purchased of you have certainly done wonderful work, and this, too, after being shipped to California and then to St. Louis. The birds you shipped me are truly very handsome, and feel sure they will do well. I have been breeding and shipping fancy poultry for the past 15 years.—R. W. B., Missouri.

KNOWN BY REPUTATION. I know you by reputation to be the largest and most successful and reliable breeders in America, therefore, I am to buy stock from you and would be glad to have your prices.—H. C. M., Tennessee.

MANUAL IS PREPARED EXPERIENCE. The birds I got from you are in every way larger and finer looking than any other Homers I have ever seen around here. Their squabs are larger at the hatch and incomparably larger at maturity, or four weeks. They seem to be attentive birds and extra good feeders. I love the business and I love my birds. I have followed your Manual as regards feeding and watering and find that I get the best results. It seems to be just what it is, prepared experience for the beginner. My policy was, if you don't know, refer to the Manual, and I always found that I did the right thing and very seldom if ever went wrong.—W. T., Virginia.

PLEASANT BUSINESS RELATIONS. Our business relations have been so pleasant and satisfactory I will leave it entirely to your discretion in making me a present of a pair of Extra Homers. (Copy of your letter attached herewith explains all.) My birds are doing finely and I know your book by heart and will follow it carefully all through. I will give you an order soon for more Extra breeders.—A. D. W., Kansas.

ONE YEAR'S INCREASE. Your book is the best I have seen and is very satisfactory. Just one year ago I purchased 24 pairs of your Plymouth Rock Homers. Now I have 200 young birds. I am well pleased with them.—W. A. L., Ohio.

LETTERS FROM CUSTOMERS RECEIVED BY PLYMOUTH ROCK SQUAB COMPANY

MORE STORIES OF SUCCESS

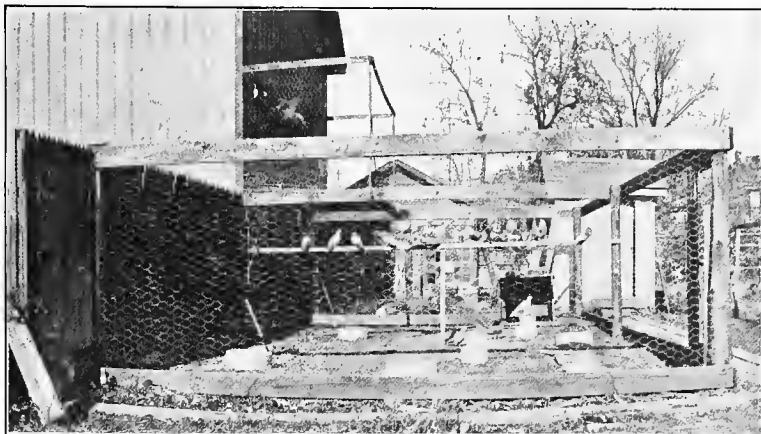

ANOTHER VIEW OF NEW JERSEY PLANT.

This breeder tells his story in a letter printed on this page over the initials B. F. B., New Jersey.

REPEATED ORDERS FROM A NEW JERSEY CUSTOMER PLANNING TO HAVE 5000 PLYMOUTH ROCK HOMERS. On April 6, 1908, I received from you six pairs of Extra Plymouth Rock Homers. On April 16, I received 13 pairs, and on May 9, 13 pairs more, the majority of each shipment being at work inside of a week after receiving them. Six pairs were laying on the second day after receipt. At the date of this writing (October 26) I have 100 young birds, as fine as you can find anywhere. The birds received from you and the young hatched by them are not beatable around these parts. I have not as yet weighed any of the squabs, but from handling them know that they will weigh all that you claim.

I have fed as your Manual directs and have not had any trouble from sickness or any sign of lice, as I am looking after my lofts at all times and keep perfectly clean. By doing this no lice will linger around. I am more than satisfied with your business dealings, fair and square in all respects. I have just received from you 104 pairs of Extras, and they are beauties, the talk of the town.

In the spring I expect to enlarge my plant so I can put in 5000 or 6000 birds, and you will have the order for stock, as I will know what I am getting. Thanking you for square dealing with me.

I will send you next week the \$150 for the two special offers and also give you shipping date. All the birds received from you in the past have been O. K. in all respects, but if you have some that you think will go ahead of them I wish you would send them, as I think it will be the means of a large order for you.—B. F. B., New Jersey.

PLEASED TO RECOMMEND PLYMOUTH ROCK HOMERS TO OTHERS. Replying to yours of July 31, in regard to our showing this gentleman around our plant, would say, that we will be pleased to do so. We feel sure he will not hesitate buying from you after he sees our birds for they are proof enough, to our minds, of your fair dealing. Permit us to say that it will be more convenient for us to show him around our place on some Sunday for then we are able to give him better attention.—L. O. N., New Jersey.

EIGHT TO NINE PAIRS OF SQUABS A YEAR FROM EACH PAIR OF BREEDERS. The 10 pairs of Plymouth Rock Homers purchased from you some time ago are all working very satisfactorily, averaging eight to nine pairs of squabs a year from each pair of breeders.—D. V. G., New Jersey.

THIS IS THE RIGHT TALK. If at any time I can get you any business, you can count on my doing so.—D. D. C., North Carolina.

LETTERS FROM CUSTOMERS RECEIVED BY PLYMOUTH ROCK SQUAB COMPANY

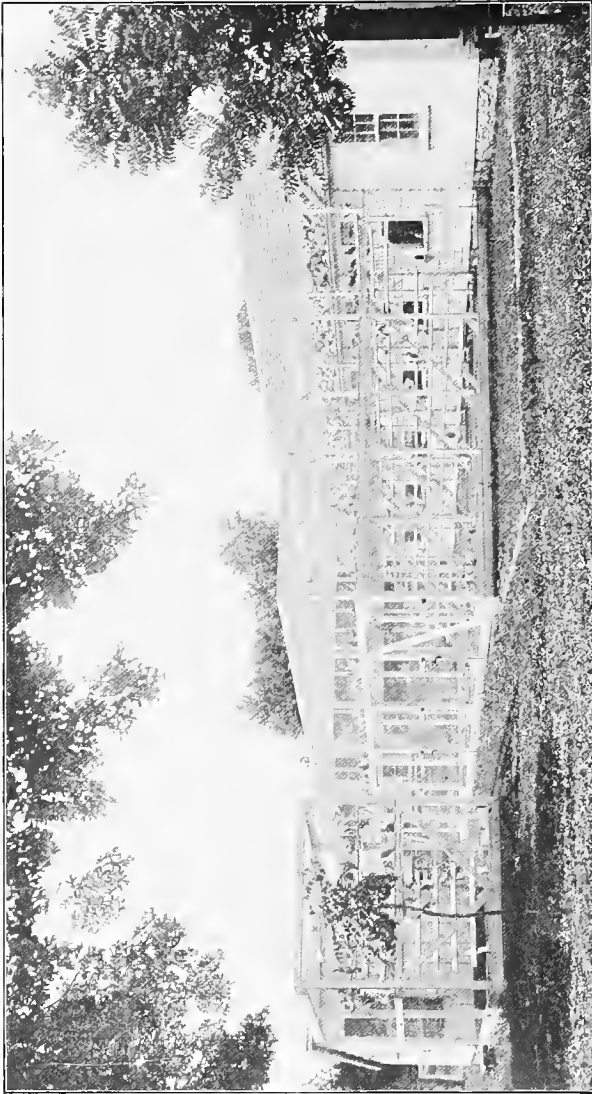

AN ATTRACTIVE MINNESOTA SQUAB PLANT.

This plant is on the farm of a well-known professional man, a lawyer. For description see matter printed on the page opposite this illustration.

MORE STORIES OF SUCCESS

THIS MINNESOTA CUSTOMER IS A PROMINENT LAWYER WITH A FINE FARM ON WHICH HE RAISES HIS OWN PIGEON FEED. The publication of my place in the *St. Paul Press* came about not upon my solicitation. All said is true enough and I doubt if I could improve it myself. Then I had the ranch and residence halftoned and stamped on envelopes and letter heads as per enclosed.

Of course, I have so much to look after that I am not able to give the pigeons much attention, but find them "good to eat" and nice in appearance. We have no difficulty now in disposing of all the squabs we can produce in St. Paul and at home. We get only \$3 per dozen which does very well here as the farms produce wheat, buckwheat, and corn enough for all the birds, horses, cows, hogs and chickens I have. This year I tried Canada peas with satisfactory results.

Our main house is 58 feet long, 16 feet wide, with seven-foot posts. It rests upon a stone foundation with stone piers in the center supporting the sills, and is about two feet above the surface. Drop siding is used for weather boarding and matched fencing for inside lining. The space between the lining and drop siding is filled with cinders. The floor is of two thickness of inch flooring and brake-jointed. Ten feet of this house is used as a storing room and for filling the drinking fountains. The building is supplied with heat and city water. There are six flying pens each eight feet wide, 10 feet high and 24 feet long, with roosts as shown in the picture and are covered with one-inch mesh wire number 18. The entire framework supporting the wire rests upon concrete foundations four inches wide and let into the ground about one foot. Each loft contains 140 nests, 70 nests on each side, leaving a space in the center of six feet. An entry way three feet wide extends along the entire north side of the building with a door opening into each pen. The small building is eight feet by ten feet with shed roof eight feet and five and one-half feet respectively in height. This is used as a mating pen, where an equal number of males and females are placed and when mated are banded and placed in larger lofts. The floor of each flying pen is covered with sand from four to eight inches deep.—H. W. M., Minnesota.

ENLARGING AFTER AN EXPERIMENT WITH THREE PAIRS. I am now making preparations to occupy a new building in the spring, and as soon as I can scare up the money, I want to order more breeders and about 20 dozen nest bowls, as I expect to have a two-unit house besides the one now occupied. I can't say enough about the breeders I bought of you. My first pair of squabs weighed two pounds, two ounces, the second pair two pounds, and by the looks of the third pair, I believe they will weigh more than any of the first ones. I am going to keep my young ones for breeders, also expect to add more of your stock in the breeding line. If I get my other house up, I can easily accommodate 150 pairs of breeders, and I want them just as fast as I can get them. I feed a little red wheat, Kaffir corn, millet and hemp-seed, buckwheat and barley and Canada peas. I have all told 10 kinds of feed, use the self-feeder for staples and my relishes I feed on a board with raised edges, which I remove from the pen after the birds have finished eating.—R. E. B., Pennsylvania.

PLEASED WITH WHAT HE SAW AT MELROSE FARM. I write to let you know I was very much pleased with what I saw at your farm in Melrose and the treatment which I received from your superintendent, and shall send you another order for some more of your birds by spring, as they are all right. If you have any new literature, would you kindly send me the same, as I want to keep in touch with you in regard to anything that I can learn for my benefit.—C. H. H., Massachusetts.

BETTER HOMERS THAN THIS FANCIER HAD IN HIS COOPS VALUED BY HIM AT TWENTY-FIVE DOLLARS A PAIR. Since I wrote you Saturday I had a great pigeon raiser call upon me to ask the privilege of looking at my birds you sent. I asked him to express himself in a candid way as to his opinion of the quality and also if he had any finer birds. He replied, "Well, I have several kinds. Some I consider are worth \$25 a pair, but I confess I have none that can hold a candle to those birds. They are extremely fine." He made strict inquiry about you and seemed wonderfully enthusiastic and, on his leaving me, remarked he certainly would have to send for some of those birds. I just simply mention this to you for your credit. This is one of the parties I mentioned to you in my first letter I wrote you, asking you to send me some good birds, as I did not want to be laughed at. I think you will receive some orders from this part of the country, at least I am hoping so.—T. S., Illinois.

RICH PEOPLE SURPRISED BY QUALITY OF PLYMOUTH ROCK SQUABS. Two years ago I bought 12 pairs of Plymouth Rock Homer pigeons of you with the intention of raising squabs for market. I have never lost but one of the old birds and now have a flock of 225 or 250. About 100 are just beginning to mate. I sold some of the squabs to a lady from New York who comes here for the summer, and her colored servant, who came to buy them, said they were the nicest ones he ever saw. The lady lives in an expensive part of the city.—W. R., Vermont.

LETTERS FROM CUSTOMERS RECEIVED BY PLYMOUTH ROCK SQUAB COMPANY

ST. LOUIS POST-DISPATCH

Greatest Banquet Ever Given in the West Will Be That at the Coliseum Saturday Night.

When hungry Republicans, who have been crowded away from the political pile counter in Missouri for 38 years, gather for their banquet at the Coliseum, Saturday night, they will face the greatest quantity of food ever served at a single eating fest in the West.

There will be seated in the great dining room 2266 Republicans. They will occupy 78 tables, and 225 waiters have been engaged to serve them.

Lyman T. Hay of the Jefferson and Planters hotels, who has undertaken to satisfy the appetites of the hungry Republicans, has ordered food in the following quantities:

- 225 gallons of soup.
- 1200 pounds of fish.
- 1000 pounds filet of beef.
- 2266 squabs.
- 2500 large rolls of bread.
- 200 loaves of bread.
- 700 bunches of radishes.
- 200 bunches of celery.
- 55 gallons of olivea.
- 10 boxes of lettuce.
- 10 boxes of chicory.
- 10 boxes of tomatoes.
- 30 dozen bunches of parsley.
- 30 cases of lima beans.
- 60 gallons of coffee.
- 25 sacks of potatoes.
- 100 gallons of ice cream, with large quantities of assorted cakes.

Sixty Cooks to Cook It.

Early Saturday morning 60 cooks and

helpers will be set to work in an immense temporary kitchen in the basement of the Coliseum to prepare the great feast. They expect to have the dinner ready for serving when the guests are seated at 6 p. m. sharp. The 225 waiters will be divided into two squads, and will work from each end of the arena toward the center.

It is expected that it will require from 90 to 105 minutes to serve the meal. Mr. Hay is having the tables made, and will procure the 2266 chairs needed, and have them sent to the Coliseum before the dinner bell is fapped.

Mr. Hay is assisted by J. D. Tellman, who will be the general superintendent at the banquet hall; Max McCurlee, who will have charge of the service, and Fred Laufgatter, chief engineer of the Planters Hotel, who will arrange for the heating service and gas stove connections.

West's Biggest Banquet.

Mr. Hay says that the banquet will be the biggest ever given in the West.

The guests of honor and the speakers will be seated at the head table, on which 52 plates will be laid. Gov.-elect Hadley will be the principal guest of honor. Jeptna D. Howe, chairman of the Republican City Committee, will be the toastmaster. The banquet is being given by the Republican City Committee to celebrate the victory in this State. All of the leading Missouri Republicans have been invited.

HUNDREDS OF SQUABS EATEN AT ONE BANQUET.

The above clipping from the *St. Louis Post Dispatch* printed in November, 1908, shows what St. Louis people think of squabs. Squabs are certainly being eaten in the West. To provide the 2266 squabs which were eaten at this banquet would take one year's output of a plant of 150 pairs of Plymouth Rock Homers.

MORE STORIES OF SUCCESS

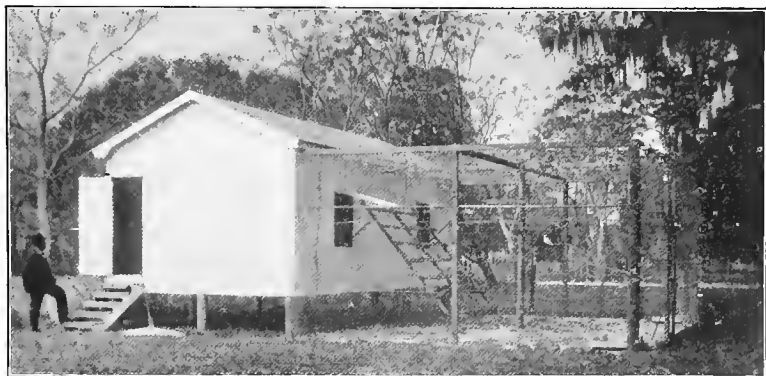

MISSISSIPPI SQUAB HOUSE.

The house is 14x26 feet and the flying pen 20x26 feet 11 feet high. There are two galvanized iron bathpans in the flying pen with water piped to each. The drinking fountain is inside the squab house and is made of six one inch T's put together with nipples, making the whole eight feet long with water running through it all the time, and the T's nearly full. This gives them plenty of fresh drinking water all the time and it cannot be fouled by the birds. The house has 76 egg crates for nest boxes and can take forty more when needed. The white line seen at the back of the picture is a much traveled shell roadway and the birds are much admired by passers-by. Of course it is not necessary to build a squab house so warm in Mississippi as in the North.

NINETEEN PAIRS INCREASED IN TWO YEARS TO FIVE HUNDRED BIRDS WITHOUT SPECIAL INSTRUCTION AND WITHOUT SYSTEM. I never had one of your Manuals. I merely put the 19 pairs of pigeons I first got from you about two years ago in a house 12 feet square and about 9 feet high, with a flying pen 20 feet by 12 feet by 9 feet, and have let them be there ever since. I have now about 500 birds and a nicer bunch of birds I have never seen. They are very much crowded at this time and many of the young are being killed by the push. I have now let contract for larger quarters and expect to remate the flock (if such a thing is advisable), and have separate pens, thus dividing the flock, and I am very anxious to get all the information possible so that I will make no more mistakes. I enclose 50 cents in stamps for the Manual. There are three or four persons in town who have small flocks of pigeons and they sell squabs at \$1.50 a dozen, but they are small and mixed breeds, and do not have enough to supply the wants of the people. We have not as yet sold any squabs, but expect to charge at least \$3 a dozen. We have a start now and my brother is going to help with the birds and we feel that there is a nice income ahead of us. I have been closely confined to my office duties, thus the birds in the past have been neglected.—G. J. G., Kansas.

RAISED A FINE FLOCK FROM A FEW. I visited a friend of mine in Erie, Pennsylvania, last week (August) and he showed me a fine flock of pigeons that he has raised from 12 he bought from you in the spring. Will you kindly send me prices for six pairs and 12 pairs, also illustrations and different kinds you have.—B. K., Pennsylvania.

FIVE TIMES BETTER THAN COMMON PIGEONS. The three pairs of Plymouth Rock Homers are doing as much as the 15 pairs of common pigeons I had in the same quarters last summer.—G. S., Wisconsin.

BREED RAPIDLY IN FLORIDA. The birds received from you have done extra fine. Our stock has more than doubled already. Enclosed find check for which send by freight 100 pounds of your health grit, 100 pounds of oyster shells, 100 pounds mixed pigeon grain, and two dozen nest bowls.—J. D. C., Florida.

NO MORTALITY. I have followed your Manual's instructions to the letter and have never lost a bird, when once out of the nest, and only three squabs, and they were only two or three days old.—W. O., New Jersey.

LETTERS FROM CUSTOMERS RECEIVED BY PLYMOUTH ROCK SQUAB COMPANY

MORE STORIES OF SUCCESS

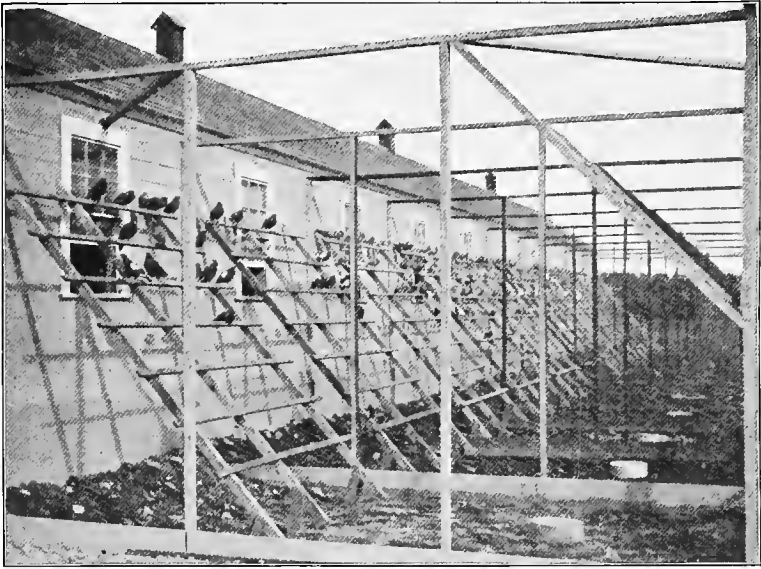

A MASSACHUSETTS PLANT.

For description see title underneath cut on opposite page.

COMMON PIGEONS IN UTAH FOUND A POOR INVESTMENT IN COMPARISON WITH PLYMOUTH ROCK HOMERS. I recently purchased one of your Manuals and find in it a world of very valuable information. I have at present a pen of 300 common pigeons which are profitable, as I dispose of all the squabs I can raise at \$3 per dozen. A friend of mine who purchased some of your Extra Plymouth Rock Homers some time ago gave me six pairs of his birds, and I must say they are the greatest workers I have ever seen. My common birds are for sale, as the Homers have taken their place in my estimation, one pair of your stock to three pairs of common. As soon as I can dispose of the birds I now have (except my pen of Homers) you can depend on a good-sized order from me for your stock. I will also want a few pairs of the Carneaux you so highly recommend. If they beat your Homers they must be great workers. I put the Homers in a separate house with eight-foot flying pen on the second of July last and at present date, November 7, they have raised 34 young and four pairs are again with eggs. I have considerable trouble in getting proper grains, that is, Kaffir corn, hemp seed, Canada peas, as no one here handles them. Will you kindly inform me as to where I may purchase same, and if not too much trouble quote prices. I hope to be able to dispose of my common stock and replace same with your fine birds.—G. S. W., Utah.

EIGHT PAIRS OUT OF NINE QUICKLY AT WORK. Recently my son received nine pairs of Extra Plymouth Rock Homers and it is his wish that I notify you of their safe arrival and that he is well pleased with them. Eight of the nine pairs are at work. In fact he has a dozen young, and eggs to hatch.—S. P. T., Missouri.

BURNED OUT, BUT STARTS A NEW FLOCK. Please send me a catalogue of your best stock. I bought some Extra Plymouth Rock mated birds about a year ago of you, but lost all in a fire which burned the pigeon house down. I made good money on them and liked them for pets very much and I wish to stock up again.—J. R., Missouri.

LETTERS FROM CUSTOMERS RECEIVED BY PLYMOUTH ROCK SQUAB COMPANY

MORE STORIES OF SUCCESS



ANOTHER VIEW OF MASSACHUSETTS PLANT.

The customer whose main plant we illustrate on this page and the preceding page lives not far from our Melrose farm. His building has been erected after our plans and is a duplicate of our own buildings with slight variations. One of these variations is ventilators in the roof, an excellent idea. The ventilators in our own houses are at the ends of the houses, which generally serve well, but on very hot days in summer we have felt the need of additional ventilators in the roof as this customer has built them. He has room enough in the cellar of his house to grow mushrooms and rhubarb. The rhubarb grows fast and to great size. This customer grows rhubarb five feet high in the dark in such a place and there is a good market for it. He is a market gardener and understands how to utilize the under part of his squab house in this manner. He heats this house and the cellar under it with a hot water plant. If any of our customers wish to put in hot water heaters, write us and we will give you the benefit of our experience. We have tried three kinds of heaters at our Melrose plant, in fact we have three different kinds in use there now and have learned something about the different makes and can give helpful advice on this subject.

HALF-INCH MESH WIRE NETTING OVER THE SILLS TO MAKE IT IMPOSSIBLE FOR RATS TO GNAW THROUGH. I got birds from you last summer, two shipments of the Extra. What do you ask for them now, as I want to get some? Your birds are fine and doing well. I have nearly 1000 birds and have a fine place, building 130 feet long, 14 feet wide, cut into units, south front, matched lumber outside and in. I used a certain building paper all over outside, tar paper inside. I intend to raise 10,000 birds and put up more buildings. Hog rings are the thing to use to weave the wire netting. I put fine wire netting, half-inch mesh, one foot wide, the entire length of building on the joist over the sills before floor is put down. No rats can get in.—F. E. B., Iowa.

FOUR HUNDRED PAIRS BRED FROM SIXTEEN PAIRS PLYMOUTH ROCK HOMERS IN THREE YEARS, AND 700 SQUABS SOLD. I purchased 16 pairs Plymouth Rock Homers from your company in July, 1905. I have about 800 birds now (October, 1908). I have sold about 700 squabs, nearly all for \$3.50 per dozen, but of late I have had hard luck with rats. They have not been breeding well for about two months. I have lost quite a number from going light and dumping around. I thought perhaps they needed some of your health grit or something of that kind and I enclose an order for your health grit.—H. S., Michigan.

BETTER THAN OTHERS. Last spring I bought 52 pairs of Plymouth Rock Extra Homers from you and like them better than any I have. They have done better than birds I paid more for, and I want to get some more of them, but I have no room. I want to sell 100 pairs which I bought in Connecticut. C. B., Connecticut.

RAPID BREEDING IN VIRGINIA CLIMATE. One or two of my pairs lay every seven weeks. The others all do better. One pair lays every month. The squabs that I raise average one pound. I feed mostly corn, wheat, barley, and small grains of whole corn. Sometimes I crumble up toast for them.—P. S., Va.

LETTERS FROM CUSTOMERS RECEIVED BY PLYMOUTH ROCK SQUAB COMPANY

MORE STORIES OF SUCCESS

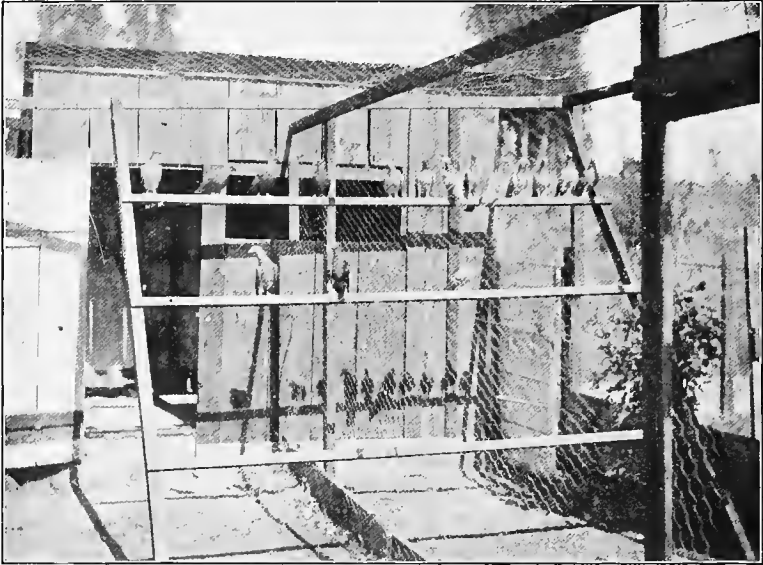

CALIFORNIA SQUAB HOUSE.

The breeder is doing very well in this unimposing place.

SQUABS SELLING BRISKLY FROM A LARGE FLOCK OF PLYMOUTH ROCK HOMERS IN CALIFORNIA. I have 30 pairs in a pen and can count 24, 26 and 30 nests in a pen, so that is speaking well for Plymouth Rock Homers. I have raised only 20 pairs from them for breeders, as there is a big demand for squabs. If I had \$3000 I would put \$2000 of it into Plymouth Rock Homers.—W. I., California.

MANUAL PROVEN TRUE BY EXPERIENCE. I recommend your firm and addressed an envelope to you yesterday morning for a man over in Calhoun, Tennessee, just over the river from Charleston. I think you will land him as a customer. I like your Manual very much as I take it alongside my experience with your birds. The simple truth shines forth on every page, and if there is any criticism I can offer, it is pertaining to the limited index, which is not really a fault for in searching for a certain point one reviews points that he cannot know too well.—P. E. O., Tennessee.

Note. Sometime we hope to have a full index for this book. If this paragraph meets the eye of a squab raiser who is also employed in a library or publishing house and has done indexing, I wish he or she would write me.—E. C. R.

EVERY PAIR AT WORK IN THREE WEEKS FROM DELIVERY. On July 29 the Plymouth Rock Extras reached us. We put them into the pigeon house immediately and were more than surprised at the readiness with which they adapted themselves to their new surroundings. We are delighted and are planning to order more birds just as soon as we have a place ready for them. Our boy would like to know how our record compares with others. Every pair at work in three weeks time. Is that equal to the usual standard?—E. S., Pennsylvania.

TRIED THEM ONE YEAR AND WANTS MORE. Please send me price-list of the Extra Plymouth Rock Homers. I bought some of you a year ago and I like them fine. I wish some more at the same price.—L. V., Illinois.

LETTERS FROM CUSTOMERS RECEIVED BY PLYMOUTH ROCK SQUAB COMPANY

MORE STORIES OF SUCCESS

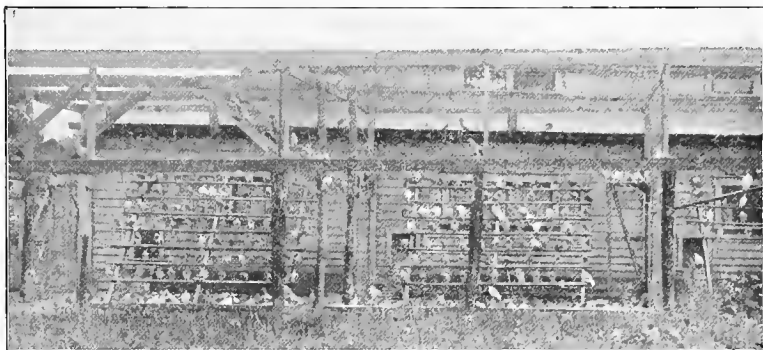

SMALL OPENINGS UNDER THE WINDOWS.

This photograph of the plant of a Pennsylvania breeder, shows small openings from which boards extend to the ground. In winter weather or at any time when it is not desired to open the closed windows, this small opening in each pen can be used. Some breeders have a rope and pulley attached to the slide of such an opening, manage the opening and closing by pulling on the rope from the passageway, and do not have to enter the squab house.

OLD TWO-ROOM COTTAGE CONVERTED INTO A SQUAB HOUSE. BEST BIRDS IN 15 YEARS' EXPERIENCE. After having so many letters from you, reading your Manual and then looking at your photo, I really feel that I am well acquainted with you. I received your last letter several days ago and would have written you sooner, but for a rush in business. I am highly pleased with all the birds purchased from you and especially the last shipment you made me. Those birds are the very handsomest I have ever seen and have been admired by every one that has seen them. They are getting down to work now. My house and pen cost me very little and yet I have almost an ideal home for my birds. Away back in my garden I have an old two-room cottage with gable roof covered with shingles. This I have turned into a home for my birds. The rooms are about 10 by 10 and eight feet high, or maybe a little larger. One of them I have almost filled with nest boxes (as you make them) and the other I keep for feed, etc. My pen is 24 feet long, 12 feet wide and about 18 feet high, taking in one side of the roof. In your Manual you do not recommend using the roof, but I have gone against you in this one thing and am allowing mine to enjoy the roof. I do not use poles of any kind in my pen. I have three running boards all the way around and find that much better than the poles. The floor of the flying pen is covered with good coarse sand taken from an island in the river here and I feed them as you direct in your Manual.

I have raised birds for the last 15 years, but have never had such success as I am now having. I keep them more for pleasure than anything else, but of course later on will begin selling off a few. Dr. Robinson tells me that he is meeting with success also. He has asked me several times to go down and see his birds, but I live way out of town and hardly ever stop around his place. Anything I can do for you in the way of directing a customer to you I will gladly do. As I have written you before, it is a pleasure to do business with you. Dr. Robinson made the same remark to me several days ago. F. E. M., Virginia.

FIRST PURCHASE LEADS TO A SECOND.

Enclosed find remittance for which please send your special offer No. 1. For your information, I will say that the birds I purchased of you have done well and of course their record recommends you to me for more. I quote you to my customers and friends. We have five pens and will keep this lot separate to note their points, for we are trying for 2000 pairs and as fast as money comes to us we will buy.—G. B. D., Alabama.

FAIR METHODS. It is certainly a pleasure to do business with your firm. I must express myself at the fairness of your methods. I wish you success and assuring you you will hear from me again.—L. L. J., Pennsylvania.

RAPID REPRODUCTION IN ILLINOIS. The 15 pairs I got from you in the spring have done finely. I have raised (September) about 50 pairs of young ones. They are all very good.—B. F., Illinois.

LETTERS FROM CUSTOMERS RECEIVED BY PLYMOUTH ROCK SQUAB COMPANY

MORE STORIES OF SUCCESS

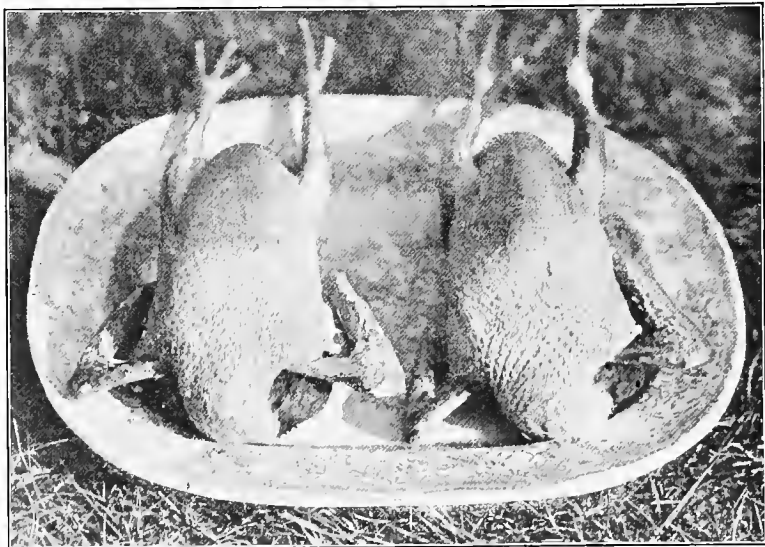

A PAIR OF SQUABS FROM PLYMOUTH ROCK EXTRAS.
These squabs weigh a pound apiece as you see them on the platter.

IN TWO AND ONE-HALF YEARS THIS ILLINOIS CUSTOMER BRED A FLOCK OF 650 FROM 12 PAIRS EXTRA PLYMOUTH ROCK HOMERS, ALSO SELLING SQUABS. On March 13, 1906, I ordered 12 pairs of your Extra Plymouth Rock Homers. I kept a record of them all the first year and found the best pair hatched the tenth pair of squabs on April 11, 1907, the average being nearly seven pairs of squabs to each pair of breeders. I consider this pretty good for the first year.

In the winter and spring of 1907, I built a new loft 50 feet long, 12 feet wide, divided into five pens with orange crates which I used for nests. Each pen has a wire run 10 x 20 feet, facing the south. The whole building is covered with roofing. I now (October, 1908) have 650 birds altogether. About 400 of them are mated and I presume the rest of them will be mated by next spring. The first ten squabs raised from your birds I sold for \$1 each when about six weeks old to a party here who was very anxious to buy them. Since then I have been keeping all the choicest squabs for breeders and the smallest squabs I have been shipping to market with the squabs of the common pigeons which we have breeding squabs around the barns. The last two months I have been shipping all of the squabs to the Chicago market, as I now have birds enough for my building capacity. My intention is to sell squabs for a while, then I may put up more buildings and start on a larger scale if everything looks satisfactory. I am at present getting from \$2 to \$2.50 per dozen for the squabs from the commission men in Chicago. In some of the large hotels they are paying forty cents each for squabs weighing 9 to 10 pounds to the dozen. I have not started to sell to the hotels yet. My best squabs weigh about 10 pounds to the dozen.

Corn and wheat are the staple articles of feed, and twice a week I feed Kaffir corn, Canada peas, buckwheat, hemp and some barley. For nesting material I use tobacco stems and therefore have not had any trouble with lice or vermin.

Your birds are the largest I have seen as I have been to other squab raisers near here. If ever any time I purchase more birds, it will be from your plant. —E. M., Illinois.

LETTERS FROM CUSTOMERS RECEIVED BY PLYMOUTH ROCK SQUAB COMPANY

MORE STORIES OF SUCCESS

EXPERIENCED PIGEON RAISER PAYS A HEARTY TRIBUTE TO THE DEMONSTRATED SUPERIORITY OF PLYMOUTH ROCK HOMERS On seeing one of your advertisements I was induced to send for your free squab book and other literature to the extent of purchasing one of your **Manuals**. I am always eager to learn of new methods in the pigeon business and to give a little time experimenting upon "claimed-to-be" better stock. On receiving your publications I began to carefully scan them to see what new thought or idea I might glean from them. In some instances I thought you were making rather extravagant claims, as most advertisements generally do. They praise some of the most worthless articles to the highest notch, leading folks to purchase something in which they are very often sorely disappointed.

This is not so in your case, for of all the claims you have made for your birds, I can truthfully say the "half has never been told." In my opinion there are no better. They are as perfect a piece of squab machinery as nature can create and man improve upon.

How well I am pleased with the birds I bought of you is well attested by the fact that I am enclosing another order for more of your **Extra Plymouth Rock Homers**.

In July, 1907, I sent my first order. They were the largest Homers that had ever been in my neighborhood, as many persons who came to see them attested. Within less than three weeks after I had placed them in my lofts they had accustomed themselves to the place, several pairs had laid and set. With machine-like regularity they have given me a pair of eggs on an average of every five and one-half weeks. I do not mean to say that they have given me a pair of squabs for every pair of eggs laid. The difference between the eggs laid and the squabs hatched from them has been so slight that a harsh critic cannot find fault. Some of my first pairs of squabs from your birds have already laid and set.

I have not allowed any sickness or lice to invade my lofts; I believe the vitality of your birds is of such strength that with little care and proper feeding one need never have any fear of them.

I have been very careful as to how I have fed them. My plan of feeding is as follows: Wheat and corn are my main feed. Each day I feed a relish, Sunday hemp, Monday Canada peas, Tuesday Kaffir corn, Wednesday millet, Thursday hemp, Friday Kaffir corn, Saturday I feed a grain which I obtain from my dealer called vetches; the birds relish this very much.

I feed whole corn at all times as most of the cracked corn we get is of an inferior sort, something which could hardly be sold in the whole grain. My feeding plan may seem a little expensive, but I am after results and as the birds are giving me those results, I feel that they are amply repaying me for my trouble. One cannot expect to get out of pigeons what they do not put into them, so with poor feeding one can expect but poor results. I am more than satisfied with the quantity and quality of the squabs they have given me. My squabs weigh from 12 ounces to 16 ounces apiece, as fat and juicy as they can be. I have some which were ready to be killed in 25 days.

I have had one bad experience since I have had your birds. On one occasion I was unable to obtain necessary grain from my regular feed dealer, so I had to purchase of another who sent me some inferior stuff. My squabs began to show the difference in that they were not so plump and fat. I soon discarded this and my squabs went back to their original size. During the moulting period your birds showed no visible signs of their being affected by it save the loss of feathers. They appeared as though there was no strain attached to it. During the cold weather they have done equally as well as in the warm weather.

It is not my intention to lead any one into believing that all he has to do is to purchase **Plymouth Rock Homers**, put them into his loft regardless of care and proper feeding, and they will prove a success. But I do claim that with little care they will give the same if not better results than they have given me. I have sold some of my squabs for as high as one dollar a pair, and got as high as \$5.50 a dozen for some.

My opinion of the squab business is that it is yet in its swaddling clothes with every indication of a successful growth. The demand for the large, plump squab is daily increasing. Breeders with such stock as the **Plymouth Rock** are the only ones who will be able to supply this demand. I have the greatest of hope in the business. It is one of the greatest investments of today. In my opinion there are but a few honest investments which give better returns for money, at least I have found none better.

I am in the squab business now as a side issue. I look for it in the near future to pay me larger returns than the salary I am now getting, which is \$1100 a year.

My present plant is composed of three lofts with a capacity of nearly 300 pairs of birds. I have other Homers than yours and have compared the two to see which give the better results. I must confess that I have **A No. 1** birds, but yours excel them by far in the number and size of squabs.

I shall in a little while have only your birds on hand as I have already learned that they are in a class by themselves and as an investment no stock can equal them. Enclosed find my order, wishing you much success.—H. N. B., District of Columbia.

LETTERS FROM CUSTOMERS RECEIVED BY PLYMOUTH ROCK SQUAB COMPANY

MORE STORIES OF SUCCESS

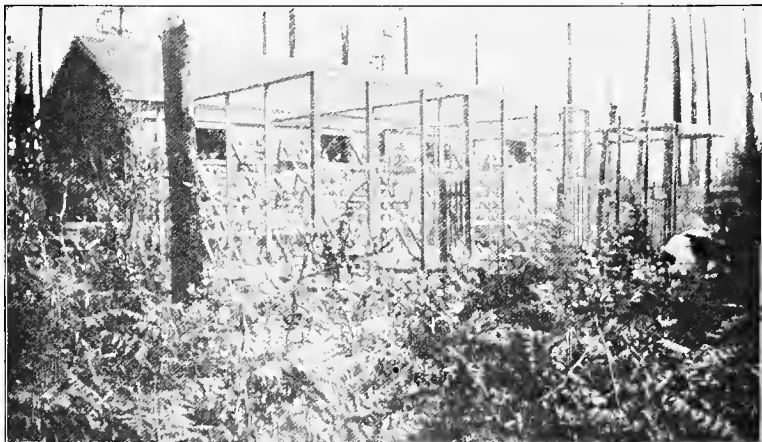

SQUAB BUILDING IN BRITISH COLUMBIA.

This looks like a view in tropical Florida but it is not; quite the opposite. It is the plant of one of our customers in Northwest Canada, British Columbia, being on the edge of a clearing the foreground showing underbrush. There is an excellent market for squabs in British Columbia, same as everywhere else.

CANADIAN MARKET GROWING. NO HOMERS IN THIS ONTARIO TOWN TO COMPARE WITH HIS. SQUABS WORTH \$3.50 A DOZEN. The first part of October, 1907, I ordered one dozen pair of Extra Plymouth Rock Homers and was surprised at the promptness of your shipment. But I had everything ready and liberated the birds in their new home. As it was their moulting season when I received them, they did not lay for nearly four weeks, but when they did begin they worked like Trojans. One pair has laid 12 eggs in the six months I have had them, and I had a pair of squabs that weighed over two pounds, 28 days old. The market quotations give such and such a price for squabs weighing 10 pounds to the dozen, but do not quote 11 and 12-pound squabs. I am confident that with care in selecting breeders from your stock, one could get squabs up to 10-pound mark every time. There are no birds in town to compare with mine. Everybody that sees them comments on their trim, business-like appearance.

I have gained a little experience now, and intend building pigeon houses to accommodate about 400 breeding pairs. If things continue as they are now, I may go into the business for a living. Your Manual has helped me a great deal. Before I read it I knew practically nothing about pigeons, but now I pride myself as being a fairly good amateur. I am offered \$3.50 per dozen for killed squabs, but am keeping mine for breeding purposes. Our Canadian market is not so good as the American market, but Canadians are fast learning what good eating squabs are, and in a few years the market will be much better. I have had some experience with hens, and know how hard it is to raise a flock successfully, but hens are not to be compared with your pigeons for money-making and simplicity of raising.

I have had no sickness in my flock and haven't seen a sign of lice. I spray the pen with diluted carbolic acid and clean it out every two weeks. I think no one would have lice in his flock if he kept his pens clean. I do not use the self-feeder at present, but will when my flock increases. I think it is a first-class affair. Your Manual includes and explains everything from the gravel on the ground of the flying pen to the roof on the pigeon loft. I can honestly recommend your stock to any one going into the squab industry and wish you every success.—G. L., Ontario, Canada.

SHOWING A PROFIT. Pigeons are doing well. They are more than paying for themselves.—E. W., Missouri

A GOOD WORD. I will always speak a good word for your kind treatment and your fine birds.—J. M. H., South Carolina.

LETTERS FROM CUSTOMERS RECEIVED BY PLYMOUTH ROCK SQUAB COMPANY

MORE STORIES OF SUCCESS

PROFIT OF \$2 ON EACH PAIR OF BREEDERS. COST OF FEED, 75 CENTS A PAIR A YEAR. In January, 1907, I got the idea of raising squabs. I saw your advertisement in the *Reliable Poultry Journal*, answered it, got your free book, then sent 50 cents for your *Manual*. After reading it, I started to fix up an old building for squabs. After fixing the building which was a cheap one, my squab house had no floor and the roof was poor, but in this dark and damp place I have never had a sick bird, but I am now so interested in the business that I am building a unit house according to your plans. After the old building was rigged into a squab house, I sent in my order for three pairs of **Extra Plymouth Rock Homers**, and when they arrived I was much satisfied with them. On the fifth day, two pairs began nesting and within a week I had four eggs. Within the next few days the other pair went to work. Not knowing much about the habits of the birds, I put in most of my time watching them. I became very interested and the next month sent you an order for six pairs. Since then, a year ago, they have done so well that in the future I am going to make it a business. I have bought nine pairs in all and now have 40 pairs that are working, and 52 young. The birds I have raised from your birds are as fine a lot as I have ever seen.

I have had many calls for breeders and have refused as high as \$4 a pair. I have sold a few dozen squabs to a few families for \$3.50 per dozen. I got them started and they are after them all the time, but I do not care at present to sell at all, as I am increasing my flock. I have weighed the squabs and find they average 10 pounds to the dozen. I am sure I can make a profit of \$2 on each pair of breeding birds. I have kept close account of the feed and it will not exceed 75 cents per pair, per year.

I have followed your *Manual* and think it a good teacher. I don't think I could get along without it. I use the self-feeder and drinking fountain and your nest bowls. I am now feeding as follows: Corn and wheat in self-feeder, four parts corn and one part wheat. The other grains I feed like this: Monday millet, Tuesday barley, Wednesday Kaffir corn, Thursday Canada peas, Friday buckwheat, Saturday broken rice, Sunday hemp seed. I find the birds like this manner of feeding and they become tame. They will be waiting for you at feeding time and fly about you, lighting on your shoulders. I use the lump salt, grit and oyster shells.

I cannot say too much for the squab business. It is way ahead of poultry—not so much work, no young to take care of, and not so much danger of lice. I have never had a louse in the squab house. I will say this in comparing squabs with poultry, first compare the advantages and disadvantages of the growing of market squabs and market poultry. To my mind the former is to be preferred. The work is lighter and the details of the business not so great. The profits are larger for the amount of time and money invested. Artificial incubation and brooding, which is quite a study in the poultry business, has no part in the squab business, as the parents attend to all these details and do it better than man possibly could. All the labor is performed under one cover. In fact, a big plant can be easily established under a single roof. There is no loss from hawks or wild animals. After having experience with both I have decided that for the man who has not the best of health and is limited for land, the squab business offers better opportunities than the raising of market chickens or ducks. The first thing for the beginner is to get the very best breeders and follow your *Manual* as nearly as possible and he will come out on top. I am satisfied with my success and will continue to the end. You will please find my order for birds and supplies.—F. L., Illinois.

FLORIDA EATS THOUSANDS OF DOZENS OF SQUABS IN THE WINTER MONTHS.

The manager of the Royal Poinciana Hotel of St Augustine, in response to my query as to the demand for birds, said he saw no reason why his company could not use several hundred dozen each week, that they would like to see more pigeon farms in Florida. I want to go South the first of next month and by the last of the month or the first of November have the birds there so as to put some squabs on the market in December.—H. B. J., Indiana.

Note. The Royal Poinciana above mentioned is only one of a chain of Flagler hotels along the East Coast of Florida and squabs are eaten in all of them.

TEXAS REFERENCE. If any one wants to know anything about your square dealings, etc., you have my permission to refer him to me.—R. S., Texas.

THIRTY YEARS' EXPERIENCE. Received your *Manual* and as far as I have gone I find it up to the minute in every respect. I have learned a number of things about pigeons in it that I did not know before, and I think I am pretty well posted on pigeons, as I have raised them, both common and fancy, off and on for the past 30 years, but only for pleasure. Now I think I will go into it for profit, in a small way at first, but expect to increase my flock from time to time, as I have the money to spare.—J. C. M., Ohio.

DEMONSTRATION OF EXCELLENCE. My Extra Plymouth Rock Homers are doing first rate. I am now at present increasing my flock as I see that the pigeon business far surpasses the poultry business. Please send me a price list of your open leg bands with three initials and number on.—L. C. W., Illinois.

LETTERS FROM CUSTOMERS RECEIVED BY PLYMOUTH ROCK SQUAB COMPANY

MORE STORIES OF SUCCESS



This breeder whose plant is pictured at the left lives in a thickly settled residential neighborhood in Washington, D. C. The building in which his pigeons are kept is at the rear end of his residence lot. It is a two-story brick building 20 x 40 feet and contains two hundred nest boxes. The two windows have a southern exposure. The flying pen, 10 x 12 feet by 16 feet high, takes in only one window. He has bred Carneau here. He has bred all kinds of pigeons, he says, but has never seen such breeders as our Carneau. He has bred youngsters from our birds weighing nineteen and three-quarters ounces when twenty days old.

A CITY SQUAB HOUSE.

TWO YOUNG WOMEN TOO BUSY MAKING MONEY WITH SQUABS AND CHICKENS TO WRITE A LONG LETTER. Please excuse our delay in writing you as we are busy most every minute of the day raising chickens for our winter layers, and they cause more work than the pigeons, but we thought the two were a good combination, as we can sell everything we can raise. There is a great demand here for squabs, and ours are fine, if I do say it myself.

We are very much pleased with the last lot you sent. They are beauties. All our birds are good workers.

Sometime in the near future we will write and give you a little of our experience since we have started in the squab business. This time of year is a busy one for us, getting everything going for the winter when prices are the highest. We are having much better success this year than last. Excuse this delay and we will write later.—Miss H. L. A. and Miss E. E. S.

FOUR DOLLARS AND EIGHTY CENTS A DOZEN FOR SQUABS IN SPOKANE. INSISTENT DEMAND. The market for squabs here (Spokane) is good, and I am getting 40 cents apiece for squabs. The demand is more than the squab raisers can furnish. I thought I would take a sample of your birds, and they surely have proven good.—M. M., State of Washington.

CANNOT SUPPLY THE DEMANDS FOR SQUABS IN THIS ALABAMA TOWN. My pigeons are getting along fine. I cannot very well supply the demands here for squabs and may have to order more Plymouth Rock Homers soon. Please write me at once as I would like to order as soon as possible.—C. N., Alabama.

LETTERS FROM CUSTOMERS RECEIVED BY PLYMOUTH ROCK SQUAB COMPANY

MORE STORIES OF SUCCESS

LARGE AND PROFITABLE FLOCK BREEDING HIGHEST-GRADE SQUABS, DEVELOPED IN TWO YEARS FROM A PURCHASE OF ONLY SEVEN PAIRS. In the early part of 1906 I became interested in squab raising. After reading a great deal on the subject, and especially the "National Standard Squab Book," written by Elmer C. Rice of the Plymouth Rock Squab Co., I concluded to try my hand at the business, not so much for profit as for relief from the confining work of my profession. I was fully convinced that I would find the work not only profitable but most enjoyable.

I immediately set to work, at odd times, to fit up for a squab loft the upstairs of a small barn on the south end of a city lot upon which my residence is located. At the present time, I have the upstairs of this barn divided into two breeding pens with one flying pen to the west and another one to the north. In order to give my birds plenty of sunshine, I built my north flying pen as high as the eaves of the barn. By so constructing it the birds can have sunshine the entire day.

In February, 1906, I bought of the Plymouth Rock Squab Company the first pigeons I have ever owned, consisting of seven mated pairs of as fine Homers as can be found in any loft. All but one pair of these were prolific breeders. From one of these pairs I have raised 37 squabs, averaging in weight about 13 ounces each.

Although I have a few times bought elsewhere a pair of pigeons that suited my fancy as to color, etc., I have failed to find any better ones than those mentioned above.

I have one of your banding outfits with which I make open aluminum bands. Just before the youngsters intended for breeders leave the nest, I place on them one of these bands. I keep a very careful record of each one of these intended breeders. From this record I can trace the origin of any of the breeders which I have raised back to their oldest ancestors in my loft. This record and my mating coop have enabled me to avoid inbreeding.

As a result of the splendid stock of birds with which I started, proper mating and the best of care, I now (July, 1908,) have a flock of nearly 250 exceptionally good Homers. A finer flock I have never seen. Nearly all of them are mated and doing good work.

From this flock I have sold nearly 500 squabs, and I am now putting into market over 100 per month, besides retaining some of the choicest squabs for breeders. My squabs average nearly nine pounds to the dozen. With the exception of those raised by very young parent birds, they average over nine pounds to the dozen, while a few go as high as 12 pounds to the dozen.

From my limited experience in the business, I am fully satisfied that squab raising is not only very enjoyable work, but also very profitable to the one who starts with first-class birds, gives them first-class care, uses ordinary good judgment in managing the business, and has stick-to-it-enthough to give the business a fair test before giving up.—W. A. G., Ohio.

HIS NEIGHBOR, AN ENGLISH EXPERT, COMPLIMENTED HIS PLYMOUTH ROCK HOMERS. My neighbor, an Englishman, who has raised pigeons all his life from the time he was a boy in England, complimented my Plymouth Rock Homers very highly. One side of his pigeon pen forms one side of mine, our two houses joining, and we have a good way to compare the birds, side by side. He has fine birds (raises his for fliers), but, although a novice in the business myself and not authoritative on the matter, I would not trade my pigeons for any he has. It was evident at the start that the birds you sent me were well mated, and my neighbor also remarked how well they seemed to be paired, and how devoted the pairs were to each other. I think also, that quite an affection has already grown up between myself and the birds, of a reciprocal nature, and I am thoroughly pleased and satisfied.—R. R. M., West Virginia.

SQUABS SOLD IN OHIO AT AN AVERAGE PRICE OF \$3.36 A DOZEN. My squabs are doing fine now. We have marketed 724 squabs since October 12, 1907, to June 20, 1908, off 210 pairs of birds—average price apiece, 28 cents.—W. H., Ohio.

THIRTEEN-YEAR-OLD BOY CHANGED HIS BABYHOOD PLAY-HOUSE INTO A SQUAB HOUSE AT A TOTAL EXPENDITURE OF TWENTY-FIVE CENTS. I changed an old play-house into a squab house and built a pen and the whole thing cost me 25 cents for bolts and wire staples. I will send you sometime some photographs of my Plymouth Rock Homers and my house. I follow the instructions in your Manual and am well satisfied with everything. My papa ordered the pigeons for me. Your well-pleased customer.—W. C., Massachusetts.

Note. We print this boy's letter because we think he holds the record on cheapest squab-house construction (or remodeling). Who can beat it?

STARTED WITH CHEAP HOMERS, BUT HAD TO KILL THEM OFF AND BUY PLYMOUTH ROCKS. I send you draft for \$45. Send the birds as soon as you can. I have the squab house all ready. Last fall I sent off for six pairs, then early this spring I sent for six pairs to another firm (low-priced place). I have now one pair that is fairly good and one good cock. I killed the others. I do not want any more \$1 per pair pigeons.—J. B., Iowa.

LETTERS FROM CUSTOMERS RECEIVED BY PLYMOUTH ROCK SQUAB COMPANY

MORE STORIES OF SUCCESS



A PAIR OF BIG SQUABS.

These were bred by the Pennsylvania man whose letter is printed on this page. Note the enormous breasts and their plumpness. They are world-beaters.

STARTED IN TWO HORSE-STALLS. RAPID PROGRESS IN ELEVEN MONTHS. I sent you my first order for six pairs of Extras, the birds arriving November 23, 1907, all in good condition with the exception of one, which you replaced later on. I selected the two horse-stalls in the barn as a fit place for keeping pigeons and put in the floor, windows, nests, etc., according to your **Manual**. I succeeded in getting the first pair to hatch within a month's time. It was very cold, which somewhat hindered them in their breeding. The remaining birds were all at work soon after the first and I became greatly interested in them. I had great confidence in this new venture and after they were all at work, I first conceived how fast they bred.

In the month of January, 1908, I sent my second order for eight pairs of Extras, these birds arriving January 25, 1908, in good condition with the exception of one, which you so generously replaced later on. This second lot of birds were all at work within two weeks after liberation. They commenced to hatch so rapidly that I find I have at this date, October 11, 1908, about **200 birds in all**. These birds include the original 14 pairs and their offsprings. My birds are all banded and I keep a careful account of each pair. I have seen quite a few birds in town classed as **Homers** which do not near compare with the birds I bought of you. My pigeons can be seen any time and people are surprised to find such a fine lot of birds. The birds which I bought of you and their offsprings will easily average from seven to nine pairs a year, and some have hatched for the tenth time in less than a year. Some of the nests had three eggs in them on two or three occasions. These eggs were all hatched out and I took the third young one and put it in the nest of good feeding birds who raised it to a good size.

I have weighed some of my squabs and find them one pound and over, some occasionally being under one pound.

After having read your **Manual** thoroughly I determined to make the feed question one of the principal considerations. I use the self-feeder which you describe and recommend. I mix corn (which includes cracked corn) and wheat in the proportions which you state in your **Manual** and keep the self-feeder always plentifully supplied with it, so that the crops of their young are well supplied. I also feed the dainties such as millet, buckwheat, peas, hemp seed and sunflower seeds, throwing lettuce, cabbage or parsley into the pen twice a week. The birds always have rock-salt, codfish and oystershell before them. The pens are re-graveled every six weeks and

LEETERS FROM CUSTOMERS RECEIVED BY PLYMOUTH ROCK SQUAB COMPANY

MORE STORIES OF SUCCESS

the birds are always in good health. I scald the drinking fountains several times a week and clean the apartments every week. The bathpans are filled daily so that they can keep free from vermin. I have not as yet been seriously troubled with lice for I disinfect thoroughly every few weeks. I have tried to follow your **Manual** in every way possible and the results testify to its great value as the book of all books on this subject. If a person has never engaged in this pleasant pursuit he need but buy a **Manual** and follow its teachings and success is sure to crown his efforts. It takes patience from the start and those who think of get-rich-quick schemes had better not start in this industry.—H. F. S., Pennsylvania.

HER BIRDS IN CALIFORNIA LIKE FINE TWIGS FOR NEST BUILDING BETTER THAN STRAW.

We have now 28 mated pairs and I have another pair in the mating coop, also saw a pair in the squab pen making up to each other this morning. We are very much interested in the work and intend to continue until we have about 2000 birds if we can. Of course we will soon begin to sell some, but we wish to have enough to supply one certain place before we do, as we think by so doing we can build up a better trade and get a better price for our birds. Several have offered to buy but we have sold none yet. Every one says our birds are the prettiest and best cared for they ever have seen. They think we take unnecessary pains with them, but we think it pays to do so. We started in March last (1907) so none of our squabs is more than nine months old and they all mate up at about four or five months. The oldest ones have had several pairs of squabs of their own. We have followed the **Manual** and think it all right. We feed wheat, corn, cracked corn, Kaffir corn, mixed, as a daily feed and three times a week Canada peas and hemp seed with now and then a little rice. We have running water in our pens and we use eucalyptus and pepper twigs for the nest building, as they seem to like the fine twigs better than straw. We keep oyster shell and charcoal and rock salt where they can get it, and put fresh gravel in the pens every now and then. We wish to keep about 50 pairs in each unit, so we have our first one almost full. We expect to buy more breeders as soon as we can and not depend altogether on our own, but we wanted to get a start and be able to handle a few pairs properly before we tried so many. Wishing you success and prosperity.—Mrs. W. W., California.

WORTHY OF ENTIRE CONFIDENCE.

Enclosed find postal money order for which please send Extra Plymouth Rock Homers, according to your Special Offer No. 3. This is my third order. The National Standard Squab Book is as nearly perfect as it can be and has given me both pleasure and satisfaction. Your improvements and additions are admirable. I am ordering from you because you are I think entirely reliable, generous and worthy of my entire confidence. My plans are not quite matured but they mean more Extra Plymouth Rock Homers.—Mrs. H. A. C., Georgia.

SELLING SQUABS AT GOOD PRICES AND BUYING MORE MATED PAIRS.

I purchased of your company six pairs of your Extra Plymouth Rock Homers the 13th of June, 1907, and six pairs the 27th of the same month and had no trouble in getting them to work. Some of them started to nest two days after I received them. I now (May, 1908), have 60 mated pairs and have been selling squabs right along for \$3 and \$3.50 a dozen. I have some pairs that hatch every month. I have one pair that hatch three birds quite often and raise them all. I have some squabs that weigh one pound at four weeks of age. They average from nine to 11 pounds to the dozen. I have sold some pairs for \$1.25 a pair. I feed the best of grain, such as whole corn, red wheat, Kaffir corn, millet, hemp seed and Canada peas and cracked corn, and use the self-feeder for the wheat and corn as shown in your **Manual**, and like it. I like your **Manual** and would not be without it. I have had no sickness or lice in my flock as I use plenty of lime, and keep my house well whitewashed inside and outside. I have been in the first stores in Pittsburg and in several pigeon houses around here and I have seen none to compare with mine. I have some young birds finer than the parent birds. I like the birds very much and the business, or I would not be sending for more birds. Your birds are more than you claim them to be, for my birds have shown so. It will pay me better to buy mated birds that will hatch right off than it would to wait on the young for breeders, as I can be selling squabs all that time.—J. H. S., Pennsylvania.

BEST IN A LIFE TIME. I have read your book with much interest. It is by far the best I have ever seen on the subject of pigeon raising. I have kept pigeons all my life, or at least for 40 years, from the common to the high-priced carrier, and at present have a coop of some dozen different varieties, all of which I propose disposing of and putting in the Plymouth Rock Homers. See enclosed order.—W. W. B., New Jersey.

LARGEST HOMERS EVER SEEN. The Plymouth Rock Homers I bought of you last season are doing far better than I had anticipated. Every one who has seen them, without an exception, says they are the largest Homers they have ever seen.—B. E., District of Columbia.

LETTERS FROM CUSTOMERS RECEIVED BY PLYMOUTH ROCK SQUAB COMPANY

MORE STORIES OF SUCCESS

KNOWS WHERE TO GET RELIABLE BIRDS. I know where to come for reliable birds, having bought my Extra Plymouth Rock Homers from you. See enclosed order. The Extra Homers I bought of you June 1 have made a good record. I knew absolutely nothing about pigeons and had never seen a first-class bird until I got yours. Have depended entirely on your Manual for my knowledge.—Mrs. R. O., Indiana.

MORE THAN DOUBLED. The pigeons we bought of you in September are doing nicely. They have more than doubled their number and our young stock have commenced

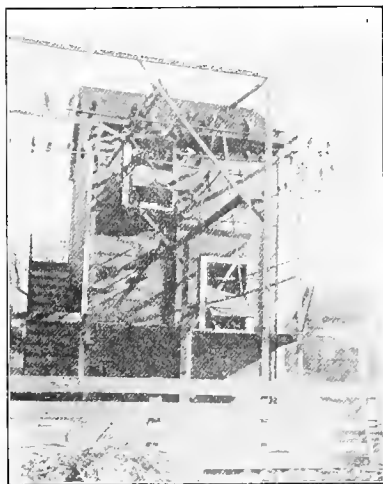

AN ODD SQUAB HOUSE.

This shows the small plant of the Massachusetts breeder whose letter is printed above and beneath the picture.

laying. One pigeon suddenly became lame after his arrival here, and after trying to cure him we finally killed him. We have discovered no more lameness in our flock.—S. W., Massachusetts.

SOME WEIGH ONE POUND AT THREE WEEKS. My Plymouth Rock Extras are all doing nicely and are raising squabs that average a pound at four weeks. Some of them will weigh a pound at three weeks.—P. E., Pennsylvania.

SET BACK BY POOR WHEAT. I started with six pairs. Got along fine until I got hold of a lot of poor wheat which made my pigeons very sick. This happened in the latter part of June, '07. I had by this time in all 25 or 30 birds, of which only five birds survived. I did not buy more pigeons until I had my pens remodeled so as to hold more birds. Got them fixed up all right and bought 17 birds of you, six pairs and five hens. They mated in about two weeks, raised about seven pairs in October, November nine pairs, December 10 pairs, January 11 pairs, February nine pairs, and I have ten eggs for this month.

I do not feed wheat as you told me not to. I cannot get a good grade of wheat so I feed all Kafir corn or a little cracked corn mixed with it.

I have followed your Manual in every way and find it an excellent book, as I did not know a thing about pigeons at all.

They do not pay as good prices here for squabs as they do in the North and East but they pay well considering the fact that people out in this part of the country do not know much about good squabs. They have been used to breeding the common pigeons' squabs which weigh about one-half as much as the squabs I raise. I had five out of the nest the 28th that weighed one and three-quarter pounds apiece. They are very fine birds. Fort Worth is growing every year very fast. We have 7500 people. I hope I will be able to convince the hotel people that they are worth more than 40 cents to 60 cents a pair. My flock is growing every day and I will order more birds before long.—J. S. W., Texas.

KNOWN ENOUGH ABOUT PIGEONS TO APPRECIATE THE BOOK. Your squab book is the best on that subject I have ever read. It covers the ground completely and makes everything plain and clear enough for a child to understand. A number of years ago I bred and flew Homers successfully for about five years. This experience enabled me to understand and appreciate your book better than if I had no knowledge of pigeon raising. I will be glad to return the old Manual and receive new one. I will do so about January first, as I like to look into the book now and then and do not wish to be without one.

I note that the *Pittsburgh Dispatch* is quoting squabs at \$4.50 to \$5.00, seconds at \$3.70 per dozen.—A. E. C., Pennsylvania. *

WORTH ALL COMBINED. We think your Manual is the best in its line. We have read many books regarding squab breeding, but none has given us the satisfaction your Manual has. We would not trade your Manual for the whole bunch. Your book is so clear that a child can understand it.—H. & F. B., Ohio.

LETTERS FROM CUSTOMERS RECEIVED BY PLYMOUTH ROCK SQUAB COMPANY

MORE STORIES OF SUCCESS

COST HIM ABOUT EIGHTY CENTS A PAIR A YEAR. My birds bought of you work well, raising a pair about every six weeks. I have about 40 young ones now that are beginning to mate. One pair have raised one pair of nice squabs already. I would have had more now, but the rats killed quite a few. I have not sold any yet, have been saving them for stock. I have had several chances to sell some for breeders, but I thought I would rather keep them myself. I have not had any trouble with lice or sickness so far. I always keep the lofts cleaned out. I feed mostly cracked corn, Kaffir corn and wheat, with buckwheat mixed in when I can get it. About three times a week I throw in some red millet, they are always looking for it. I have followed the **Manual** in regard to feeding. In the winter I feed more corn than wheat, and in the summer more wheat than corn. I think it has cost me about 70 or 80 cents a pair for the year. I made a self-feeder like the one outlined in the **Manual** and think it is all right. Feed has been high here for quite a while. I think anybody can make money raising pigeons if they tend to business and read their **Manual**. I think it is all right. I like to work around the lofts and watch the old ones take care of the young. I have two sections, one to keep the old ones in and the other for the young. I keep all my pigeons banded. I use the open legbands. I like them better than the others. Part of the birds seem to like to build on the floor better than in the nest bowls. I use clean straw for them to make nests.—E. L. Y., Illinois.

NEARLY ALL HIS PLYMOUTH ROCK SQUABS WEIGH ONE POUND EACH. I would like to say that your Plymouth Rock Homers are fine birds. The second week I got them they started to work, although it was last February and very cold weather. I have now over 40 young ones and I sold some also. I certainly would not have any other kind of a pigeon about me. It used to worry me for fear I could not get my squabs to weigh up to some of your customers, who say in your National Standard Squab Book that they have squabs weighing 10 to 12 pounds to the dozen. Now I have some that weigh more than that. I have had some that weighed 14 ounces, but most all weigh a pound apiece. I am going into the pigeon business on a large scale, and every one of my birds will be from you, as soon as I get a place where I can enlarge my plant.—C. H. P., Pennsylvania.

BUILDS A NEW HOUSE AFTER FIFTEEN MONTHS' EXPERIENCE WITH A TRIAL LOT. Fifteen months ago I bought six pairs of Plymouth Rock Homers of you. They are doing splendid. I think I will want another small lot when I have my new house done that I am building.—W. A. R., Maryland.

HAD SUCCESS WITH HIS BIRDS FOLLOWING PLYMOUTH ROCK METHODS. Please send me some of your pigeon literature for 1908 if you have any. I bought one of your **Manuals** in 1907 and am very much pleased with it and I would not part with it for five dollars. I have had success with my birds since I had it and recommend it to all my friends. It is full of facts that are true, and is written so that any one can understand it that reads it. I love pigeons and I like to see others make a success with them.—E. H., Maryland.

CLEVELAND (OHIO) MARKET. Monday, October 19, 1908, I was offered \$2.50 a dozen for squabs just taken off the nest, not killed. It has been stated in this city (Cleveland) that squabs will go up as high as \$3 a dozen wholesale.—W. E. P., Ohio.



TOBACCO STEMS.

Used for nesting material. You should not use these stems if you are going to sell the manure to tanneries because they do not want manure containing tobacco stems, as the stems stain the hides. If you are not going to sell the manure to tanneries but to gardeners and florists you can use tobacco stems as they are an excellent preventive against lice.

WOMAN'S SUCCESS LEADS TO ANOTHER ORDER. Some time last winter I was at Spring City, Tennessee, and advised a woman to order some of your pigeons. They having proven very satisfactory to her, and upon her recommendation after a trial, I am enclosing you herewith New York exchange for \$30 for which please send me as early as possible your Special Offer No. 1, Extra Plymouth Rock Homers, etc.—J. M. C., North Carolina.

DOING WONDERS IN VERMONT. Our birds are doing fine and for the care they have had have done wonders since we got them. We find very few inbreeding. If you have any new literature, please advise us.—J. O. S., Vermont.

LETTERS FROM CUSTOMERS RECEIVED BY PLYMOUTH ROCK SQUAB COMPANY

MORE STORIES OF SUCCESS

SQUABS AS FAT AS AN OLD HEN. I have 100 pairs of Plymouth Rock Homers and am well pleased with them. I dressed 16 Homer squabs yesterday that averaged just a pound apiece. Several were only 26 days old. My principal feed is cracked and whole corn, red wheat and millet seed, also feed some Kaffir corn and think well of it. I use tobacco stems for nesting material.

My squabs are as fat as an old hen at four weeks. My birds are healthy, snappy and strong and working fine. In banding squabs or young birds before leaving nest how can I tell male from female, as I want to know which leg to place band on?—H. R., Ohio.

Answer. You cannot tell at that age. Put the band on either leg and transfer it to the correct leg when the bird discloses its sex by its actions at four to five months.



LUMP OF ROCK SALT.

This kind of salt and no other should be fed to pigeons. By pecking at it they get off enough and cannot harm themselves by eating too much. If you feed your Health Grit you do not need to provide this rock salt.

A BOY'S PLEASURE. You have treated me very nice. I am fully satisfied with what birds I have got from you. I have done everything you recommend in your Manual. The red checkers raised one pair of squabs which weighed almost two pounds when three weeks old. I would like very much to order some of your specials, but I am only 12 years old and just starting out. I am also a cripple, not being able to do very much myself, consequently I must depend entirely on my father for assistance. I do not like to ask too much of him. I feel that he does all he can for my pleasure. My education is from him, as I have never been able to go to school.—E. D., Illinois.

HAD EXPERIENCE WITH COMMON PIGEONS, POOR HOMERS AND PLYMOUTH ROCK HOMERS. I had a notion that the common pigeons would do as well in raising and raise as large squabs as the Homers would, but I was greatly mistaken as you will see. I kept my common pigeons for about four or five months, which was enough for me because it cost more to feed them than I got for my squabs, so I sold out all of my common pigeons and bought some Homers. These Homers I got from men who were selling for 75 cents and \$1.50 a pair which did not do much better than my common pigeons, so I got thoroughly disgusted with pigeons and sold out again. About two weeks later I saw your advertisement, which was the starting of my success. I liked your advertisement and sent off for your catalogue. What I found in your catalogue was true and it sounded like the truth. I liked the catalogue so well that I sent for your Manual, which you sell for 50 cents, which is not a hundredth of its value. After I read the Manual I ordered some of your Extra Homers. I thought you would give me good birds the first time and bad birds the second time, but the second order was filled with as good birds as the first. I got my first birds from you in the winter, about February, 1908. By mail you sent me a slip of the most valuable information that I ever read or will read in my life.

I kept fresh water before my birds all the time. I did not let the birds drink the bathing water at all. In the winter time the water would freeze at night but fresh water was put in every morning. My pigeons did better in the winter than in the summer.

I feed my pigeons wheat, cracked corn, hemp seed and about a double handful a week of Kaffir, corn and sunflower seed, which altogether is about the most digestible and fattening for the squabs. I keep salt, charcoal, grit and oystershell before them all the time. I give my pigeons about four or five heads of lettuce every week. I followed your Manual in every way possible. In a few days I will send you a third order for your Extra Homers.—P. A., North Carolina.

BUSY WORKING ALL THE TIME. As you, no doubt, remember, I bought 15 pairs of your Plymouth Rock Homers last March. Am very well pleased with them. My Homers are doing fine, busy working all the time. When I want more Homers will place the order with you.—H. J., Ohio.

SELLING SQUABS REGULARLY FROM A SPLENDID FLOCK OF BREEDERS. In February, 1906, I bought a few pairs of very good pigeons from you, from which I have raised a splendid flock of breeders from which I have been selling squabs regularly for the last eight months.—G. A. W., Ohio.

LETTERS FROM CUSTOMERS RECEIVED BY PLYMOUTH ROCK SQUAB COMPANY

MORE STORIES OF SUCCESS

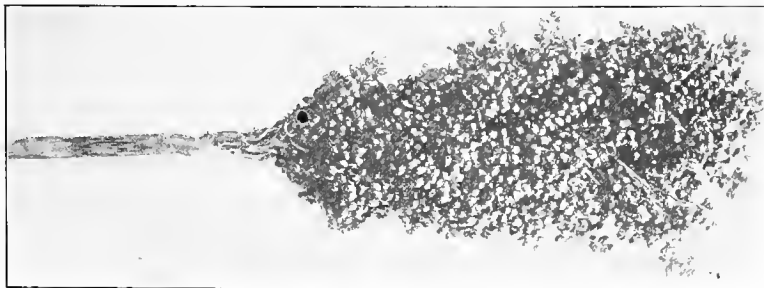

HEAD OF SORGHUM SEED.

This is fed largely to pigeons by our customers in the Southern States. The birds are very fond of it. The berries are brown in color and a little smaller than Kaffir corn. When dried, this head of sorghum cane may be thrown directly into the squab house and the birds will peck the berries off the stalk.

AFTER HE HAD TRIED PLYMOUTH ROCK HOMERS HE DISPOSED OF HIS OTHER PIGEONS BOUGHT OF OTHERS. I am sending you a small order for 24 pairs Extra. Please ship birds as soon as possible. The birds are doing well I got of you 60 days ago. I have disposed of all my other pigeons bought of others and only have what birds I bought of you. I intend to keep buying until I get what stock I need. I had a local trade but I let it go, because I would not sell squabs from Plymouth Rock Homers at the same price I sold former squabs. I will have a four to six dozen capacity plant and would ask for the address of some firm in Pittsburg or New York City to whom I could sell a couple of five dozen shipments, just to keep from housing them in my loft. The main point is to get in touch with the market. I prefer to sell my squabs and buy breeding stock of a mature age, but I do not want to spoil the market or give them away to the local trade for 40 cents a pair. You need not be afraid to give me the name of your nearest fancy squab buyer.

My shipping boxes are being made of white enamel inside and white painted hard wood outside. The white enamel box is to fit in the white wood box, allowing enough room for ice. The boxes are to be returned to me at my expense. I hope you will consider the proposition. Now I have tried many squab companies and if you people will do anyway right I will buy all the stock I can from you.—R. B., Pennsylvania.

A WOMAN'S SHORT AND SATISFACTORY MESSAGE. The pigeons I got from you several years ago have been most satisfactory.—Josephine S. H., Massachusetts.

RECEIVING FIFTY-FIVE CENTS A PAIR FOR SQUABS. Our No. 1 Plymouth Rock Homers breed squabs weighing eight pounds to the dozen and we are receiving 55 cents a pair for them. We have found your Manual a great help and have followed it almost entirely, and never pick it up without seeing something that we missed on previous readings. We are feeding from your self-feeder a mixture of whole corn, cracked corn and wheat, varying the proportion as we notice they scatter one grain or another, but usually about one-third each. Then we throw to them on the floor different mixtures of millet, Kaffir corn, Canada peas, hemp seed and rice. On the whole we are well pleased with the birds and the business and we hope to increase our stock as rapidly as possible.—H. J. B., Pennsylvania.

EVERYTHING TRUE IN MANUAL. I have your Manual. It is complete and you make no false statements. Everything you say is true, and if any one is wishing to start, I would advise them to get a hundred pairs; don't start with a few. Our last order was small because we do not know whether we will stay in this town or not, but when we are permanently located we will order a hundred or more pairs.—R. M., Iowa.

BREEDER OF COMMON PIGEONS CONVERTED BY OBSERVATION OF PLYMOUTH ROCK HOMERS. Enclosed find order for some of your best Extras. Your Manual came a few days ago. It is all that you claim for it. Have had a good deal of experience with common pigeons, but have seen your Plymouth Rock Homers at work and they are "the thing."—R. D., Texas.

LETTERS FROM CUSTOMERS RECEIVED BY PLYMOUTH ROCK SQUAB COMPANY

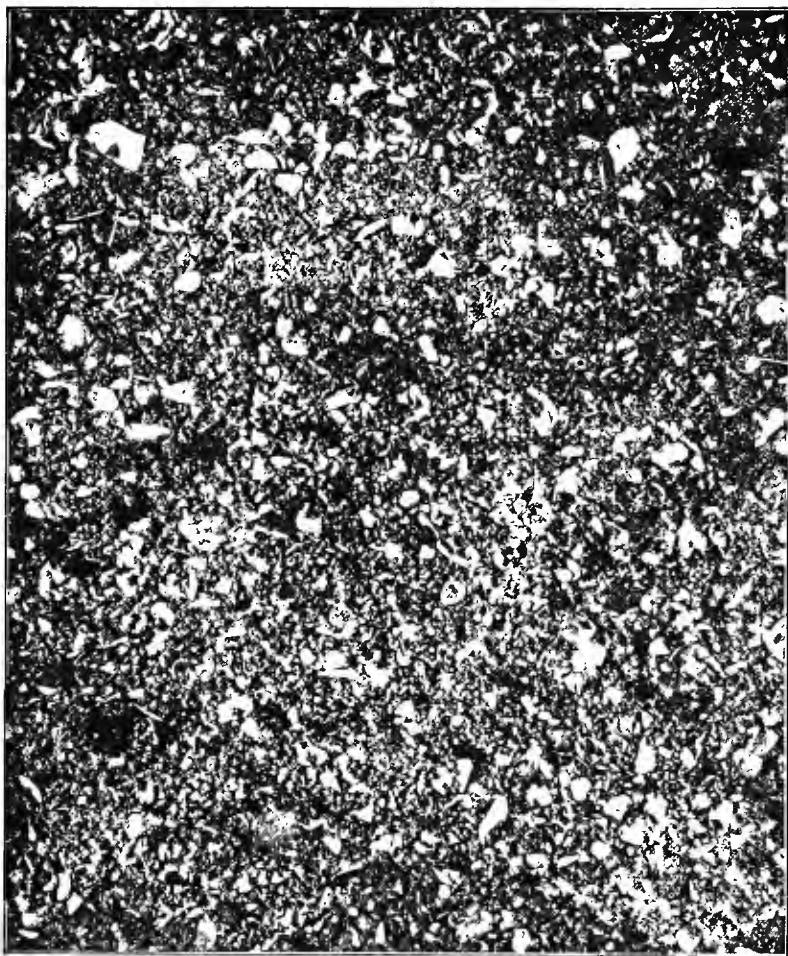

HEALTH GRIT.

This is a photograph of our Health Grit, for which we have an enormous sale. It will pay for itself many times over, increasing both the number and the size of the squabs and also keeping the whole flock in first-class condition. The above photograph shows clearly the small shells and the gravel and charcoal which are in the grit. There are half a dozen ingredients in the grit, including medicinal substances. The formula is a trade secret. We receive hundreds of letters praising this grit. Nearly all of our large customers, almost without a single exception, feed it constantly to their flocks. The value of this grit is well indicated by the following letter received from a customer in Connecticut in May, 1908: "Please send enclosed order for your Health Grit as soon as possible as we have lost a few pigeons lately. I think it is because I got out of the grit. They are crazy about it and were healthy when they had it."

MORE STORIES OF SUCCESS

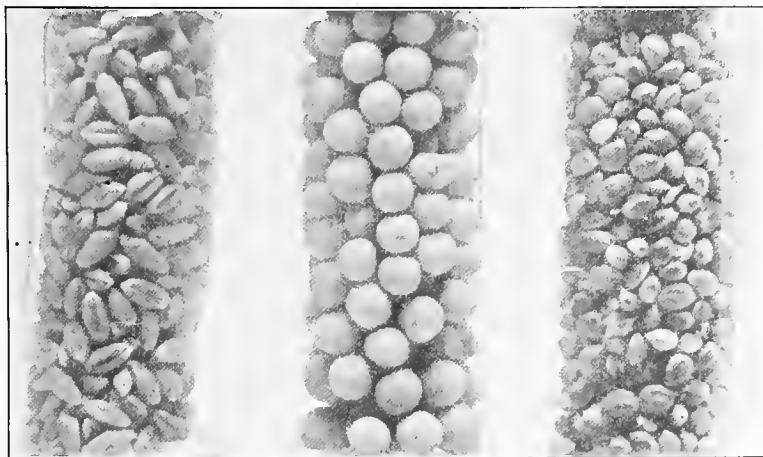

1. RED WHEAT.

2. CANADA PEAS.

3. HEMPSEED.

On this page and on the pages that follow we print pictures reproduced from direct photographs of grain used in squab raising; also grit, shells, etc. These pictures have come out very well and will give our readers scattered over this continent and in other parts of the world a clear idea of what we are talking about.

In the above picture (the first of the series) No. 1 is a sample of good red wheat, showing the plumpness of the berries. No. 2, Canada peas. No. 3, hempseed.

ENLARGED PLANT AND FLOCK. Seven months ago we bought one dozen pairs of your Extra Plymouth Rock Homers. We now have 78 young. Ten pairs of young have mated and we find them to be larger than their parents. Our squabs at four weeks weigh from 12 ounces to 15 ounces apiece. We keep constantly before them pure fresh water and we feed from a self-feeder made from your pattern, filled with two parts whole corn and one part red wheat, then at noon we feed some dainty placed on a flat board with raised edges, alternating between Kaffir corn, buckwheat and hemp seed with rice on Sunday. We keep a cash account of everything and find at present prices we are able to keep our birds at the rate of \$1 per pair per year. We have surveyed a place for a pigeon house of five units to be built on our plan and hope before many months to be doing business on a paying basis. I am fully convinced there is money in it. Your Manual is just fine and cannot be beat as far as I know. It has been the secret of our successful start so far. We have to refer to it very often. We wish you even greater success than in the past.—A. L. H., New York.

RECEIVES TWENTY CENTS EACH FOR SQUABS ALIVE AND FINDS THAT THIS PRICE PAYS. I started in April, 1906, with 24 pairs of Plymouth Rock Homers. They got to work in about three weeks. The squabs weigh eight to nine pounds a dozen. I sell the squabs alive at four weeks old for 20 cents each. I have not sold any live breeders, but I have had chances and referred them to you. I have fed as your Manual says. I have no trouble with lice.

I like my birds and think there is money in them, but one has to have a large flock to do much. I intend to keep at it and this spring will build me three more pens, as I now have three and I want to get 500 pairs, and will send for more later. Your Manual is all right and very plain in every way. I use egg boxes for nests, tobacco stems and straw.—B. A. L., Connecticut.

YES, WE ARE CONVINCED AND THANK YOU. I bought my first lot of birds from you. Since I have bought elsewhere, but I believe you are the most reliable to deal with and this order will confirm my belief and convince another, too.—F. P. S., Massachusetts.

LETTERS FROM CUSTOMERS RECEIVED BY PLYMOUTH ROCK SQUAB COMPANY

MORE STORIES OF SUCCESS

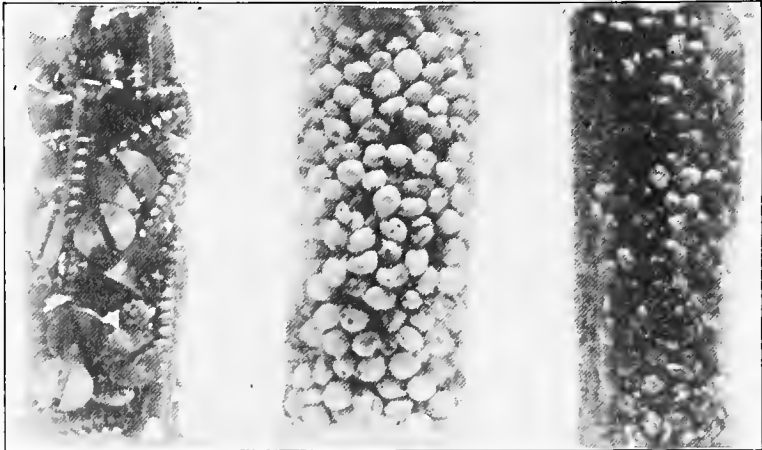

4. WOOD SCREWS.

5. KAFFIR CORN.

6. SORGHUM CANE SEED.

In this picture we show in the first group a lot of common wood screws seven-eighths of an inch long. (These are the screws which we furnish with every order for nest bowls, for screwing the bowls to the bottoms of the nest boxes.) Our object in printing the screws is to afford the eye of the reader a measure of comparison with these different grains. For example, in the above photograph the sample No. 5 is Kaffir corn. By comparing the Kaffir corn with the screws, the eye of the observer forms a correct estimate of the size of the Kaffir corn and also the other grains in the other pictures. These photographs show the actual sizes of the objects. The grain in No. 6 is sorghum cane seed, full size. A reduced photograph of a head of sorghum cane is shown on page 285.

QUICKLY AT WORK IN MONTANA. I think we will send for Special Offer No. 7 and extra supplies this month. Our birds (100 pairs) received May 17, have done very well. Some pairs are setting (August) for the third time. Have a four-unit house in course of construction, part of which we will fill with selected young from our own flock. I have sold about five dozen squabs and it is three months today since the birds were received, and have about 100 young in the squab house, which we expect to keep for breeders.—S. A. F., Montana.

SUCCESS TOLD BY REPEATED ORDERS FROM IOWA. I send you money order for \$150 for which send me Extra Plymouth Rock Homers as per your Special Offer No. 7. I would like birds in place of supplies which I think amount to \$24.98, making 238 birds according to the offer. I would like to get 650 mated birds in three shipments and will send you an order every two weeks until that number is supplied. In November, 1907, I bought of you 12 pairs No. 1 and 12 pairs Extra.—R. I. E., Iowa.

FIFTY CENTS A PAIR ALIVE. I am selling my squabs to a local cafe and am receiving 50 cents per pair alive. If you think I can do better than that in larger cities, kindly send me the names of some firms who are in the market for heavy squabs, the average weight being 10 pounds to the dozen. Also please send me all your latest circulars. Hoping to have a prompt reply and wishing you all the success that you deserve.—P. A. W., Pennsylvania.

PRAISE FROM AN OLD BREEDER. The Manual is "non plus ultra," without a peer, can't be beat. I read it through twice and still I find something interesting each time I pick it up again. I have raised Belgium Homers since a small boy.—H. T., Pennsylvania.

ALL WE CLAIMED FOR THEM. If I had the room and money, I would like to buy 100 pairs from you, as the No 1 birds I bought from you are all you claimed for them and if the Extras are so much better, they certainly must be fine.—G. R. J., West Virginia.

LETTERS FROM CUSTOMERS RECEIVED BY PLYMOUTH ROCK SQUAB COMPANY

MORE STORIES OF SUCCESS

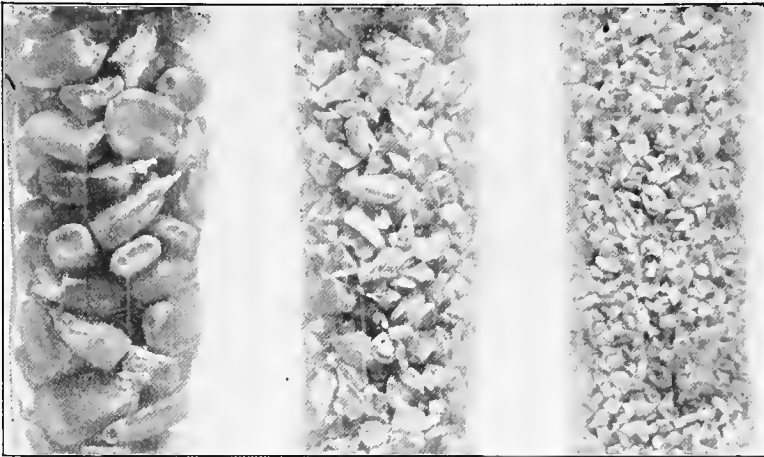

7. WHOLE CORN.

8. COARSE CRACKED.

9. FINE CRACKED.

No. 7 is common yellow whole corn. No. 8 is coarse-cracked corn sifted and No. 9 is fine-cracked corn sifted. (See the chapter on feed in this Manual for full instructions.) As a rule the coarse-cracked corn No. 8 should be fed instead of the fine-cracked corn No. 9. This No. 9 sample of corn is what is known as chick-cracked corn. It is good for little chicks.

HIS SMALLEST PLYMOUTH ROCK SQUAB WEIGHS THREE-QUARTERS OF A POUND AT THE AGE OF THREE WEEKS. My birds are very tame, so much so that when I go into the coop with hemp seed or other dainties and hold out my hand, they fly right on it and eat. I was weighing my squabs yesterday, and the smallest one I have at present weighs three-quarters of a pound. It was three weeks old yesterday.—G. A. W., New Jersey.

HOT SELLERS. I want to know if it is too late for me to send for pigeons on that Special Offer. If it is not too late, when I hear from you I will forward the money. I am having good luck with the pigeons I bought of you last year and am selling the squabs as fast as I get them.—T. N., British Columbia.

WE SELL TO HUNDREDS OF FANCIERS TO BREED FLYERS. Although I am not interested much in squab breeding I am interested in flying. A dealer in my neighborhood has a few of your birds and finds them pretty good for flying so I intend to try some.—L. S. B., Pennsylvania.

THREE PAIRS SHOW WHAT THEY ARE GOOD FOR. Ever since I have had your birds they have bred remarkably well, one pair raising eleven pairs of fine squabs in one year. Not one pair that I bought of you or raised myself has raised less than nine pairs of prime market squabs per year. I think that is a fair record. Besides eating plenty of squabs, I have worked up a flock of 30 pairs of prime breeders from the original small lot of three pairs.—R. E. F., Michigan.

GOOD PRICES FOR SQUABS IN PENNSYLVANIA. Squabs have been quoted at \$4 to \$4.25 per dozen, seven pounds to the dozen, in our papers here. I do not know what mine weigh as I have not weighed any of them, but feel satisfied that they will go more than that as they are large.—A. A. R., Pennsylvania.

EVERY WORD TRUTH. A friend of mine gave me one of your National Standard Squab Books the other day and I have read it through and think it is every word truth, having raised pigeons a long time, but never for the market, so think I know a little about it.—R. H., Iowa.

LETTERS FROM CUSTOMERS RECEIVED BY PLYMOUTH ROCK SQUAB COMPANY

MORE STORIES OF SUCCESS

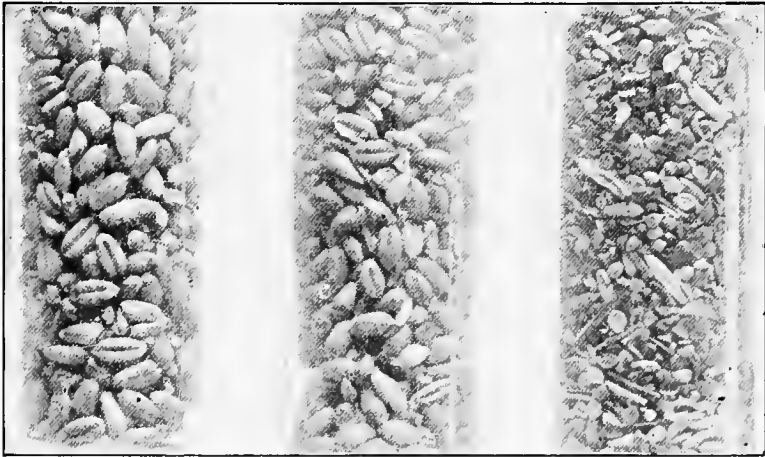

10. WHITE WHEAT.

11. POOR RED WHEAT.

12. WHEAT SCREENINGS

No. 10 is good white wheat. (It is all right to feed white wheat to pigeons if you cannot get red wheat.) No. 11 shows a poor quality of red wheat. The berries vary in size, showing that the wheat is a mixture, and sprinkled through them can be seen oats and elevator sweepings. No. 12 is an even poorer kind of wheat known as wheat screenings. This is the refuse of a wheat elevator, including sweepings, broken grain, hulls, rat manure, etc. Such sweepings or screenings are not a profitable feed for pigeons. They are fed quite largely by many people who buy the cheapest they can get of anything, but a flock fed on this will be out of condition and will raise poor squabs.

WHITE PLYMOUTH ROCK HOMERS WORTH FIVE DOLLARS A PAIR. My partner sent to the Plymouth Rock Squab Company for a pair of your white Homers and when he got them they were dandy ones. They were worth the money. When he sent for them, we just wanted to see if they were good, and we sent for five more pairs at \$2.75 a pair. We got them safely and now I wouldn't sell them for a V.—F. L., New York.

RAISED THREE YEARS FOR FAMILY USE. I saw your advertisement in the *Ladies Home Journal* and will be glad if you will send me one of your free 1908 books on squab raising. We bought pigeons of you about three years ago. They have been very satisfactory. We raise them for family use only.—Mrs. J. G. P., Virginia.

WOULD PAY TEN DOLLARS FOR THIS BOOK. I would not be without your *Manual* no, not if it cost me \$10 to get one, for it gives me more instruction, pleasure and satisfaction than I can express.—L. A. W., Georgia.

WANTS ONLY THE SQUABS WHICH PLYMOUTH ROCK EXTRAS BREED. I am mailing you \$20 for which I want Extra fancy Plymouth Rock Homer breeders. I am breeding about 100 pairs of Homers that produce squabs that weigh about nine and one-half pounds, but the demand is for the largest. So send me something good. Mr. Chase, my neighbor, bought a few pairs of you about one year ago and has been having very good success.—E. E. T., Missouri.

RECOMMENDED BY A FRIEND. Will you please send me price list and literature about the raising of squabs? A friend of ours recommended your company to us, as his son-in-law purchased some pigeons of you last spring and they are very satisfactory.—W. H., State of Washington.

ONE DOLLAR A PAIR FOR PLYMOUTH ROCK SQUABS IN PITTSBURG. I am getting \$1 per pair for all the squabs I can raise, and will have another order for breeding stock as soon as I can arrange for larger quarters.—H. R., Pennsylvania.

LETTERS FROM CUSTOMERS RECEIVED BY PLYMOUTH ROCK SQUAB COMPANY

MORE STORIES OF SUCCESS

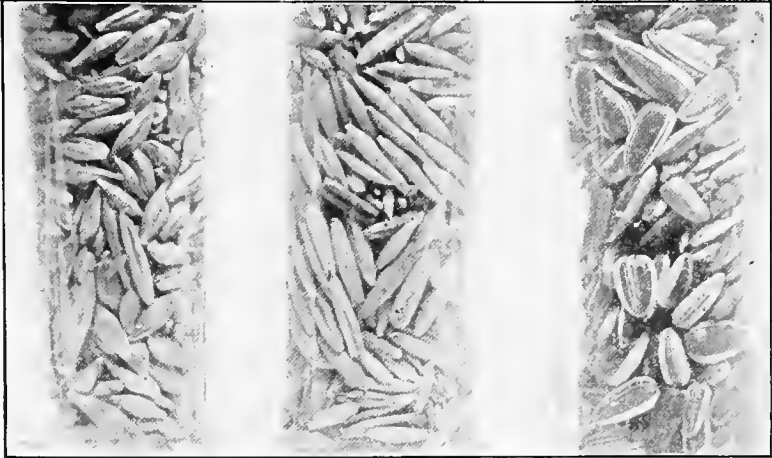

13. BARLEY.

14. OATS.

15. SUNFLOWER SEEDS.

No. 13 is barley, which may be fed if plentiful and cheap. No. 14 is oats, which may be fed if plentiful and cheap, but they are not generally fed here in the East because the squab raiser gets more for his money in other grains. No. 15 is sunflower seeds. Sunflower seeds grow freely without attention almost everywhere. The heads when dried may be thrown directly into the squab pen and the birds will peck the seeds out of the heads. Sunflower seeds sell at retail for from six to eight cents a pound, sometimes more. Nearly every drug store sells them for parrot feed. The supply comes mostly from the West, although a great deal is exported from Copenhagen, Denmark. To buy sunflower seeds and feed them to pigeons is not profitable for the squab raiser, because hempseed sells for less money, namely five cents a pound, and hempseed is better than sunflower seeds for the birds.

GOT THIS BOOK FROM A LIBRARY AND STUDIED IT STEADILY FOR A MONTH.

I am just starting in the pigeon business and I would like you to give me a few starting points. I went to the library to get a pigeon book and I found a book which you published and I read that book every day for two weeks, and then I took it back and had it renewed for two more weeks and I still have it.—A. K., Indiana.

PLYMOUTH ROCKS KNOWN IN UTAH.

Some man asked a question in a daily paper in Salt Lake. In answering him they boomed you up to the clouds. They praised your company so much that I thought I would write you for a catalogue.—H. S., Utah.

FOUR DOLLARS AND A HALF A DOZEN FOR PLYMOUTH ROCKS IN NEW JERSEY.

My squabs all average nine to 10 pounds to the dozen. Am I doing well to get 75 cents a pair?—Mrs. M. C. C., New Jersey.

PLYMOUTH ROCKS THE ONLY KIND WORTH WHILE.

I hope later on to do away with all except what I am purchasing of you and get all Plymouth Rocks, as I am convinced they are the only kind worth while. I will leave the selection entirely with you, feeling sure you will send the best you have.—Mrs. D. W. A., Georgia.

SQUABS IN ARKANSAS.

The squab business is a new enterprise in this section. If I can work it up I will build another house and order more birds from you. I have a friend who is thinking of buying a lot from you. When he sees mine I am sure he will decide at once. Thank you for your promptness and square dealings.—C. W., Arkansas.

MANUAL WORTH TEN TIMES HALF A DOLLAR.

I received your National Standard Squab Book and find every time I pick it up something new in it. It is worth ten times its cost. I would not let any one have it for what I paid for it.—P. J. L., Pennsylvania.

LETTERS FROM CUSTOMERS RECEIVED BY PLYMOUTH ROCK SQUAB COMPANY

MORE STORIES OF SUCCESS

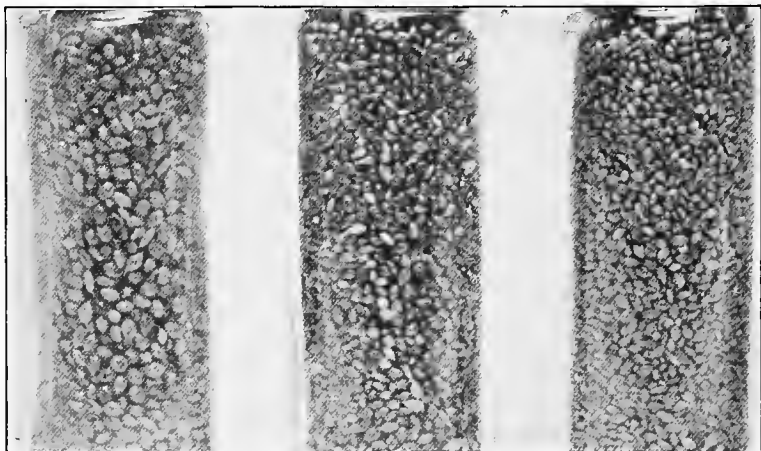

16. AMERICAN MILLET.

17. SIBERIAN MILLET.

18. GOLDEN MILLET.

The above are samples of millet. No. 16 is the ordinary American millet. No. 17 is the Siberian (red) millet. No. 18 is the golden (yellow) millet. All of these are good pigeon foods.

FOUR YEARS' BREEDING IN IOWA. I am about to save the pigeon manure and sell it to a tannery at Milwaukee that is nearest to me. They will buy it if there is no foreign matter in it. They object to tobacco stems. Please tell me what I could use so as to be able to sell it.

If you remember, I purchased a few pairs of Extras from you over four years ago. I am shipping squabs to Chicago and doing fairly well considering the high price of feed here.—J. C., Iowa.

Answer. Use straw.

OLD CALIFORNIA CUSTOMER HEARD FROM AGAIN. We had 100 pairs of you once, but being obliged to move away on business sold them. We shall get more breeders before long and would like to know what you have to say in 1908.—F. B. M., California.

SIX-FOLD INCREASE IN ONE YEAR. September 21, 1907. I received six pairs of your Extra Plymouth Rock Homers. I have now (September, 1908) 75 squabs. This is a fair increase for the old birds. My pigeons are the finest lot in Kankakee.—J. W., Illinois.

NO RACE SUICIDE HERE. We cannot hold our pigeons back. We returned from California four months ago bringing our nine pairs with us and we now have 52. I would like to have a price list of your birds again. We are counting on buying about 100 pairs, probably next spring. One little hen you sent is a wonder. She does not know anything about race suicide. I have a good mind to send her to President Roosevelt.—A. B. M., Missouri.

IN BRITISH COLUMBIA. Two years ago I sent for your circulars, but I could not then see my way to try the business, but after seeing the success a friend of mine is making of it in Victoria, I am tempted to try it as I now have the necessary room and leisure.—W. M. L., British Columbia.

BOOSTED IN SOUTH DAKOTA. I am giving your birds a good boost all around here and I think you will soon be receiving some orders.—G. B., South Dakota.

HOTEL TAKES ALL. My birds are doing fine. I am getting \$3 per dozen for squabs and the hotel takes all I can breed.—W. C., West Virginia.

LETTERS FROM CUSTOMERS RECEIVED BY PLYMOUTH ROCK SQUAB COMPANY

MORE STORIES OF SUCCESS

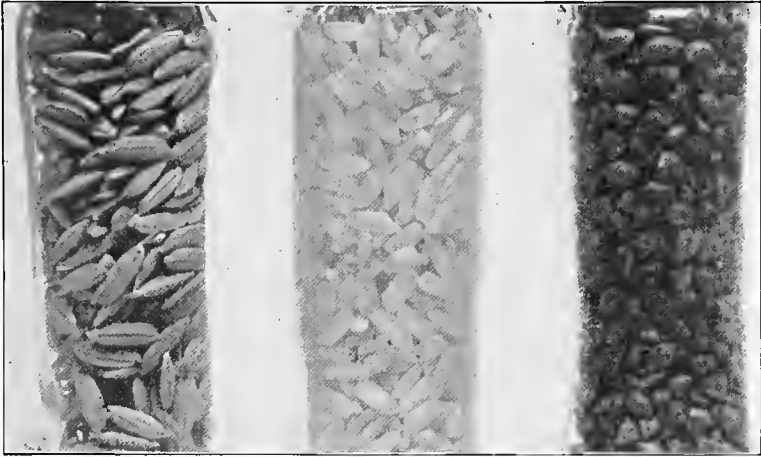

19. RICE UNHULLED.

20. RICE.

21. BUCKWHEAT.

No. 19 is a sample of rice with the brown hulls on. No. 20 shows the same rice with the hulls taken off. This, the unhulled kind, is what should be fed to pigeons as needed to correct diarrhoea, or as desirable where it is cheap and plentiful. Do not cook rice to feed to pigeons. You feed the white raw grains same as you do any other grain, uncooked. No. 21 is buckwheat.

SOME PEOPLE THINK SQUABS ARE YOUNG BANTAM CHICKENS. My Plymouth Rock Homers arrived in fine condition and in three weeks were all nesting. I now have 97 birds with them and their young. The young that hatched in February and March laid in August, so I think I did well. I have not seen any that could compare with them. Others that see them say they are a fine lot of birds. Each pair has averaged a pair every six weeks, except in the moulting time when they dropped off laying for a while. The squabs that I raise weigh from three-quarters to one pound before they leave their nests.

Mr. Haganbothan saw my birds and sent for 12 pairs from you. They have been doing fine since he got them.

I have fed principally cracked corn and wheat, buckwheat and mixed feeds, changing from one to another. I do not think it a good plan to feed long the same grains. In moulting time I feed corn, whole rice and a few peas and poultry powder. This is my first experience in the pigeon business. I have one of your Manuals and have followed it mostly. For a tonic I give them a table-

spoonful of vinegar in the water once a week and some poultry powder, which I think is a good help to producing eggs. The birds are not much care—only a few minutes in the morning and evening.

Your Manual is a great help to those in the pigeon business. If the loft is kept clean, with fresh water and change of feed there will be no sick birds or lice. To keep lice out, take slaked lime and wood ashes and sprinkle in loft. I have not been bothered with them. The cost of the birds per pair is something like 65 cents per pair per year.

I shall keep most of my birds that I raise this year and by next year will commence to sell some squabs. They sell from 25 cents to 40 cents apiece and I could sell them to good advantage. Some people do not know what squabs are and think they are young Bantam chicks.—J. L. M., Indiana.

GETTING ALONG VERY WELL IN FLORIDA. Please find enclosed check in payment for 200 fibre nest bowls. We are getting along very well with the pigeons. We have between 300 and 400 young birds. I think I should build another house and fly.—H. B. L., Florida.

LETTERS FROM CUSTOMERS RECEIVED BY PLYMOUTH ROCK SQUAB COMPANY

MORE STORIES OF SUCCESS



22. GRANITE GRIT.

23. QUARTZ GRIT.

24. SAME CRUSHED.

Here are samples of grits which never should be fed to pigeons. No. 22 is a coarse granite grit. No. 23 is a finer granite or quartz grit. No. 24 is the same material, either granite, quartz or mica crushed finer. All of these poultry grits will do the pigeons more harm than good and are useless expense. Ordinary sand or gravel is better.

HOW A LOUISIANA SQUAB BREEDER BUYS HIS GRAIN. PRICES FOR SQUABS IN HIS STATE ARE GOOD. I resigned my position with the railroad company and have moved to my home and you will please address me here. I have been very busy getting in shape for my birds and I now have them comfortably located in a nice house 14 by 24. They are getting to work nicely and as they are now in their permanent quarters and will not have to be disturbed any more, I expect soon to have a large flock of them. My birds have been moved three times in the last 90 days, but are all in fine condition, which shows they are thrifty and will do well under most any kind of circumstances.

I am buying wheat and Kaffir corn from Kansas City, Missouri. I get Kaffir corn at 98 cents per hundredweight f.o.b. Kansas City and wheat at \$1 per bushel. The freight rate here is about 70 cents, so Kaffir corn does not cost me much more than corn chops. I pay \$1.50 per sack for chops delivered here.

Every one who sees my Homers says they are the finest they ever saw. I have orders now for about 50 pairs at \$1 per pair at weaning age.

Quotations for squabs this week in my

markets are \$4 a dozen. (This price is offered by commission men.) The hotels and cafes will pay from \$1 to \$1.50 more.—G. W. T., Louisiana.

FIRST EXPERIMENT, THEN THE REAL THING. The first lot that I bought from you was an experiment, a success. I will enlarge this spring if not sooner.—J. F. C., Wisconsin.

EIGHT DAYS OLD, WEIGHT HALF A POUND. I had a squab that weighed one-half a pound when it was eight days old from the Homers I got from you a few weeks ago. How is that?—R. B. W., Ohio.

PLYMOUTH ROCK HOMERS THE BEST IN THIS NEW JERSEY TOWN. Mine are fine birds, the best in the town, there are none like them.—L. K., New Jersey.

TEXAS WOMAN'S WORK. Something more than a year ago I purchased six pairs of pigeons from you. I have quite a flock now, having been successful.—Mrs. R. E. B., Texas.

RAPID PROGRESS IN ELEVEN WEEKS. I bought 12 pairs of No. 1 Plymouth Rock Homers and received them April 11. I now (July 6) have 33 young ones.—E. L. F., Iowa.

LETTERS FROM CUSTOMERS RECEIVED BY PLYMOUTH ROCK SQUAB COMPANY

MORE STORIES OF SUCCESS

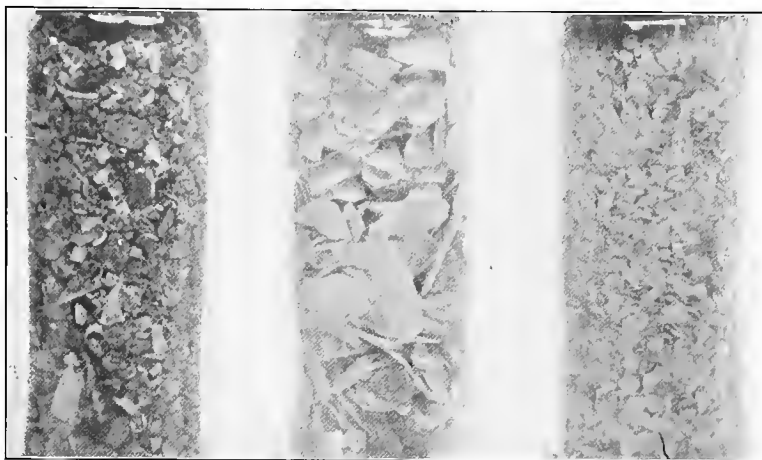

25. HEALTH GRIT.

26. COARSE OYSTER SHELL.

27. PIGEON OYSTER SHELL.

No. 25 is another view of our Health Grit same as the larger picture on page 286. No. 26 is a sample of large oyster shell such as is sold for poultry. It is too large for pigeons. The correct size for pigeons is shown in sample No. 27.

BEING DEAF, SHE WAS HANDICAPPED IN BUSINESS, BUT SQUAB RAISING SOLVED THE PROBLEM. My birds bought of you several years ago are doing splendidly and paying me amply for the care and cost given them. I have found your *National Squab Book* of the greatest practical value. I like the business better than anything I ever tried. **Being deaf, I found it especially hard to get hold of a business I could manage myself,** but in squabraising one is not thrown so much in contact with the world and one is able to feel independent. I began last fall and had several months of discouragement at first, failing to find a satisfactory market. As there is a good demand for good birds at all times I succeeded in making a permanent arrangement with a summer resort, they agreeing to take all I could send at \$4 per dozen, and pay express charges, too. My birds generally weigh 10 pounds to the dozen and are fine-looking birds. At four weeks they are hard to tell from the parents.

I have only 50 or 60 birds but have just sent off 24 squabs, have 36 in the house and about two dozen eggs. I think that is doing a very brisk business for so small a flock. I have gone in regard to feed almost exactly by your *Manual*, indeed I have followed it in every respect and could not have managed without it. I have had no sickness except once, when I left the birds in charge of some one who did not treat them properly, and once when I was without grit for several weeks. Both times they had diarrhoea and were all fearfully thin, what you call "going light," I believe. Occasionally the parents desert the squabs before they are big enough to kill and begin on a new family; but these cases have been rare.—Miss B. R., Virginia.

PRACTICAL NEW YORK MARKET MEN SUCCESSFUL WITH PLYMOUTH ROCK SQUABS. In looking over your new *Manual* (1908) I noticed a letter from a firm that does business in front of our store. It is "Heineman & Co." I am personally acquainted with them and told them I had bought pigeons from you. William Heineman wished me to mention his name to you when I wrote again, so I have taken this opportunity to do so. I feel amply repaid for having bought my birds of you and I will place my future orders for stock with you. Just as soon as I am able to branch out more I shall send for more birds. Thank you for your great kindness and clean business dealings with me and wish you still further success in your business.—R. L., New York.

LETTERS FROM CUSTOMERS RECEIVED BY PLYMOUTH ROCK SQUAB COMPANY

MORE STORIES OF SUCCESS



28. MIXED GRAIN.

29. MIXED GRAIN.

30. MIXED GRAIN.

The above are samples of mixed pigeon grain. No. 28 is a good mixture. No. 30 contains good grains but also has oyster shells and grit in it. No. 29 contains an even larger proportion of granite grit and oyster shells and the grains are poorer. The reason why some grain dealers put oyster shells and grit into their mixtures is that these two substances cost them less than half of what grain costs, and by selling the mixture at the price of good grain, they sell grit and oyster shells at the price of grain. If the breeder wishes to mix grit and oyster shells with his grain, it is much cheaper for him to buy them separately and do his own mixing.

SELLS SQUABS FOR THREE DOLLARS A DOZEN TO A MAN WHO CALLS AND TAKES THEM ALIVE OUT OF THE NESTS. Since February each pair of my Plymouth Rock Homers has thrown five pairs of squabs, all weighing 10 and 11 pounds to the dozen. Am a great believer in feed, i. e., quality and variety, and feed each morning equal quantities of cracked corn, red wheat, and Kaffir corn. In the afternoon I substitute Canada peas three times a week and hemp seed twice for red wheat, and this mixture has kept my birds in good working trim.

The self-feeder which I made according to your instructions was somewhat of a failure in my case. The birds managed to scatter an enormous amount of feed on the floor, causing a great waste, which I have obviated by the use of troughs. I feed twice a day and have by observation got the quantity needed to satisfy them down very fine. Very little grain is tossed out of the troughs, which are six feet long by 12 inches wide with one and one-half inch rims. Was very careful to see if there was any falling off in the weight of squabs when I made the change from self-feeder to trough, but none was noticeable. Have followed your instructions otherwise and must say they have worked out beautifully. Your Manual has proven a veritable storehouse of practical information and advice. Some time ago I bought some birds from a friend which he purchased from— and must admit that the squabs from your birds are whiter meat. From present indications, I am going to get at least one pair of squabs more per pair of breeders from your birds than from my other stock. Hereafter it's your stock for me. I keep a card file system which enables me to tell in a moment just what every pair in my lofts is doing. The squabs raised from your stock are all throwing healthy offsprings at four and a half months of age, which I think is very young for birds to go to work.

I am selling my squabs now to a party who takes them out of the nest, saving me the killing and dressing, and pays me \$3 a dozen for them. In the fall and winter I will get from \$4 to \$5.50 a dozen for them, and all the market I can supply.—A. D., New Jersey.

LETTERS FROM CUSTOMERS RECEIVED BY PLYMOUTH ROCK SQUAB COMPANY

MORE STORIES OF SUCCESS

FIRST-CLASS MARKET FOR GOOD SQUABS AND PLYMOUTH ROCK HOMERS IN IOWA.

I received six pairs from you two years ago and started to raise a flock from them. I purchased your **Manual** and followed it in every detail as far as possible and will state I have had fine luck. My flock now consists of 50 good mated pairs and they are working very well. I have sold some squabs and a few older birds. I receive \$2 per pair for old and 75 cents per pair for squabs. I can safely say I have made a good profit on my purchase, as I paid \$10 for six pairs of your birds direct from you. My order was sent in with Mr. J. Haas's as three of us took six pairs each. Two of us are still in the business, but he was compelled to sell out on account of moving away. I think that the squab business is one of the best. If one follows the instructions of your **Manual** he will succeed far ahead of anticipations. I am well pleased with my success, and now I am enjoying the benefit of my old birds, as I have squabs most of the time for my own table use and sell to customers here in the city. In the spring I will increase my flock.

As far as sickness is concerned, will say that I have not had any. My flock is in the best of health and has no vermin. Others will fare the same as I have if they will follow the instructions of your **Manual** in regard to care and feeding birds, also in keeping fresh water in pens. I have a hydrant in my yards and turn it on so as to keep a flowing stream at all times so I do not have any trouble in this way at all. I have my birds all marked so that if any one of them should happen to be killed or die I can pick out the mate and pair it off with another. This is also a very profitable plan so as to keep all workers in one pen. I have had no trouble in selling my squabs as the market is always open for Homers. There is a vast difference between the common pigeons and your **Plymouth Rocks**. There is a man here who raises the common pigeons which he sells for \$1.75 per dozen, but there is no comparison between the two, as the **Homers** from your farm are so far ahead, and the consumers of the squabs say they would rather pay more and get good birds. We feel that there will be no opposition from him in the squab business as our price has not been kicked on yet, nor do I think it will be. I will send you a small order for some more birds in the spring as I want to increase my flock from your birds. I again thank you for past favors and will do as much as I can to push the squab business and to hold up prices. If you have an opportunity to refer any of your customers to me, you can feel assured I will say your firm is square and will do as you say. I would be pleased at any time to help you. I will do you some good here as our stock of old birds is not for sale. Our squabs are all ordered ahead of time, so let me know, as there is a fine big market here for your **Homers** and your birds will meet with the approval of any and all.—W. G. S., Iowa.

SPLENDID FIELD IN COLORADO. ONE HOTEL TAKING MORE THAN THIS LARGE PLANT CAN SUPPLY.

The writer would like to know the names of one or two good poultry journals in which we can place an advertisement for partner in increase plant, which is at present 2000; 1200 of these birds are from your plant. Would like to procure 500 pairs from you to infuse new blood into our flock. Perhaps you might know of one who has some experience in this line who would like to come to Colorado or Denver. There is a splendid field here for the business. We have but one customer, a hotel, which we attempt to supply. This hotel consumes 20 to 30 dozen a week. They pay us \$3.60 a dozen dressed. Denver has many hotels and restaurants besides a great demand from the dining-car service from here to the coast. I have been in this business 14 months. I sent for your squab book four years ago and have gradually been drifting into the business. My wife looks after every detail of the plant while I have been working at the tin trade, which I soon hope to abandon and take up the squab business exclusively. We have solved the problem of keeping down the mites and have little or no disease among the birds. I hope in the next two years to have a squab plant worthy of the name. Any advice you can give to help the cause will be appreciated. If possible, would like to have the name of some party who would come West to engage in the business, with whom we might correspond.—H. J. D., Colorado.

CHICKEN RAISER OF FIVE YEARS' EXPERIENCE IS PLEASED WITH HIS SQUAB WORK.

The last lot of **Extra Plymouth Rock Homers** came in fine shape. Some of them started to work at once. Five pairs have eggs and are setting on them, and six pairs now have nests. The first 25 pairs I received from you, June 12, 1908. I will take a snapshot of my place when I get my big squab house up. It is going to be a dandy for 300 pairs. You will get the order from me for the **Extras**. I think they are grand birds, and the squabs are so large they are bigger than chickens. I feed good grain and hemp seed and some rice. I clean my house once a week and sprinkle lice killer in the nest boxes.

I have raised chickens for five years but squabs have got them down and out as far as I have seen. There are other little jobs of work you could do on the place with squabs, whereas if you have 600 chickens you have to attend to them from daylight to dark, and then some.

I must say one word for your squab book, I think it is just grand. I would not take \$10 for it, and not have one, and I don't see how any one could get along without it, even if he was an old-timer at the squab business.—J. B. B., Missouri.

LETTERS FROM CUSTOMERS RECEIVED BY PLYMOUTH ROCK SQUAB COMPANY

MORE STORIES OF SUCCESS

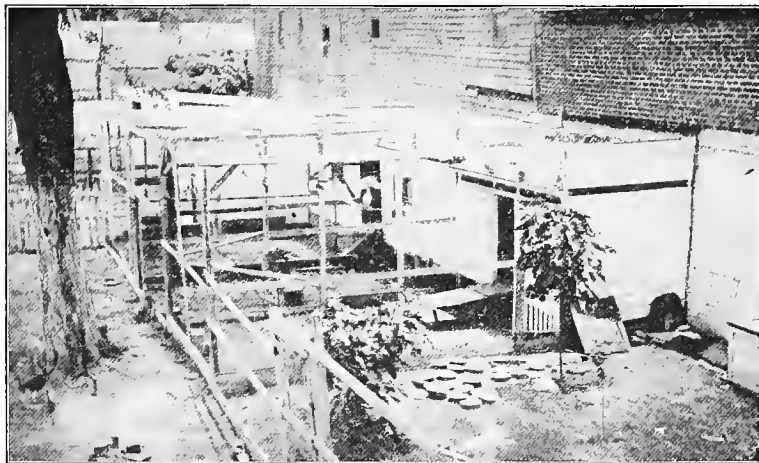

A SOUTH CAROLINA PLANT.

What this breeder has accomplished here he tells in the letter printed on this page.

GOING TO MAKE IT A REGULAR BUSINESS. NESTING MATERIAL IN THE MANURE.

A little over a year ago I bought 12 pairs of Extra Plymouth Rock Homers from you. Now I have over 100 birds in my houses and have started to sell some squabs. I am more than pleased with my birds, they are doing fine. After a while I expect I will have to get a few more from you so as to mix in some new blood.

My birds have averaged nine pairs of squabs to the pair for the year. I find the squabs at the killing age weighing from 13 to 15 ounces per bird, and for what birds I have sold, which has been only a few, I have received \$3 per dozen. I have been holding most of my birds for stock, as it was my intention at the beginning to raise a stock before entering the market. I am feeding a scratch feed with a little hempseed about once a week. My birds have been perfectly healthy. Out of the original 12 pairs I have lost only four birds. It costs at an average of five cents a month per bird and I have in my houses 130 birds; which I consider a very good increase. I am more than pleased with the birds, and intend to go into it on a business basis, making it a regular business, and I do not see why it should not be a success.

My houses are of the plainest kind, costing about \$125. They will accommodate 300 birds. I have one pair of birds that I have raised, which lay four eggs to the setting. This is the first incident of its kind that I have ever heard of. They will set on these four eggs for about 10 days, and then throw the eggs out, one by one, in consequence of which I lose the setting. * These birds have done this thing on three occasions. Two of the eggs would be fertile and two infertile. I at first thought that perhaps some other pair had laid in the nest with these, but after watching carefully I found that the eggs came from the one pair of birds.

The manure from the birds is amounting to something and I would like to get the address of some good party who will take it off my hands so that I could communicate with them. Would you kindly advise how to get rid of the nesting material or do you let it go in with the manure?—T. L. O., South Carolina.

Answer. Straw and feathers caked in with the manure are acceptable to the tanners. They do not like to get manure in which is a large amount of discarded tobacco stems, as these stain the hides.

LETTERS FROM CUSTOMERS RECEIVED BY PLYMOUTH ROCK SQUAB COMPANY

MORE STORIES OF SUCCESS

NOTE HOW THIS BREEDER BUILDS HIS SELF-FEEDERS. On December 20, 1907, six pairs of No. 1 Plymouth Rock Homers were shipped to me. I lost some squabs caused by the old ones eating green sprouts and from cats, but as soon as I made the floor tight and mended the wire on the flying pen I had no more trouble. Now (September, 1908) I have 42 old and young, with those I raised mating up and starting to build their nests and lay. My birds are all in rugged health and are doing well, breeding fat, plump squabs. I have compared them with other breeders, but mine are far better.

I give them plenty of fresh water for bathing and drinking and scald out the pans and drinking fountains with hot water once a week. I save the manure, as it has a ready sale and helps to pay the feed bill. I clean the nest bowls and floor once a week, sprinkle slaked lime over the floor, sprinkle a little insect powder on the squabs, and vermin does not bother them. I feed cracked corn and wheat, one-third wheat to two-thirds corn for winter, and for summer one-third corn to two-thirds wheat. In addition, I feed rice, barley, millet, sunflower seeds, Kaffir corn and Canada peas with a little hemp seed as dainties. I put a small trough below the holes of the self-feeder on each side. In this way, the grain which falls out is caught by the trough and there is little waste. I also have a protected box divided in halves. In one side I put health grit, in the other oyster shells. All the covers for my self-feeders are three inches wider than the feeders. This prevents soiling the grain, as pigeons are very particular about clean grain.

My squabs weigh eight pounds to the dozen. My birds have bred at the rate of from seven to nine pairs a year and one pair has bred ten pairs per year. The cost of feeding averages five cents per pair per month.

I think well of the squab business and expect before long to buy more as it is a profitable business, considering the small capital invested. I use egg crates and orange boxes as I have found them best and cheapest. The unit system is best as it is easier to keep track of several small flocks rather than one large one.

A person breeding pigeons must study and learn their birds to make a success of it.

I have read and re-read your squab book and think for clearness of description, plain explanations, and good clear illustrations it is the best live-stock book I have ever seen. When in doubt, consult the *Manual*.—J. Y. E., West Virginia.

FLOCK INCREASED FROM SIXTY TO THREE HUNDRED AND SIXTY IN EIGHT MONTHS.

I got my flock of 30 pairs of Extras into their permanent quarters in February. I now (October 5, 1908) have about 360 head of the finest young birds you ever saw. I have just put my flock through the moult and they have begun to work now in good shape. I have squabs now in my house that were raised by my young birds (the ones which I raised myself) and their second pair of squabs weighed over one pound each at four weeks of age. Is not that good work for the second pair that young birds raise? What do you think of my increase in stock from 60 head to 360 head in eight months; is that good work or not?

I can get orders for all squabs I can raise at \$3 per dozen f.o.b. cars here, but I have sold only one dozen and I got \$4.50 for them. I do not care to sell any until I get a big flock of breeders.

I am making some arrangements now to build squab houses and I want to get about 150 or 200 pairs of breeders from you in the spring; as I want to get into shape to fill orders. I had an order the first of this month for ten dozen per week at \$3 per dozen. This would have been a standing order for all winter if I could have handled it. I have one pair of young birds that laid four eggs, hatched and raised all of them. Has that ever happened in your flock? Write me what you think of my success and advise what price you will make me on an order for 100 pairs of Extras.—G. W. T., Louisiana.

FAMILY TRADE BRINGS HIM AS HIGH AS EIGHT DOLLARS A DOZEN FOR PLYMOUTH ROCK SQUABS.

Enclosed you will find check and order for pigeons and supplies for \$116.29. Please ship sundries by freight at once and the pigeons on July 23. The birds I got of you in February, 1908, are doing finely. Have raised three and four pairs each, squabs weighing at 25 days from 14 to 19 ounces alive. I have several pairs more, all raised from your Extras, so I have about 155 birds altogether now. I am clearing out the chicken pens and filling them with pigeons, as I am fully convinced they are a much better paying proposition than the chickens.

Several other firms have written me for orders, but as you took such pains with my little drib, and the birds have done so well, you people get the rest of the orders. I have the largest birds in the city, and they attract much attention from the hundreds of visitors at my poultry yards.

The *Manual* is a gem. It is plain enough for any one and I really think I have it memorized. Have several other works on pigeons, but have laid them away. They are not in the same class.

The market is good here, my birds bringing from \$4.50 to \$8.00 a dozen, all family orders. I have worked them right into my chicken and egg customers. Could sell 50 pairs a day if I had them.—J. A., Pennsylvania.

LETTERS FROM CUSTOMERS RECEIVED BY PLYMOUTH ROCK SQUAB COMPANY

EXPERIENCE OF PROMINENT WASHINGTON PUBLIC MAN BREEDING PLYMOUTH ROCK HOMERS

I wish you would send me an outfit of your Extra Plymouth Rock Homers, mated and banded. I want to see how they will turn out. I have already quite a large lot of pigeons but they are doing so poorly that I do not expect to keep them. I expect better results from the ones which I order.

The letters from customers printed in this book are evidence of the widespread interest on the American continent in squab breeding not only for revenue and for one's table, but also as a pastime and instructive hobby. It will not be forgotten that the master mind of Charles Darwin evolved "The Origin of Species" from pigeon breeding. The ideas he conceived and the laws he discovered might have been worked out with other animals, but not within the span of his lifetime, with the thoroughness he accomplished, because pigeons breed rapidly, and in other respects are ideal for experiment.

Prominent in political life at Washington are customers who give part of their spare time enthusiastically to this work. One of these ordered of us in January, 1908, as indicated by the letter printed at the top of this page. The next letter was as follows:

I am greatly pleased with the birds sent me, and they seem to be all that you have said in regard to them.

We wrote him in December, 1908, to interest him in our **Carneaux**, and received the following letter:

I have your letter of some days ago in regard to the Homers you sent me. They were very fine, and I was well pleased with them. One disaster after another has followed these birds until now I have none left. First, an owl got in among them and pulled heads off, which was followed by some other misfortune. I shall never experiment here again with them, but when I retire from the field of my labors and go back home, I certainly intend to keep pigeons. I thank you very much for calling my attention to your new Plymouth Rock Carneaux.

We are not at liberty to print the writer's name. We call attention to this to point the moral that serious-minded men of large affairs turn to squab raising with lively and sustained interest. (Incidentally, another moral is, Beware of owls!)

MORE STORIES OF SUCCESS

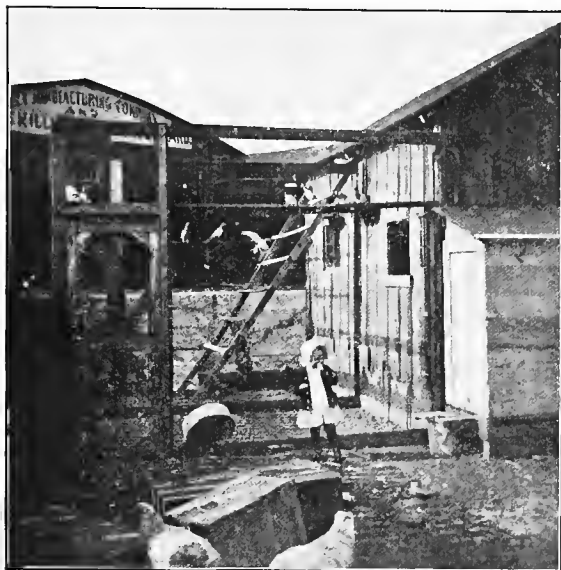

ORDINARY QUARTERS.

The Pennsylvania customer whose letter is printed on this page is doing well here.

SEVEN PAIRS QUICKLY AT WORK. ORDERING EVERY MONTH. The seven pairs of Plymouth Rock Homers arrived on April 24 in first-class order. Five nests are finished (May 7), one has two eggs and there are two other nests in the course of construction, which speaks mighty well for your stock, I think. I expect to send you an order the latter part of this month and intend buying every month. In that way I will not feel the investment so much.

One could not ask for better stock than you sent me. I am well pleased and shall be glad to boost your stock among my friends. My neighbor is more than ever chagrined at the job lot that was shipped him from the southern part of the State and will undoubtedly send you an order before long. Thank you for the pains you must have taken in selecting my birds.

(Later, August, 1908.) I write you to give you the address of a gentleman who is going into the squab business. You can use my name or not, just as you desire, but one thing you can use to him is my recommendation. When I return from my vacation, September 1, I intend placing another order for 10 pairs more of Extra Plymouth Rocks. My birds have done fine and as long as I get such birds from you, you can expect my order and all others I can throw your way. There is all sorts of rivalry here on account of the show in January.—J. B., Pennsylvania.

YEAR'S TRIAL SATISFACTORY, AND GOING AHEAD. I thought you might be interested to know that the birds we purchased of you last January have turned out finely, we having lost but two, and this on account of flying against the wire, breaking their necks. We decided to give the birds a thorough trial for a year, being novices

at the business, and I am sure as soon as the year is up, we will place another order with you, as your birds have been greatly admired by other raisers here, and they have done what you said they would. We have had no trouble in selling the squabs, which have ranged from ten to thirteen ounces each, receiving in nearly every case from 50 cents to 75 cents per pair.—C. W. C., Pennsylvania.

WON THE PRIZES IN TEXAS. My pigeons took first, second and third prizes and I credit it much to your good stock that helped me.—I. R., Texas.

IMITATION GRITS A FAILURE. Enclosed find money order for which please send me 100 pounds of your health grit and 100 pounds of oyster shells, pigeon size. I have tried other health grits that are sold nearer my city but find my birds will not touch them.—H. E. M., New York.

READY MARKET IN MONTANA. I have about 90 young and have sold about 125 squabs. I can get \$3.00 a dozen plucked and not trouble about selling them. I have paid as high as \$2 per hundredweight for wheat but am now getting wheat at \$1.15 per hundredweight; corn \$1.90.—L. E. Y., Montana.

LETTERS FROM CUSTOMERS RECEIVED BY PLYMOUTH ROCK SQUAB COMPANY

MORE STORIES OF SUCCESS

TEXAS WOMAN DELIGHTED WITH HER PROJECT. I am enclosing an order for some Homers intended for a Christmas present to my young nephew, and wish you to ship the birds so as to arrive about the 24th. In March last I bought of you six pairs of **Plymouth Rock Homers**. My flock now (December) numbers 25 pairs, the first birds hatching the 16th of April, and I have seven hens due to hatch on the 17th of this month. I think my success has been creditable and to me very satisfactory. I have lost less than half a dozen young ones, and believe the loss of these was due to a lack of rock salt in the fly. My aim is to increase the flock to 100 before beginning to market the squabs. Squabs sell in our market for 25 cents each and are scarce and in demand. My pen consists of a house 8x8 feet in which the birds roost, lay and hatch. Connected with the house I have a fly eight feet wide, 20 feet long and eight feet high; with which accommodation the birds seem perfectly contented. Many of them seem to know me and are not afraid when I go among them. I feed twice a day, about 8 a.m. and 3 p.m., giving them what they will eat of whole and cracked corn, wheat, millet and Kaffir corn, when procurable. Occasionally I throw in bits of cabbage leaves which they seem to relish very much. I have your **Manual** and have followed instructions as nearly as circumstances would permit, and with it as a guide and reasonable attention, do not see how any one could fail to succeed in a pleasant and pleasing pursuit. I believe it also profitable, even in my small way. I bought your fibre nest bowls and have them screwed to pieces that slip into the egg crates that you mentioned in your **Manual**. This makes cleaning the bowls and boxes a very easy matter. I intend in the near future to build another pen, divide my flock and test the question of "pigeons for profit." Thus far I am delighted with the project, but love for my birds may interfere with selling squabs for slaughter. My squabs weigh on an average of three-quarters of a pound, live weight, at about three weeks of age. I have had neither sickness nor lice, and on the whole am most highly pleased with my birds.—Mrs. R. E. B., Texas.

USES A WATER FOUNTAIN WHICH HE MADE FROM A BOTTLE. In February (1908) I became interested in **Homers** and thinking they would give better results than common pigeons, I sold my flock of common birds and sent you an order for three pairs of **Plymouth Rock Extra Homers**. Three days later I received them. Some friends of mine had **Homer** pigeons which they considered excellent birds, but they could not beat mine. My friends have been anxious to get some of my **Homers**, but I intend to keep all I raise until I have quite a flock.

Up to date (October) one pair has raised six pairs of squabs since I received them. The other two pairs have done nearly as well. The common pigeons I had generally stopped breeding during the moulting season, but your **Homers** kept right on.

I feed what is called here "scratch feed," composed of buckwheat, peas, Kaffir corn, sunflower seed, cracked corn, wheat and several other grains. I also give a tonic every Sunday with a little hemp seed. I use a feeder which I made, as shown in your **Manual**, and a water fountain which I made from a bottle. I have followed your **Manual**

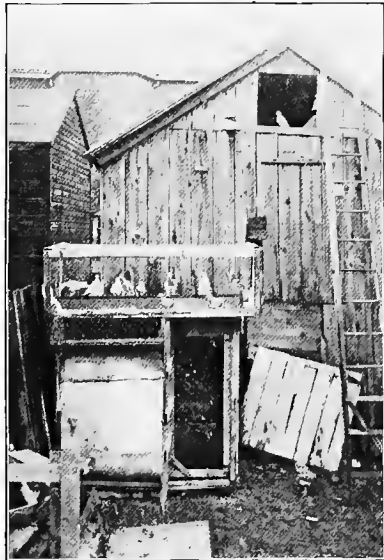

HOME MADE.

For this little plant the breeder has utilized what he had; expending hardly a dollar. He has done very well in these rough and ready quarters, however, as his letter here printed shows. (See letter of M. J. H., New York.)

in caring for my birds and think it is an excellent book. Sometime in the future I intend to give you another order.

I send by this mail a picture of my place and birds. The small pen is where I keep my young stock until they mate. The one with the **Homer** in the window is where my working birds are kept.—M. J. H., New York.

LETTERS FROM CUSTOMERS RECEIVED BY PLYMOUTH ROCK SQUAB COMPANY

APPENDIX G

The year 1909 was notable in the squab and pigeon world by reason of two important happenings: the founding of the *National Squab Magazine* and the organization of the **National Squab Breeders' Association**. The magazine is a monthly periodical. The first number issued bore the date **February, 1909**. At this writing (**January, 1910**) twelve numbers have been issued and the second year begun. This periodical was an instant success, taking at once a commanding position. It is the first successful attempt made in this country to print a handsome, up-to-date squab or pigeon periodical with only original articles and illustrations giving instruction by competent writers. A flood of letters at once poured in commending the undertaking and with its third month's issue the magazine had the largest circulation of any pigeon periodical. So valuable and interesting has been each number of the magazine that subscribers obtained through the summer and fall called for back numbers in such volume as to exhaust the supply of all single back issues. At present, copies of the **double holiday issue** dated **January, 1910** (the last issue of volume one) are on hand and will be supplied as long as they last at **twenty cents each**, or that issue will be given **free** to all who subscribe for one year during the first three months of 1910. The price of each regular month's issue and of specimen copies is **ten cents**. The price of one year's subscription is **one dollar** (for Canada, **\$1.24**). A few bound volumes of the first year's issue were placed on sale January 1, 1910, at five dollars a volume, transportation charges prepaid.

The owners and publishers of this magazine are the **Squab Publishing Company, 220 Purchase Street, Boston, Mass.** The magazine is open to all for both contributions and advertising, for all breeds of pigeons. The advertising rate is low, and advertisers have been getting amazing results on account of not only the largest circulation but also the high quality of the readers, who are able to buy. The magazine has a strong editorial staff, having the exclusive services of the best writers on squab and pigeon topics. It is a periodical of genuine interest and value, serving only the special industry of squab raising, and as such is recognized by the United States Government and admitted to the mails at pound rates.

We commend this magazine highly. We write for it and take subscriptions for it. We urge everybody interested in the subject of pigeons or squabs to subscribe for it. It will be found really original, helpful and entertaining. It is entirely different from any other periodical. Any person who subscribes through us and is not pleased with the magazine can apply to us and get his money refunded.

By permission of the **Squab Publishing Company**, owners of the copyrights, we print on the following pages, **cut and condensed**, a selection from the hundreds of articles printed by the magazine during 1909. (The first volume of the magazine contains **over four hundred pages**, each page $7\frac{1}{2}$ inches by $10\frac{1}{2}$ inches). We have selected accounts written mostly by customers of the **Plymouth Rock Squab Company**, who bought either **Homers** or **Carneaux**, or both, of us. Those who wish to duplicate the successes which these are making should get our birds and our help.

We have also reproduced on the following pages recent letters from leading marketmen, and these are **stronger than ever** in giving us credit for the founding of the squab industry and for the remarkable excellence of the **Plymouth Rock squabs** which now dominate every market wherever squabs are sold.



MEMBERSHIP BUTTON.

This photograph gives a view of four of the buttons, exact size. Two of the buttons are turned so as to show that each has a back piece to hold the button securely on the back of a buttonhole.

NATIONAL SQUAB BREEDERS' ASSOCIATION.

This was formed in 1909 and before the close of the year obtained **eight thousand members**, constituting the largest pigeon organization in the world. It was organized by the magazine and the headquarters of the association are at the magazine office, **220 Purchase Street, Boston, Mass.** **It costs nothing to join and there are no initiation fees or annual dues.** If you are breeding squabs or pigeons for market or for recreation, send in your name and get a button and wear it. To secure a button, send **ten cents** (either a dime or United States two-cent stamps) to the **National Squab Breeders' Association, 220 Purchase Street, Boston, Mass.,** saying that you are a member of the association and want a button. If you are not yet a member, say that you wish to join. Your name then will be enrolled and a button mailed you. The button is not cheap celluloid or enamel, but is made of solid copper alloy, bronze, with a dark finish like the familiar G. A. R. button. (It is not a brass button.) The buttons of the Spanish War Veterans and other organizations are of the same type and are delivered on deposit of at least twenty-five cents and generally one dollar. Our button is as good as it is possible for a bronze button to be made. Wear the button and talk up the association among your fellow pigeon men and others interested in squabs. Get them to join. The objects are: To profit financially by refusing to sell squabs at less than a profit. To encourage the eating of better squabs and more of them. To find out the best places to buy grain. To learn how and where to sell squabs as well as how to raise them. To **unite** as squab and pigeon breeders, not to fight each other, but to **help**, in any way that comes up. To boost, and not to knock. To use the influence of what is now the largest pigeon organization in the world, on any topic, or in any work that may come up, in the broadest and best way, for the good of all. To get acquainted with and understand each other, so that when button wearers get together they can clasp hands in good fellowship. Watch the magazine from month to month for bulletins of progress.



I TAKE SQUABS TO MARKET IN A BASKET, by Thomas Hanigan. Four and a half years ago I bought twelve pairs of first-class Homers. They proved so interesting and convincing that I bought six pairs more a few months later. These were all I ever purchased, but they bred so well there are now 250 full-grown birds, and I have been marketing nearly all the squabs for the last year.

I never had any pigeons before, so I studied their habits and requirements as I went along, aided by the standard literature on the subject.

In these four years, but two of the pigeons "went light" and there have been but six cases of canker with the squabs, never any with the old birds. There never has been any sickness. One night there was a commotion in the flock. Taking my lantern, I went to investigate and found a rat in the loft, which I killed. I concluded that the only way the rat could have got in was by climbing a post of the flying pen, which was against the barn and near the opening to the loft. To guard against its occurring again I took a two-foot strip of zinc and nailed it around this post, and have never seen another rat. There has been no trouble with lice or mites, for I used tobacco stems when I could get them, for nesting material, and I spray a little phenol disinfectant around the loft every time I clean out.

My regular employment as baggage-master on the railroad makes it necessary for me to leave the house at 6 o'clock in the morning and I do not get home again until 7.30 at night. This forces me to feed and water very early in the morning, and kill the squabs for market in the evening. Cleaning out the pen is a once-a-week job, left until Sundays. This does not take very long.

My staple feed is red wheat and cracked corn the year round, in the proportions of two-thirds wheat to one-third cracked corn in summer and the reverse in winter. For change and luxury, I give a little kaffir corn, millet, buckwheat and hempseed. Health grit, which I buy regularly, fine ground oyster shells, lump salt and straw are kept before them all the time, and common gravel on the ground of the flying pen.

The one hundred pairs of Homers which are mated supply me with an average of two dozen squabs a week for market. Killing them in the evening, as I am obliged to do,



MR. HANIGAN'S SQUABS WEIGHING A POUND APIECE.

there is some food left in their crops, I neither bleed, pick nor dress them, for this is the way I sell them at the Boston market. They weigh a pound apiece. As my run on the train takes me to Boston every day, I put the squabs in a basket and carry them with me. There I sell them to the marketman who will give me the best price. There is never any trouble in selling all I can raise. Last week (the first week in April), I got \$3.60 a dozen; the week before, \$4 a dozen; and the week before that, \$4.50 a dozen. Selling in this way there is no bother of picking, packing, icing nor paying express charges. I have never tried to sell any squabs to the summer people who come to my town, for they seem to think I ought to sell them cheap because I am in the country.

ENJOY GREEN THINGS, by Edward Roberts. I have a new idea. Pigeons eat water cress and radish tops, also green mustard leaves, and they like all. I feed them all the bread they can eat.

One pigeon laid an egg in a nestbox with no bowl and without even building a nest, so I put straw in a nestbowl and placed the egg in it. She took to it right off and laid another egg in two days, by its side. She is setting now.—L. Franklin.



CARNEAUX SQUABS ONE WEEK, TWO WEEKS, THREE WEEKS AND FOUR WEEKS OLD.
(Photograph by C. W. Brown. All these five views are on one plate.)

I GIVE UP CHICKENS IN FAVOR OF SQUABS,

by Thomas F. Cook. Two years ago I had had no experience whatever with squabs, in fact had no intention of ever raising any, when a gentleman living near me, who was forced by lack of time to sell his pens of birds, numbering about 400 Homers, offered them to me, and as I had read quite a bit at that time of how well others were doing raising squabs, I decided to try my luck. Of course moving them disturbed them but after a few weeks they settled down to work and were doing very fairly, when some one told me where I could buy some very cheap feed, viz.: frozen Manitoba wheat, which turned out to be the dearest feed I ever bought. The pigeons did not like it and would not eat it if they could help it, but I kept feeding it to them as I thought it was cheap and plenty good enough for pigeons. The result was they got poor and practically quit laying, and the few squabs I did succeed in raising were so thin I could not market them.

It took me months to get them back in good trim again, but I finally succeeded in doing so and they were paying me very well indeed when one night in last August my barn was burned down and the pigeon house with it. I managed to save about 100 birds, but their breeding was over for some time till I could get another house and pair them up again, but I had seen plainly that, rightly managed, there was money in squabs so hearing of a lot of about 900 that were for sale in Thornhill (about 15 miles from here) I bought them with the building they were in (a one-story frame structure fifty feet long by fifteen feet wide), shut the birds up in the house and pulled the flying pens down, then sawed the whole building in two through the centre pen. We moved it up here on trucks and set it down on a good foundation and built twenty more feet in the centre of the one we moved, making a building seventy feet long.

It was quite a bit of trouble and expense moving the building that way but it paid me, as the birds went right on breeding, in fact with the exception of a very few eggs that rolled out of some of the nests they did not seem to know they had been moved.

As a main feed I use corn, Canada peas and buckwheat alternately, with a little hemp, kaffir corn and wheat as dainties, also plenty of grit and a lump of rock salt always in each pen, also lots of clean water before them at all



SQUAB PLANT MOVED FIFTEEN MILES.

times, and a bath placed in each flying pen every morning during the summer. In the winter I give them a bath only on nice bright days when it is warm enough so that there is no danger of the water freezing.

I might say that all my birds are thoroughbred Homers. I intend to buy some Carneau later on and intend to cross with the Homers, as of course the larger the squabs the more I can get for them. My squabs now average about nine to ten pounds to the dozen.

I have been raising quite a lot of chickens, but am gradually dropping them and intend to increase the pigeons, as they pay better, take up less room, are less trouble, and the returns come in every week. There is no slack time with them as far as my experience goes. Under proper conditions and right treatment they breed every month in the year.

HOW TO GET GOOD FEEDERS, by James Y. Egbert. Feeding qualities of pigeons in a flock vary almost as much as the number of birds in the pen. Some feed their young early and often and stuff them full, making large, plump squabs. Others feed moderately and their squabs are not so fat. Some parent birds can raise three and occasionally four squabs, but the latter is rare. A squab breeder should observe his birds and mate those of good feeding qualities. In this way he would build up a flock of large, sturdy, well-fed birds. Good feeding qualities are handed down from one generation to another

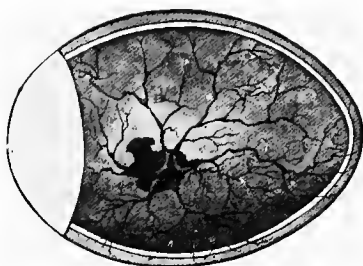

HOW A FERTILE EGG LOOKS AFTER SIX DAYS.

The nucleus with the veins radiating from it may be clearly seen at this time. The white space at the end of the egg is the air space. Around the egg inside may be seen the white membrane lining.

HATCH ONLY EGGS OF THE LARGEST BIRDS, by M. C. Martin. Many buyers of limited means who wish to start with six or a dozen pairs of Homers, demand the very choicest birds to breed their flock from, i. e. they insist that all be the very best or "top."

As a matter of fact birds are not all the same size and weight. Just like buying apples. You have to take them as they come. They are already "sorted" and the merchant will not pick them for you. So with birds.

The writer desired to breed up a flock of the very finest Homers and Carneaux and this is how he did it.

In a dozen pair about half of them will be exceptionally fine and the rest only ordinary. Whenever one of the smaller birds lays, you will find that at least one of the largest hens has done the same. Throw away the eggs of the smaller bird and substitute for them the eggs of the larger bird. The smaller pair will hatch out the eggs of the large pair of Homers.

In about ten days or two weeks the large hen will lay again. Repeat the process three or four times and then let the large hen set and hatch out her own eggs. When she lays again rob her nest and so on as before.

If you cannot find enough small birds to hatch the large ones continuously, of course do the next best thing. Always make the smaller pairs hatch the eggs of the large ones and never their own.

In this way you will get almost as many birds in a year from the very largest, as in the natural way you would have raised from large and small both. This would hardly pay in raising squabs for market, but it assuredly pays when increasing your flock of birds.

The same plan may be used with the Carneaux or any other high-priced birds. Use the small Homers to do the work of setting for your Carneaux and it is amazing how rapidly the large birds will multiply.

In changing the eggs from one nest to

another, you must be sure that the birds have laid about the same time (not over three days' difference) or the one setting will either have no bird milk in her crop or, if she has set too long, the milk will be so thick the little squab cannot take it.

This is the only precaution necessary, the birds will do the rest. All eggs look alike to them, but unlike the chicken very few will set longer than nineteen or twenty days.

Some might object to this method as being cruel and contrary to nature, but a study of the case shows that it is not. A pigeon has a short memory and a very strong nesting instinct. Rob the nest one day and the birds will many times go to nesting the very next day, showing that they are not very much "upset" and are willing to try again right away. Fifteen or more pairs of squabs may be raised from one pair of birds in this way without affecting the health of the old birds in the least, and the young are strong and healthy.

A complete explanation of this method of forced breeding is found in Rice's manual, the *National Standard Squab Book* (see page 231) and the writer can testify to its verity, as he has tested it thoroughly and boasts of one of the finest flocks of Homers and Carneaux in the West, obtained by this method of forced breeding.

After the eggs have been sat on for four or five days, hold them up between yourself and the sun, and if they are fertilized, you will clearly see a nucleus with a network of veins clustered about it. It looks just like the one-celled animal in the lowest scale of animal life, such as the amœba.

If eggs are not fertile, they will appear transparent with only a small patch of red coloring matter within. Shake the eggs and they will be found to be spoiled. Throw them away and the birds will lay again in a week or ten days. If only one egg is fertile, look for more "bad" eggs, and many times you will find several nests with one good and one bad egg. By holding them before you in the sun or before a lamp, you can with a little practice, by the appearance of the nucleus (if during the first week of incubation), match up the eggs just as well as to wait until each pair of birds hatches and then arrange the young two in a nest.

Two or three weeks' time may be saved on a pair of birds by this method. My motto is: **After five days, always have two fertile eggs in each nest.**

NINE OF TEN SQUABS FEMALES, by Dr. H. N. Kingsford. I bought a pair of Carneaux in January, 1908. This has turned out to be a peculiar pair, in regard to the sex of the young which they have bred, as I have raised five pairs of young from them, nine of which were females, the remaining one a male. The first four pairs were eight females. I have four hundred pairs of birds. I use a great many pigeons in my work in teaching. I make them pay.

HOW TO KEEP MICE OUT OF GRAIN TROUGHS, by W. L. Plumer.

For those who, like the writer, have been annoyed by the depredations of mice in the self-feeders within the squabhouse a sketch is given showing arrangement which, while simple, has proven entirely effective against these little rodents. Squab breeders are in many cases losing a much greater amount of grain from this cause than they realize, as while it is comparatively easy so to build the squabhouse that it is secure against the entrance of rats, the little mouse will in some way get in, and in numbers unsuspected by the breeder unless he has paid a night visit to the lofts. At the time I followed the general custom of placing the feeders upon the floor, it was no uncommon occurrence on the morning rounds to disturb one or more mice which had lingered within the feeders from the night before.

After some slight alterations the self-feeders were arranged in the following manner: In the centre of the unit or loft are placed two uprights two by four, thirty-two to thirty-four inches high and thirty inches apart, with strips four by ten inches on bottom of each, which are nailed to the floor. This together with two short braces gives the necessary support. On the top of each upright is placed an inverted three-gallon crock, a board five by eight inches first being nailed to top of uprights, and on these the crocks rest rigidly.

A NEW WAY TO COOK SQUABS, by Mrs. M. E. Slight. I clean them and split them in halves, then fry them in olive oil and butter, two-thirds oil and one-third butter. I first brown in the oil and butter, then cover them with water and simmer until they are cooked dry, then I slightly brown them again and make a cream gravy to eat with them. I ship my squabs alive to San Francisco and average \$3 a dozen for them. I have sold some to the sanitarium also.

BURLAP WINDOWS VENTILATE, by C. A. Herrold. I have two hundred Homers all working, and I am selling squabs from them that run from eight to nine pounds to the dozen. They bring me from \$2.50 to \$3 in Chicago sold by commission men. I have no trouble in keeping my birds in healthy condition. I think the first thing a beginner should learn is to ventilate the pigeon house. They must have pure air to breathe. Do not ventilate so that the wind will strike the birds. I think the roof should slope both ways, with a ventilator in each gable sixteen inches by twenty-four inches. The window on the south side should be taken out and left out in winter as well as in summer. Put a roller at top of window with gunny sacking to pull down in bad weather or in very cold weather.

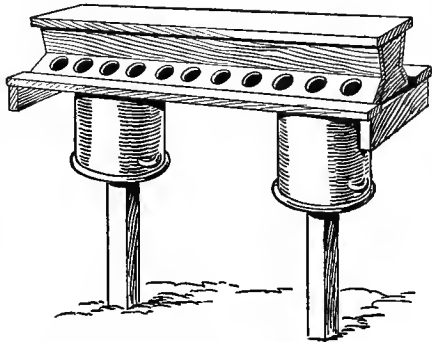

RAT-PROOF SELF-FEEDER FOR GRAIN.

MISSOURI BREEDER SHIPS TO PITTSBURG, by J. B. Beckman. It was a year ago the twelfth of this month (June) that I received the first twenty-five pairs of Homer breeders and I have at present two hundred and fifty pairs of working Homers, and five ones, too. I have quit selling squabs in my town for they will not pay over \$3 per dozen, so I ship to Pittsburg, Penn. I get \$3.75 for nine-pound, and \$4 for ten-pound squabs. My check comes every week, and it amounts to \$12 to \$15 a week.

I can raise a good deal of my feed. I have fifteen acres of land, high up on a hill. I have about five acres of Canada peas, and the vines are loaded. I have kafir corn and millet, and big corn, all for my birds, and about two acres of sunflowers—and all doing well.

I have a five-horsepower gasoline engine for pumping my water for my birds.

We are going to enlarge our plant before fall for three hundred more pairs. With what buildings I already have I will then be breeding seven hundred pairs. I think things look good for me.

FRANTIC OVER GREEN VINES, by Louis A. Hart. I am having fine success with my Carneaux. All four pairs that I bought have families, besides some of the squabs that have mated. I am enlarging my flying pen, enclosing a lettuce and a tomato bed. They do so much better with more room, and they go frantic over green Canada pea vines.

I am raising some very fine Homer squabs but not enough to supply the demand for this kind of stock. In my position as meat cutter in one of the highest class markets here, I have a good opportunity to market all the squabs I can raise.—Henry A. Lindenschmitt, Colorado.

<hr style="width: 100%;"/> <small>REFERENCES: FIDELITY TRUST CO. COMMERCIAL AGENCIES</small> <hr style="width: 100%;"/>	 <p style="text-align: center;">Nathan Schweitzer COMMISSION MERCHANT POULTRY & GAME 291 Washington Street, <small>NEAR CHAMBERS STREET</small></p>	<hr style="width: 100%;"/> <small>TELEPHONE CALLS 5302-5303 WORTH</small> <hr style="width: 100%;"/>
---	--	--

9/29/09.

Mr. Elmer C. Rice, Treasurer,
Plymouth Rock Squab Co.,
Boston, Mass.

NEW YORK,

Dear Sir:

We are very pleased to note the signal success of the Squab Magazine, and the small card which we inserted with our name, has brought us numerous inquiries from all over the country from Squab Raisers, as to market prices and conditions, and has resulted in the receipt of shipments of some very fine birds.

There is absolutely no limit to the quantity of Squabs we can handle, and as our trade is constantly extending, we are anxious at all times to keep in touch with raisers of good Squabs.

It is a source of satisfaction to observe the better quality of birds now being received on the market, due, no doubt, to the eliminating of poor breeding stock, greater care and attention given to the keeping and feeding of the birds, and more intelligent dressing and shipping. All this is due, we believe, to the educational efforts of yourself, and the testimony is present in the superior quality of the Squabs now being received, as compared with a few years ago.

We endeavor at all times to give our shippers the best possible prices, make prompt returns, and are pleased to furnish all the information in our power.

We wish to thank you for the courtesies you have shown us in the past, and with best wishes for success in your continued efforts to improve the squab industry, we are,

Very truly yours,



XSS/LLO

HOW THE CITY MARKETMAN WANTS SQUABS, by A. Silz. Squab raisers should bear in mind that squabs should not be more than three to four weeks old when killed, and after being killed, it is very essential that they be allowed to bleed properly, by hanging head downward, otherwise the blood congeals and tends to turn the bird more or less dark. The best-selling squab, at all times, is the one which is perfectly white and free from blemishes.

Within a short time after being killed and after being dry-picked perfectly clean of all feathers, it is a good plan to immerse the squabs in ice-cold water until such time as they are to be packed for shipment. They should never be held for any length of time, as it tends to make the birds flabby, and by the time they get to the dealer, who places them to the trade, they present a very stale, undesirable appearance, and in the majority of cases, must be sold at a sacrifice as a result of this condition.

We receive, from time to time, among the fancy squabs, some nice, large, plump birds which would otherwise be perfect were it not for one or more red blotches which appear on the back of the bird and detract from its appearance to such an extent that high-class trade will not touch them at all. If squab raisers can arrive at some method by which these red blotches will be eliminated they will very naturally benefit, as the birds will bring better money, at all times, where this condition is not apparent.

During the summer months, the squabs, after being properly cooled, should be carefully packed between layers of cracked ice, using a laver first to cover the bottom of the package, then a layer of squabs arranged head downward, then another good layer of ice, a layer of squabs and so on, and when the package is filled a good double layer of ice on top, so that the birds are completely enveloped. This will keep them thoroughly chilled and prevent any chance of spoiling while *en route*



A. SILZ.

to the dealer. Care, however, must be exercised, even here, that too many squabs are not put into a package. It is better to use a little more ice and not pack the squabs very tightly, as this all tends to bring them to market in the best possible condition.

WHY, WHEN, HOW TO TRANSFER SQUABS. It is a noticeable fact to all squab breeders that there is apt to be a difference of size between the two squabs in a nest when they are three days old and upwards and that the difference in size becomes more apparent the older they get until they are pretty well feathered. This condition is found less with Homers than with any of the other breeds, but Homers are not exempt from it. The reason for it is that one egg hatches from one to two days before the other. As soon as the first one hatches the parents begin to feed it and it will double in size in a day or two so that when the second squab hatches it is only half the size and strength of the first one.

Have a flat-bottomed basket or box with a handle that you can carry on your arm. With this go through all your nests twice a week and even up the sizes of the two squabs in each nest. First, take a hasty glance through the nests in a pen to get an estimate of how many pairs of squabs need attending to and their relative sizes. Then take one of an uneven pair and put in the nest of another uneven pair so that the two will exactly match, remove the third one thus formed and either put it in the first nest or in some other so that they will exactly match in size and so on. If there is a nest with but one squab do not hesitate to put another with it if it be of the same size.

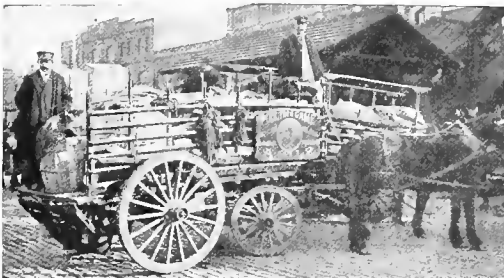

A SILZ DRAYLOAD OF SQUABS FOR ONE OF THE TRANS-ATLANTIC STEAMSHIPS.

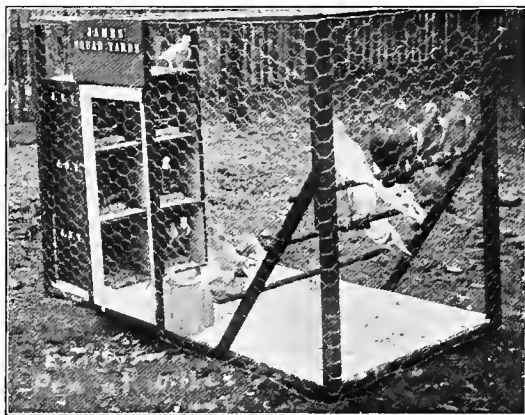

SQUAB PEN FOR POULTRY SHOW.

This is good advertising for a poultry show, much better than merely showing the old birds, for a stranger to squabs is intensely interested in seeing the young and actually realizing how quickly they grow to market size.

HOW I SELL SQUABS FOR SIX DOLLARS A DOZEN, by Lynn L. James. My introduction to squabs came through buying only three pairs of Homers a year ago, or to be more exact, on February 15, 1908. I was then, and had been for some years, a breeder of high-grade poultry, single comb white, buff and brown leghorns. I had read a good deal about squabs and being over-cautious, perhaps, started with only the three pairs.

I bought them at the right place and my experience with them was so encouraging, they did so well, that on July 25, 1908, I invested a hundred dollars in sixty pairs more from the same concern. These have kept on with the good work and this month I am buying fifty pairs more.

I certainly have had unbounded success and now have a house of four units more under construction. I have five units full of breeders and cannot get enough squabs for my trade. I have no competition in my Pennsylvania city, and the enclosed card will show you my prices.

I have discarded poultry entirely. All pigeons for me. As the old saying goes, they have chickens "beaten to a frazzle"—and I did exceedingly well with them also.

The accompanying photograph shows my exhibition coop at the poultry show here. I built that exhibition pen for the poultry show after my own ideas. The nests contained squabs of all ages with the old birds caring for them, all finished in red and white same as my

coops are. The newspapers gave it a good notice.

I have exhibited at various places this fall and winter in hot competition and taken all the first and second prizes, and it all helps my advertising as my cards, etc., are all trade-marked. I am breeding from two hundred pairs now, getting from \$3.50 to \$6 per dozen. I sold \$24 worth of squabs yesterday and turned away telephone orders amounting to \$12.50 since noon to-day, but won't do that long.

People here say they never saw such large squabs. I am getting the whole city stirred up over it.

The mortality list is very small compared with chickens, and squabs are less work, while for profit, well, chickens may as well quit trying. I have all three hospitals ordering squabs, and hotels clamoring for even the smallest. It's great, I tell you. Guess I

have blown my own horn enough, but I get enthusiastic over it and forget to stop.

The card which Mr. James refers to in his letter above is what is known as a private post-card. On the front is a place for the one-cent stamp and the address of the customer. On the back is the following printed matter, the places for the prices being left blank and filled in by pen when the card is sent out.

(Italic type indicates what is filled in by pen)

EAT
(Trade Mark) Squabs
(appears here)

We are pleased to quote you prices on fresh Squabs for the month of *February, 1909*, as follows:

Prime, 10 lbs. to doz., per doz.	\$6.00
No. 1, 8 to 9 lbs. to doz., per doz.	\$5.25-5.50
No. 2, 6 to 8 lbs. to doz., per doz.	3.75-4.50

Unpicked Squabs twenty-five cents per dozen less the above prices. Telephone orders given prompt and careful attention. Bell Phone 1208-R. People's Phone 710-R.

JAMES' SQUAB YARDS

Mr. James sends out the above postal card (no letter under a two-cent stamp needed) to past and prospective customers, once a week, or as needed, and they order by either of the two telephone systems or by postal or letter.

HOW TO MAKE A CHEAP SHIPPING CRATE, by F. B. Shepard.

The crate we use for retail, or individual, trade in dozen lots as shown in the picture is made of strips of any light, tough wood except pine, as the odor from pine might taint the squabs. The strips should be sand-papered so that the crate will look and be clean. The cover is fastened at the back with wire loops, not hinges. The cover is fastened at the front with pieces of iron wire three inches long, which you bend around the heads of two nails. The strips of wood are seven-eighths of an inch or one inch wide. The nails are wire brads, three-quarters of an inch long, not only driven in but clinched where possible.

Each squab is wrapped in waxed paper. Six squabs are put on the bottom of the crate, breasts up, and six more on top, breasts up, thus the crate being filled.

The express company is conquered by such a crate. It is so light (it weighs only seventeen ounces), that the additional express charges amount to little or nothing. It has cost less than would be asked to transport it back home, so your customer can keep it.

SELLING 2000 DOZEN SQUABS A WEEK, by Ray S. Long. A short time ago I had occasion to step into the New York store of Heineman Brothers, to see how their business was, and it is needless to say that I was greatly impressed with their methods of handling their big trade. They have a very large, spacious building in Washington Street well equipped with every modern appliance for carrying on their extensive business, which is located in one of the busiest sections of lower New York. They handle all kinds of poultry, game, etc., but that which most attracted my attention was the enormous trade in squabs. This trade is attended to in a very quick and efficient manner, consequently they have to have plenty of squabs on hand in order to supply the demand, which calls for from fifteen hundred dozen to two thousand dozen squabs weekly, most of which are used by many of the large hotels, restaurants and steamships. They are at all times in a position to handle good squabs and pay the highest prices for them, as they cater to a fancy trade which demands a good squab, one that is white and plump weighing from seven and one-half to twelve pounds to the dozen. They pay the best price for birds of this weight. In packing for shipment, great care should be used in arranging the squabs according to size, color and general appearance. It takes only a little more time and attention but it more than pays one in the end, for the squabs command a better price.

The squab market in New York is never overcrowded with first-grade squabs. I advise those who are raising squabs to raise only A No. 1 birds, for then they need never fear of

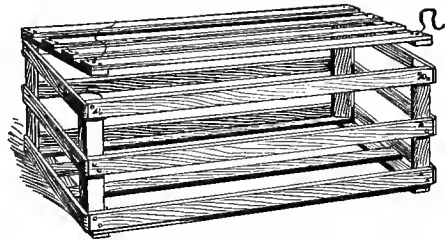

TEN-CENT SHIPPING CRATE FOR ONE DOZEN SQUABS.

Inside dimensions, in inches, 14 long, 7 wide, 6 high. Strips are one inch wide. Weight 17 ounces.

not finding a good active market for them at all times. Everywhere the trade is demanding good squabs and is willing to pay for them. It doesn't pay to waste one's time raising inferior ones, so get busy and produce the kind that is wanted.

The Heineman Brothers are always ready to receive squabs, so do not be afraid of sending them too many fine ones, for they can handle any number.

You will be pleased and encouraged to know that many of those who ship squabs to this concern state that their parent stock is from Mr. Rice's famous Plymouth Rock birds. Letters come to them telling of the good results obtained which are simply due to their being started right by Mr. Rice, and it pays to start them right, for then one does not meet with the discouragements that many do who buy cheap birds; further, their trade is continually demanding squabs raised from the Plymouth Rock stock, giving evidence of the sterling qualities of these birds.

MATTING STRAWS FOR NESTING, by Edward Rice, Texas. A good substitute for tobacco stems is matting straws unwoven and cut into five or six-inch lengths. They make a thick and compact nest and the birds like them if they are sweet and not too old. In this way a cheap but good nesting material may be provided. Some may think that they are not good because they don't keep away mites and lice, but I think cleanliness is the best thing for that purpose anyhow.

WIRE DOOR FOR VENTILATION, by Edward Rice, Texas. In order to give my pigeons plenty of fresh air I have removed the wooden door in my loft and put a wire one in its place. The air inside the house is always fresh. As the door is in the east end of the house it allows the sun to shine in and warm up things on winter mornings, and also allows the easterly breezes to blow through it in summer. Sometimes I close the door on cold nights.

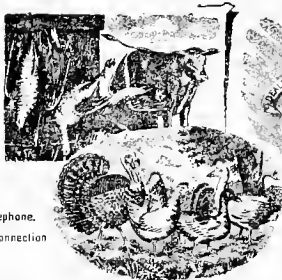

Telephone.
Connection

Heineman Bros.
 Commission Merchants
 217 to 221 WASHINGTON ST.
 78 to 82 BARCLAY ST.

Camel & Poultry
Diamond Back
Ferrari

Sept. 24th, 1909.

Mr. Elmer C. Rice,
 Treasurer, Plymouth Rock Squab Co.,
 Boston, Mass.

Dear Sir:

We herewith wish to state, that with all our numerous shipments, we take great pleasure in noticing the fact that they use your breed of birds. This class of birds has given us and our customers the best of satisfaction, we having no complaints whatever offered us during the entire past season.

We have asked a large majority of our shippers where they at first purchased their stock to go into business, and find your name at the top of the list.

There is none who takes such an interest in the breeding of squabs as your firm does, and we assure you that anyone purchasing your stock will be satisfactorily recompensed for his venture, and will always be perfectly satisfied with the outcome of using your breed of birds. We can only say, they are the best for them to handle, and past experience has taught us they will make more money in shorter time, DOING BUSINESS DIRECTLY WITH YOU, than with anyone else.

Yours very truly,

Heineman Bros

HOW TO TRAIN HOMERS TO CARRY NEWS, by Alfred Lloyd.

To obtain best results in condition and endurance in the flying game regularity in feeding and exercise is necessary. We generally fly the birds three times a day, about thirty minutes to a fly, for a week or so. After that we give them one hour three times a day. Our first toss would be two miles; the second toss five miles; the third, ten miles; the fourth, twenty miles; the fifth, thirty-five miles; the sixth, fifty miles; the seventh, seventy-five miles, and the eighth, one hundred miles. After that the birds ought to fly one-hundred-mile jumps right up to five hundred miles.

Of course one might take a bird from the loft and jump it to five hundred miles and have it come back, but it is simply a chance. I jumped one myself from thirty-five to five hundred miles, but it took five days to get home.

The above training applies to mature birds, but for training young birds it is different. Young ones should not be flown before they are three months old, and it is better to wait until six months. There are more Homers whose training begins at six months than at three. Young Homers should not be given more than a hundred-mile fly for the first three tosses. The best way is to give them tosses of three, five, ten, fifteen and twenty-five miles. After that, they can stand jumps from twenty-five to one hundred miles.

The picture on this page shows an opening guarded with wires set where the window of the squabhouse generally is, or at the end of the flying pen. The bird pictured has just completed a flight and is about to push the wires further and drop down into the middle of the coop. As soon as the bob wires move out from a vertical position, the electric circuit is made by the contact breaker and the electric bell rings to inform the owner that the bird has arrived home. Two cells of dry battery are shown in the picture, also the electric bell. The battery and bell may be set anywhere on the premises, even two hundred feet away in the residence of the owner, if desired. As soon as the bird has dropped into the pen, the wires fall back to a vertical position and the bell stops ringing. A battery of two cells would cost fifty cents. An electric bell costs about fifty cents. The wiring would cost half a dollar more. The bob wires and frame cost about twenty-five cents a wire. You can buy them with two, four or six wires, etc. The whole outfit is inexpensive, and is the source of much pleasure

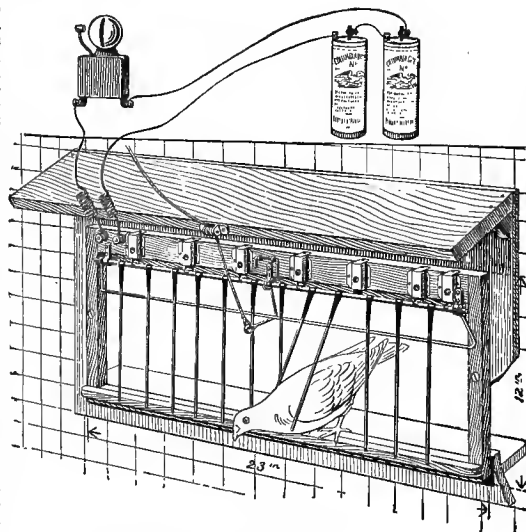

BOB WIRES WITH ELECTRICAL ATTACHMENT.

and enjoyment. The bent wire and cord shown in the picture are for the purpose of raising all the bob wires by a pull from the back of the squabhouse, so that the birds can go out for their exercise. The cord is released so that the bobs will drop and be in position for tripping when the first bird comes home.

HOUSE TO HOUSE CANVASS, by William H. Woodruff. As we have no very large quantity of squabs, our method has been to make a house-to-house canvass for customers. This prevents creating demand without supply, as advertising would do. We have sold squabs for over two years and have always received at least seventy cents a pair to private trade. We shipped a dozen to New York and got \$2.55. From this express charges were deducted. The best plan, especially with a small flock, is to build up and hold a good private trade.

SALT BAKED IN CANS, by A. L. Thompson. I take a common empty tin fruit can and punch holes in the bottom for drainage, then fill with salt, and dampen, after which I put in the oven and bake hard. You can put these cans in any place in the squabhouse and if you lay them on the side, the pigeons cannot soil the salt. One end of the can is open, the other end closed.

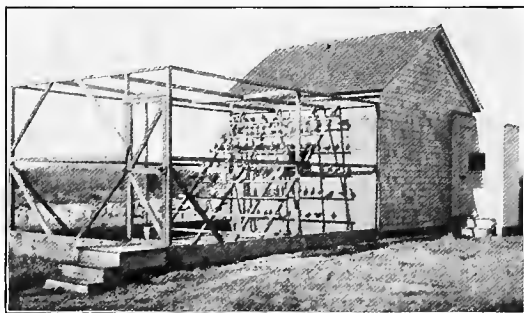

MISS DUNHAM'S PROFIT-PAYING SQUAB PLANT.

HOW TO CURE SQUABS IN NEST OF CANKER, by M. C. Martin. It is a well-known fact that Venetian Red paint is one of the best regulators for poultry in general. I have tried this on squabs repeatedly and it invariably cures the canker in three or four days. Have some Venetian Red paint in the squabhouse, and whenever you see a pair of squabs looking sickly, examine the mouth. If you find a cheesy deposit, take a pinch of the paint between thumb and forefinger and drop into the open mouth. Do this morning and evening for three or four days and the canker is gone.

This plan may be used with old birds, but they very seldom have canker and are more difficult to catch twice a day, but with squabs it is a matter of only a few minutes to straighten up several dozen of them.

Venetian Red is a fine regulator and may be used in the drinking water to ward off canker but to cure the ailment it must be administered in larger quantities as explained above. The droppings become red, showing that the paint has passed completely through the alimentary canal and cleansed the digestive system of impurities collected which have caused the canker.

Venetian Red is a powder which retails in a paint store for five to ten cents a pound, but in a drug store you may be charged fifty cents a pound for it, and some poultry remedies have it in fancy package style at the rate of a dollar or more a pound.

FLAXSEED INSTEAD OF HEMP, by Paul Gosser. I feed some flaxseed to my pigeons besides hemp. Flax is cheaper and the pigeons like it nearly as well as hemp. My pigeons like lettuce leaves very much. In the morning I throw some into the pens and at noon they are all eaten. I sell all my squabs in Pittsburg. I get from \$3 to \$4.50 a dozen for them.

HOW I MAKE MY SMALL FLOCK PAY WELL,

by Mary Dunham. I bought six pairs of the best Homers in October, 1904. After studying them and breeding them for a year I bought twenty-four pairs more in October, 1905. In June, 1908, I bought twelve pairs more and in October, 1908, another twelve pairs.

All of my birds were bought from the same source. They have all kept steadily at work. One pair has raised ten pairs of squabs a year and there are others which almost equal them. In the fall of 1907, I began to save the squabs from the best breeders. I had to keep them in the house with my

older birds because I had no other pen for them. They disturbed the breeding pairs somewhat but the following spring they mated and got down to work.

I sell all the squabs I can raise to the local marketman. At first there was no sale for them in my Connecticut city, except in the summer when the wealthy people from the larger cities were sojourning here, but the marketmen bought all I had last winter.

When ready for market my squabs weigh from two pounds to two and one-half pounds a pair. They are white and fat and the dealer has complimented me about them many times. I find the business very interesting and would like to engage in it more extensively if I could get more time to devote to the birds but it is impossible to do so at present.

I am often praised for the fine appearance my birds make when out in the flying pen. Last week a gentleman told me my little house is the neatest and the birds the finest looking he had ever seen.

NO NEED TO GRIND PIGEON MANURE,

by Harry Howe. Having read in the magazine the different methods of handling pigeon manure for the making of commercial fertilizer, I will tell you the result of my own experience. I take the cleanings and then pack them in barrels. When I have several barrels of them, I form a pile outdoors consisting of a layer of manure, then a layer of loam, sprinkling each layer with air-slaked lime until it shows white. Keep on until you have used all the manure on hand, then cover the top well with loam, and wet the whole pile. After a few days, when it commences to steam, it should be well turned over, repeating the turning over three or four times. You will finally have a fertilizer as fine as sugar which can be thoroughly dried and bagged, or used at once. This for a variety of crops cannot be beaten.

WHY I PREFER SQUABS TO CHICKENS, by Mrs. Lizzie A. Trout. I wish to keep on increasing my flock of pigeons as I like the work better than raising chickens. I have learned that if one would succeed in squab raising he must like it and by so doing acquaint himself with the little things that are of great value to the successful squab raiser. The following are important points: care of the birds, what to feed, how to feed and when to feed.

My squabhouse is built on the slope of a hill facing the south and as this is a warm and pleasant location I do not have frozen squabs in the winter. I give them tobacco stems to build their nests and by frequent cleaning give no chance for the lice to live in my squabhouse. I find that to give a variety of feed is the best. A good mixture is six quarts of sifted cracked corn (not too fine, because if it is fine it takes out much of the meal from the corn, which otherwise would help to fatten the squabs), six quarts whole wheat, two quarts buckwheat, two quarts Canada peas and two quarts kaffir corn. Every other morning I give them a few handfuls of millet seed and twice a week hempseed. I think this is a good mixture for them. I also keep within their reach charcoal, salt, fine oyster shells and a grit of which the old birds are fond. Before I used this coarse grit, I noticed that a few of my hens would prefer being out in my outside pen or yard, and were in a constant hunt for something, and trying to pick up bits of gravel and stone. It appeared to me that perhaps a coarse grit might be a help to these birds and I find it did the work well.

I always try not to have left over any feed, or very little, until the next feeding time so I know that their grain will be sweet and clean. They will be more eager for their feed. I do not like the idea of throwing feed on the floor and they will get the feed more or less dirty even if you do clean the floor once a week. I feed in a box six feet long, two feet wide and three inches high. The birds cannot scatter the feed in this way very much. This box is large enough for a loft of fifty pairs as they never all feed at the same time. Feeding should if possible always be at the same hours, seven o'clock in the morning and four o'clock in the evening. This will give the birds plenty

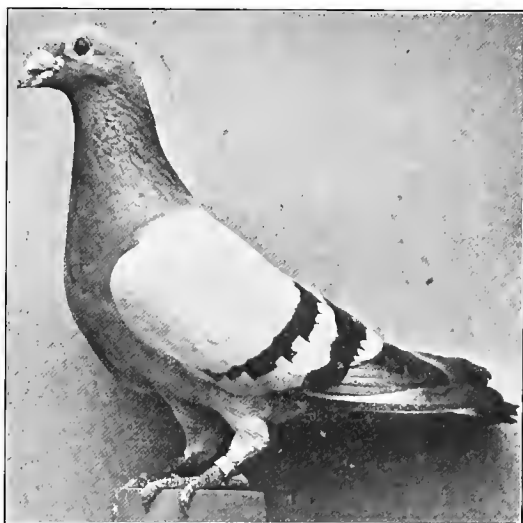

BLUE-BARRED RACING HOMER.

A beautiful flyer bred by Paul F. Miller which has covered five hundred miles in one day.

of time to feed their young before night. I wash my fountain and give my birds fresh water twice a day in winter and three times a day in summer. They are as glad for the nice fresh spring water in the hot summer day at noon as you would be for a plate of ice-cream.

As to my choice in chicken or squab raising, I prefer by far squab raising. There is not half the work, with much quicker results and feed for the purse. No unruly hens to contend with. No squabs to run after when a rain is coming. They are already cared for. No lamp to fill and trim, no thermometer to watch, no eggs to turn, no trays to change. The old birds do all this work themselves. No wind to blow out the brooder lamp and chill the squabs at night. All this you must contend with if you want to raise chickens.

Feed your pigeons the right kind of feed, give them plenty of fresh water. Then they will care for the squabs themselves and in four weeks' time the squabs will be ready for market. There is a field for prosperity in squab raising.

When President Taft started on his 1909 trip, he was given a banquet by the Boston Chamber of Commerce. One line in the menu was roast squabs, two thousand in number.



FIRST-CLASS HOMERS, SILVER AND SPLASH.

Plymouth Rock Homer stock produces squabs which sell for \$3.50 to \$6 a dozen in Utah, unplucked.

SQUAB PIE, by James Y. Egbert. Dress, draw and singe four squabs. Stuff them with the chopped livers, hearts and gizzards and fine bread crumbs, mixed with chopped parsley, a large lump of butter, pepper and salt. Run a small skewer through the body of each, fastening the wings to the sides. Cover the bottom of your bake-dish with thin strips of ham. Season with chopped parsley, pepper and salt. Over these lay the squabs. Between every two squabs put the yolk of a hard-boiled egg, and three or four in the center. Cover the squabs with a thick brown gravy. Cover this pie with puff-paste and bake in a moderate oven for an hour and a half.

BRAISED SQUAB. Clean, wash carefully. Put a large olive in the body of each. Bind legs and wings neatly to the sides of the birds. Fry six or eight slices of fat salt pork in the frying-pan until crisp. Strain the fat back, lay in the squabs and roll them over and over in the boiling grease until seared on all sides. Take them up and keep hot. Add a tablespoonful of butter to the hot fat, and fry an onion, sliced, in it. Lay the squabs on the grating of the roaster. Pour the boiling fat and onion over them. Add a cupful of stock. Cover and cook steadily for three-quarters of an hour. When the squabs are done wash with butter, dredge and brown. Remove to a hot dish and make the gravy. Serve with currant jelly.

STARTED SMALL, GREW UP BIG IN UTAH, by Walter Bramwell. Two years ago I purchased twenty pairs of the best Homers. Being cashier of a small bank in a country town, much of my time in the morning and afternoon was unoccupied. I sent for the birds out of curiosity and for recreation and study. They immediately impressed me as being very interesting. My little flock commenced operations shortly after arrival and as they rapidly increased in number my interest increased in proportion.

It required little time for me to discover that my Homers, properly handled, were money makers, and to that end I have built up a fairly large business, having now more than twenty-five hundred breeders.

At first my plant was in a small town but in the meantime I have moved to the largest and best city in the State.

The market conditions at that time were very much undeveloped and when I would mention squabs there would be a round of laughter from my friends. However, to-day, through persistent effort and the production of first-class squabs, the demand is greater than I can supply.

During the present winter I will enlarge my plant to four or five thousand breeders, and later on will be prepared to furnish all squabs desired by my patrons. My customers consist of cafe, club, hotel and railroad officials, who buy the best, and whose patronage is very satisfactory to me, because I am not compelled to sell to commission men and can thus demand a larger price for my product.

The price in this State is from \$3.50 to \$6 per dozen, undressed.

The future for the business here appeals to me as being a very bright one and I feel confident that my business stunt of squabs will reward me handsomely.

The business is attractive and profitable beyond expectation, provided the proper attention and skill are exercised that would be demanded in other lines where success is attained. I am delighted with my birds and business and trust all who are or may be interested in the same line will have their efforts crowned with success.

PECULIAR COLOR RESULT, by C. C. O'Neal. About the young birds from the cross of two Carneaux males with two white Homer females, generally they are of *solid black* plumage, sometimes dark-shaded checkers.

HOW A BIG OHIO PLANT SHIPS SQUABS, by F. J. Bunce. On Monday morning while the attendant is watering, and before the birds are fed, the rounds of the pens are made and all of the squabs that have dropped to the floor over Sunday are placed in a crate, and these with enough more to make six dozen, are removed to the killing room for the early morning start. These are enough squabs to run the pickers several hours and give the breeders plenty of time to feed the young before more squabs are required for the killing room.

There is no set age at which a squab should be marketed. Some will be ready at three and a half weeks, some at four and some not until five weeks of age. If the squab on the nest is solid and plump and is full feathered under the wing, it is ready for the market. Do not hurry them off the nest unless it be absolutely necessary to fill an order, as a few days longer on the nest may make ten-pound squabs of birds that would not weigh more than eight pounds if dressed too soon.

We do not suspend the squabs from a string to pick them, as the most of the large plants do, but pick them in the hand. Our picker has always contended that he could pick a squab while the other picker was hanging his up and taking it down.

Place the left hand around the base of the wings after drawing them together and draw the head back between the thumb and first finger. Insert the killing-knife well back in the mouth and draw it sharply up and forward, twisting the knife as you remove it from the mouth. Care should be taken not to insert the knife too deeply into the brain, as the bird will bleed too freely and cause the skin to set before the feathers have been removed.

As soon as the incision has been made, remove the wing and tail-feathers first, following this with the neck, and then the balance of the body.

The squabs are then placed in the buckets to remove the animal heat. When the buckets become full, the bodies of the squabs are washed off, the blood is removed from the mouth and the filth from the feet, and they are placed in another and larger tub, where they remain until it is time to pack them.

We wish to say here that we never leave the squabs in the tanks over night, if we can avoid it, as they are apt to get soft. If unavoidable, ice the water heavily, but always do your best to get them out on the first train for their destination.



EXTERIOR OF ONE OF THIS OHIO PLANT'S HOUSES.

Never use a box for packing your squabs as some will recommend, for the simple reason that the express messengers will up-end the package, also pile other boxes on your shipment, and when it reaches your market, your commission man reports it arrived in bad order and you are given a nice little cut in your remittance.

We use a small keg for small orders and a cracker barrel for larger shipments. First fill your barrel or keg with water and let it stand until it drains out to swell it, then line it with a good grade of white parchment paper to make it air-tight. This also helps the appearance of your package. Before placing any ice in the package bore a small hole in the bottom of the barrel to drain off the water which would gather from the melting of the ice. Place a large scoopful of finely cracked ice in the bottom of the barrel, then place in the barrel in very nice order a layer of squabs, a thin layer of ice and another layer of squabs, repeating until barrel is three-fourths full. Then fill to edge with ice cracked to about the size of a man's fist. Fold the balance of your parchment paper over the top, remove the hoop, place a piece of burlap over the barrel, replace the hoop and drive down in place, holding it in place with small lath nails. Fasten your express tag to a strong cord or wire and run through the burlap, fastening same securely.

Question: I have bought a set of steel figures to number leg bands but the figure 9 is missing. **Answer:** To make figure 9 hold the figure 6 die upside down. None of these sets has both a 9 and a 6. One die serves for both.



FLYING PEN WITH BOB WIRES.

The small holes guarded by the bobs can be seen at the top of the flying pen. The pigeons cannot get out unless the bobs are raised. They can enter whenever they please by pushing back the bobs.

TWIGS ARE GOOD FOR NESTING MATERIAL, by James Y. Egbert. I have tried hay, straw, pine needles, leaves and twigs for nesting material. The birds will use twigs in preference to any other material, building a neat, compact nest lined with a few wisps of hay or straw. I cut the twigs into five or six-inch lengths and place them in a berry crate, then after the squabs are taken from the nest I clean the twigs and replace them in the crate. In this way, the pigeons use the twigs over and over again and the breeder does not have to supply so much new nesting material.

I suppose that on the seashore, where Homer pigeons originated, they used twigs lined with dry grass in their nest building.

I find it is a good idea, in preparing my garden, to plant a few rows of sunflowers, and in the odd corners or along the border scattered seeds may be sown. In this way a squab raiser can have all the sunflower seeds he needs for his pigeons at a trifling cost. Pigeons are very fond of these seeds and if a breeder raises his own the feed bill is cut down just so much. Sunflowers require little cultivation and will grow and thrive in almost any location.

Question: Are squabs ever scalded before plucking? **Answer:** Yes, but it is not necessary, nor do the dealers want them scalded. They should be dry-picked.

SEVEN YEARS' PROFITABLE EXPERIENCE, by P. A. Heiermann.

I have been raising squabs for nearly seven years and have found it a good paying business. I started with one pair of common pigeons. After having them a few months and learning their habits, I bought ten pairs of good Homers. Their squabs were much larger than the common pigeon squabs. I then began to save all of the largest squabs and banded them so as not to inbreed, and numbered the bands and kept a record of them. At present I am getting from \$3 to \$5 a dozen for my Homer squabs dressed, according to size, but at wholesale I get \$3.50 a dozen straight through.

I sell most of my squabs at retail, and then cannot supply all my orders.

The city in which I live has a population of about sixty thousand and I have a home market for all the squabs I wish to put out. My squab plant is on the car line and can be reached from all parts of the city.

I never have donated any squabs to get customers, but at first when I had no market for them I telephoned parties whom I thought would want them and I soon found places to sell. When I got a new customer I always gave him a few of my cards, and by so doing I soon built up a large trade, as a satisfied customer is the best advertisement.

I feed wheat, cracked corn, peas, kaffir corn, millet, hempseed and other different kinds of grain, but I always keep changing so as not to feed one kind too long. I feed three times a day in long troughs, and do not use any self-feeders, but in the moulting season I do not feed so much. I always keep plenty of fresh water before them at all times, also grit, oyster shells, charcoal and rock salt.

It costs me about \$1.25 a year to feed a pair of breeding Homers.

Question: Can you tell me how it comes that one of the pairs of blue checkers has an almost white-feathered squab? **Answer:** Colored Homers do not breed true to color. Blue checkers may breed blue bars, or blue checkers, or any other color. A white youngster from colored-plumaged birds is rare, like a white calf from a black bull and black cow, and is generally called a throw-back, or reversion to one of several constituent types. The white Homers breed true to color as a rule.

WHAT ONE PAIR OF CARNEAUX PRODUCED,

by Mrs. R. M. White. The first of May, 1908, I bought a pair of Carneaux. In fourteen months I bred forty from that one pair. I send you two films showing me feeding my pigeons. In my story you will notice that I say I fed some of the squabs after taking them away from the parent birds. I did this by chewing up soda crackers and then moistening them in my own mouth with malted milk. Then I held the squab to my mouth and fed the bird in the natural way. Any squabs may be readily nourished in this manner. As they grew older, I gave them grain by hand.

In the upper picture Mrs. White is feeding two squabs in the natural way. In the lower picture she is feeding two squabs out of her hand. Her experience with one pair of Carneaux is quite a jolt to those who are afraid of inbreeding. Starting with only one pair of Carneaux, she has done more in fourteen months than another might with six pairs in the same period, having turned out a good-sized flock of two-score birds. Of course she could have accomplished nothing without inbreeding. It was all inbreeding, except the young bred by the original pair. Her flock are fine, large and rugged birds. This is the record of one pair of good Carneaux in competent hands.

DELAWARE HOTELS PAYING \$4.50 A DOZEN, by N. H. Case. I can sell my four-weeks-old squabs faster than I can raise them. There are three large hotels in my nearest town in this State (Delaware) whose proprietors all say they will give me \$4.50 a dozen, for as many as I can raise. They want them killed and bled. They offer me this price for both winter and summer. Each hotel keeper says he can handle from two to two and one-half dozens a day, so it looks as though there ought to be money in them—no expressage and payment on delivery.



MRS. WHITE AND CARNEAUX.

I am sure there is a fine opening here for squabs as San Antonio (Texas) is a city of 100,000 population and nothing of the kind here. I never have seen anything but common squabs here and very few of them. A friend, Mr. Hobbs, is working in a nearby country town, and he says they are always ringing up from San Antonio asking if they can find any squabs.—J. W. Mann, Texas.

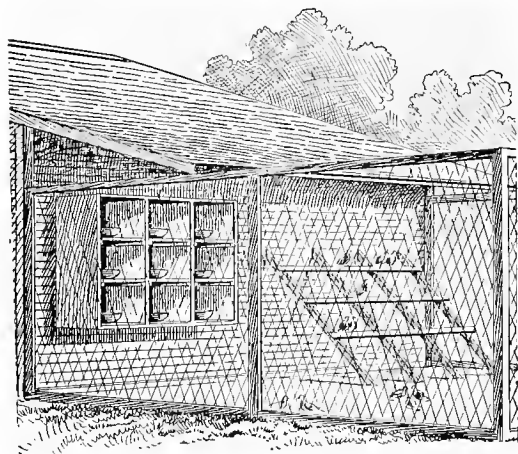

FRESH AIR FOR THESE NORTH CAROLINA PIGEONS.

CANADA COTE BUILT OF COTTON CLOTH, by F. V. Dickson. It may be of interest to your readers to hear something about a Canadian squab plant.

Last fall I tried the experiment of building a squabhouse with cotton walls, two stories in height. Ordinary cotton, at ten cents per yard, was used. This was tacked to the upright scantlings, which were set at a proper distance to suit the width of the cotton. Poultry netting was put on outside of the cotton. On the east side, from which direction come our prevailing high winds, another thickness of cotton was put on. This house was cheap to build, and is light, dry, and airy. It is cold, but I have as yet seen no harm resulting from that cause. A number of my birds have been occupying it during the past winter, and they have done as well, and raised as many squabs, as any of my other birds. At present the flock consists of about three hundred and sixty pairs of birds. For the squabs I get \$4 a dozen, the buyer paying the express charges.

Question: What, if any, is the difference between the squab-breeding Homer and what is generally called the Carrier pigeon? If the Homer is not the same as the pigeon generally used for long-distance flights, can it be trained for such flights? **Answer:** There is no difference between the squab-breeding Homer and the message-carrying pigeon. A carrier pigeon is a Homer which has been trained. There is a variety of pigeons known as English Carriers, but these are not used for message carrying. Everybody breeding squabs from Homers can fly the young which he is raising.

NORTH CAROLINA SQUABS IN OPEN AIR, by Julius A. Caldwell, M.D. We have been experimenting with twenty-five pairs of the best Homers. We put them in a wire pen 24 feet x 12 feet x 12 feet built against an old house whose roof projected out about five feet. This afforded some protection from the weather. I send you a sketch to show you the idea more in detail. Finding the work a pleasure as well as profitable, even in such an elementary manner as this, I decided to build a unit squabhouse and it is now built. I am buying some Carneau to try also.

HORSE RADISH AND SPLIT PEAS, by Edward Gerhard. A good tonic for pigeons is horse radish. Plant it close up to the flying pen so the birds can get at the leaves to eat them. They are very fond of them. I feed my pigeons split peas, which they enjoy. These peas do not cost me very much. I get them for seventy-five cents a bushel. It is the cheapest feed that I buy. With wheat at \$1.20 a bushel, it does not pay to feed very much wheat. I am raising squabs weighing from twelve ounces to sixteen ounces apiece, with the help of mysplit peas. These squabs make the finest eating any one can have placed before him.

ONE YEAR'S WORK, by Ward Edwards. One year ago this month I purchased four pairs of the best Homers. I now have one hundred and thirty-five pigeons in all. Of course they are not all old enough to raise yet, but if they continue to raise as fast, by another year I will have over a thousand. I should have bought more breeders and not had to wait this long for them to multiply. I have followed the directions in Rice's Manual very closely and had no trouble with my flock. I have kept close track of my matings and have had little or no trouble of inbreeding. I sell many squabs to private residences and although raising to multiply have made a nice little sum along with it.

Question: Is rye a good food for pigeons? **Answer:** If cheap and pure, it is useful in connection with the other grains, but most rye contains ergot, or false rye, which acts as a mild poison, harmful to both pigeons and poultry. The ergot grains are larger than the rye grains. When you buy rye, look at the grains and if they are not uniform in size and color, don't buy.

FLOCK OF GOOD HOMERS, by Leroy Wiles. The two squabs in the picture are Homer squabs. The father is a large red checker and the mother is a black Homer. These squabs weighed one pound apiece, when four weeks old. They are black checkers. Both of them turned out to be males. One is now mated and has a nest with two eggs. I banded the one that is mated with one of the bands of the usual size and it would just go around his leg, so you can see what a leg he has. The little boy holding the nestbowl is my brother. He is nine years old. I am nineteen. I think that he is going to be just like me in regard to pigeons, as he likes to go out with me and watch them eat and feed their young ones. I have some more squabs growing up and I think they will be fully as large as the two in the picture.



MY BROTHER AND MY BIG HOMER SQUABS.

I SELL SQUABS FOR FIVE CENTS AN OUNCE, by W. E. Blakslee. I have

a way for keeping young squabs in the nests made around on the ground. I nail four pieces of board a foot long into box shape and set it over the nest. This keeps the squabs quiet and the old birds have free access to them all the time. The young birds cannot get over the top of it, and the old ones can easily get into it for feeding them any time.

I find it a simple matter to work up more trade than one wants if you go at it in the right way. I adopt the plan of selling my birds by weight—five cents per ounce. When asked what my price is, and I tell them this they exclaim that they can buy all the squabs they want for forty-five cents apiece. There are many flocks of common pigeons in this surrounding country. I don't run down the birds that they are buying, nor do I stand and argue the question with them. I ask them to weigh the birds they buy and see what my price would make them cost. They find they are getting more six and seven-ounce birds than anything else and at my price they would cost only thirty and thirty-five cents instead of forty-five cents. They come back to me and want to see my squabs and are astonished at the size of them. They find I have squabs instead of jack-knives to sell. Most of my squabs are eleven and twelve ounces. I have some eight and nine

and I have a good many twelve to fourteen. I have no trouble in making customers understand that they are getting meat for their money—for they have proved the fact to their own satisfaction. When you have the right squabs, your biggest trouble is too many wanting them.

Question: Do you know of any way to dispose of pigeon wings? It seems to me that there must be some concern which buys them. **Answer:** The wings of the colored Homers are not used to any extent on women's hats, but the wings of white Homers or white pigeons of any kind are in active demand by milliners. Wholesale milliners try to buy these for ten cents apiece. They sell them to the retailers for thirty cents to fifty cents apiece, and when the milliner makes up the hat for her customer she gets from \$1 to \$2 for the white wing. I would advise you to sell your white wings for at least twenty-five cents each.

Question: One young Homer that hatched had a great deal of white in it, although the old ones were blue. Is this liable to happen any time? **Answer:** Yes. The colored Homers do not breed true to color.

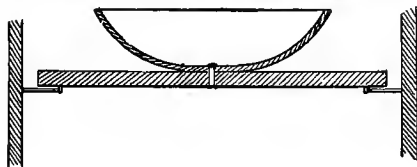
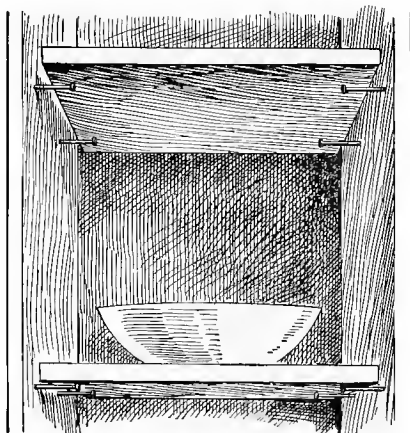

WIRE NAILS INSTEAD OF CLEATS.

Question: I would like to inquire if stale bread crumbled into small pieces about the size of corn would be good to feed to squabs. I do not mean exclusively but at times. I have a large bakery and have considerable stale bread which I thought I might be able to use to good advantage in connection with the squab business. *Answer:* Yes.

Question: Do pigeons breed as well on the seashore as inland? *Answer:* I think so. The species originated in the cliffs on the seashore, according to the ancient writers. I have seen a fine flock of squab breeders at Buzzards Bay, where they fly out over the salt marshes and get a good deal of their living from small snails, eaten shell and all.

Question: Can peat moss be used for nesting material? *Answer:* Yes, and it will drive away lice. It is good for nests for setting hens (fowls) for the same reason. An attempt was made in Indiana to use this peat moss for upholstering furniture but this did not work very well. It is used for bedding horses.

ONE DOLLAR FOR EVERY LOUSE FOUND ON MY BIRDS, by F. Beltran. As I believe in exchanging ideas, I am going to tell you about my last arrangement of nestboxes such as I draw them here. The whole thing is plain. The bottoms rest on only four nails, two on each side, that is all. My aim has always been to have not the smallest hiding place for mites, etc., and when I could not avoid having them, then to have them movable so as to be sure to reach the pests, easily, whenever I wanted. Everything inside of my house is absolutely smooth and affords no hiding place for those pests that live in the cracks here in our Mexican climate. The lice which live on the bodies of the birds would be also a thing of the past in every house of mine, if only the man in charge would keep as close a watch on the squab-raising pens as I keep on the breeding stock and raising pens, where I would give a dollar for every louse found on the bodies of the birds.

SET YOUR STANDARD HIGH. It is not merely the birds, it is the intelligence and skill behind them. In buying breeding stock, whether pigeons or poultry, of a man you are not buying simply his birds but you buy his knowledge, skill and experience. He has attained a certain standard which may be high or low, as you can judge for yourself by reading what he says, and knowing his record in the business. All Homers and all Carneaux are not by any means alike. The best ones are furnished by the men of most skill and intelligence, because they have set their standard high and do business accordingly. The man of no standing may offer to sell you birds at half the price of the man whose standing is high, and it almost invariably happens that such birds indeed are found to be worth about half price, because the offering of them at a low price is a confession of the advertiser that he has not a high standard and is not making his birds indispensable, but is satisfied to take the trade of people who want the cheapest they can buy, and such people are satisfied with poor stock.

I have seen something in the magazine about high altitudes and dry climates. Up in this part of Canada it is very dry and we have to make our pigeons breed on the ground so as to get the dampness, for the eggs will dry out if they are up on the wall in nestboxes. So we do not put more than twenty pairs of pigeons in a house twelve by twelve, and we let them build nests on the ground.—
J. H. Smith, Saskatchewan.

Question: Are pigeon wings salable? *Answer:* The wings of colored Homers are not used to any extent on women's hats, but the white wings are readily salable to wholesale milliners.

HOW TO TAKE PIGEON PICTURES. Almost everybody has a camera these days and with a small one, costing two dollars, it is possible to take excellent pigeon pictures. The film can be enlarged to any size.

Choose a day when the sun is out and take them in the flying pen when they are walking around on the ground. Do not take them while they are on the perches because then they are drawn out of shape. They strike a natural and handsome pose when they are on the ground. You should sit on a board on the ground. Hold your camera not over six inches from the ground and point it at the birds. Have a pocketful of hempseed and throw it out to the birds in front of the camera from four or eight feet from where you are sitting. Do not snap the birds while they are pushing and scrambling for the hempseed but wait until they have eaten and raised their heads expectantly as if looking for more. This is the time to press the button. Try to get a group of the birds in this manner, showing six or eight birds. The best view of a pigeon is obtained broad side, but sometimes an excellent picture is obtained from the front or even from the back, such a view showing the width of the shoulders. Photographs showing squabs four weeks old alive or dressed or novelty pictures like the one on this page are always interesting.

COMMON SQUABS TOO SMALL, by Charles F. Manahan. I watch and study the ways and habits of my Homers whenever I have time. I live near a summer resort in Maryland in the Blue Ridge Mountains and have a small truck farm and haul my vegetables to these cottages and hotels. I think I can sell the squabs from several hundred pairs after I get them introduced, as there is nothing in this neighborhood but common pigeons. Where I sell them, the people say they are the finest they have ever bought. On one occasion I did not have enough and told the person that I could get a pair of a neighbor to make out the number. After I had the head and feathers off, I saw much difference, so I put the pair I got from the neighbor on



GRANDPA, BABY AND SQUABS.

I send a photograph of myself and grandchild, Miss Janet Pfister, eighteen months old, squabs just three weeks old.—Gottlieb Pfister, New York.

the scales and the two weighed just a pound. I then put one of the Homers on and it weighed fifteen ounces, so the Homer squab weighed *only one ounce less* than the pair of common ones.

Question: I have been contemplating for two or three months trying the squab business. I wrote to a commission house in Chicago to give me prices on squabs and they quoted me \$5.50 per dozen for eight-pounds-or-over squabs. I also wrote to another commission house about the sale of squabs and they sent me a price list in which it priced squabs at \$2.50 and \$3 a dozen for choice squabs, and as low as \$1.50 a dozen. **Answer:** If you were to go into a hat store and offer a man \$1 for a hat which you happened to see and liked, and he should laugh and tell you you could not have it for \$1, that the regular price was \$3, would you be disappointed because he would not take your \$1 and give you the hat? You are not obliged to sell for \$1 a dozen just because you are offered that amount.

NEW YORK CITY SQUAB MARKET BOOMING, by William R. McLaughlin. The New York City squab market, with which I have been intimately connected for many years, buying and selling to a trade which I know thoroughly, is steadily increasing in demand, especially in January and the following eight months, when no game can be had. There is no possibility of overdoing the production, as the squab business is here to stay. There is a good demand all the year round for birds running from seven pounds to twelve pounds to the dozen, at good paying prices, and breeders should place themselves right at the start by buying birds enough to ship from five to ten dozen squabs at a time. In this way they will save considerable on express, as the charge on this quantity is a trifle more than on one, two or three dozen shipments. The very small shipments are unsatisfactory to handle as they do not contain enough birds of any particular size to keep a good average scale.

There is no line of goods I handle which has grown so much in the last few years as squabs, especially since the squabs have been sold according to grade and size, and I believe they will continually crowd to the front. I want squabs all the time.

I know there is nothing around a farm paying any better and holding to a more steady price all year round, than good squabs from seven to nine pounds.

As regards increase, I will say that in one little town in New Jersey where I started a few shippers and got them to raise according to the scale of selling by weight per dozen, when I first started, the business in that section was something like \$5000 a year and has since grown to \$25,000 a year, and you could not get them to go back to the old way for love or money. They have all made money and grown from small shippers to large ones.

I DO MY KILLING IN THE EARLY MORNING, by B. F. Babcock. I have two days in each week for the killing of my squabs—Wednesdays for the city markets, and Saturdays for my home orders. At this time of year (July) I start in killing at five a.m., and have all squabs killed, plucked and delivered by ten a.m. I have two covered baskets which I take with me to the lofts and the squabs which are to be killed are put in them. Then they are taken to where I kill and pick them.

I have a boy who does all the killing and helps pick. My wife and myself do the most of the picking. As soon as the squabs are picked they are thrown into a pail of cold water. For my home trade, I leave them in the water only until all are picked. Their feet and mouths are all cleaned of foul matter, then they are delivered to the customers. I do all delivering myself. For the city market they are left in the water from five to six hours, according to what train they are to be shipped.

I have at home a large hotel trade, having a standing order of four to six dozen a week. Prices range from twenty-five to seventy-five cents each according to size and weight, the average being about fifty cents each. In shipping squabs to the city markets I pack all squabs in ice, first putting in a layer of ice, then a layer of squabs. I have not shipped very many to the city markets as my home trade takes nearly all that I can raise, but have always when shipping received the highest market prices.

The inexperienced will at first find in using the squab killing knife, that they do not stick the squabs right and that some will live for quite a long time, and have to be stuck the second time. This has been my experience so I tried this plan so as not to let the squabs suffer any.

I made a killing machine, the same as described in the **National Standard Squab Book**, pages 114-115, which breaks their necks and kills them at once. I then use the squab knife and bleed them. As soon as the squabs are plucked they are at once placed either in a pail or tub of cold water, into which some salt has been put. If you use a twelve-quart pail put in three to four pinches of salt, that is, what you can hold with your thumb and fingers. If a tub is used put in according to size. This will give the squabs the fine white skin desired by the New York market, taking out all the dark or red spots. It also gives them plumpness.

I leave them in water from four to five hours, which takes out all the animal heat. I then clean the feet of all foul matter and wash all the blood from their beaks and mouths and wrap their heads in white tissue paper. The paper costs very little and the trouble will more than repay any one. It gives a fine, clean appearance when your dealer opens the box and your squabs will bring the top prices.

I pack all shipments in ice, putting in a layer of ice first, then a layer of squabs, keeping this rotation up until the box is filled, but being very careful not to get the box too full. No breeder will ever be sorry for any extra pains he takes with his shipments, as it will pay in the long run.

SOFTENS PEAS IN WATER, by Elmer Streckwald. I know a woman breeding squabs who softens peas by moistening them in water. Her idea is that they will not be so hard to digest, especially for the young pigeons. I have not tried this myself. Of course they should be softened fresh at each feeding time, or allowed to soak three or four hours before feeding time, for if they were allowed to stay damp over night they would ferment. This woman also feeds her squabs on bread crumbs and she has told me that she finds the use of a moist mixture an improvement over the dry feeding. This spring I sold my squabs to middlemen in Boston for \$4 and \$4.25 a dozen. My plant is paying a profit.

\$9 TO \$12 A DAY FROM SQUABS AND EGGS, by J. E. Ross. In May, 1910 I purchased thirteen pairs of Extra Plymouth Rock Homers from the Plymouth Rock Squab Company, and as it is more than a year now since I received them, I thought you would like to know what they have been doing and what I have been doing.

The birds arrived on a Saturday afternoon, and by Friday of the following week twelve pairs were sitting on eggs, and they are still at it. From the original thirteen pairs I have raised one hundred pairs of the finest birds that you would want to look at. I have not lost any old birds, nor have I had any sickness in the flock, nor been troubled with lice.

Out of the thirteen pairs, nine pairs have raised nine pairs of squabs from May, 1910 to May, 1911, one pair eight pairs of squabs, and three pairs eleven pairs of squabs in the same time. My squabs weigh from twelve ounces to seventeen ounces at four weeks old, the majority of them weighing from fourteen to fourteen and one-half ounces each. I sell my squabs by the ounce, five cents an ounce, to private trade.

I feed a mixture of Canada peas, red wheat, buckwheat, kaffir corn, whole round corn, lentils, millet and hempseed. I use the self feeder described in Rice's *Manual*. It costs me six cents a month per bird to keep my flock.

I have many visitors who come to see my Homers. They all say that they are the finest they ever saw.

I will tell you how I came to start in the squab business. About three years ago I met with an accident on the railroad where I was employed, and it left me in such a condition that I was unable to do any work without sitting down to rest very often. I found it very hard to get work where I could do that, and as my small bank account was getting smaller, I had to do something very soon. A friend of mine told me of the squab business. I read Rice's *Manual* until I had it off by heart, then I sent for the birds. I have never regretted the day that I spent the thirty dollars for the Plymouth Rock Homers. I have sold several pairs of breeders for four dollars a pair, and have refused a number of sales at that price, for they are worth that much to me.

As I went around in my Long Island town selling my squabs, the people would ask me for fresh eggs, so I decided to buy eggs and sell them with my squabs. When I first started with squabs I was not making a cent. I am picking up from nine dollars to twelve dollars a day now with my squabs and eggs. At present I have more orders for squabs than I can supply, and my place will not accommodate another pen of birds. I am looking for a larger place now, and if I can get it I am going to put in two more pens of Plymouth Rock Extra Homers, and I am going to get them from the Plymouth Rock Squab Co., so you can expect to hear from me again.

LOOK OUT FOR SUBSTITUTION. Many newspapers from Maine to California have poultry and pigeon columns of advertisers selling breeding stock. We have noticed, and no doubt our customers have, the freedom, not to say license, with which "Plymouth Rock" Homers and Carneaux are offered in such columns. In nearly every city there are some irresponsible hand-to-mouth dealers selling all breeds of pigeons, and every Homer and Carneaux they can get hold of is promptly labelled or advertised as "Plymouth Rock" and sold on the strength of the reputation our birds have made. This substitution sometimes can be worked on a buyer who may be afraid to send money by letter. We have stopped a good deal of it with the help of customers who have called our attention to cases in their States. The use of our trade mark, unless specifically authorized by license from us, is illegal and we will be indebted to friends who will point out to us cases of violation as they see them. Imitation is the sincerest flattery, it is true, and the fact that our pigeons are the standard for comparison or for making sales, in the different markets and advertising mediums, is gratifying, but competition of that kind is unfair. We give only to customers the right to sell their killed squabs as Plymouth Rock squabs, no matter where they live, and we want no better testimony than is printed from month to month to prove that this trade mark is worth money on the price of the squabs. It is the right kind of an introduction to the big squab buyers. Every week letters come from somebody who has bought of our "agent" and has some disappointment to record. We have no agents anywhere. All trading with us is done direct with our Melrose farm, or Boston office, or it is not Plymouth Rock business.

WHAT TO DO WITH STRAY EGG, by W. E. Blakslee. Young birds are liable to lay their first eggs anywhere, in a nest, on the floor, and sometimes even you will find their eggs out in the flying pen. They lay their eggs, but many times a pair pays no more attention to them. Many seem to think such eggs are not fertile, but I find the chance is that they are. Save them and put one in each new nest of your other birds the day their second egg is laid. This is your chance for a few extra squabs. What if you do have three in a nest? When you match up your squabs you may need these extra ones that you may get this way. Every squab saved counts to the good.

BIG HOMER INCREASE, by N. A. Huston. My stock of six pairs of Plymouth Rock Extra Homers was bought in 1907, March 22. I have about three hundred birds today, January 31, 1910. My intention now is to raise as many squabs as I can for market. I made an outlay of about \$250 on my squabhouse last spring, raising on three-foot posts, new floors, etc. Expect to enlarge in another year if nothing happens.



SQUABS FOUR WEEKS OLD BRED FROM PLYMOUTH ROCK CARNEAUX.

WE SELL NO SQUABS FOR LESS THAN \$6 A DOZEN, by Elmer E. Wygant. A few months ago I wrote you to the effect that I was having some photographs taken of our buildings, to show you what we have been able to do with the twenty-five pairs of Extra Plymouth Rock Homers which we bought of the Plymouth Rock Squab Co., Boston, in April, 1909.

When the birds arrived, we placed them in a box stall, built a small pen on the outside, and did not pay any attention to them except to water and feed for over three months, when we found we had to prepare other pens for the young, which were coming very fast. In fact, every pair shipped us were all raising squabs at this time. They came so fast that we have been compelled to put up a building which is 128 feet long, eighteen feet wide and twelve feet high. At this writing (June 3) it is filled with three hundred mated pairs all breeding, besides ten pens in the large barn with four hundred mated pairs.

I can see where I made a mistake when starting and that was that I should have bought about five hundred pairs and saved the time we have taken to breed. For since last August, when we began to sell squabs, we have been compelled to refuse orders owing to our wish to breed to one thousand pairs.

We have made a point not to sell any squabs less than \$6 a dozen dressed, and guarantee every squab to weigh three-quarters of a pound, dressed, or no sale. We are careful not to kill any birds if under the above weight. We have supplied banquets and hotels at the above price and in doing so we show a common pigeon by the side of a Homer, which settles all arguments at once.

We feed entirely according to the directions in Elmer Rice's book and have had no trouble in keeping all the birds in fine condition. The main point, in our estimation, is to have clean coops, fresh water at all times, and see that every bird is given enough to eat. If these instructions are lived up to at all times, there is no reason why anybody should not make a success of raising squabs.

(By Ray E. Brown, Manager.)

Owing to the fact that Mr. Wygant, the proprietor of Etwinoma Farms, is also the owner and manager of a large summer resort, this time of the season finds him rushed, so he has handed me your request for further details regarding the way we are getting along with the squab business.

We started small and enlarge as we grow. We are at the same time growing a large poultry business.

Make up your mind what variety of pigeons you want, how many you want, and remember the best is what you want. There are a great many varieties suitable for squab raising. We prefer the Extra Plymouth Rock Homers, which we find come up to all the requirements called for by the squab demand.

Regardless of the variety you start with, it is quality you want, not quantity. Buy your foundation stock from a reliable breeder.

Tell him what you want and pay his price. Don't think the price too high considering quality, as he knows the value of the birds he is quoting you prices on much better than you, and bantering over prices with a reliable breeder is only waste of time. Also remember that saving money buying cheap stock birds is not saving, only wasting.

This being a large farm covering 300 acres, we find valuable use for all the pigeon droppings in the orchard. We raise some of our grain, which is but a small advantage over those who have to buy their entire amount. Our main advantage is that our entire lofts and farms are connected with running water.

The successful squab raiser should study the **National Standard Squab Book**, subscribe for the **Squab Magazine** and take advantage of some of the many good hints published in each and every copy from men who know from experience.

A correspondent in Maryland writes to us March 20, 1911: "I have seen some of your Plymouth Rock Homers in this neighborhood and they are fine birds, so fine indeed that I am anxious to get rid of my Carneaux to get them instead." That is quite a recommendation, is it not? We might add, that the Carneaux which we sell at a higher price than our Homers are bigger and better than our Homers. Many people buy only by labels and prices; in other words if pigeons called Carneaux were offered them at one dollar a pair, they would buy them, without any thought further. There is not much satisfaction in that kind of trade either for seller or buyer.

BOTH HATCH ON SAME DAY, by Leroy Wiles. I think it is a good idea for a breeder to save all his eggs that do not hatch and when a pigeon lays her first egg, take it out of the nest and put in one of the infertile ones, then when she lays her second egg, take out the infertile one and put back her own that was taken out the first day she laid. (The infertile egg can be told by putting a mark on it.) This will keep one squab from hatching a day before the other. Then very few squabs will get stunted.

Considering the question of "How best to reach the retail trade," would say, although I have not tried it out, I believe a good way (and one of small cost) would be to send post-cards, either neatly printed or written, to each doctor in the city, stating that if any of his patients are in need of squabs, the writer is in a position to supply them.—H. A. Knolly, New Jersey.

Charles S. Eby, a Michigan customer, is raising squabs from Plymouth Rock Extra Homers weighing from one pound to nineteen ounces apiece. The smallest squab he ever weighed registered fifteen ounces. He has the right Homers and he knows how to feed to fatten.



NOW, BUSTER, DON'T MOVE.

CARNEAUX PRICES. It is a peculiar thing about the pigeon trade that whereas there are a certain number of purchasers at, say, six dollars a pair, the number will treble and quadruple at three dollars a pair, with no further inducement than the price. This is an absurdity and in the old days did more to drag the pigeon business down than anything else, for few selling pigeons at cheap prices could afford to replace dead birds, odd

sex, etc. Cheap pigeons are never cheap, but in most cases are a total loss and a source of the utmost vexation from start to finish. In a pigeon transaction, the price is a very small matter. What you wish to know is: Will I get them promptly, or wait from three to six months while the birds are being bred for me? In case there are some dead ones in the coop on arrival, will the seller promptly make good, or will he refuse, putting the blame onto the express company, which never pays such claims unless the deaths have been caused by a wreck? In case I am not satisfied with some or all of the pigeons, have I any redress? Who pays the express, myself or the shipper? In case I find some youngsters, or more of one sex than the other, can I force the seller to make good? So, you see, suppose you can buy Carneaux at \$3 a pair, and do not buy character, reputation and good service with it, you get less than half of what you would have secured had you paid \$6 a pair and received satisfaction. The friendship and good will between buyer and seller is a very important matter in a pigeon sale. If one finds he can buy regular ten-cent soap for six cents, why one would of course pay six cents. Soap is not alive and does not breed. It can be transported without risk. It is not likely that you would ask for a refund of the money. But there is some risk in buying pigeons and it is to your advantage to trade with a firm which will take the risk, and not compel you.

I can talk Homers all day. I owe a great deal of my success to the **National Squab Magazine**. I started three years ago with thirty-six Plymouth Rock Extra Homers. I have now nineteen units on Mr. Rice's plan, and have between 1200 and 1500 birds. In June I shipped 434 squabs to a northern market, first week in July 115. We have no local market in summer, this being a winter resort. My best prices are obtained in the winter. I sold in two and a half months eight hundred squabs at six dollars per dozen.—W. C. Hyer, South Carolina.

Your Manual, the **National Standard Squab Book**, is the best and most thorough publication on pigeons and squabs ever published. I am more than pleased with it. I shall send on an order early this spring, possibly earlier, and if your birds are like your book, there shall certainly be another order.—W. C. Valentine, Illinois.

HOW I NET \$4000 A YEAR WITH SQUABS,

by Oscar Maerzke. I have been in the squab business thirteen years. I have a mixed flock containing both common pigeons and Homers. The squabs from the Homers are larger and bring more money, and the Homers breed better than the commons. I make \$4000 a year profit. I always have run the business alone, up to last year, when I took a partner, Charles Lutovsky. In the county where we live (Wisconsin) many of the farmers breed common pigeons. We have an automobile with a rack on back to hold pigeon crates. My partner goes out daily in this automobile, to gather up the squabs from the farmers, covering regular routes. He brings them home alive and I kill and pluck them and ship them along with the squabs we raise. We have shipped squabs as far East as New York. Just now we are shipping to Chicago, about 150 miles distant. We use any kind of a second-hand box, provided it is clean and fairly tight, for shipping, putting a layer of ice on top of the squabs and nailing the box up tight. The empties are not returned to us.

My home is half a mile down the street from the squab plant. I have built one residence from squab profits and am now building another alongside my present home.

It costs us \$3500 a year to feed our birds, or a little less than \$1 a year a pair. An important part of the daily ration is a wild seed mixture, bought cheaply. We get it from a brewery. It is what is left after cleaning barley for malt. The brewery, having no further use for this refuse, sells it cheap. It is perfectly clean, dry, sweet and good, however. The pigeons are very fond of it and it does them good. Of course, when they are eating it they are not eating the more expensive wheat and corn. The mixture contains the small black kernels of wild buckwheat, also cockpit seed, flaxseed, the seed of pigeon grass, and some barley. We store it in bins and it does not have much of a tendency to heat or spoil.

The squabs from our common pigeons and the common squabs bought from the farmers weigh about seven pounds to the dozen. They are smaller, do not look so good and do not bring so much in the market as the Homer squabs. The squabs from our Homers weigh eight or nine pounds to the dozen and we have some ten-pound Homer squabs. When I started in the business a squab was a squab, no matter what size, and brought a flat price, but now, on account of the enor-



MAERZKE'S \$4000-A-YEAR PROFIT SQUAB PLANT.

mous number of superior, large-size Homers which Elmer Rice has imported from Belgium and sold in this country, the small-size native American Homers and the common pigeons have been overshadowed in the markets. Squabs are now graded by weight when sold, and the more they weigh to the dozen, the more they bring. I have always sold to commission men and dealers in the large cities.

We have no heat in our houses. In the winter the temperature goes as low as twenty degrees below zero. The squab production falls off some in winter and we lose a few squabs and eggs by freezing, but this is trifling compared to the cost of installing and running a heating apparatus, which is out of the question with our houses built and located as they are. We have so many pigeons in each of our three flocks (and a fourth flock of one thousand pairs to be soon added) that the houses are kept quite comfortable by the heat given off by the birds.

Mrs. W. R. Lyan, a customer in far off Oregon, writes us March 31, 1911: "I bought three pairs of Plymouth Rock Homers just one year ago and have raised over seventy, lost very few. One pair has raised nine pairs and is setting again. This notwithstanding the fact that we have moved during this time and had them in a coop for several days, and have never had a flying pen; just have them in an open-front chicken house. How's that?"

HOW A MAN OF 75 MAKES \$25 WEEKLY, by John D. Ludwig. I am making \$100 a month net profit squab breeding with 1400 mated pigeons, mostly Homers. I am seventy-five years old. In front of my house I have a sign: "One squab contains two to five ounces of liquor protoplasm. This is the liquor of life, without which nothing can live. Thirty good squabs have more protoplasm than a beef weighing eight hundred pounds." I live on the Southern Pacific railroad line, and thousands of people read the sign.

At the present time (March) I receive \$3.75 a dozen for Homer squabs, and \$4.50 a dozen for my larger squabs, net. Last year I sold 8199 squabs. My customers call at the aviary for my squabs. I put from twenty-four to forty squabs in a box alive and the expressman calls for the boxes. My market is Oakland and San Francisco. I cannot raise the number of squabs that are called for. My squabs are always plump and fat, and weigh from twelve to eighteen ounces each.

The boxes I ship the squabs in are the size of Swift turkey boxes and have a partition in the center. I place eighteen or twenty squabs in each compartment. The boxes are returned to me and the poultrymen pay the express both ways, on the squabs and empties. They are paying as high as \$5 a dozen in San Francisco, one year contract.

It is hard work to take care of 1400 pigeons, they ask me. I have two boys, George, the older, thirteen years old; Edwin, the younger, nine years. In vacation they did all the work around the aviary. Gathered all the squabs for market. Removed the dirty nests. Cleaned them. Dipped them into the whitewash barrel. Set them aside ready for future use. Placed clean boxes for the dirty ones taken out. Raked out the houses and lofts. Shoveled the manure in the wagon and delivered it to the florist. Mixed the feed and placed it in the hoppers. Gathered and handled eucalyptus leaves to refill nestboxes. They ran the place in fine order. (The boys did that during their vacation from school. I was on a trip to Sonoma county.) At present they go to school. After school hours they are on hand and we do the work. Both love pigeons and are pleased to be with them.

Boys certainly can make money raising squabs for market. They must learn all about pigeons. Must attend to business or they will lose the cash they invest. Start with only a few pairs.

Does it pay to raise squabs? Yes, it does. I am making money. But like any other business you must learn the details. Learn the habits of pigeons and how to take care of them.

I write you these few lines to let you know that we are still in the business, and I will tell you of our success after a year and a half. We wish to enlarge. We have now working about 135 pairs of the old original birds, of which seventy-five pairs were secured from your company, and the balance elsewhere, but like most new beginners we of course got a

few of those so-called Homers, and that meant we were stung, but the seventy-five pairs that we got from you are certainly fine workers and are going great for us. Out of the last year we have saved something like one hundred pairs of young birds out of those we bought from you so now we have about 240 pairs turning out squabs for us, and we are shipping on an average of four dozen squabs a week and also are supplying some few small breeders around here. Besides the Homers we have thirty-eight pairs of Carneaux working but have not put any of their young on the market yet. We are proud of our success, which we lay to the birds bought from you. We want to add another sixty-foot building to our present holdings and to secure about three hundred pairs Plymouth Rock Homers from you. You have the only pigeons that we care to handle. We ship our squabs to Heineman Brothers in New York.—**E. J. Quigley, West Virginia.**

ONE YEAR'S RECORD, by Emil Oetteking. I kept a record of the feed consumed by eight pairs of Homers in the year from January 1, to December 31, 1910, with the following result: Whole corn, 177 lbs. at \$1.55 per 100 lbs.—\$2.63 Red wheat, 168 lbs. at 2.40 per 100 lbs.— 4.03 Kaffir corn, 122 lbs. at 2.30 per 100 lbs.— 2.81 Buckwheat, 51 lbs. at 2.25 per 100 lbs.— 1.15 Peas, 158 lbs. at 3.80 per 100 lbs.— 6.00 Hemp seed, 9 lbs. at 6.00 per 100 lbs.— 0.54

Total,	678 lbs.	\$17.16
--------	----------	---------

I killed 129 squabs in twelve months from the eight pairs of pigeons. This is at the rate of sixteen and one half squabs per pair, or eight and one-quarter pairs of squabs to each pair of parent breeders.

I suppose you are always ready to read of a customer of yours that has made a success with pigeons, so I am writing to give you that information. I started my flock two years ago with three pairs of your Plymouth Rock Carneaux and now (March 26, 1911), am the proud owner of nearly two hundred pairs of as fine birds as there are in the country. I have sold squabs, youngsters and mated pairs, and at no time have I had any trouble in disposing of them. The breeders are always of good color, good size, and as for breeding qualities, they are hummers. I want to thank you again for starting me right. Still have my original pairs (three), which are as busy as ever.—**Cadet H. Hand, New York.**

Two weeks ago I killed and shipped my first squabs. I never killed and plucked a squab or fowl of any kind so you can imagine the task I had on hand. I had eleven squabs. For the best I received seventy-four cents a pair clear, or eighty-three cents gross; for the smallest forty-four cents a pair clear or fifty-five cents gross, an average of \$4.20 a dozen gross, or \$3.70 after packing and shipping expenses were deducted. How is that for a "greenie" in the business—good, bad or indifferent?—**Park F. Esbenshade, Pennsylvania.**

HOW AN IOWA FAMILY MAKES SQUABS PAY, by R. L. Allen. I am very much interested in the pigeon business. I believe it is only in its infancy and that better times are coming. I send you a picture of our unit house which, as you see, has eight separate apartments. We have three other houses not shown in this picture. These apartments are each eight by ten feet. They are eight feet high on the high side and six feet high on the low side. The fly yards are ten by sixteen feet, eight feet high.

Each of these apartments has an average of one hundred and twenty-two nests, and an average of one hundred and twelve mated, working pigeons. We find it better to have more nests than birds.

The girl in the picture is Lila Allen, sixteen years old, another member of the firm, who has charge of the feed supplies. Once every day she goes all through the plant and refills the automatic feeders that are in need of grain. In these feeders there are compartments to accommodate two kinds of grain. We also have a little contrivance of our own invention to keep salt and grit always before them. We are not prepared at this time to furnish the pictures of Mrs. Allen, who is bookkeeper and secretary, or of Mr. R. L. Allen, general manager. In this pigeon plant, each member of the family and firm has his or her work to do, and each receives a share in the receipts. We have one thousand breeding pigeons.

I find in traveling about over the country that where there is a bunch of pigeons that the owner is "sick of" and complaining because there is no money in them, the house is in bad condition, feed and water supply is poor, and the pigeons are not evenly proportioned in regard to sex. Under such conditions good results are out of the question. The owner is trying to sell them cheap, and if he gets a buyer, unless the latter is a good judge and understands how to cull them closely, he too finds out a little later that there is no money in the pigeon business. Then the poor pigeons get the blame for it all.

HOW THEY BREED IN ONTARIO, by W. Ernest Williams. In March last I purchased three pairs of Plymouth Rock Extra Homers and to date (October 27) I have twelve pairs of youngsters that have been spared for breeders. In March all three pairs had eggs within two weeks of being in their new home. In my pen I have up to the present twelve pairs of youngsters that are flying about, and

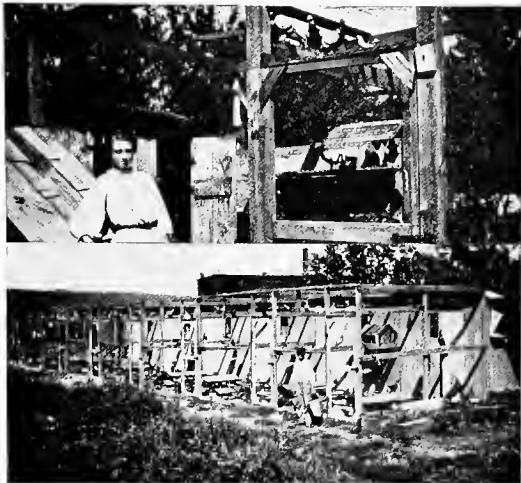

VIEWS ON THE ALLEN SQUAB FARM.

have killed two pairs for eating. One pair fell out of its nest or was pushed out and killed when only two weeks old. Now I have one pair about four days old and two pairs on eggs. Mr. Baker and Mr. Burgess will no doubt want to buy my birds after seeing this, but not for \$3 a pair if I know it. Just look: sixteen pairs and two pairs of eggs. This is a straight fact and no fairy tale, I can assure you.

I have been getting three dollars per dozen for my squabs. At one of the Chicago markets I asked the man what he would pay me for what he called fancy Homer squabs. He said they were too high for his market, and that the hotels and big restaurants paid six and seven dollars a dozen for them dressed, done up in one-half dozen lots, and they had to weigh just so much. I also spoke to a party that used to be in a meat market where squabs were handled, and he told me they paid around forty cents apiece for squabs and sold them as high as seventy-five cents apiece.—Henry Huecker, Illinois.

I ordered three pairs of Extra Plymouth Rock Homers six months ago. I had other Homers in my house but in the scramble for nestboxes, the new ones were easy winners, they were so much bigger and stronger. I am raising some big squabs from them. The largest I had were a pair of red checks, one weighing twenty ounces and the other twenty-two ounces.—Walter Sieverling, Ohio.

SQUAB MONEY KEPT THIS BOY IN SCHOOL, by Elmer Krider. I am a boy of seventeen and live with my grandparents in California. Both my mother and father are dead, so you see I had to find some way of making money without having to quit school. While reading a paper one day I saw the Plymouth Rock advertisement and sent for a free book, then bought the complete pigeon guide, which I found was the same as having an expert squab raiser with you all the time. By studying this **Manual** I got a clear view of the squab industry, purchased twelve pairs of Homers in September, 1907, and up to this writing (September 27, 1909) have three hundred and sixty, including one hundred mated pairs. I ship the squabs at the rate of about seven dozen every month to San Francisco, where I get never less than thirty-five cents each.

Boys who were my best friends wanted me to go out in the fields and work with them for \$25 a month. I told them I would not quit school to go out in the hot sun and work for \$25 a month. Then here is where they began to tease me about the pigeons and that I would not make a cent out of them. So, what happened is, that I have kept on with my school, making a clear profit of \$20 a month with little work.

This just shows what a great chance the pigeon industry offers. There is one man here who came from Minnesota to raise squabs and on arrival took the ginseng fever and began raising it. Now he is beginning to see his mistake in not sticking to squabs.

SQUABS SELLING IN BOSTON \$7 A DOZEN, by Elmer C. Rice. Just one year ago this month I wrote an article telling how squabs were selling in Boston at seven dollars a dozen, the highest known up to that time. This year (1911) squabs are just as high, and appear to be scarcer.

In the *Boston Globe* for January 27, 1911, squabs were quoted at \$5.00 to \$7.00 a dozen. In the *Globe* for January 20, \$5.50 and \$6.00 a dozen. For January 13, \$5.00 and \$6.00 a dozen. For January 6, \$5.00 and \$6.50 a dozen. For December 30, \$5.00 and \$6.00.

The *Globe* prints the squab quotations in a special market article every Friday afternoon throughout the year, along with quotations on meats, butter, cheese, eggs, fruits, vegetables, fish.

When squabs weighing eight pounds to the dozen sell for \$6.00 a dozen, this means that the buyer pays seventy-five cents a pound; ten pounds to the dozen at \$7 a dozen, seventy cents a pound; twelve pounds to the dozen at \$7.00 a dozen, sixty-seven cents a pound. This is double the prices at which chickens sell, pound for pound, and indicates how profitable it is to breed squabs.

MY SQUAB PLANT PAYING 22 1-2 PER CENT PROFIT, by H. C. Longcoy. For any one entering any business, the first question coming to mind is: How have others

succeeded? So a few figures of actual facts are here submitted. I have been raising squabs in Ohio for five years and have made big money for the time spent on them. I get all my grain, grit, etc., at wholesale. I sell through a retail store. They give me \$3.50 a dozen, flat rate, the year round. I have fifteen pens of breeders at present, but, for example, we will take one pen of twenty-one pairs of large crosses with actual figures. These birds have done no better than the others:

Grain for 365 days	\$30.57
Cost of house (pro rated) \$1.57 per pair or	32.97
Value of birds, 21 pairs at \$4	84.00
Interest on \$84 plus \$32.97 (investment)	7.01
Depreciation on investment 10%	11.69
Actual outlay \$30.57 plus \$7.01 plus \$11.69,	
total \$49.27.	
Twenty-one pairs produced 246 squabs	
during the year at \$3.50 per dozen	\$71.75
Droppings sold	3.90

Income	\$75.65
\$75.65 minus \$49.27 equals	\$26.38 profit, or
\$1.25 1-2 per pair.	

Very few business propositions pay 22 1-2% net; so I say a squab plant well taken care of is the best money maker I know today.

POISONED PEAS, by C. W. Blanding. I found it extremely hard to procure Canada peas, and to take their place I bought some peas of a dealer which he recommended as pigeon peas. In less than two weeks my birds were all dead with the exception of a few pairs. A careful examination proved that the peas had been doped to prevent the worms from bothering them, as they are very poor sellers. You can bet now that I know what my feed is when I buy it.

Question: No two accounts agree as to the average yearly increase from working pairs of pigeons, and I am at sea as to what I might reasonably expect from say fifty pairs in one year under favorable circumstances. **Answer:** Accounts differ with regard to the average yearly increase of a flock of birds, because the ability of each breeder varies. It depends mostly on yourself what you will do with a flock of pigeons. If you are skilful you will get the maximum results. If you are not skilful you will get the minimum results. If you have average ability you will get average results. It is impossible for anybody to predict what you will do at squab raising.

A buyer appreciates that prices mean very little when he puts \$20 into a lot of pigeons, obtains twice the number obtainable for the same money elsewhere, but finds on getting the birds from the express company that perhaps one-third of them are desirable, and he can get no relief, frequently not even an answer to letters. It is our belief that the customer is the best judge of what is shipped him, that the pigeons themselves talk more convincingly than printed matter or letters.

RAISING SQUABS BY HAND, by E. Guenther, M.D.

My squabhouse recently finished is fourteen by twenty feet and cost \$150. I put tin pans on top of the posts under the sills to keep rats and mice from working up. On October 2, I took out thirteen squabs (Homers) which weighed fourteen pounds. During the summer I lost a pair of Homers which had hatched out a pair of young Carneaux. The young birds were thirteen days old when the old ones flew away. They were yellow Carneaux and I was very anxious to raise them, so I got my boy Harold to look after them. One of the pictures shows Harold feeding one of them by mouth, which was the way they were first nourished. When they were older they were fed with a spoon. They are now in the rearing coop and doing well. The other picture shows Harold and my girl Blanche feeding a young Carneaux with a spoon.



RAISING SQUABS BY HAND.

boards on a side if needed. This leaves more flying space in the pen than the ladder system.

SIX DOLLARS A DOZEN, by George N. Cbilds. I am having good luck with my Homers. I have quite a few calls for squabs. I can get six dollars a dozen for them. I follow Rice's *Manual* to the letter and find it to be just the right thing. I would not take \$25 for it if I could not get another copy. I sell my squabs to private families. They made the price themselves and are willing to pay six dollars a dozen. This Pennsylvania town is very rich and I can sell all the squabs I can turn out. I cannot say enough or too much for the squab business or my birds. There was a man here this morning from a New York town and he said he had been to see a squab plant there which had seven hundred birds, but had not any to come up to mine. I am going to have a picture taken of my place and will send you one.

FLYING PEN ON EAST SIDE OF BUILDING, by M. C. Martin. For warm climates, I think the flying pen should face the east instead of the south. In the summer when it is so intensely hot, if the pen faces the south, the sun shines on the flying pen all day long, and except in the early morning and late in the evening the birds must stay in the squabhouse to escape the sun. If the pen faces the east, shortly after noon there is shade in the flying pen, and all the birds off of eggs will be found enjoying the shade, and very few suffer during the hot season. In the winter the flying pen should have a windbreak on the north side, then remove this in the spring again.

My plan for perches in the flying pen is to have six-inch boards all around the sides of the pen. One may have two or three tiers of

Question: I have a good-sized flock of Homers which have been working fine, but recently I bought two pairs of Carneaux. One pair worked all right, but the other pair although they are mated do not work properly, so I have come to the conclusion that the Carneaux are not so good as the Homers and I think I will stick to the Homers. **Answer:** It has been my experience that a party will buy, say ten pairs of Homers and be well satisfied if eight or nine pairs go to work soon. On account of the expense of Carneaux, they may buy only two pairs. They expect both pairs to be perfect breeders under the change of circumstances, although they do not expect an absolutely perfect percentage with their Homers. It is a well-known law stated by all competent observers, that some pigeons will breed properly only when at their old home or with their old partners. It is also true that birds which breed properly in one pen may not do so if sold and shipped away to a new pen. Therefore, in every flock there may be some pigeons coming under these exceptions. Such birds should be mated up with new birds, or later on with birds of your own raising. It is impossible to do much breeding with Carneaux, or with any pigeons, unless you have from three pairs to twelve pairs, so as to have some material with which to work. Anybody who buys one pair of birds and figures on perfect results is taking a chance.

From the Extra Plymouth Rock Homers that I bought and received May first this year, I have one hundred pairs, some of which are beginning to mate; will have a big bunch mated up by spring.—A. E. Perkins, Iowa.

TELEPHONE SQUAB SALES \$6-\$9 A DOZEN, by R. E. Sons. Having read all the books relating to pigeons and carefully thought over the matter, I decided to try as an experiment forty-eight pairs of Plymouth Rock Homers and to see for myself if I had any demand for squabs. When they arrived I was well pleased with their looks and was better pleased when I saw them getting busy ten days after their arrival. Then when my first squabs hatched I commenced to look for ways and means to sell.

The markets were selling them at forty cents each so I decided to try fifty cents each. I inserted a small advertisement in the local paper but could trace no business there. I then wrote several prominent people and received two answers, each with orders too large for me to fill. I then started in to call the wealthy ladies by telephone, asking them if they would like some fresh killed squabs, as I had so many for sale, and by this means I sold my first birds. This I continued, always calling new people, and when I delivered my squabs I always placed my card on the package and requested the cook to keep the card in a conspicuous place, and when she wanted fresh killed squabs to call me by telephone.

Soon orders were coming in far beyond my supply. I then ordered fifty pairs more Homer breeders from the Plymouth Rock Squab Company. As soon as they were working and I was able to market their squabs I found I could not meet the demand. I ordered again fifty pairs more, but even then I could only meet about half the orders.

My plant has always been open to inspection and I tamed my first pen so that they would come and eat hempseed out of the hand. This was a great success for many wealthy people stopped to see how squabs were raised and I found I sold quite a lot simply because they would eat out of the hand. These I sold for pet squabs. I weaned them when they were four weeks old and received from nine to twelve dollars a dozen. I refused all offers for the old birds.

Some of the wealthy people thought that fifty cents was too high as the markets had by this time cut their prices to thirty and thirty-five cents each, but I explained how I plucked and chilled the birds, which were only killed upon order, and that if they would try a small order, they would be convinced. Some would place an order for one and two and in nine cases out of ten they would try to get my squabs, and if I was sold out then go to the market.

All this summer I have received fifty cents each for killed squabs four weeks old, seventy five cents for live squabs five weeks old and one dollar for six weeks old, weaned and trained to eat and care for themselves. I have not at any time had any squabs ready to kill that I have not had an order on my books to fill. In fact, I have not had a chance to eat one myself. I have four more units about half completed which I will fill with Homers as

I believe they turn out squabs that are just right for the home market.

For canker, I put three drops of squab-fe-nol in one-half a glass of water for a wash, using a small swab. I then powder the throat with half Venetian red and half burnt alum, and find that this mixture works quickly, effecting the desired cure.

Here is a record to date (March, 1910) of the three pairs of Extra Homers bought of you last March, 1909. It is a record you can be proud of. I will swear that it is correct, as I have them banded and keep a book to record them. Pair No. 1 hatched April 1 (1909) 2 squabs; May 12, 2; June 18, 2; July 21, 2; August 24, 1; September, none; October 4, 2; November 14, 2; January 8 (1910), 1; February 20, 2. Total, 16 squabs in 10 months. At present date (March 20) building another nest. Pair No. 2 hatched April 5 (1909), 1 squab; May 18, 2; June 24, 1; July 28, 2; August, none; September 1, 1; October 5, 2; November, none; December 1, 2; January 26 (1910), 1; March 8, 2. Total 14 squabs in 10 months. At present (March 20), sitting on two eggs. Pair No. 3 hatched April 15 (1909), 2 squabs; May 27, 2; June, none; July 15, 2; August 28, 2; September, none; October 11, 2; November, none; December 11, 2; January (1910), none; February 6, 2. Total, 14 squabs in 10 months. From these three pairs I have now twelve working pairs of birds that I have yet to see the equal of in California. I hope this record may be of some use to you, and it will be if you are as proud of it as I am. I never had raised a pigeon in my life until I received your birds. You gave me a fair and square deal both on my Extra Homers and Carneaux. I follow your *Manual* from A to Z. The results speak for themselves.—**Fred M. Parkison, California.**

I have adopted a way for holding my nest material which you can print if you wish. On the wire partitions between units, at the bottoms I put a thirty-inch width of the wire, fasten this at bottom and ends, fill from the top with stems, straw, etc. This makes a clean pocket for keeping the nest material in the pens, and it also makes a good break from wind caused by the flying of the birds. Don't cut wire to make this. Use a regular made width, then you have the edges in shape.—**W. E. Blakslee, New York.**

I am very proud of my flock of Plymouth Rock Homers. From the twenty-four pairs I bought a year ago, I now have two hundred and eighty-eight birds, all beauties. My neighbors and every one who sees them say they are lovely.—**Mary R. Forbes, New York.**

I have four hundred working Homers. They are producing seven pairs of large squabs to each pair of breeders a year. Half of these breeders are too young to do their best. I hope to enlarge my plant in the near future.—**D. D. Powell, California.**

HOW TO JUDGE WHEAT FOR SQUAB RAISING. I have found, in travelling over all parts of the country, that there is a great difference in wheat. It is divided into the two general classes of red wheat and white wheat. There is also winter wheat, which is planted in late summer in time for it to send up its blades or leaves, then remains like this over winter and starts to grow again with the first opening of spring, thus having a long or full season to mature or ripen in. Spring wheat is wheat planted in the spring, thus having but a short season to mature and ripen, for the farmer has to wait until the ground is sufficiently thawed and dried out to work it.

The very best staple feed for pigeons everywhere on this continent is the first or best quality of the red, winter wheat—the same as is used for making the best quality of flour. Necessarily, this is the most expensive wheat in cost, but the cheapest feed, all things considered, for squab raising. In appearance, it is copper-colored, well filled out or smooth on the surface, not puckered or wrinkled, clear colored, almost transparent like a small chip or a fine specimen of brown flint, not cloudy. It should be well seasoned, dry and hard to bite. This kind of wheat is not offered for sale on the general market and it takes a fairly skillful buyer to procure it. It can seldom or never be bought by the bag except direct from the farmer or possibly from the flour mills, and the flour mills would only let you have the poorest of this grade.

Next to this, in desirability for pigeons, is the number one, red, winter wheat often sold by grain dealers. Then comes the number two, red, winter wheat which may have considerable wild seeds and some chaff mixed with it and it may be somewhat shriveled or wrinkled. This last is not objectionable for squab raising if the kernels are clear, transparent-like and hard. But if the majority of the kernels are cloudy and especially if they are soft or easy to bite, I would never buy it. In some sections, the screenings of this red, winter wheat can be had cheaply and it is not objectionable if the kernels are clear and hard, as stated above.

The next on the list is red, spring wheat. Though not so good as the winter wheat, it is all right to use, provided the kernels are clear and hard. It hasn't as much nourishment for pigeons and is more likely to be soft or immature and hence cloudy. Any genuine, red wheat, although cloudy, may be fed to pigeons without serious harm, but it will not produce the results you are looking for with the squabs, neither in quality nor number. If this last kind has to be used more peas and hempseed should be given.

White wheat may be fed for squab breeding, if handled with judgment, in any part of the country, if it is impossible to get the red wheat.

Wheat of any kind, which has been "heated" and has the slightest musty smell, or has the slightest amount of bluish mould or dust on it, must not be fed to pigeons. It is much easier to find good wheat and to detect it if it has been spoiled than it is to judge cracked corn.

BEST WAY TO FEED SALT, by Edward G. Rice. I have heard many people say that coarse ground salt is all right for pigeons. In my experience it is not. The pigeons when eating will sometimes get too much and it will kill them. I used it for a while, but of course when it began to kill my pigeons I stopped it. It is best to put a lump of rock salt in a box of grit or gravel and wet it thoroughly every day. The pigeons will eat this grit or gravel after it has been flavored by the salt and you will find that it keeps them very healthy. It is almost as necessary for pigeons to have salt as it is for them to have feed and water; that is, if you expect them to keep in good condition and work.

TEN CENTS A PAIR A MONTH, WEST VIRGINIA, by J. L. Wallace. I have kept a record of the feed, and find that my Homers cost me ten cents a pair a month, or \$1.20 a year. I have now moved into my new home and want to make arrangements to get my squab plant fitted up as soon as possible. I work in the bank from 8 a.m. until 4 p.m., which gives me ample time to look after a good-sized flock.

I wish to join the National Squab Breeders' Association. Please enter my name, also that of Fred Le Blond, Jr. Send two buttons. The Homers that I bought of the Plymouth Rock Squab Company are the handsomest and best birds that I have. I sold off every one of the old ones and now have my loft full of the offspring. They are certainly fine birds. The squabs weigh from nine to twelve pounds a dozen. I have turned the entire financial part of the business over to my boy, who is ten years old, and even if it does cost me money each month, I am perfectly satisfied to pay it for the splendid training it is giving him. He keeps an accurate account of all money, pays himself a salary, and just about breaks even. I consider training a young boy along these lines to be invaluable, as it gives him a fair insight into business methods, and not only in handling the business itself, but in teaching him the importance of watching details so as to insure success.—F. E. Le Blond, Ohio.

I sent you in a couple of orders a few days ago and from time to time you will hear from me, as my birds are giving you some fine advertising in these parts. Of course you know as I do that it is the man behind the gun and I tell these people that when the birds arrive, they will be all right and just like mine, but it is up to them to get the same results that I do. My short experience with your firm has convinced me that you have the stock all right and that you are responsible in every respect.—A. Penn Krumbhaar, Louisiana.

I began my plant with four pairs of Extra Plymouth Rock Homers in April, 1910, and I now (April, 1911) have over ninety strong, healthy birds including twenty-six mated couples.—Ethel M. Watson, California.



THE MISSES BOHANNAN HOLDING TWO OF THEIR PET PIGEONS.

SQUAB SUPPLY FALLS SHORT OF DEMAND,* by **Burton T. Beach**. Epicures are coming to think that squab on toast is as appetizing as quail on toast, provided the bird is bred scientifically, killed at the right moment and properly kept in the larder.

Squab meat is one of the few forms of food the supply of which falls absolutely short of the demand in the United States. Scores of banquets given last winter in New York, Chicago, Philadelphia and Boston were arranged without squabs in the menus for the sole reason that it was not possible to get enough to go around.

"My chef," said the proprietor of the famous Manhattan hotel, "tried to gather eight hundred squabs for a dinner in February. The committee insisted that we get them. After searching the markets and squab farms and cold storage houses all we could find was five hundred, and we had to cut out squabs. Very likely there will be a similar shortage next winter. And it will be a genuine shortage, not an artificial one."

The first solid food given to Mayor Gaynor after the shooting was squab. Medical men are more and more inclined to prescribe squab in the dietary of invalids, especially children. One of the most nourishing fluids is the juice of the squab killed when about able to leave its nest voluntarily.

Six years ago the business had a boom, but the boom soon collapsed. In 1907 there was a vigorous revival: improvement has been continuous.

On Long Island, near New York, the Misses Bohannon, after five years of unremitting attention, have built up an excellently organized plant, with improved modern appliances, and are exploiting a flock of four thousand birds, soon to be enlarged by half as many more.

One who never had met them save at a social function in Manhattan or in their parlor at Knollside Farm would not suspect that they knew any more about pigeons than could be learned from books or an inspection of rare columbidæ at the zoological gardens or a visit to the Basilica of St. Mark's, in Venice, where the pigeons are a whirling wonder.

Confronted suddenly with the necessity of making parental capital yield at least four times what it would yield if deposited in savings banks or invested in securities, they decided to try squab farming as likely to bring a better return than the New York market for poultry. While there are plants larger than theirs devoted to raising "breeding birds," these young women have the satisfaction of owning one of the largest devoted exclusively to raising squabs for food.

Question: I have my nestboxes numbered and know what each pair does. In the evening I transfer the records to a book, and thus know from week to week where I stand. I give the birds quite a lot of bookkeeping.
Answer: It is easy to do too much record keeping. The record should be kept either on the nestboxes or at the back of each pen, and in a card index kept handy in the squab-

house. Do not make memoranda which later you have to transfer. Write it only once, for keeps. Do the record-keeping in the squab-house, otherwise one is liable to spend as much time over his records as over his pigeons, which is a poor use of time. Evening work, if any is done, should be devoted to writing letters and postal cards, advertising matters, etc., pushing sales. The marketing is quite as important as the raising, that is, intelligent marketing which gives the breeder a fair share of the money which the consumer pays.

A BIG SQUAB SHIPPER, by **E. L. Kauffman**. Please send me the Association membership button. I think your ideas are all right. Push the price and urge more squabs eaten, as all squab raisers and shippers want that. The last year I shipped over one hundred thousand squabs to the New York market. We seem to have a fine country for squab-raising, and I hope it may come to be one of the great things. Wish you good success.

This is not an uncommon experience: "Before I commenced to correspond with you I bought five pairs of Homers of a dealer near home and I got eight cocks and two hens, and he will not exchange back so I can mate mine up. Now, I am about ready to get the ones I had written you about, special offer No. 2, and I would like to get also six of the No. 1 hens to mate with the six odd cocks I have. If you can fill the order in this way I will send the money as soon as I hear from you."—**H. W. Nims, Minnesota.**

I entered my five pairs of pigeons, each pair of solid red Carneaux, white Maltese, white Plymouth Rock Extra Homers, blue checker Plymouth Rock Extra Homers, and blue checker Swiss Mondaines, at Seymour, Columbus and Franklin Poultry Shows (Indiana) and captured all fifteen first premiums, or five first premiums at each show. Our judges said that my birds cannot be beaten. Don't you think it is a good record to win fifteen straight first premiums?—**George S. Beyer, Indiana.**

The pigeons which I bought from you a little more than a year ago (six pairs Plymouth Rock White Homers and six pairs Plymouth Rock No. 1 Homers) are certainly fine, and I now (June 27) have nearly three hundred birds and they are splendid pigeons. I have at present two pairs that have three fine squabs each and also one pair sitting on four eggs. I haven't been trying to dispose of any as yet, but in a month or two I am going to be in a position to sell quite a lot of squabs.—**E. G. Davidson, Illinois.**

The three pairs of Plymouth Rock Homers I bought in March, 1910, multiplied so fast that up to November inclusive, I raised thirty-four squabs, and every one of these weighed one pound apiece alive when four weeks old.—**John N. Moeller, Connecticut.**

*Copyright, 1910, by the New York Herald Co. All rights reserved.



MR. LLOYD PAID \$50 FOR THIS HOMER.

It is an investment because he sells for good prices the racing stock bred from her.

Question: I send you a newspaper clipping showing today's San Francisco quotations: pigeons \$1.50 a dozen, squabs \$2.50 a dozen. I spoke to a Chinaman the other day and asked him what he asked for squabs and he said fifty cents each. He showed me some and they were common pigeons. The Chinamen are big squab eaters. Would it pay me to ship to Eastern markets in large lots or would you seek a home market? **Answer:** Sell squabs right where you are. Your present doubt is caused by assuming that those figures you saw in the newspaper are correct, just because they were in print. As I explain periodically, those figures are what the commission men would like to pay to get the squabs, not what they are obliged to pay a breeder of intelligence. The Chinaman gave you the straight tip. He said \$6 a dozen, therefore sell at wholesale at \$3 and \$4 a dozen.

For scouring out the drinking fountains and bathtubs, I use baking soda and scalding hot water. This cleans and purifies the vessels and leaves them fresh and sweet.—James Y. Egbert, West Virginia.

My birds are coming on so fast that I have to build larger quarters for them. The demand for squabs here continues very good, prices, too.—Walter I. Hayes, Colorado.

\$50.00 PAID FOR A MILE-A-MINUTE FLYER, by Alfred Lloyd. I have bought for \$50 the Atlantic combine winner (see photograph) which won the three-hundred-mile race in the Malden district. This Homer is the best hen in the United States flown in 1909. She was competing against thirty districts, two hundred lofts, 1274 birds in the contest. The race was from Midland, Ontario, to Everett, Massachusetts. This bird made a speed of 1753.22 yards, or very nearly a mile a minute. One of my customers flew a bird that he bred off of birds which he bought from me in the greater Boston concourse race. He won first diploma in Malden district and won third diploma and third cup with 1864 yards a minute. This Homer is a straight bird imported by the Plymouth Rock Squab Company. The man who flew the bird is Joseph McKane, of Malden district. The race was flown October 17, 1909.

I stopped at the Kirkwood Hotel, one of the leading hotels of Des Moines, and asked what they were paying for Homer squabs, and I found they were paying \$4.25 a dozen for those weighing seven pounds or over to the dozen. I asked if they could use any, and they said they could not at present, as they are getting a regular supply from some one out of town; but they told me of two other hotels that can use quite a number at the same price, so I consider our home market pretty good.—Charles Starkey, Iowa.

I could have sold the last order of pigeons a dozen times over, but none of my pigeons are for sale. I was quite proud of the comments and attention they received at the depot. You selected a fine bunch of birds, and I sincerely thank you. If I have occasion to order more soon, you will get my order.—Dr. I. B. Thompson, California.

If you will look at your books, you will find I bought three pairs of Plymouth Rock Homers of you about two years ago. I have sold about \$100 worth of squabs outside of what we have used ourselves. At the present time I have about nine dozen mated pairs.—John Freely, Illinois.

I have the beginnings of a really good pigeon plant of the Extra Plymouth Rock Homers. From the original eight birds which I bought in April, 1910, I have now, January 26, 1911, seventy fine birds.—Ethel M. Watson, California.

DO NOT HELP SQUABS OUT OF THE SHELL, by M. C. Martin. I have received inquiries about squabs dying in the shell. Some have said that they had helped dozens of young out of the shells and that many of them had died in the shells, and many that they helped out died later.

I had the same experience several years ago. I used to become impatient after the eggs were "pipped," and have killed many a squab by helping it out of the shell before it was ready. Some young break the shell slightly two or three days before they get out, others come out quicker, but for pity's sake let the eggs alone and do not try to get the squabs out ahead of time. A little one that cannot get out of the shell itself is not worth helping out, for it is not healthy and will very likely die anyway, but the harm is this: You kill so many good young by pulling them out before they are ready. One writer stated that the young seemed stuck fast to the shell and she had to pull them out. The young were very likely all right had she just left the eggs alone and let the young run their own business, viz., getting out of the shell. "Care killed a cat," and it has killed many a pigeon as well.

There are two kinds of squab breeders, those who are too stingy to feed a sufficient amount of the higher priced foods or luxuries, and the other class who treat their birds like pet canaries, and feed too much of the rich foods.

Don't help the young out of the shell. Let nature attend to this.

Don't give baths excepting on warm days in winter weather.

Don't be stingy, but "treat" your birds to the luxuries as several writers have indicated in the magazine columns in their bills of fare for feeding.

Don't "treat" the birds all the time to luxuries or they will become like candy-fed children, disordered and sickly.

Don't jump at conclusions about your birds and their habits. "Make haste slowly," and study the birds.

My plant now consists of twelve units, and the structure is fourteen feet wide and 120 feet long. Three years ago I started with five pairs of Plymouth Rock Homers, having no intention of increasing my flock this soon, and now I have 400 pairs of birds. I am now building another structure containing six units, sixty feet long and fourteen feet wide.—**Frank Hucht, Kansas.**

My Homer squabs weigh alive as I sell them, nine or ten pounds to the dozen. The Carneauux or Carhones weigh at four weeks old, while yet on the nest, one pound each, or about twelve pounds to the dozen, average. I got my first pigeons in 1906, Plymouth Rock Extra Homers. In 1908 I got Carneauux same place.—**Graham Roys, Michigan.**

The sunny squab breeders are the successful ones. Follow the failures home and you find debt, gloom and snarling.

REASON WHY SQUABS DIE IN THE SHELL, by Elmer C. Rice. Squabs dying in the shell have puzzled many. In all such cases, I formerly gave these causes: a damp loft and lack of vitality due to improper feeding. The second is rather indefinite, being a result rather than a cause. I have no doubts now that the two causes, and the only two causes are: **dampness and lack of ventilation.**

I have been keeping track of letters of this kind and have watched to see the results of advice. The average case of squabs dying in the shell is mild, affecting only a few. Beginning over a year ago, however, Alfred Karker, a Wisconsin correspondent, had an adventure which he tells as follows: "Last year I wrote you asking what caused the squabs to die in the shell, and you told me it was either a damp loft, lack of vitality, improper feeding. Last spring I lost at least sixty to seventy squabs this way, and this spring I am having the same trouble. I have been feeding only the best grains and as you direct in your **Manual**. My loft is in the hay-loft of my barn directly overhead the horses, and I think the steam from the horses goes through the ceiling and condenses in the hay-loft and causes this dampness. In cold weather the rafters in the hay-loft are all covered with white frost which shows that the moisture must come from the horses below. What would you advise me to do, and how can I arrange it to overcome this trouble without changing the location of the loft? I am a subscriber to the magazine and think it the best published. Thank you for any information you can give me."

I replied as follows, February 25, 1910: "That trouble is surely caused by dampness if you can see the white frost on the timbers. You can dry off this dampness by letting more fresh air into the lofts. You should arrange a ventilator so as to get plenty of fresh air. Do not be afraid of the cold. The fresh air will dry off your loft."

April 21, 1910, Mr. Karker again wrote: "Received your letter of February 25, and wish to thank you for the advice you gave in regard to dampness in my loft. Since I tried your plan I have had no more trouble."

In other words, to use language easily remembered, squabs in the shell may be **drowned** by too much water, or **suffocated** by bad air. I find that pigeon breeders able to tell dampness when they see it are as scarce as those able to judge grain. In case of doubt, no matter where you live, summer or winter, take out your windows entirely and stretch cotton cloth. There are absolutely no sick pigeons or squabs housed in dry, open-front houses and fed on a variety of sweet, sound, old grain and grit. Ability, or lack of it, to control health, as well as profits, is in the caretaker.

The birds you sent me in October, 1908, are doing fine work, also those shipped to me last August. I have one red checked cock raised from your No. 1 Homers that weighed nineteen ounces at four weeks.—**Jerry F. Kaftan, Ohio.**



FOUR-WEEKS-OLD SQUABS BRED FROM WHITE PLYMOUTH ROCK HOMERS.

I SELL SQUABS AT MY DOOR FOR \$5 A DOZEN, by Harriet L. Ayres. I have bought the share in chickens and pigeons from the young woman who started with me, so I own the stock now complete. I began three years ago last September with six pairs of Extra Plymouth Rock Homers. They started to lay within two weeks after they arrived. I purchased six pairs more Extras of the Plymouth Rock Squab Company one year ago last July. I have raised about five hundred.

I have had a great many compliments on my pigeons for their size and beauty as well as for their hatching. I have been with them and watched them so often that I know their little ways very well. I find it very interesting. I have kept track of some and know they have hatched nine pairs to the year. They average about one pound apiece, over ten pounds to the dozen. I get \$4.50 and \$5 a dozen right at my door in private trade. I sell them for luncheons and for the sick and have sold some at our hotel here (New Jersey).

I feed a mixture and find my birds do better on that. I give them their dainties of hemp and Canada peas separately. They have plenty of fresh well water. They have a lump of rock salt, and oyster shell, pigeon grit and charcoal before them all the time. The sickness I have had would not be worth mention and have not been troubled with lice, as I believe keeping them in a clean place is the root of health.

I keep a cash record of everything and will say they more than pay for themselves. The pigeons alone paid for my partner's half of poultry and pigeons when I bought her out last May and a great many other things I have not the room to mention. I am pleased with the business and am convinced there is money in it and expect as soon as I can get the plans and material to put up two unit houses and progress in that business. I keep on raising chickens for the eggs as the two are well combined. I consider Rice's Manual a good one. If followed, one cannot help succeed. I have found experience a very good teacher but one must love the work and be interested in the birds to make a good success.

On three previous occasions we have bought your pigeons and found them satisfactory, especially the white ones. We find that your birds go to work rapidly, and we have a good demand here at a good price.—**Olympian Homer Squab Company, Kentucky.**

My stock were Homers received from your company. They have been doing excellent work for me. I began the business in a very small way about two years ago with three pairs; now I have about 250 breeders on hand.—**C. H. Burton, Maryland.**

Squab breeders, don't forget that no one is interested in your getting good prices for good squabs but yourself.

HOW TO CURE PECKING, by Eleanor G. Ames. There is one thing I have to offer which may be of help to the breeders who have trouble with squabs being pecked. It is a remedy I have used with great success. Dust a pinch of powdered aristol on the spot. It will cure the sore, and as the pigeons do not seem to like either the taste or smell of the aristol, the squabs are let alone. The powder is quite expensive, but a little will last a long time. I have had great success with my Plymouth Rock Carneaux as breeders of squabs averaging seventeen ounces each. I cannot supply the demand for squabs among my own friends and acquaintances.

I have one Plymouth Rock squab just three weeks old that weighs one pound, two ounces. I think there is some class to the Plymouth Rocks. The squab is a Homer and the largest I have raised. I have about three hundred now. We get \$4.50 per dozen and all we have sold from ten to twelve pounds to the dozen, which I think is very good. I bought three pairs of Carneaux from another party over a year ago. One pair has done very well, one other pair laid a few times, but never hatched a squab, and the third pair never laid for the whole year, and they were turning gray and I thought I had fed them long enough, so killed them. If I ever get any more it will be from the Plymouth Rock Squab Co.—**A. H. Eldredge, New York.**

In looking back over my file of your Squab Magazine, I find that I have received twelve copies of the paper since I sent you my last subscription of a dollar, and as I would not miss a copy of the pigeon man's best standby, the Squab Magazine, I am sending you an express money order for one dollar, for which please send the magazine for another year. I have about fifty pairs of Homers, as fine, racy, broad chested and fast breeders as any one would wish to own. They are from Plymouth Rock stock mostly and that accounts for it. Though only in the business one year this month, I find that poor stock at any price is dear and as for my part I wouldn't take any as a gift and mix them with mine.—**R. R. Muirhead, Washington.**

There is a great demand for squabs in Colorado Springs. The butcher charges eighty cents a pair for them. Our butcher, while selling us a pair last week, said that he thought they made the most popular dish. I mentioned the Plymouth Rock Squab Co. and he said, "Their squabs are quite famous."—**Howard B. Carroll, Colorado.**

I hope to be able to build another pigeon house this spring, in which case I would place an order for birds with you of about the same number as last year, because I was and I am well satisfied with them.—**Stefan Schwarz, California.**

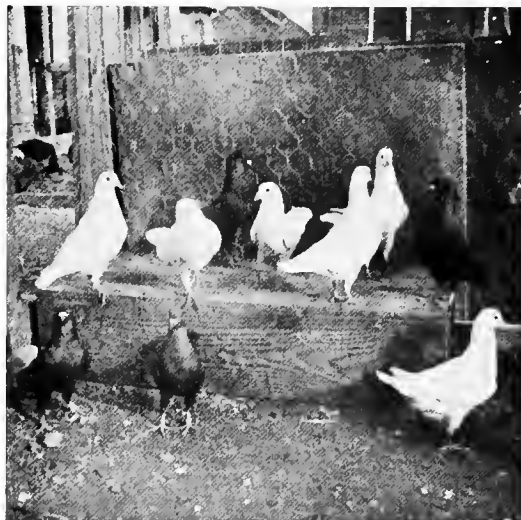

RED AND PURE WHITE CARNEAUX.

This photograph is the first ever printed of pure white Carneau, obtained by breeding out the red of the splashed birds, exactly the opposite procedure of those who have bred out the white to get all-red Carneau. Fully ninety per cent of Carneau have both red and white in their plumage and these two colors are characteristic of the breed.

When you find eggs on the floor, do not throw them away unless they are broken or cracked. Some of my best pigeons have come from eggs that I have found on the floor. Put an egg in a nest that has only one egg in it. If you find three eggs in a nest, take one egg out and put it in a nest where there is only one.—Pruyne Van Alstyne, New York.

The Homers that I bought of you two years ago are doing fine. The squabs at four weeks old weigh from fourteen to sixteen ounces apiece, and they have been breeding eleven pairs a year. I think that I will want one or two pairs of Carneau in the spring.—Harvey C. Jasperson, Wisconsin.

The Homer females I ordered from you arrived today. I must say they are the finest birds I ever saw. Your Extra Homers must certainly be large birds, as these are the largest I ever saw. When I order again I will know just where to get them.—Karl Fach, Jr., Mississippi.

Pigeons which are observed and studied are more entertainment and less work.

HOMERS ARE THE REAL MONEY MAKERS, by J. W. Arthurs. My experience in the squab business dates from the spring of 1908. I use tobacco stems for nest material, I have absolutely no lice trouble. All my houses are from eighteen to twenty-four inches off the ground. No rat trouble.

I weighed all feed consumed by one hundred pairs for one year. It totaled 7500 pounds, and at a cost of two cents per pound it makes the feed cost of \$1.50 per pair. In the same time the pigeons produced 1300 squabs at a cost per squab of eleven and one-half cents not including cost of labor. This year feed is fully fifteen per cent cheaper than last. During the four summer months last year I sold from 400 pairs, 1800 squabs. I sell all squabs to a dealer in Philadelphia.

I have tried several breeds of pigeons and as yet have found none that I can do as well with as the Homer. It is a wonderful bird, and I believe it will have to be the basis of most large squab plants for some time. My ideal squab pigeon is one that has the many good qualities of the Homer and that will produce a one-pound squab. I weighed this week two squabs out of the same nest, eighteen and twenty-three ounces, and as far as I know they are straight Homers.

Personally, I am delighted with the raising of squabs as a business. I enjoy the work and am satisfied with the result. I have had experience with chickens and can obtain the same results with one-half the labor with pigeons as I could with chickens.

The birds I received from the Plymouth Rock Squab Co. October 31 pleased me very much. Every pair is sitting on eggs, except one pair of Maltese with squabs five days old. Enclosed you will find Money Order for \$10 for which send me six pairs more of your mammoth crosses. This is my third order. I would have sent you a larger one but my loft would be overcrowded, as I now have a large flock of Homers which I raised from the six pairs of No. 1 stock purchased of you January, 1909.—Mrs. Ada T. Hayden, Massachusetts.

A little thing is a little thing, but faithfulness in the little things of squab breeding is a very great thing.

More squabs, better squabs, higher prices for squabs. More business squab talk and less politics and personalities.

SQUABS PROFITABLE TO ME FOR FIFTEEN YEARS, by William P. Gray.

We often read in the poultry papers of hens that do phenomenal laying during a short period of time. Usually this will be for the spring months, with no account given for the fall laying. Such reports are of little value, and are misleading to the novice. Yearly records are what count. It is the same with pigeons: the birds that breed through the fall and winter are the ones that raise ten pairs of squabs a year—they are the mortgage lifters. For the past fifteen years, pigeons have continued to be a good investment with me. The average cost of feed per year for a pair has been \$1.20, and I have never sold a dozen squabs for less than \$3 a dozen. My birds in large flocks always average better than twelve squabs per pair per year.

I have been engaged in the poultry business in all its branches, both for myself and managing large plants for others profitably. I believe my observations are of some value.

The advantages of squab raising over broiler raising are briefly as follows:

1. One thousand squabs can be raised successfully on a plot that one hundred chicks would be crowded on.

2. No such expensive equipment is required to raise squabs, as with broilers on a large scale.

3. No incubators to watch or cranky setting hens to fuss with.

4. Small chicks require five feeds a day and constant attention, while in squab raising with a hopper filled with food once a day, the old birds attend to the wants of the squabs entirely.

5. Squabs do not get into cold corners and get chilled, nor wander off in the bushes and get lost.

6. Squabs do not require a range where they are liable to become the prey of rats, cats, hawks and crows.

7. The death rate is almost nothing in squab raising, while it is something appalling in young chickens.

8. Squabs mature in one-third the time that broilers do.

9. Squabs are raised the year round at a good profit, while broilers are rarely raised successfully more than six months in the year.

10. Three squabs can be picked in the time it takes to pick one broiler, and the three squabs will sell for twice as much as one broiler.

11. No need of getting soaked to the skin driving stock to shelter every time a shower comes up, as squabs are always safe in their nest.

12. No night work in all kinds of weather as in the broiler business, stoking coal or standing on your head to look at a brooder lamp.

13. The broiler raiser must be continually on the job. He has no Sundays and no holidays, while the squab raiser can often with a few hours' work in the morning filling hoppers and fountains have the balance of day himself.

I can state without any qualifications that my experience has proved squab raising to be the best paying branch of the poultry industry. Every ten cents' worth of feed used will maintain a pair of breeders and raise a squab selling from thirty cents to fifty cents.

I trust these facts may put some one on the right track. I am at present caring for 1800 head, mostly small chicks, also hens, pigeons, squabs, ducks, and geese.

SQUAB ORDERS TOO LARGE FOR ME TO FILL, by C. S. Eby.

I am going to make a specialty of Carneaux, as I am having good success with them. I started in a four by eight chicken coop with some Homers. I then built a unit squabhouse, and have it full of Homers, and have no more room for any more units. I am now looking for a larger place so as to go into the business on a larger scale, having the desire to raise them by the thousand. I still get from sixty to seventy cents a pair for squabs wholesale, and they retail here (Michigan) at ninety cents and one dollar. I have been doing all wholesale business and I am now going in for the retail trade. I can sell all the squabs at sixty cents a pair and better. The only trouble I have is that the orders are larger than I can fill and that makes it hard on me. A few weeks ago I went to a market downtown and inquired about squabs, and the marketman told me he sold them whenever he could get them. So I left my telephone number with him. A week or so later he telephoned me an order for two dozen. I had been selling right along and did not have enough squabs to fill it, so he told me his opinion of me. I resolved not to advertise unless I am sure of the goods. I am going to move into a place where I can raise a thousand pairs of pigeons. I have been in the business two years and feel confident that I can make a success. My birds have been greatly admired and praised for their size and quality.

I beg to advise you that the shipment of 115 Extra Plymouth Rock Homers reached here in good shape Saturday night and on Sunday morning I liberated them in their new home. I wish to thank you for your liberality in sending me the two extra pairs, and for sending me such a fine, healthy lot of birds, not one of them being in any but the best of condition. I have some very fine stock, originally bought from you, and this last lot of birds, taking them all the way through, equals the balance of my stock, which has been bred from year to year to produce only stocky, full breasted birds. Your guarantee accompanying the shipment is very broad and fair, and had I known its terms, my letter of October 21, 1911, to you would have been superfluous, for the guarantee itself covers everything. I then asked of you concerning matings. I am very much pleased with all of the birds, and especially with the pair of Carneaux, which are undoubtedly the real thing.—B. N. Spangenberg, New Jersey.

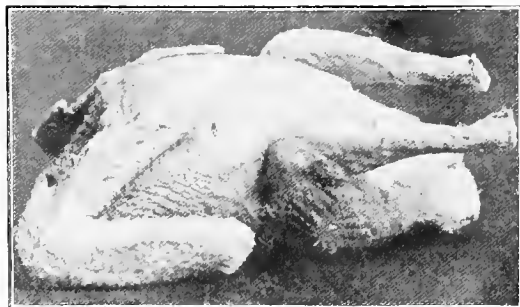

HOW I DRESS MY SQUABS.

"The method here described applies to those which I deliver to families. I draw them and cut off the head and feet. I do not believe in selling squabs alive to a retail trade."—*R. C. Boyd.*

WHY SQUABS SHOULD NOT BE SOLD ALIVE, by *R. C. Boyd.* The squab from which the above picture was made weighed seven-eighths of a pound: a white-skinned Homer. The picture shows the way I dress my squabs for my private customers, with one exception: I draw them and take crop out perfectly clean. I also give with each order a couple of printed recipes. I do not sell live squabs to customers except on special request. I give them no reduction. I charge the same for a live squab as I do for a dressed one. Consequently my customers do not order live ones. One should not sell live squabs to private trade because (1) some will order to get them a little cheaper than dressed ones. (2) It is a knock against the squab business. (3) No cook or other servant in private families likes to dress poultry. If they have to do it, you bet they could burn them a little or have them cooked in some way that would make the mistress not want any more squabs in her house. When I solicit customers, the first thing they ask me is: "You dress them, do you? How much are they in the rough?" Answer: Seventy cents small, eighty-five cents large. "How much dressed?" Answer: Seventy cents small, and eighty-five cents large. I hope all other squab men who are catering to private trade will not sell any squabs in the rough.

The seventy-five pairs of Plymouth Rock Homers which I purchased of you are doing good work. They are the most carefully selected birds as to size and color that I ever purchased. The Carneaux are large birds, and breeding rapidly.—*D. D. Powell, California.*

It pays to be a live squab breeder. Remember that the inscriptions on the tombstones of the dead ones do not tell what their faults were.

\$30 FOR GRAIN, \$100 TO \$120 FOR SQUABS, by *J. B. Beckman.* I must say I am doing fine with my Extra Plymouth Rock Homers and they are doing fine with me, so we get along very well. I do for them and they do for me. You ought to see the swell addition I am putting on my plant for three hundred pairs more. I have not shipped very many squabs for I have been saving them for breeding birds. I have now seven hundred pairs not counting squabs. I never lost a breeding bird in the last moult, and the house is just a mass of squabs, nests and eggs.

I was the first one in this Missouri town to start a squab plant and they all laughed at me and assured me I must have money to burn, and went so far as to tell me I had no sense to put up such a fine building for the old pigeons. If I had listened to them I would not have a fine plant worth about \$2200, with birds, and just as it stands I would not take for my place now \$6000. But I have them all thinking when they come out and see for themselves what is going on at my house. Last Sunday there were fifty-one persons out to see the fine birds and I feel very proud of it, too.

There is a man close to me who is running a dairy farm. He has ten milk cows and he said when I showed him my account in the German-American Bank, just on my squab plant from last March to first of September, 1909, that I had his father beat on his dairy business. He didn't say how much.

From March 18, 1909, to September 11, 1909, I sold \$392.63 worth of squabs from 229 pairs of breeders, expenses \$150.35, total of \$242.28 net profit. If I had 1000 pairs I would have made a nice piece of money and you see I will make more when I get better posted on these lines, raising my squabs and marketing also. There is always something to learn about this.

I am shipping seven dozen fine squabs per week, which bring me from \$25 to \$30 a week, and it costs me \$1 a day for feeding, or \$30 a month. I tell you it's fine doings.

I have been in this business now almost two years, have made quite a success, and I am well pleased when one comes to see my plant, for it is a dandy.

My Plymouth Rock Homer squabs are dandies. Weighed several pairs of squabs already, and one pair twenty-six days old weighed two pounds four ounces. None less than three quarters of a pound each have I found yet. My birds are all working now and I expect great doings from them, for they are certainly hustlers.—*Norman E. Crozier, New York.*



SEE THE BIG SIZE OF THESE EXTRA PLYMOUTH ROCK HOMERS IN TEXAS.

TEXAS JUDGE ON SQUABS vs. CHICKENS, by Ocie Speer. I am one of the justices of the Court of Civil Appeals for this State (Texas) and my interest in pigeons and poultry is purely for diversion, and I must say I have found it most interesting. As between pigeons and chickens, I am decidedly for the former. This conclusion has been reached after a very thorough comparative test, for one season, at least. During the past spring I have expended nearly two hundred dollars in incubators, coops, chickens, eggs, oil, and feed. Have set nearly two thousand eggs, hatched nearly one thousand chicks, eaten only about twenty, and now have, of all ages, only about one hundred. They began dying immediately after they were hatched—indeed, hundreds of them made greater haste, and died in the shell—and those that didn't die of bowel trouble waited to die of sore head and roup. I have fertilized my kitchen garden with their decaying carcasses. I have tried all the remedies, from coppers to carbolic acid, and fed everything from bran to alfalfa. I have all the chickens I want—in a Pickwickian sense. I have eaten more broilers and had more pies from my few pigeons than from all my chickens. I have never lost a pigeon, but a few squabs have died of canker. I fed many bushels of grain and chops in an automatic feeder and finally canker appeared in my loft. I immediately ceased using the box and threw the grain on the gravel bed of the flyer, and the trouble disappeared entirely. If I use the feeder again I shall remove the board bottom and replace it with screen wire, which will act as a sieve for the dust to which I attribute the canker.

The plain way to get good prices for squabs is to refuse to sell at poor prices.

ONE YEAR'S GROWTH. I would like to write to let you know how I have succeeded with my Carneaux and Homers which I purchased from Mr. Rice of the Plymouth Rock Squab Company about one year ago last March. Starting with twenty-six pairs of Carneaux, nine pairs of colored Extra Homers and four pairs of Whites, I now have over three hundred Carneaux, one hundred Extras and fifty Whites. In fact, so many that I have no more room, and will have to sell some.—William McK. Ewart, Pennsylvania.

I have been very successful in the squab business. Have one hundred pairs of the finest Homers that you ever saw, all raised from thirteen pairs of Plymouth Rock Extras. All my squabs are sold to private trade for five cents an ounce. My lowest weight has been ten and one-half ounces, highest seventeen and one-quarter ounces each; average weight thirteen and three-quarter ounces each. Have sold several pairs of breeders for four dollars a pair. Trusting that you are doing a successful business, I still remain a friend of the Plymouth Rock Squab Co.—J. E. Ross, New York.

Replying to your favor of recent date, as to how my ten pairs of Plymouth Rock Carneaux were doing, I beg to advise that I now have about three hundred very fine birds, sixty working pairs, and all in the very best of health, never yet had a sick bird. I expect to be in the market again soon, either for more Carneaux, or some of your famous Plymouth Rock Homers, as I like your way of doing business very much. I thank you for your kindly inquiry, and wish you continued prosperity.—W. A. Sharp, Minnesota.

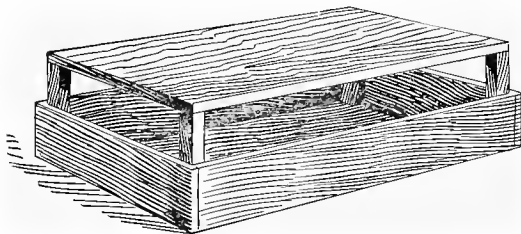

MY FEEDBOX IS SIMPLE BUT GOOD.

This illustrates the idea. The board on the sides should be about three inches wide and the opening above it two and one-half inches wide. The box may be any length to suit any size flock. The top board is removable. It prevents soiling. I feed grit and shells also from this type of box. The birds cannot squeeze into this box.—*Fred Ambrose.*

ONE WOMAN'S SUCCESS, by Mrs. Ida Knosman, Indiana. My success is due to the Extra Homers and service given by the Plymouth Rock Squab Company. In July, 1910, I bought twenty-four pairs of Plymouth Rock Extras. Now (October, 1911) I have sixty mated pairs and 150 youngsters. I intend to start buying adult birds January 1 and increase my flock to six hundred. I will buy of the Plymouth Rock Squab Company, so I'll get A1 birds. My experience has taught me that it is cheaper to buy adult pigeons than to wait and raise the young and feed six months.

In June, 1910, I purchased thirteen pairs of your Extra Plymouth Rock Homers, and now (November 2, 1911) have about eighty pairs of breeders and 140 youngsters. Have just started to sell my squabs and find a ready market. Can get \$4.25 per dozen for eight to nine-pound squabs. I am on a rented place, but expect to move in the spring and build more lofts and increase my breeders. If you know of any one in this locality who has Plymouth Rock breeders and cannot dispose of their squabs at a fair price, would be pleased to have their address, as at present I can dispose of ten to fifteen dozen more squabs a week than I can supply. There are a great many breeders here who have what are called American Homers which breed a squab a little larger than the common pigeon. Enclosed find ten cents to join the National Squab Breeders Association.—*H. W. Moore, Ohio.*

I received some of your goods last spring and I am very glad to say that they have given me very much satisfaction, especially the birds, which have raised squabs weighing over a pound apiece.—*J. W. Bolgiano, Maryland.*

I FEED ONLY ONCE DAILY FROM THIS BOX, by Fred Ambrose. I consider the feed question of the most importance in raising squabs. I lost more birds my first summer through canker by feeding too much cracked corn than I would lose in ten years from other ailments. Last summer I used Venetian red in the drinking water as a preventive, and had only two cases of it. I cured both of these with two doses each of Venetian red put in their mouths dry. For going light I use the red and pull out all the tail feathers, and very seldom I lose a bird.

I find that the birds must have grit before them all the time. I once neglected this for one week, and got a large number of undersized squabs. I opened some of them and found that their gizzards were about

half of their normal size, consequently they could not digest enough food to fatten up on.

It costs me about ten cents a month per pair to feed the birds, and I receive fifty cents for a pair of squabs, twelve ounces or over, each. They invariably weigh that at three weeks, some of them weighing a pound at that age. I have raised my stock from the Plymouth Rock Homers that I got from Mr. Rice. All my squabs are sold alive to marketmen in this vicinity. I haven't tried to work up a retail trade, not having time to attend to it.

I have read a great deal about mice scaring pigeons so that they don't breed, but from my experience I must say that I can't see it. I had lots of them in my loft and got just as many squabs as I ever got. I caught five in one trap one night so you can see they were pretty plentiful. One built a nest in a nest-box, right alongside of a pigeon nest with eggs in it, but the pigeons sat on their eggs just the same. Of course rats are another thing.

I send a sketch of the box I use for feeding grain, grit and shells. It can be made any length to suit the number of birds and will keep the grain clean. It has an advantage over some feeders because a larger number of pigeons can get around it at once. This enables the parents to feed their young at daylight instead of squealing for a couple of hours while the old birds are scrapping around a self-feeder to get a chance to fill up.

I received the birds and Manual, and certainly cannot recommend either too highly. I am an old breeder of pigeons and thought I knew about all that was to be known, but on perusing the Manual, I found out I could still be taught. It is the best book of its kind that I ever read, and would not part with it at any price if I could not get another.—*Charles Jansen, Illinois.*

FLORIDA'S BIG DEMAND, by W. M. Brown. We wish to get every person in Florida interested in squabs. We could at the present time sign one contract with one concern for four hundred dozen squabs at \$1800 for a four months' supply at one hundred dozen a month (\$4.50 a dozen) and could more than double it. We did not desire to cater so much to the tourist season, but went after the leading restaurants in our nearest city and got them, for the year. In one afternoon we had contracts to take every squab that the squabhouse we had built could supply, and at top-notch prices. Not only these, but one hotel made a request that we submit to them a proposition so that they could be guaranteed fifty-five dozen squabs a week. These are not half the demands that have already been made upon us to supply squabs.

There is only one thing in this matter which is lacking, and that is competition. We want it and we would like it from the North. There is now the best opportunity for squab raisers to come here and do well.

The bugbear which has held back so many squab raisers as well as poultrymen from coming to Florida is mites and lice. This fear is shown by people who are prone to laziness for there are no more mites and lice here than in the North.

Another condition which is becoming more and more dominant every year in this State, which any squab raiser by a little push can use to his advantage, is this: The people of inland Florida are making the coast towns their summer resorts. The influx of Northern tourists during the winter compels a great majority of the Floridians to stay home and attend to business and their recreation must wait over until summer, and as it is much cooler here than in the North, naturally they come to the coast. They are epicures to a large degree, and you will notice that they are always after a nice fish or an excellent turned chicken, but this summer they are to a good extent to be treated on this section of the coast to the luscious squab.

I am a subscriber of the *Squab Magazine* and think it a very up-to-date squab periodical. I have one thousand birds and anything new I like to try in the line of good cheap feed. I have been very successful in the business by following your Manual, which I would not be without.—Walter A. Hagedorn, Ohio.

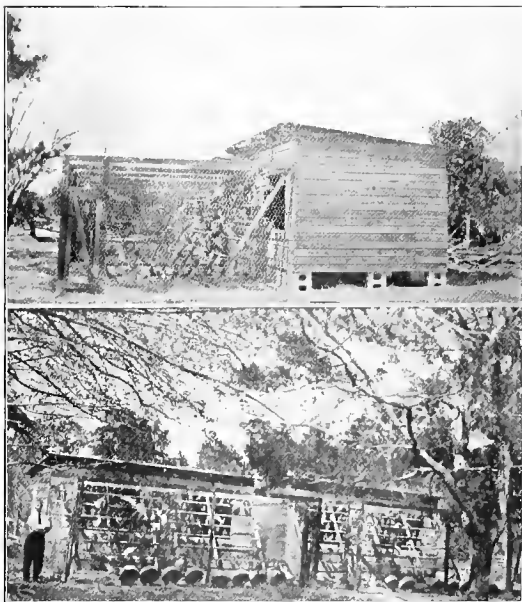

HOW THEY BUILD SQUABHOUSES IN FLORIDA.

Only one thickness of boarding. (Mr. Brown is seen standing by fly-pen in lower picture.)

In 1909 I sent to Boston for Plymouth Rock Homers from the Plymouth Rock Squab Co. I have sold squabs for breeders when about three months old for \$1.00 per pair. I have always fed the best grain and given them plenty of fresh water and have had but one or two sick ones. The hotels will take all that I can raise at from \$2.75 to \$3.00 per dozen. In the fall I am going to build for one hundred and fifty pairs. I have raised my flock of sixteen birds in less than two years to over one hundred and fifty.—F. S. Sadler, Oklahoma.

I have about three hundred Extra Plymouth Rock Homers, and they are fine ones. The weight of a fifteen-day squab which I examined yesterday was three-quarters of a pound.—L. O. George, Maryland.

I purchased six pairs of Homers from you in 1903 and was pleased with them. I want some good Carneaux for foundation stock, good heavy birds for squabs. Am not particular as to feathers.—E. W. Lewis, Colorado.

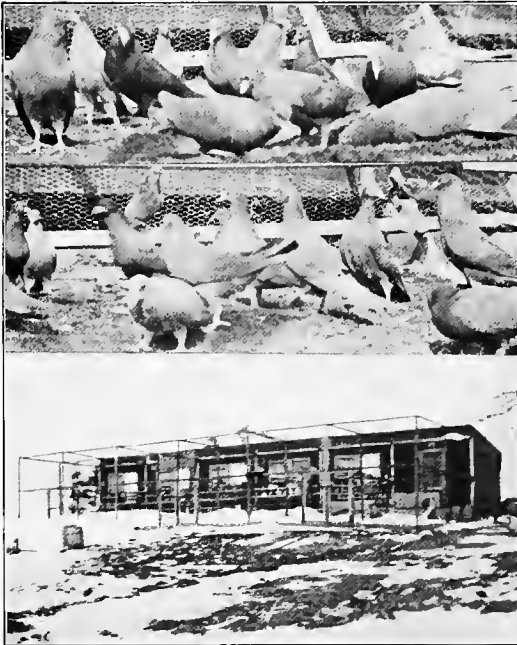

MR. HOWE'S SQUABHOUSE AND HIS CARNEAUX.

I am writing to ask you about picking and dressing squabs for market. I just picked and shipped six dozen to Heineman Brothers, New York, and I find it simply impossible to get the feathers off the head and upper part of the neck without tearing them. Does the market object to the feathers being left on the head and upper part of the neck? Any information you can give me along the killing and picking line will be highly appreciated. The Select Homers I purchased from you about twelve months ago are doing splendid work. Out of the twenty-five pairs two pairs lost their mates, which left me twenty-three working pairs. From them I have sold a good many squabs, and some mated pairs that I mated from them, and have mated up altogether about one hundred and fifty pairs of fine Homers.

We are just starting in the squab business, although we have had some little experience with pigeons, enough to know that Homers are the squab producers.—J. F. Woodhead, Minnesota.

FAT SQUABS FOR ME ON THREE GRAINS, by H. A. Howe. Starting a year ago I stopped using hemp entirely, substituting a mixture of one part oil meal, one part table salt and three parts sharp sand. This I keep before them in hoppers all the time, and becoming accustomed to it they eat it freely. The only grains I feed are peas, coarse cracked corn and red wheat. I give a mixture of these grains twice daily, at 7 a.m. and 4 p.m., in an open feed trough with a revolving stick running along the top (see page 108 of this book).

I give them just what they will eat up clean between feeding times, feeding more corn in winter than in summer, increasing the amount of wheat in summer. This method may be in defiance of many of your feeding schedules, but I am turning out Plymouth Rock Carneauux squabs that average a pound apiece, and Plymouth Rock Homer squabs that go better than ten pounds to the dozen.

The markets here (Massachusetts) from October 1 until July 1 are very good, the prices running from \$3.50 up to \$5.50 a dozen for good squabs.

The squab plant is located on a side hill that slopes to the south and consists of a building of the shed-roof type that houses five hundred breeders, both Homers and Carneauux.

During the past winter I removed the top sashes from the windows in the pens, substituting cotton cloth, which has been very satisfactory, giving a drier house and healthier stock.

I have for the past two years given all young stock raised for breeders their liberty during the entire summer, thereby reducing my feed bill and developing hardier breeders.

A few more words and I shall make these in the form of good advice: Start with good stock, enlarge slowly, give the business a chance under sound business principles and failure will be an unknown quantity.

If nothing happens I am going to put up two extra buildings this fall and winter, and next spring I will want from you at least five hundred pairs of selected Homers. I am planning to come up that way about that time, and will call on you and make arrangements for them.

Hoping to be able to do much business with you in the near future, and thanking you in advance for your information, I remain, H. A. Henkel, Virginia.



SQUABS, FRUIT, POULTRY, VEGETABLES RAISED HERE BY MR. VAIL.

I SELL MY SQUABS BY TELEPHONE FOR \$6.60, by Harry M. Vail. My wife and I came to New Jersey last May from New York City with the intention of starting in the poultry business. While we were waiting for our incubators to hatch our first chicks, we became interested in the pigeons that were already on the place. Our admiration for them later changed to genuine love. There were nearly seven hundred pigeons in the lot. Since the accompanying photograph was taken we have increased them to 1280. The breeding house is 172 feet long, divided into fourteen pens with movable double nestboxes. The floor is of concrete and the inside walls are of asbestos plaster. The house throughout is equipped with a self-regulating hot-water system, the same as are my brooder houses.

I am running a combination poultry, squab, fruit and vegetable farm. We do no advertising, as our squabs and other products do it for us. Squabs at this writing (February 13) are bringing \$6.60 a dozen retail and \$5 wholesale. Naturally I do no shipping.

One of my hotel customers supplies me with two barrels of bread a week. It costs us nothing and as I serve him anyway it costs nothing for hauling. I feed the bread slightly moistened, with a small quantity of commercial beef scraps added. It makes a splendid filler for squabs.

I never try at first to see a prospective customer personally, as you might as well try to see the King of England as the people of Montclair. I secure their telephone numbers

and call them up. I invariably secure my first introduction that way, state who I am, and what I have to sell. I mention several customers that I am already serving, and in a town like Montclair they all know of one another. I make an appointment and am seldom disappointed by the customer. If you are fortunate enough to secure them as customers and if you have the goods, you seldom have trouble holding them.

I guess I owe you a report about the Extra Homers that you sent me in July of last year. They have excelled my expectations. I have more than one thousand birds at present in spite of having sold some squabs since and having lost a good many during last winter while I was in the East, in consequence of carelessness by my former partner, and in spite of having moved them twice. They are admired much, especially my "old Guard," as I call my original stock bought of you.—Stefan Schwarz, California.

A little over a year ago we purchased some Homers from you and for breeding they beat any that I ever saw. I do not think there are any that can beat your birds for breeding qualities.—William E. Merritt, New York.

There are very few of my squabs that come less than ten pounds to the dozen. I have a good Plymouth Rock stock of Homers to breed from bought from Mr. Rice.—F. G. Fillmore, Missouri.



PLYMOUTH ROCK EXTRA HOMER OF BELGIAN ORIGIN.

Other breeds come and go, but our large, first-class Homers have no equal as money-makers in the squab business. The original photograph from which the enlargement was made is seen in the lower left-hand corner.

I have been steadily building up my flock of Plymouth Rock Homers, selling only enough squabs to pay for their feed, and have found my birds all you represented, often having squabs weighing eighteen ounces. Both of us have gotten a great deal of pleasure out of handling them. We sell their output to the steamers sailing from Galveston, having felt out the market and knowing it to be good.—**W. S. Faires, Texas.**

INDIANA WOMAN GETS \$3.65-\$4.60 A DOZEN, by Mrs. M. Bunyard. My Extra Plymouth Rock Homers are doing splendidly. I do not see how they could do much better. They are fine healthy birds and splendid workers.

I have sold since April 27, 1910, sixty-one dozen squabs, besides giving some away. I have got a good price for all I have sold this summer. I have been getting from \$3.65 to \$4.60 a dozen for the last month. Our banker says there must be a lot of money in pigeons from the amount of checks we bring in. I hardly ever lose a squab. I haven't given a dose of medicine this winter. I kill, pick and pack all my squabs myself. I have five squabhouses, one built in the left of the barn and three in the barn with the flying pens outside built up to the barn. I have one squabhouse in the coal shed. I find my birds like clover hay (that has been threshed out for the seed) to build nests. They never know when to quit building with it.

Some time ago I wrote to you in regard to purchasing twenty-five pairs of Plymouth Rock Homers. I was finally persuaded by the proprietor of a local plant to invest the money in a larger breed, Runt-Duchess-Homers. He represented them to be faster breeders than the Homer and said that they bred larger squabs. The former is anything but true, and he barely gets by on the latter statement. I am sorry that I did not then know of the breeding qualities of the straight Carneaux. I have recently taken in a partner and we have decided to rid ourselves of this mixed breed if possible, and fill this unit with straight Carneaux from your company.—**T. R. Frank, Rhode Island.**

Our stock was originally purchased from the Plymouth Rock Squab Co., both Carneaux and Homers and we can assure you our stock is good. We have several letters from Messrs. Silz of New York, to whom we ship most of our birds. We also supply the Hotel Royal Poinciana, Palm Beach, Florida, during their season, and we can assure you that nothing but the best holds their trade.—**Seminole Squab Farm, Florida.**

HOMERS MORE PROFIT THAN LARGER BIRDS, by Martin L. J. Steele. Two years ago I became interested in squabs but as I knew nothing of the care of pigeons I began raising them in mind only. I spent nearly a year studying the question from all sides, and last February put in my first lot of breeders, fifty pairs straight Homers. March first I bought fifty pairs more. This lot consists of Homers, Dragons, Mondaines and two pairs Maltese.

After a careful comparison of loft No. 1, Homers, and loft No. 2, crosses, I find the Homers are the more profitable.

One item in favor of the Homers is feed. For example, my fifty pairs Homers are doing well on five quarts of grain daily, while the fifty pairs of crosses take from eight to nine quarts.

The price of squabs in the Washington, D. C., market did not appeal to me. Three dollars a dozen for nine to ten-pound squabs in December did not sound right. So I began advertising by using a card headed with a picture of a pair of squabs in the nest, and reading as follows, the date and prices being written in ink:

We are pleased to quote you the following prices on SQUABS for the month of July, 1910:

Fresh dressed, per pair.....	\$0.75
Feathers on, per pair.....	.65
Live, per pair.....	.60

I mail these cards about the first of each month to a regular list, and to all who have not ordered by the middle of the month I send another card. I find it much better to vary the cut at the head of the card.

The three pairs which I bought of you in March, 1909, have done splendidly. I now have forty-five pairs working and a few youngsters. Have sold a good many, and we have eaten a great many. I have worked up a fine trade and now sell to the swell clubs in Portland at thirty-five cents each. They will take all I have. Enclosed find an order for thirteen pairs more of your Extra Homers. If these only do as well as the ones I got before, we will be satisfied. We simply cannot get along without the magazine. It is fine.—Mrs. W. R. Lycan, Oregon.

If grand opera were fifty cents a ticket the 400 would not attend. The higher squabs are priced, the more the rich want them, always provided the quality is there.



PLYMOUTH ROCK HOMERS IN MONTANA.

My pigeons are straight Homers raised from some I bought in Boston in 1904. I have a pair which raise squabs from eighteen to twenty-one ounces at four weeks. They are both 1909 birds. I have a rooster six months old from this pair that weighs 24½ ounces, crop empty.—James T. Fisher, Montana.

In January, 1910, I bought a few breeders of you, six pairs of Carneaux. I have a nice flock of one hundred mated pairs now (October, 1911), besides having sold all their produce since last May. I have been getting from \$4.50 to \$6.00 per dozen for them during the summer, the town I live near being quite a summer resort, and I had not breeding stock enough to supply the demand. Now the market is over for this season, and I must look further afield for an outlet. I notice in one of your books that you have requests from commission men asking you to send them the names of your customers so they can keep them posted on the price of squabs. Would esteem it a favor if you would advise some reliable commission houses to furnish me with quotations for the different grades of squabs. I am nearer Rochester and Toronto than other large cities, but I suppose distance is not much of an obstacle if reach the best market. My squabs will average about nine pounds to the dozen.—R. L. Ralls, Ontario.

I would like to buy ten Carneaux hens, as I have a surplus of cocks on hand and I would like to mate them up and have them working. The birds I have come from your place and I find they are very good. I do not want to buy the hens from any other, for I do not think there are any to be gotten as good as yours.—H. D. Marsden, Pennsylvania.

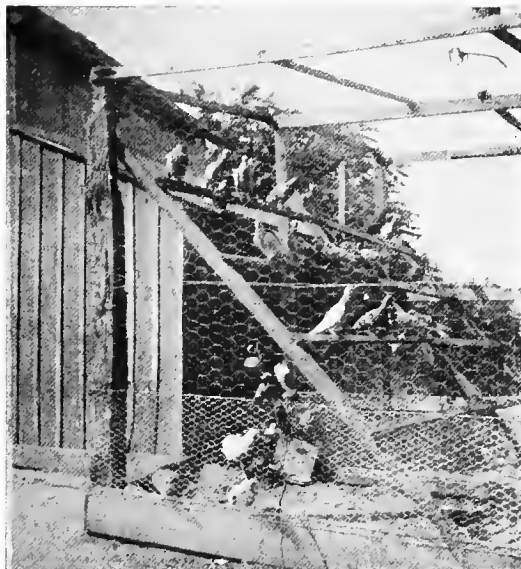

ALL RAISED FROM ONE PAIR.

It is just a year ago since I purchased six pairs of the Plymouth Rock Extra Homers and I had very successful results. I have at present (December 7) fifty mated pairs and have sold just 387 squabs, which brought me \$218.50. I find that my expenses were \$74.50, which leaves a profit of \$144. I find that the birds like the wood-fibre nappies better than any other sort of a nest. I also find that squabs are reared fifty per cent easier than chickens. Enclosed you will find picture of birds, seventeen of them, all reared from one pair of blue checkers.—George Briggs, Jr., Connecticut.

Last May I bought one hundred pairs of pigeons crossed between a Maltese and Runt, bought them at first sight on account of their size, but have found out since that they cannot deliver the goods like a Homer, and am very much dissatisfied with them. Thought you might be in a position to let me know where I might get rid of them, and if not, let me know the best advertising medium. They cost me five dollars a pair. As soon as I can unload them I will be in the market for two hundred pairs of your Plymouth Rock Homers.—F. J. Baker, Indiana.

I am glad to say that the twelve pairs of Homers you shipped me in March are doing fine and have increased to about seventy-five pairs (August 20, 1911).—William M. Wilson, North Carolina.

HOMERS ARE MOST RELIABLE FOR SQUABS, by Fred Fisber. I have close onto two hundred mated pairs of Homers. I am selling between \$35 and \$40 worth of squabs to San Francisco markets per month. Some people here are in favor of the Maltese and Runt pigeons crossed. To be sure they raise a large, fine squab, but in the moulting season they act like a poor chicken, taking from two to three months to moult, and at the same time they eat their heads off. This year in moulting season I did not notice it at all with my Homers, and shipped just as many squabs then each week as I am shipping now. The Homer is the squab breeder.

I feed in open troughs twice daily, about 9 a.m. and 2 p.m., giving each pen enough so they will have feed before them all the time. I feed my birds dry blood once a week with good results. I give each pen the top of a fruit jar filled with the dried blood, and the birds are very fond of it. It keeps them in good health and sharpens their appetites. I feed red wheat, kaffir corn, red oats, cracked corn, whole barley and cracked horse beans.

Enclosed find fifty dollars for which send me your Special Offer No. 5 at the earliest possible date, as I have a good summer trade here that I cannot supply. I want to get the birds started as soon as possible. You will no doubt pardon my delay in acknowledging the receipt of your **Manual**. I am positive that any one following your instructions is sure of success. If I could not get another book like it, you could not buy it for twenty times what I paid for it. Every one I have talked with has praised your Homers. The marketman told me that if I had Homers I could get a better price for my squabs. I am now receiving the highest market price for mine, which is three dollars a dozen, alive.—F. L. Thomas, California.

We would like to exchange some Carneaux raised from the two pairs gotten from you last June, with a friend who has some thorough-breds but he will want a guarantee that ours are the same. Will you send us proof of some kind to show him? From the four birds gotten just one year ago, we now have thirty-four in all, twenty-two of which are mated pairs. Don't you think that is doing well?—Mrs. J. H. Moynodier, Maryland.

I SELL SQUABS AT RE-TAIL IN MY TOWN, by Charles H. Marston. In November, 1907, I bought twenty-five pairs of Homer pigeons and like many others I thought that I had a bargain because I got them cheap, but there is where I learned something. They had not been well kept and did not do a thing all that winter but eat, and how they did that! It took some time to get them filled up, but about February 1, 1908, they began work and did finely all the year, so that at the end of that year I found they had paid their way and a little more.

Having weeded out some of the drones, I began the year 1910 with sixty pairs of mated birds and at the present time of writing (February 26) I have fifty-three pairs either with young or setting on eggs, making me think that the outlook for 1910 is pretty good.

From the very first I have been a believer that in every community there are some that will buy dressed squabs, and I have built up quite a trade in my town and the adjoining towns in this part of Massachusetts. I am very enthusiastic on squab raising, and am satisfied that there is money in it.

The Homers I received from you are doing splendidly. I have no trouble in getting squabs a month old to weigh a pound. I have a pair sixteen days old weighing fifteen ounces. I had a man offer me about ninety Homers for \$25, but I would hardly take them as a gift. The best his squabs weigh when four weeks old is between nine and ten ounces. Thank you for the good birds you sent me.—H. J. Read, Ontario.

Thought you might be interested to know how I made out with my Carneaux entries at the Suffolk County Fair for 1911: Solid red, first premium; red and white, first, second and third premiums; yellow and white, first, second and third premiums. All birds raised from Plymouth Rock stock. I won as many prizes as were allowed on my entries, so I have no kick coming.—Cadet H. Hand, New York.

The eleven pairs of Carneaux I received from you last October are doing well. I have one hundred and eighty or more birds now (September 15, 1911).—Dr. J. W. Cutler, California.



MR. MARSTON AND TRAINED HOMER.

We stocked up with twenty-five pairs of your Extras in 1909. We stocked up with Carneaux in 1910. In Carneaux and Homers we showed thirteen birds, six pairs and one odd bird. We won thirteen ribbons, \$12.50 in cash at the Virginia State Fair, 1910.—Frank W. Danner, Virginia.

I have been in the squab business raising your Extra Plymouth Rock Homers and Carneaux, but sold out and now I want to start in again. I have handled a great many of your birds and I have found that they prove satisfactory in every respect.—Arthur Newcomer, Pennsylvania.

Single men who do not make squabs pay should get married and let their wives show them how.

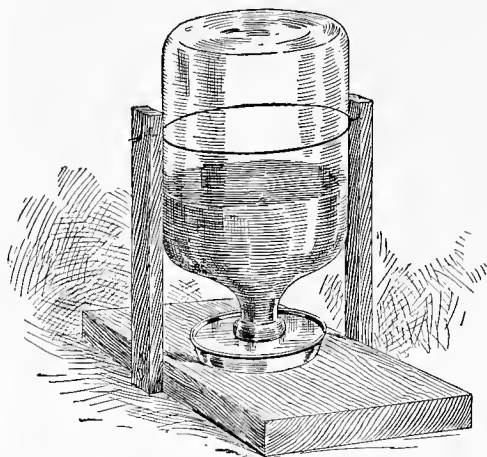

YOU CAN SEE THE WATER IN THIS FOUNTAIN.

KALE FOR MY BIRDS; FERN BRAKE FOR NESTS, by Mrs. W. R. Lycan. I bought three pairs of Plymouth Rock Extra Homers one year ago and have raised over seventy, lost very few. One pair has raised nine pairs and is sitting again. This, notwithstanding the fact that we have moved during this time and had them in a coop for several days and have never had a flying pen, just have them in an open-front chicken house about ten by fourteen feet. How's that? I have not arranged my plant as I want it yet. We bought us a small place (in Oregon) entirely unimproved, and it takes time and money to get things going right.

I feed kaffir corn, cracked corn, wheat, peas, stale bread and occasionally sunflower seed. I also find they are very fond of nice tender kale. Now and then I give them rice. I give my birds what is called "brake" out here (it is a kind of fern and very soft) for nesting material. They seem to like it better than straw.

I have just finished reading your \$1.00 **Manual** and find it absolutely the best work on the care and rearing of squabs that was ever written. Mr. Rice deserves much credit for the writing of this book. I have a few pairs of your Extra Plymouth Rock Homers and find them far superior in size, weight and vigor to any Homers I have ever seen.—R. L. Chipman, Washington.

A good man has good pigeons, and conversely, a tumble-down man with a rickety home has pigeons to match.

HOME-MADE FOUNTAIN, by Heyward R. Barret. I am sending you a drawing and the description of a swinging drinking fountain for pigeons which I have found to be very satisfactory. It can be made of a "Buffalo" lithia water bottle as well as a whiskey jug. As the top of the jug is larger than the pan the droppings can not fall into the water from a bird perched on top. The one illustrated is made of a glass whiskey jug which can be obtained most anywhere and holds from a gallon up. Cut two pieces of wire the same length and twist tightly around the jug, leaving the ends exactly opposite one another for axles. The pan should be about one and one-half inches deep, and the jug should be suspended one inch above the bottom of the pan. By making it out of a glass jug you can easily see when it is empty. Simply turn the jug up and fill it and let it drop in position, and it will supply water only as it is diminished from the drinking pan. Cost about ten cents.

Three friends of mine visited me Sunday, especially to see your Plymouth Rock Homers, and they were surprised to find such large, handsome and well marked Homers. My Philadelphia Homers are not in the same class with yours in any shape, manner or form and you can duplicate my order. I like to deal with honest, reliable people whom I am confidently sure are treating their customers right. I am going to build another unit to my plant this week and so I will be ready to put nothing but Plymouth Rock Homers in same. It will cost me \$10 for the unit. My Philadelphia birds are certainly picking up after feeding and watering according to your **Manual**, as I have not lost another squab in the shell. One pair brought out three squabs and are feeding them in fine shape. This same pair of birds lost five pairs of squabs in the shell until after I had worked according to your **Manual**. I thank you kindly for the fine birds sent me.—Frank J. Lyons, Ohio.

I have bought health grit of other houses nearer home but find my pigeons do not take to it like yours. I bought from you twelve pairs of Homers and now have nearly one hundred and fifty.—William M. Wilson, North Carolina.

I have some of your Plymouth Rock Extra Homers, and will say that there is no other stock known to me that can even compare with them.—John Overbrook, Illinois.

SQUABS FOR ME INSTEAD OF FANCY POULTRY, by W. H. Brown. I have had a stock of Extra Plymouth Rock Homers since January 1, and have been saving most of my squabs for breeders. I have sold some squabs and received thirty-five cents each for them. People say my squabs are the nicest they have ever seen. I have had calls for ten times as many squabs as I have raised; some one is wanting from two to a dozen every day. There are squabs to be had here (North Carolina), but none like mine. They sell for twenty-five cents each and weigh about six to eight ounces, while my squabs weigh twelve to sixteen ounces, so you can plainly see why the people are after mine. I have also had many calls for breeders, and hope some day to be able to fill them.

I have been raising fancy poultry for five years, and I find the pigeons have got the chickens skinned a country block. They are a great deal less care and more profit. The pigeons for me every time. I have plenty of room and can raise most of my feed, and intend making squabs my business.

I live two miles out of the city, and have been for the last four years with the largest retail grocery firm here, and in this way have learned all the best people, and how to deal with them. I am going to build a new squabhouse soon.

WHY I PREFER PINE NEEDLES FOR NESTS, by H. A. Rice. Nest material is indispensable to the squab breeders as well as to the chicken, turkey, duck and geese men. This we learn as one of our first lessons in the handling of all domestic fowls. When it has to be bought, we try to get the least expensive material, and usually that is the last real thought, so we hike after a bale of straw, cut it open and spread it out on the floor or in crates or nests, so the fowls can get at it. Now, everything goes well for a while, but by and by the day surely comes that we find the chicken and squabhouse is alive, yes, just crawling away, and so we have a job on hand. Here is the job: Take a pencil and paper and count the number of straws you put into the house for your birds (sure all fowls have lice more or less), count the number of lice eggs and lice in each (incubator) straw. Do not use straw. It is an incubator, and your birds the brooders. I have this winter experimented with pine needles, the foliage from pine and fir trees. The birds like it equal to the tobacco stems. I use alfalfa. The chaff or foliage is just the thing for your hens if cleaned and mixed with bran. Your pigeons will eat it if mixed with salt after it cools. (Do not give the salted to the hens, as it is sure death.) On page 349, December number of the Squab

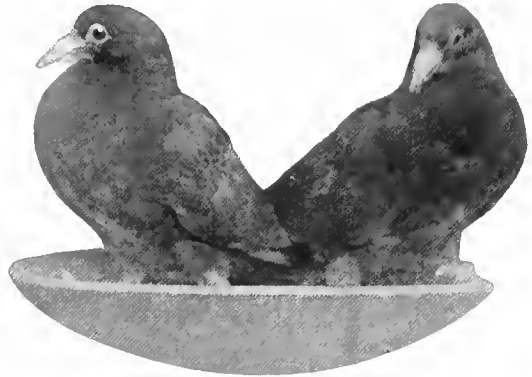

CARNEUX SQUABS SEVENTEEN OUNCES EACH.

Magazine Brother Newcomer says he feeds cabbage and lettuce as green feed. The lettuce is all right, but no cabbage for me. I have known of the finest fowls and birds and canaries to be killed by feeding cabbage. It bloats them just as it does cattle. (I once lost in that way, a cow for which I had paid \$60 in gold.) Often people ask me about feeding green food, and I always advise against the practice. If your birds have their liberty, then that is different.

I notice that oats and barley are not recommended for pigeons with squabs because the sharp points are supposed to cut the thin crops of the young. Do you suppose there would be any harm in feeding vetches mixed with oats? The farmers around here raise vetches and oats together, the oats to hold the vetches up, and when they are threshed together the two grains are mixed. I can get this mixture about harvest time quite cheap, about \$1 to \$1.25 a hundred. So if I could feed it, I should like to do it. The mixture is about two or three times vetches to one of oats. I should naturally suppose that if I gave the birds plenty of wheat and other grain they would have sense (or instinct) enough not to feed their squabs anything that would hurt them. I have been in the pigeon business about three years. Have now about 140 pairs, mostly Homers, with a sprinkling of Runts and Carneau, all doing nicely.—H. Denlinger, Oregon. Vetches are a first-class food for pigeons. Feed that mixture by all means, if you can get it at that price.

The breeder who is selling squabs at low prices is either ignorant or is himself low-priced and can be bought cheap on any proposition.



OSTRICHES AND WHITE HOMERS.

NO ADVANTAGE IN BREEDING CROSSES, by J. Wallace Williams. I do not raise any crosses. I believe in improving the thoroughbred Plymouth Rock Homers and Carneaux. I've never seen the advantage in crosses, if there's any. When you breed a first-class Carneau to a first-class Homer, where's the advantage? You get a freak pigeon. Let us improve the thoroughbreds. Plymouth Rock Homers for squab breeders are hard to beat. I put thirty pairs in each pen. Every month in the year you will find from sixty to one hundred eggs and squabs in each pen. Before writing this article, I counted in one pen of thirty pairs, fifty-six squabs, twenty-eight eggs and six new nests. What's the name of the freak pigeon that will come up to that record?

Squabs well sold are easily raised.

ARIZONA SQUABS AND OSTRICHES, by Francis Sbow. We have twelve hundred Homer pigeons here in Arizona. We have good birds in Arizona and plenty of good fanciers, but not many good squab breeders. The Salt River Valley can't be beat for poultry and pigeon climate. Squabs are a side line with us as we are in the ostrich business, and have over four hundred of them on this farm, and are now hatching more.

HOMER SQUABS SELL WELL IN MONTANA, by James T. Fisher. I have been raising pigeons on a city lot, and can't enlarge very much. I have a good market here. (Montana.) I get from thirty-five to fifty cents each for all I can raise. I have only eighty-one pairs of breeders, from which I sold thirty-nine squabs in December and forty-two in January. I also have one hundred and twenty young, which are mating up now. The smallest squab I raised in the last three months weighed eleven ounces. There were only two under twelve ounces. They will average thirteen and fourteen ounces dressed. I have one (a Homer) that weighed twenty-two ounces alive at four weeks. This is the largest I have ever raised. I have raised several that weighed eighteen and nineteen ounces. I bought my stock of Homers in 1904 from the Plymouth Rock Squab Company. I feed mostly wheat, whole corn, millet and hempseed. I mix salt, grit, charcoal and a little alum together and

keep before them all the time. I burn and grind bones for them in place of oyster shell. I clean my houses every week and spray with carbolic every other week. I have lost but one squab in three months with canker.

The eight pigeons I bought of you nearly three years ago have increased greatly. I have 214 mated pairs and I am making a nice profit on them.—Ward Edwards, Texas.

Percy Perkins likes to write letters asking for information about his pigeons. It takes more time than studying the birds, but he gets a splendid collection of opinions.

Pigeons for breeding or squabs for eating cannot be sold by advertising where nobody exists. Get into the marketplace, not the cemetery.

HOW TO BLEED SQUABS NEATLY, QUICKLY, by W. E. Blaklee. When killing squabs, this device will be found useful. It is a rack of funnels made of tin, open at top and bottom. Hold the squab in the left hand, stick it with the killing knife and put it in one of the funnels, head hanging down through the lower hole. The object is to drain out the blood. This does away with the necessity of hanging the feet from a string, and prevents spattering of blood. The live squab may be put in the funnel head down and out and then stuck, if preferred. This is the method used in Europe by the quail marketmen. These quail are caught in Egypt in nets and transported alive to London, where they are fattened for a few days and then killed. All of the marketmen have the same method of using this rack of funnels, their racks being from eight to ten feet long. London consumes these quail by the hundreds of thousands. The traffic is an old one and this funnel method of bleeding is thoroughly practical, needed by fast workmen.

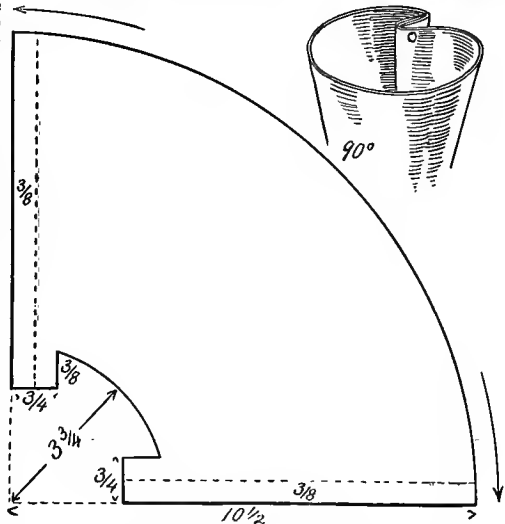
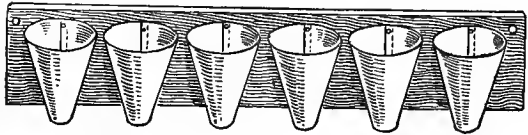

FUNNELS TO BLEED SQUABS.

How to cut the tin, make seam and bend. One wire nail fastens each funnel to board.

HOW CLEVELAND SQUAB PRICES WENT UP, by Mrs. Carl Moeller. From December 31, 1909, to December 31, 1910, our thirty pairs of breeders averaged eight pairs of squabs. No pair went below fourteen squabs and one or two pairs had the first pair of eggs December 31, 1909, and the tenth pair of eggs December 31, 1910. As these were Homers, it seems very good to us. This average is of squabs sold or raised to maturity. Others do not count. One year ago this month, nine-pound squabs, alive or dressed, were bringing at the most two dollars a dozen. Wholesalers in Cleveland were actually insulted if you asked them to buy by weight. They simply refused to talk business if you mentioned price and weight together. Five-and-six-pound-per-dozen squabs brought just as good a price as the larger ones. In March, 1910, prices began to go up. We found a dealer who knew a good squab from a cull and would pay by weight. We sell all our squabs to this one dealer and receive a steady price the year around. At wholesale nine and ten-pound squabs are now bringing \$3.00 and \$3.50 a dozen dressed. They may go to \$4.50. Cleveland is fast creating an appetite for squabs and all we need to make things boom is a union of all squab breeders in and around Cleveland.

and then some good live advertising that greater Cleveland may know what squabs are, where to get them and how to eat them.

About two years ago I purchased three pairs of your Extra Plymouth Rock Homers and two pairs alone have increased to about fifty-five by now (the other pair having flown away when I released them about three months after I received them). I am very enthusiastic about the raising of squabs and in order to have even pairs and also to introduce new blood, I wish to purchase about ten females. My males have increased more than the females so that I need about this many to even up. I desire the Extras. At present I am enlarging my unit house and in the near future expect to increase my flock to at least five hundred pairs.—W. M. James, Ohio.



MALE AND FEMALE PIGEON BILLING, OR KISSING.

HOW I LEARNED TRUE CALIFORNIA PRICES, by Stefan Schwarz. In the leading San Francisco daily papers, squabs are quoted at \$2 and \$3 a dozen at present (May 29, 1911). Everybody knows that squabs are numerous at this time of year, and that competition is active. Circumstances did not encourage me. Anyway I did not expect a very ready demand, or good prices either. I am breeding a flock of several hundred pairs of Plymouth Rock Extra Homers.

I asked my grain man for the address of a commission house, and he sent me to a big one of first-class reputation. Who can describe my great surprise as one of the members of the firm told me: "I will take all the squabs that you will ship to me and I am ready to make a contract with you for one thousand dozen squabs a year, for which I will pay you \$3.50 for Homer squabs weighing ten to twelve pounds, and \$4.50 for Carneaux squabs weighing fourteen to sixteen pounds."

It is a puzzle to me how my fellow squab raisers in California can afford to go so much below these quotations just mentioned, unless they ship squabs which weigh considerably less, or are fooled by the newspaper quotations, as I nearly was.

Squab buyers must buy squabs. Squab breeders alone can furnish squabs. It is the business of the seller and not the buyer to make the price.

HOW I LEARNED TO GET GOOD PRICES, by A. J. McCauley. I sold all of the Plymouth Rock Extra Homer squabs I raised in eleven months to a marketman in St. Louis, Mo., for prices ranging from \$3.25 to \$4.80 a dozen. I started in to ship to the market people in December, 1909, and until January 21, 1910, received \$3.60 a dozen; from then until February 25 I succeeded in getting \$4.20 a dozen. I again wrote them to advance the price as I had been offered more elsewhere. The price was then advanced to \$4.80 a dozen. This price lasted until April 10, when they tumbled to \$4.50 a dozen, then in the same month they cut them to \$4. In May they cut them to \$3.60. In June they cut them to \$3.50. From July until November, when I quit shipping to them, I was getting only \$3.25. At this time I wrote them to know if it wasn't about time for squabs to start to advance in price. The answer I got was quite an eye opener for me, for they said that they had been putting squabs in cold storage all summer and that they had quite a lot of birds on hand that

they had bought reasonable and consequently could not pay any more for them just at that time. I at once got busy with other buyers in Chicago where I received \$4 for eight-pound squabs and \$4.25 for nine-pound birds. At present I am shipping my birds alive for \$4 a dozen to a place near Chicago. I am putting forth every effort to be able to gather a lot of squabs through the months of February and March, when I hope to get \$4.80 or \$5 a dozen; then I expect to be able to ship squabs by the barrel next summer and will either ship East or store them until the prices advance.

Some people are dead set against whole corn because it is so big, and claim it chokes the squabs, but I notice when I feed cracked corn and whole corn together, they always pick out the whole corn. The females seem to like it when they are on eggs especially. One reason I feed whole corn is because the cracked corn gets sour in the least dampness, and soon I see sick birds. A breeder about two miles from my place buys squabs and he told me the other day that he got \$4.50 per dozen himself. I went down a few weeks after and he offered to buy fairly good squabs at thirty cents each, or \$3.60 per dozen, netting him a profit of ninety cents on every dozen. I take the magazine and it certainly is a beauty.—P. E. Foster, Massachusetts.

All squabs are good, but some are better.

HUNGRY CALL FOR SQUABS IN MONTANA, by W. M. Safley. We started in the squab business in May, 1908, with two hundred of Plymouth Rock Extra Homers. We have sold squabs most of the time since, but have saved four hundred, of which about two hundred and fifty are at work. We have sold about forty-five dozen squabs since June 1, 1909. There is no trouble about the market here in Montana. We have quarters for one thousand birds and expect soon to fill the houses. I am in the business to stay. We are at present getting \$3.50 per dozen for squabs unsorted, plucked, F. O. B. We ship to Helena, only thirty-three miles, so have never used ice to pack in. We use peach crates mostly, packing two dozen in a crate, but will use the corrugated boxes as soon as we can. The young shoots of grease wood are our nest material.



EFFECT OF MONTANA APRIL SNOW.

Four pens after a snow on April 13, 1909. The snow was all melted before noon. Photograph from W. M. Safley.

HOW THE MARKET RUNS AFTER SQUABS, by John E. Gilbert. About six years ago I began to look into the squab business from a straight business viewpoint. All I knew about the business was what I read and after reading I got to thinking. I first wondered whether I could sell all the squabs I raised. I often had read about the large hotels using thousands of squabs a week, so I ventured to go to several hotels in Philadelphia, the Bellevue-Stratford, Bingham and Walton, and each chef in charge told me he could use all the squabs I could bring him, but they had to be prime, large ones. There was an old breeder who served the Bingham Hotel regularly every week, but with hotels you must have quantity as well as quality.

As an ordinary person cannot comprehend the demand for squabs I will say that when hotels and other large institutions cannot be supplied by the breeder himself, they turn to the commission men, who have hundreds of shipments daily from all parts of the country within a radius of five hundred miles. Commission men take any quantity, small or large, and can be better relied upon by the hotels because of the large army of squab breeding shippers pouring squabs into one firm. If a breeder cared, he could increase his flock large enough to supply the trade direct, and make a good deal more on his squabs.

Every person without doubt has wondered whether he really could sell the squabs he could raise, and whether there really is a big demand for squabs. It is positively a truthful fact that the demand for squabs is equal in some sections to the demand for eggs, although this may not seem so to many, when you think how many people eat eggs. You never have

heard of squabs being seized from dealers by the United States food experts and destroyed as you have very often heard about eggs. The fact is, there is at times an over-production of eggs. The demand for squabs everywhere cannot at present be supplied, and will not be supplied for some years to come.

In many localities it is not necessary to ship squabs now, as commission men have buyers in all parts of the country to take the squabs right at your place, and pay you cash. There is more competition in buying squabs than one would imagine, as each dealer has his trade to supply and must have the squabs. When commission men will send out their men to visit the squab plants to get the goods direct, and have your assurance that you will let them have your squabs, this should be confidence enough to cause any one to enter the squab business.

HOW TO KNIFE A SQUAB WITHOUT PAIN, by F. J. Bunce. In killing squabs, by inserting the knife well back in the throat, the picker will come in contact with a little, hard lump, which is the brain cell. The knife should be drawn sharply through the brain and up toward the point of the bill.

It is always possible to tell if the sticking has been done properly. If it has, a convulsive shudder will pass over the bird, the wings draw back and the eyes become set, but if the bird continues to kick and gasp for breath, the sticking has not been done correctly. If the sticking is right, the bird should be perfectly dead in two minutes. If the bird does not die as fast as the picker thinks it should, another quick incision should be made. This as a rule will be sufficient.

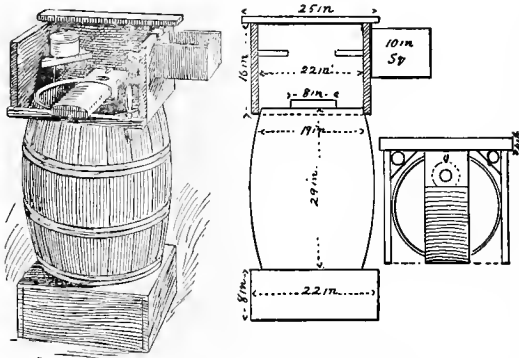

MR. TROXEL'S SQUAB KILLING CHUTE.

I CAN SELL 100 DOZEN DAILY IN OREGON, by Louis A. Hart. The squab market here is quoted in the papers at \$2.50 per dozen, but I just ignore that price and go to Mr. Hotel Man and engage my pound birds at \$5.50 and the nine pound to the dozen birds at \$4.50. I find the market firm and demand, well, say, I guess I could sell one hundred dozen every day if I only had them. Only you who are near New York city can appreciate the position that I am in, for it surely looks good to me. The staple grain is wheat, although some corn and barley are raised. I am located close to a broom factory, so for nesting material I use the refuse broom straws, with all the dead twigs I can find.

HOW I TEST EGGS THROUGH A STRAW HAT, by H. A. Davis. For an egg tester, I use a straw hat draped with black cloth that draws together with a string at the bottom around my shoulders. This is practically a small dark room for one's head, except for a small hole opposite the eye through which the egg to be tested is seen when held to the light. The egg is held close to the hole to shut out all light, and it is surprising how easy it is to tell whether the egg is fertile or not. When we pass through the pen to test, we glance at the date the egg should hatch, and reckon back ten days. Thus we are testing an egg about eight days old, and we have gained more than ten days more than once, by testing, which only takes a few minutes. We like to record on the sticker the date the egg should hatch rather than the date it was laid. We find our birds will drink from the bathpan but since we have whitewashed the bathpans once a week in summer, their bowels are in better condition than before. We put a piece of rock lime about the size of a hickory nut in each drinking fountain also.

EXPERT TELLS HOW TO KILL AND PLUCK, by Clinton L. Troxel. Being a poultry dresser long enough to dress more than forty thousand chickens, I will give you a good idea how to dry-pick squabs. They look better than when scalded. It is also much quicker. One can be killed, dressed and drawn in less than five minutes. I dress them upon a barrel. (This is fixed in a manner known to poultry dressers as a chute.) The way it is made is to take a barrel and place it upon a box one foot high. This makes the barrel the right height. Place another box, which may be about two feet square, with the top, bottom and end removed, upon the barrel. This leaves the remaining three sides to form a shield around your squab, which keeps the feathers from dropping upon the floor. They

will drop into the barrel, where they can be saved, then sold.

Over the center of the barrel is a board eight inches wide, which is used to lay the squab upon while dressing. This board is padded so as not to bruise the squab. At far end of the board is a hole two inches round. Below this hole a cup is placed so that the blood cannot drop upon the feathers. At the other side of the hole a sharp hook is set.

Place the bill over the hook, hold the feet, and tip the wings in the left hand. Insert a sharp-pointed knife in front of the eye, upward into the brain. Bleed from the side of the throat; sticking in this way causes the squab to give up its feathers more easily, and at same time it also loses its feeling.

One would be surprised to see how quickly and easily a squab can be dressed. The tail, wings, entrails and head can be placed in a pail which hangs near.

In front right-hand corner, a small shelf is used to support a lamp for night work. In front left-hand corner is another shelf upon which is a cup of water in which to moisten the fingers.

After dressing, draw and remove the head, singe and put into pan of cold water for four or five hours. Add pinch of salt to the water.

I have no trouble in disposing of my squabs after dressing like above. We find in this locality, with prices high on feed, that it costs \$1.25 per pair per year. Our birds average about five pairs squabs per year. We get twenty-five cents each alive for them. This gives us a profit of \$1.25 on each pair a year after paying above amount for feed.

Did you ever see a drunken pigeon raiser? Rum and squabs don't mix. There is no such thing as a squab plant with a whiskey bottle hid in the grain bin.

HOSPITAL, CLUB, FAMILIES, \$3.50 DOZEN, by Westley O'Harra. I have never shipped any squabs as I have hard work supplying the home market (Ohio). We have a large new private hospital, which takes five dozen a week. The first club of the city takes ten or twelve dozen just as I happen to have them. Then with the family trade I can dispose of all and more than I can supply. I am thinking of enlarging my plant soon. I get \$3.50 a dozen the year round without sorting, feather dressed.

I do not believe in starting with a small number and breeding up your own flock. I tried that for a year without selling any squabs, then bought a large flock of Extra Plymouth Rock Homers and began to get results. One thing I accomplished that first year was proper feeding, which I wish to say is the most essential point to the best results in this business. Do not be afraid to give them plenty to eat. I use the self-feeders, which I keep filled with plenty of cracked corn and red wheat. I have always had good results with these boxes. If any feedbox is not successful, it generally is due to the fact that it is not kept free of the dust which accumulates in the slit where the grain falls through. I sift all of my corn and wheat and clean my feed boxes once a week, give my birds plenty of good, fresh drinking water, with bath water twice a week. I have found that straw is a good lice producer and that the only way to stop the lice is to use tobacco stems for nest material.

HOW TO HANDLE TWO KINDS OF BUYERS, by Arthur S. Burlingame. Selling squabs direct to consumers no doubt will bring in the most money, but all people cannot look after a retail trade, as it takes considerably more time. One can get good prices, however, by grading his squabs according to weight. A breeder of squabs ought to have a price for his birds in proportion to their weight by the dozen. A squab that weighs a pound surely ought to be worth more than one weighing twelve ounces. I have about forty pairs of Plymouth Rock Homers and very often get squabs that weigh sixteen to twenty ounces each, and never have had any less than twelve ounces at four weeks old. When I started to sell my squabs, I sold them to a large market and received twenty-five cents each, and sometimes thirty cents, according to their supply and demand. I tried to get more for the larger ones, but they would not pay any more. They told me a squab was a squab, and that they sold them all for the same price. They had them marked on the poultry counter at forty-five cents each. Not satisfied with these prices, I looked around and found a



MR. O'HARRA'S SQUAB FARM.

smaller market that sold to a more particular trade, and this one wanted squabs that weighed twelve or thirteen pounds to the dozen. For the first lot I took there I received thirty-five cents each, and have worked the price up to forty cents. I think they sell them to their trade at about fifty-five or sixty cents each. This still left me the ten and eleven-pounds-to-the-dozen birds, which are very good sizes. I went to a good hotel and asked if they used squabs, and they said they used them all the year and would like any that I might bring in, provided they weighed from ten to eleven pounds to the dozen, just the ones I wanted to sell. I quoted thirty-five cents each, and they were willing to pay that. They list on their menu, "Native Squab 75c." I simply have to kill the birds. I made a machine according to instructions in Rice's **Manual** and it is all right. I catch the squabs after dark and kill them in the morning and let them hang in a cool place and take them to market the next morning. I would rather kill a dozen or more squabs than to kill one chicken. It is much more simple and very much cleaner.

My squabs weighing from nine to ten pounds I turn into the first market at \$3 to \$3.60 a dozen. They seem satisfied and I am.

Don't sell your largest birds in the same lot with the smallest sizes, unless they pay you more. You can find several places where the trade calls for the smaller sizes, and others who want the better birds. You can keep all satisfied and hold their trade. I would not put in the large birds (in case your purchaser of that size was overstocked) with the smaller ones. If you do, they will expect to get them all the time. Eat them yourself.

I have not found much of a demand for squabs weighing from one and a half to two pounds.

Always make your deals with the owner of the place; he is the man. Show him what you have and he will appreciate quality.



RED CARNEAU. SPLASHED CARNEAU.

HOW TO PATCH AND HATCH BROKEN EGGS, by M. C. Martin. One who deals in high-priced pigeons can by hatching out the broken eggs save many dollars. Infertile eggs should be saved for patching the cracked or broken eggs. In warm weather place these in a small box in the squabhouse. In the winter keep some "fresh" infertile eggs where they will not freeze, and whenever you find a "good" egg that is cracked or broken, select an infertile egg of similar size. If the egg is broken on an end, take an end half of the infertile egg and place it over the egg to be patched, and if the fit is a good one put the egg back in the nest and as soon as the shell lining is dry, it will fit like glue to the "good" egg. If an egg is broken on the side, break the shell of the infertile egg lengthwise and patch the egg as above directed.

Unless a good round, sound shell covers the egg, the two will roll together in the nest and the broken or "dented" shell will soon be broken in by the other egg, hence the reason for patching the egg. Of course if the membrane of the egg is broken, there is no remedy, but this is very seldom the case, and the patching can be done very quickly as this is a very simple method.

I have a flock of 175 Homers and am getting \$4 a dozen for my squabs. I ship them to Charlotte.—J. Paul Leonard, North Carolina.

HOW A PRACTICAL IOWA PLANT IS RUN, by P. P. French, M.D. From what experience I have had with a number of different varieties of pigeons, it is my opinion that a good Homer is hard to beat for squab purposes. By keeping our birds in large pens, it reduces the labor of taking care of them to a minimum. We try to keep the flock as nearly mated as possible. We know they were mated in the first place, and when an old bird dies it is an easy matter to break it open and see whether it is a male or female and then replace it from our small pen with one of the same sex. That method comes the nearest to keeping a flock mated of any I know, keeping the birds in large pens as we do, and while it is not a perfect method, I consider it good enough for all practical purposes, and does away with a lot of time spent in banding, numbering and recording. I tried that method when I first started in the business, but soon gave it up and adopted the other method, and have been just as well satisfied with the results. Again by keeping a large number of birds in a pen it is possible for one man to take care

of ten thousand birds, except picking the squabs, and I believe in having the same man take care of the birds all the time if possible, because they very much object to having strangers around.

Regarding prices I can say that we ship our squabs to Chicago, and last year (1910) they averaged us thirty-two cents apiece net the year round, leaving us a profit of over a dollar a pair for our flock, and by that I mean all expenses for feed, etc., except the work.

I go to Chicago in the spring and fall and sell our entire output of squabs for the succeeding six months at a contract price, and by so doing we know just where we are at all the time, and do not have to feel that we are getting stung by sharp buyers, as the element of doubt is removed.

I am getting for squabs dressed: 1 pound, \$6.00 per dozen; 14 ounces, \$5.50 per dozen; 12 ounces, \$5.00 per dozen; 10 ounces, \$4.50 per dozen. I sell nothing less than ten ounces and have fair luck with my birds, my prices and squabs. My squabs advertise themselves.—Albert H. Gerling, Illinois.

Question: Do you believe in pulling out the tail feathers of young pigeons, to help them grow? **Answer:** No, it is unsightly, and unnecessary. Let Nature attend to this matter in her own way.

GOOD SQUABS SHOULD BE SHIPPED RIGHT, by B. F. Babcock. Shipment of September 23, 1909.

1/2 dozen 10-pound squabs.. \$2.13
2 dozen 9-pound squabs.. 7.00
1/2 dozen 8-pound squabs.. 1.40
\$10.53

The above is a statement of a shipment of Plymouth Rock Homersquabs that I have made lately to a New York commission merchant and shows the actual cash received by me. The following is a copy of part of the letter received from the commission merchant, under shipment of October 14:

"We received from you this week a shipment of squabs for which we are enclosing check and account sales. Your birds were very fine and hope that you will continue to send us your output."

In making the above two shipments no pick of birds was made, taking the birds of killable age from each pen. But in the following matters I was particular (and it is the only way to be a successful shipper):

A clean box, clean paper, clean ice, clean birds, clean mouths, and clean feet, and to make the shipment more attractive when the box is opened, is to wrap the heads in tissue paper. No one will ever regret following the above particulars. I have a nice printed card which is tacked on the lid of the box.

ENORMOUS DEMAND NOW IN CALIFORNIA, by

William J. Reid. I have made a canvass of the local market conditions and find the following state of affairs: Several commission men inform me that they cannot supply the demand, particularly during the last year; that small, common squabs, "rejects," weighing six and seven pounds, find ready sale at \$3.50 and \$4.00 a dozen; that Homers are very scarce, those that can be obtained being easily disposed of at \$4.50 and \$5.50 a dozen, *alive*. From these figures the commission men deduct eight per cent for handling. In Oakland, I bought a pair of dressed Homer squabs, medium sized, for which I paid \$1.30. Broiled, they were enjoyed very much by Mrs. Reid and myself. The marketman stated that he can handle all the choice Homers brought to him, at good prices, according to weight; would pay \$4.50 and \$5.50 a dozen. At the California Market (retail) the poultryman told me he would pay \$4.50 a dozen for all the

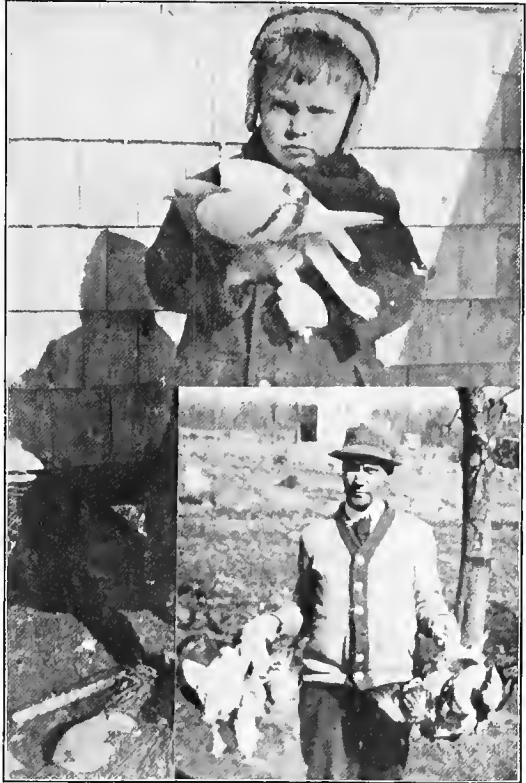

A PIGEON AND TWO BUNCHES OF SQUABS.

Homer squabs I could bring him, regardless of weight. All the dealers agree that this is not a temporary condition, but that the demand is increasing faster than the supply, and it seems to me that the forthcoming World's Fair will not hurt the business.

A year and a half ago I purchased from the Plymouth Rock Squab Co. eight pairs of Carneaux. I now (June, 1911) have over three hundred of all ages, of which some eighty pairs are mated.—Percy A. Bath, Ontario.

The difference between success and failure in the squab business is the difference between work and hot air.



A COMBINATION CHICKEN AND SQUAB HOUSE IN OREGON.
This plant was started with \$100 borrowed money and was a success from the start.

HOW TO PUSH AND HOW TO COOK SQUABS, by Fred M. Parkeson.

I have seen people pay seventy-five and eighty cents for a chicken in the markets here that could not begin to furnish as much meat as a pair of my four-weeks-old Plymouth Rock Homers, not mentioning the difference in the quality of the meat. Yet if you or I asked them why they did not try the squabs instead of the chicken they would say: "Well, I don't know how to cook them." I dare say that every eight out of ten housekeepers in this State have never cooked a squab. Now the question arises, why? I can answer it. Every morning excepting Sundays there are pedlars going from house to house here in San Francisco selling fruits, vegetables, rabbits, eggs, butter and even live chickens. But I have yet to see for the first time any one going to the homes to sell squabs. There seems to be a mistaken idea that the working class of people cannot afford to buy squabs, and that squabs are for the rich only, but such is not the case, as can easily be proven by the way that the working class buys other high-priced articles of food in general.

I wish that I were so situated that I could put in a stock of five hundred pairs of Plymouth Rock Homers, I would not hesitate so far as paying me a nice profit is concerned. I wish to offer a recipe for cooking squabs. This recipe has been prepared exclusively by Mr. Victor Hirtzler, chef of the St. Francis Hotel, San Francisco, California:

Squab en Casserole

Squab, or a small bird of any kind, is very good cooked in a casserole. Have the squab cleaned, then dust ever so lightly with flour and put into the casserole with a piece of butter the size of an egg. Cook for twenty minutes, then add one small tender onion, cut fine, three or four mushrooms and a little chopped celery which has been parboiled in salted water. Let this bake together for ten minutes then add half a cup of strained brown gravy and two spoonfuls of sherry. Let simmer for ten minutes until the squab is tender. It should be very tender when done. Place a napkin neatly about your baking dish and serve hot. Brown gravy is made by browning two spoonfuls of butter in an iron pan until it is at an even color. Stir all the time. Then add two cups of hot water and a spoonful of beet extract and simmer for half an hour. Salt and strain. You will find this to be one of the most delicious dishes you ever tasted.

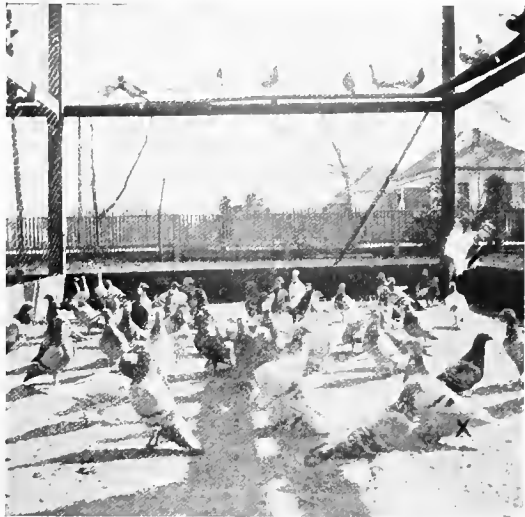

PLYMOUTH ROCK HOMERS IN TEXAS.

The two marked with an X are a prize pair of silvers.

TRY ROASTED SQUABS LIKE THIS.

Prepare much the same as you would chickens. Scald, pluck and clean, tie their wings against the body, place in baking pan on backs, put quarter-inch hot water in pan, place on bottom of hot oven and cook slowly thirty minutes, then baste and put another baking pan over them and put on grate in oven for one hour, basting occasionally while cooking. Remember a slow fire is better than a hot one, and the oftener basted the better, but do not cool oven opening too frequently. Cooked in this way, you have a dish fit for kings. None of the thin parts are burned and bitter. The flesh leaves the bones freely. The wings, legs and small muscles on the back are all good, delicious. After trying them this way, you will find you can afford them much oftener than you thought you could, as there is more meat on the legs, wings and thin parts than you ever thought there was, when served broiled. Avoid squabs of the common pigeon. Secure good, fat, genuine Plymouth Rock squabs and prepare as above, and you will always want more and consider them cheap at any price.

I started three years ago with thirty-six Plymouth Rock Homers. I have now nineteen units on Mr. Rice's plan, and have between 1200 and 1500 birds.—W. C. Hyer, South Carolina.



BACK YARD SQUAB BREEDING.

Showing that squabhouses in the rear of a city home may be made attractive and interesting. A very satisfactory business of considerable magnitude has been built up here. For particulars, see the accompanying article.

WHAT WE HAVE DONE WITH SIX PAIRS, by Columbus Nelson. We started here in the State of Washington two years ago with six pairs of Plymouth Rock Homers. From these we now have over two hundred mated pairs of breeders. We sell the squabs in Anacortes at a good figure. Besides saving a number of pairs of breeders during March, over \$20 worth of squabs were sold to local fanciers and eager consumers. Ours is the only plant of the kind, so far as we know, in Skagit County. In connection with squabs, my wife and I make a specialty of thoroughbred buff and white Orpingtons and Pekin ducks. We expect to enlarge our plant to two thousand mated pairs of Homers, and then will devote our entire time and our five-acre tract to the raising of squabs for the city markets. We declare, after much work, careful study and experiment, that the business will be a complete success.

To break up floor nesting, first let the male and female build the nest and as soon as she has laid the first egg, take her and her egg and nest and put her in a nestbox. Put on a wire door so she cannot get out. The door must be taken away at night, so she will not see you. You will not have any more trouble with them. I have been raising pigeons since September, 1908, and have one hundred pairs of Homers and Carneaux. I send my squabs to New York, where I receive the top price.—**Walter Hudson, Connecticut.**

HOW I PUSH SQUABS ALONG IN TACOMA, by

Adam Sossong. I started with one dozen common pigeons about two years ago to see how it would pay raising squabs for market. I raised one dozen squabs from the commons, took them to the Tacoma Hotel. The first question asked was, are they Homer squabs? I had to tell him, no. The answer he gave me was to get Homers and he would buy the squabs at all times. So I came to think that I would sell the commons and buy Homers. I bought two dozen. As soon as I glanced over Mr. Rice's **Manual**, I saw some mistakes on my coops and nests. I took the book, read it over carefully and followed his directions up to the mark. I did not have any more trouble selling my squabs, and got more customers in a short time. At present I have four hundred pairs of Homer squab breeders, which are doing their best and raising fine squabs. I do all my selling to hotels and high-class fraternity clubs. My squabhouses are in my back yard. (See photograph.) I praise soaked wheat bread which I give to

my birds twice a week, all that they will eat, and green vegetables such as lettuce, clover and cabbage. I will give you the prices on all the feed. Wheat is \$2.35, peas \$4, kaffir corn \$3.50, millet \$3, scratch food \$2.35, hemp \$7, flaxseed \$4, buckwheat \$6.

The prices for squabs are from \$3.75 to \$4.50; if you supply good squabs, you get top prices, for there is always a big demand. There are lots of markets here that would buy squabs if they could get them and enough of them to keep the trade. I don't bother with any markets. I have my steady weekly customers. I dress all my squabs and get top prices. I get letters from Seattle for squabs so I am not worried about not having a sale. I am going to get a few acres next fall and then I will put in a large stock of breeders. The more Tacoma is growing the better squab sales there will be. Take my advice and get interested in raising squabs.

I was troubled by three and four weeks old squabs leaving the nests, especially those close to floor. I have begun to wire each in with two-inch poultry wire, tacking a six-inch piece of lath on to the front for a perch, so that parents may alight there and feed them through the wire. Most parents feed them O. K. I have had a few that seemed to be allowed to starve to death.—**E. S. Riggs, Missouri.**

Keep your squabhouses clean, and neat looking; that is, if you wish to interest visitors.

FROM A FLAT TO SQUABS IN THE COUNTRY, by Laura A. Pierson. A year ago I became interested in the subject of squab raising through a magazine article, and determined to inform myself with a view to engaging in the business. I accordingly sent for the "National Standard Squab Book" and read it through. At that time we were living in a suburban flat, but contemplated moving to our present location, which we did in the spring of 1909.

There is a barn on the lot, the loft of which we fixed for pigeons, the lower floor for chickens. We built flies to the south and have a nice chicken-run to the east. The chickens are simply to supply our own table, although we have a surplus of eggs, and have enjoyed the sale of some at the extremely high prices the past winter. The flock of pigeons we intend to increase as rapidly as possible and concentrate on as a business.

Last August we received thirteen pairs of Plymouth Rock Extra Homers. The birds settled down very promptly and have worked well. We now feel that we are sufficiently experienced to handle a larger flock and are fixing our quarters for more birds. We have ordered one hundred pairs more.

WHAT I AM DOING WITH A SMALL FLOCK, by Walter Sieverling. Six months ago I ordered three pairs of Plymouth Rock Extra Homers. They arrived in good condition and in a week they had eggs. I fed them the best that could be bought and they repaid me with fine, big, fat squabs. It was very funny to see them claim their nests. I had other Homers in the house at the time but in the end the new Homers were the winners. They were larger and could handle my birds like babies. I have nine pairs working now and in May I had nine pairs of eggs in the nests. The day the first pair hatched out the last pair laid their eggs. They all hatched and I had eighteen squabs all of good size. The largest I had was a pair of red checks which weighed, one twenty ounces, and the other twenty-two.

In order to raise good-sized birds, cull your squabs when they leave the nest and after they develop.

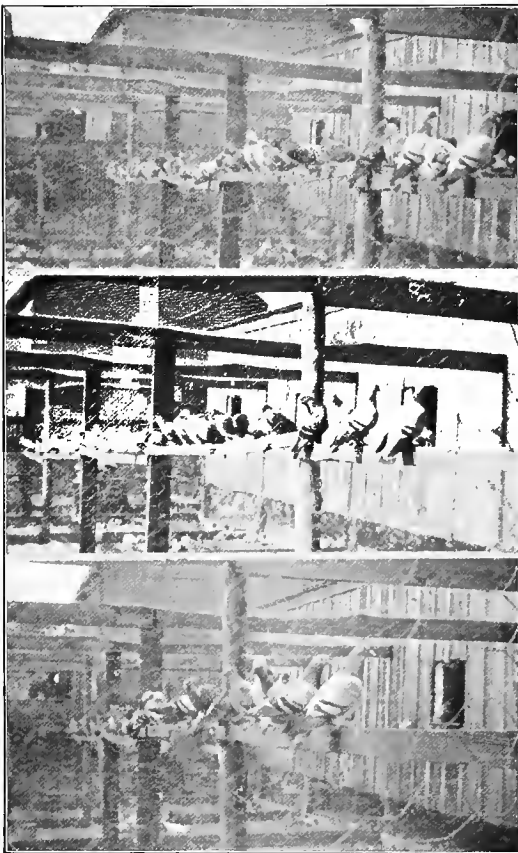

NOTE SIZE OF THESE EXTRA PLYMOUTH ROCK HOMERS.

One of the Chicago houses has contracts with a squab raiser paying \$2.50 for six-pound squabs, \$3.00 for seven-pound squabs, \$3.50 for eight-pound squabs and \$4.00 for nine-pound squabs. One man in Iowa has six thousand old birds and has a yearly contract with this house.—H. Huecker, Illinois.

Don't ship to a wholesaler unless you are wholesaling. If you want retail prices, go and get them according to the directions given in the Squab Magazine.

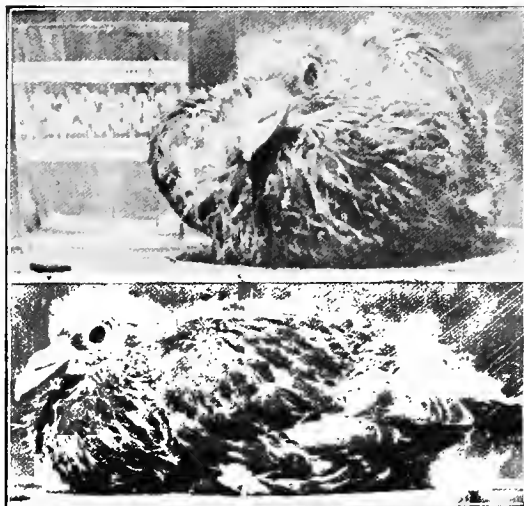

PLYMOUTH ROCK CARNEAU SQUAB.

Weight one pound, age three weeks. Two views of the same squab. In the upper picture the squab is compared with an ordinary glass tumbler, to show size.

HOW MY BIRDS GET NESTING MATERIAL, by Harvey Drake. The usual way is to use crates to hold the material, but what the birds pull out and do not want they throw or drop down until they find what they do want. I have found a way to overcome this. Take a box about one and one-half feet deep, one foot wide and three or four feet long and put it under the window. Then take a board a little larger than the box you use and fasten it to the window for a sill inside like a shelf. This protects the nesting material from being soiled by birds sitting on the window sill, also if a shower of rain comes up in summer when the windows are up, the material is protected. I put the nesting material I use in the box and do not fill it more than one-third full. The birds fly down in this and pick it over until they find what they want, and then fly to their nesting place.

A year ago in May I bought five hundred pigeons of the Homer variety and lately I have bought two hundred and fifty pairs more. I am greatly interested and have been greatly encouraged the past three months, as I have been getting \$4.00 net for all of my nine-pound squabs, and \$3.25 for those weighing less, and never have been able to fill the orders I get.—D. G. Barstow, Missouri.

I USE STEMS OF LEAVES FOR NESTING, by Dutch Cropper. I fully believe pigeons prefer dark-colored material for their nests. Just give them a chance at the stems of different kinds of leaves, such as are easily gathered from under the black walnut, butternut or locust tree; also, the inner bark torn from cedar posts or logs, and the bark of the grape-vine. I have known instances where salt-marsh hay was bought for the purpose, when, with very little effort, material far more desirable could have been procured right on the owner's place.

I have made beautiful jacks-traws out of rye and oat stalks which were absolutely refused. Tangled oat straw they will use, but give them a chance at one or the other of the above, and note the difference in the architecture of their nests.

The Fulton Market Company are now buying squabs at thirty cents a pound and sell them at forty cents a pound. They say they rather quote them by pound, because the size varies so much. The demand is dull just now (August), and they are placing squabs in cold storage. Geis & Waelde will pay \$2 a dozen for squabs and sell them at \$2.75 and \$3. I visited the farm of the O'Harra Squab Company. The proprietor, Wesley O'Harra, has Plymouth Rock Homers. Mr. O'Harra sells his squabs direct to the consumers and gets from thirty-three and one-third cents to forty cents each dressed. This is at the rate of \$4 to \$4.80 a dozen.—R. D. Hiatt, Ohio.

VASELINE FOR CANKER, by L. T. Dunn. Please publish this for the good of those who raise pigeons as it is the most valuable thing I have ever discovered for the pigeon raiser. Just common vaseline is a marvel for canker. Take some on the end of the finger, a good lump of it, and poke it down the squab's throat. It will loosen the lumps in the throat and you can pull them out easily with a hairpin. Put some more vaseline in the throat after you do this. You will not lose two squabs in a hundred.

Question: How shall I whitewash a loft filled with working pigeons? **Answer:** Drive your pigeons out into the flying pen on a sunny day and shut the windows, then paint the interior with cold water white paint, which will dry before night, then you can let your pigeons back into the house.

Begin with the very best pigeons that money can buy; then breed for better ones.

FRESH SQUABS DISPLACING COLD STORAGE, by Harry U. Bell. Despite the fact that Washington City may be classed as a poor squab market, the demand for fresh-killed squabs is far in excess of the supply.

The bulk of the squabs handled during the winter season is the product of the cold-storage plant. These are bought up during the summer, wherever they can be obtained, the source of supply being from persons with small lofts of birds, or they are shipped from surrounding country places. The supply of cold-storage squabs has to be very short before they will pay as much as \$3.50 or \$4 a dozen.

The recent investigation of the cold storage has done a great deal towards helping squab breeding in this vicinity. The squab-eating public is now clamoring for a better class of goods, and is willing to take them from breeders, knowing that they are the fresh-killed product. Having had to pay a goodly little sum for cold-storage squabs they are equally willing to pay for the fresh product.

No one starting into the squab breeding business in this vicinity need fear for his market. It is waiting for him. If he produces good squabs and lets a few people know it, it will be but a very short while before he will have as much trade as he can handle.

GRAIN WEIGHTS, by W. H. Cunningham. Below are given the weights of various products in their raw state, the figures indicating pounds per bushel: Wheat, 60; corn (shelled), 56; corn (on the cob), 70; rye, 56; barley, 48; buckwheat (in Pennsylvania), 50; buckwheat (in Kentucky), 52; buckwheat (in Massachusetts), 48; oats (in Illinois and Massachusetts), 32; oats (in Ohio), 33; oats (in Kentucky), 33 1-3; oats (in Maine and Pennsylvania), 30; flaxseed, 56; hempseed, 48; broomcorn seed, 52; sorghum seed, 40.

When a pigeon gets out of fix, it fasts sometimes three or four days and later comes around O. K. Don't worry about a bird's not eating. It knows its own business and is taking its only treatment, **fasting**. I have noticed this so much among the birds, especially with youngsters, I am earnestly entreating all pigeon friends to let the pigeons do the "doctoring" and let the owners of the birds give attention to feed, water and care of squabhouse, and Nature, the great doctor of all animal life, will take care of the pigeon's ailments.—M. C. Martin, Kansas.

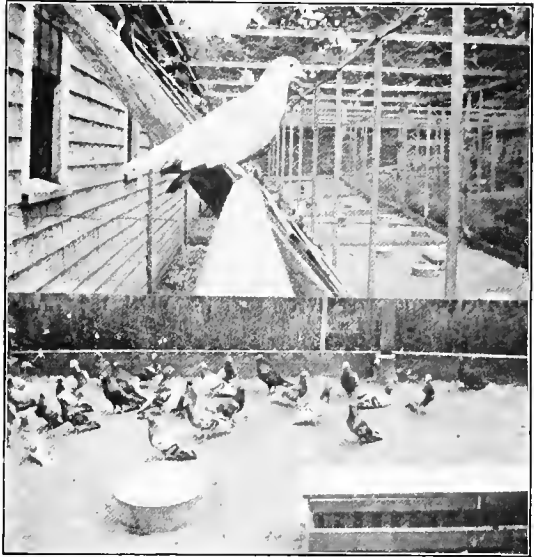

WHITE HOMER AND PEN OF COLORED HOMERS.

GROWTH OF AN IDEA. Ten years ago the word "squab" was practically unknown. Today it is on the lips of every one not only as an article of food, but in slang, which is a true test of popularity. For example, at the great American preparatory schools, the freshmen are now dubbed "squabs" meaning the soft, tender, inexperienced youth, of both sexes. In the West, a "squab" is a tenderfoot. In the theatres, a "squab" is a young chorus girl of eighteen years or under. A "broiler" is a chorus girl between nineteen and twenty-one. "Squab parties" are gatherings of children.

Fried spring chicken, roast turkey, duck, or beef are all good eating, but not as good as roast squab for my taste. It is the choice of all other meat for me. One of my customers, who is a hunter, just recently told me: "If I were served with young roast quail one meal and squab another I could not tell which was which."—W. B. Glotfelty, Pennsylvania.

I am very much impressed with the squab business here in St. Louis, and think there is no better market to be had. I get \$4 per dozen for nine pounds and \$4.50 for ten pounds. I pay no attention to markets.—F. L. McDonald, Missouri.

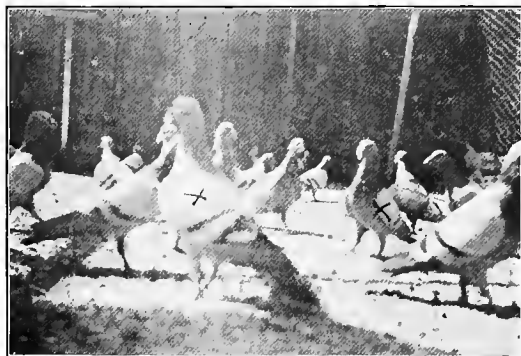

TEN PAIRS OF SQUABS A YEAR.

What do you think of these Homers? The ones with the crosses on them are the two best breeding Homers in my flock. They raise squabs weighing sixteen ounces apiece at the rate of ten pairs a year. They are the largest birds I have. I get twenty-five cents apiece for all my squabs alive and cannot raise one-third enough.—*A. F. Ayers, California.*

HOW TO GET AIR INTO SQUAB HOUSES, by *W. P. Jencks*. When you see frost on the nails of your roof inside, make up your mind your house is damp. To ventilate a house ten by twelve feet make a box about five or six feet long and about one foot wide. Have doors on the north and south side on hinges that swing in from the top. Close the one on the side where the wind is blowing and open the other one. A small ventilator one foot square open all around will let in more fresh air than one six feet long that is open only on the side opposite from the wind. A ventilator that is not over one foot square in a house ten by twelve with seventy-five or one hundred birds in it is not much use. The average squabhouse ventilators are too small. Make them larger. Try one as an experiment and find out as I did.

I have sold all my squabs to a hotel right in the town. They have taken all I could raise and wanted more. They paid twenty-five cents each and took them alive. I did not have to kill them. I now sell my squabs by the ounce. I get two cents an ounce just killed and three cents an ounce dressed.—*W. P. Jencks, Rhode Island.*

We are starting in the squab business on a small scale but with the idea of success and of a large plant. Our enthusiasm is strengthened by the remarkable success of a friend during the past two years. He has fully demonstrated to our satisfaction at least that the squab business is O. K.—*H. C. Voss, Ohio.*

HOW TO IMPROVE A FLOCK BY REMATING, by *George F. Lunn*. I have about three hundred pairs of Plymouth Rock Homers and Carneau. If I find a pair that do not breed well, I remate them. I find that it is better to try that than it is to sell them, if they are good birds. If I find two pairs which I do not think are doing what they ought, and mate them over, then they do as a rule very much better.

I take them out of the pen and use a mating coop for one week, then I put them in a small pen which I have built for that purpose, and I keep them there until they lay one set of eggs and have hatched them out, then I give the squabs to another pair and put them back into the pen from which I took them. I have not had any trouble of their going back to their old mates if they are kept apart for one or two months.

I am getting for squabs that dress eight pounds to the dozen \$4 a dozen at this date (May 5, 1911) and think that is very good. January, February and

March, I receive five and six dollars for them in the market. They sold well last winter and the birds have been doing very well.

My birds averaged six and one-half pairs of squabs for each pair of breeders for the year 1909, and I think that they will do better than that this year, as they have worked at a more rapid rate so far.

RAT TRAPS IN A BOX, by *James Y. Egbert*. When a breeder is troubled with mice in the squabhouse, he can get rid of them by using one or more traps in boxes. I take a box 13 x 7 x 3 inches, or a tobacco caddy may be used. With a one-inch auger bore eight holes, four in each side. Bait your traps and set them inside, then put a cover over the top so the pigeons will not spring the traps. Traps in a squabhouse should always be protected as pigeons or squabs may be injured if they are not. In this way I cleaned out all the mice around my pen.

I am going to buy more Homers soon, and will then have an output of twenty dozen squabs a month. I have standing orders for private trade for squabs. I get seventy cents a pair for the smallest squabs, or \$4 a dozen. For the largest squabs I get \$1 a pair, or \$5.50 a dozen.—*R. C. Boyd, Pennsylvania.*

I have a printed postal card to keep my customers informed and jog their memory as to the desirability of a course of squabs. They have the habit now and require no reminder.—*Frank R. Tucker, Rhode Island.*

HOW A HOTEL MANAGER PUSHES SQUABS, by John Hill. We pay seven dollars a dozen for the kind of squabs we serve. Just at present we have enough, but I would be very glad to know the names and addresses of some breeders of fine squabs. We cook them in any way our patrons want them, but put them on the bill of fare merely as squabs. I rather prefer them roasted, to any other way of cooking them.

I ran the advertisements of our hotel in the *New York Times* and *Brooklyn Eagle* to stimulate the night-dinner trade. The night following my published talk about squabs, the sale was forty-two orders. Our average number of orders per night for squabs had been six or seven. That advertisement was read and it brought the business.

I have been engaged in raising pigeons for eight years, and as I am employed in the city, the only time I have to attend to my birds is in the morning and afternoon, after returning home. During my experience I have bred various pigeons, but have finally settled down to Homers for first choice and Carneaux for second choice. My Homer squabs weigh from twelve to fourteen ounces each, and Carneaux squabs from fifteen to seventeen ounces each, and I have also crossed the Carneaux and the Homer, and squabs from this cross weigh from fourteen to sixteen ounces each. I recently purchased ten acres of ground near the city and it is my intention to convert this entire place into a squab plant early next spring.—T. P. Meyer, Texas.

I am getting from \$2.75 to \$4.50 per dozen for live squabs from the commission men in Cincinnati. I have not started to sell to the hotels yet. My best squabs weigh over ten pounds to the dozen. We grow wheat, corn, sunflower, kaffir corn on our farm. We save much money on feed bills. Corn and wheat are the staple articles of feed and every other day I mix corn, wheat, kaffir corn, sunflower seed, Canada peas, hempseed. Most of the time I feed mixed corn, wheat and Canada peas, the rest every other day. I think the first thing a beginner should learn is to ventilate the pigeon house. They must have pure air to breathe. Don't ventilate so that the wind will strike on birds. I store grain in barrels covered with tin, so rats can't eat.—George S. Beyer, Indiana.

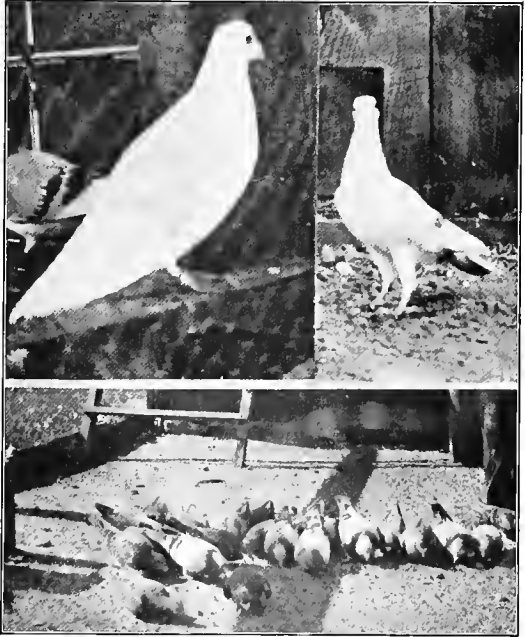

WHITE AND COLORED HOMERS.

One thing I have learned about the care of pigeons: first and most important is plenty of clean, fresh drinking water, one fountain in the fly and one in the loft so when the old birds feed the squabs they can get water without flying outside for it. Second, that all grain or seed should be free from dust of any kind, and musty grain should not be fed under any circumstances. I think most of the pigeon men here feed a little different than in most places. My main feed is wild brown mustard seed. I have fed it with good results for three years. I will give my way of feeding: One and one-half quarts wheat in morning. From three to four quarts mustard seed at noon. One and one-half to two quarts Egyptian corn at night, with a feed of peas and rice once a week each. In each loft is a feeder containing grit, charcoal and sea-shells, in each fly a piece of mineral salt. One reason I feed more mustard seed is that it is a cheaper feed than anything else. It costs here \$1.25 per one hundred pounds; white wheat is about \$1.60 and Egyptian corn \$1.75 to \$2 per hundred.—Riley C. Clark, California.

HOW I FEED SO AS TO LOSE NO SQUABS, by Fred C. Schrein. I started to raise squabs in 1904 with six pairs of Homers, the Extras from the Plymouth Rock Squab Company. They cost me fifteen dollars, and my coops five dollars, total twenty dollars. I did not know a thing about pigeons, and so you see I had to start at the bottom and climb up, and now I am on the top rung of the ladder.

When my squabs came, where was my market? I had to look for one. I took some down to the leading hotels and the managers startled me by remarking that they were not squabs. I asked in some perplexity, "Why are they not squabs?" "Because they are too large for squabs." It was up to me to make good. I replied that for every one of the birds that was not a squab I would give them a dollar. Then they said they had no calls for squabs, but I finally persuaded one of them to try mine, telling him that I would let him have them for three dollars a dozen. It did not take long before he found out that it pays to have first-class goods to do business, and so it was. I had to educate the people first as to what a squab was, and now I have them pretty well educated, and I cannot raise enough for my trade. I am now catering mostly to private custom and get fifty cents apiece for all my squabs. It makes no difference who it is; every one is treated alike.

I have at present about one thousand birds, and if I had room I would have five thousand more. I expect in the near future to go out in the suburbs and build a large squab plant.

I use a mixed feed, and everything but corn. The only time that my birds get corn is in the winter months, then in the afternoon I feed it to keep them warm through the night. **Do not feed cracked corn at any time unless you can crack it yourself, and know it is fresh.** Follow these instructions and I bet you will not have any more squabs die with canker unless your grain should happen to be musty. I know what I am talking about, as I have gone through the mill.

HOW I MADE ROAST SQUABS POPULAR, by Clara M. Hodson. I have hatched eight hundred birds, kept one hundred pairs and sold the others at a fair profit. I have sold the squabs from twenty-five cents to fifty cents each according to size. They average ten pounds to the dozen, but many of them weigh one pound after removing feathers.

I selected the birds I wished to keep, built a small addition to my first house and mated them up as I wished according to the colors, blue, white, black, brown or Carneau red. This is easily done if the youngsters are confined together in a mating coop for a couple of weeks, then are allowed to go into the fly where the young pairs are kept. They will bill and coo, build a nest and go to work. I have quite a number nesting at five months.

My pigeon cote is in the rear of a lot 80 x 180 feet on one of the main streets of this Maryland town of eight thousand people. It is the only

pigeon plant in this section, and I have created an interest in my birds and a taste for "roast squab with peas" that make a sale here for all. I cannot always supply the demand. I had pure healthy stock to begin, studied Mr. Rice's valuable book and the magazine and without any experience have had exceptional luck. No disease of any kind. I feed them a special pigeon feed (which stood first under a recent examination by the Maryland Agricultural College). It has about twelve different kinds of seed and cracked corn in it. I pay \$2 per 100 pounds for it. It costs me two cents apiece per week for my old birds and their squabs. Sometimes if the number is larger, I feed a little higher. They are fond of hemp. I watch them and feed them what they like. They are very little trouble. I feed and water regularly twice a day in troughs and fountains, and have the house cleaned every week, sometimes oftener, as nests may require. This work is done by a boy twelve years old who loves the birds.

My birds are the admiration of all who pass and see them sunning themselves. They know me and many of them know their names, I think. They are far more easily reared than chickens. I have fifteen White Leghorns and fifteen Rhode Island Red hens in a lot adjoining my pigeons, but they are not so profitable. I find great pleasure showing my guests my birds, and all are enthused with them. I recently took a prize serving them roasted whole, stuffed with celery and served with *petit pois* and crab apple jelly. Let every woman who loves pets try a few pigeons.

Question: In what cases do you believe in selling squabs to middlemen, and in what direct to private trade? **Answer:** I believe in knowing the cost of production and selling to somebody at a profit. The average pigeon or poultry raiser doesn't know either costs or selling prices. The product of a large squab plant in the hands of an average business man is best sold to middlemen because the cost of finding retail customers for a large output is something requiring bother, skill, time, money and equipment, all of which the middlemen have, as well as the educated habits of people who are trading with them. The product of a small squab plant is best sold at retail because it costs nothing to find the customer if you follow directions. Producers are much more common than salesmen, in all lines. The salesmen have the equipment, the know-how. The producers should try to get it. It must be remembered that it takes training to lead a business life, although few seem to appreciate it. The man or woman who raises beautiful squabs but doesn't know how to sell them is very much of the habit of mind of the professional man, a physician, for example, who can write a book on how to cure a cold but can't cure one. Many of the misunderstandings in the pigeon business have arisen from the inability of the writers, who never do, to comprehend what the doers were doing.

HOW ONE WOMAN WORKS AND WINS, by Nellie C. Wellman. The business of squab raising had always appealed to me as most fascinating, but living in a city I could not very well engage in such an occupation.

But a few years ago, a very pleasant home-stead in the country, my husband's boyhood home, came into our possession.

In the spring as soon as the weather permitted, our squabhouse of two units was started, and May 4, 1909, we installed thirty-one pairs of birds in unit No. 1. We were fortunate in securing fine Homers. I began to save the young birds for future breeders and by the last of August had about one hundred youngsters in unit No. 2.

We sold no squabs until the first of September of that year, and have been most successful in raising fine birds, and also in disposing of them to the very best markets and private customers.

I live about twenty-five miles from New Haven, Conn., which was my birthplace and also home for many years, and having an extensive circle of acquaintances, I found no difficulty in selling my squabs.

Then, too, being personally acquainted with the proprietors of the best markets, I found them very ready and willing to buy good birds.

Another means of our getting customers was through a private chef, who goes to the houses of the wealthy class to cook for private dinners. This chef (a woman) has done much to recommend our squabs, telling people they are the best that come under her notice.

Two of the markets take the birds with feathers. Another market wishes the feathers off, but birds are not drawn.

For our private trade, we dress the squabs completely, wrapping each one in wax paper and packing nicely in pasteboard boxes.

As the birds are all sold in New Haven, this way of packing seems all that is necessary and we have never been obliged to use ice.

In the spring of 1910 three more units were added to the house, which now consists of five units besides a grain and killing room at one end.

I believe in absolute cleanliness, pure, fresh water, and plenty of it, good health grit, charcoal, salt and oyster shells. My birds have all of these, and I have never had a case of canker in my loft.

I hire a man for cleaning and other heavy work, but attend personally to the birds, being familiar with each individually.

Several of my breeders have raised nine and one-half pairs of squabs, and few less than eight pairs during the year.

If possible I am more enthusiastic as regards squab breeding than ever. The pleasure I derive from being with the birds more than repays me for the labor connected with their care.

As a rule, those who offer any class of pigeons for half price, either have failed to figure out what it cost to raise and mate, or they are selling a poor class of birds.

HOW A POSTAL CARD FOUND MY BUYERS, by Frank English. I purchased some Homers and Carneaux of the Plymouth Rock Squab Company. I started in to raise my own breeding stock, and my birds proved to be excellent workers. I began to advertise in the local press and by the following post card:

SQUABS

Rich, juicy, fat squabs are not only a dainty food, but also very nutritious and far superior to chickens. They are especially valuable to the sick and convalescent who cannot assimilate coarse meats. If you have never enjoyed the pleasure of eating squabs, try them. We have them on sale either killed and dressed, or alive as desired by some. We have nothing but the very best, and raise all we offer. No cold storage nor common pigeons. We sell by the single pair and upwards in half dozens, or any number required.

FRANK ENGLISH, Squab and Pigeon Farm.

Within forty-eight hours my telephone kept me busy with people inquiring about squabs. I need not say that in a small Northern Connecticut section many of the inquiries were both original and provincial. Some wanted to know if I raised squabs for Gloucester fishermen. Some wanted to know if it was right to skin them. Others desired information concerning the nature and purposes of squabs, while a few wanted to learn how to hunt and trap them. Of course, among the Berkshire and Litchfield Hills this simplicity was pardonable, but out of one hundred postal cards sent out and a small advertisement in a local paper, I received orders for more squabs than I could furnish and the prices ranged from four to six dollars per dozen, according to size.

To say that I was agreeably surprised goes without saying. I feel that many of the squab breeders unfavorably situated for expressing squabs long distances at great expense may take heart by my experience and cultivate a local trade to their advantage and profit.

Later (April 25)

Here's a how-de-do! My post cards and the advertisement one of our local hotels has given me have created a furor. I cannot supply squabs enough and have had to refuse orders. I did not dream when I sent out the post cards that I would have such a deluge of orders. The hotel man informs me that he never had such fine squabs before.

There are squab breeders as far West as Missouri, Kansas, Nebraska and the Dakotas who are shipping steadily to the Eastern city markets. Your success with squabs does not depend upon the markets, but it does depend upon your intelligence in dealing with the markets.

The pigeon business is like any other business; that is, you must talk pigeons if you sell pigeons.

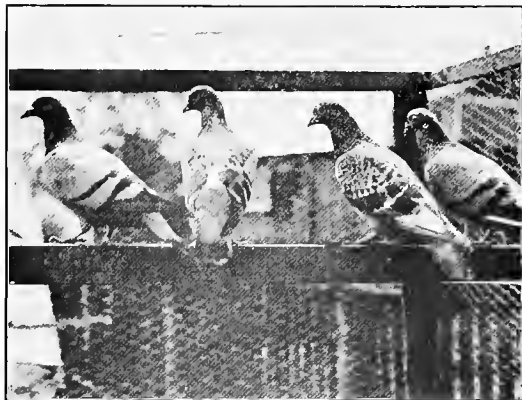

FOUR PLYMOUTH ROCK HOMERS.

HOW I EXPERIMENTED WITH COW PEAS, by William P. Gray. Although I have always found that it paid me well to feed Canada peas liberally, their price was so high through the summer and fall that in October I decided to try cow peas as a substitute, and accordingly mixed four bushels of cow peas with about eight hundred pounds of other grains. Shortly after beginning to use this mixture, I noticed that about all my squabs were affected with a looseness of the bowels that made my nests the filthiest that I had ever seen them. Several squabs died and those that I have marketed the past two months have been about the poorest I have ever had to dispose of.

Ten days ago I made up another grain mixture, this time using instead of the cow peas four bushels of Canada peas and other grains, the same amount as before except for an extra one hundred pounds of cracked corn. Here is the result in ten days after substituting the Canada peas for the cow peas: The looseness of the bowels in the squabs has disappeared. My scales have shown that the squabs taken out of the loft today were the heaviest that I have produced this fall. The old birds act as though they had taken on a new lease of life. Out of sixty-four pairs, sixty-one pairs are working, and seventy-four eggs have been laid the past week.

To any wishing to know what my birds are being fed now, I wish to state that my grain mixture for cold weather is as follows: four bushels peas, five hundred pounds cracked corn, four bushels wheat, one hundred pounds kafir corn, fifty pounds millet, twenty-five pounds hempseed.

I never place a pair of pigeons in a pen unless they are banded. I also limit the number of birds placed in a pen to conform to the size of the pen, and under no conditions whatever do I allow another bird to be added to this pen. In my case the number is twenty-five pairs, as I have built my pens with this idea in view, for I believe this number is the most practical for all purposes, and I am convinced that a greater number than this will fail to produce the results shown by this number of birds. I then make out a chart with the numbers one to twenty-five in a row, and allow twelve spaces for the twelve months of the year. Then I make a note in the space opposite the pair number in the corresponding month when robbing the pair of its young, showing just how many were taken. By referring to this record I am able to know exactly what this pair has accomplished in a certain period, and if it does not show a stand-

ard result I make arrangements to dispense of one or both birds at once, and in this way I save the feed the pair would consume and also avoid any possibility of either bird causing any trouble in idleness. This takes practically no time and is a big money saver.—**F. L. Stock, Missouri.**

A year ago I moved my drug store about a mile from its former location, and about that time I had about one hundred old and young pigeons to move with squabs and eggs. I caught all the pigeons, old and young, put them in boxes with a sack over the tops, and lost only one young pigeon from suffocation. I lost all the eggs, and strange to say did not lose one squab, which were of all ages from one or two days to a couple of weeks old. I just put them in the squabhouse, and the old pigeons went on feeding them as before. By using a little common sense, pigeons are the easiest thing in the world to raise, and beat poultry all over.—**C. Montz, Louisiana.**

In June, 1910, I purchased a dozen pairs of Plymouth Rock Extra Homers, and now (October, 1911) have eighty pairs of breeders and 140 youngsters. I have just started to sell my squabs and find a ready market. Can get \$4.25 per dozen for eight to nine-pound squabs. I am on a rented place, but expect to move in the spring and build more lofts and increase my breeders. I can dispose of ten to fifteen dozen more squabs a week than I can supply. There are a great many breeders here who have what are called American Homers which breed a squab only a little larger than the common pigeon.—**H. W. Moore, Ohio.**

DRY GRAIN HEALTHFUL, by Hugh Donlon. Having had trouble and sickness in my birds, especially in the "big fellows," I was at a loss for some time to know where the trouble came from. I had grain from different sources to see if that would help, but no better luck. Lately I have taken each day's feed and left it on the back of the stove all night, or put it in a warm oven for a short time, and I find a wonderful difference. The birds picked up at once and seem to relish the crisp grain. There is very little grain, after it has stood in damp storehouses for a year or more, that will not draw dampness.

I have been feeding dry bread for some time, and see it spoken of but how to feed it is the puzzle that will bother a great many, as it should not be wet. Run the bread through a coarse food chopper and it will come out in the form of pills that will be devoured greedily. It makes great stuffing for squabs. Of course it must be used in connection with grain rations.

HOW I MADE A RAT-PROOF GRAIN BIN, by J. E. Maccabe. My feed room is down stairs, and the lofts are up stairs. The rats used to eat about half of the feed. I went to a tin shop and ordered a box of galvanized iron, twenty-four inches wide, thirty-six inches long, eighteen inches high, eight compartments, four of the compartments six inches wide, and the full width of the box, the other four compartments six inches wide, but only half the width of the box, or twelve inches. Each compartment the full width of the box will hold a bushel, so the whole box carries six bushels of grain. Inside of two months the box had paid for its cost, five dollars.

Between the rat-proof feed box and the lime in the lofts I have no more rats or mice.

What Lime Did

I couldn't go into the loft but what there was a rat or mouse, although I didn't keep the feed in the loft. The floor was of boards. The rats would go up the side of the building, then they would make their way into the loft. This spring, to make some whitewash, I bought too much lime, so I put some of it around the wall on the floor of the lofts. It extended out from the wall for six inches, an inch in thickness. From that day I have never been bothered with rats.

I was in Seattle last week looking for a market. I went to all the high-class cafes and restaurants. Here are a few: The Butler, Mancas, the Rathskeller, Olympus and Gerald's. All offered three dollars a dozen (feathers on) delivered. In one I had rather an amusing experience. I went to the chef and asked if he bought squabs. He said, "Yes." I asked how much he paid. "Ten cents apiece," he answered. I turned and started out. "Hey, wait," he called. "Gif you fifteen cents." "Nothing doing." "Gif you twenty cents." "Come again." Well, he "came" to twenty-five cents each delivered in Seattle.—Wallace Todd, Washington.

SQUABS AT GOOD PRICES IN CALIFORNIA, by Walter E. Hiller. I have moved to California from Massachusetts, where I bred squabs, and am all ready to have my Extra Plymouth Rock Homers shipped on here. They have fine pigeons around here. Squabs weigh twelve pounds to the dozen. They get \$3.50 to \$4 a dozen alive, and don't even have to twist their necks. Grain costs about the same as in the East: peas \$4 per one hundred pounds, hempseed \$6 per one hundred pounds. This is a fine climate to raise squabs. I have bought a nice home, one acre of land, all kinds of fruit, large stable, hot and cold water, electric light, bath room and a line of cars, eight miles to the city. I have built two coops, fifty feet long, and am building more. Things are all different here. The house is fifty feet long, four feet wide, ten feet fly, seven feet high; cement floor; everything all open, no windows, very easy to clean out. One coop holds fifty pairs.

FOUR PAIRS HOMERS STARTED ME IN 1903, by E. W. Lewis. I purchased six pairs of Plymouth Rock Homers in 1903. I did not purchase a bird in the seven years, but selected the best from these four pairs and their increase for breeders. The inbreeding did not seem to hurt them in the least, as the seventy-five pairs I have now are never sick, and the squabs at four weeks weigh eleven to fourteen ounces. I put my squabs in a separate coop for twenty-four hours before killing, and then their crops are entirely empty. Then kill and dry pick. In that condition they weigh eleven to fourteen ounces each. I am getting \$3.75 a dozen the year round. A few days ago I had a large squab which dressed sixteen ounces. The chef at the hotel I sell to looked me up next day and said, "If you can furnish me squabs like that, I will give you \$4.25 per dozen the year round." That decided me to get Carneaux, which I am doing, and I hope they prove all that has been written of them. I have not been in a position to expand as fast as would like. Of the seventy-five pairs of breeders I have now, here is the record for last year: January 1 to December 31, 1910, 748 squabs for which I received \$224.90. Feed for the year was \$106.75, leaving a profit of \$118.15, and the work attending them was a recreation and pleasure. I feed whole corn, macaroni, wheat and kaffir corn as main feed, and hemp, peas and millet as luxuries. (Mr. Lewis, the writer of the foregoing, lives in Colorado. It is often asked by residents of that state whether pigeons will breed well there, on account of the high altitude. His story is proof that they do. We are acquainted with a number of squab breeders in Colorado who never have complained that the altitude had any effect, and we do not believe that it has, either one way or the other. Pigeons seem to breed there as well as anywhere.)

The demand for first-class pigeons is greater than the supply.

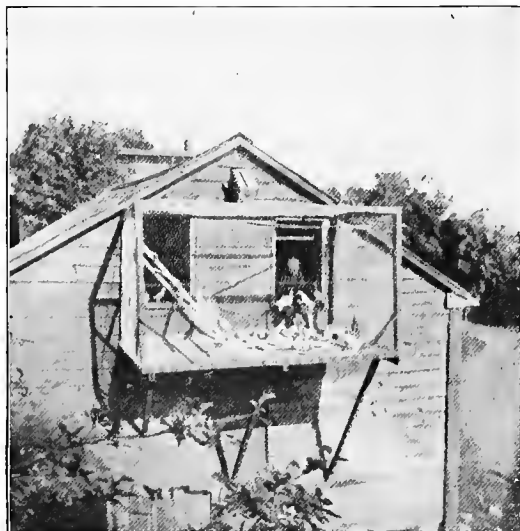

NOVEL FLYING PEN.

Squabs in the loft of a wagon house.

Any fancier can find enough desirable characteristics in the Homer and Carneaux utility pigeons to fully satisfy his fancy and at the same time be breeding something that is of some use to the world. I get just as much pleasure in breeding something that's useful, as any fancier does in breeding useless fancy varieties. If a person wants to breed pigeons for pleasure or fancy, utility pigeons are more desirable, in that by selling or eating the squabs that are not your ideal, you can pay the feed bill. If you have a squab which is off color or has something about it you do not like, you get just as much for it as squab, as if it were just what you desired and you sent it to market. I believe in fancy utility pigeons, and as long as I breed pigeons I will consider the fancy points, even in squab breeding pigeons.—**J. W. Williams, Texas.**

The most essential point in buying utility pigeons is to get the kind or class that will breed the most and the best squabs. However, the kind that's in demand must be considered. The kinds most in demand in the South are the Homer and Carneaux squabs. The reason for this is that there are a great many more Homers and Carneaux than all other varieties combined. In fact, all dealers know what Homer and Carneaux squabs are.—**J. W. Williams, Texas.**

For several years I had been trying to get a flock of well-bred chickens. I had paid good prices for eggs and hatched a mongrel lot of chicks. So few were at all what would be called good lookers that I became thoroughly disgusted with the whole business. Too many casualties and fatalities of the chicks, to be profitable. Too much bother to run out in the storm and pick up the half-drowned chicks. Too many mites to keep off the roosts. Too much of a job for the financial returns. So I decided to look to squab raising. Some of my friends have gotten past the point where they smile as they ask me how the pigeons are getting along. They formerly acted as if they thought that pigeons were good enough for a boy to have, but for a big strong man with a good profession to bother with pigeons was too much like child's play. The person that is looking for a pleasant and profitable business would do well to take up squabs.—**C. F. Wilson, Illinois.**

I will tell you of a little experiment I had with a pair of pigeons. I did not like the looks of the place where they had their nest so one noon I changed it into another nestbox.

During the afternoon while I was away at work a white cock chased the cock off the nest. In the evening when I came home I found the eggs very cold, and I put them back where they were in the first place, caught the hen, put her on the nest, and she stayed. I didn't expect them to hatch after being chilled, but to my surprise they did, but the young ones were two days behind time in getting out. They are getting along nicely.—**Edward Knapp, Indiana.**

Some one gave me an old copy of Rice's *Manual* five or six years old. I began to study that and soon decided to send for the last issue. It came in due time and along with it a sample copy of the *National Squab Magazine*. After considerable deliberation and delay I sent in my one dollar subscription for the paper and from that time on I began to see what squab raising meant. For the first few months the magazine was worth more than the subscription price each month. I could not do without it now.—**R. C. Clark, California.**

About a year ago I bought of you thirteen pairs of Extra Plymouth Rock Homers. I now have about two hundred pigeons, and they are beauties. I have killed but few, as I wish to get a large stock on hand and then offer squabs only for sale.—**William C. Davis, Georgia.**

MINE EAT LOCUST LEAVES, PEPPER-GRASS, by George Jackson. I bought thirteen pairs of the best Plymouth Rock Homers in May, 1909, and now, eleven months later, I have two hundred birds. Every one that comes along admires them. I have a friend who gives me boxes, which I break up and make use of in building. So in this way I do not have to buy much lumber.

We have an offer here (Kentucky) for squabs weighing eight ounces at \$3 per dozen, and as ours weigh from twelve to sixteen ounces I think I could get at least \$5 for my squabs.

I feed seven different kinds of grain, but my young birds do not like the Canada peas. I feed rice and locust leaves sometimes, and as soon as peppergrass grows I will give them that.

RICH SQUAB OPENINGS IN CALIFORNIA, by M. W. Donaldson. Nowhere outside the city of New York is the demand for squabs so strong as in the cities of Oakland and San Francisco, California, with their combined population of approximately 700,000 (census just completed). While Oakland boasts of her hotels, grills, clubs and sanitariums, where squabs find a ready market, San Francisco's three leading hotels alone could consume all the squabs produced in California today, and then run short on orders for this delicious luxury. One dollar per pound can be obtained for the right kind of squabs in the Oakland or San Francisco markets when offered to the right kind of trade. As the game laws of our state are becoming more stringent each year, and prices correspondingly higher for the inadequate supply of wild game brought in, also likewise for young poultry, the only substitute for the squab, there must soon be found by the caterer a means of taking care of his menu along the lines of wild game, and the only logical solution appears solely in the squab. There certainly is a field here for many who might care to invest in this lucrative industry. San Francisco is a most cosmopolitan city and right up to date. Californians are not afraid to spend their money. They want the best money will buy and they get it, regardless of what it may cost. If they should call for squab on toast, they would not hesitate at \$2.50 to ask for it. It's the same in all other lines of trade in California. The people here demand the best and they certainly have it. Squabs will soon be included, and the best that can be produced, both in size as well as in flavor. The man that gets in first on this market with a modern squab plant will have the easiest and the surest sailing, but nevertheless, sure. Such are the possibilities for the producer of squabs (for the rich man's stomach) near the Oakland and San Francisco markets of California.

About October of last year I bought from your firm nine pairs No. 1 Plymouth Rock Homers. At the present time (June 12), I have about eighty-five birds all in first-class shape, besides about twenty killed for the table.—A. E. Buchanan, British Columbia.

NEW ORLEANS WAITING FOR GOOD SQUABS, by K. J. Braud. I am raising squabs for pleasure and for my own table use. I received my birds exactly nine months ago, twelve pairs of Plymouth Rock Extra Homers, for which I paid \$30. I have raised in that time twenty-four pairs of breeders, some of them larger than the parents, and have used for our table seven dozen squabs, and now have ten pairs of young ones in the nests, making a total of 146 birds. This is not remarkable, but in view of the fact that I had never had any experience in the business I consider it highly satisfactory, at least to me. I have never lost a single large bird, having all the original birds, and a finer lot I think it impossible to find. I have six pairs of my young ones working, three of which have hatched young squabs, and the other three are setting.

Taking things generally, I am highly pleased so far. I derive a great deal of pleasure, and besides quite a delicacy for our table. I have no doubt in my mind that squab-raising can be made profitable here in Louisiana as well as anywhere else. I feed my birds along the lines set in the *National Standard Squab Book*, and I feel that any one following those directions can hardly fail if they give them the proper attention.

It appears to me that a good market could be created in New Orleans for squabs if the proper energy and push were behind the business.

MUST SAY I PREFER SQUABS TO CHICKENS, by Albert F. Neblung. I will tell you why I am going to raise squabs and not chickens. I have been raising both for some time and have wanted to sell my chickens, and have found a buyer at last, and have sold out all I had, also sold all my pigeons, because they were not what I wanted. Now to get a start with the best there is in the line of squab breeders. I could clean my squab coop in two hours, then they would be all right for one week without need of cleaning, but the chickens needed about two hours' work each morning to keep away lice, then it was never right. The chickens were always wild and would fly as if I were going to kill them all, but the pigeons would mind their business, be tame, sit on my hand, and eat out of it. I'd like to see a chicken do that. Then I set an incubator with 108 eggs and hatched fifty-four chickens. The first week I lost fifteen, the second week, fourteen, the next two weeks eleven. Out of the fifty-four I had fourteen left. That is the way chickens do with you. But when pigeons lay, you will have two squabs. You don't have to feed them or watch the heat in the incubator or brooder. Well, to cut a long story short, chickens eat about twice as much as pigeons. About the same with work, if not more. Me for pigeons! I will have some good Carneaux or Homers. I have room for about one hundred pairs, but will not start with that number.



PLYMOUTH ROCK CARNEAUX IN NEBRASKA.

I used oat straw for nest material. The birds leave all other kinds for it. It's soft, pliable, holds shape, is superior to anything for both hens' nests and birds' nests, of anything procurable. They build of it large nests which protect the eggs from cold. Having the nest shelves on cleats of iron keeps lice or mites away. With a keg of good, strong whitewash with carbolic acid in it, a man can clean nests in a jiffy. Dip in keg and save lots of time. His lofts look neat at all times. A man could clean many hundred in an hour. I use plenty of salt in all whitewash. The birds peck at it, and get plenty of lime and salt. In buying birds I always put on an extra fifty cents a pair. This gets the best at all times for foundation stock.—William B. Thomas, Texas.

A great many children come into this world every year with a decided deficiency of the liquor protoplasm in their little bodies, and continue to suffer for want of the supply of it, until some bright physician advises that they be given squabs to eat, as it is practically the only known way of supplying this life-giving fluid. It is a well demonstrated fact that nothing is so beneficial in the treatment of children's diseases, such as dyspepsia, stomach and intestinal, where the pancreatic and gastric juices have vanished and the ptyalin of the saliva has disappeared. This squab elixir is almost instantly absorbed into the veins and is the most nourishing, invigorating and vitalizing juice the medical profession has ever discovered, especially in the case before mentioned, and also in all other "wasting away" diseases due to malnutrition. It must not be understood that squabs as a life-building food are necessarily confined to the children—far from it. Any one suffering from dyspepsia, indigestion, chlorosis or any of these system-depleting stomach diseases is equally benefited.—Franklin H. Smith, California.

MY SALT CAT, by P. Earl Kolb. Take one part charcoal, one part sifted sand (using the coarse part), one part salt, and add a little lime, enough to make it stick, and add a little water. Mix well. Make one or more wood moulds and fill them with this mixture, then let them dry (I put mine near the stove, for the bottom part is hard to get dried without heat). When the mass is hard it will come out of the mould like a brick. Place a brick on a board in the cage and the pigeons will peck at it.

To retain the peculiar delicate flavor of the squab the favored method of preparing them for the table is as follows: If possible make use of a regular covered roaster; in any event use a pan that can be covered. If you care to stuff them, and oysters are not objectionable, use bread crumbs and fresh oysters, though many claim this method is no improvement. Roast them rather slowly for an hour and a half or two hours, basting with melted butter every fifteen minutes. In frying or broiling them the greater portion of the delicious delicate flavor of this superior dish is lost and you are the loser thereby.—F. B. Shepard, Pennsylvania.

FOUR-WEEKS SQUABS BEAT EIGHT-WEEKS CHICKS, by A. J. Alexander. Six pairs of Plymouth Rock Homers arrived here March 13. Three weeks later I sent an order for ten pairs, so I have a stock of seventeen pairs and have had them about two months. I now have thirty-six squabs, about twenty of them off the nest, and they weigh at from three to four weeks old from three-quarters to one pound each. I am writing this to show you and others how much easier it is to raise squabs than chicks. I hatched twenty-four barred Rock chickens in February and March and now have only eight of them. They have disappeared by night from rats, and some were drowned by being led out in grass by old Biddy. Each day finds me looking them up to see if the eight remaining are all there. My little Rocks are now nice broilers while the oldest squabs can't be told from the old birds. In fact my squabs are larger at four weeks old than the Rocks are at eight weeks old.

After I have time to raise pigeons enough to have a reasonable stock there will be no more chicken raising in mine.

I put an extra pick-up pigeon egg into a nest with one egg and three more were laid. The hen hatched four squabs but one died. One nest with two squabs in it was deserted and I lost them, making three squabs lost out of thirty-nine, which is much better than I did with chickens running at large or in a barnyard. Doubling my stock in two months' time I think pretty good for a new breeder.

I FEED WILD SEEDS PICKED ON THE STALK, by Vivian E. Dawley. I saw in the April issue of the magazine an article by J. W. Arthurs, saying that Homers were real money-makers, and I am convinced beyond all doubt that they are as good as the best, and better than the rest. I have eighteen pairs in one pen and since the first of May have sold \$20.73 worth of squabs, and on July 24 there were twenty-two squabs and twelve eggs in the coop. All my feed since April 1 has consisted of yellow corn, whole and cracked, and Canada peas. Corn is going up in price every week here. It is now (July) \$1.50 per bag, and Canada peas \$2.40 per bushel. My wild seed I feed at this time of the year, green. I pick it on the stalk and place it on the wire in the flying pen, and the birds get plenty of exercise clinging to the wire and pecking it to pieces. I keep grit by them at all times, as I think it the most essential of anything we give them, except water, which should be given at least three times a day, and the best of spring water should always be used, as river or pond water is softer and creates a slime in the drinking fountains quicker than the spring water.

My three hundred birds (Homers) purchased in May, 1910, have given me squabs for sale every month since, except December, paying from five to seven per cent per month on cost of flock and equipment. I am planning to enlarge my plant.—D. N. Carrington, New York.

HOW I LEARNED NOT TO LOSE A SQUAB, by Mrs. E. C. Monahan. One year as a pigeon breeder hardly seems long enough for advice-giving, but I am so sure that I have the solution why young stock are lost in the first few weeks after leaving the nests that I can't keep it to myself. Advice need not be taken, anyway. I lose not one bird. When the squabs first leave their nests, I arrange retreats to give the frightened little things plenty of opportunity for rest from the hazing even the gentle Carneaux give. Next I transfer them to the youngster pen at night and slip them into a roomy corner. For several days after this, I scatter food handy before the callow brood when the older birds are interested in fresh bath water or a little hempseed. The last thing at night, before the newcomers have mustered courage to go above to roost where the older birds already are, I scatter grain as long as it is picked up. As I am raising birds which at eight months outweigh their parents, who are eighteen to twenty-two-ounce Carneaux, my plan seems a good one. I also keep the same bone and muscle-making dry mash before them in hoppers that poultrymen say is indispensable. It is dry bran mixed with charcoal, grit, oyster shell, salt, and a very little cayenne pepper and commercial beef scraps. This hopper is liberally patronized by the birds. The squabs in the nests nearly always weigh sixteen ounces at three weeks, and where the nests are low many of them run about at this age. The parents feed them for eight to ten days longer. At five weeks, when the young are no longer tolerated near their former home, I do the transferring. At first any work that required handling the pigeons made me about sick, for fear I would fail or would hurt the birds. I use no net or other device, simply do all the catching at early roosting time. Mated stock is especially easy to handle that way. The pigeons were bought to keep me out of doors, for reason of health, but have developed into a fine pin-money investment, so the plant is to be enlarged soon. I often give the *Squab Magazine* to persons buying stock of me, and recommend it to all who show the faintest interest in pigeons.

I notice some writers suggesting that the first egg be taken from the hen pigeon as soon as laid, and another be substituted, until the second is laid, then both eggs again be replaced, so that the two eggs will hatch the same day. Child play. Again I wish to say that the birds with Nature as the teacher can run their own business. As a matter of fact, as all experienced breeders know, the birds do not hover the first egg closely in any season; in winter, just enough to keep it from freezing. You can examine the one egg and you will find almost invariably the first egg cold until the hen goes on the nest for laying the second egg, which is about 2 p.m. the third day. Then she hovers the eggs closely, and the hatching process begins with the two eggs in the nest.—M. C. Martin, Kansas.

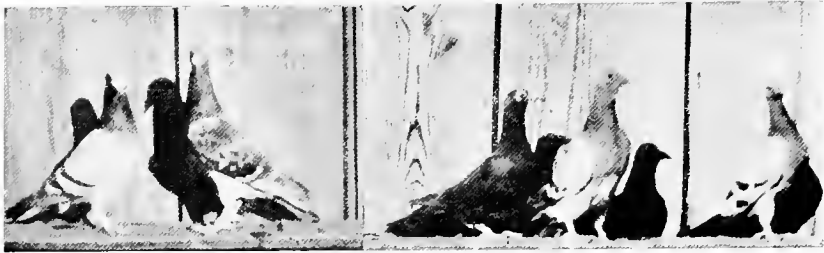

FIRST-CLASS HOMERS IN THEIR KANSAS HOME.

SIXTY CENTS A PAIR, by Charles S. Eby. I have a standing order for all the Plymouth Rock Extra Homer squabs I can raise from a large firm in Detroit (Michigan), and they pay me sixty cents a pair, just as they are off the nest. They told me they were the largest squabs they had ever seen. They weigh from one pound to nineteen ounces apiece. I think I have the largest or rather the heaviest Homer squabs in the country. Don't you think so? The smallest squab I ever weighed at four weeks of age weighed fifteen ounces. I have lost but three old birds since I started, and that was with sour crop, caused by poor feed.

Question: I am going to start squab raising in a carriage house which is now overrun with rats and mice. How should I arrange the place to keep them out? **Answer:** I advise you to lay one-half inch mesh wire netting on the whole floor, also the walls and ceiling, so as to make it physically impossible for rats or mice to get into the squab room from the outside. If you have a double floor you can lay the wire netting between the floors. You must be careful to screen the ventilators, and in the management of the window, especially when closing for the night.

Question: Here in Illinois we have cow peas in plenty. Are they good feed for squabs, and are they as good as Canada peas? I can buy them for from \$1.25 to \$1.75 per bushel, according to the season. **Answer:** Cow peas are not favored so much as Canada peas and are generally more expensive. They are all right to feed to pigeons.

Question: I am a woman and dislike to kill and pluck the squabs. Would you recommend my shipping the young squabs alive from Mississippi to the northern markets? **Answer:** No. If you don't like to kill them, why don't you raise up your pigeons for breeders and sell them alive in pairs, as so many are now doing?

WHAT AN EASTERNER SEES IN CALIFORNIA, by B. F. Babcock. Having been in Southern California and Los Angeles for over a year, it has given me a good opportunity to look around and give to the readers of this magazine an idea of the possibilities of squab business in Southern California. The climate is *par excellence* (except occasional fog and dampness in the morning, which may cause sickness among the breeders, but this is easily overcome) having none of the extreme Eastern winters and no bad storms. I have not so far seen any squabs in the markets that compare with the ones that I raised in New Jersey from Plymouth Rock Extra Homers and sent to the New York markets.

I have been raising pigeons for the last few years, but never paid any attention to the raising of squabs for market until about a year ago. I had some Homer pigeons, and then I bought a few more, and sold my first pair of squabs in May, 1910, and from that time on I have had sale for all the squabs I could raise. I sell all my squabs dressed, and get seventy-five cents a pair for all. I feed corn, wheat, kaffir corn, buckwheat, hemp, peas, barley and millet. They are very prolific breeders and raise nice squabs. I am a great lover of pigeons and find squab raising very interesting work. I have been a subscriber to the **Squab Magazine** since January, 1910, and think it is the best periodical on pigeons ever published, and would not be without it.—Ralph Lenz, Ohio.

I bought some fine Homers from the Plymouth Rock Squab Company two years ago. A friend asked me to try my birds in a Homing Club, but I thought they were not good enough for racing. I joined one of the largest Homing Clubs in Canada. I won a good many prizes in the club, the birds flying as far North as Cobalt.—Peter Chormann, Ontario.

The retail prices in Providence for ten-pound squabs are \$1.10 per pair, \$5 per dozen.—H. C. Card, Rhode Island.

HOW I BUILT LARGE FROM A SMALL START, by W. E. Blakslee. Many times we fail to realize that the things we do for a pleasant pastime may become most important later. About three years ago I thought it would be an enjoyable and interesting way to spend my spare time to have a small flock of pigeons, and make a study of raising both breeders and squabs. At that time I little realized what it was going to mean for me later.

My first move was to obtain the **National Standard Squab Book** and study up what information I could derive from that. I found it to be a great aid to me for the "know how," and what to do, in getting my place in proper shape for keeping birds. As I advanced in my experience I appreciated more and more what the **Manual** taught.

I fixed a place at the start for a good number of birds, and also a good-sized rearing pen. My first order to the Plymouth Rock Squab Company was for only three pairs of birds. It was my intention to go slow and sure, and let my knowledge increase as my birds increased. I can see what it means to me now in being able to handle any number of pigeons with perfect ease.

After I got started under way, I found myself getting more and more interested. There seems to be something very attractive in it if one once gets fully interested. The growth of the squab is a fast and wonderful development. Any lover of nature cannot help be astonished by seeing it. After one has raised a nice lot of selected breeders, he certainly has done a work to be proud of.

As I advanced in raising my flock, I added now and then a few birds from Mr. Rice to mix in with my own raising. I had such good success, and increased so fast, that many times I found myself wishing I could devote my whole time to them. I little thought then the time would come so soon for me to do so. My birds have done well and proved a perfect success from my start, and I have a fine large flock at present that is a good investment for me. I have had the misfortune to lose my health and have had to stay in a higher altitude than my own home all the summer, leaving my home and birds to the care of my wife and daughter, who have kept everything right up to good success and standard. This proves a family might be left in worse circumstances than having a good, profitable flock of pigeons to help out. My condition has made it necessary for me to give up my home in the valley for one in the mountains, so I am having to give up my position in the manufacturing line and do what I am next best fitted for, and able. If it was not for my squab experience, I don't know what I would take up, for I am prepared for maintaining myself only in a mechanical life. It now looks as if the squab business came to me for a good purpose. I now have nearly a thousand pairs, all Plymouth Rock stock. I am getting fine squabs, very few less than ten ounces, most twelve to fourteen ounces and very often I find a few fifteen, sixteen and seventeen ounces.

HOW WE RID A LOFT OF FLIES AND MICE, by H. J. Moeller. We are living in the trade center of this state (Wisconsin), but the game laws extend over such a wide range of time, that it is a hard proposition to have our squabs bring the right market prices. At present (July) we are receiving three dollars per dozen for squabs weighing eight to nine pounds per dozen, while the same are being retailed for four and five dollars. The prices of grain, however, are reasonable, thus affording us one advantage over the low prices paid. We have arranged to have always about fifty extra nestbowls on hand, so that when the squabs are taken from the soiled ones we can quickly take them out and replace with clean ones. Then if the time does not permit we can put the dirty nestbowls aside and clean them later in the day. After the nests are cleaned we scrub them with a solution of lime and carbolic acid. We also use the crystal form of carbolic acid as a disinfectant around the coop, placing it on different parts of the floor in cans with the tops perforated. This is a quick way to rid a loft of flies and mice, as neither of them can bear the odor. For nesting material we use nothing but tobacco stems in the warm months and marsh hay in the winter. Our loft is given a good cleaning twice a year, and painted a good heavy coat of whitewash. The floor and nests are attended to weekly.

I have just finished the job of whitewashing my pen with a very good whitewash made as follows: Dump a bushel of lime into a water-tight barrel and add water until it is slaked, at the same time adding cup by cup, while the slaking is going on and the mixture is very hot, common kerosene oil until you have added a gallon. If added in this way the oil forms a curious chemical combination with the slaked lime. The product when mixed with water to form a whitewash of ordinary consistency gives a smooth, hard finish, brilliant whitewash. Fill the barrel up with water after the mixture has cooled, when a small amount of the uncombined oil rises to the surface and protects the wash against deterioration. Any unused residue keeps for years. Put the wash made as indicated above on the outside of everything that you wish a brilliant, durable white. On the inside use the same whitewash, modified by adding a third of a cup of crude carbolic acid (purchased at drug store) to the water bucket of the wash. The carbolic acid reacts with the lime, making carbolate of lime, which is the basis of most of the lice powders. This is an excellent whitewash to put on the nestboxes and walls on the inside of the squabhouses.—H. M. Maybaw, California.

Carneaux come not only in red splashed with white, but also yellow splashed with white and solid yellow. These colors are liable to come out at any time, just as several colors come from Homers.



SMALL SQUABHOUSE.

In a corner of the right-hand picture is seen a group of some of his Homers.

PITTSBURG A RICH MARKET FOR SQUABS, by William McK. Ewart. One year ago last March, I purchased twenty-six pairs of Plymouth Rock Carneaux and nine pairs of Extra Plymouth Rock Homers. I had no intention of making a business out of my birds, but bought them to please my son. This started me to making an effort to reach two hundred pairs of birds. Last August I started to kill squabs and have been since selling them to a Pittsburg wholesaler who pays liberally and takes all I offer him. I must tell you what grand breeders my birds have been. By substituting Carneaux eggs under Homers, I have been getting my best birds to lay fifteen times a year. (For full directions for doing this, see page 231 of this *Manual*.) The squabs weigh a pound at four weeks of age, which is what good Carneaux should weigh. Most of my young birds have proven as good and better than my old ones, which goes to prove that my original birds were first class. It pays always to buy the best.

A friend of mine told me about mixing Venetian red in the grit, which has proven a first-class way to give it to them. They must get the red when they eat the grit. I have no trouble now with canker.

Another plan of his is to equip your nests with wire bobs, made from griddle toasters, which cost five cents each. Have these fastened on your nests when squabs are about three weeks old, and keep them there till you are ready to kill at four weeks. This keeps the squabs from getting out on the floor and running off all their flesh and weight. The old birds feed them through these wire bobs which will swing in if you wish them to, thus letting the old bird into the nest. This, however, requires you to let the old bird out to get feed and exercise. I find the cock bird will feed through these wires all right.

While raising youngsters I found that more females were dying than males, so I tried the scheme of taking away the first egg and only hatching the second. As a result I now am actually long on hens.

Four years ago the Healys purchased twenty pairs of Plymouth Rock Extra Homers. The increase was conserved, the culls disposed of, and new stock was introduced and added just as fast as the owners were able to pay for it. The marketing of squabs was also carried along with the growth of the plant, demonstrating conclusively that the profits would be greater, and the expense far less than usual to the conduct of a large chicken plant. The houses, flies and other equipment were gradually gotten in place. As the large stock of poultry was disposed of the proceeds were invested in more adult Homers, and some Carneaux.

The flock has grown until now there are 750 pairs of producing birds in the nineteen units of houses and flies. No more beautiful sight was ever beheld than that presented by these contented and happy birds in their clean and comfortable homes. Shipments of squabs to New York have been successfully made through three summers without the loss of a single bird and no shipment has been re-iced en route. In each box is a tiny outlet for drainage. The rate to New York is \$3.50 per one hundred pounds by express, there being no charge made for the ice. The boxes are returned at a very low charge and one box will make the round trip in six days. The New York market alone would take one hundred birds for every single bird offered. There is no way to fill the demand and there seems to be no limit to the demand. Mr. Healy, the manager, stated that while he had no stock of any kind for sale, he would be glad to see others enter the business, as there is no element of risk encountered in it, and, with fairly good attention and a little capital most any energetic person could make a success of the industry.—T. K. Bates, Florida.

If you raise pigeons get all you can out of them. Raising squabs is a business, so by all means make it a business. You would not invest your good money in a dry-goods business and sit down and expect the business to come to you. If a business man with the big, red-written word of success ever before you, you would fix up your show windows to attract attention, would carry all the newest and best goods, and, above all, you would advertise and advertise well. What applies to one business applies to another. If you go in for squabs, either as your business or as a help to your income, go into it well, and with all your heart. Do not buy your birds and then sit down and wait for results.—Charles B. Durborow, New Jersey.

Your birds have proven to be what you claim them to be. I find also that I can depend upon you with absolute confidence.—Sylvester Grote, Ohio.

POOR JUDGMENT IN MARKETING SQUABS. Members of the National Squab Breeders' Association will be interested in the following letter received from New Jersey: "I take my squabs to a New York supply house, and am getting top prices. I have found out that some breeders are considerably to blame if low prices for squabs prevail. A commission man sold me eight dozen eight-pound squabs for \$1.96 a dozen, and the breeder received \$1.87 a dozen, minus expressage. I sold these squabs at \$3 a dozen, but I can not always do this, as they smelled a rat."

The above is an instance where one squab breeder profited by the ignorance of another. What happened was this: The breeder of the squabs had eight dozen good ones which he could have sold at retail by the use of ordinary intelligence and the directions given by the *National Squab Magazine* for \$5 a dozen, and at wholesale for at least \$3 a dozen. He parted with them at the absurdly low price of \$1.87 a dozen. The expressman or other middleman reported to him that the sale had been made at \$1.96 and took off nine cents a dozen commission, probably figuring at five per cent. The breeder did not get the whole of \$1.87, because the express charges had to come out of that. It reads like an express company sale. All interstate express companies have what is called order and commission departments. They will take any farm produce and sell it on commission. In such cases the wagon starts out from the depot with the goods and the driver calls at a convenient marketplace. It is for the interest of the express company to sell the goods at highest price so that they can get a higher commission but their interest is not nearly so strong as that of the shipper and as a matter of fact, in the case of perishable goods, they are anxious to get rid of the load in the quickest possible time. The buyers know all this and taking advantage of the circumstances, buy at what is practically their own figure. The expressman will put up no argument with them and will not move on to another place but concludes the sale then and there. Franklin wrote: "If you want a thing done well, do it yourself." If you wish your squabs sold properly, sell them yourself; you are the interested party and don't think that anybody else will fight your battles for you.

The man who sold the squabs for \$3 a dozen made his profit because his intelligence was superior to the breeder's. It is a case of knowledge and skill every time when squabs are marketed. It seems incredible that the original breeder was a member of our association.

Some might ask: Was not the commission man to blame for buying the squabs so cheaply? Did he not rob the breeder? It is business, and honorable business, to buy in the cheapest and sell in the dearest market. The breeder was to blame, if anybody, in giving up his squabs so cheaply. He would not have done so, had he known that another breeder would step in and buy, and again sell, at a profit. This lack of

knowledge on the part of any squab breeder is easily remedied by joining the National Squab Breeders' Association, subscribing for the magazine, reading it every month, and remembering what he reads. The subscription price of the magazine for a year can be saved on every dozen of squabs marketed if the reader will sell as we have instructed him to sell.

HOW I CATCH MATES THROUGH PEEP-HOLES, by Arthur H. Penny. I have been in the squab business four years, and have learned by hard experience a few things that may help others just beginning. From my observation, and what I have learned from hotel stewards, commission men, too, I believe that Homers are much the best for the squab breeder, unless he has very fancy private trade. My squabs bring \$4 a dozen for all weighing seven pounds to the dozen and over, and I find this a very good price. If I had all ten and twelve-pound squabs, I could not hope to get very much more for them, and taking into consideration the greater amount of feed required for the larger birds, and the fewer squabs produced, I consider the Homers more profitable. I have never seen described my method of mating, which has proven easy and satisfactory. I have several pens for the youngsters that are boarded all around, with a peep-hole, close by a slide in each door. When the birds are mating, I watch them through the peep-hole, and when I see a pair together in a nestbox, building a nest, I walk in on them quickly, and almost always catch one in each hand. If I am not certain I have the right ones, I let them go and try again. For this method, rather a small pen is best, and not more than one hundred birds in a pen.

COST PER PAIR FOR ME, \$1.60 A YEAR, by G. Allan Sorrick. During the first week in March, with a pen of eighteen working pairs, I endeavored to ascertain the cost of feeding a pair of breeders for a year with feed per bushel as follows: Corn .80, wheat \$1.20, peas \$1.59, millet \$1.38, buckwheat \$1.11, grit \$1.50 per 100. Total pounds fed 30 3-4, cost 57 cents, or \$1.60 a pair a year. One year ago I made the same test, result \$1.80 a pair. I credit the difference to buying feed in larger quantities, and a different method of feeding. The Pittsburgh wholesale prices to jobbers and retailers, which are an advance over prices paid to producers and shippers, were from December 1 to April \$5.50 and \$5.75. Newspaper market quotations \$4.75 and \$5.

Few squabhouses are heated. Cold air, if pure, will not hurt pigeons if they are well fed. It is customary for the old birds to hover their young more closely during freezing weather. If the pigeons are not broken in to cold weather you will find some frozen squabs in the squabhouse if you forget and leave the windows open on such a flock some night in zero weather. The *Squab Magazine* has printed articles written by Canadian breeders telling how they breed squabs through the winter as well as the summer in houses built of cotton cloth.



TWO KINDS OF SQUABS.

The top picture shows Homer squabs ten days old; the bottom a pair of Carneaux squabs almost four weeks old. (The camera was closer to the Homers than to the Carneaux, so they look larger proportionately.)

I received the Plymouth Rock Carneaux ten days ago and the other goods a few days before the arrival of the birds. Everything came to me in good shape and is satisfactory in every way. I am not much given to making testimonials, but I want to say that the birds you sent me are fine, indeed much better than I expected, or bargained for. You advised me that you had now no solid yellow birds, so I was much surprised to find one fine yellow cock and three other birds so nearly solid yellow that the white can be seen only by close examination. I made two entries in the pigeon show I told you about, and won first in class of five. Some of the pairs have already gone to work and have eggs, although they are in the moult.—C. R. Deardorff, Indiana.

Since quail can no longer be served at California hotels and cafes, fine, fat squabs are filling the place at first-class tables. A large squab plant about sixty miles from San Francisco has a contract for all its squabs (large varieties), killed and feathers off, at \$5.50 per dozen. Another gets \$5 alive the year around. When we consider that these birds are but four or five weeks old, and require little or no care except that the parent birds are well fed and watered, it certainly looks well for this growing business. It pays, like any business, to raise the best. When people ship little, half-fed, half-feathered, black-meated squabs, bred from small stock, there is small profit, and no satisfaction to seller, dealer or consumer. The San Francisco papers have all summer quoted squabs at \$2 to \$2.50 per dozen, but hundreds of shippers have been getting from \$3 to \$5 right through, according to size and quality. They pay better than chickens. One squab plant in Sonoma County sends as high as 700 fat squabs per month to San Francisco.—W. A. Bolton, California.

I am shipping Plymouth Rock squabs to a hotel in Indiana. They give me \$3.75 a dozen. They wanted me to sell them by the pound, offering me so much for twelve pounds, but I made one shipment of sixteen Homer squabs that weighed twelve pounds, and they were so well pleased with them, that I finally got \$3.75 per dozen to start, and I think I can contract with them for about \$4.50 per dozen the year round. The parties I deal with send me a check on the first and fifteenth of each month. They will accept even half a dozen squabs at one time. The express charges on my shipments are only twenty-five cents.—Mrs. Ida Kosman, Indiana.

In South Bend, the people like squabs very much, but they do not want to pay more than \$3 per dozen. I sold some squabs in Chicago last summer at \$3 per dozen. I paid the merchandise express rate for dressed squabs until we got a new agent. I asked him what the express rate on dressed squabs was. He looked it up and found that they go at the general special rate, which is less than merchandise rate.—W. O. Bunch, Indiana.

CHICAGO \$4.50 A DOZEN, by Stewart Galbraith. Send the *National Squab Magazine* for another year. I like it and prize it next to the *National Standard Squab Book*, which taught me how to raise squabs at a profit. I live in a suburb of Chicago and get \$4.50 a dozen for my squabs twenty-five to thirty days old, not picked, no express charges, and although I have about one hundred breeders, I cannot begin to supply the demand. I have only the best Plymouth Rock Homers. I use a prepared pigeon feed only, costing \$2 a hundred in half-ton lots delivered. I have an iron kitchen sink sunk in the pigeon fly. The fly is forty-four by forty, nine feet high, and as I have the garden hose attached to faucet in basement and running to this sink with water running slowly all times (except very cold weather) and keep a solution of permanganate of potash in the water, I don't know what canker is. Put one-quarter ounce permanganate of potash in a pint bottle of water and use about one teaspoonful of this solution to one gallon of water.

HOMERS ARE WORTHY THEIR HIGH PLACE, by Harry M. Samson. Only too often the opportunity presents itself for the man with a fairly productive loft of Homers and kindred breeds to launch out upon the sea of uncertainty by becoming interested in some of the larger varieties of squab producers. There are about as many varieties of large squab producers as there are hairs on a dog's tail, some good, others fairly so and many absolutely worthless. It is not size that counts, but the breeding qualities. An old breeder quoted something that seems to ring true, viz., "Other birds may come and other birds may go, but the Homer keeps on forever." Go where you will, one finds the Homer in evidence.

The safe way in shipping is to have a tag of your own printed something as follows: "PLYMOUTH ROCK SQUABS, from JOHN JONES, COLLERS, WEST VIRGINIA, PERISHABLE RUSH, FOR" and then write plainly in ink or indelible pencil the full name and address of the consignee, being sure to put on his street address and spell out in full the name of his state. Inside the box put your invoice, with your name and address in full printed on it, and send him by mail a letter telling him what and when you are shipping, with duplicate invoice.

Sometimes irresponsible grain dealers will doctor peas, and actually make them poisonous for pigeons. Some of the least scrupulous will go so far as to take a lot of cracked corn or other grain which is green with mould and dye it yellow. Such grain will make pigeons sick and kill squabs. Cases of sickness and deaths in the squabhouse are in nine cases out of ten traceable to the grain. One must be observing to detect such bad grain and it is not to be wondered that other causes are imagined. The remedy is to buy grain only of reliable dealers.

HOW TO FASTEN WIRE NETTING, by W. O. Bunch. Take No. 12 galvanized wire and with a pair of common pliers in the right hand and the wire in the left make a ring about three-quarters of an inch in diameter. Then cut off and make another, or as many as you want. These little rings should be open enough so that you can easily put one around the two outside wires of the poultry netting. Then with the pliers pinch the little rings together. Another nice way is to take hog rings and with hog ringers you can fasten the netting together very quickly and neatly.

Question: In my flock of thirty-five pairs of Homers which at one time were all mated and at work, eight pairs have broken up and taken other mates. One male bird has raised squabs with three females, and built a nest with one, leaving her before she laid eggs, making four matings for him in eight months, or less. Is this customary? **Answer:** In every flock there are exceptions to the rule. For that reason, no seller can give mated pairs whose matings are guaranteed to hold absolutely. I think it is a mistake, as I have many times written, to advertise mated pairs guaranteed, for pigeons themselves settle such matters. Moreover, if one sells what he calls guaranteed mated pairs, this means, in the mind of a rascal, that the buyer can hold the seller responsible for profits he might have made if certain pairs had held continuously together, instead of readjusting, as in the above case. That may seem to be far-fetched, but I have seen it tried. The most satisfactory way to sell pigeons is to let the customer try them for a while and, if he is not pleased with them, exchange them, or refund his money. That certainly is fair both to buyer and seller. Anybody who would guarantee the firtings and other love affairs of a pair of pigeons in a pen with many other pigeons has quite a contract on his hands. It has been my experience that those who were the most insistent in guaranteeing such matters have been the slowest in performance. They rectified nothing and in the end, ninety-nine per cent of them went out of business. The reasons pigeons look for new mates occasionally are the same as one sees every day in the human family. The rule among humans, as among pigeons, is that of one wife, one husband, nevertheless there are sailors with a sweetheart in every port, and railroad men with wives at both ends of the line.—Elmer C. Rice.

In Savannah there is great interest in pigeons. The Homers and Carneaux have full sway down here. They are raised mostly for pets and not for commercial purposes. The Homer squabs bring from \$4.50 to \$5.00 a dozen and the matured birds about \$3.00 a pair. The Carneaux bring \$6.00 a dozen for the squabs. The matured birds are \$5.00 a pair straight. The demand exceeds the supply and it is a pity that some large plant is not established here. The hotels sell the squabs as quail.—Timothy F. Sullivan, Georgia.

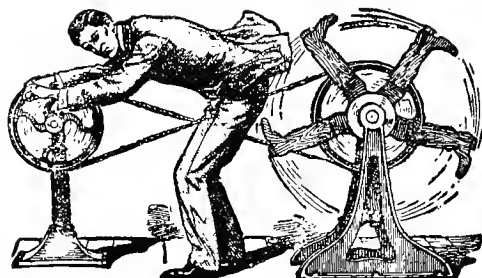

THE PERCY PERKINS ENERGIZER.

The inventor finds use for this excellent machine almost daily, in his work among the squabs.

SPLENDID MACHINE FOR THOSE WHO SELL SQUABS AT LESS THAN COST, by Percy Perkins. Every squab breeder should make use of cheap and simple appliances to help him in his work. A little ingenuity in such matters will save him considerable expense. I send herewith a sketch of a little device which I find exceedingly useful in producing animation in the breeder. It stimulates the thought cells and, incidentally, humiliates the spirit. I have found it helpful in cases like the following, for example. Our butcher called me on the telephone and said he would buy a few dozen squabs if the price was right. I asked him what he considered the right price. He replied in turn by asking me what it cost me to raise a dozen squabs. As I have not raised any yet, I was in some doubt, not to say perplexity, but I promptly rejoined that each batch cost me, as near as I could figure, about two dollars a dozen. Thereupon he said he would give me \$2.10 a dozen, which would allow me a profit of five per cent, which is more than government bonds pay. I told him his argument was good and that I would accept and give him a few dozen at his price. He asked how soon I could send them and I was obliged to reply that I would not have any ready for market until probably about February, 1912, as I was experimenting with a lot of young birds and wondering how many cocks and hens there were, and when it would be likely that they might reach adult age. He hung up the receiver with a fearful oath and I then repaired to the corner of the squabhouse where I have my machine set up, and exercised violently with it for half an hour, to remove the vexation caused by my failure to make that five per cent profit. I think the price the butcher offered me was a very fair one, as it would have enabled me to see several dollars which I could view in no other way.

A word of appreciation from a conscientiously handled and well satisfied patient never made me mad yet. Possibly a little of the same thing from a customer of yours won't hurt your business feelings any. Six months ago I bought your *Manual*. Before that I knew as much about breeding squabs as you do about medicine, and probably less. After reading it over three times I ordered three pairs of Extra Plymouth Rock Homers, which arrived April 14, 1911. 1. From these three pairs in just six months I got the following results, viz: Seven and a half pairs killed for personal use and sale, one and a half pairs banded, two pairs eggs in nest now, besides one egg broken in two different nests, and parent birds deserted nests. 2. From six pairs Extra Homers bought of you May 4, 1911: Twelve and a half pairs killed, two and a half pairs banded, two pairs eggs deserted, one pair in nest. 3. From six pairs bought of you June 8, 1911: Nine pairs killed, one and a half pairs banded, one pair eggs deserted, one pair in nest. For the squabs killed I have received on an average one dollar per pair. The squabs I banded were all very large. Kept and moved to a separate pen to mate and save for breeders. I have fed whole corn, kafir corn, red wheat, cracked corn, Canada peas, barley, and twice a week rice and hempseed, feeding twice daily, except when I didn't get home before dark, which happens about twice a week. My birds have had no lice or disease, and are strong and vigorous. The house is cleaned weekly, and they have a bath in the middle of every pleasant day, also a constant supply of rock salt, fresh water, hard grit and fine oyster shell. Average time I spend every day is about ten minutes morning and afternoon, feeding and watering, and two hours once a week cleaning squabhouse. This is a greenhorn record of a small squab plant that is a source of recreation and pleasure, and a fair return to a man who is **decidedly not making a business of squab raising**. If my birds go through the winter safely, I shall give you a good order in the spring, for I can handle three times as many as I have now with little or no more demand upon my time.—**Dr. Howell S. Bontecou, New York.**

Your *Manual* has been of the greatest assistance to me, and since adopting your methods and style of housing, a great improvement has taken place in my pigeons, although I am anxious as soon as possible to get some of your birds, as the demand for squabs is growing here, and will be just as profitable here in the course of a year or two as in America. I have the best birds it is possible to get here. I have 170 pairs with accommodations for 400 pairs. I want to send for some of your stock.—**D. R. MacDonald, Australia.**

HOW A MARYLAND WOMAN COOKS SQUABS, by Mrs. Clara M. Hodson. I recently furnished the squabs and recipe for preparing them for a spring luncheon. I cannot always fill my orders for fresh birds. Here are two of my squab recipes:

Grandma's Pigeon Pie.

When I was a little girl, I went from the city every summer to visit my grandparents, living on a large farm on a beautiful river in Maryland. There was an old mill on this place of the Dutch type of wind gristmills. It had gone to decay and become a rookery or pigeon loft. I would climb up and gather the young squabs in a basket and take them to my grandmother, and then we would anxiously await dinner. This is the way she made it: After the bird had been shorn of feathers and drawn, it was split down the back with a sharp knife and pressed flat, or cut in half, as many preferred half a bird, and it serves better. Placing the birds in a large stewing kettle, she covered them with water, cut up a very small onion, and a tablespoonful of minced parsley. This she added with salt, and a tiny piece of red pepper pod, to the cooking birds, about ten or fifteen minutes cooking.

Having made a nice pastry, she lined a large round baking pan with it, and put in the birds and stock. Adding a large lump of butter, half a cup of flour for thickening, and a cupful of rich milk or cream, she would cover the whole with fine pastry, touching here and there with a little butter, and bake until it was a golden brown, serving very hot at the midday dinner with fresh vegetables and plenty of fruit. About it there are pleasant memories.

Roast Squab with Peas.

Select medium-sized, fat squabs, draw and wash thoroughly, cleansing the mouth and bill carefully. Tuck the head under the left wing, bending wings close to the sides of the birds. Make an incision in which to tuck the legs, after cutting off the feet. Stuff the birds with minced celery (or minced celery and bread-crumbs), salt and pepper birds and rub with butter and a little flour. Place them in a shallow baking pan with just enough water to keep them from burning, and roast about twenty minutes in a hot oven, frequently basting with the juices drawn from the birds. Serve whole or individual plates with a garnish of water cress and two tablespoonfuls of sifted or very small peas. Celery gives the flavor of the canvasback duck to the squab, and the whole makes a very acceptable spring luncheon.

Question: Please tell me the proper proportion of grain to feed my pigeons, so as to obtain the largest squabs. My squabs although they have been as large as a pound apiece when four weeks old, now scarcely weigh half of that.
Answer: The feed has a great deal to do with the weight of the squabs. If your squabs are running light, you should cut down your wheat and feed more corn, Canada peas and bread crumbs, all of which are fattening.

HOW I STARTED A BOYS' PIGEON CLUB, by Reuben Brigham. Knowing how much pigeons have meant to me, I have been always glad to help other boys to learn to care for them and stick to them. About a year ago, the pigeon craze struck the boys in this Maryland neighborhood, and I helped organize the Sandy Spring Pigeon Club with thirteen charter members, all being boys under twenty-one excepting myself. Our object was "to encourage the keeping of pigeons in this neighborhood and to promote the more intelligent and profitable care of those already in our possession." We agreed to meet every other Friday night and to admit only bona fide pigeon keepers. Strangely enough, after the first enthusiasm waned, the attendance and interest continued and it is rare that more than one or two members are absent. Minutes are read, short papers are written and delivered, and pigeon papers subscribed to and studied.

MUSLIN WINDOWS FOR ME, NO GLASS, by W. E. Blaklee. Last fall we put up on our new mountain site a building for our Plymouth Rock squab breeders, two hundred feet long, twenty-four feet wide, with a four-foot wide alleyway lengthwise in the center. Over this alleyway the whole length of the building is a lantern with windows in its sides. All the doors for the pens are only frames. The ones on the alleyway are covered with wire. The outside ones opening into the flying yards are covered with muslin. The windows in the lantern are also frames covered with muslin. At each end of the alleyway is a tight-boarded door swinging out for winter use, and a wired frame door swinging in for summer use. The way the doors and windows are arranged makes sure of no direct circulation across the nestboxes. There are no drafts from the use of muslin, but we do plan not to have any direct line of circulation across the nests. Our building is on posts six feet above the ground. The floor is double boarded with paper between. This gives a thorough ventilation underneath and the whole building is perfectly free from any ground dampness whatever.

Just two years ago I bought four pairs of Plymouth Rock Homers and ten pairs of Plymouth Rock Carneaux. I have thirty-five pairs of Homers (sold all the rest for squabs) and four hundred Carneaux—sold seventy-three. So you can see that for a beginner I have done fairly well. I never have sold a squab for less than twenty-five cents, and never had enough of them to supply my neighbors. I have just bought five acres and hope to build up a good business. Will want more birds before the first of the year.—W. C. Barrett, California.

Have some cards printed with "Eat Squabs and Stay Young" on them. Send these to all the women in town who are financially able to eat such; and explain in brief why squabs are the best meat. Be sure that you have an extra supply on hand when you do this.



MR. STEWARD AND HIS BIG PLYMOUTH ROCK HOMERS.

SQUAB BREEDING FOR A STAY-AT-HOME MAN, by Charles E. Steward.

Three years ago today I was stricken with heart trouble and not being able to do any work of any account, I sat around the house and did nothing but worry about my trouble so I thought I would get a few pairs of Homers to keep my mind occupied. I sent to Boston for twenty-five pairs of Homers and one pair of Carneaux. Today I have two hundred Homers and twenty Carneaux. Last summer I kept eighty youngsters for breeders, all banded, and left them to choose mates for themselves. Out of the eighty I got thirty-seven pairs and six odd mates. The best part of it was there were no nestmates that went together. I put twenty-five pairs of these young birds in a pen by themselves. Today, June 21, I counted forty-eight young ones and nineteen eggs. This shows that some birds have both young and eggs. Can any one beat it? This shows that it pays to buy good stock to start with. As squab breeders I think the Plymouth Rock Homers can not be beat (if they have the attention). My birds get fresh water twice a day and all the green stuff they will eat, such as lettuce, horseradish leaves and dandelion. For nesting material I use tobacco stems and hay cut about six inches long. I notice that when you use only tobacco stems they become hard and dry in the nests and when a bird happens to bear much weight on the eggs you will find a good many eggs broken with a little dent or crack, and won't hatch. This is because there

is no "give" in the tobacco stems. When it is dry, mix hay or straw with your tobacco stems and see if you haven't less broken eggs.

My first squabs I sold all sizes for \$3 per dozen. I am now selling eight-pound squabs at \$5, nine-pound squabs at \$6, twelve-pound squabs at \$8 per dozen, less express and commission. I have nothing in my pens breeding less than six pairs per year, averaging nine to twelve pounds per dozen. The Carneau-Homer cross makes a large squab, also Maltese-Homer, but I would not like to keep them for breeders because a well-established breed is so much more reliable in reproducing its characteristics.—Mrs. W. A. Roth, Indiana.

I have been in the squab business for some time and have done fairly well, but after visiting a number of small plants find they all use the Plymouth Rock Homers. Now what I want to know is if you will trade me Extra Homers for forty or fifty pairs of red and splashed

Carneaux, most of the Carneaux I have being from parent stock that came from you and bought by a doctor of my town. I want to put in these two pens and buy them, and if satisfactory I will sell my other breeds and replace with your Homers. One of your customers was at my house last evening and he told me that your Homers are certainly first class, and of course I want the best.—George Sisco, New Jersey.

HOW I SAVE MONEY BY FEEDING BREAD, by Chariton Green.

I have been feeding bakers' discarded bread, crushed dry or moistened. The pigeons like clean bread and white bread better than rye bread. Besides bread, I feed about half a pound of Indian corn each day. I find the bread an excellent feed for squabs that are just out of the nest. They learn to eat it much quicker and easier than they do grain. I have noticed squabs in nests with it also. I believe it is as good for squabs in nest as it is for the older squabs or youngsters. I don't believe a better feed could be fed to youngsters. The bread costs me one cent a loaf, or from \$1.00 to \$1.10 per one hundred pounds.

Take a piece of paper, wrap it around a pencil, glue and pull the pencil out, dip the paper in pulverized sulphur, hold the mouth of the bird open with thumb and first finger, and blow the contents down the bird's neck once a day for a day or two, and the canker is gone.—Harry Wesner, Pennsylvania.

PEA VINES ARE BEST NESTING MATERIAL, by C. S. Persons. In nesting material I have used nearly everything, and I have found that the common pea vines which every one raises in gardens and throws away or burns are their choice. They will leave anything else for them. After I have used the peas I pull up the vines and thoroughly dry them, then cut them in lengths of about six inches, leaving as many of the leaves on as will stay. Sweet pea vines are equally as good.

In regard to green food, clover, lettuce and Swiss chard are their favorites and a fine tonic as well. A ten-cent package of Swiss chard (or cut-and-come-again spinach) will feed seven hundred birds from June until the third or fourth frost, as it is very hardy. They will pick the stems clean and leave only the stalks. I feed lettuce the year round, in winter buying it by the crate once a week. I feed clover through the summer.

With regard to a market for squabs, the Chicago commission men are paying from \$2.75 to \$3.25. I do not blame the commission men for buying at these figures but I do blame the producer for selling, for with everything as high as it now is, and after deducting express charges and labor, what has the breeder made? He has simply lost money, and the commission man is getting the benefit of the failure to hustle.

HOW TO WASH OUT THE SQUABS' CROPS, by Henry Blake. A handy and quick way for cleaning the grain out of crops when washing squabs is easily arranged if you have piped water supply. Have a fitting made to screw on the bib-cock. One can go to the expense of having a special fitting made. A cheap way is to tinker one up by using an old hose coupling. Solder a piece of bent small tubing into it.

To use it, hold the bird's head down, putting its mouth over the tube, set the water running slowly, work the bird up and down a few times, so the tube goes well up into the crop, and the job is done. If one does not have the water pipe, he can use an elevated reservoir either hung up or put up on a bracket.

I stew squabs until tender and done, in water seasoned with salt and pepper to taste. I bake biscuits a delicate brown at the same time, being careful not to make them too thick. Take up the meat, add a little milk to the soup, being careful not to put in enough to weaken it, add salt, butter and pepper to taste; thicken with flour, making a medium thick gravy. Split the hot biscuits and add to this hot gravy. When well saturated take up and place hot squabs on top. Serve. Delicious! I have used in this way, too, rabbits and chickens.—Mrs. Dora B. Badger, Washington.

Do not keep extra small squabs for breeders just because their parents are fine birds—all birds will raise offs sometimes.

NOT TRUE TO COLOR, by Ralph Walker. I have a pair of Homers, the male being pure white, and the female black all over except one white feather in the back and a few on each leg. I have had only one pair of squabs from them that were of the exact color of the parents, and they were of different hatchings. Even then the male was white and the female black. Among the pigeons raised from them I have had the following color combinations: Dark brown, female; several light red pigeons, both sexes; heavy booted, solid silver female; black with white on tips of wings and at base of tail and various other places, both sexes; light brown with dark brown bars, female; and also a big dark blue cock with a shiny red blue breast. Don't you think this is a pretty good color combination?

Question: Of what value are pigeon fairs and exhibitions in advertising to sell breeding stock? Are the money prizes enough inducement to go to the expense of exhibiting? **Answer:** The value of pigeon and poultry exhibitions as an advertising medium is something to the breeder who relies for sales on persons who come to visit him and look at his stock, but such results are practically nothing in comparison to the results obtained from periodical and newspaper advertising. Pigeon and poultry shows are an interesting neighborhood enjoyment, bringing good stock of each section together for comparison and gossip. The money prizes are never of themselves of any particular value, certainly not enough to recompense one for the time and effort expended. One should go into a poultry and pigeon show with the idea of making a week of enjoyment for himself and his family, meeting others, seeing what they are doing, etc., but not with the idea of making himself rich or famous, for that never is accomplished by exhibitions alone.

Question: I have been reading a story written by a woman who lost money raising poultry and squabs and her figures of production do not agree with those given in a bulletin which I have. **Answer:** That is why she failed. It is always assumed, in such writings, that intelligence, skill and industry are factors, but one who fails in these branches is seldom either intelligent, skilful or industrious.

I have benefited much from the **Magazine** and am selling my own squabs to private trade for fifty cents each, dressing five cents extra, and ten cents for delivery; Carneaux squabs one dollar each, and have all I can do. Plymouth Rock stock.—Miss Marion S. Baker, Massachusetts.

The general wholesale quotations on squabs here (San Francisco) range from \$3.00 to \$3.50 per dozen, although some extra large would bring \$3.75. They can be handled better alive than dressed at present. Trade would prefer to do their own dressing.—Harbaugh & Co. (Wholesale Dealers), California.

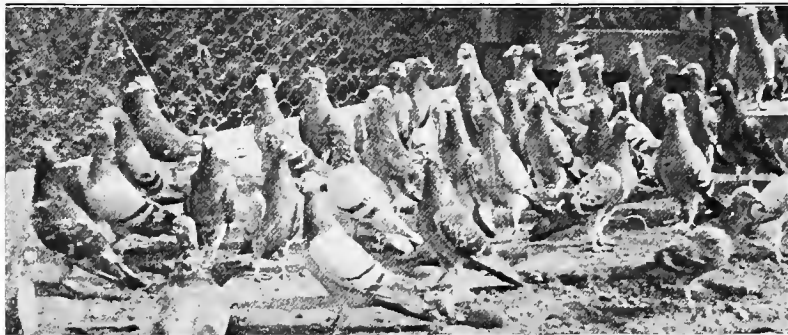

A PEN OF FIRST-CLASS HOMERS.

SQUAB COST AND PROFIT, by H. C. Frankforter. For the last few years I and a friend of mine have been raising squabs and find that there is profit as well as pleasure derived from them. We buy feed from a Baltimore firm which costs us till we get the freight paid \$2.25 a hundredweight. We have tried it on a separate pair of Homers and find that they ate nine cents worth of the feed from the day the young were hatched until they were salable, so we made it fifteen cents for labor, feed and health grit. We receive from \$3 to \$3.25 a dozen for our squabs, so you can see that the profit would be from thirty to forty cents on one pair of squabs.

"Market reports" are generally furnished to the newspapers by the produce exchanges and in every case are not a record of true transactions, as are the stock exchange reports, but are the lowest prices which the members of these exchanges hope to pay for chickens, squabs, fruit, potatoes, etc. If you live in a city where such inspired quotations for eatables are being printed, write to the editor and tell him that as a subscriber to his paper you object to such information as being misleading and untruthful, and published in the interest of the marketmen, with no thought of the producer. This will help to bring about a much needed reform. Not every newspaper will stand for such "market reports" nonsense. The best send out a man or woman reporter to shop and write what they find. Prices of eatables obtained in any other way are inaccurate and false. If there are any squab or chicken breeders who are fooled into selling at such low prices simply because they have seen those quotations "in print," they ought to have a guardian. Get your retail prices by actual shopping and then make a fair deduction to get at the wholesale prices.

DURABLE WHITEWASH. A whitewash adopted by the United States Government and used for coating light-houses and keepers' dwellings, is composed as follows: To ten parts of freshly slaked lime add one part of best hydraulic cement. Mix well with salt water. This whitewash when properly mixed and applied, produces a clear white that does not easily rub or wash off.

I sell all my squabs to private families and sell all I raise. In winter time the prices run from \$4.50 to \$5.50, in summer \$3.50 to \$4.50. Every Tuesday morning I 'phone to every customer one after another until I have my forty-seven customers called, and then I have a boy hired to deliver the squabs. I have a one-horse wagon, painted orange color, trimmed black, and have a very showy horse, which makes a good appearance. It looks very tidy. I feed a mixed ration which I buy for \$28 a ton. I sold over 5700 squabs last year, took in \$1575, cleared about \$1000. Not so bad for the boy and me.—J. M. Shellenberger, Pennsylvania.

I inquired the retail price of dressed squabs of Robert Barron, a Yonge Street fish and game dealer of Toronto. He informed me that the price was fifty cents each, or \$6 a dozen. Mr. Shelts sells his squabs to the dealer whom I mention at \$4 a dozen. There is a large demand for squabs in Toronto, as it is a city of 400,000 people.—Charles Watson, Ontario.

During the past fourteen years I have had considerable experience, always as a side line, in selling eatables to family trade, and the only way I ever succeeded in obtaining a customer was to go right after them. The personal face-to-face interview captures the trade.—Raymond W. Dotts, Pennsylvania.

I FEED A GREAT DEAL OF SWISS CHARD, by Hugh Steele. The market here (Kansas) is not very good yet, but is improving. I think a few good marketmen would make it the equal of any, as with all the large cities surrounding us, and very strict game laws being made, the demand is sure to come very fast. Our grain market is rather high: wheat ninety cents, corn eighty cents, kaffir \$1.50 per hundred. Canada peas cost about \$2 per bushel here and hemp sixteen pounds for \$1. I feed a great deal of Swiss chard, which seems to be relished very much. A small bed will supply a large flock, as it is a very rank grower.

GOOD SQUAB DEMAND AROUND PITTSBURG, by James G. Bennett. It costs me about \$1.40 here (Pennsylvania) to feed a pair of breeding pigeons that raise from eight to ten pairs of squabs a year. That is the cost with good feed. Do not ever feed old or musty grain. In their free state, pigeons can select a variety of grain and seeds, but when they are kept in flying pens, they must, of course, take what they are given. While you may have seeming success for a time feeding only cracked corn and wheat or any other two grains selected, yet a long continued feeding of such invariably fails to produce as many or as good squabs as when a properly balanced ration is provided. Always have oyster-shell and the best of grit before them, and I find it very healthful to mix a little air-slaked lime and Venetian red with their grit. The lime sweetens their crops and helps the same as oyster-shell in producing eggs. I find kerosene oil and turpentine in equal parts good for canker, two or three drops to a dose. There is a fine outlet for squabs in this section, Pittsburg being the main market. In fact all along the three rivers here there is a good sale for squabs, as there are so many hotels and clubhouses. The supply cannot more than half meet the demand. The price paid by the wholesalers in Pittsburg is \$5.25 a dozen for twelve-pounds-to-the-dozen squabs.

ONE BOY'S WORK, by Roland Ralph. There is not a very good squab market in Richmond, Va., but I can make two hundred pairs pay me a good profit. I have made twelve hundred dollars clear profit out of three chicken incubators, twenty-two turkeys and a small root beer plant on two acres of ground, which father gave me, and I worked only after school and vacation time.

I am situated near the city of Chicago, and I think I have a golden opportunity facing me. Upon having a personal interview with a steward of a certain hotel in Chicago, I was informed that squabs were as high as \$7.50 per dozen this summer. The commission merchants were paying \$3.50 last week.—W. G. Puls, Illinois.

I bought thirteen pairs of Plymouth Rock Homers, part of them a little over a year ago, and the others will be two years this fall. I now (June, 1910) have 250 all told.—R. C. Brenner, Illinois.

HOMERS BREED BETTER IN DARKENED PEN, by Richard L. Fishburne. I have found by experience that my breeders do better work in a loft slightly darkened. My buildings face south, are 10 x 15 x 10 feet, with a fly about the same size for each pen. Around the fly I have planted sunflowers and sweet peas which add to the attractiveness of the place, at the same time affording shade for the birds, keep dampness from the fly and loft and give me a quantity of feed. Once each week my lofts are scraped and sprayed with a ten per cent solution of creolin, and air-slaked lime scattered on the floors. A few applications of this solution will soon saturate the wood and positively prevent any lice in the lofts. About once or twice a week in the summer I use a small quantity of creolin in the bath water and in spraying any birds or squabs that are near, spray without injury or frightening them.

The reason Plymouth Rock Homers are so popular is that the squabs they produce are good enough for any market. In many hands, skilful in feeding and selection, they do the work of more expensive breeds costing three times as much, and more. We have a letter dated August 23 from a customer in Connecticut, John N. Moeller by name, stating: "I intend to purchase a piece of property and erect a large plant and buy stock of you as soon as I find a satisfactory place to sell squabs in large lots, and regularly. As already stated in previous correspondence, I have raised twenty squabs from three pairs since March 12, 1910, and every one weighed one pound alive at four weeks of age." Mr. Moeller does not say that some weigh a pound apiece, or that the average weight of his squabs is one pound. He states that every one weighed one pound. This is twelve pounds to the dozen. The sales of Plymouth Rock Homers are many times more than all other pigeons combined.

As we have before written, always remember that prices of pigeons mean nothing without service. We throw out twenty-five per cent of all our pigeons, sending them in as culls to market, where we get only the eating price. We don't put them into shipments and expect the customer to throw them out. Moreover, we don't keep our best pigeons. Every bird on our farm is for sale. Anybody who calls there and fancies a bird can take it away with him in a coop and we're glad to see it go.

My present squab plant consists of 300 pairs Homers, and a few larger breeders, but no Carneau. I have been visiting various squab plants in the country, and know what a good Carneau is supposed to look like. Most of the Carneau that I have seen do not come up to what I call good Carneau. The best that I have set my eyes on so far are those owned by M. C. Martin, and he told me that they were from you. Enclosed you will find a bank draft for which please send me the eleven pairs of Carneau under the conditions stated.—J. E. Unruh, Kansas.

MY PLANT MAKES \$100 MONTHLY PROFIT, by W. A. Bolton.

The Sunny Slope Squab Farm is shown in the accompanying photograph. The writer having been interested in pigeons since his school days, when he kept a few for pets, resolved in 1908 to make it a business and made his first mistake by sending to Europe for his Carneau and Homers, several hundred of them, with the result that about half of the birds died en route, or just after they arrived. They are splendid birds and after a few months became recuperated and acclimated and proceeded to do their best, but if they had come from good reliable home breeders or eastern breeders, the results would doubtless have been much more satisfactory. Last year the plant practically paid for itself.

Today there are about 1400 birds at work, and taking care of some 1400 more young and old that will soon be at work, besides netting about \$100 a month profit. The demand for breeding stock has been brisk since the squab prices dropped, so that but few squabs have gone to market.

Our Carneau youngsters bring from \$10 to \$15 per dozen and Homers to the market bring \$3 in summer and \$4 in winter. Next year, I expect to contract all our squabs at \$5 a dozen the year round, not including the Carneau which are likely to go for breeders as they always have done.

I saw the books of one poultry dealer in San Francisco recently, showing where he gets \$7 per dozen from one of his customers for large squabs. He pays \$3 for the same, alive.

The majority of raisers ship alive to San Francisco and Oakland, and the coops that produce best results are not over six inches high in the clear. This prevents the birds piling upon each other.

BOSTON 1911 SQUAB PRICES. The following figures for 1911 taken from the *Boston Globe* show the prices for squabs from January to December of that year. The first price quoted in each case is for the poorer grade of squabs. The prices quoted highest in each case are for squabs bred from our Extra Plymouth Rock Homers and Carneau. These figures show that the Boston squab market, like that in other cities, is steady all the year around at highly profitable prices, in no case falling below \$3 a dozen, this price coming in the summer, when squabs may be sold at summer resorts in New England at prices equal to the best winter Boston city prices: January 6, \$5, \$6.50; January 13, \$5, \$6; January 20, \$5.50, \$6; January 27, \$5, \$7; February 3, \$5, \$6; February 10, \$5.50, \$6.50;



A CALIFORNIA HILLSIDE SLOPE SQUAB FARM.

March 3, \$5, \$6; March 19, \$4.50, \$6; March 24, \$5, \$6; March 31, \$5, \$6; April 7, \$5, \$6; April 14, \$4.50, \$6; April 21, \$4, \$6; April 28, \$4.50, \$6; May 5, \$4.50, \$6; May 12, \$4.50, \$6; May 19, \$4, \$6; May 26, \$4, \$6; June 2, \$4, \$5.50; June 9, \$3.50, \$5.50; June 16, \$3, \$5; June 23, \$3, \$5; June 30, \$3, \$5; July 7, \$3, \$5; July 14, \$5, \$6; July 21, \$3, \$4.50; July 28, \$3, \$5; August 4, \$4, \$5; August 11, \$3.50, \$4.50; August 18, \$3, \$5.50; August 25, \$3, \$5; September 1, \$4, \$5; September 8, \$4, \$5.50; September 15, \$3.50, \$4.50; September 22, \$3.50, \$4.50; September 29, \$3.50, \$4.50; October 6, \$3.50, \$4.50; October 13, \$3, \$4.50; October 20, \$4, \$5.50; October 27, \$4, \$6; November 3, \$4, \$6; November 10, \$4.50, \$6; November 17, \$4, \$6; November 24, \$4, \$6; December 8, \$4, \$6; December 15, \$4, \$6.

When a beginner, like Etwinoma Farms, takes 25 pairs of our Extra Homers worth \$50 and in two years multiplies them to 800 pairs worth \$1600, do you realize that this is a big return? You can't put \$50 into any bank and get \$1600 back in two years. And remember, that in the two years squabs enough were sold to pay the entire running expenses of the plant. Fifty dollars increased to \$1600 in two years is thirty-two hundred per cent increase. This is not theoretical, but is the record of something which actually has been accomplished with our Plymouth Rock Extra Homers. This is only one of hundreds of such phenomenal returns.

After you have read this **Manual**, write us a letter telling us how you think it can be improved. Is anything lacking? What do you wish to know that is not covered here? We intend to keep the book full and complete from year to year and welcome suggestions for its improvement. Tell us what your plans for squab raising are and let us help you if we can.

SQUAB MARKET UP IN SALT LAKE CITY, by J. H. Armstrong. I will try and tell you something of the squab and its market in Salt Lake City. It has been only within the past few years that the squab has had a place on the tables of our private families. Only the hotels and restaurants knew what it was to have squabs to serve to their fine trade, but today the squab will be found on the tables of those who can afford it, and, in fact, on the tables of a good many who can not. The squab of today is taking the place of the young chicken. The demand is growing and the "hello" for squabs is getting greater every day. I have only one hundred pairs and I cannot breed enough squabs to fill my orders, so I am buying from other parties, and even then my supply is limited; I cannot get enough. I am looking forward to the time when I will have two thousand squab breeders instead of two hundred. I am working slowly, but it is steady.

This past week's market (July) has been good with prices as follows:

8-lb. squabs per dozen, \$3.00 hotel and restaurant.

9-lb. squabs, \$3.50 hotel and restaurant.

10-lb. squabs, \$4.00 hotel and restaurant.

10-lb. to 11-lb. squabs per dozen, \$4.50 to \$6.00 family trade.

These prices I have fought for the past three years (credit to the magazine) as I could not get other squab raisers to stay together on the prices until the last few months.

New Yorkers are spenders, and money is no object when they desire something that appeals to their appetites. Go where you will, squabs will always be found on the bill of fare. The demand is simply enormous, as thousands of birds are consumed daily and the demand is continually on the increase. The trouble has been to obtain a sufficient quantity to supply the demand, and I have heard it stated that birds actually were imported to satisfy the demand for extra large squabs. Here is an excellent opportunity for the wide-awake, up-to-date breeder who is in a position to deliver first-class stock to the consumer direct. A veritable hidden treasure of practically unlimited profit awaits him. Just think of the prospects, with our industry still in its infancy.
—Harry M. Samson, New York.

We have been selling a few Plymouth Rock squabs in Louisville, Ky., at \$3 a dozen. The men we sell to say they are the finest they ever handled. As soon as we can get enough to make regular shipments we intend to send them away, as we were offered \$5 a dozen for them in June. We keep a strict account of all expenditures in our large single entry ledger and find it costs about ten cents per pair per month to feed them.—James C. Martin, Indiana.

We have no ground oyster shells here, so we use ground clam shells.—Miss B. Devereux, British Columbia.

EGGS AND SQUABS DUE TO CONDITIONING. I am inclined to think that there is such a thing as introducing too much red tape in this business of mating and tabbing birds so as to make the task too burdensome. It would be a nice thing if you would give us a line once in a while as indicating where system leaves off and red tape begins.—J. C. Broadwell, Oregon. Pigeons will breed naturally if you give them a chance and if they are in condition. Novices who have had no experience with poultry cannot be made to comprehend that the production of pigeon eggs is a study in conditioning, the same as the production of hen's eggs. Poultrymen also have their matings but they know enough to look to condition and not to the sexual relations for eggs. Pigeons should be banded, but the system of record keeping should be simple and end in the squabhouse, not be carried into evening work under the study lamp. The most important work, as the *National Squab Magazine* has demonstrated, is to sell the squabs intelligently. Squab breeders who fuss about the small matters never accomplish anything.

TRANSFERRING BREEDERS, by Ida Dana. I have been transferring my breeders from the house in which they have been working since I received them in May, to one better fitted for the winter. I have been careful to take each family when the youngest squabs were two weeks old, before the mother had started her new nest. When I placed the squabs in a nest in the same part of the new room as that occupied by their nest in the old room, the parents never failed to recognize and feed them. It was before I understood the necessity of this arrangement that one pair, neglecting their own squabs, fed those in the place in which theirs should have been. I granted their wish by putting their squabs into that box, and had no further trouble.

FACTS ABOUT NEW YORK FRESH SQUABS, by William R. McLaughlin. I get a great many letters during the year from timid beginners and also from old breeders that indicate they fear to make heavy investments at the start or doubt the advisability of increasing their flock for fear of overstocking the market. To all such inquiries I urge them to go ahead and increase their flocks of breeders so that they can ship every few days from five to twenty-five dozen squabs at a time. They run no risk as to demand at good prices all the year round. They run no risk of overloading the market.

I have had extraordinary success with Plymouth Rock Homers and am more than pleased with the results. I have met with ready sale for my squabs, and if I had the space would increase my flock. I sell my squabs locally and get \$3 to \$4.50 a dozen, in other words fifty to seventy-five cents a pair. My squabs will average in weight nine pounds to the dozen, in fact in some instances had them to weigh fifteen and sixteen ounces.—H. H. Kangeter, South Carolina.

HOW I FEED HEALTH GRIT FRESH DAILY, by M. C. Martin. When I first started to feed health grit, as it was rather expensive, I was not very particular about the birds eating very much of it. So I would fill a covered trough with a good quantity. Result, pigeons would "go some" for it, when first put in the trough, but would soon eat the choice ingredients, and care little for the leavings. Also, after water was poured on for several days, the grit became packed and hard, and the birds would pay little attention to it. In this way a sack of grit lasted a long time. But I began to study my birds, and found that when they ate more grit, they were healthier and heartier. Then I began to experiment and after thorough trial have settled on the following method:

Provide covered wooden troughs about four or six inches wide and two inches deep, and long enough for all the birds in each pen to eat at once. The top of the trough may be made so as to be lifted off or removed when putting grit in the trough.

Once a day feed the grit in the covered troughs and the little birds will soon learn to come for it, and make more fuss about it than when you feed them hemp. Give them grit once a day just what they will eat up in a few minutes.

With a little experimenting you can soon learn about how much is best for them. For, by this method, you can overfeed them easily.

I use five-gallon cream cans to keep the grit in. Pour in a little water and keep closed, and in this way, the grit is always damp and moist, ready to feed. Grit should be bought in 500-pound or ton lots, thus saving on the freight bill.

Now, as to the reasons for using health grit. I find the iron in it enriches the blood corpuscles. The small sea-shells, which it contains, I have noted, make better hatching eggs, as too much crude lime, contained in oyster shells, makes the eggshells have large white deposits on them, causing the eggs to be easily broken. Such eggs seldom hatch, and if they do, the "peepers" usually die. Another thing I have noticed is that the birds seldom if ever have sour crop, a common ailment without a liberal use of grit.

If you follow the method I have explained here, be careful you do not feed too much. A good, large handful once a day is sufficient for a flock of thirty birds. The other way of feeding as used by most squab men is to put a large quantity in a covered trough and leave it a number of days until it is all eaten up.

SAVES WIRING TIME, by Louis A. Hart. Instead of the old method of tying every other mesh of the wire netting with a short wire, or even running a long wire all the way through the entire length of strand, just take an eight-penny nail and twist it around the two wires three or four times, causing the wires to weave together the same as the rest of the netting. It is very fast, also simple and entirely safe. To undo, just reverse the operation.

PREVENTS STICKING, by C. C. Fraser. I find it a good plan to dust the nestbowls with buckwheat hulls or tobacco dust. This prevents the manure from sticking to the bowls and makes the cleaning much easier. If nothing like this is used, the work of cleaning the bowls is quite difficult.

One of our customers in New York State, Henry Blumers, who bought a big flock of our Homers and Carneaux last year, has raised sixteen squabs from one pair of our Carneaux in a period of seven months. This is how he tells the story: "We noticed in the magazine a party in California having sixteen squabs in ten months, so we thought we would send you the record of one of the pairs of Carneaux which we purchased of you last fall. They hatched: January 10, two squabs; February 9, two; March 14, one; April 22, two; May 7, one; May 25, two; June 27, two; July 15, two; July 31, two; and now at the present writing (August 23) they have a nest started with one egg. We call this the champion pair of the five hundred and fifty pairs of Homers and Carneaux which we bought at that time."

A man in business judges his correspondents by their style of correspondence. Anybody who wishes information of an advertiser should write him a letter, not a postal card, and enclose a two-cent stamp for his reply. If the advertiser has a stenographer, it will cost in her wages at least five cents to write the letter, not to mention the postage as well as the time of the advertiser in dictating or writing the letter. Every advertiser gets a great many foolish and needless inquiries which are a constant burden of expense, and scores of such correspondents are productive of no business. Hundreds of questions asked daily are fully answered in printed matter sent out by the advertisers. Another point to remember is that advertisers cannot reasonably be asked to make estimates of what the inquirer will do with certain pigeons, or in certain contingencies which come up in daily work in the squabhouse. The only way one can find out what one can do, is to do it, or try to do it. Nobody can tell without trying.

We are very particular about the quality of our grain. We never buy damaged or second quality grain, and we have told our grain dealer so in such plain words that he distinctly understands it. We govern the amount to give the birds at one time, by the looks of the feed box. If they have not eaten all that was given the time previous, we do not give them so much. We try to gauge the amount so there will be very little, if any, in the feed box at feeding time.—George F. Cook, Maine.

I sell the pigeon manure to a tannery for fifty cents a bushel. I find plenty of fertilizer that does not go to the tannery, splendid for the garden and lawn.—Graham Roys, Michigan.

Breed for three things: good feeders, good color and good size.

HOW I OBTAINED A PROFITABLE PRICE, by John F. Bushmeyer. My brother has been selling Homer squabs in St. Louis at ten and fifteen cents apiece, not knowing they were worth more; in fact, not even looking up the market prices in the daily papers. We got wise to the fact that they were worth more through the **Manual** and the magazine, which is a daisy. My brother decided not to sell any more squabs unless he got a better price. One day last week, having three pairs of squabs ready for sale, he put them into a small box and went down to the market; but instead of going to the ten-and-fifteen-cent dealer, he went into the opposite side of the market to walk through, and the first butcher's stand he passed, the man behind the counter, seeing the box he carried, called him, saying, "What have you got there, squabs?"

"Yes," answered my brother, "are you buying them?"

"Are they commons?"

"No," answered my brother, "they are fancy Homers."

"What do you want for them?" asked the dealer.

"The market price," was the answer.

After looking them over, he asked again,

"What do you want for them?"

"The market price as I said before, if I cannot get any more."

"Say, Chollie," the butcher called to another man behind the counter, "what are Homer squabs selling for today?"

Chollie picked up a morning paper, made a bluff at looking at it; "\$1.75 a dozen," he answered.

"Wake up and let me see that paper," said my brother, which he did after some stalling, and my brother proceeded to read the market quotations, which were as follows:

"Pigeons and Squabs—Live pigeons at seventy-five cents per dozen. Squabs—Fancy Homers at \$2.75 per dozen for eight-pound, \$3.25 for nine-pound, \$3.50 for ten-pound and at \$1.50 for small; common at \$1.00 and \$1.25 per dozen." This is out of the *Post Despatch* of today. Now if you want those squabs, weigh them up and give me the price.

The butcher put them on the scales and they weighed four and a half pounds; for the six he readily produced \$1.60 and said, "Bring me all you can get." This shows you how anxious they are to get good squabs.

I am now shipping all my Plymouth Rock squabs to a Chicago marketman. He pays \$3.25 for eight-pound squabs, \$3.75 for nine-pound, \$4.00 for ten-pound, and sends check weekly. I ship at 4.12 p.m. and they arrive in Chicago at 8.30 a.m. the following day. I am building another fine addition for three hundred more pairs of my Carneaux.—J. B. Beckman, Missouri.

Squabs are a good proposition around here. Ours are in demand, many more than we can care for. The trade is waiting for them at \$5 to \$6 a dozen.—Mrs. Ed Cogley, Iowa.

SQUAB CONDITIONS IN ST. LOUIS, by Fred L. Stock. This is intended mainly for the information of the western squab breeder, yet it may prove of some interest to the eastern breeder, to the extent of giving him some inside, as to the conditions now in force in St. Louis. But, in the start, I wish to make my position clear, by the statement that I have no interest in any manner with the Plymouth Rock Squab Company, as I do not own one bird that was ever purchased from this firm. The market in this city (St. Louis) is without doubt the most unsatisfactory market in the United States today, and will continue to be such so long as the conditions are in force that now prevail, the conditions I refer to being the limited number of really good flocks of Homers in the city. In fact, I can use one hand in counting the owners of these first-class Homers, and in each and every case the original breeders were purchased from the Plymouth Rock Squab Company, and their owners have no trouble in finding a private market for their squabs at the eastern market price, owing to the vast difference in quality of squabs from these birds, and the squabs to be found in the public market.

Many people state how much per pair it costs to feed their birds. The price of grain in California and the Middle States differs so greatly that their estimate gives me no idea whatever of what it would cost me per pair. For this season I am weighing all the feed used in one house. In the past three months they have eaten at the rate of eighty-four pounds to each pair per year. I will continue to weigh for a full year. There is little demand for large squabs in the small towns, but in San Francisco they want large squabs and lots of them. San Francisco is only seventy miles from here, so I ship my squabs alive. The express is fifty cents per hundredweight. A few of my squabs go to commission houses, but most of them go to marketmen direct, and I pay no commission. Several marketmen have asked me to contract my squabs to them by the year at a given price. They are willing to give a good price anyhow so I have not contracted yet. Squabs are quoted at \$2 to \$4.50 per dozen. My squabs are classed as extras and I never receive less than \$3 per dozen and this for only a few shipments each year. I have been unable to find a demand for larger than a one-pound squab on the open market.—D. D. Powell, California.

The largest New York hotels consume on an average of sixty dozen squabs a day, each hotel, and the prices range from 75 cents to \$1.50 per squab, according to the location and size of the hotel. My readers can draw their own conclusion as to whether squab raising pays in this part of the country.—Harry M. Samson, New York.

I can sell all my squabs to private customers from fifty cents to seventy-five cents a pair.—Ray F. Peavey, Massachusetts.



FRANK HUCHT'S KANSAS SQUAB FARM STOCKED WITH PLYMOUTH ROCK PIGEONS.

I SHIP SQUABS FROM KANSAS TO COLORADO, by Frank Hucht. I started four years ago in the business. I did not know anything about the pigeon industry but have learned something since. The first Homers I saw were in our town, shipped from the East, one-half dozen pairs. They were fine birds, and I liked them very much. I stocked up with Plymouth Rock Homers. My start was in an old barn almost ready to fall down. It did not take very long when my second room was filling up. I talked the matter over with my wife in regard to building a squabhouse, but she would not listen to me at first and told me I had better sell those old pigeons and get back what money I had spent on the birds I had. I had quite a time to convince my wife that there was money in raising squabs. I began selling a few dozen every week, and got \$2.50 and \$3 a dozen for them. My wife was well pleased with that, and I convinced her of the fact and built a house sixty feet long, fourteen feet wide, with three-foot aisle, self feeders in every unit. I then had only one hundred pairs and had four units to go on. I sent for one hundred pairs more Homers. That made the house fill up some. A year ago I bought other property in town, which gave me more room. I moved my sixty-foot building to this place and added sixty feet to it, which makes the present structure one hundred twenty feet long. (See photograph on opposite page.)

My principal feed is corn and kaffir corn, millet and wheat. I have kaffir corn in self feeders at all times. The other grains I throw on floor. I also feed hempseed and peas with plenty of grit. I have now five hundred mated pairs of Homers and some youngsters, and also Carneaux.

I ship all of my squabs to Colorado. I dry-pick them in the winter and in the summer months I ship them alive. The market West in the summer is not as good as it has been. I received \$2.50 and \$3.00 a dozen for them F. O. B. Denver, which I considered a fair market. I got as high as \$3.75 for them.

Let members of the association, when they go shopping, inquire the prices of squabs, as if they intended buying a pair or a dozen. Mail us the dealer's full name and address, date and price quoted. These figures would give the true retail prices. Then the wholesale prices will be from twenty-five to fifty per cent less. It has been true, is true now, and will be true, that nobody can be guided successfully by printed quotations, but must find out first what his squabs cost him per dozen, then add what he desires for a profit and sell at that figure. Otherwise nothing but failure will result.

I had a dirt floor in my pigeon house, thinking it a necessity, but after I put in a floor of two-inch plank and raised my house about two feet off the ground I raised squabs with ease and rapidity. Dampness was the cause, produced by the dirt floor.—Charles A. Tupper, New York.

NON-FLAKING WHITEWASH. To prepare whitewash for fences, buildings, shop interiors, etc., that will not flake and fall off, mix one part fine Portland cement with about eight gallons whitewash. The cement binds the whitewash to the wood and makes a permanent covering which is unaffected by weather conditions. The small quantity of cement used and the constant stirring necessary to keep the whitewash in good condition for applying, prevents the cement hardening in lumps at the bottom of the pail, as might be expected.

I have been in the habit of robbing the Carneaux nests twice in succession, allowing the old birds to hatch the third pair of eggs. I had robbed a certain pair twice and as the third pair of eggs was laid on the floor in an undesirable place, I determined to rob them a third time. It seemed pretty hard, but I considered it best all round, so it was done. Nine days later pair of eggs number four appeared, this time in a nestbox. They were allowed to hatch this pair (strong, healthy chaps they are, too) and—here's where the speed comes in—just seven days after these youngsters were hatched, the hen laid again. These eggs were removed to a Homer pair as usual. It has now been four days since the second egg was laid and I am eagerly waiting to see how long it will take this fine little egg machine to produce again. I call this rapid work and if any one has a breed of birds which can go ahead of it, I should like to bear from him.—George N. Rogers, Maryland.

I never knew a thing about pigeons until this March (1910) when I took charge of a hundred pairs—seventy-five pairs Homers, twenty-five pairs Carneaux. They were very much run down and neglected on account of my husband not having the time to devote to them that they should have had. I read all the **National Squab Magazines** over and over again and consequently have had better results than I ever dreamed of having. In June I sold \$29.25 worth of squabs, besides keeping fourteen pairs for breeding purposes, and in July I expect to do better still.—Mrs. Edgar Rapp, Missouri. This story ought to sell some more of the bound volumes of the magazine, price \$2.50, transportation prepaid. Each volume has over four hundred large pages of original squab matter which will not be reprinted. The first volume includes the twelve issues for 1909, the second 1910, the third 1911, the fourth 1912, and so on. Address Squab Publishing Co., 220 Purchase Street, Boston, Mass.

I purchased my Homers from your plant some two years ago, and I have bred them under the most adverse circumstances. I wish to state that after looking at several plants in this town my pigeons are just a little bit the best looking, and if I can get these other pigeons from your place, would be delighted to do so.—H. G. Cooper, Louisiana.

HOW GOOD SQUABS TOOK THE RIGHT OF WAY, by C. E. Plank. In May, 1908, I purchased one dozen pairs of the Extra Plymouth Rock Homers, intending to raise squabs for my own use only, but in a year I had on hand seventy pairs, and lacking room had to dispose of the surplus squabs. I called on one of the largest retail grocers, handling groceries, meats, fruits and all good things to eat, who offered me only \$1.50 a dozen, saying he never paid over \$2 for the best. I told him he must be getting only common birds of about seven or eight pounds per dozen. He acknowledged such was the case. When I explained what my birds were and that my squabs ran ten and eleven pounds per dozen, he was willing to talk, and we finally compromised on \$2.50, alive off the nest, any quantity and at any time, this because I had to sell my birds alive, having no time to dress or even pluck them.

I averaged eight dozen a month the rest of the year, or \$20 a month, and my feed was costing me about \$7.

I had one house twelve by fourteen feet, with a low upper story, keeping about ninety birds in the lower part and thirty above. In May, 1910, I built another cheap house seven by eleven feet, stocking it with select youngsters, fifty Homers and twelve Carneau, allowing them to mate up as they wished. Most of the Carneau mated with Homers and their squabs all run over a pound each, and these Carhomes are fully as prolific as the Homers.

To verify the quality of my squabs, I will say that last month the head buyer for the grocer instructed me to bring no more squabs, as they were overstocked. I told him I had arranged with the owner personally for the sale of my birds, and the conditions. He called the owner, who said: "Oh, you are the gentleman who has the large squabs," then to the buyer: "Cut out some of the others, and take all this man brings. We can always dispose of his birds." His retail price is thirty to fifty cents each, and if I had the time to kill and pluck my squabs, I could find a ready sale for all of them to private parties and hotels at \$3.50 to \$4.50 a dozen.

Comparatively few private families in this Missouri city use squabs to any extent whatever. I have attended several banquets at hotels and clubs, at which squabs were served, and find them invariably broiled, practically "dried up" and usually the common birds. It is no wonder that people who try the small birds, served in that manner, are not very "strong" for squabs.

While my pigeons are yielding me a big per cent profit on the investment, I know they would be much more lucrative were I to give them an hour or two each day. I see them a few minutes each morning and spend a few hours with them on Sunday. In winter I see them in daylight only on Sunday.

An elderly Englishman who raises fancy pigeons of all kinds for shows and fairs called to see my birds recently and said I had the nicest, healthiest lot of pigeons he had ever

seen. I lose very few birds with my present manner of feeding. I have tried various methods and find whole corn and kafir as main food to be the best, with about one-sixth hard wheat.

BRILLIANT WHITEWASH. Half a bushel unslaked lime; slake with warm water, cover it during the process to keep the steam; strain the liquid through a fine sieve or strainer; add a peck of salt, the same to be previously well dissolved in warm water; add three pounds of ground rice boiled to a thin paste and stir in boiling hot; add one-half pound of glue which has been previously dissolved over a slow fire and add five gallons of hot water to the mixture, stir well and let it stand for a few days, covering up to keep out dirt. It should be put on hot. One pint of the mixture, properly applied, will cover a square yard. Small brushes are best. There is nothing can compare with it for outside or inside work and it retains its brilliancy for many years. Coloring matter may be put in and made of any shade—Spanish brown, yellow ochre, or common clay, etc.

I tried to find out if there was any one in London, Ontario, a city of 50,000 inhabitants, who is doing a squab business, but I hear of only one man selling squabs. He is over eighty years of age. He pays the boys twenty-five cents a pair for common pigeons alive or dead. He plucks the feathers, and sells the pigeons to private customers at eighty cents a pair. That is I think a pretty high price, for common old pigeons. There are quite a few breeders of flying Homers in London and I understand they have an association, but apparently they have not yet become much interested in squabs. Near London is the city of Hamilton, with 65,000 people, sixty miles away; also Chatham sixty miles away, with 30,000 people, and St. Thomas twenty-six miles distant, with 30,000 inhabitants. Surely this is population enough to make trade for squab plants.—W. W. Sutherland, Canada.

Sulphate of iron is a good tonic and corrective for pigeons. Use a tablespoonful to a gallon of water. I grind charcoal as fine as I can and mix it with salt, then dampen it and pack a paper bag and bake in the oven for half a day or longer, so it will be as hard as a brick. Put it in the pen and the pigeons peck at it. I have sold some of my squabs for sixty-five cents a pair. I think there is nothing better than squab raising, both to make money and for satisfaction.—Louis H. Scharff, Pennsylvania.

In regard to nest-building, I have found out that by taking mustard stalks and cutting them about three feet from top of tree and then chopping the little thin branches and stump together to about six inches in length, this makes excellent nesting material for pigeons. They will leave all others and pick out mustard sticks. If some of your subscribers will try this, they will see how quickly their pigeons will build nests.—Elmer Krieger, California.

