

赤

28
29-129

石丸三七郎纂輯

泰西繪原



寫景法

附圖

東京

金港堂

藏版

圖三第

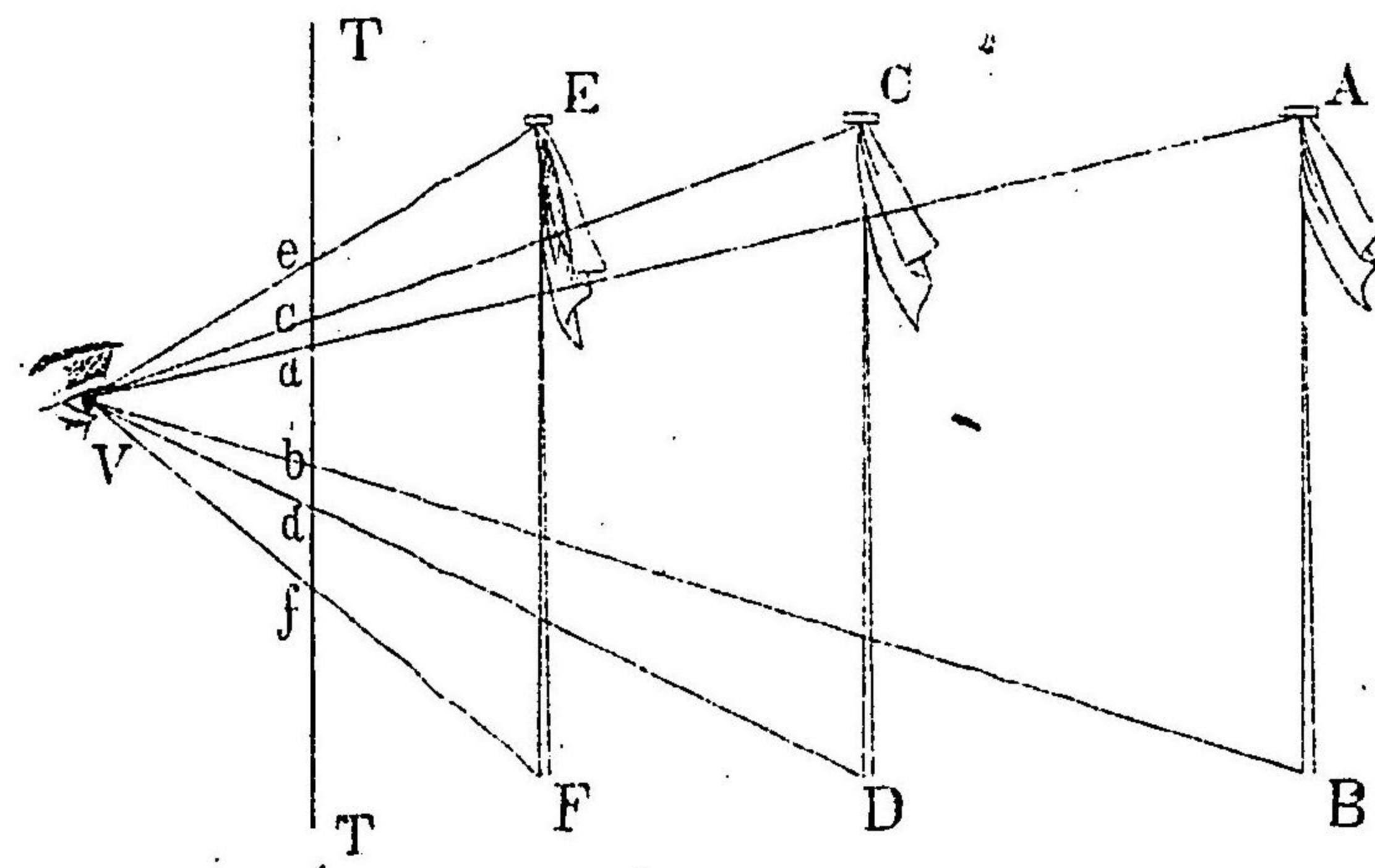

圖一第

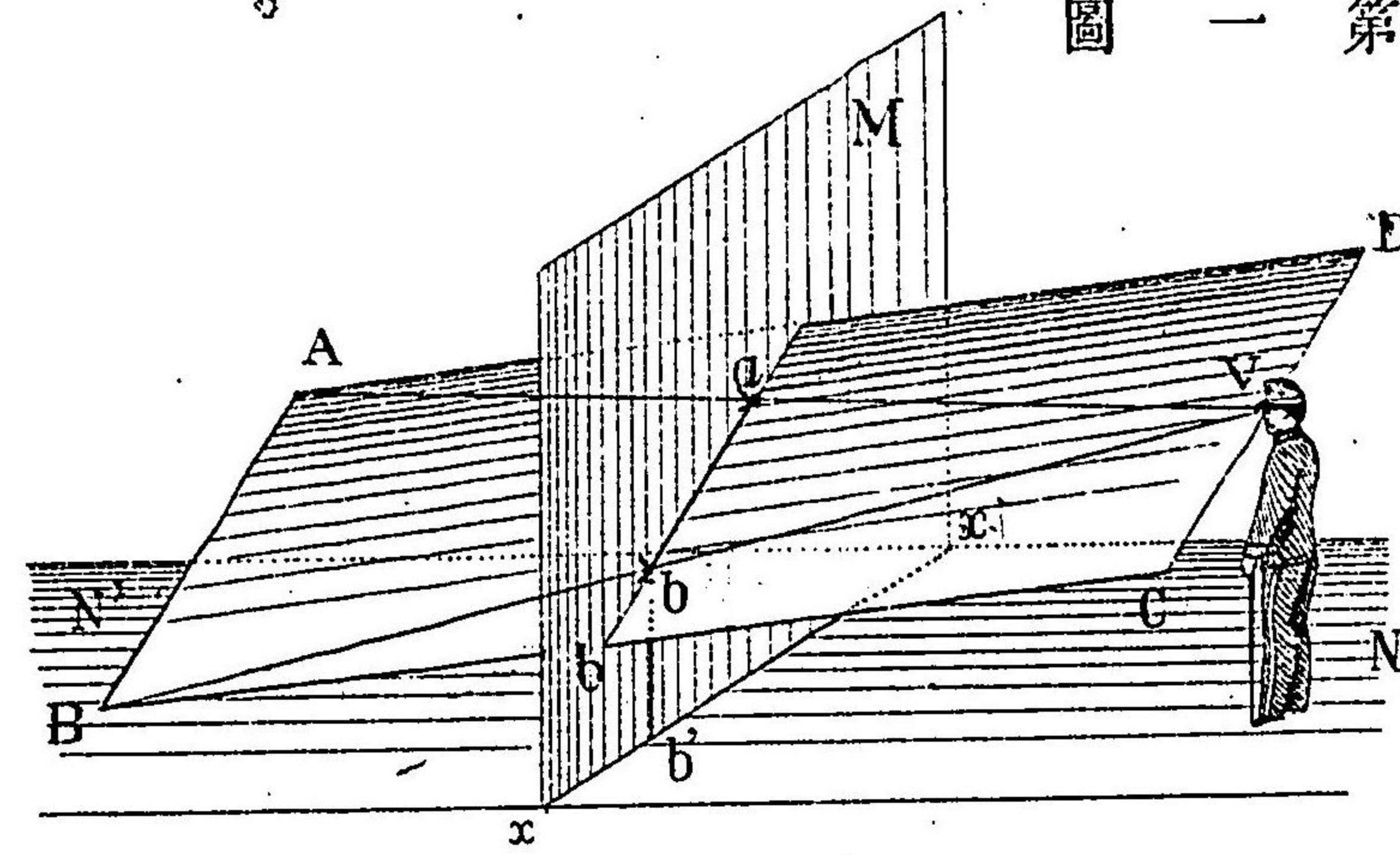

圖四第

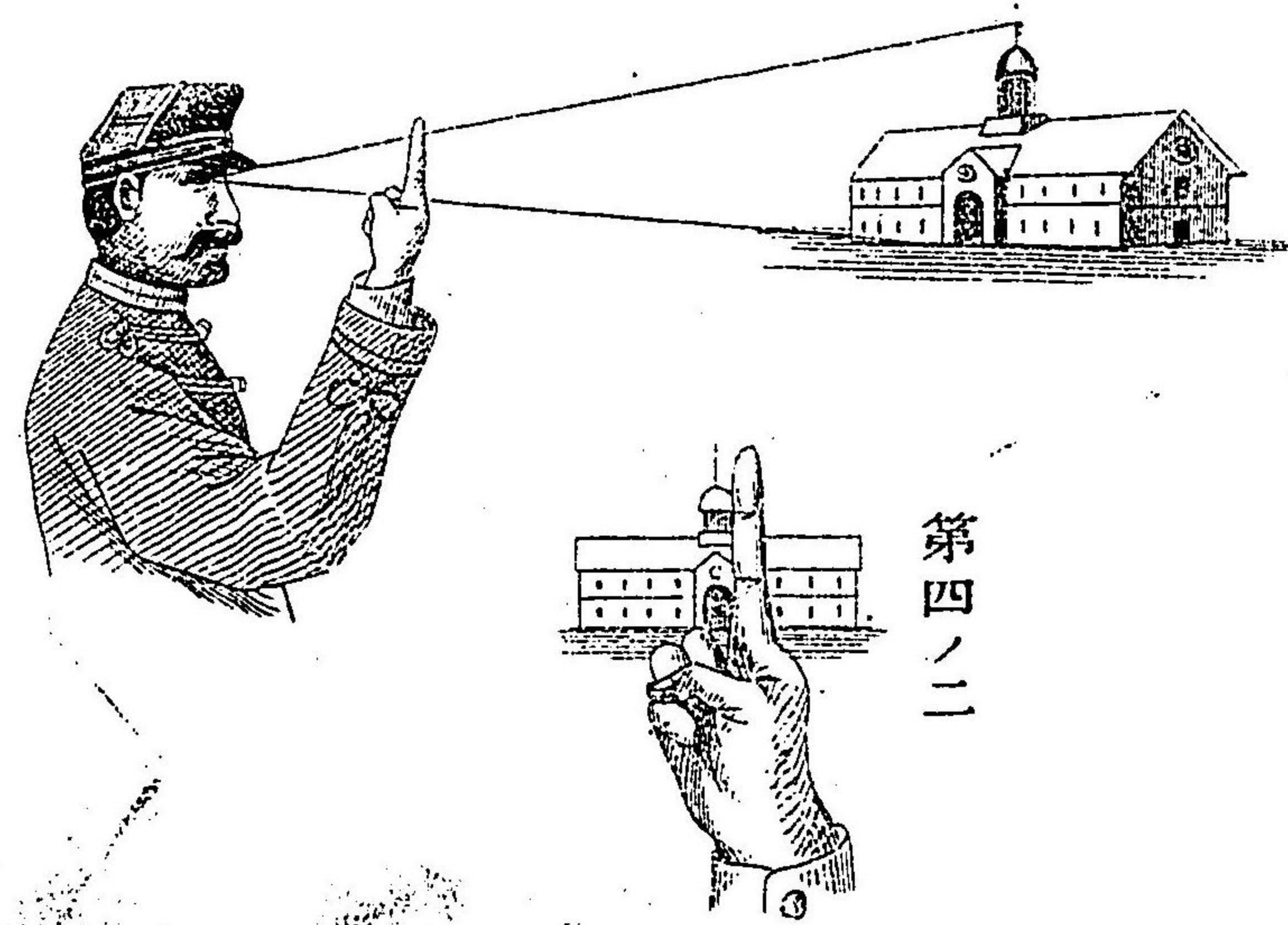

第四ノ二

第貳圖

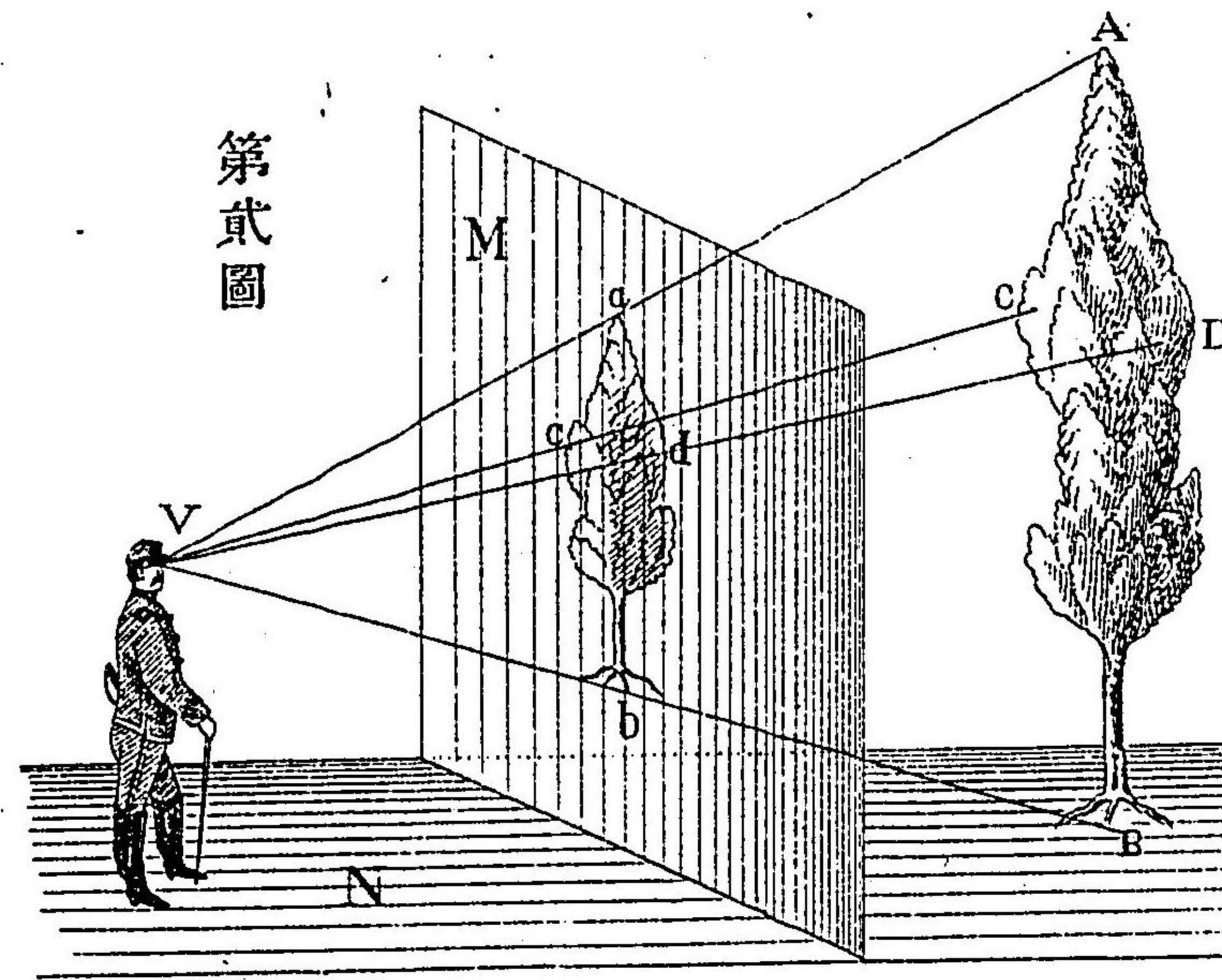

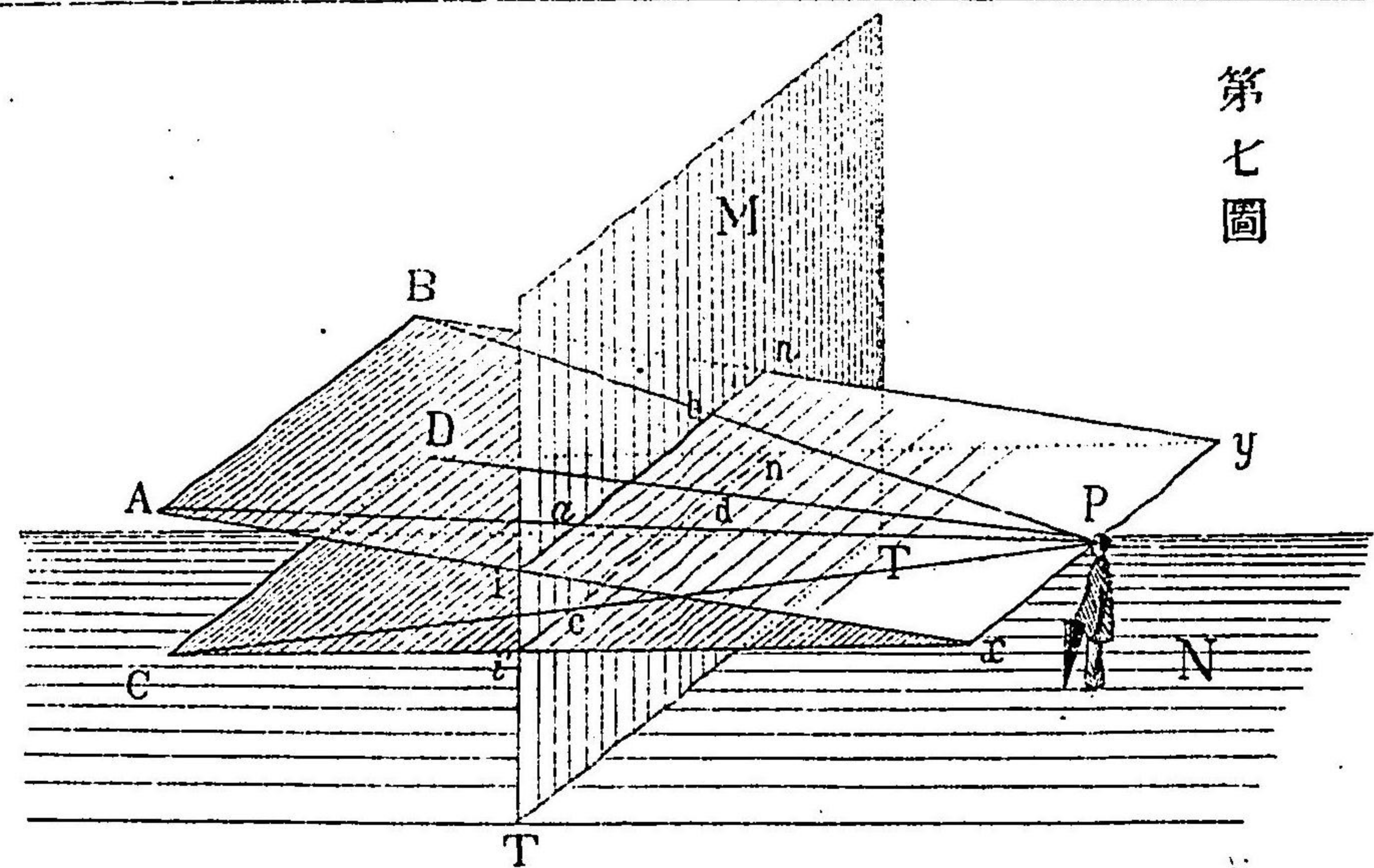

第七圖

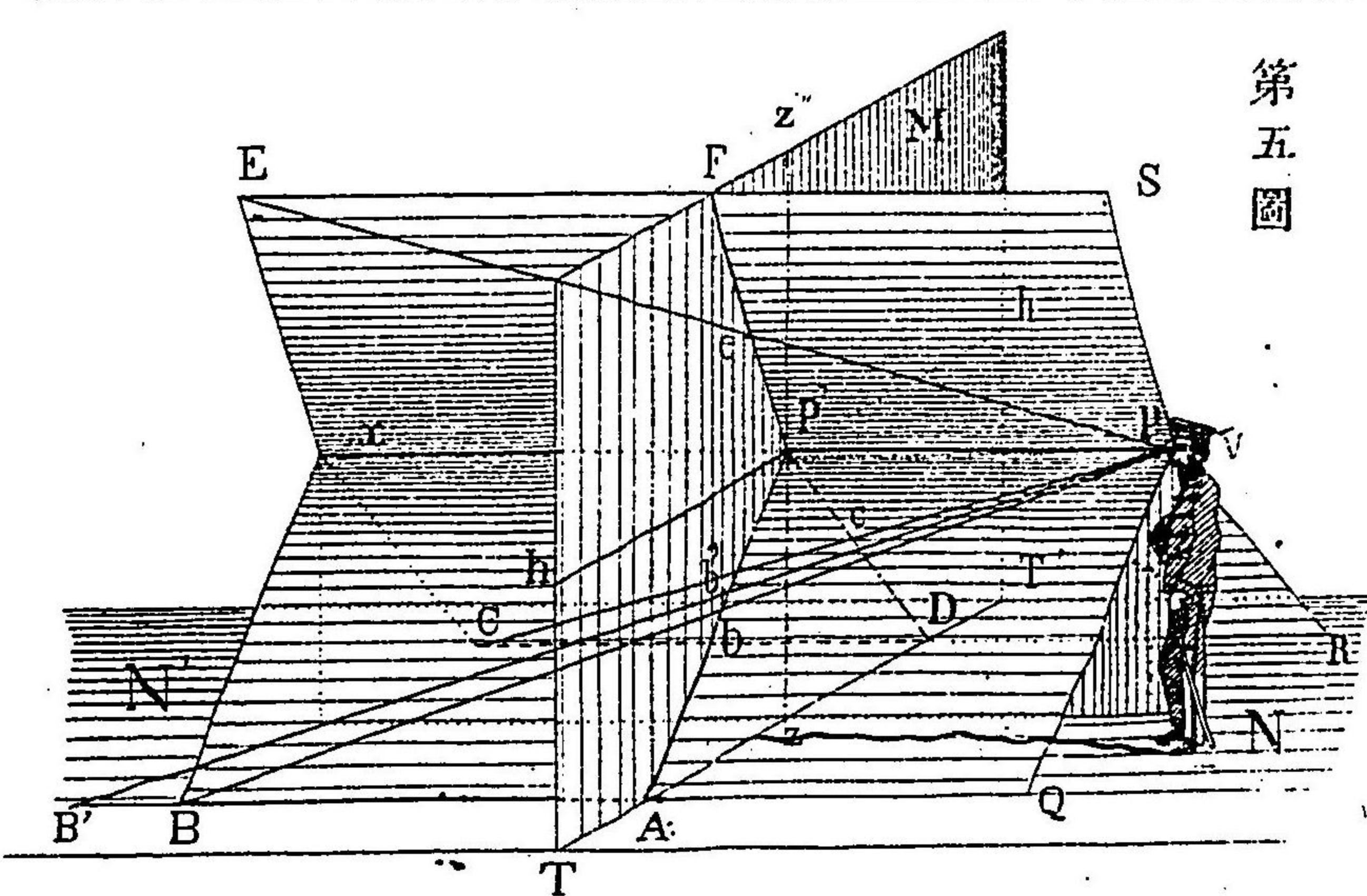

第五圖

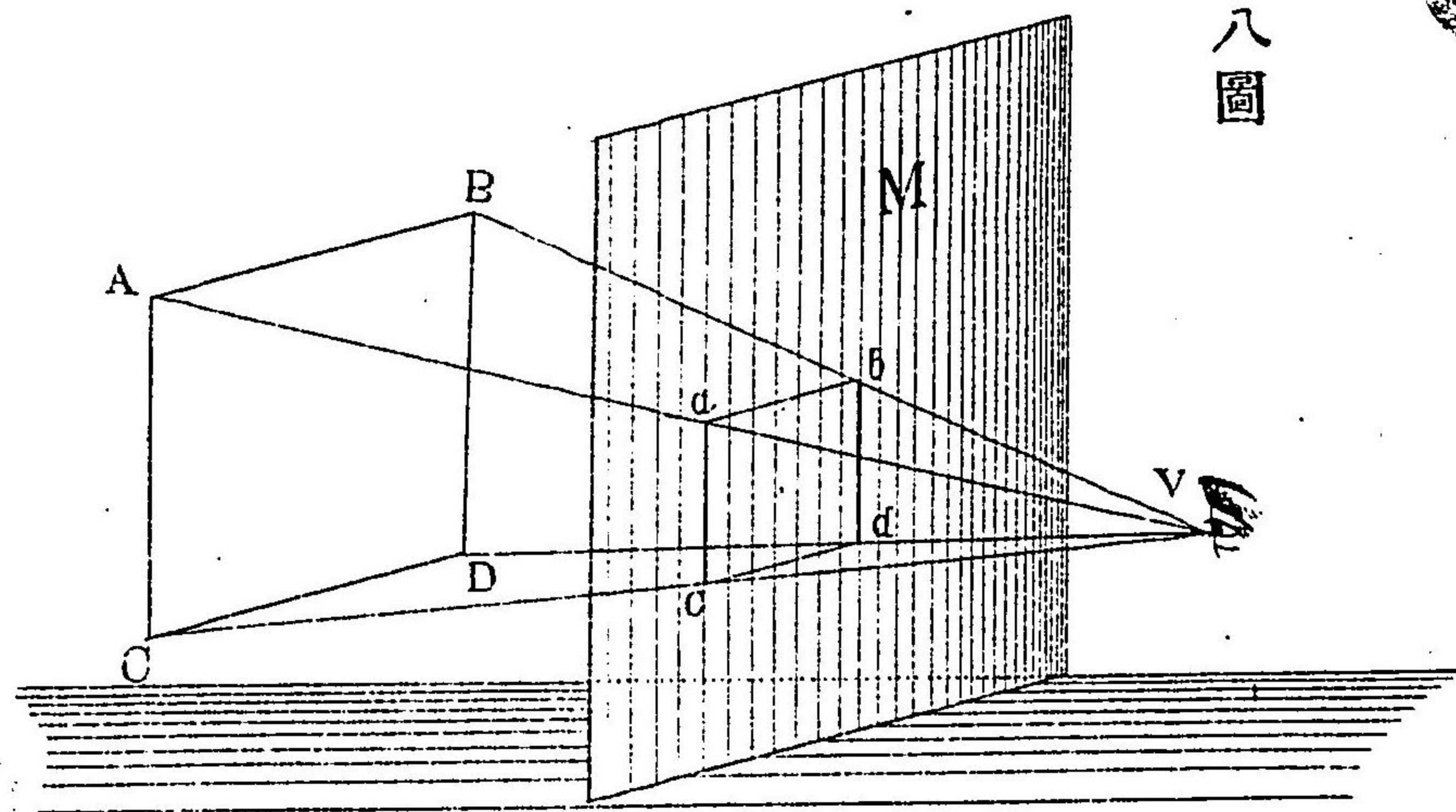

第八圖

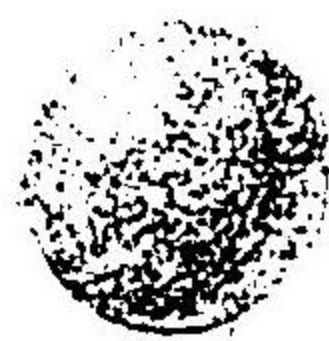

球中影影

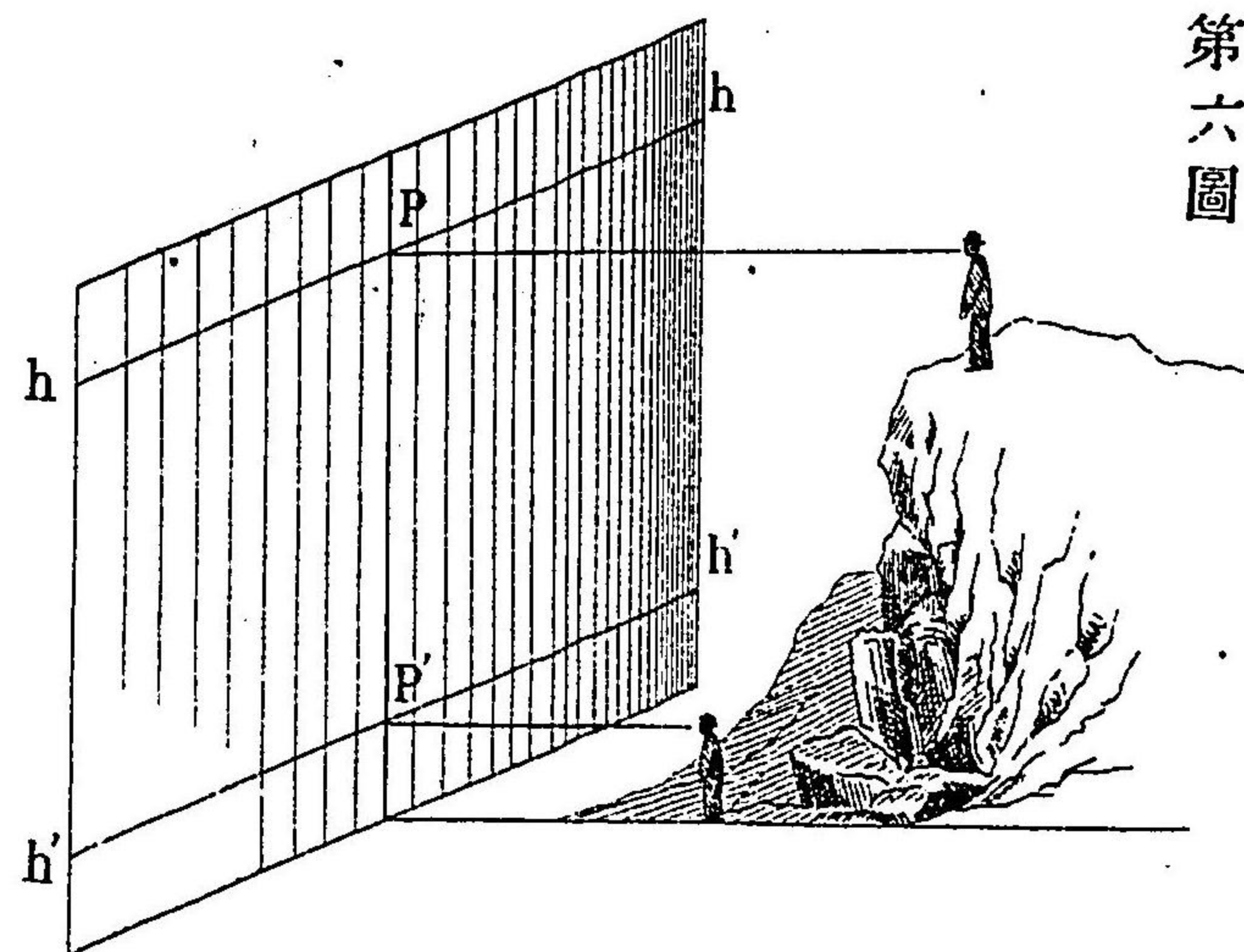

第六圖

第十圖

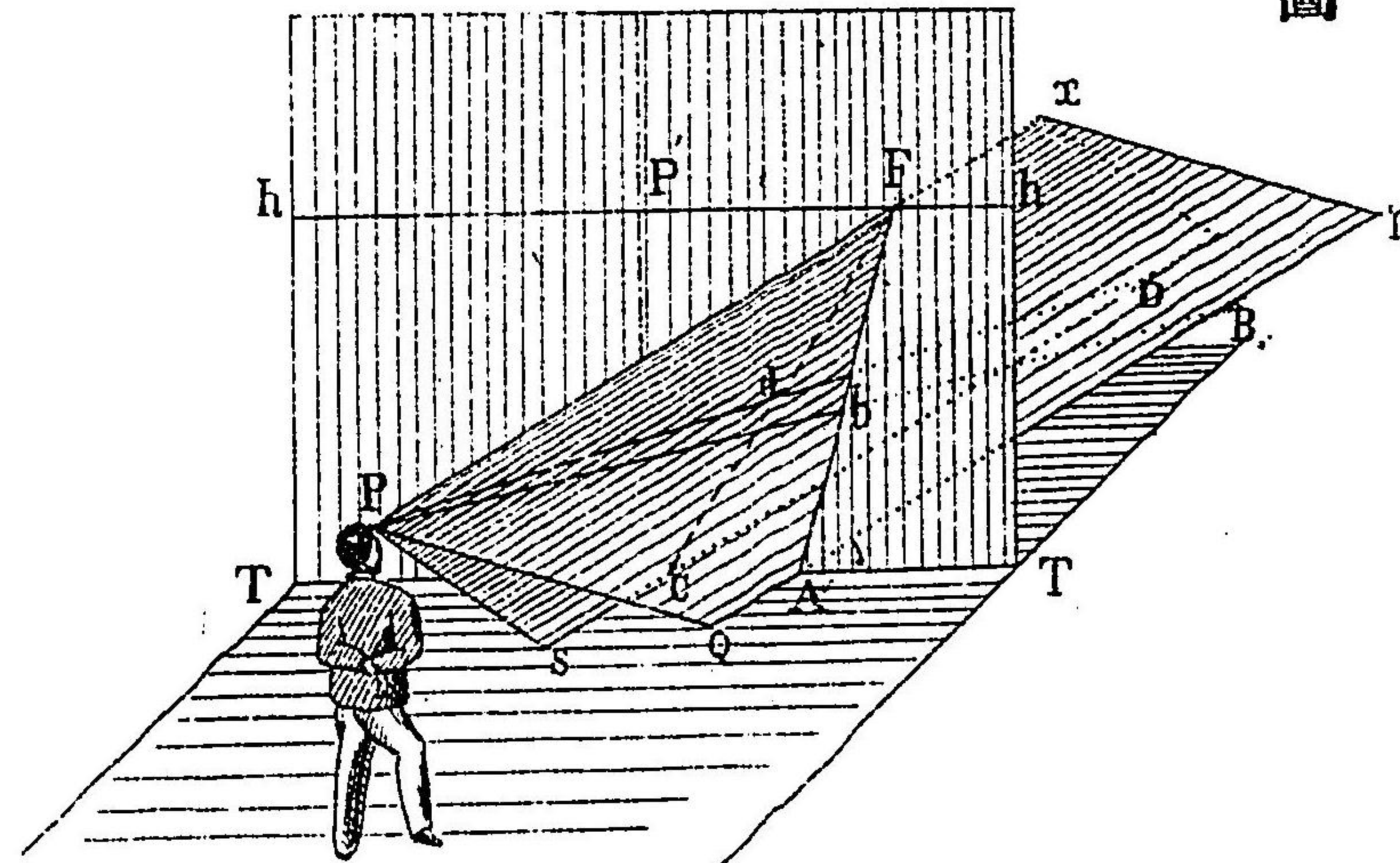

第九圖

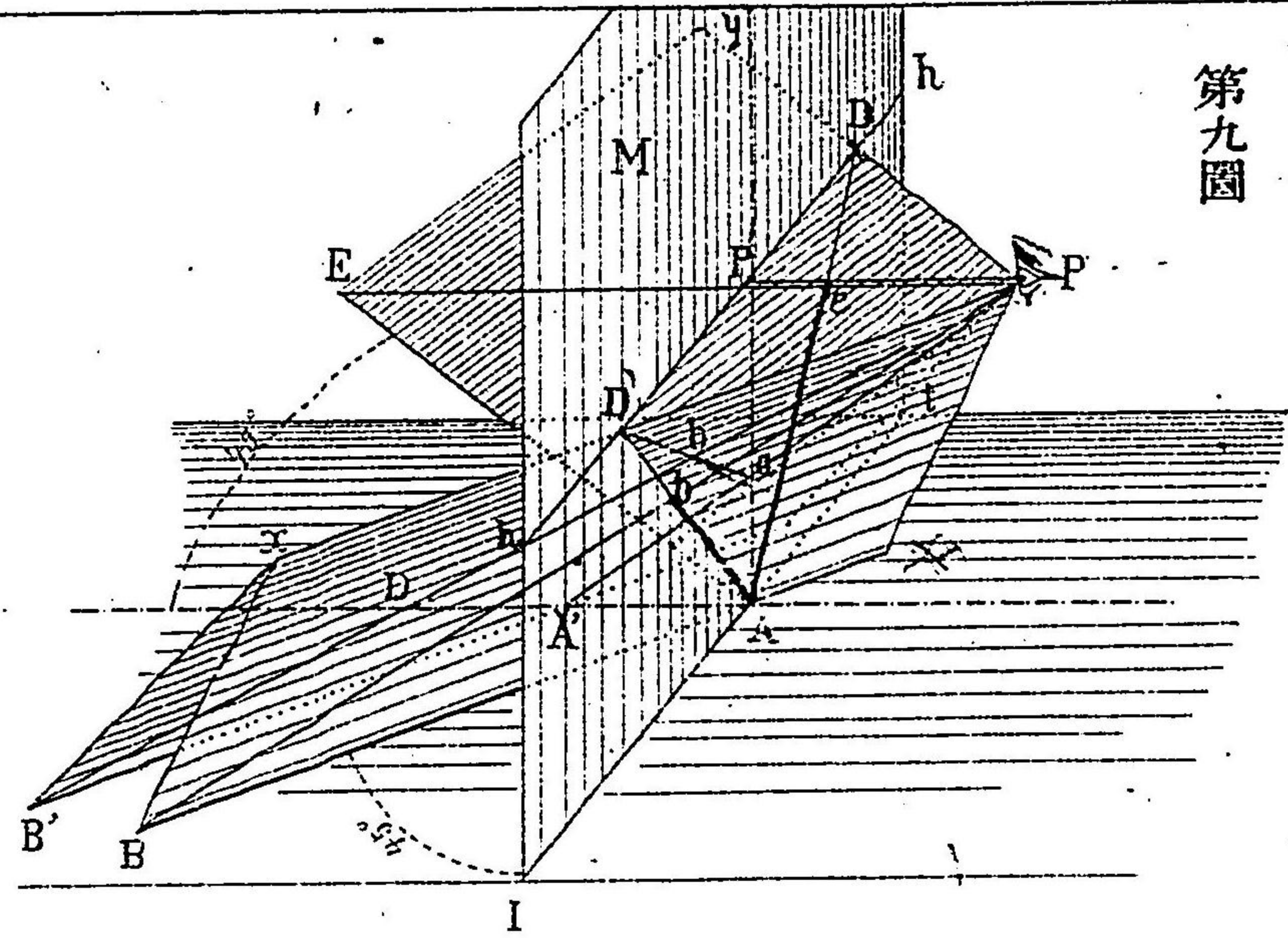

第十一圖

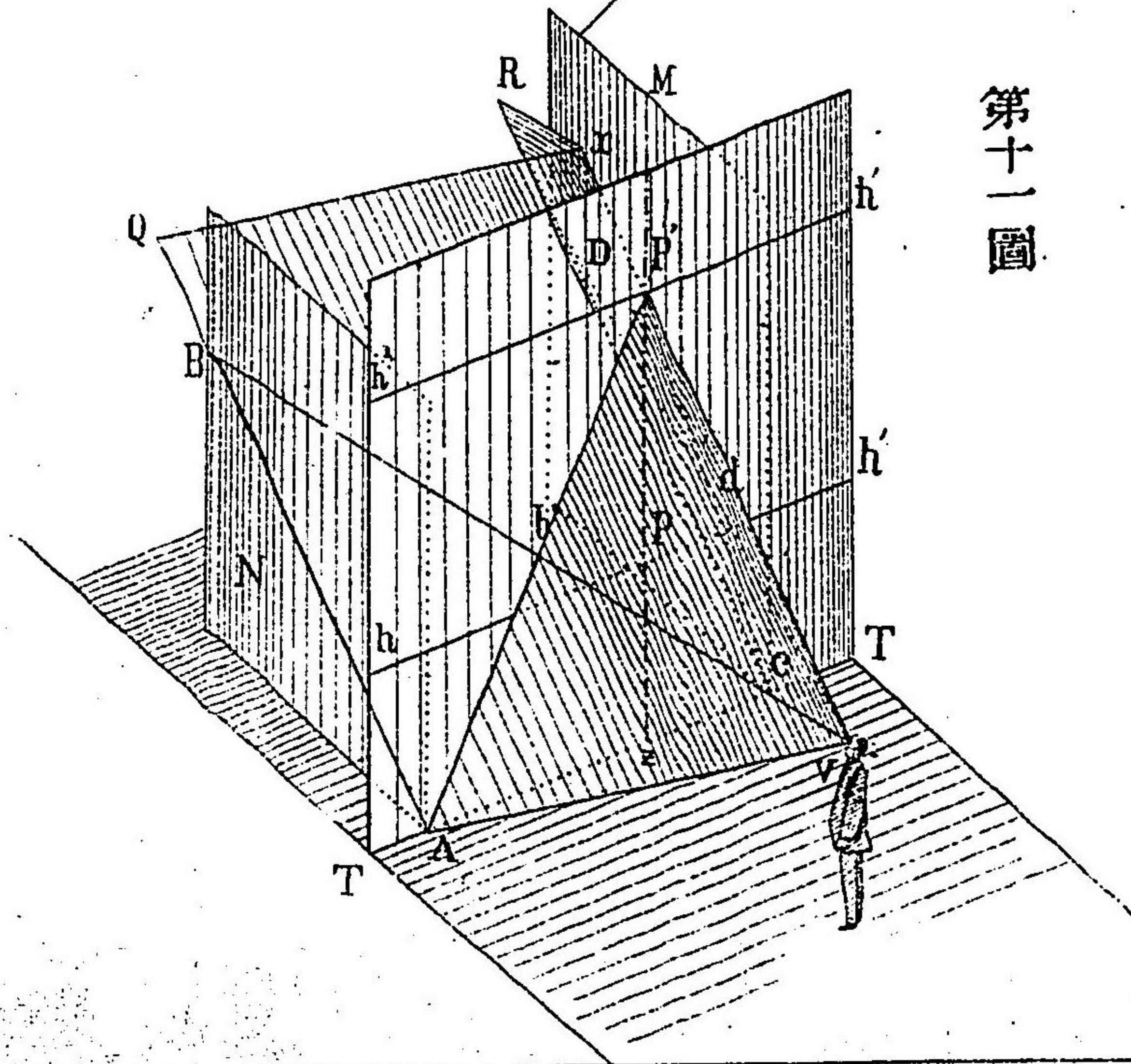

第九二圖

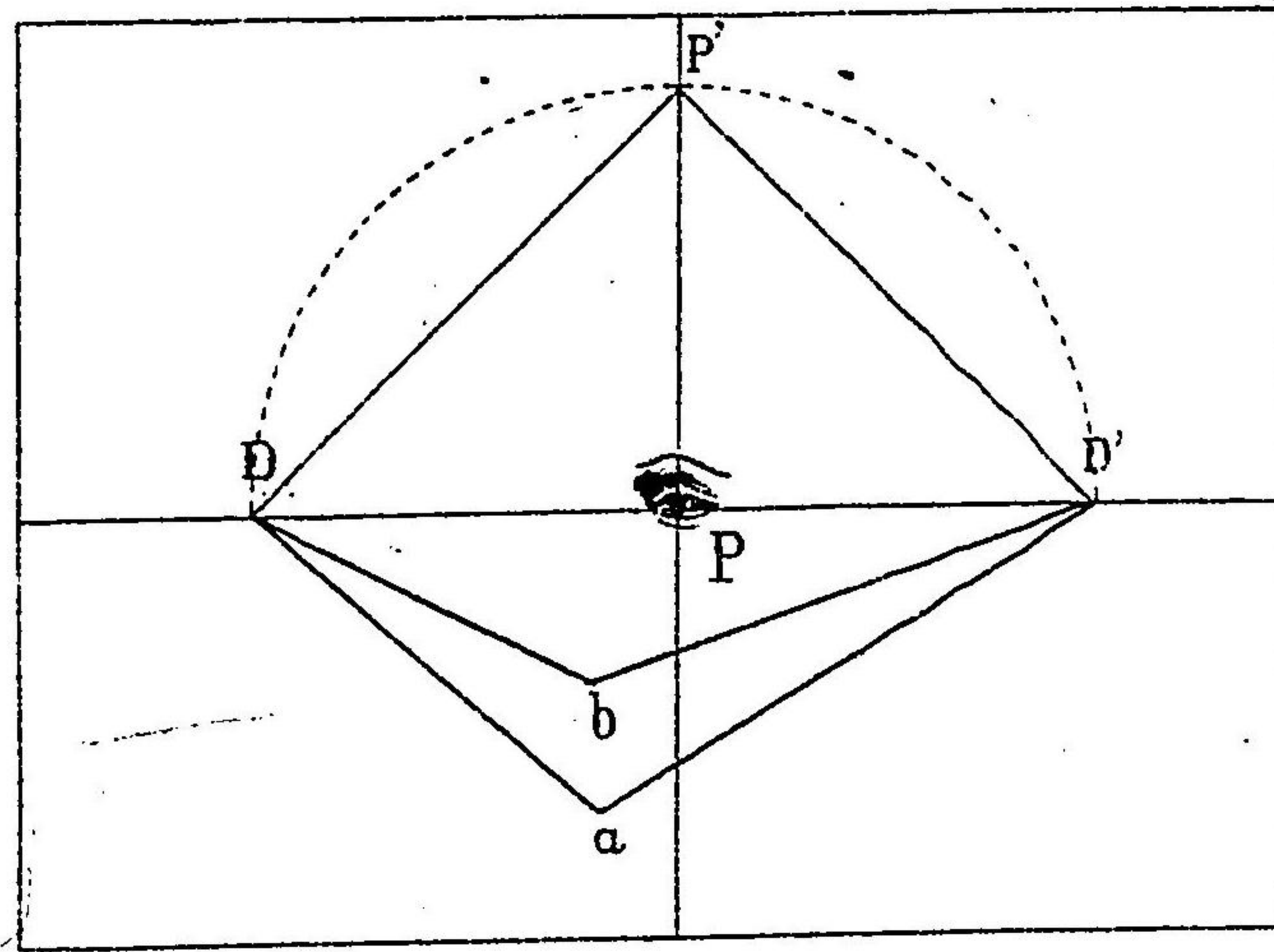

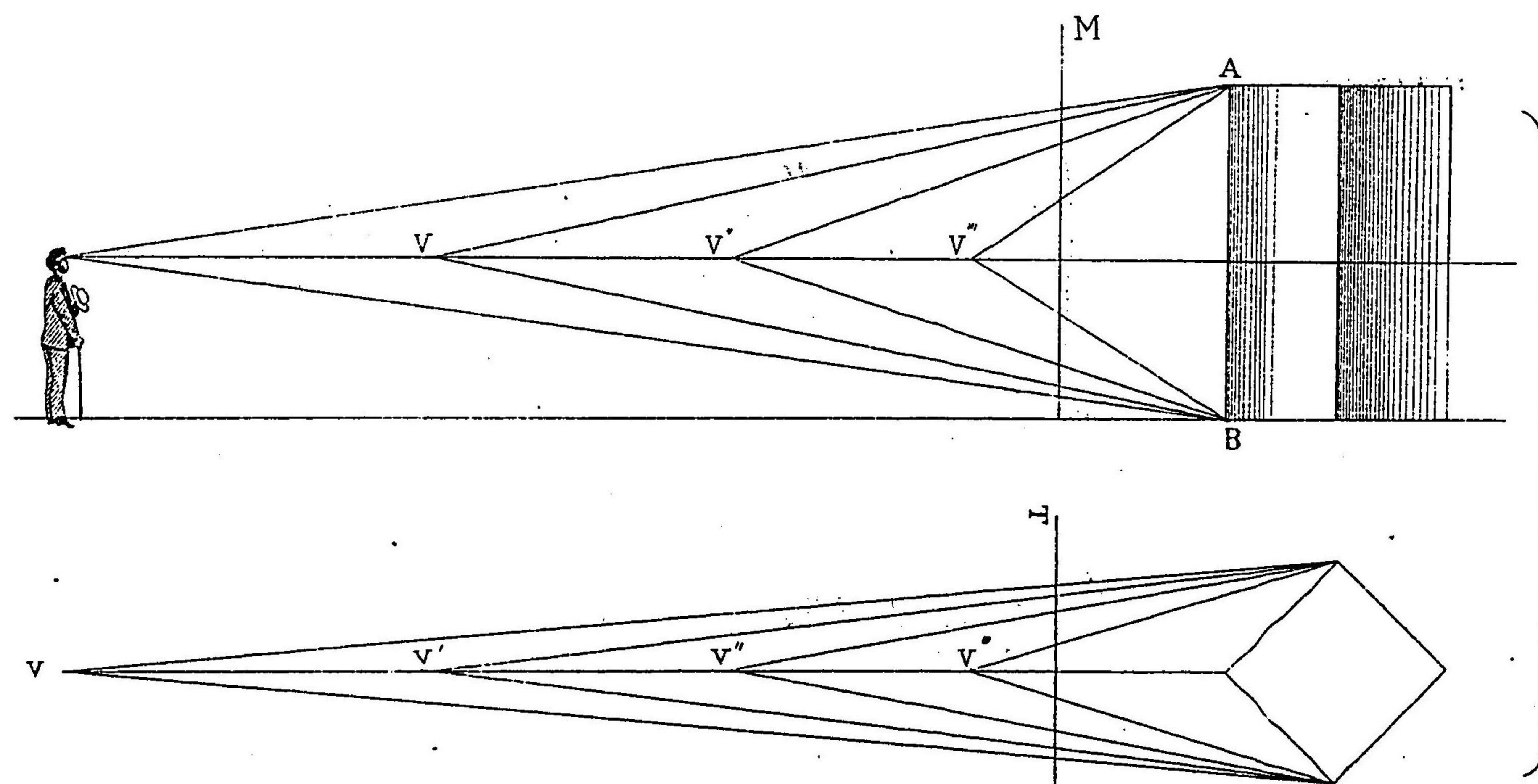

第十五圖

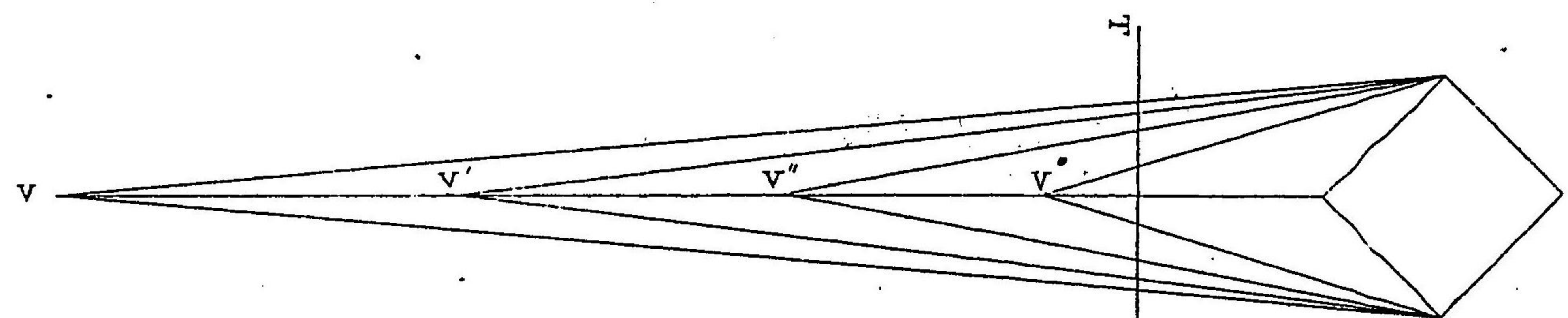

圖六十第

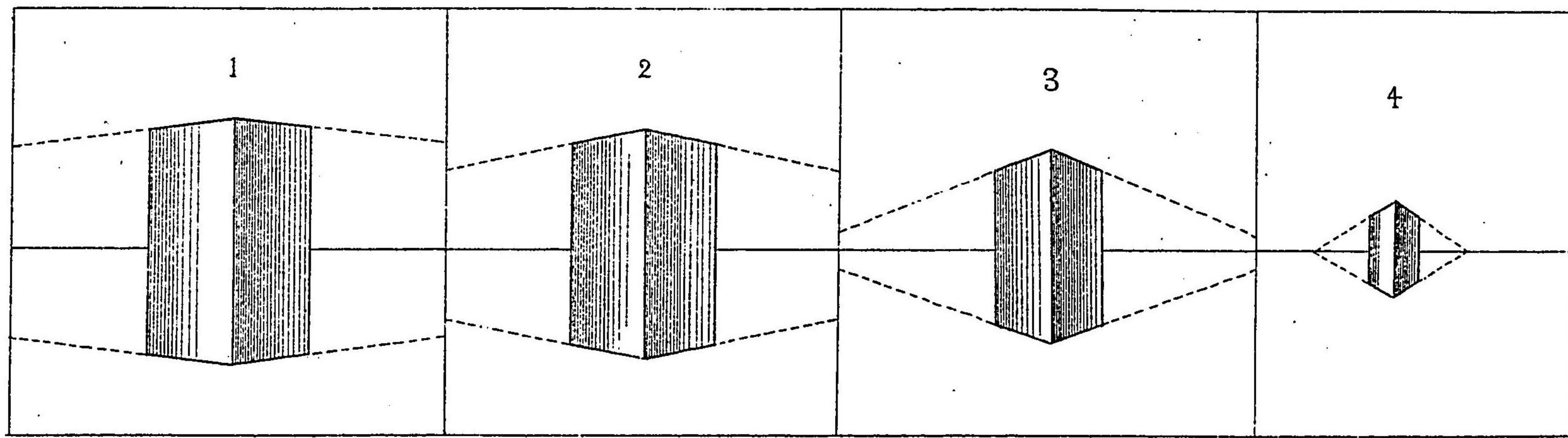

二ノ七十第

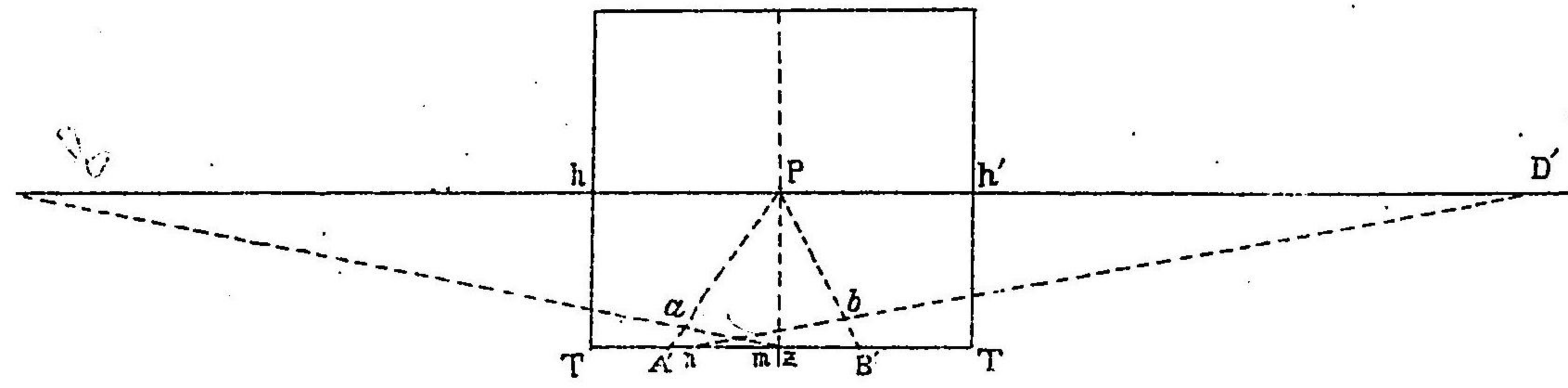

第十九圖

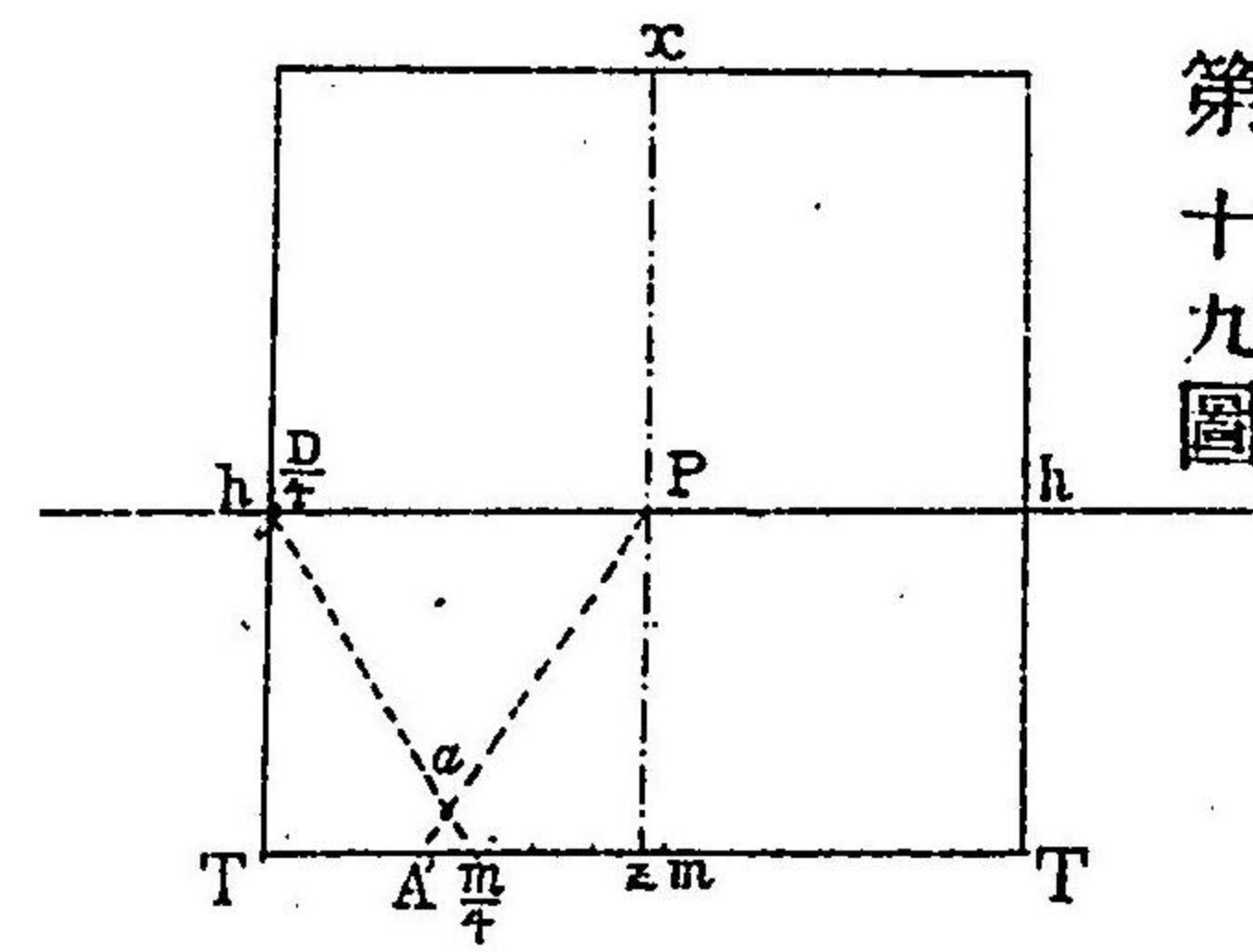

第二十圖

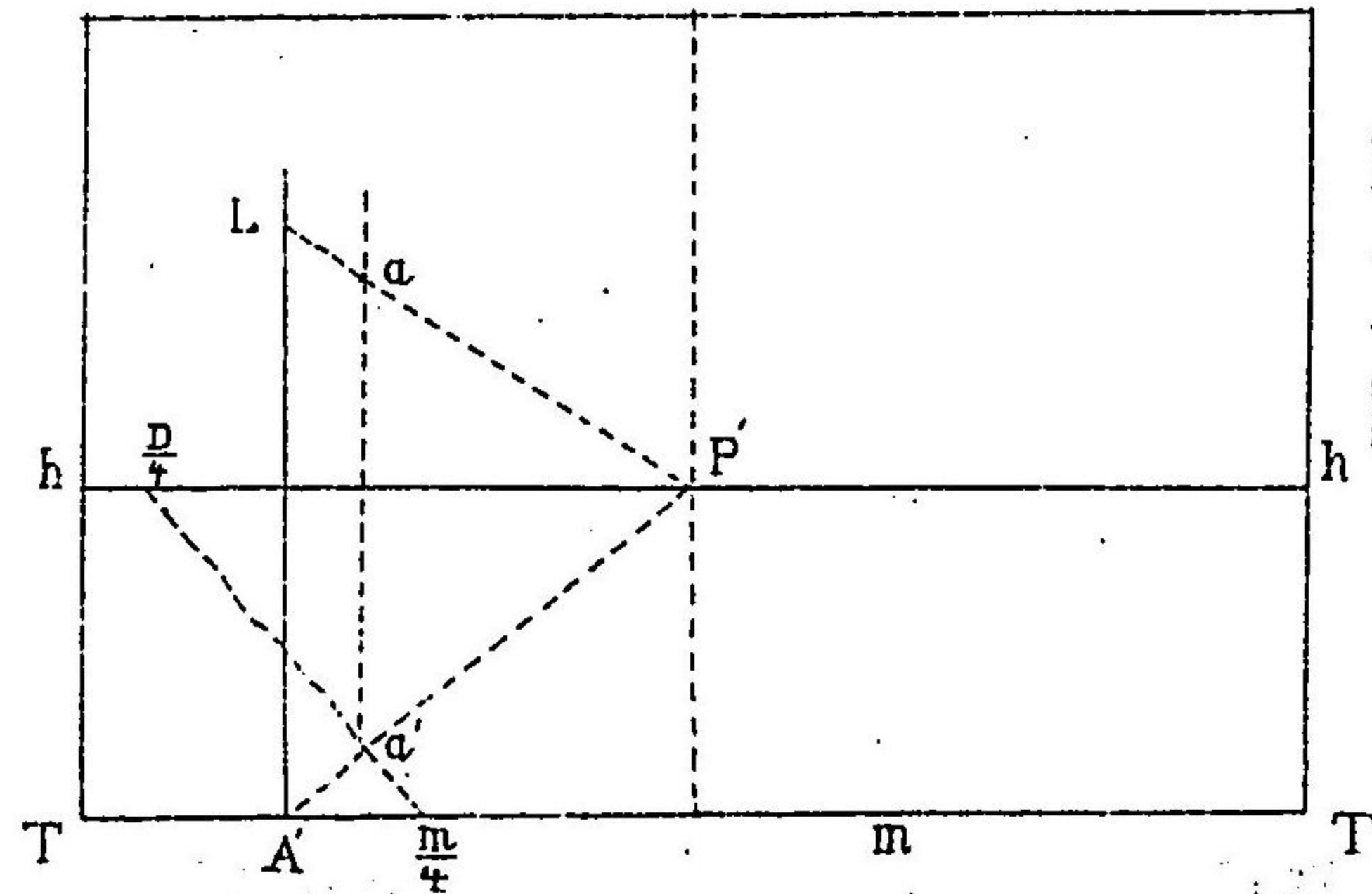

第十七圖

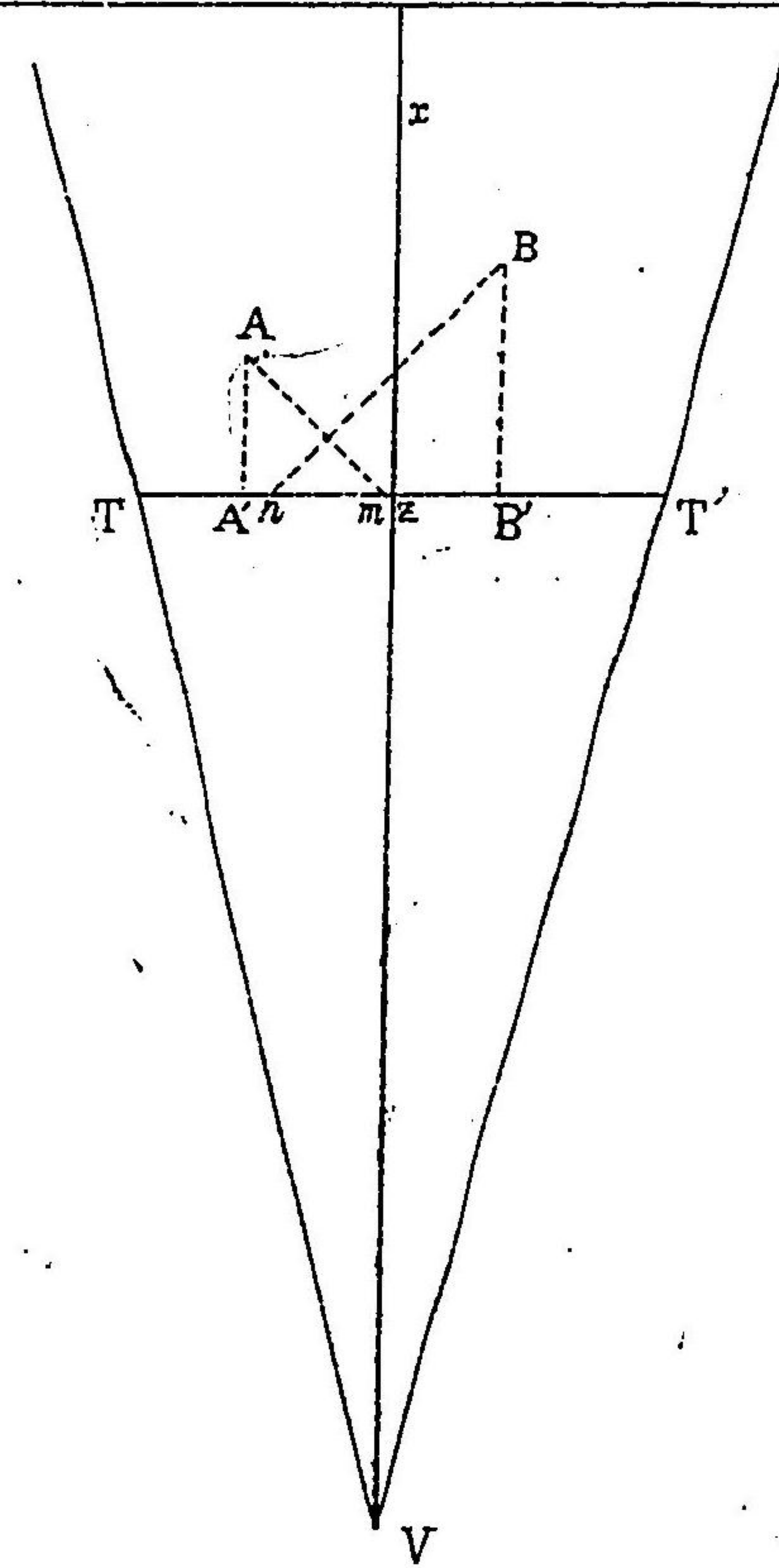

第十八圖

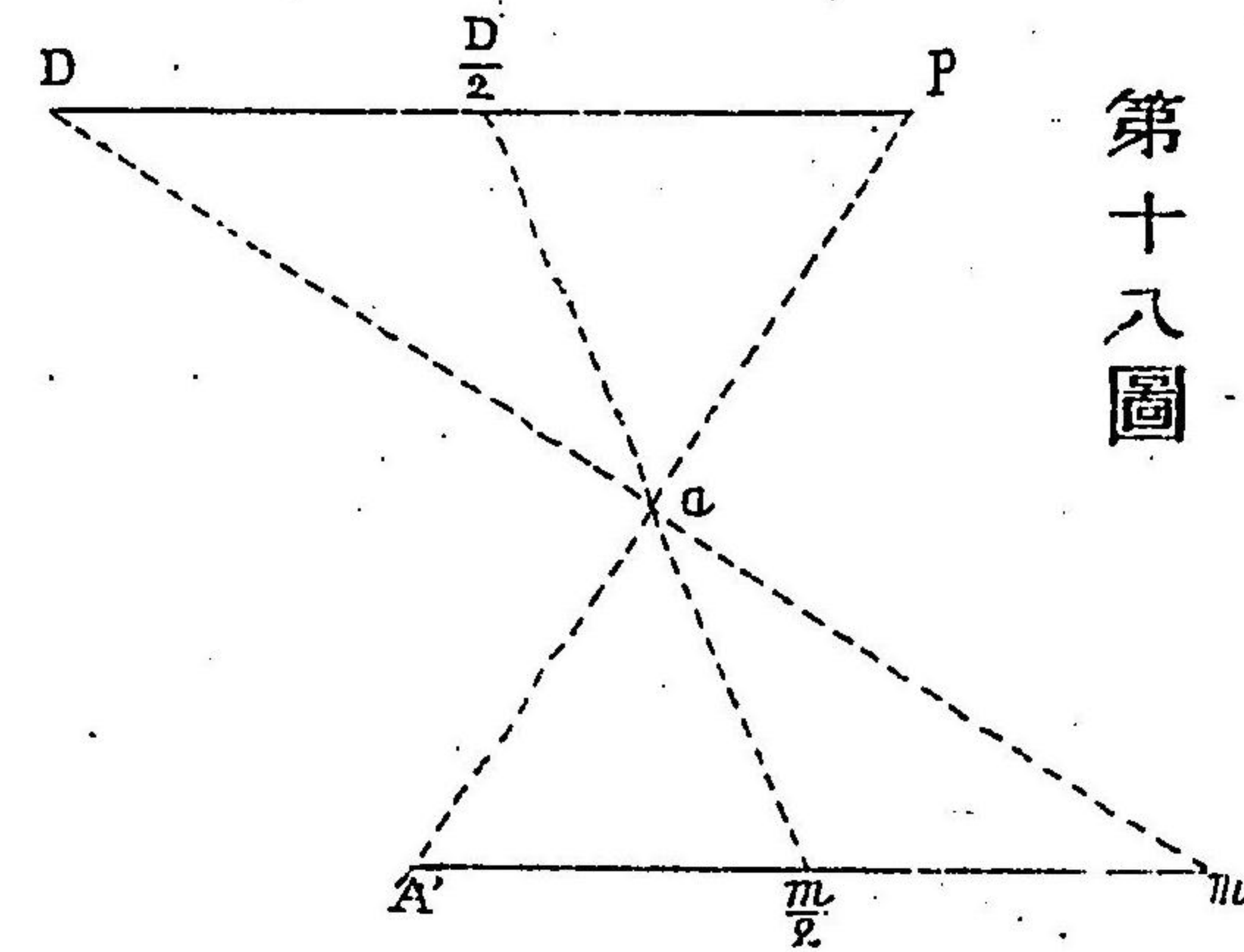

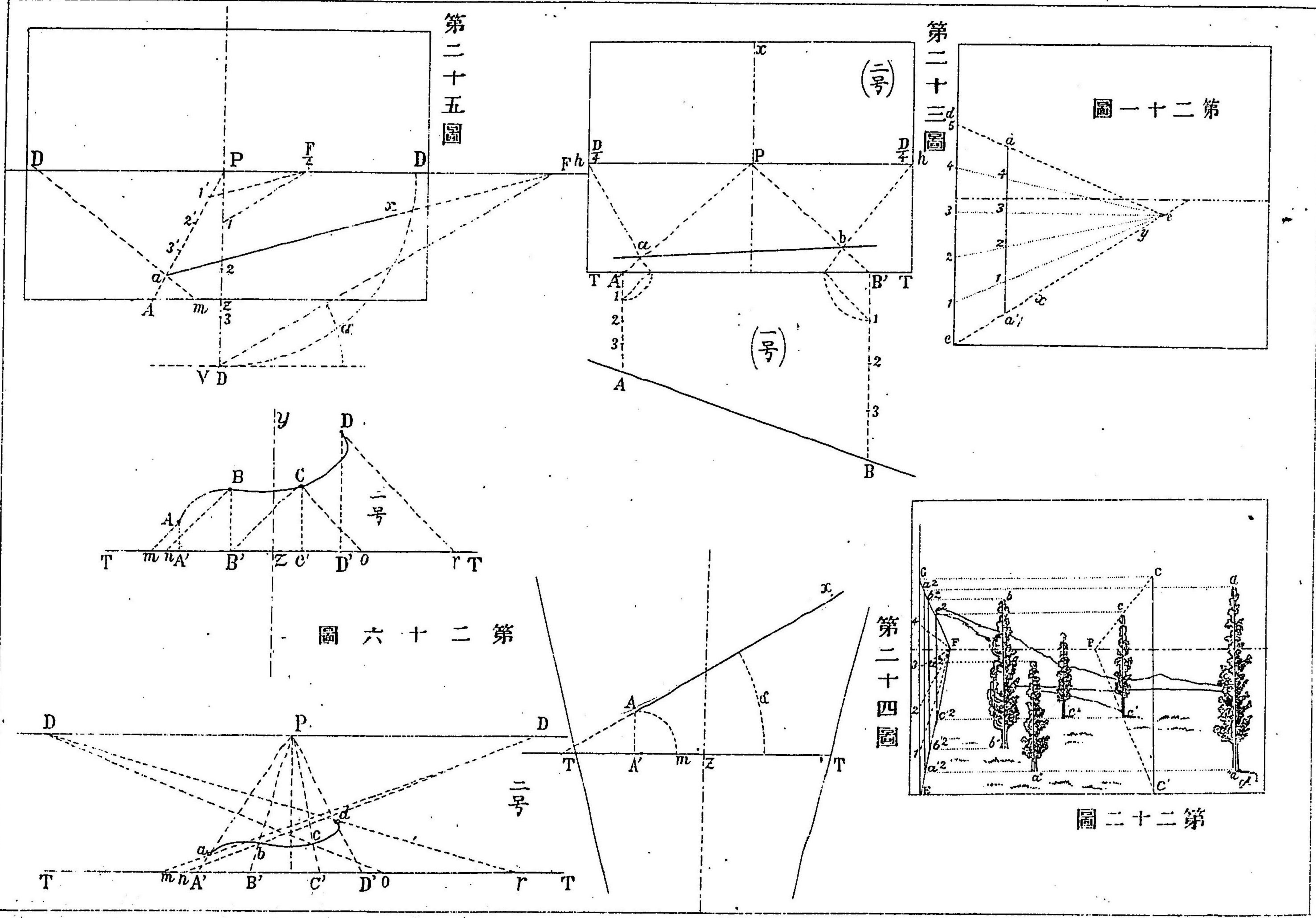

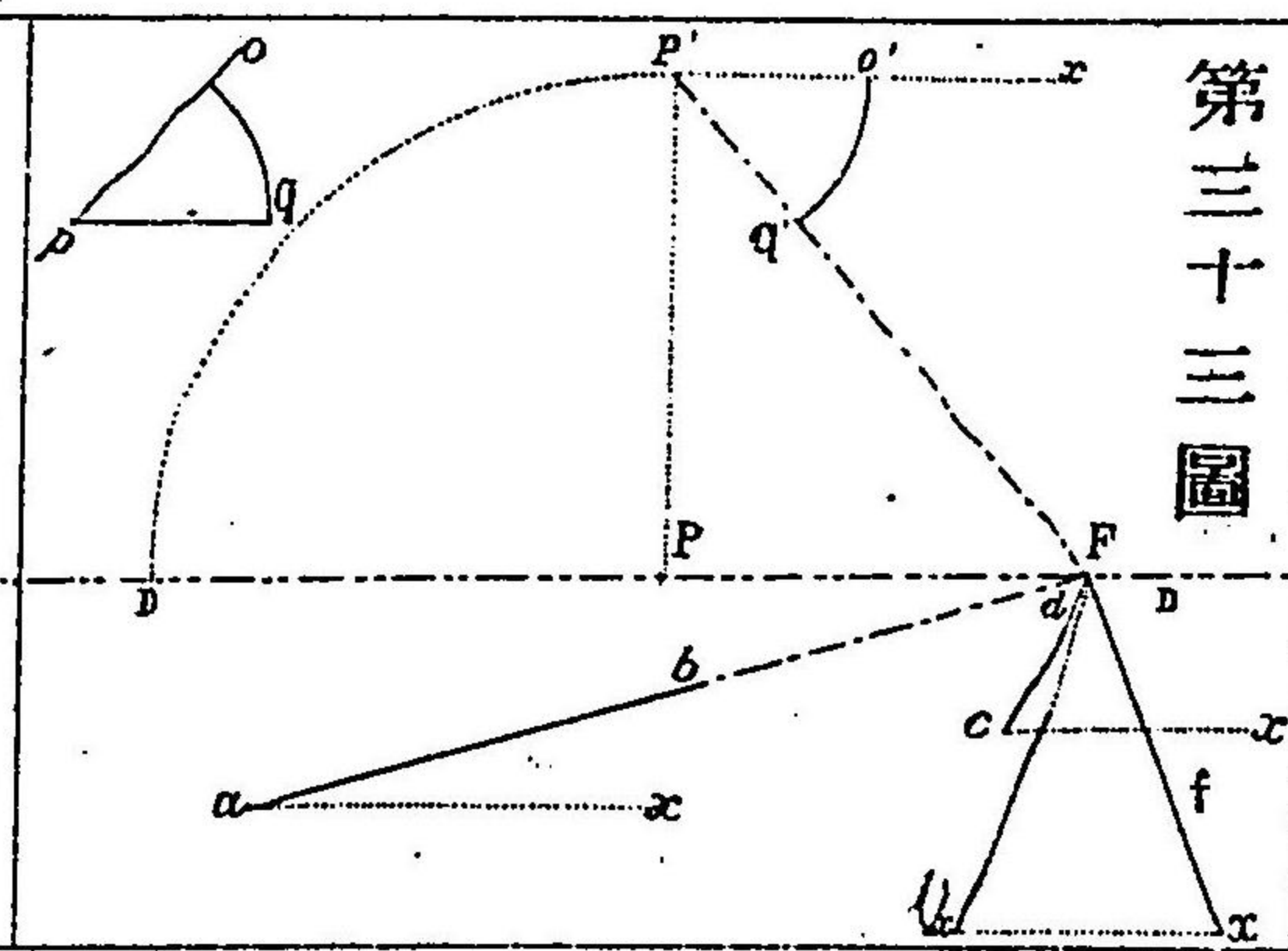
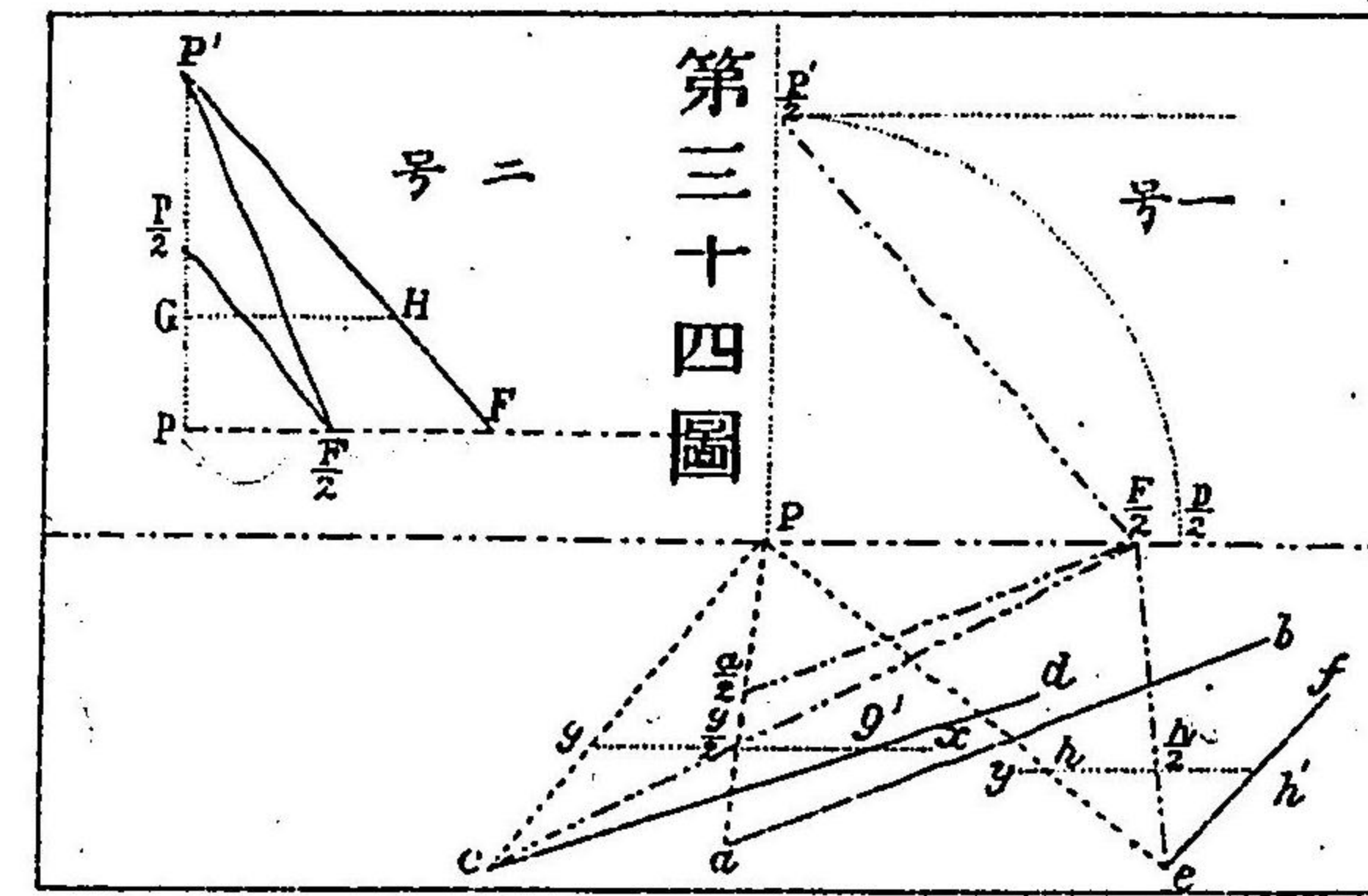
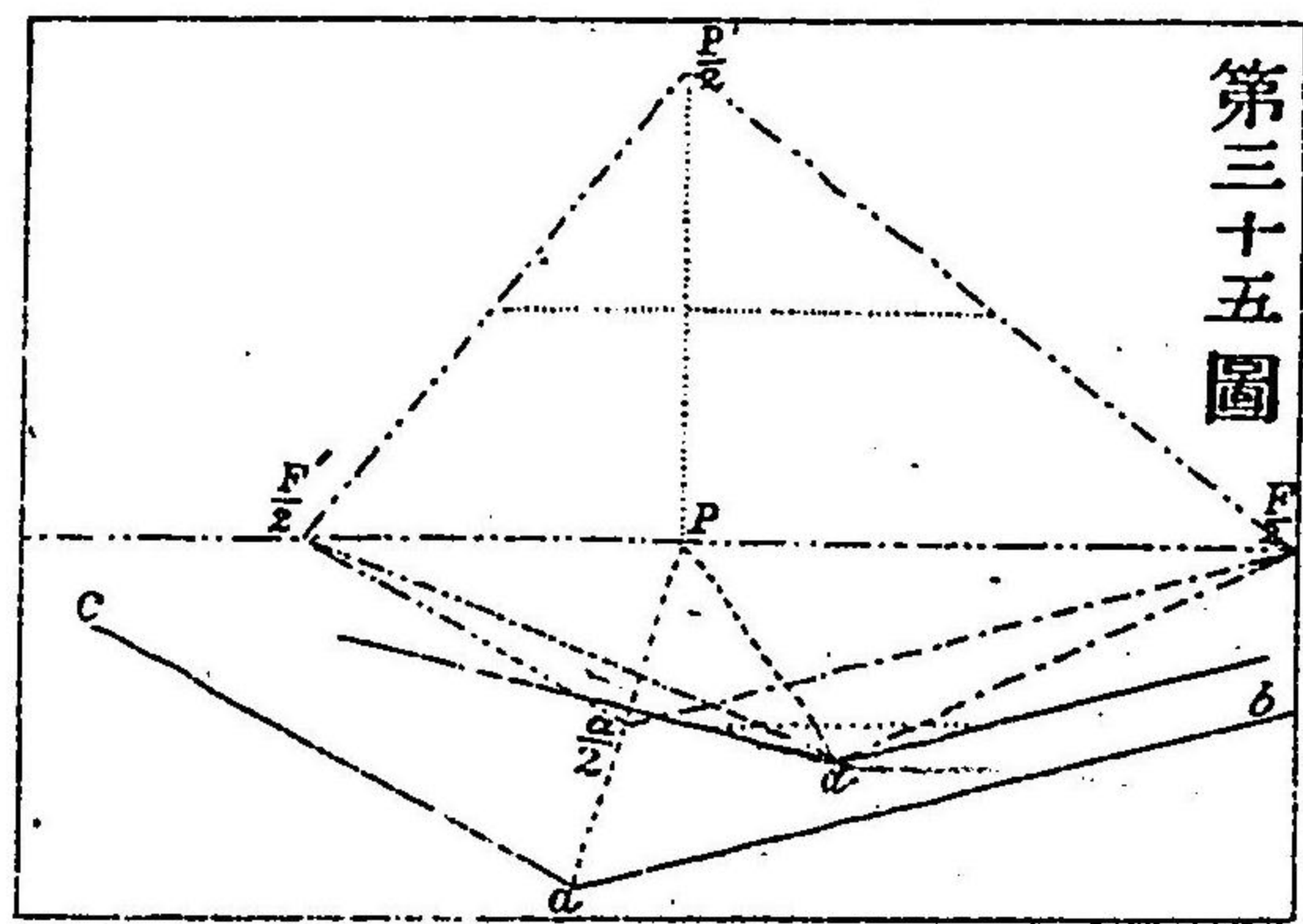
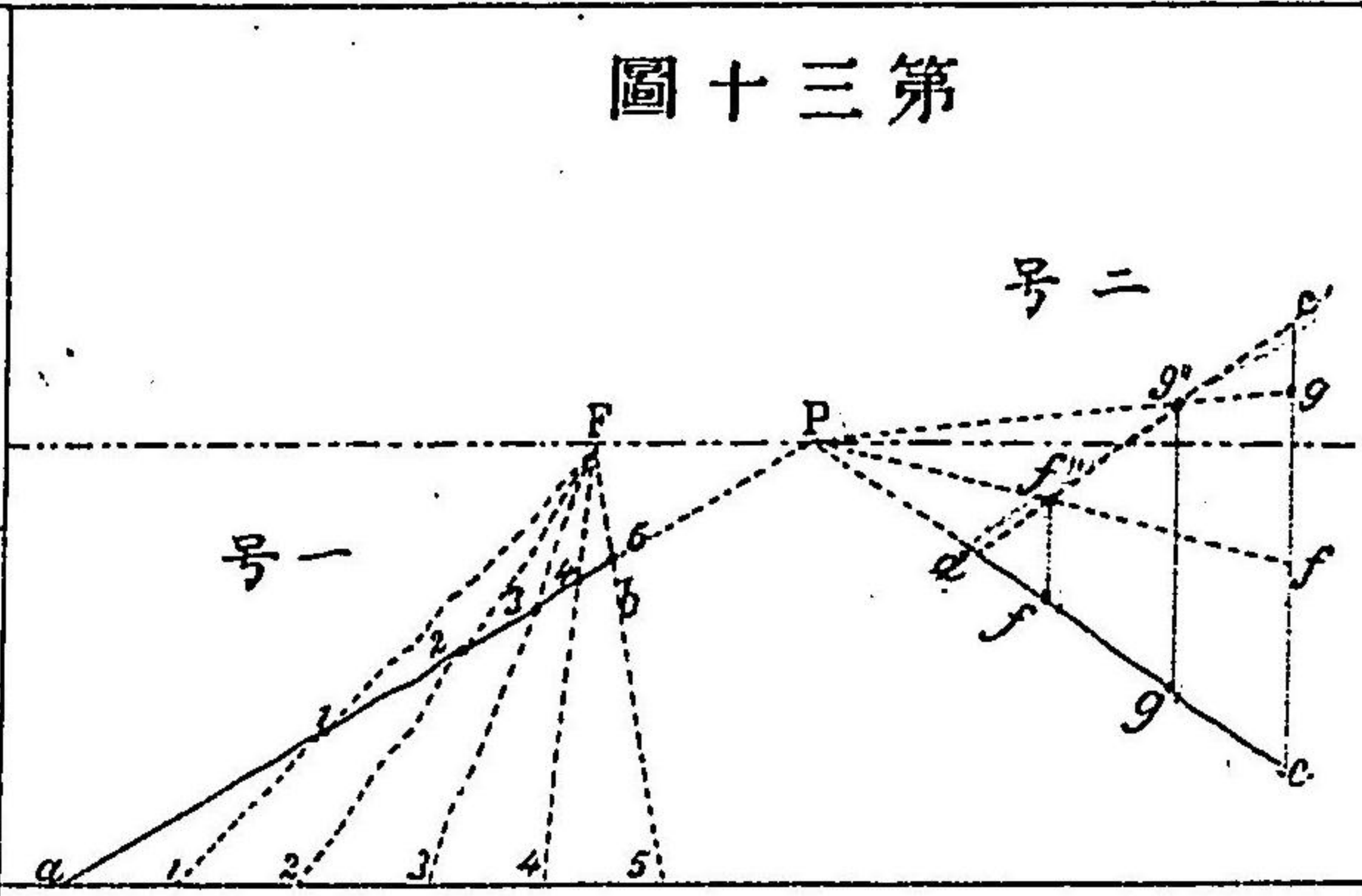
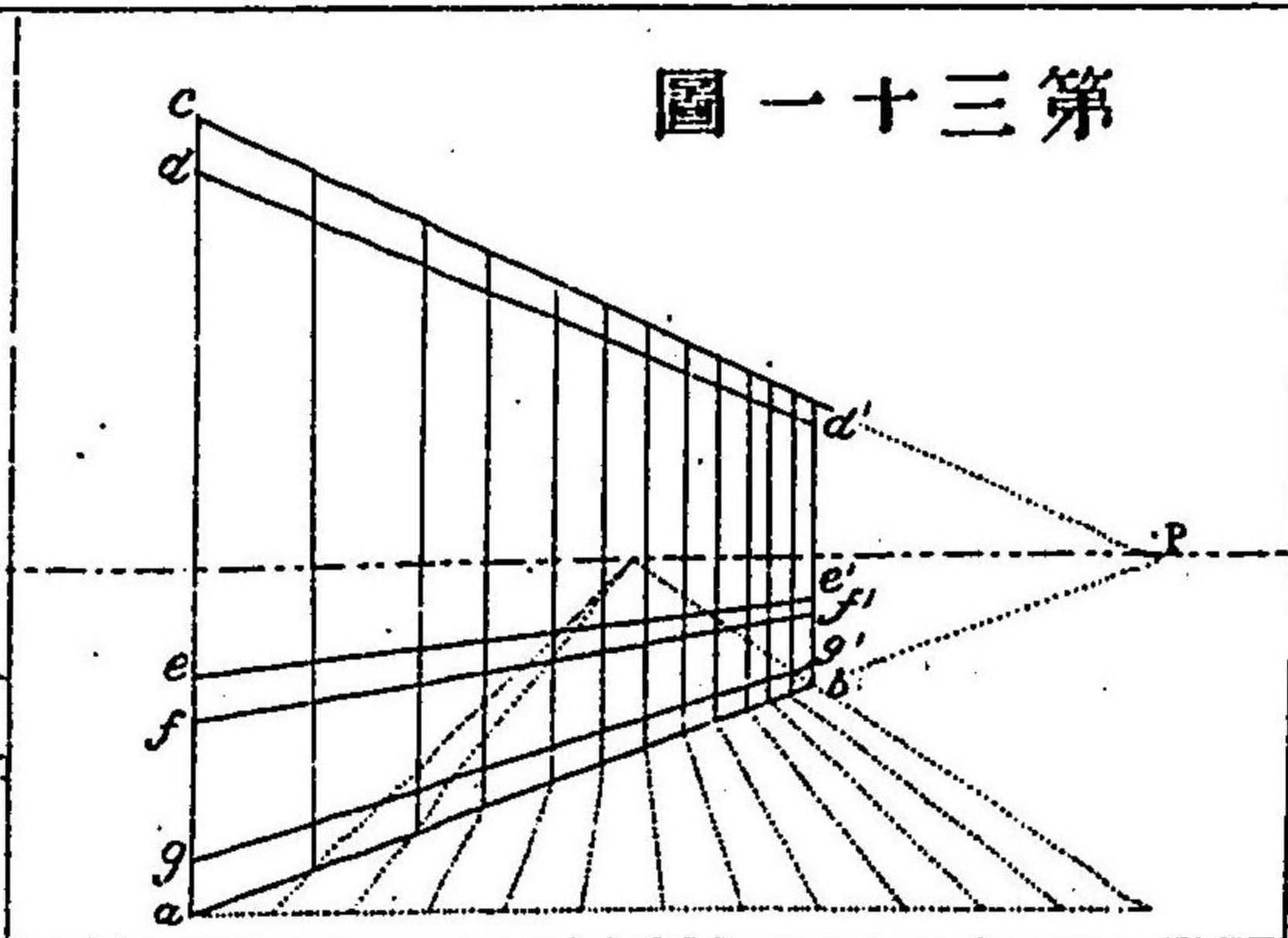
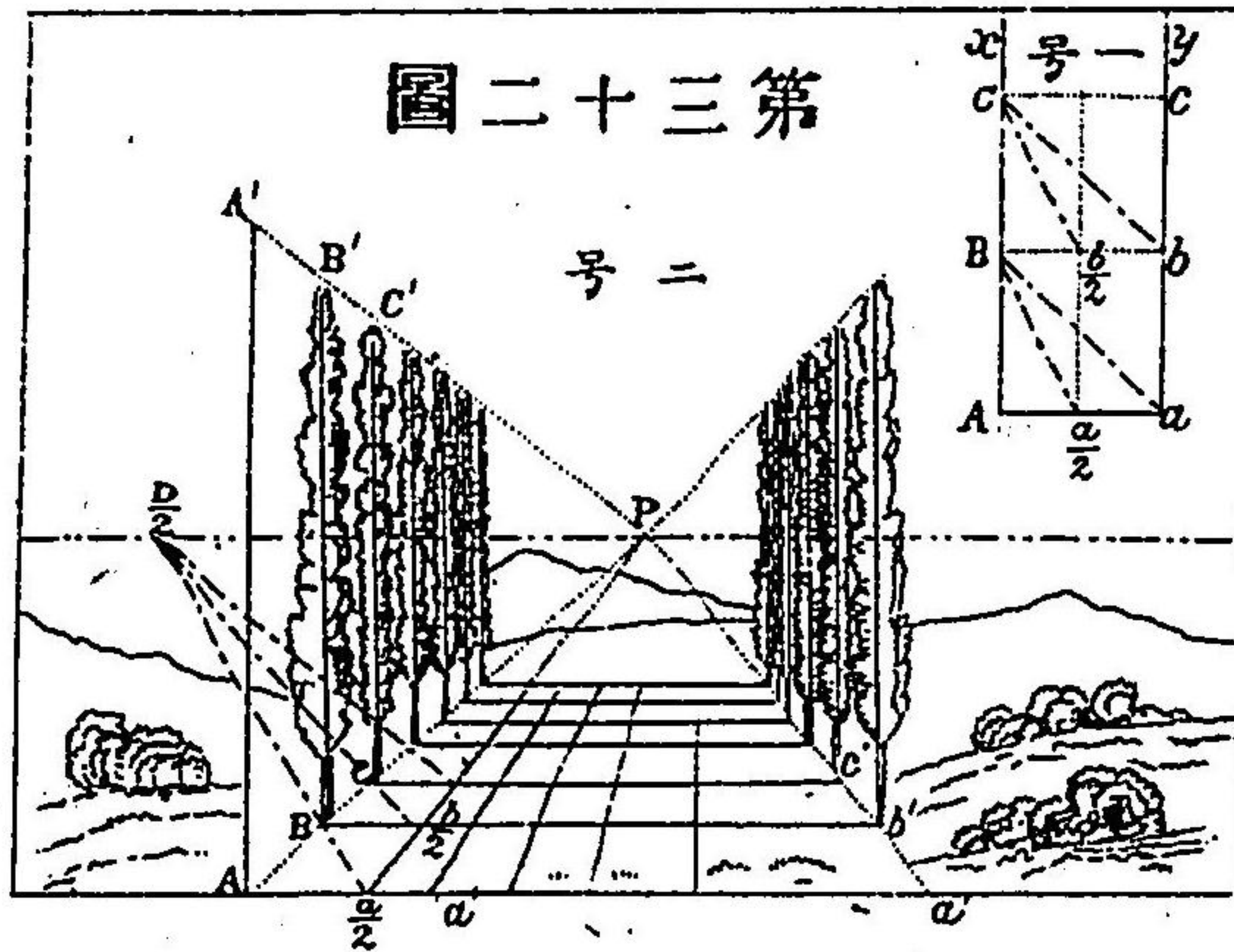
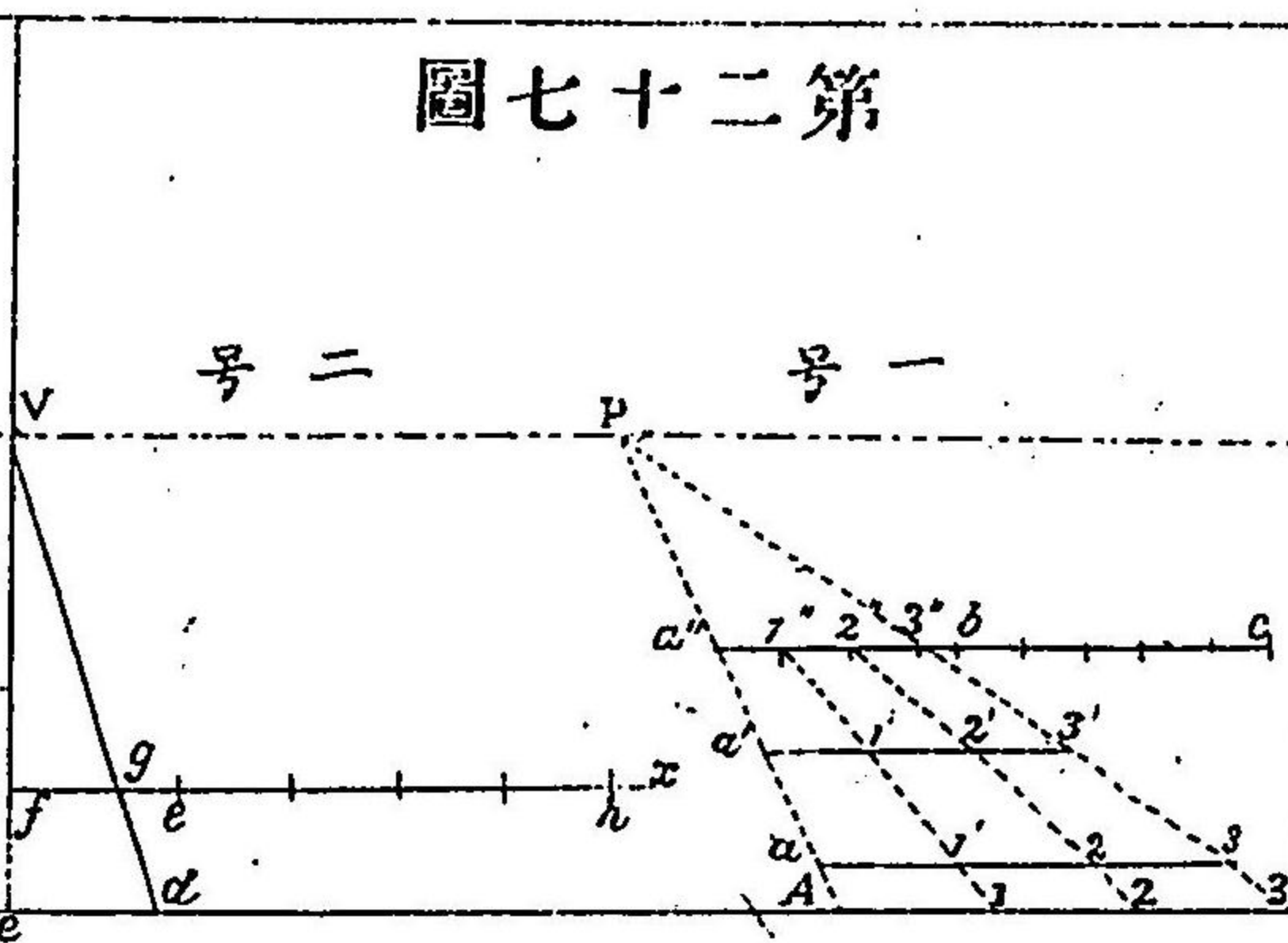
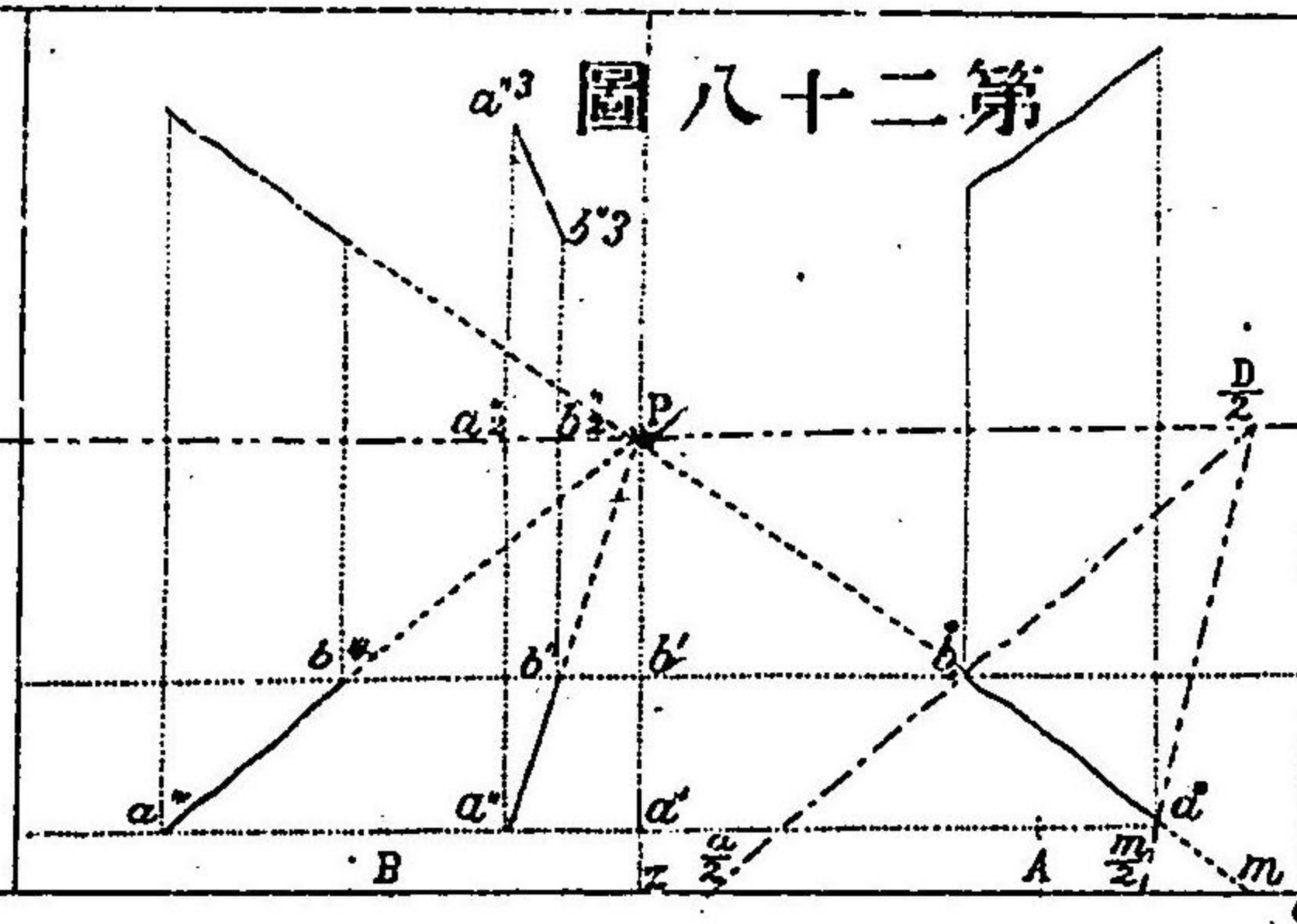
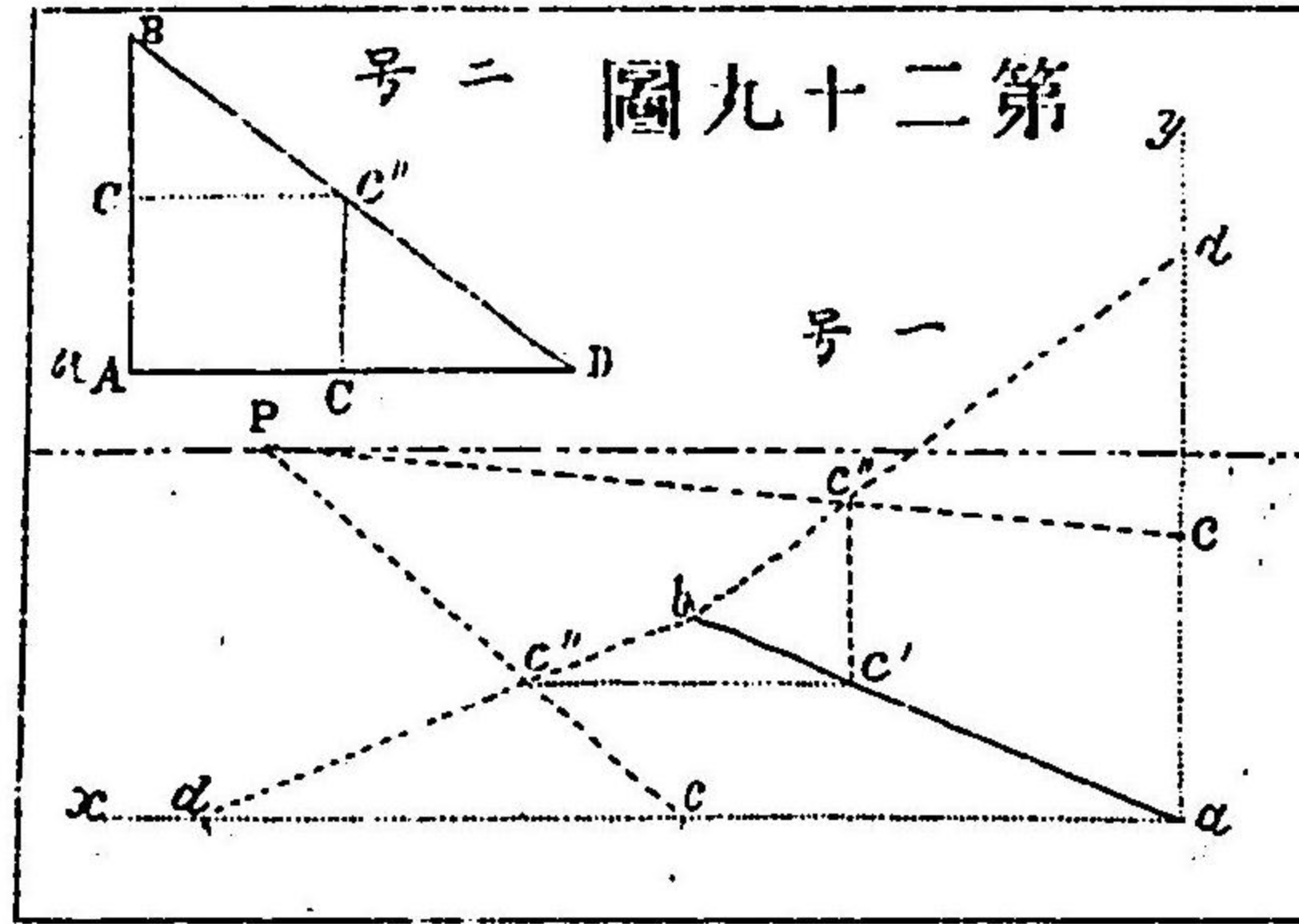

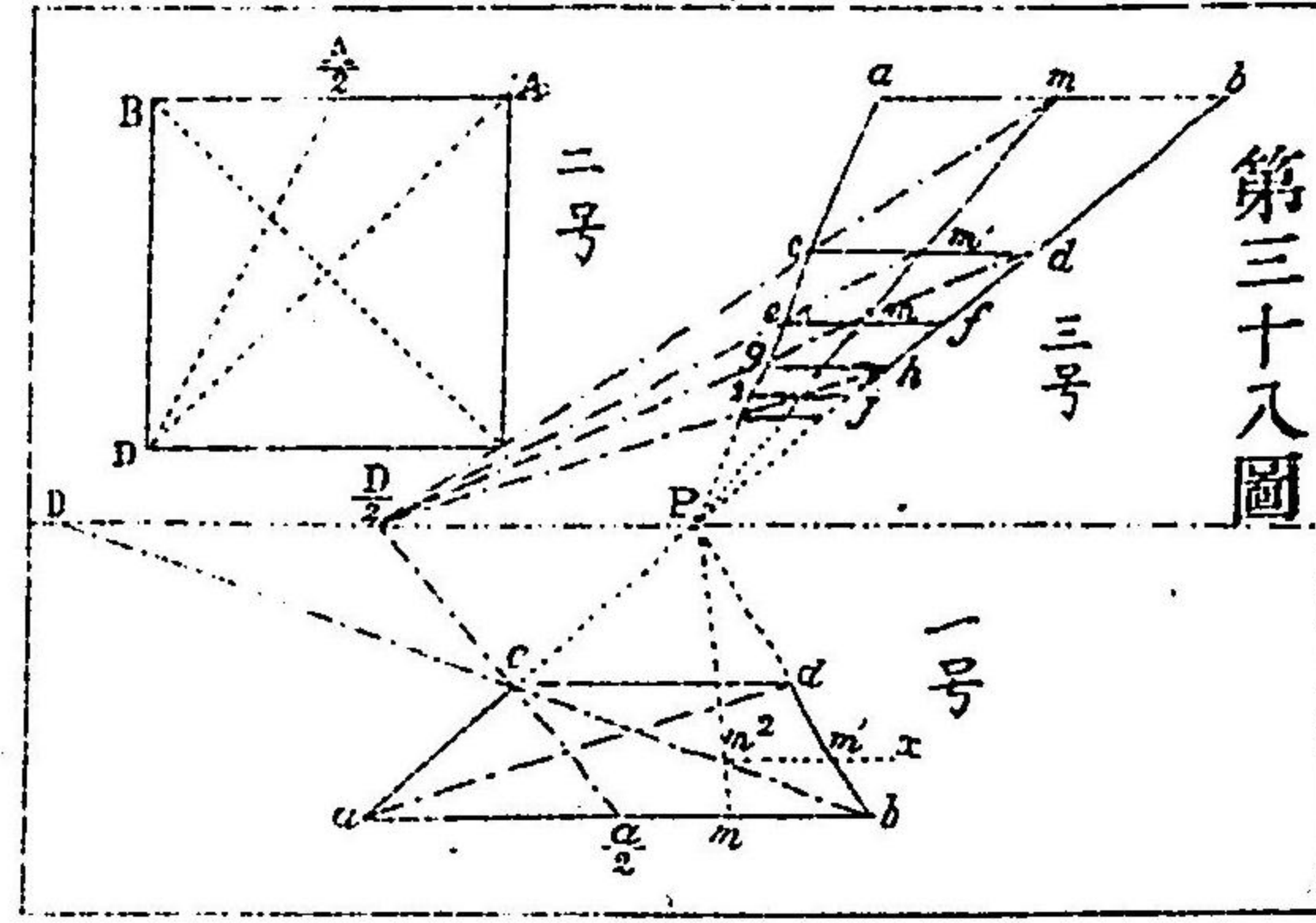

第三十八圖

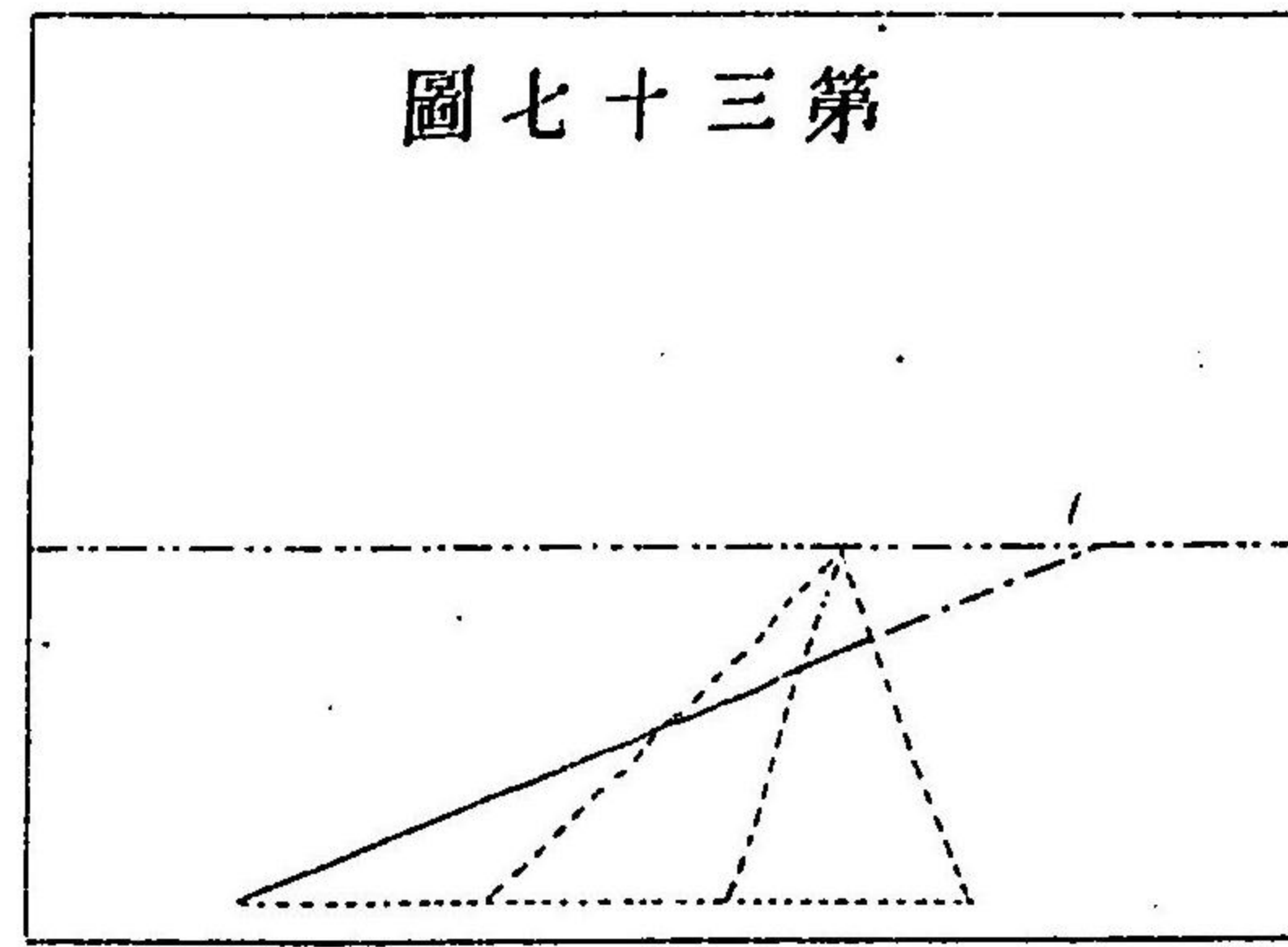

圖七十三第

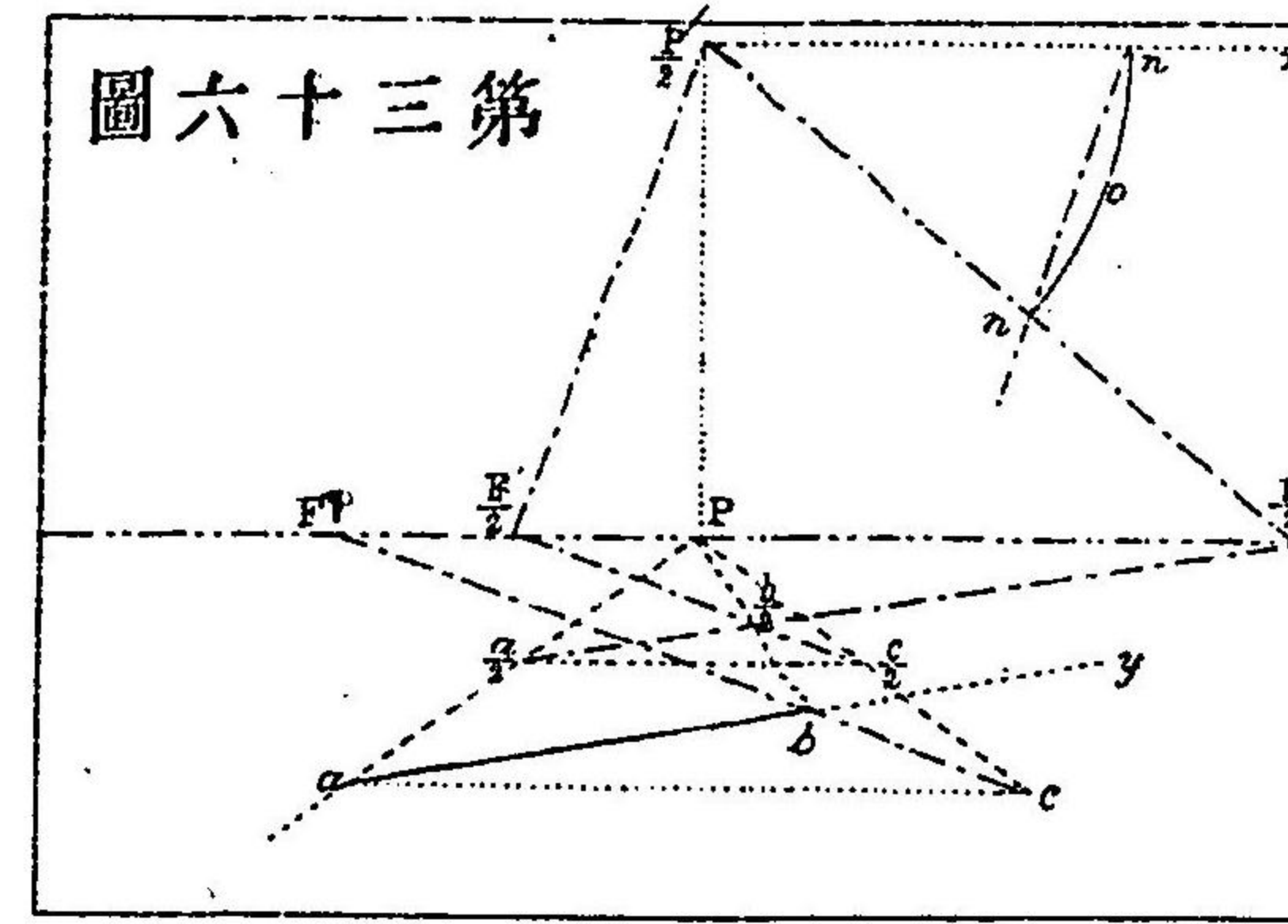

圖六十三第

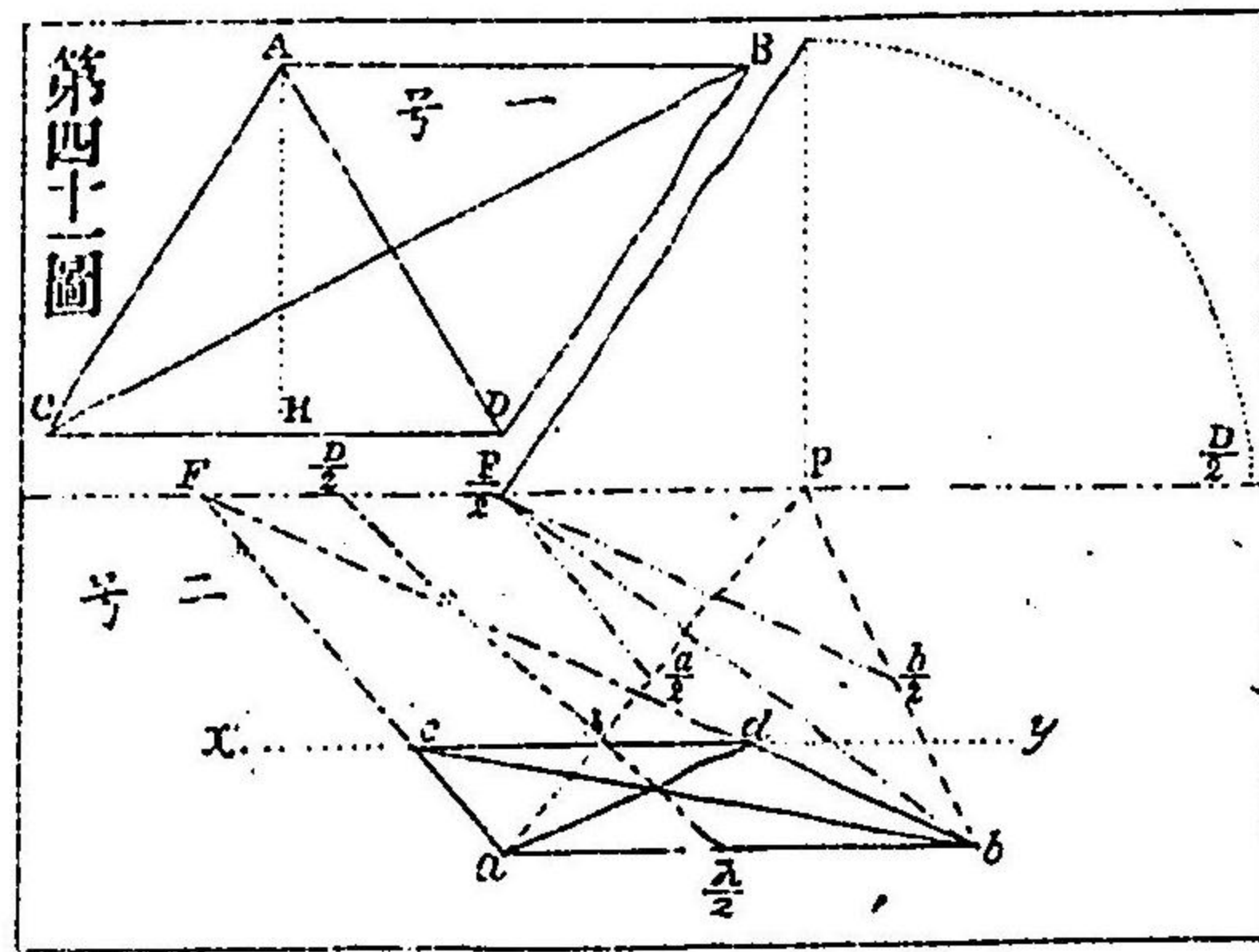

第四十一圖

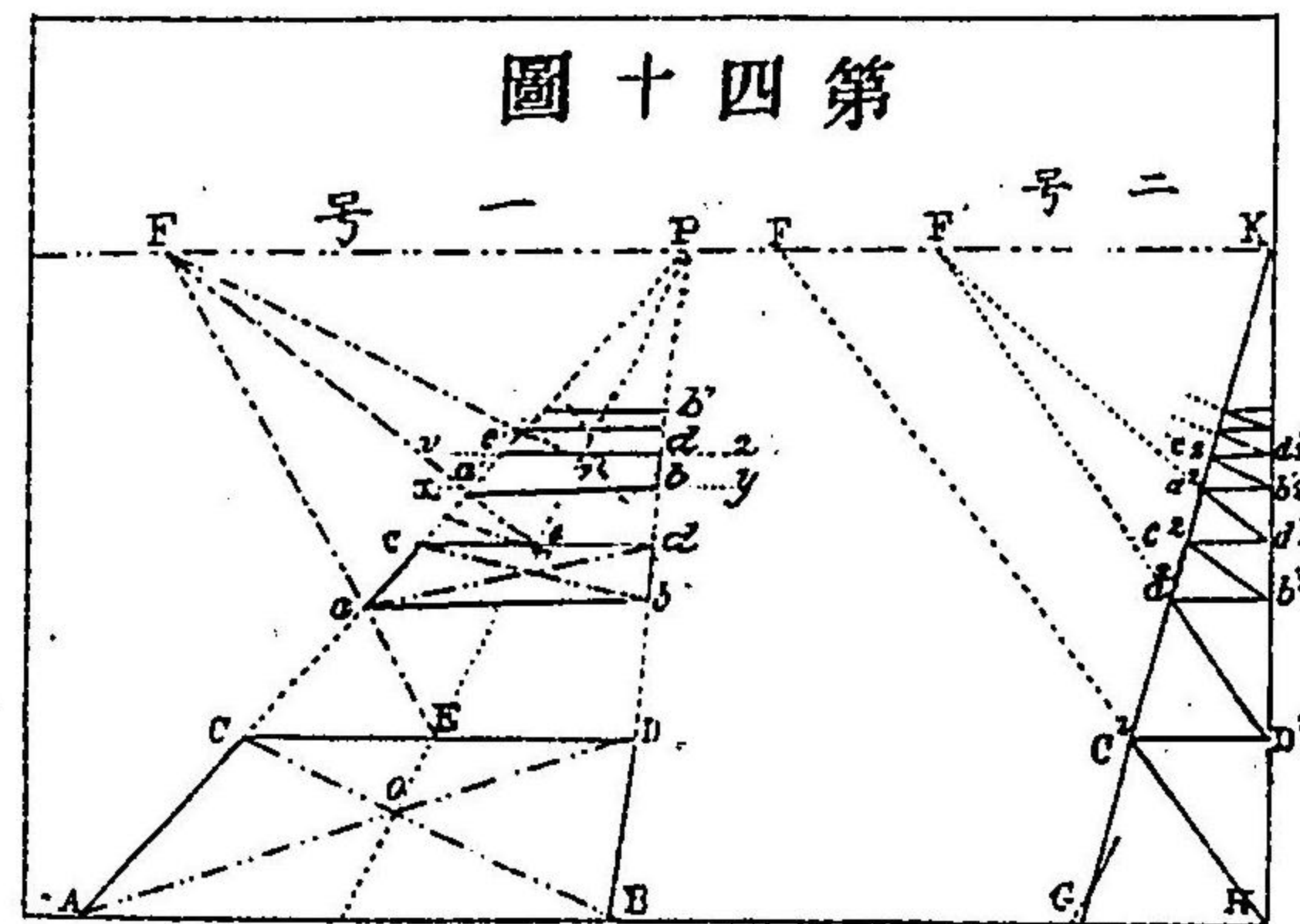

圖十四第

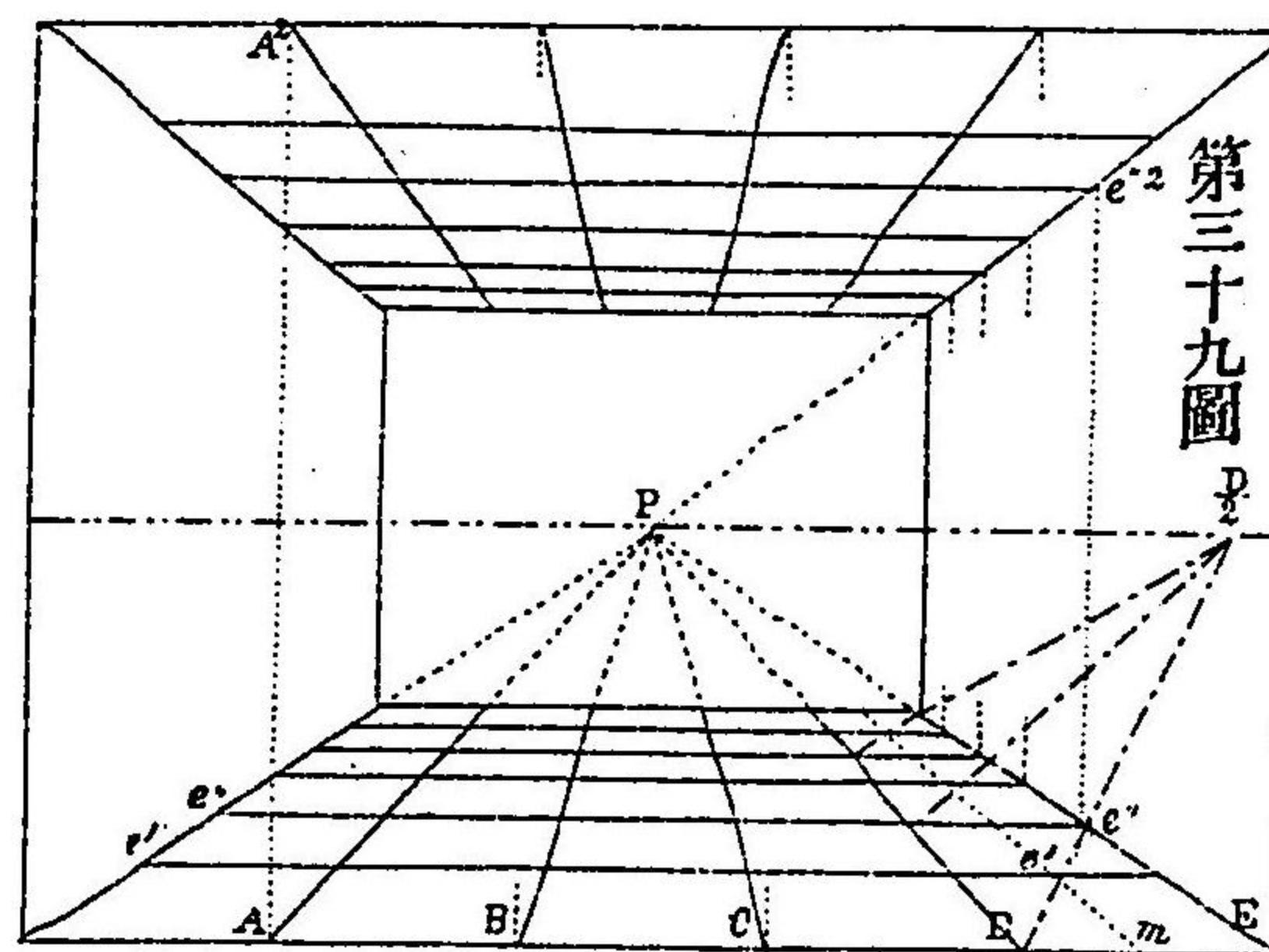

第三十九圖

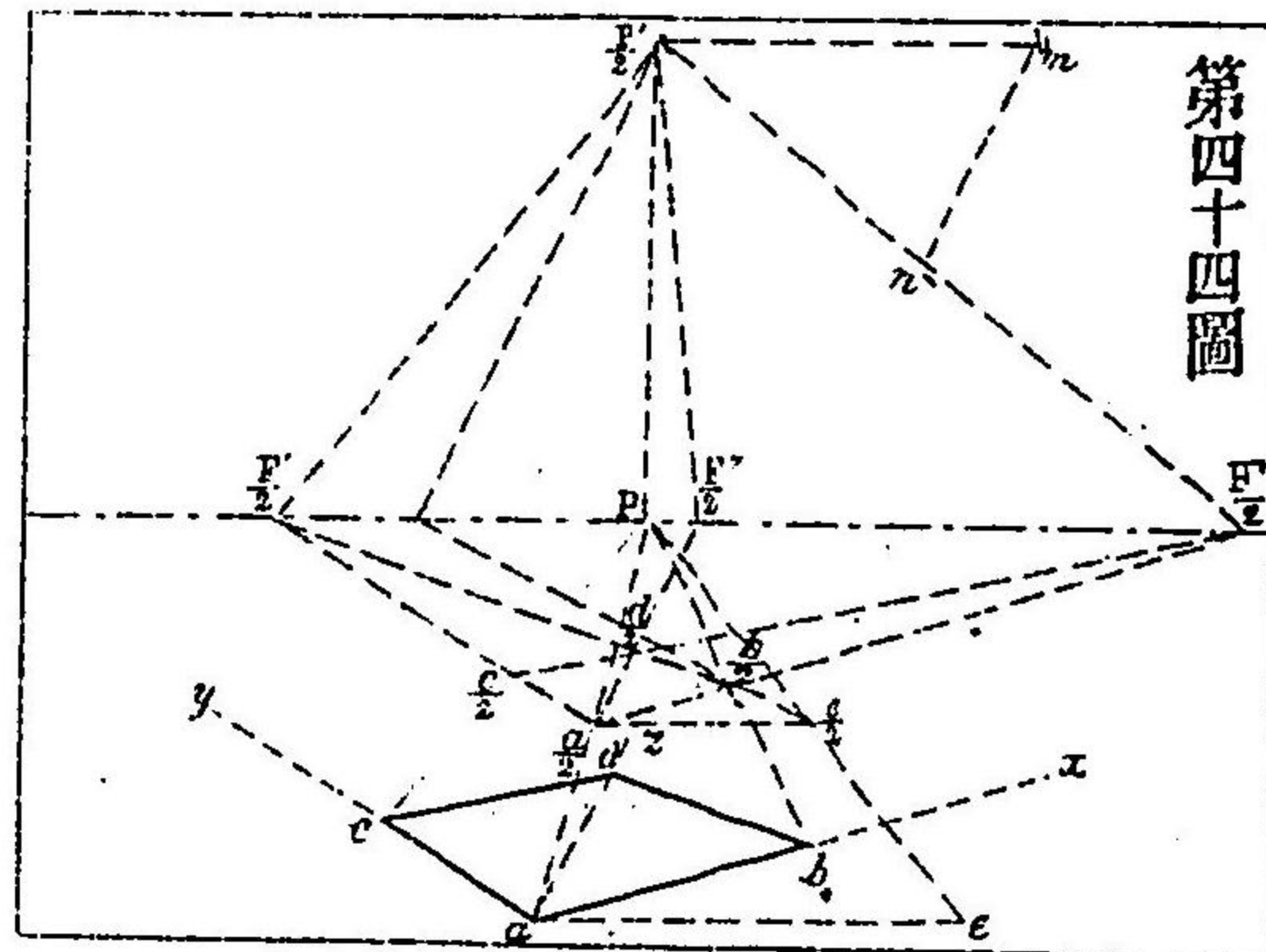

第四十四圖

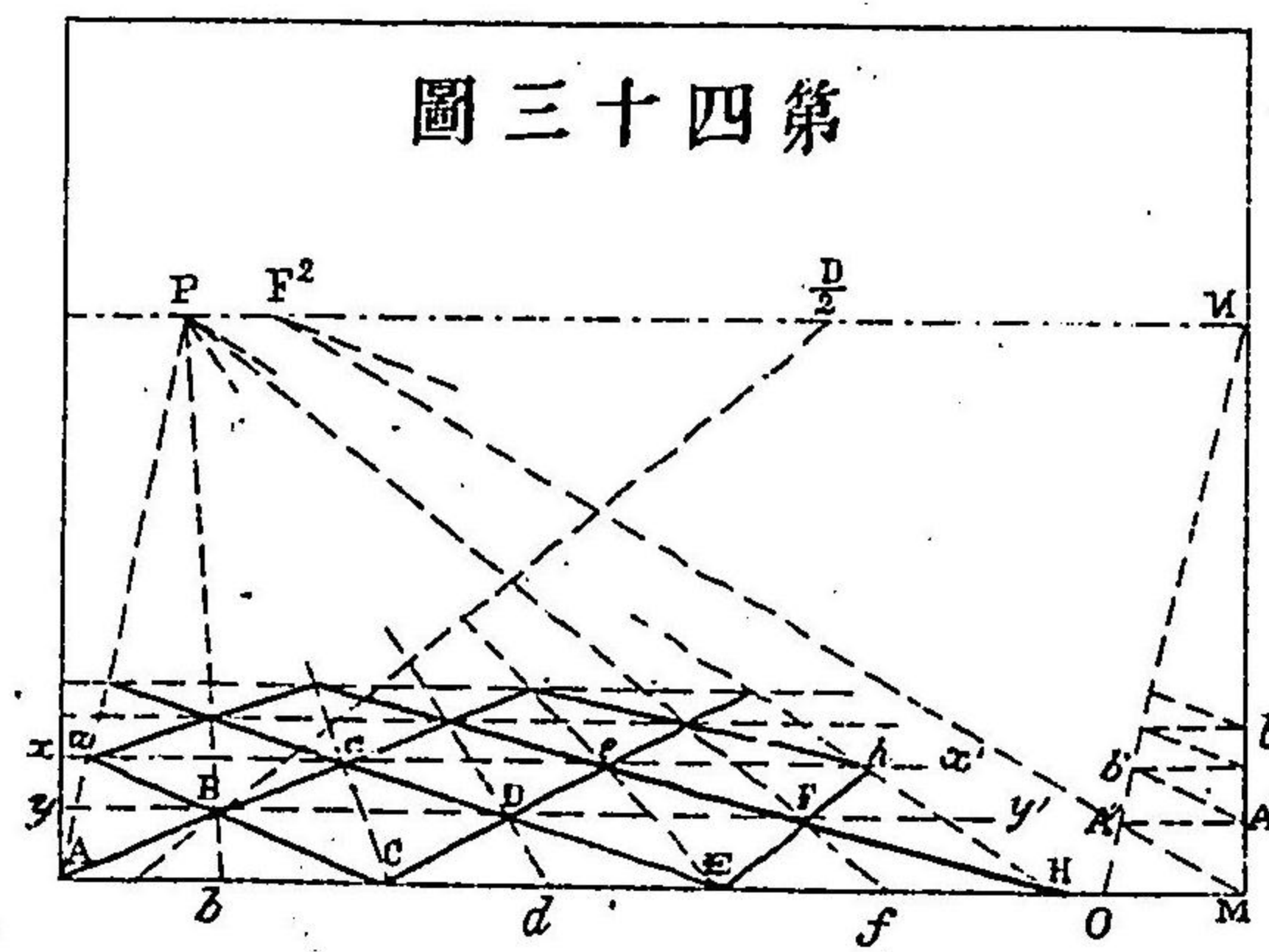

圖三十四第

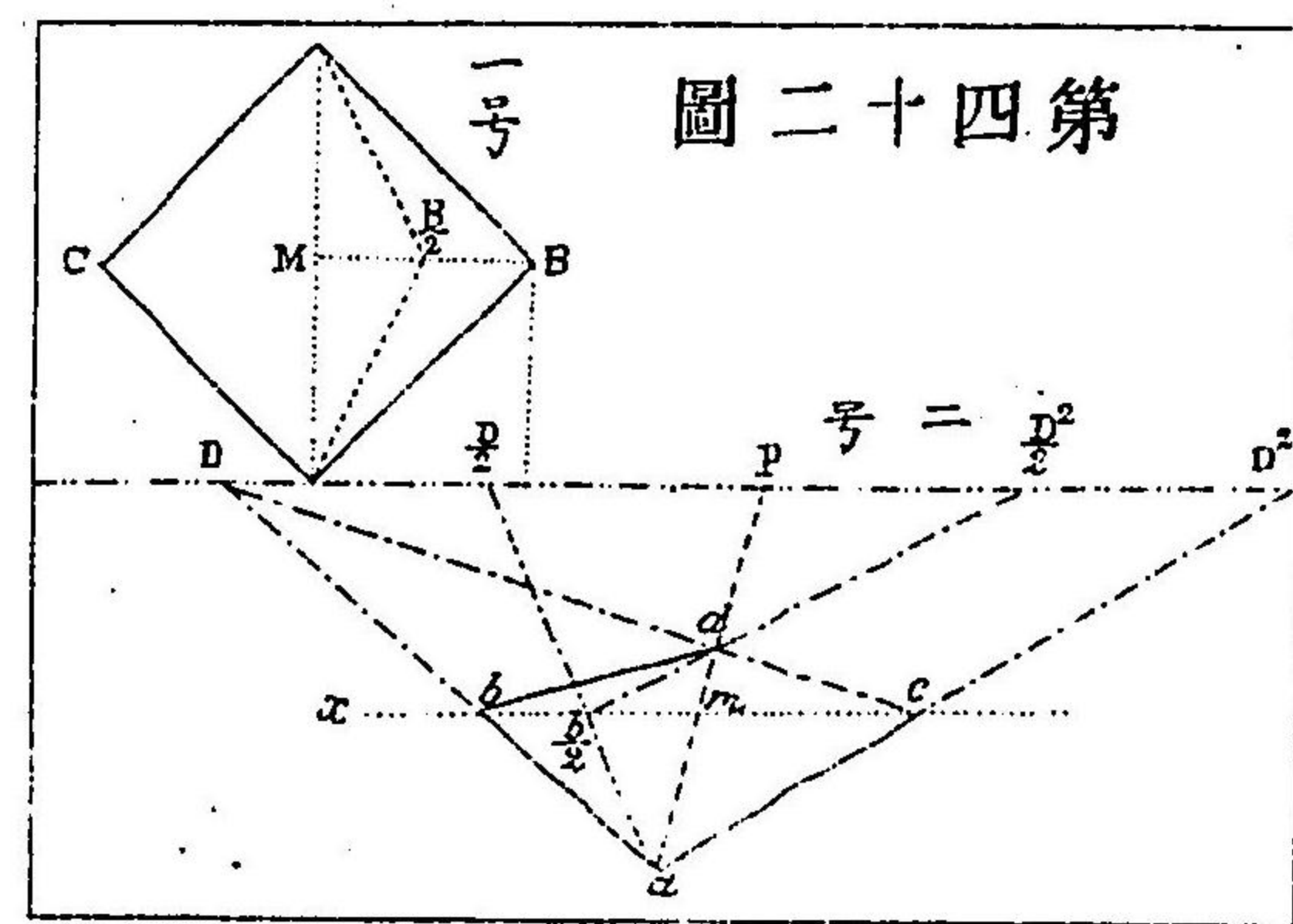

圖二十四第

圖九十四第

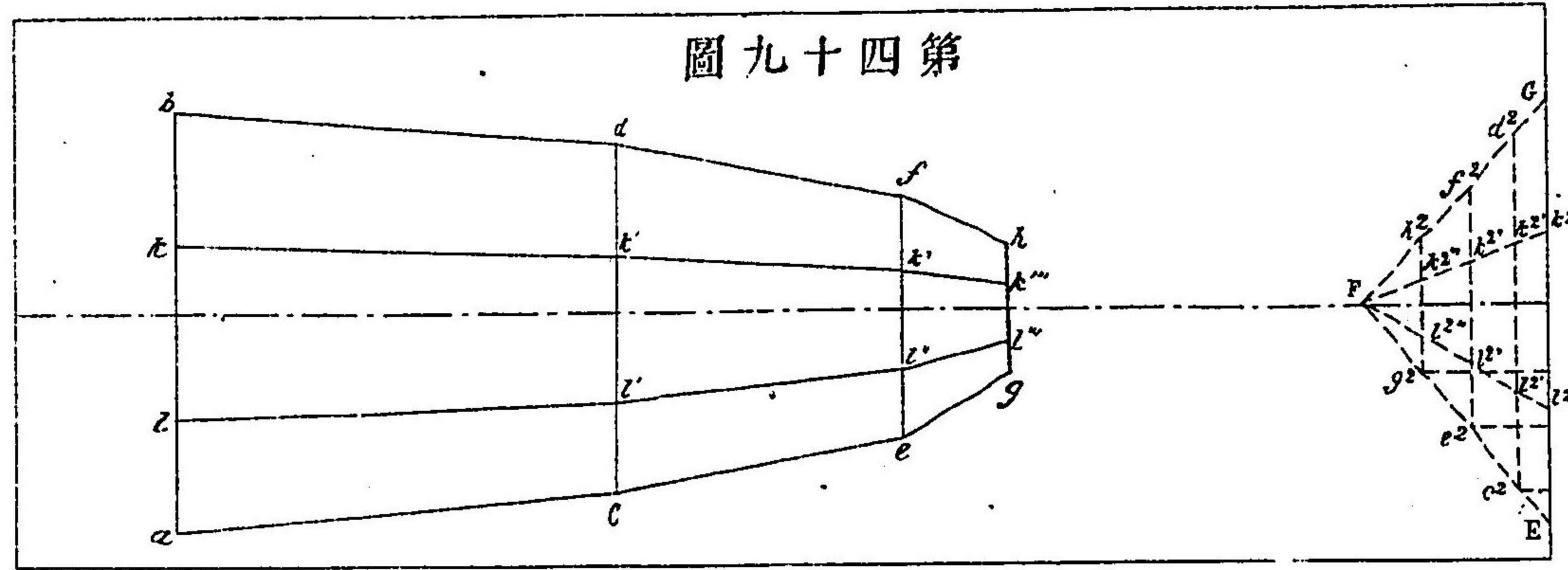

圖七十四第

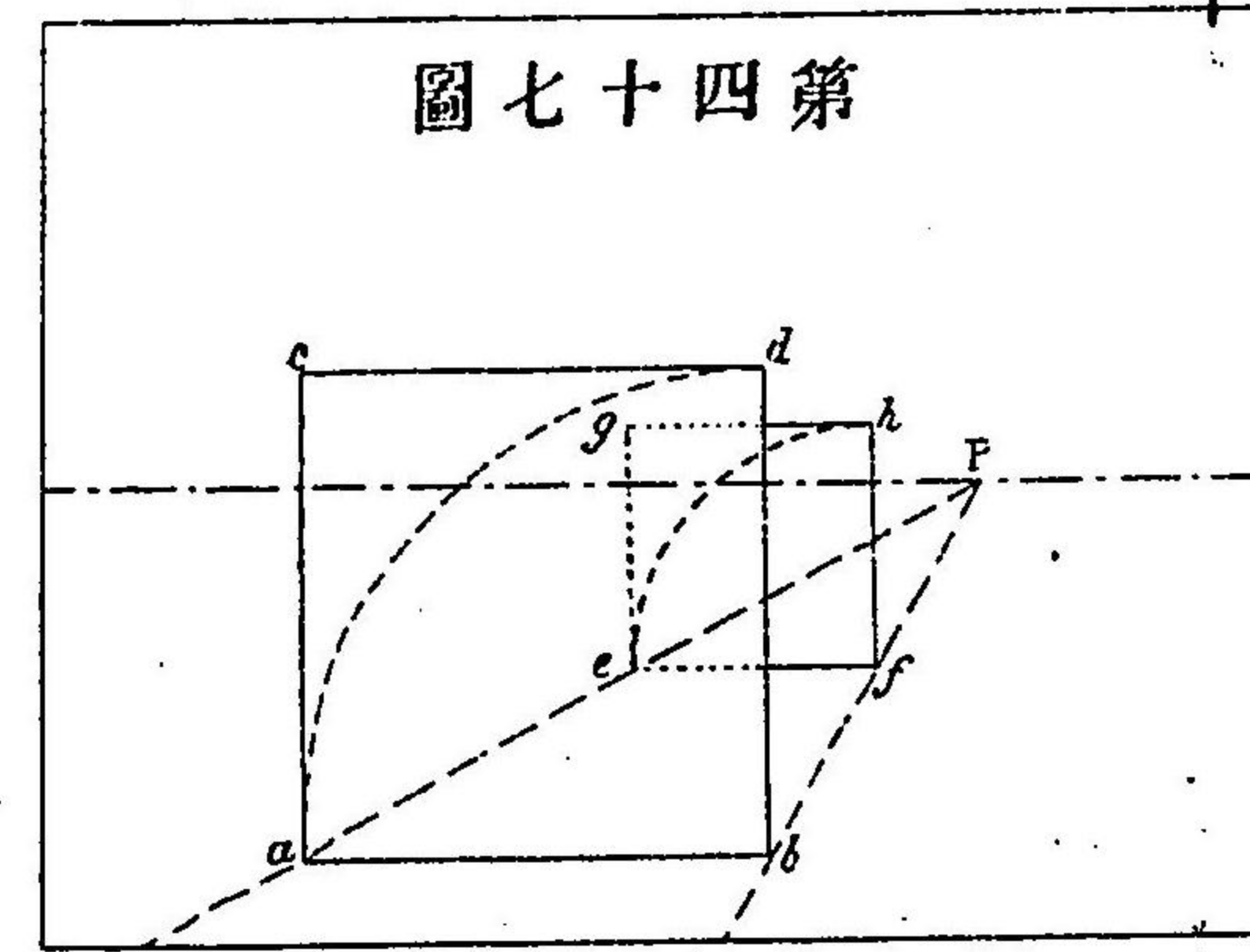

圖十五第

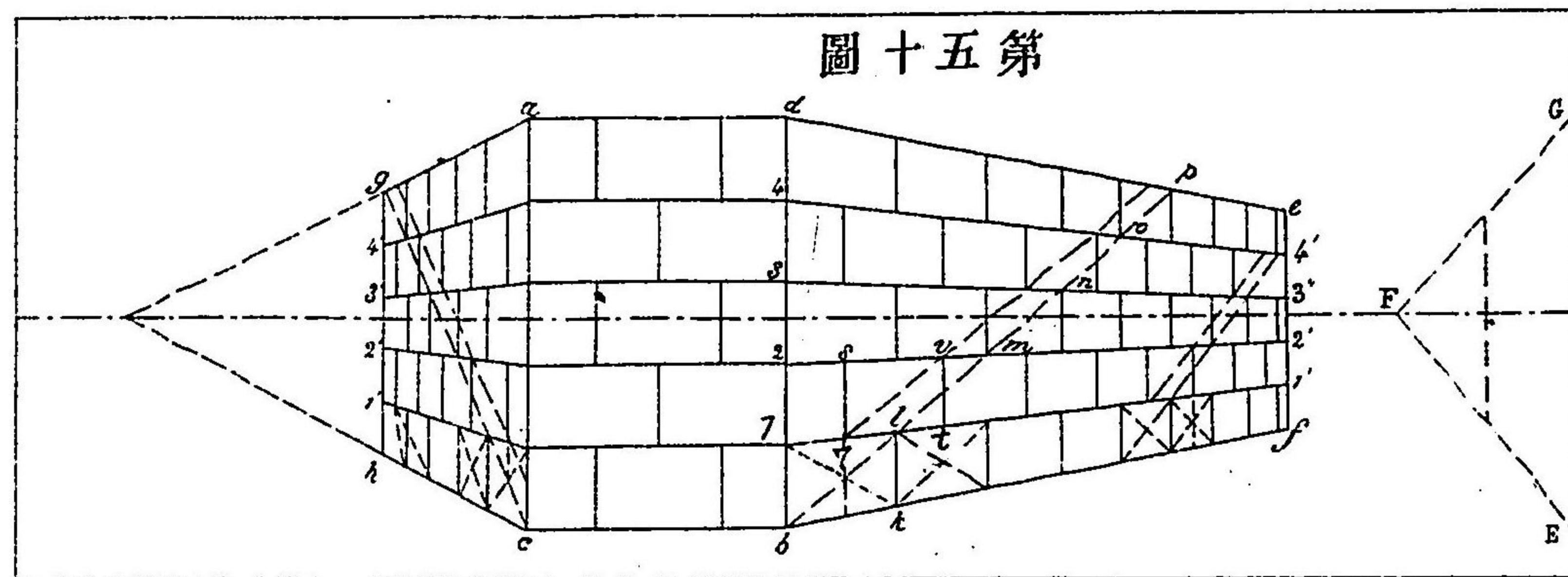

圖八十四第

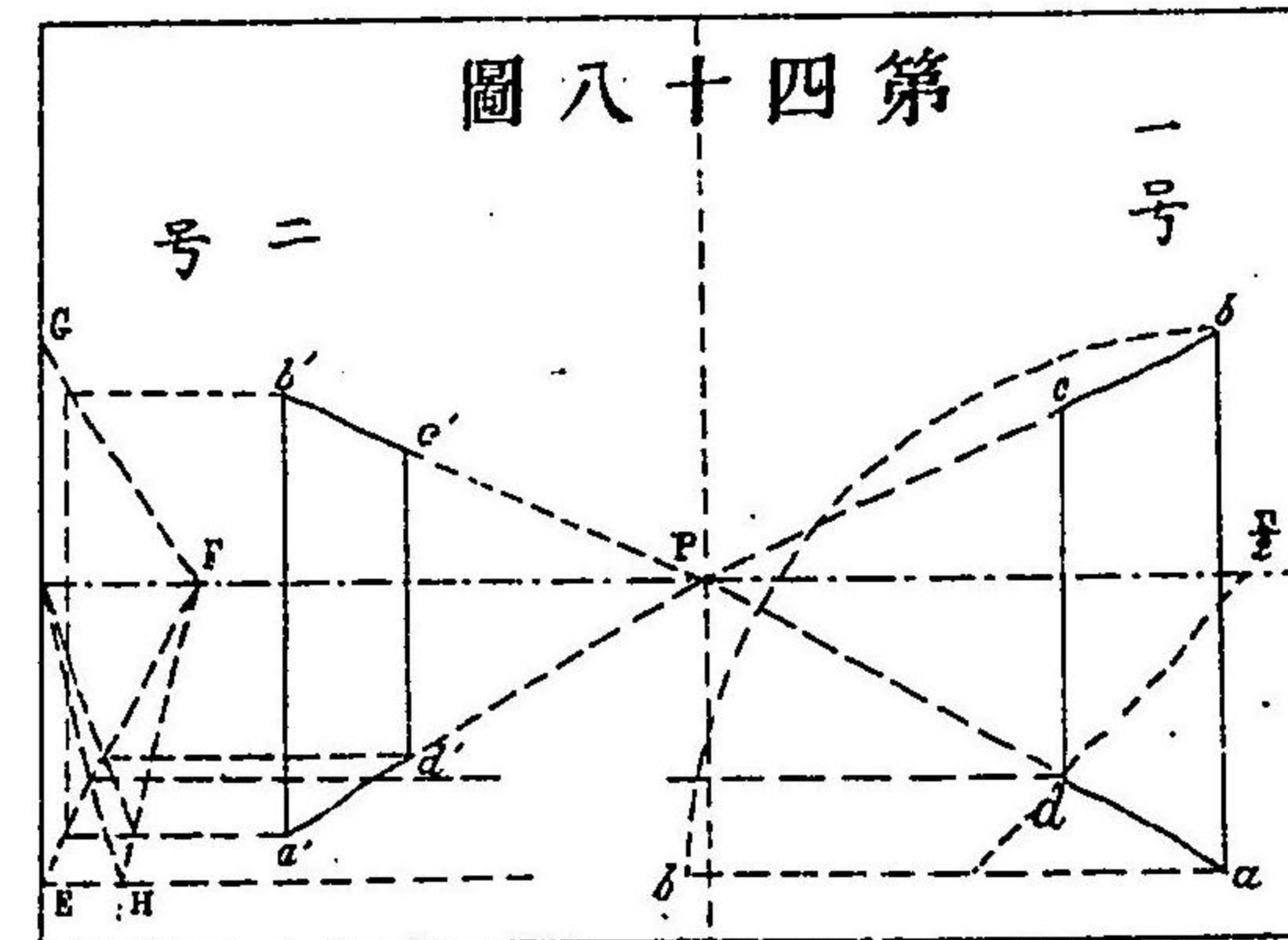

圖六十四第

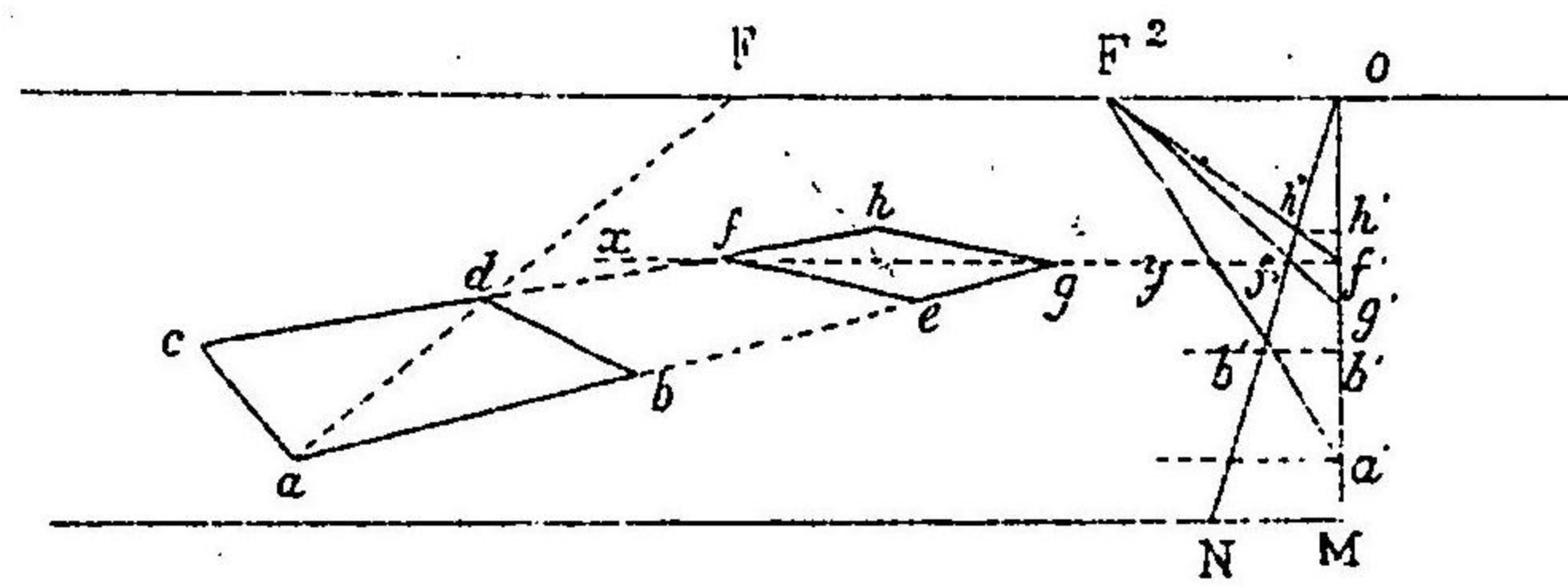

圖五十四第

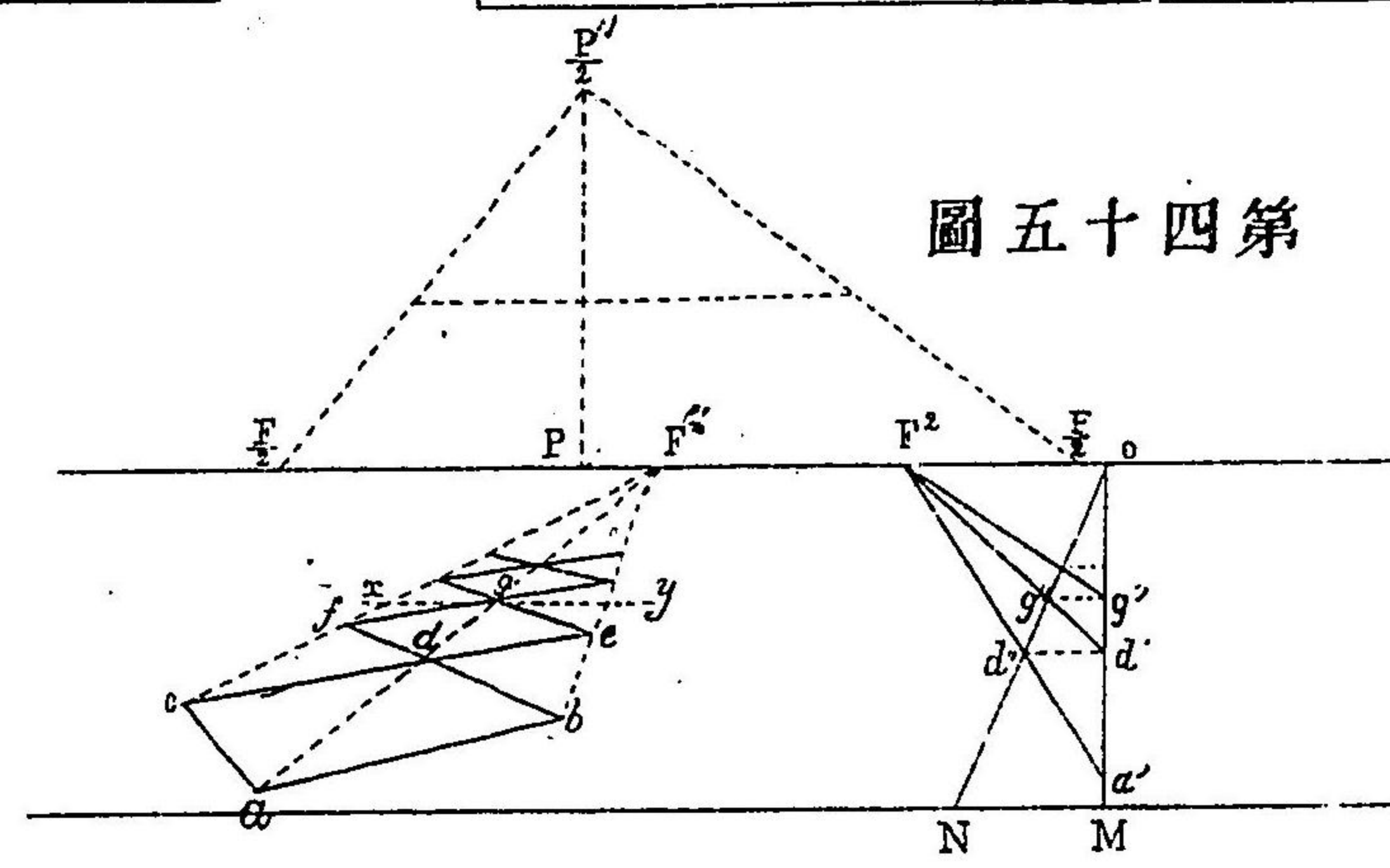

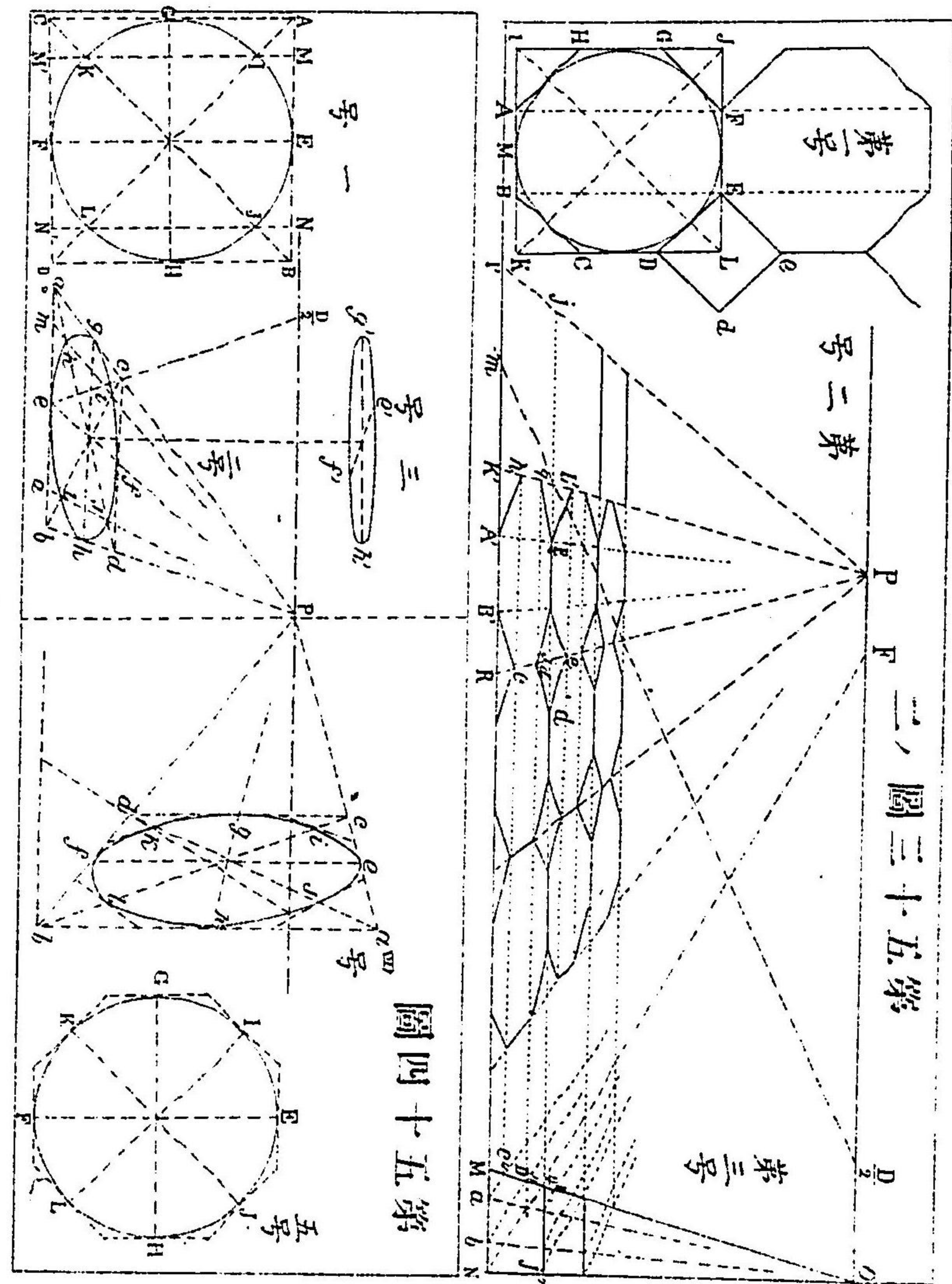
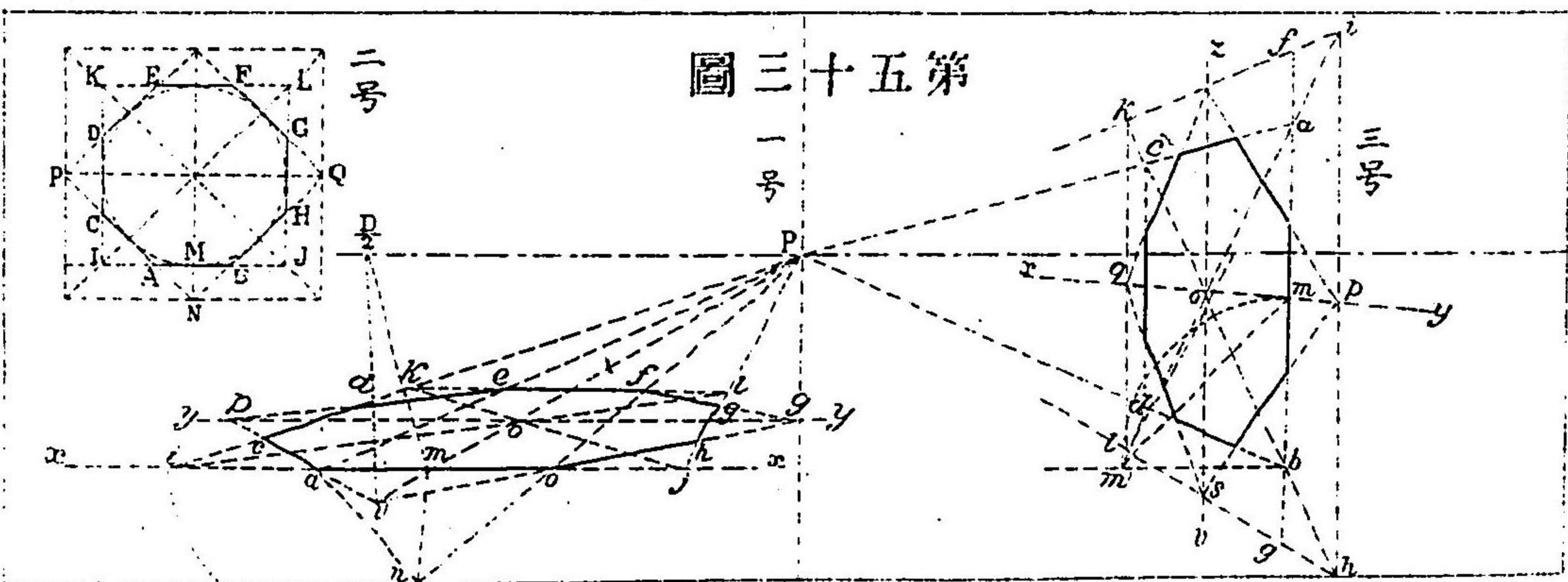
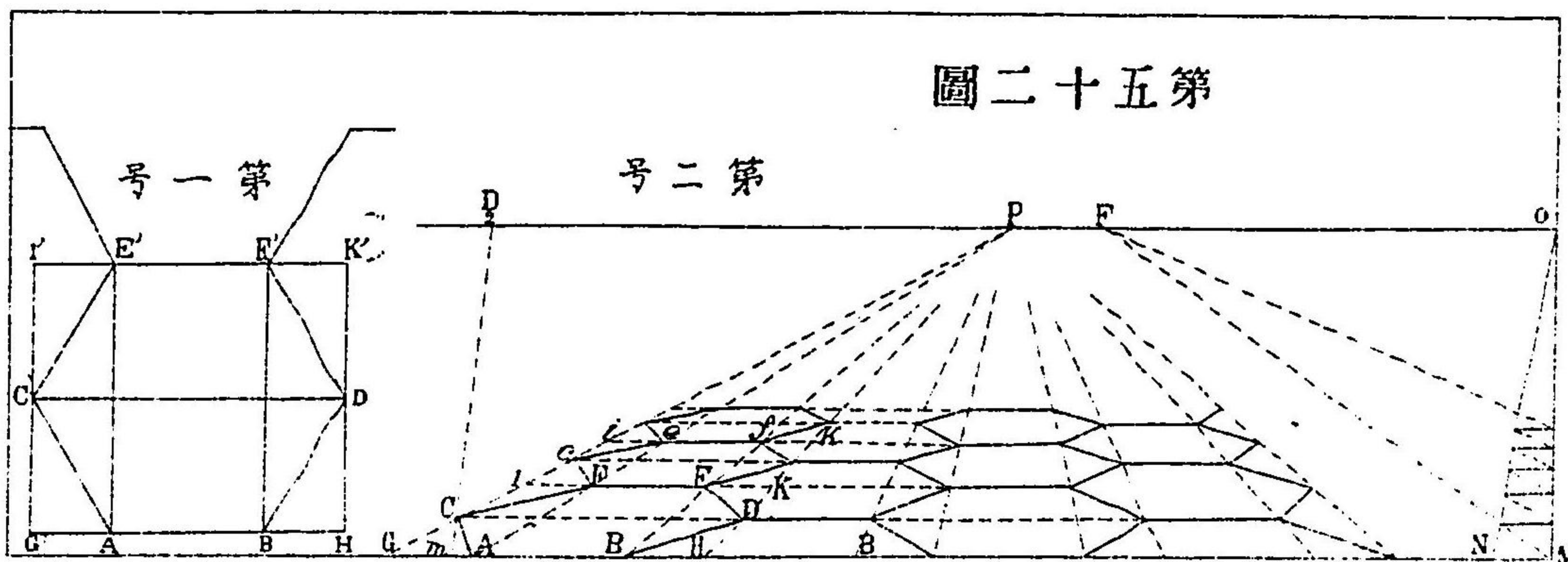
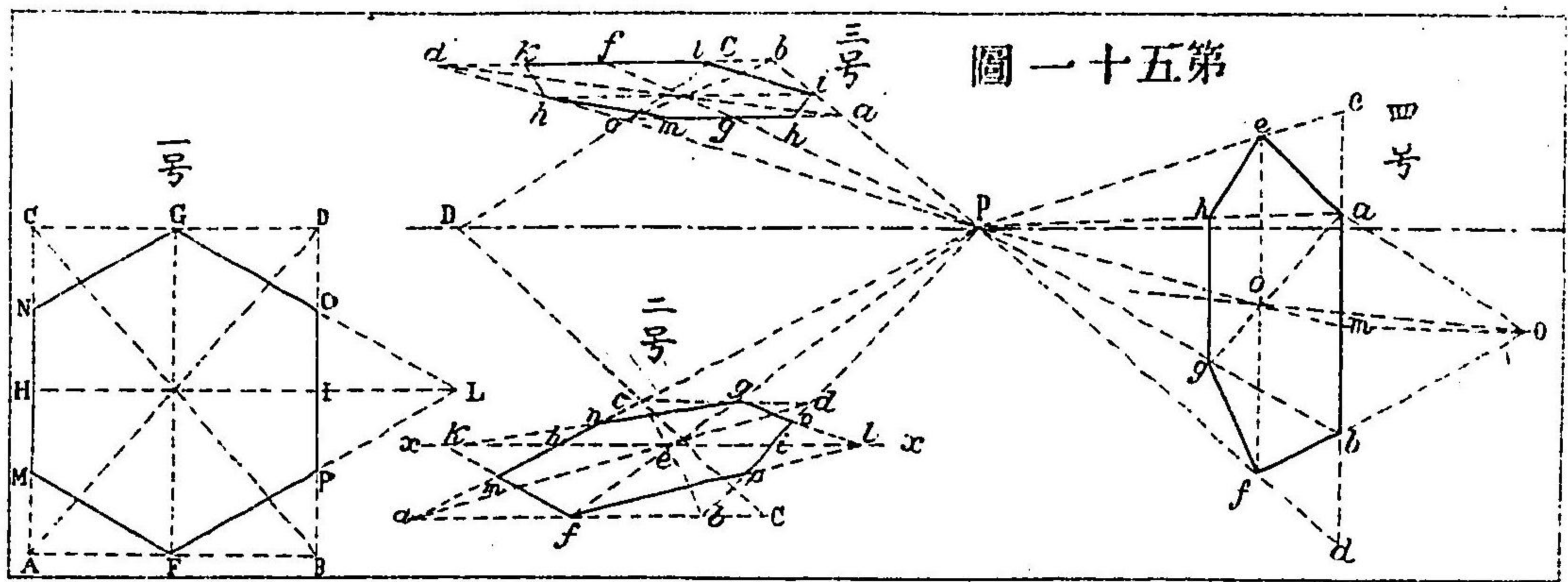

圖四十五第

圖三十五第

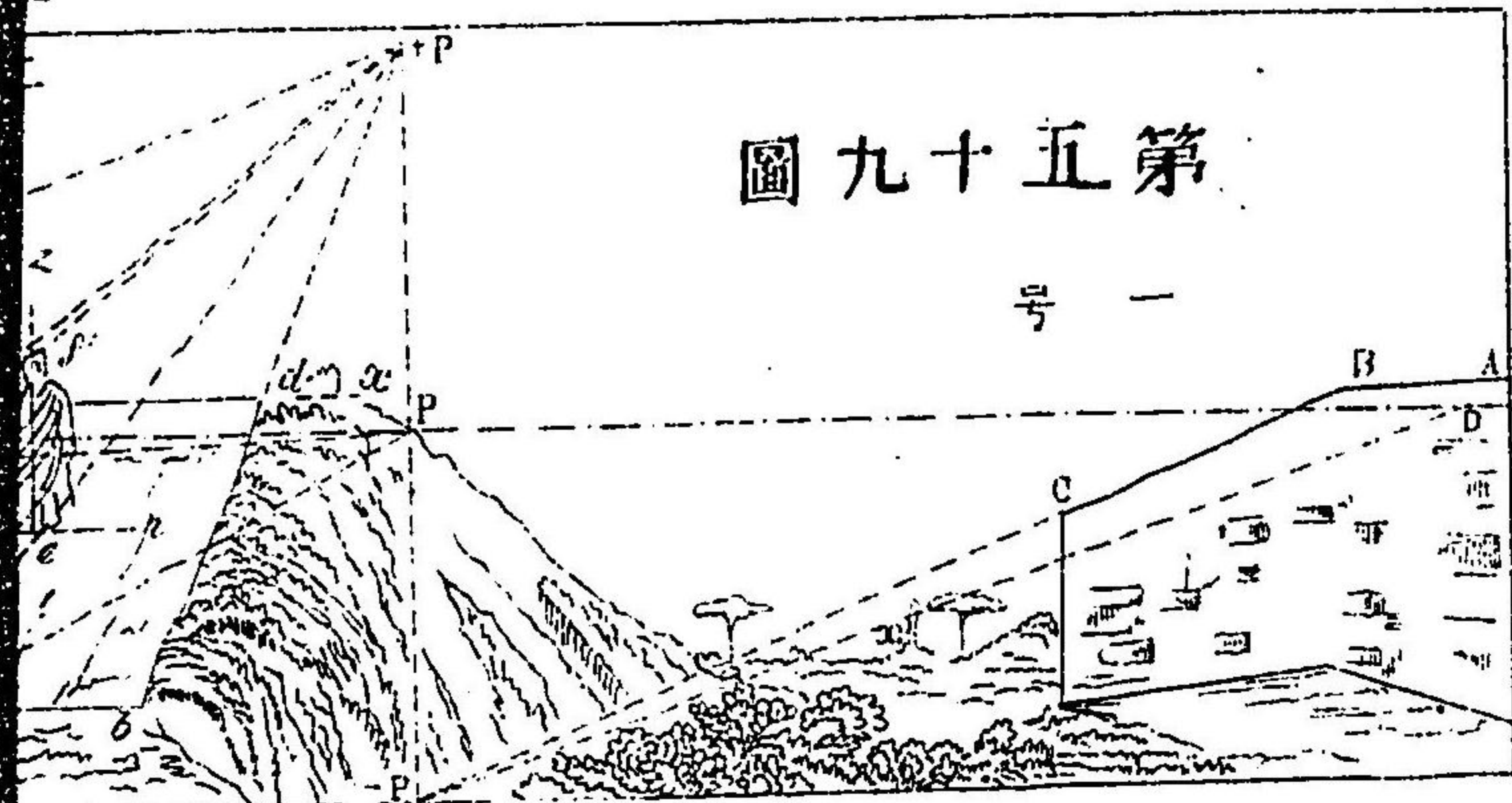

第五十九圖

一號

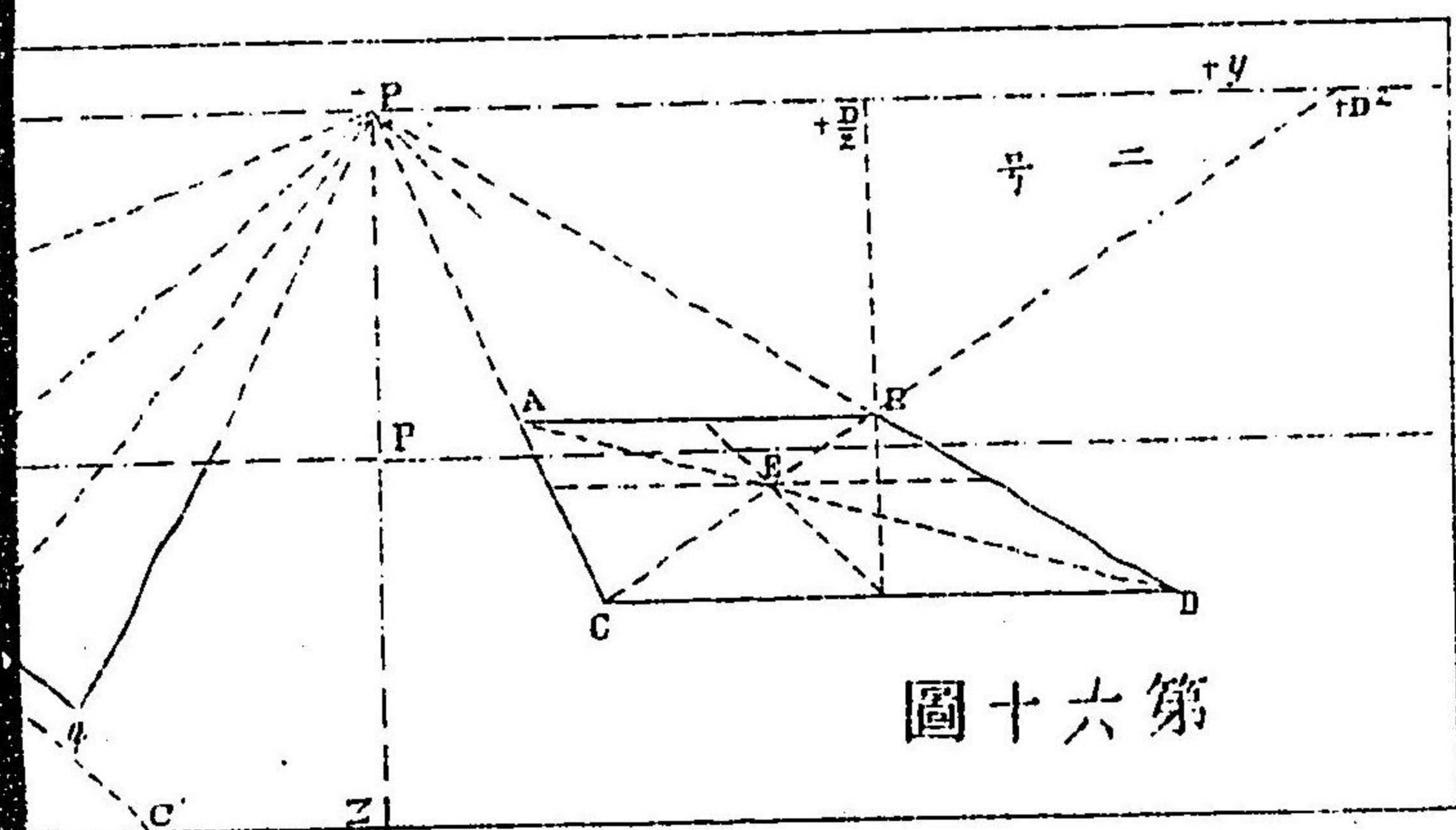

第六十圖

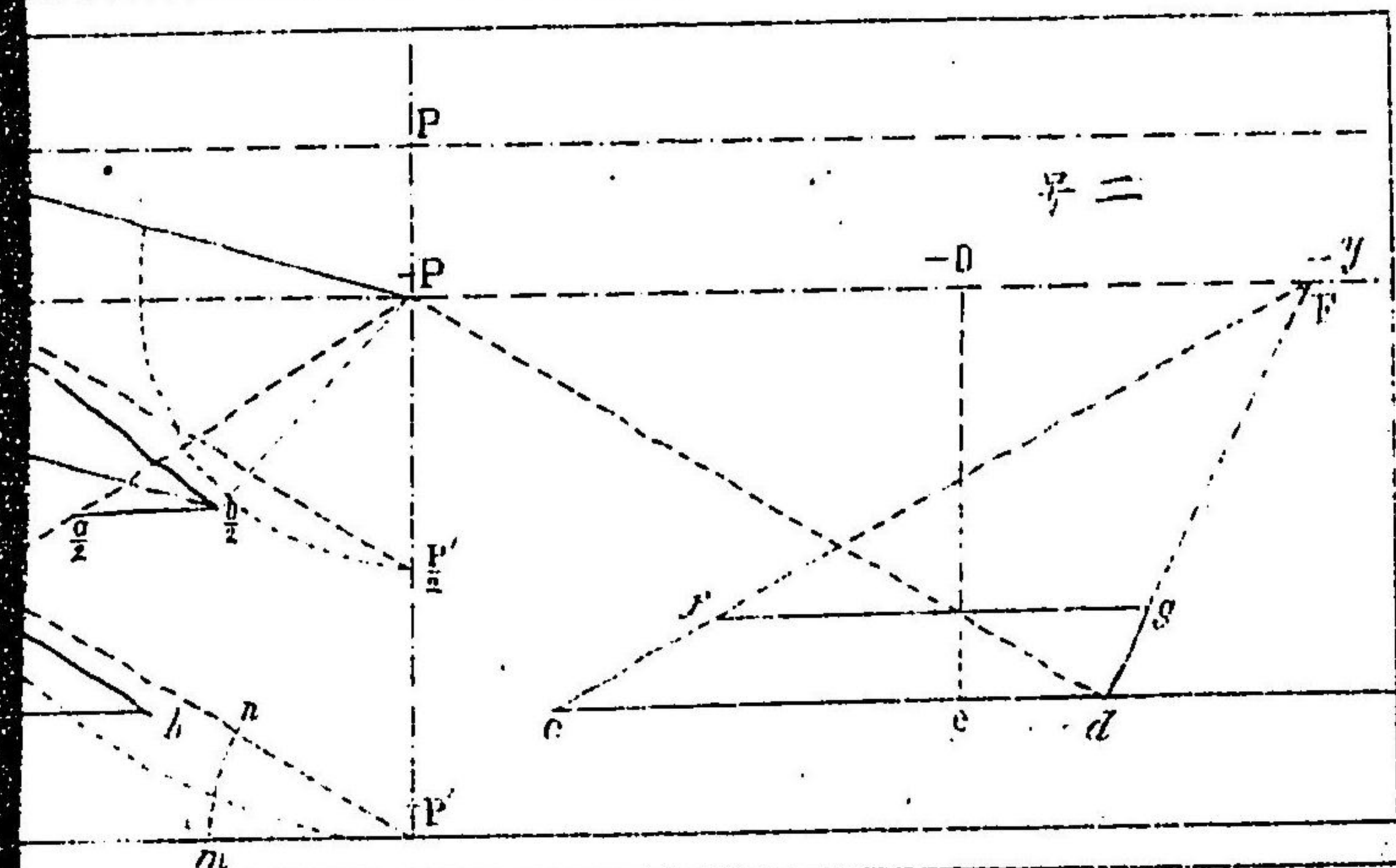

二號

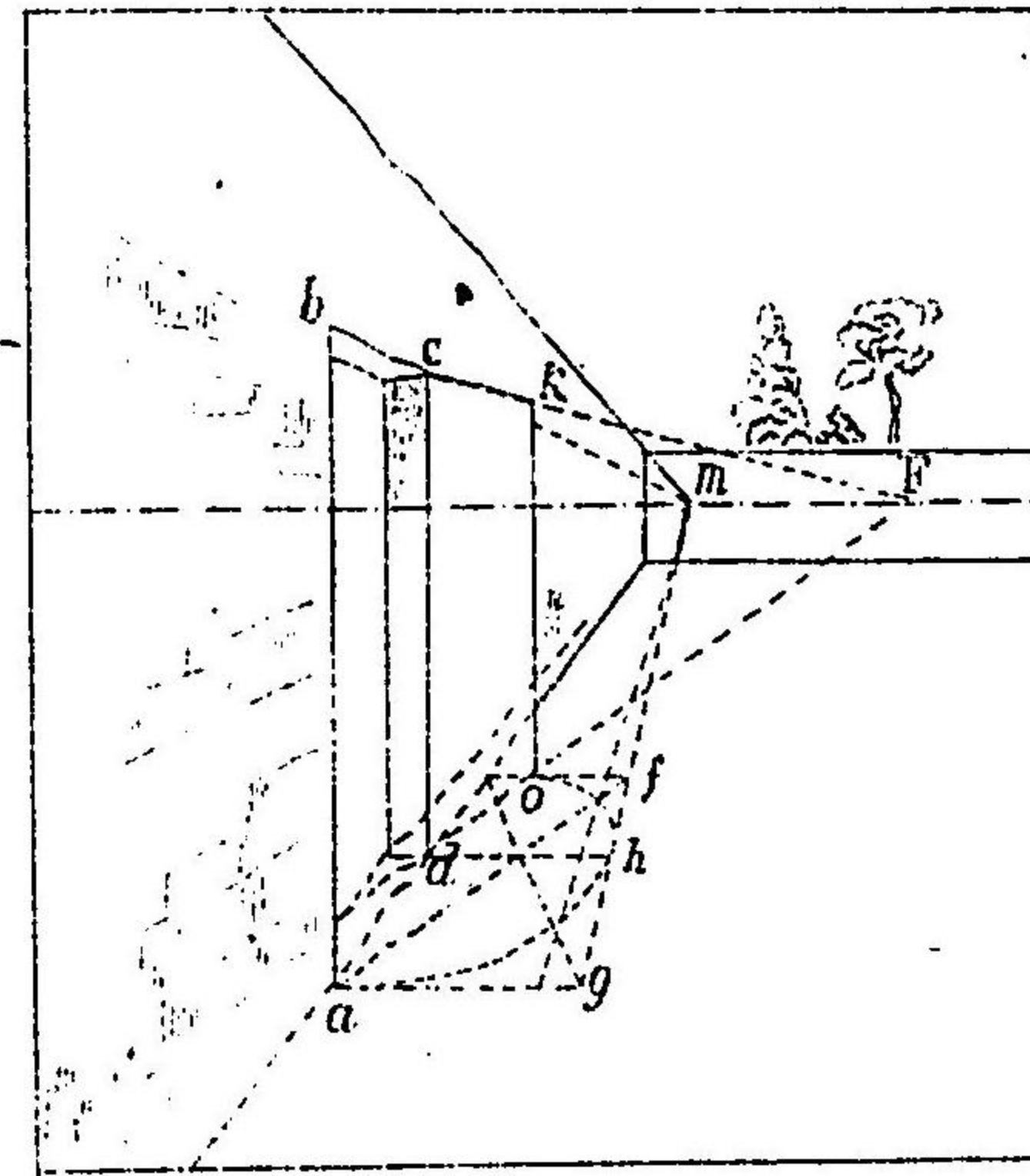

第五十七圖

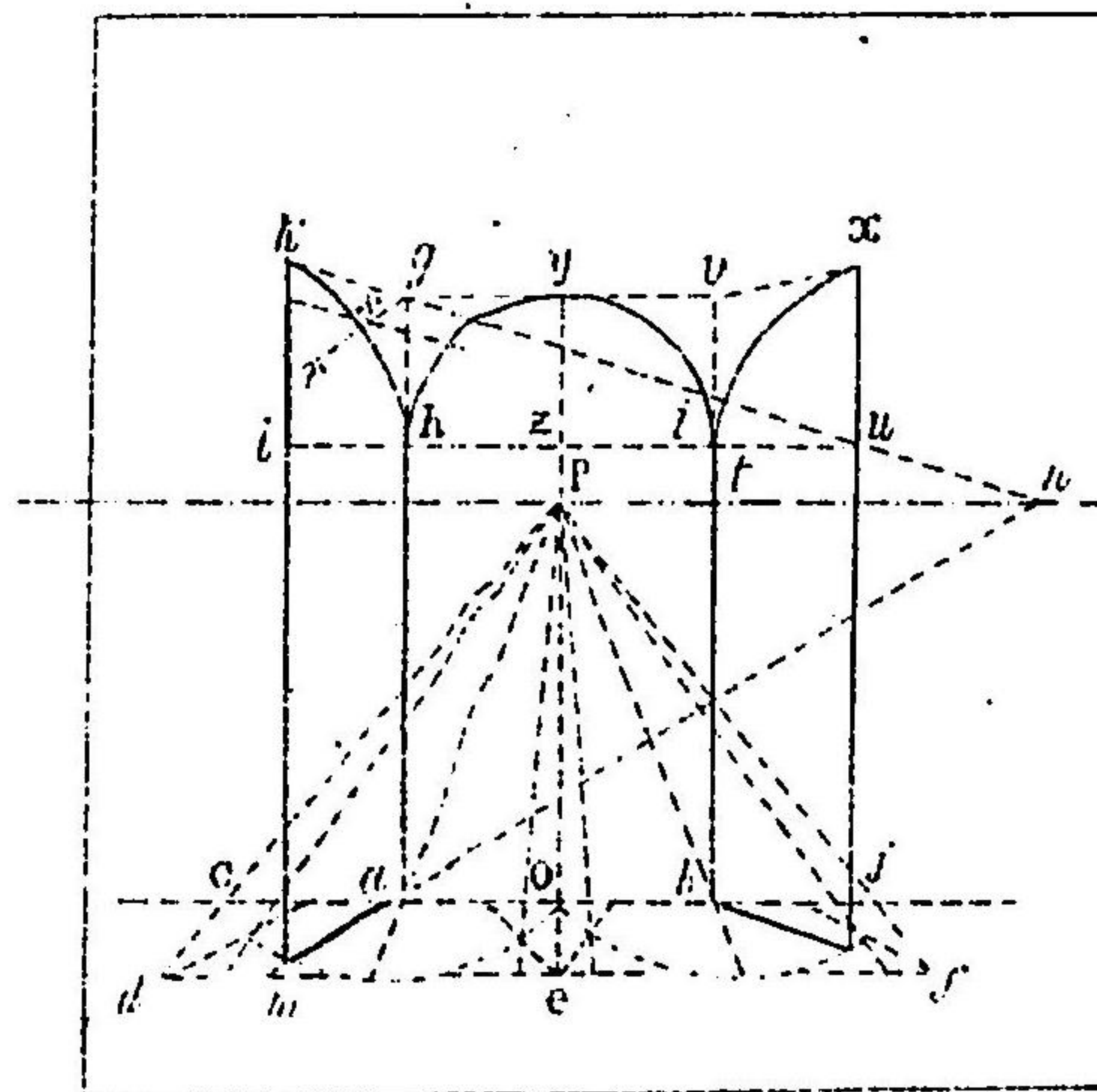

第五十八圖

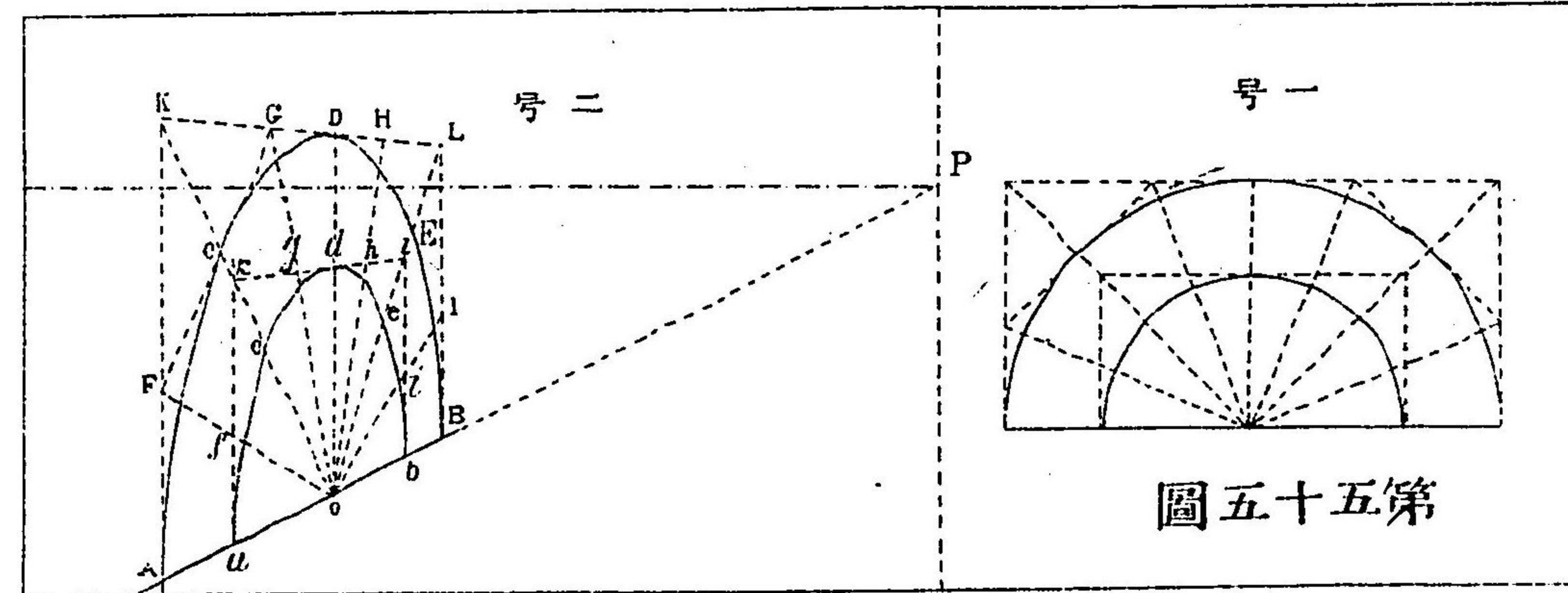

一號

第五十五圖

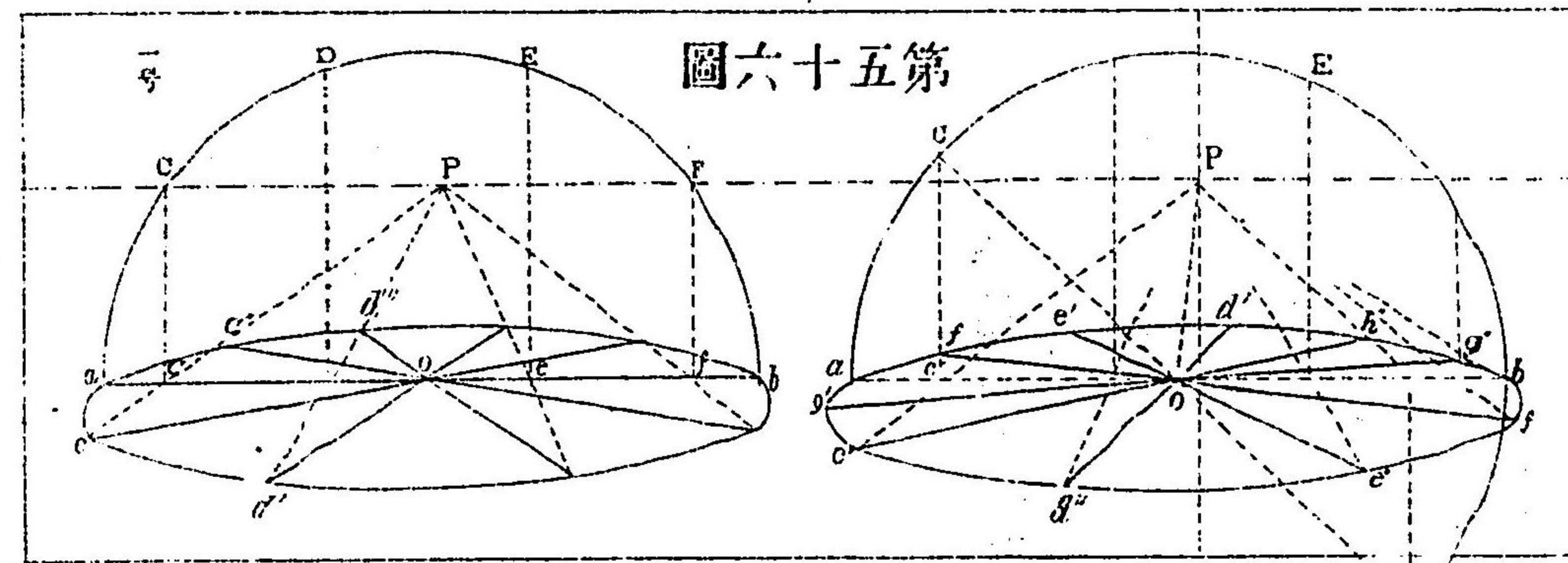

第六十五圖

一號

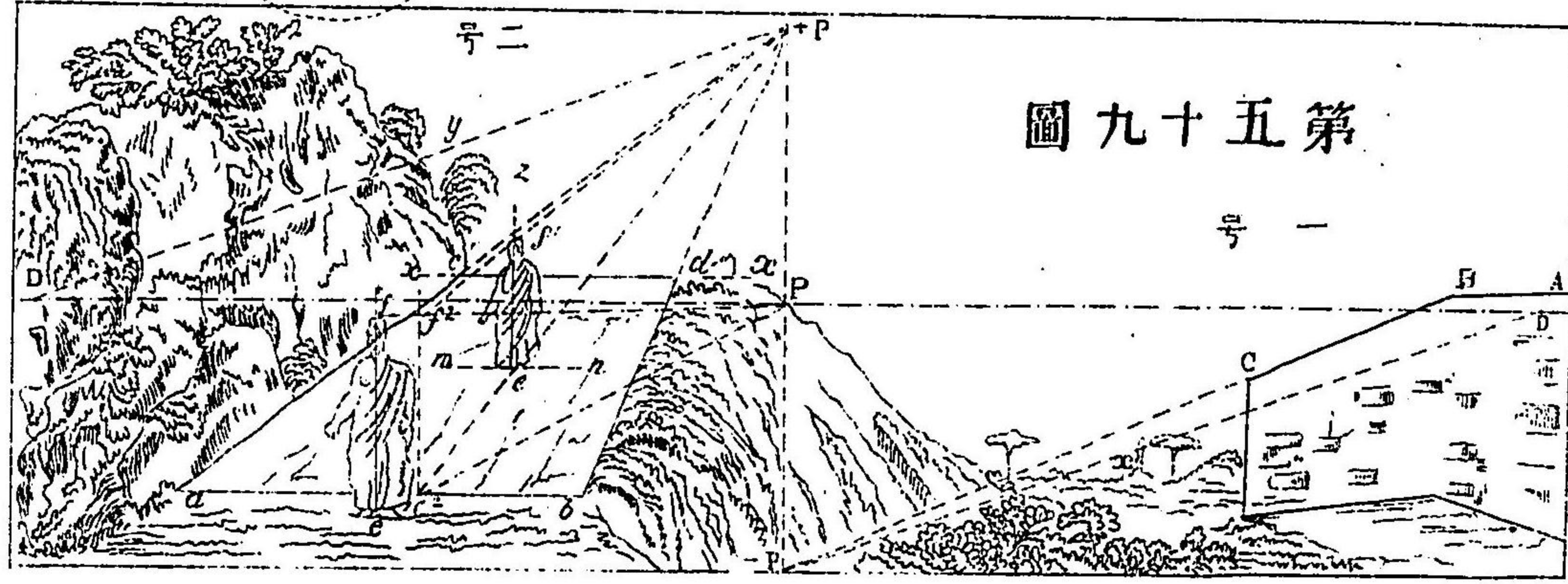

圖九十五第

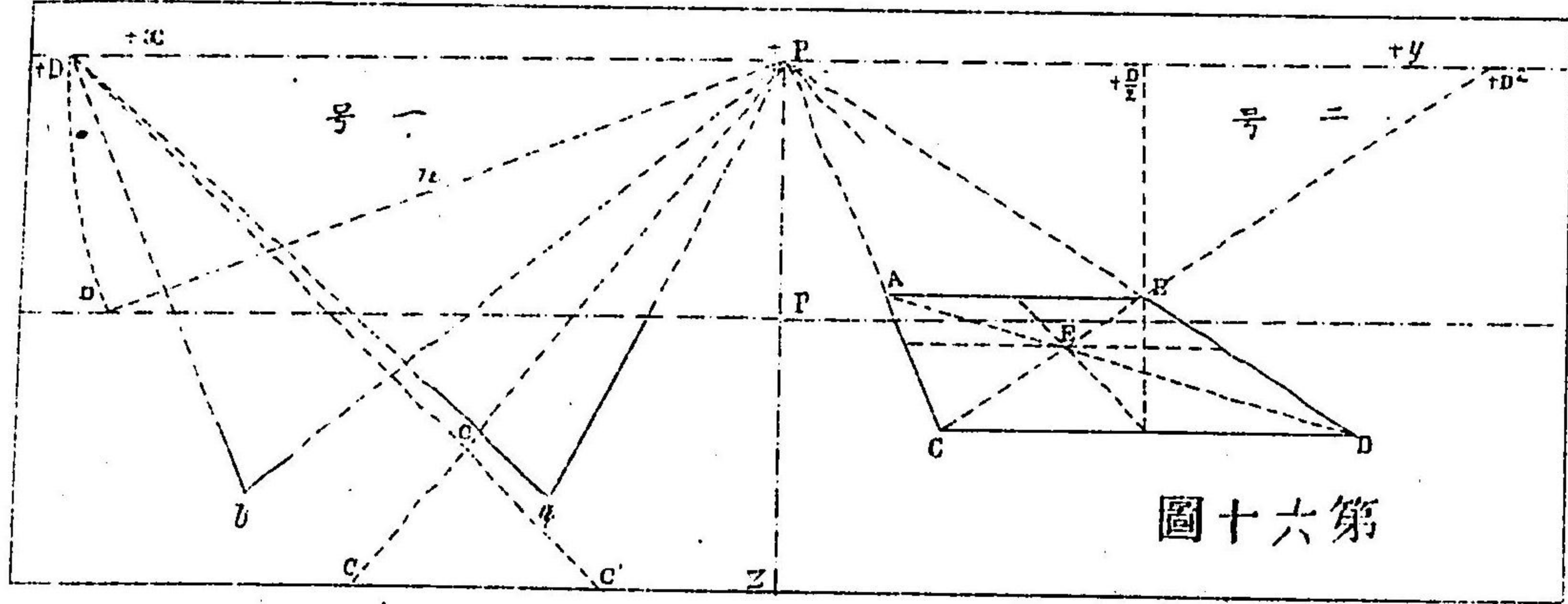

圖十六第

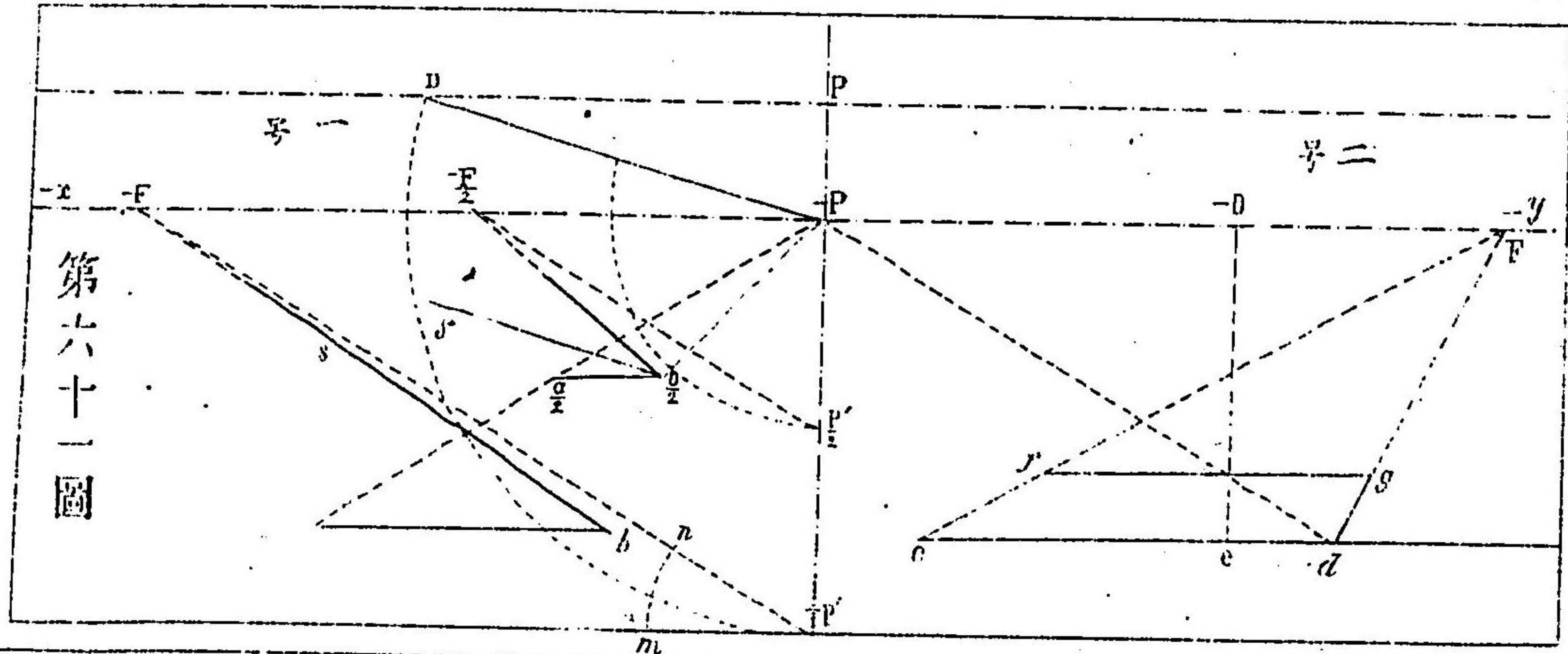

第六十一圖

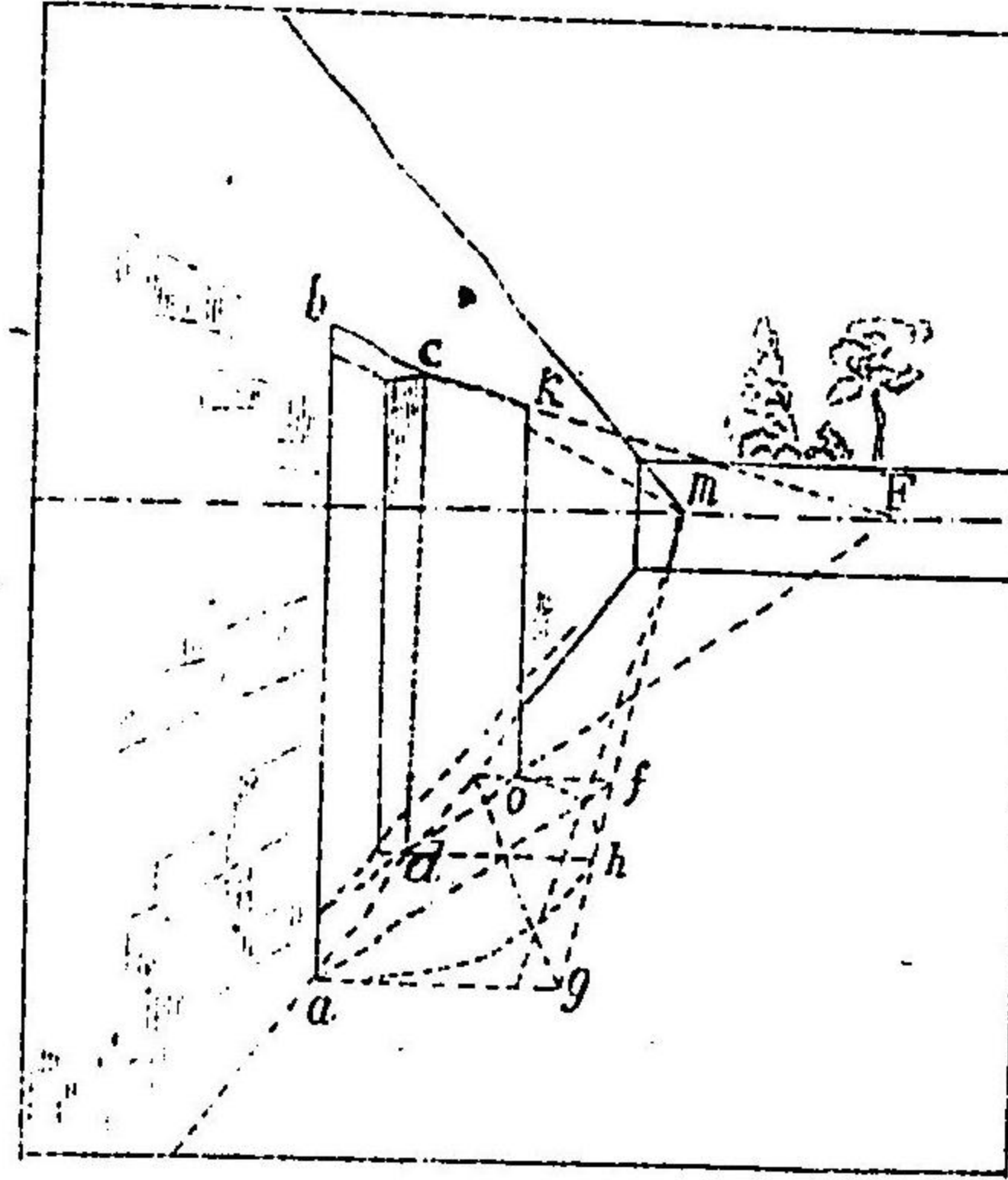

第五十七圖

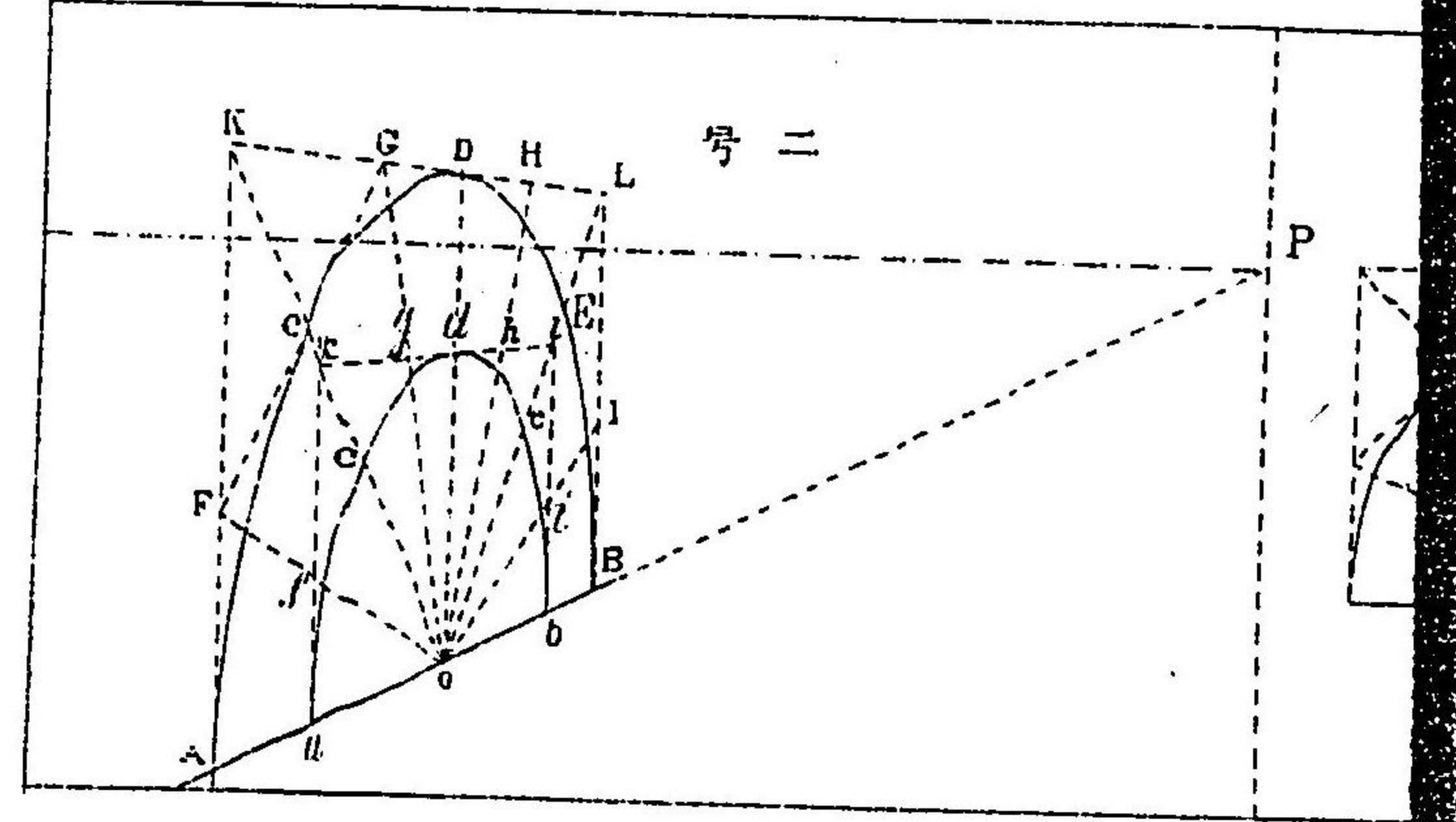

第五十八圖

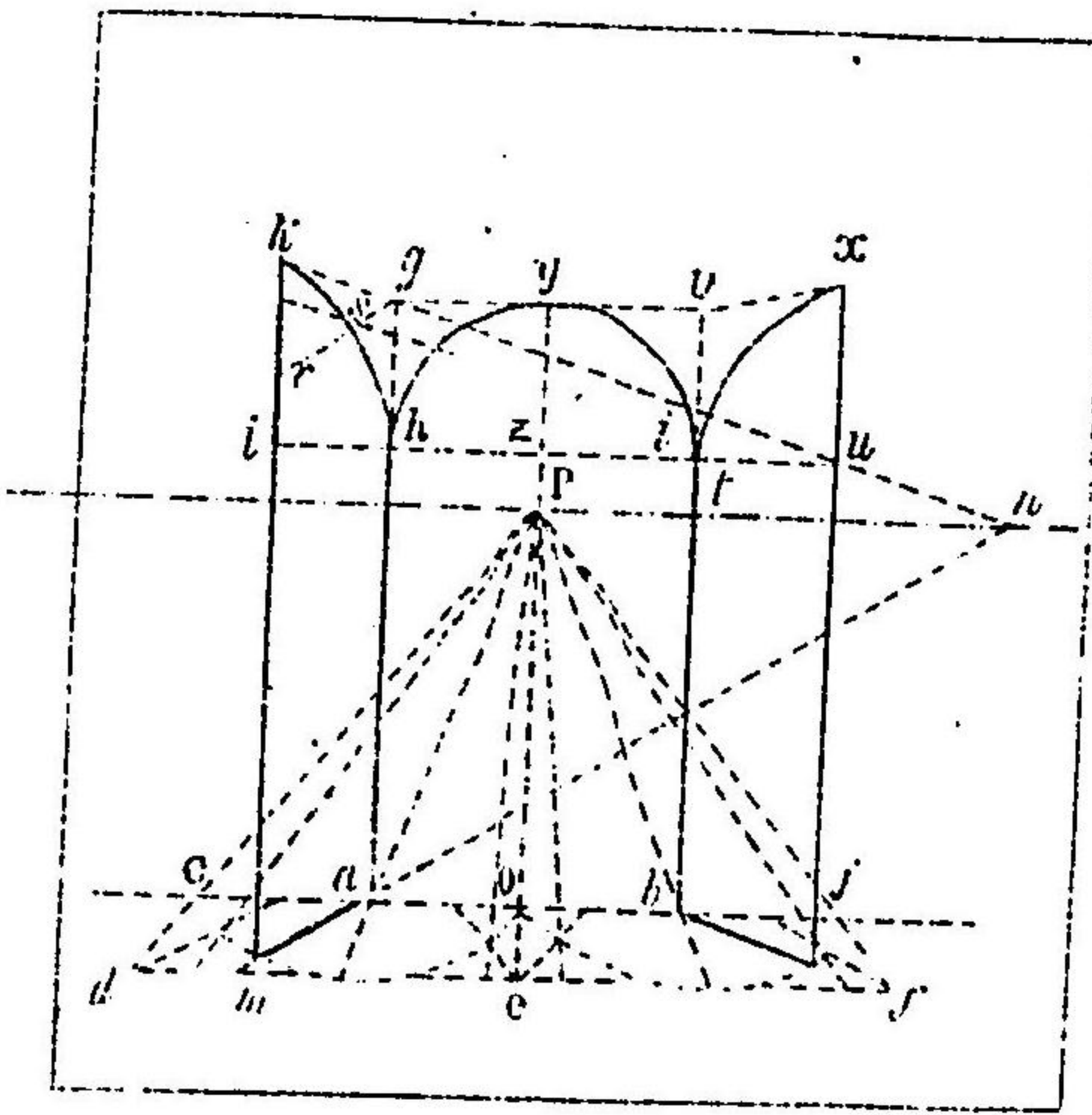

圖六十五第

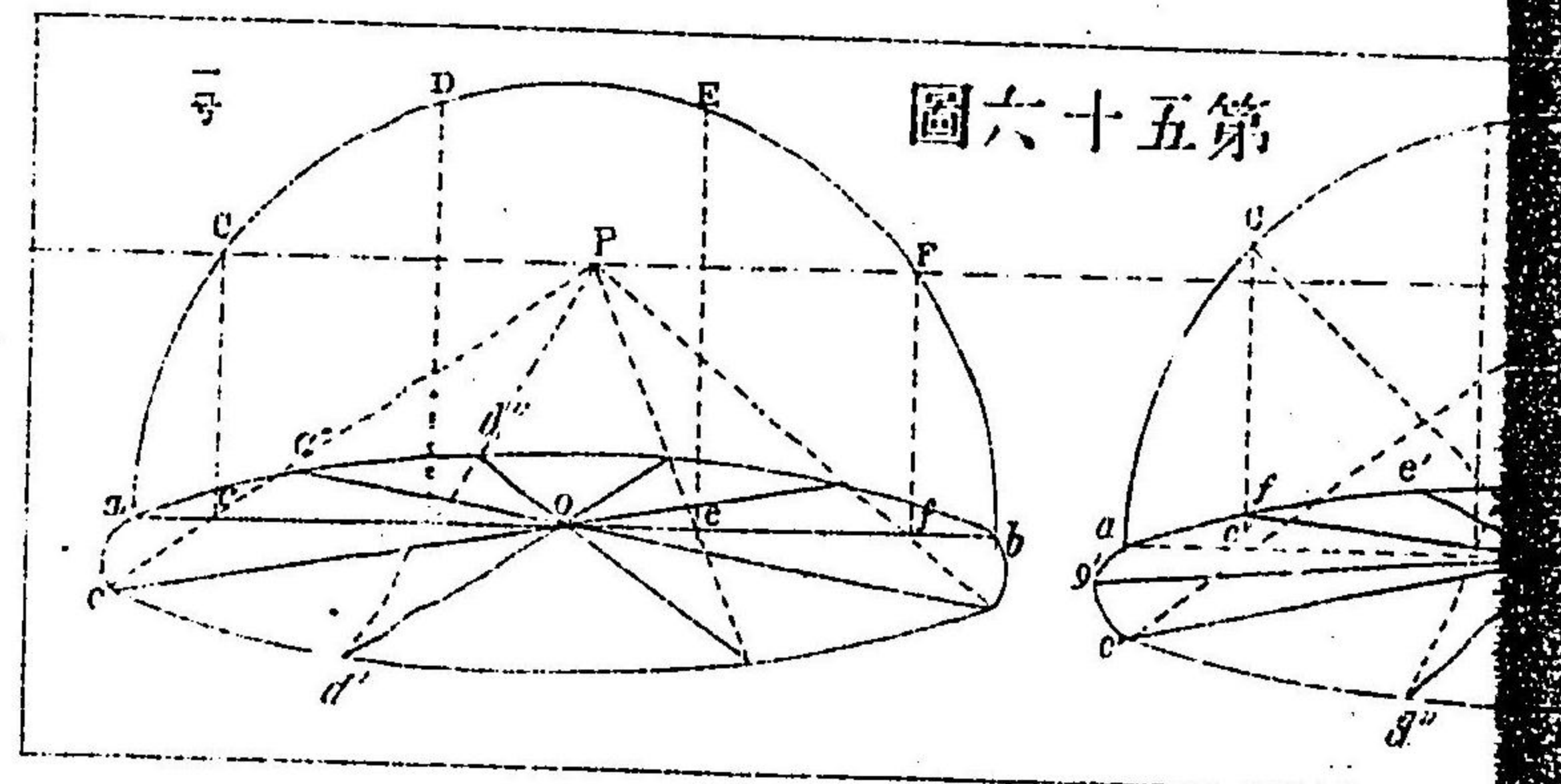

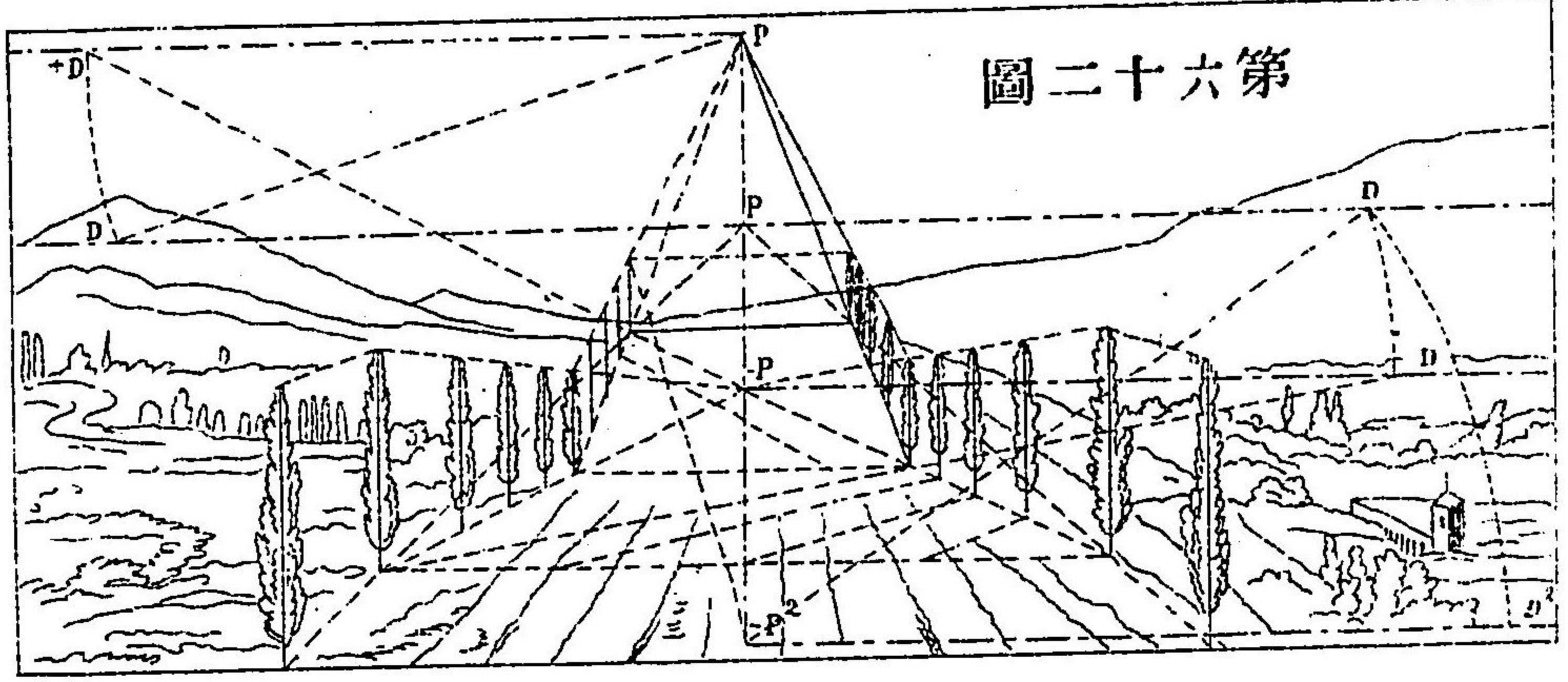

第六十二圖

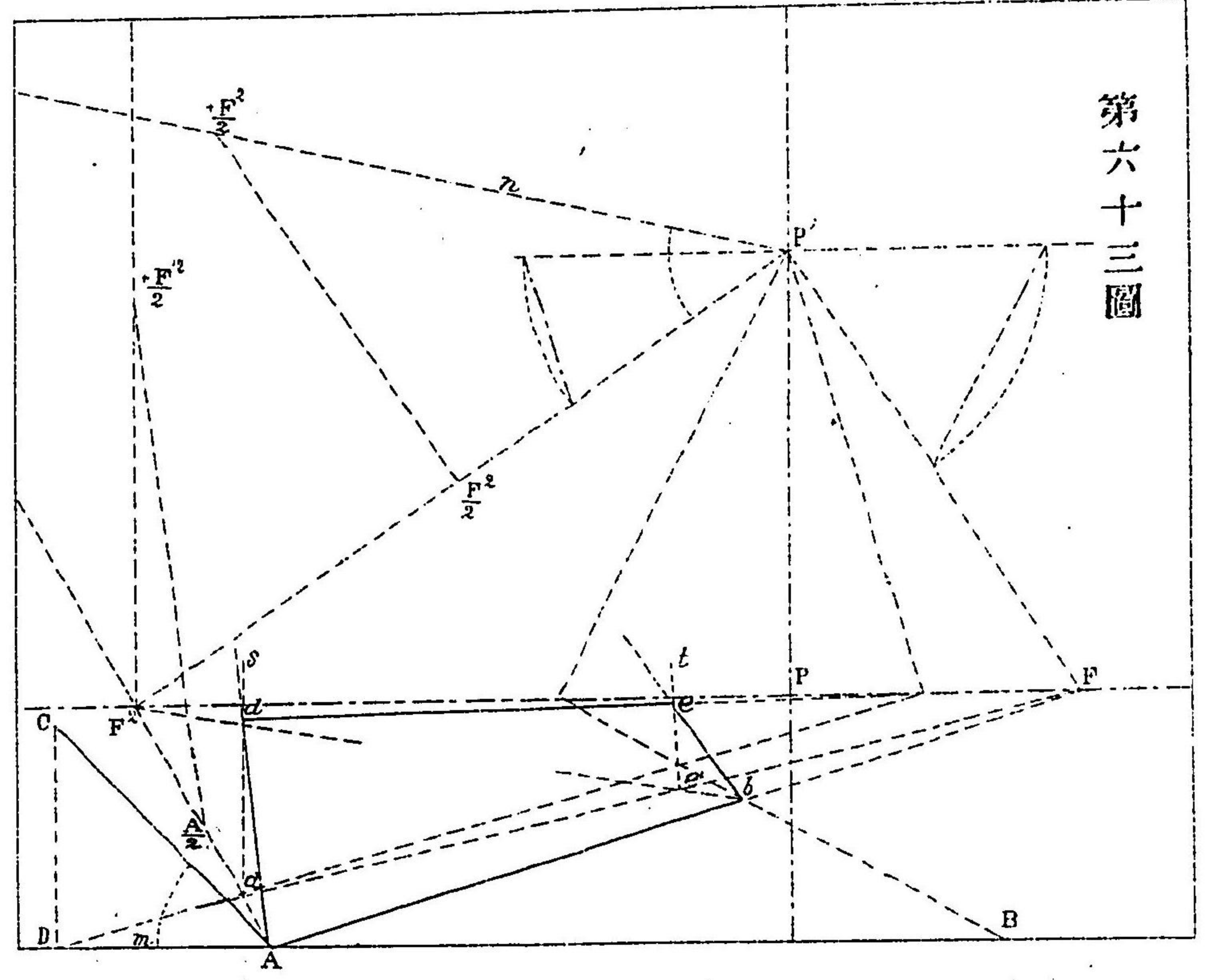

第六十三圖

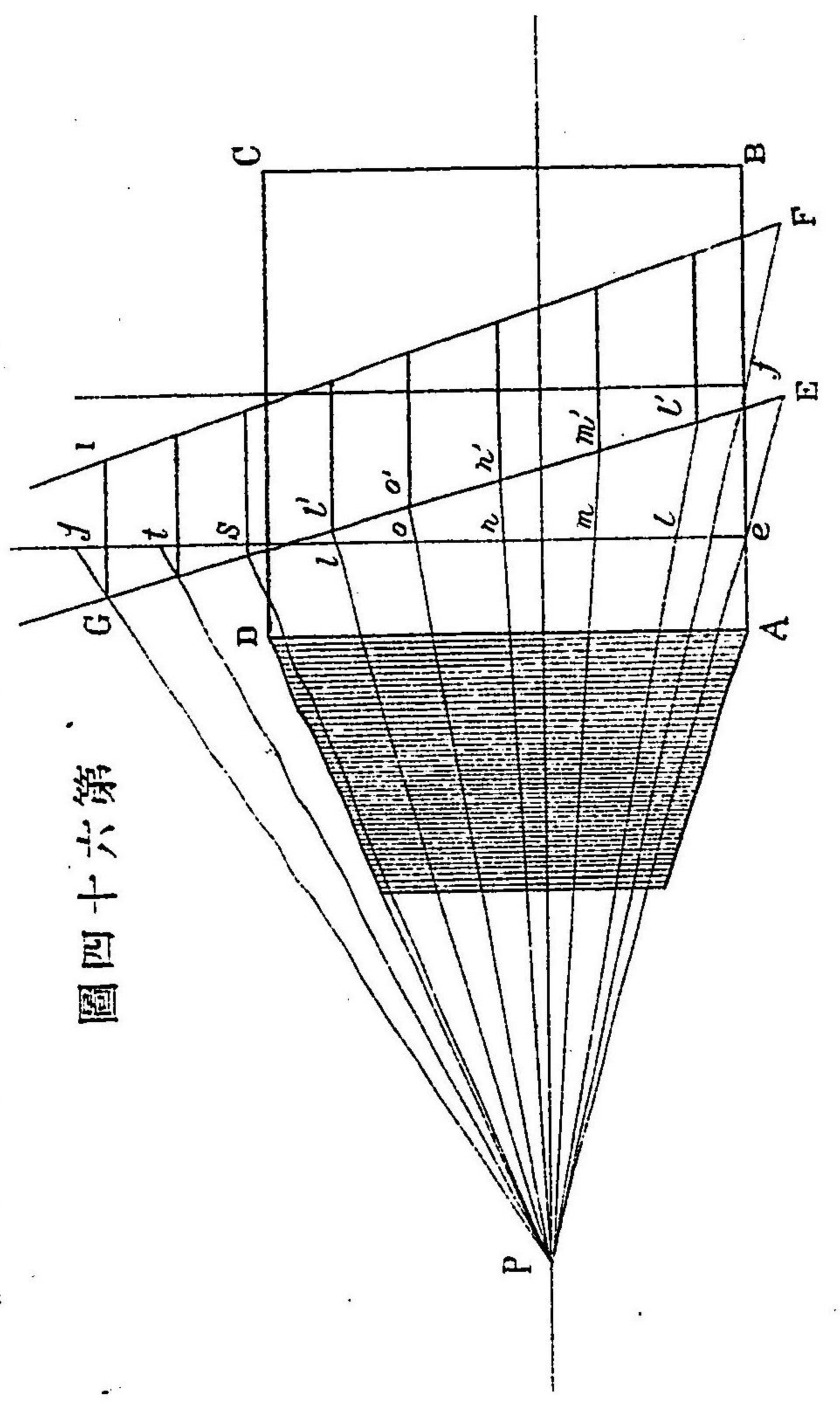

第六十四圖

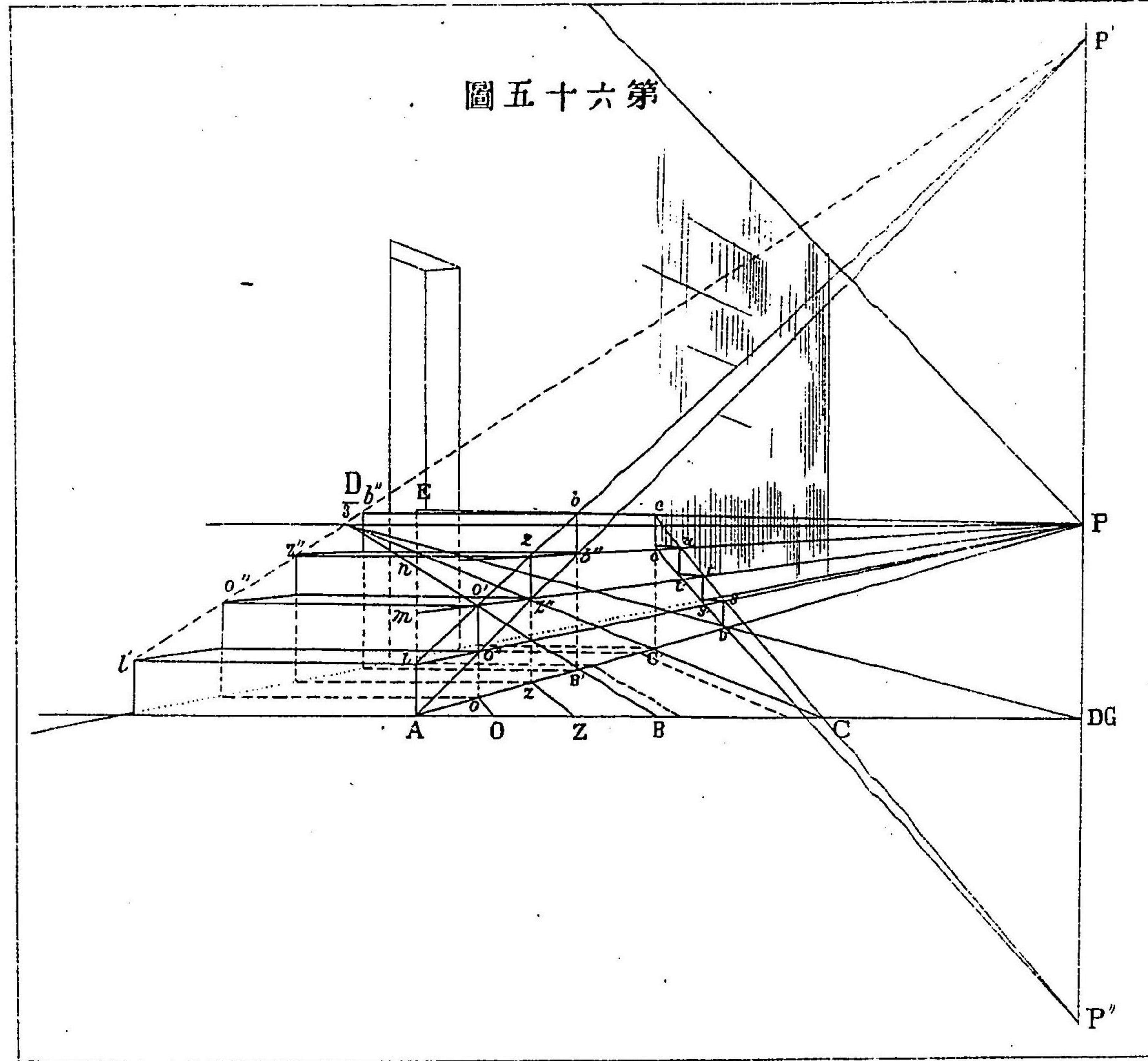

第五十六圖

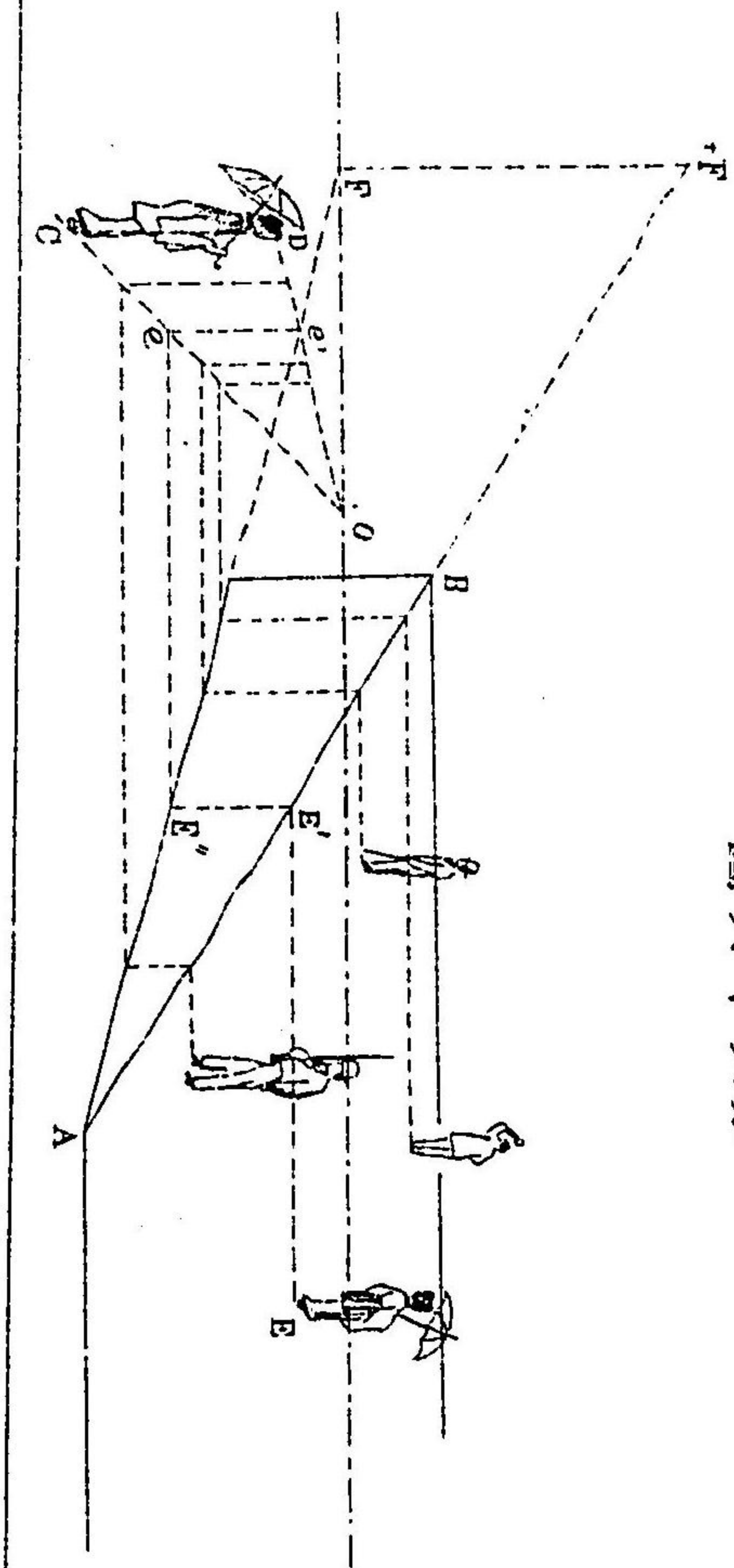

第六十六圖

圖七十六第

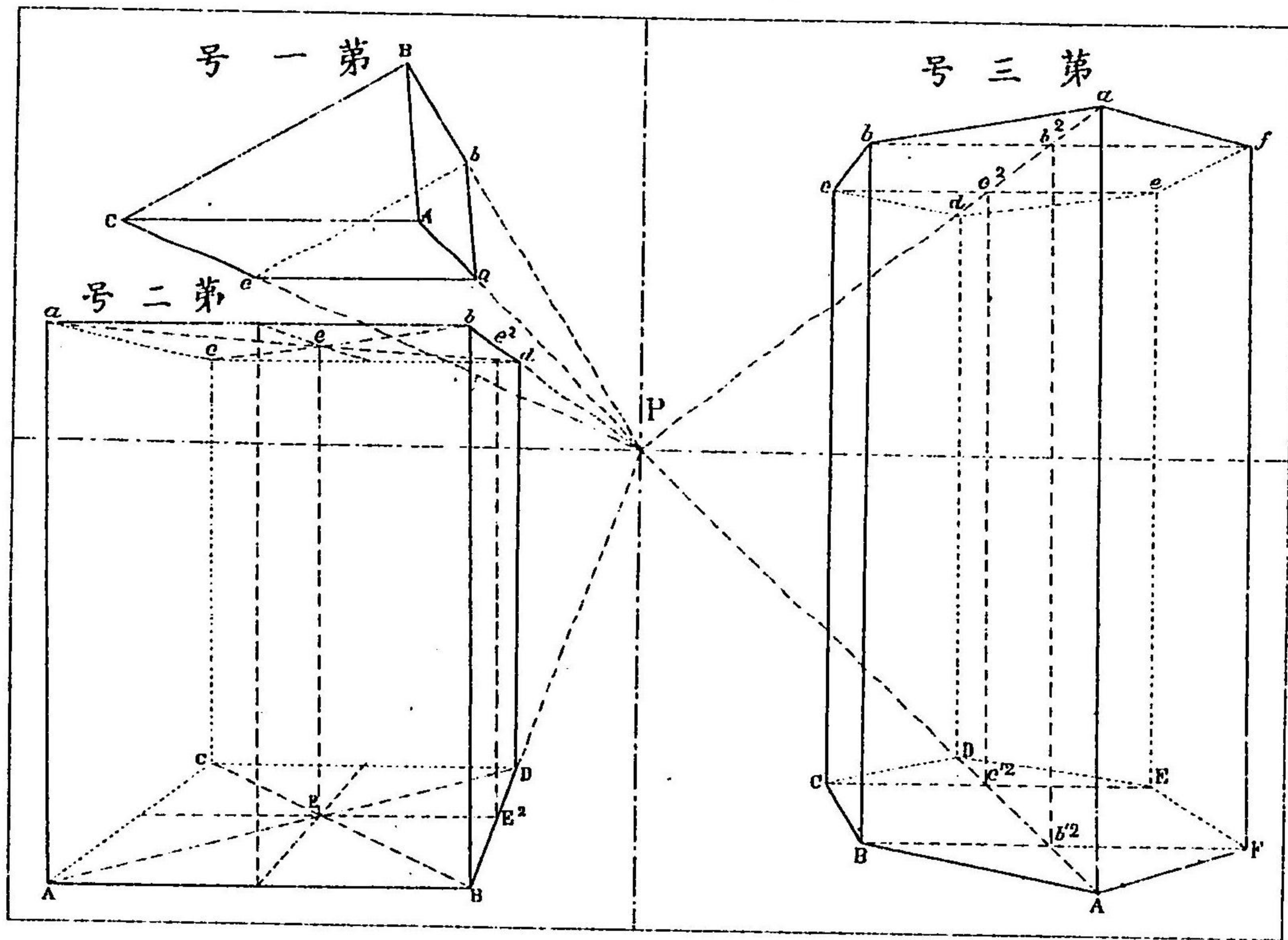

圖八十六第

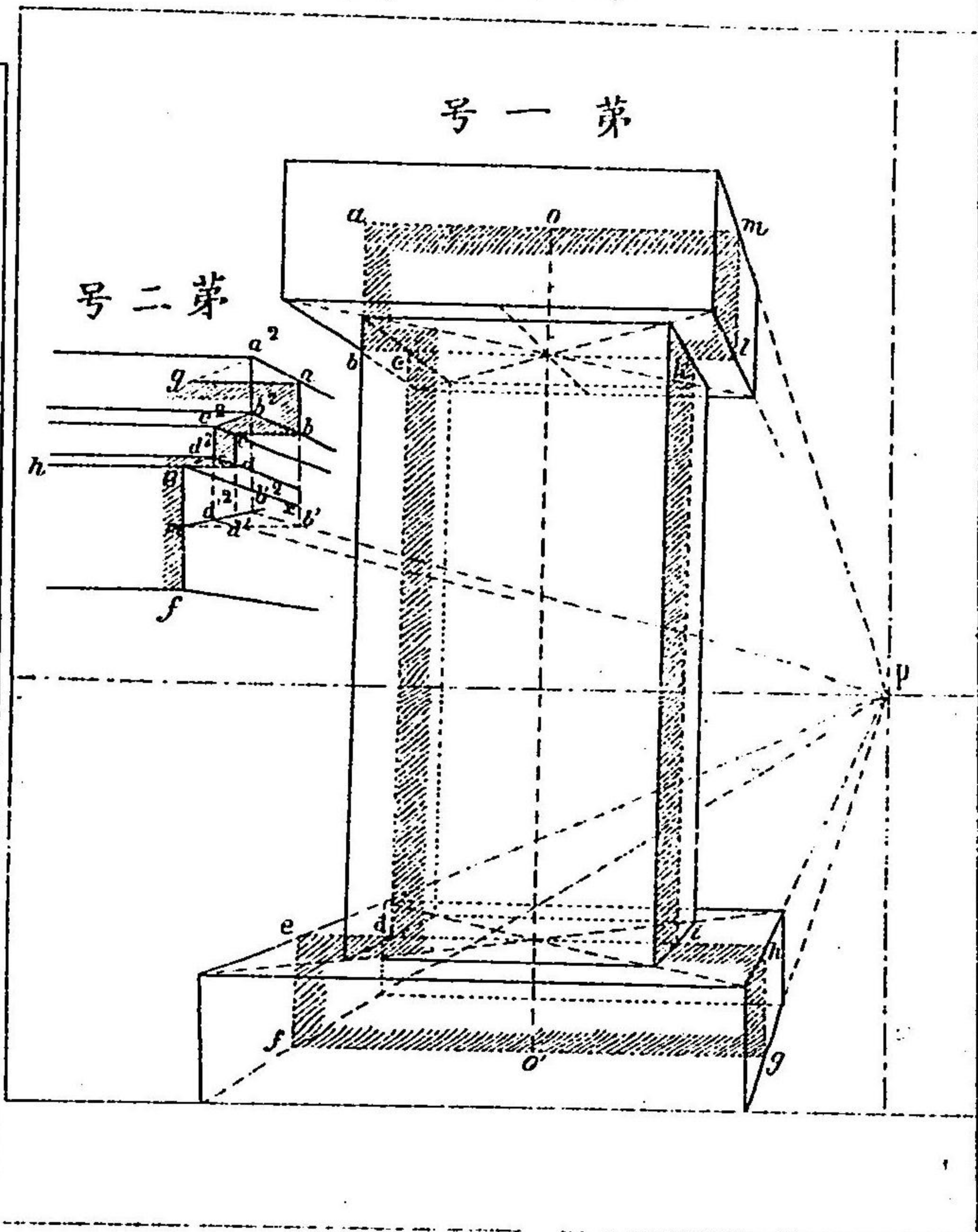

第六十九圖

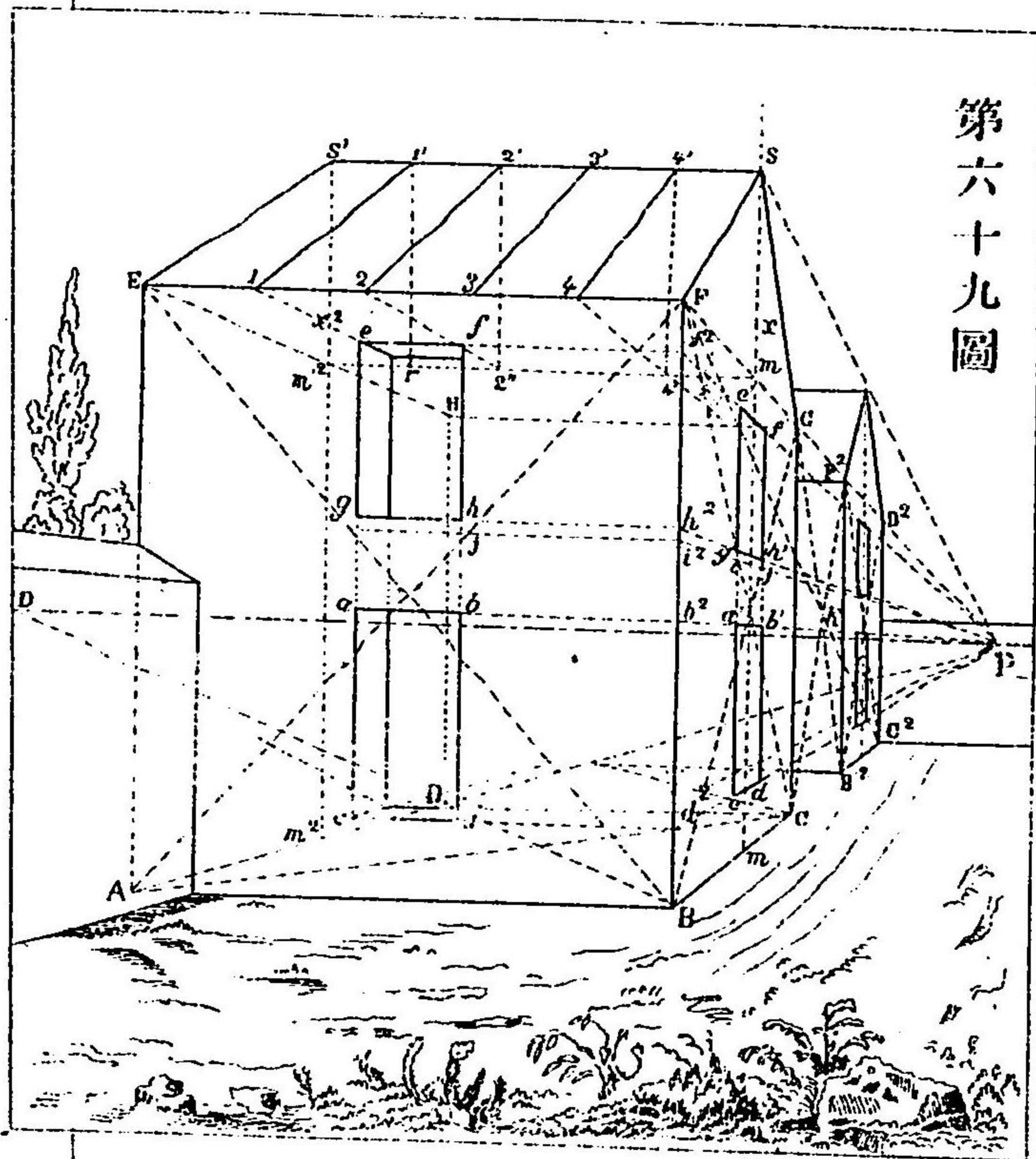

圖二十七第

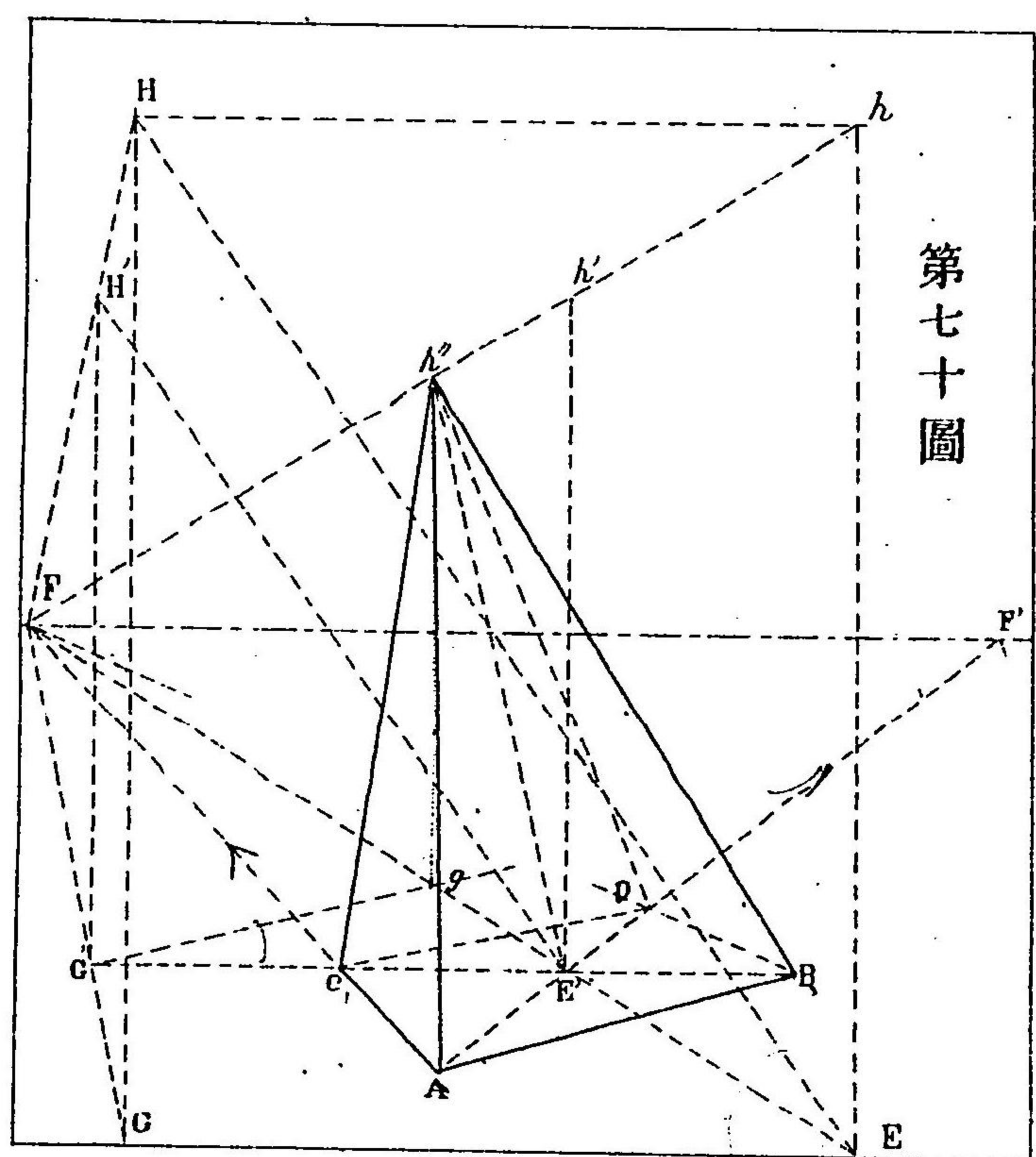
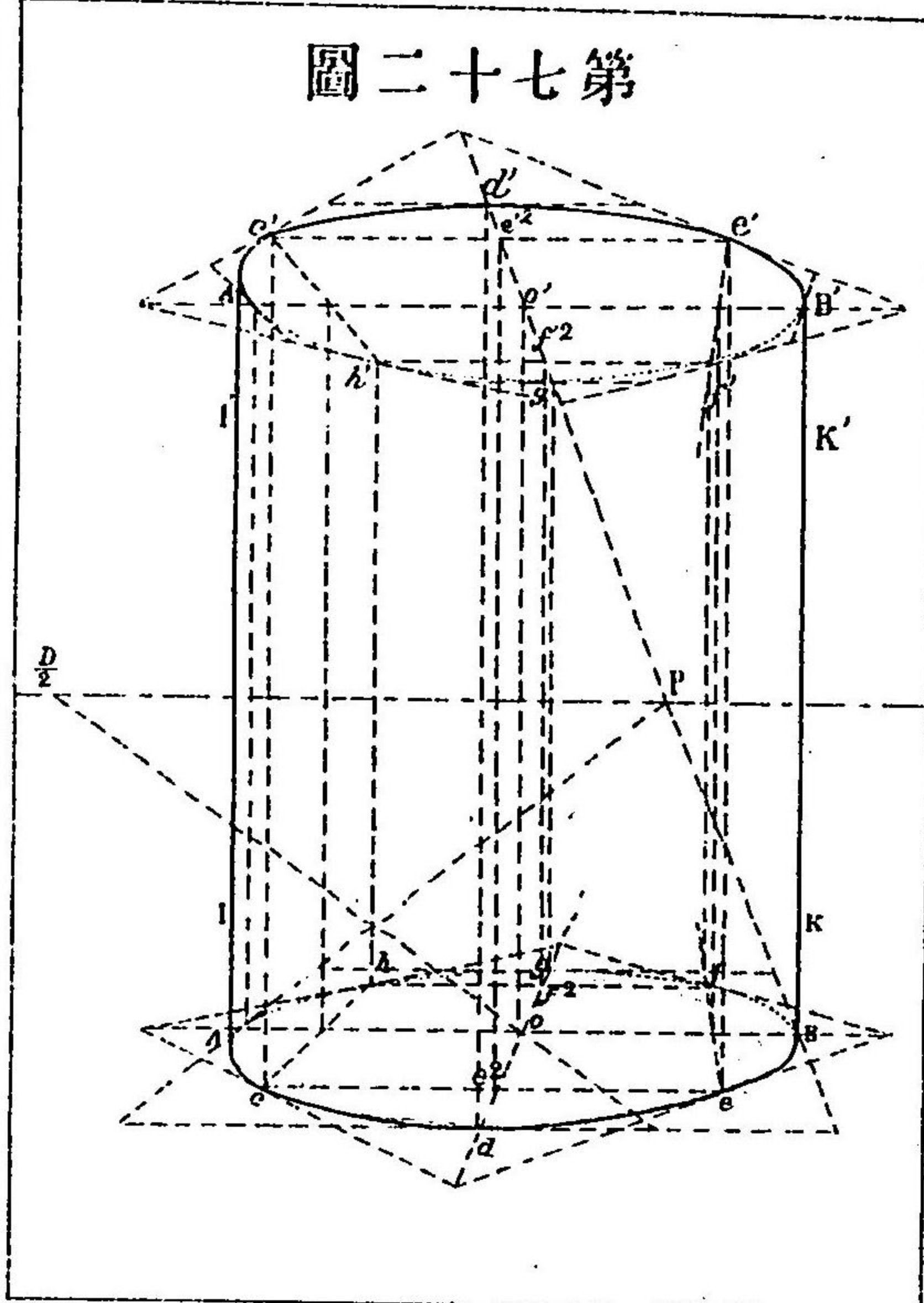

第七十圖

第七十三圖

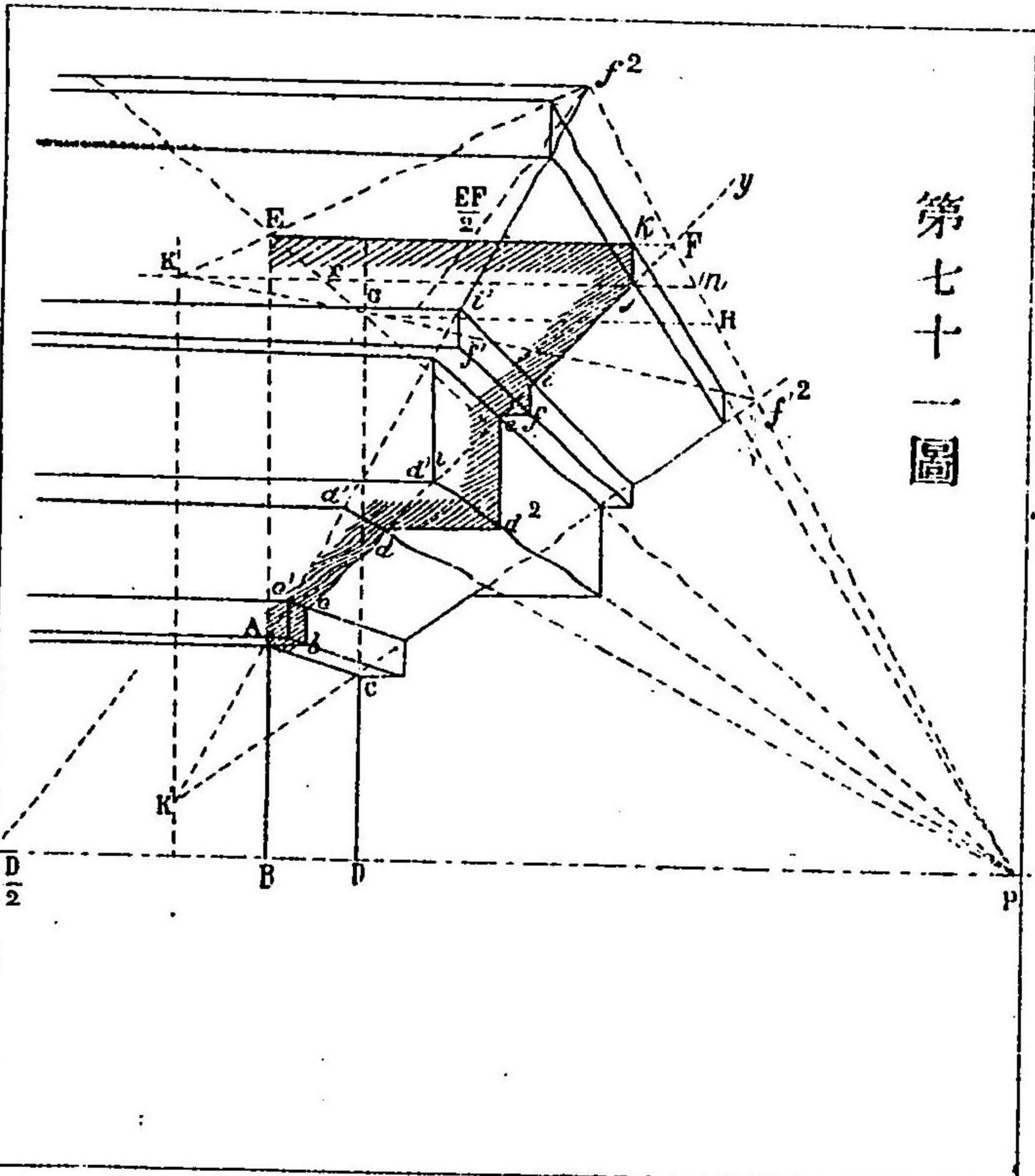
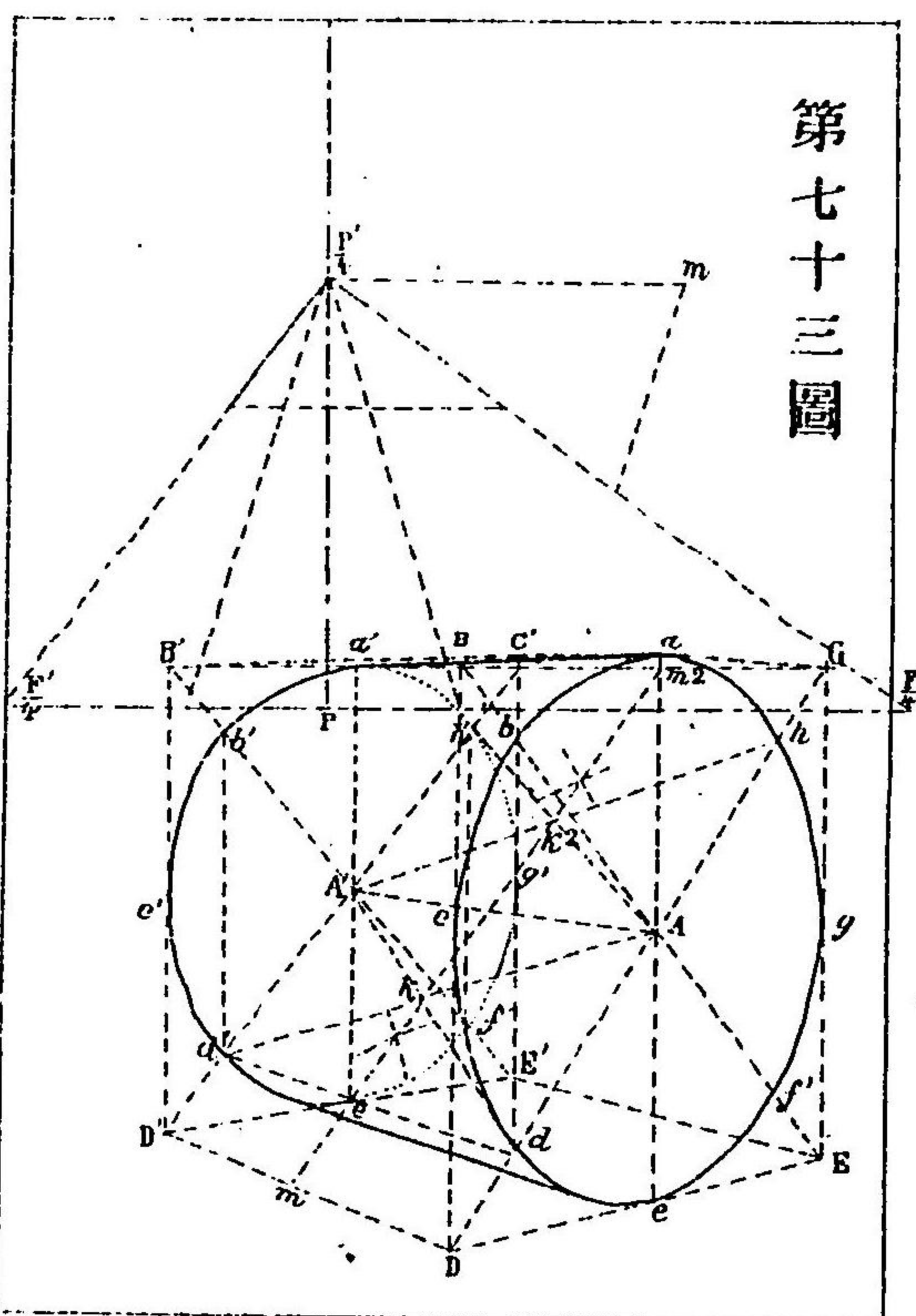

第七十一圖

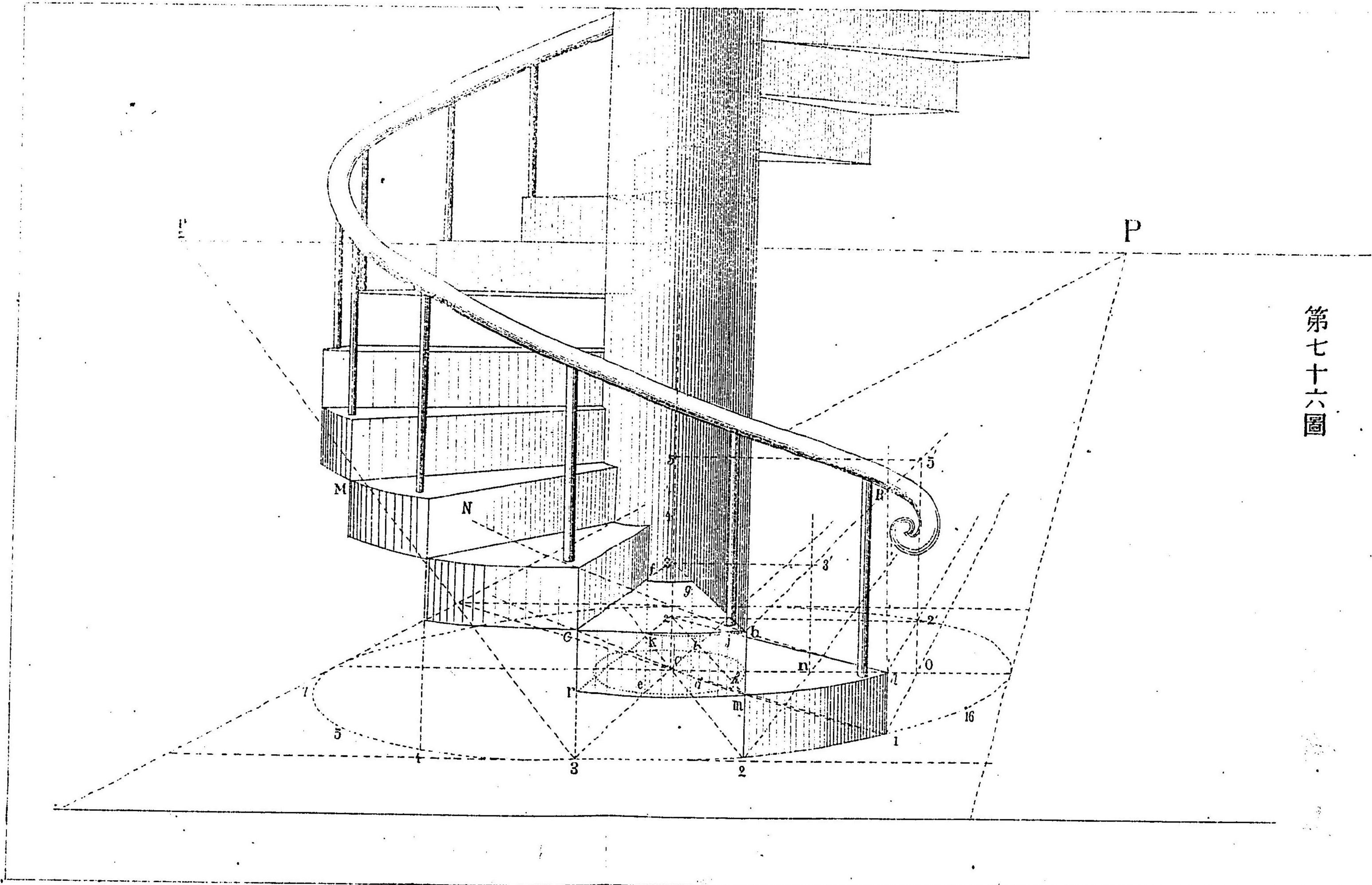

第七十六圖

第七十四圖

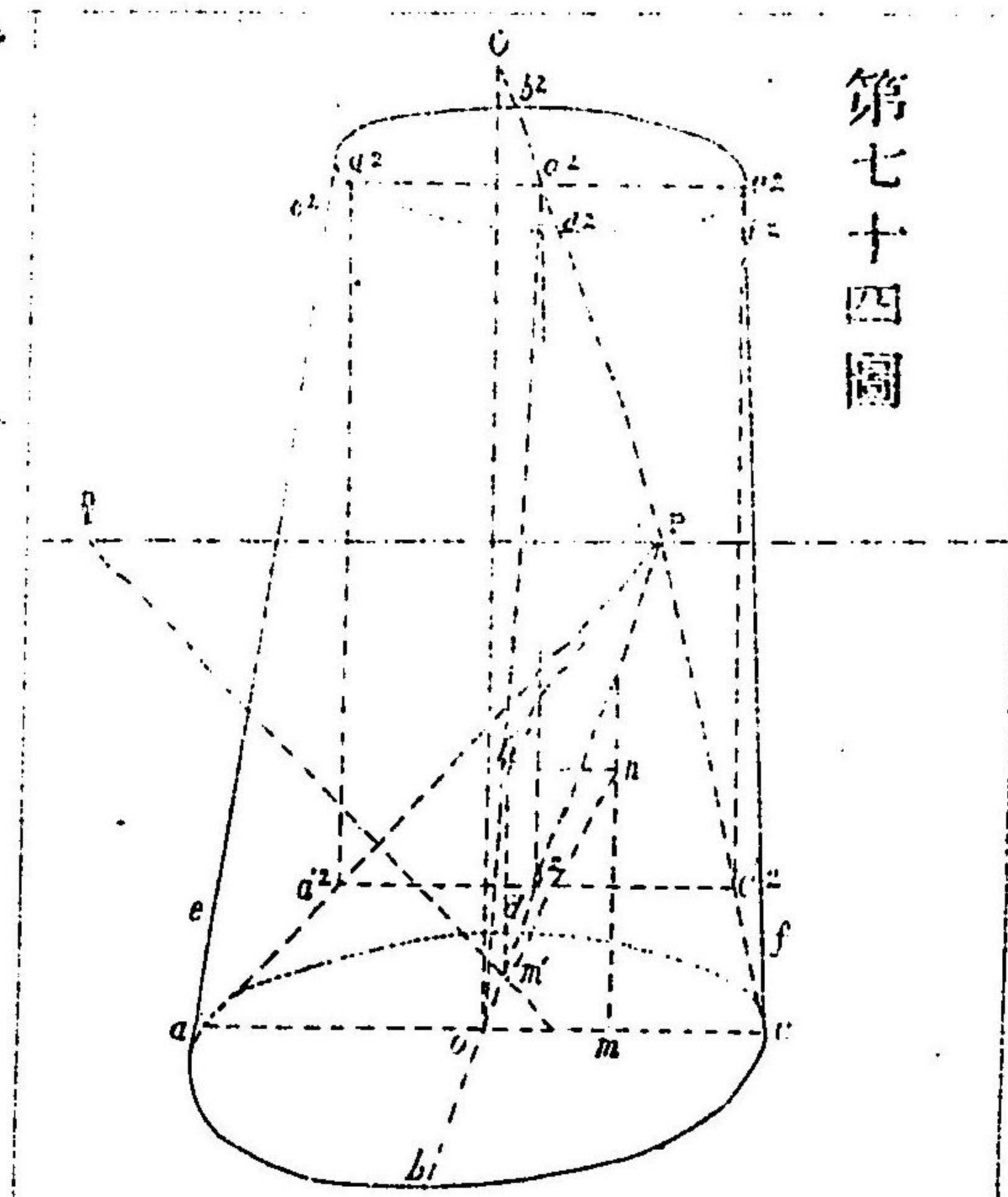

第七十五圖

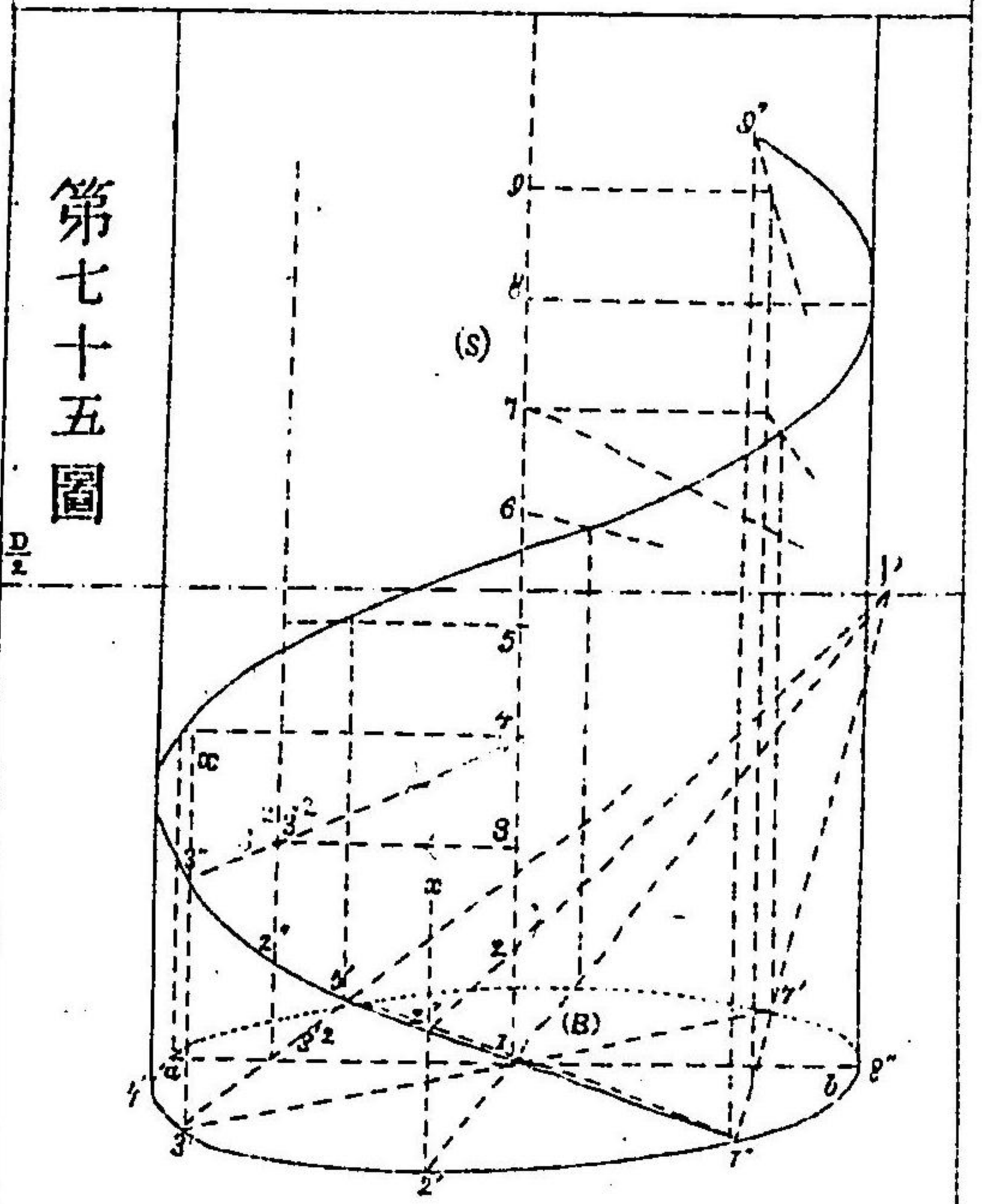

圖八十七第

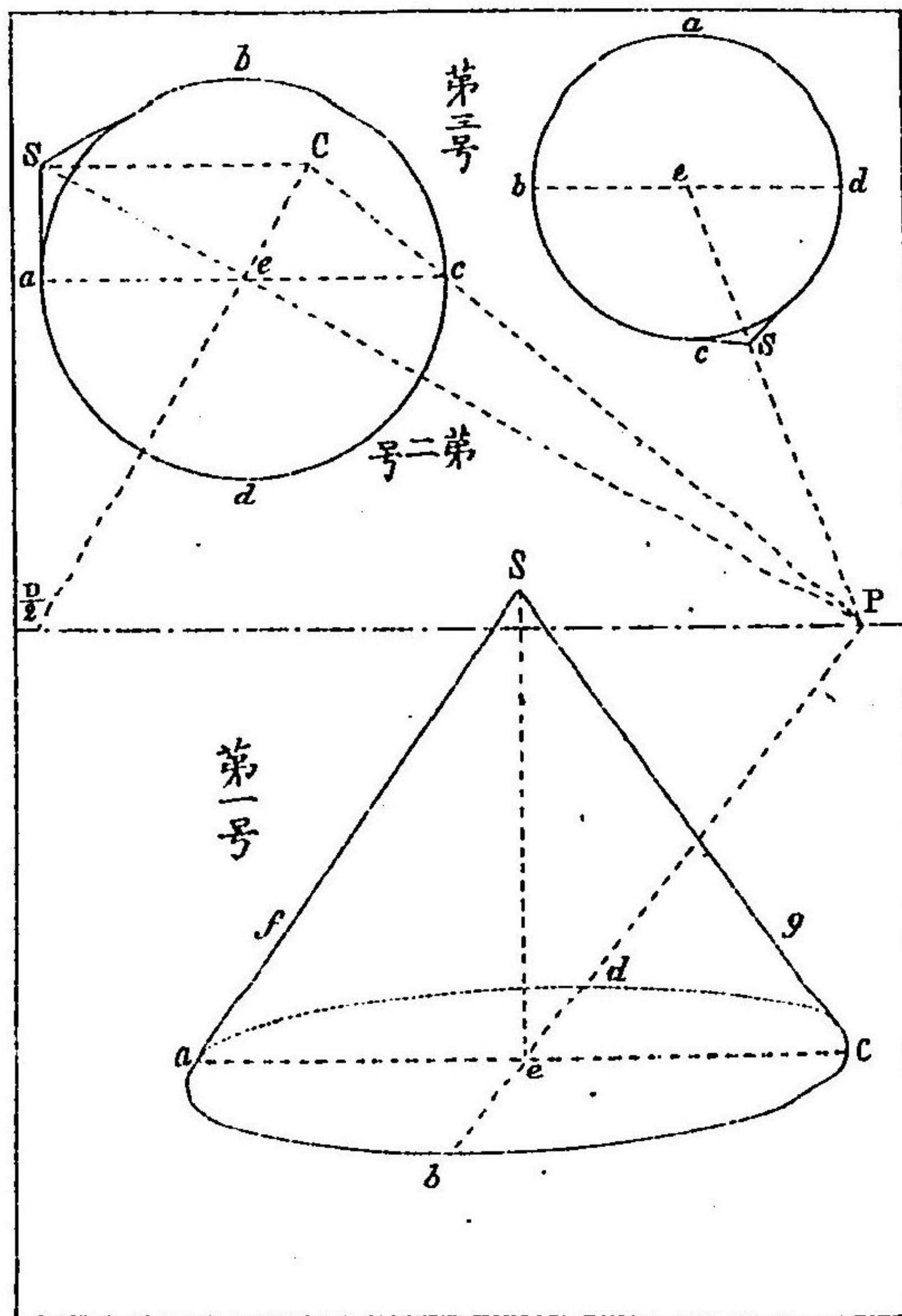

圖七十七第

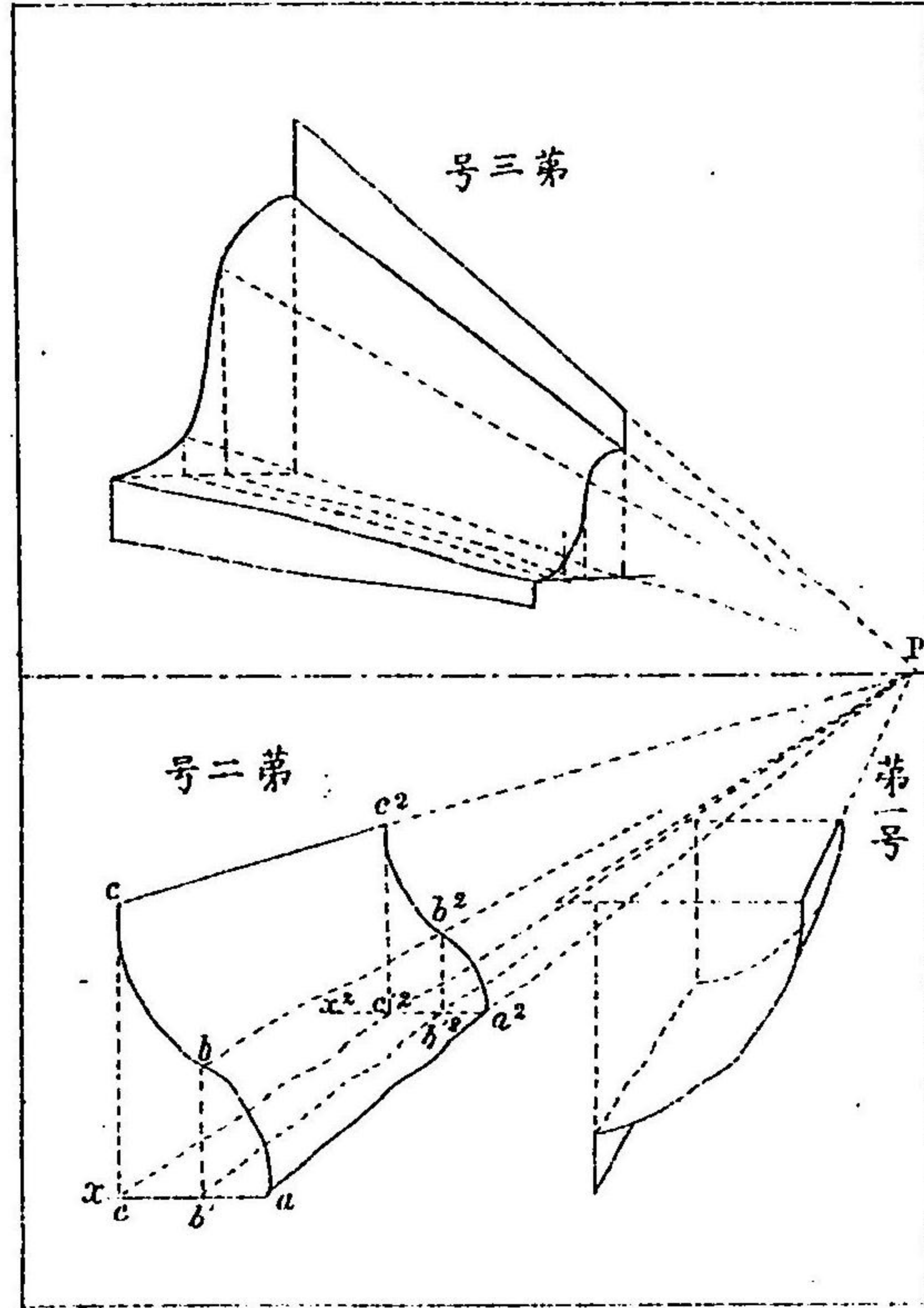

圖十八第

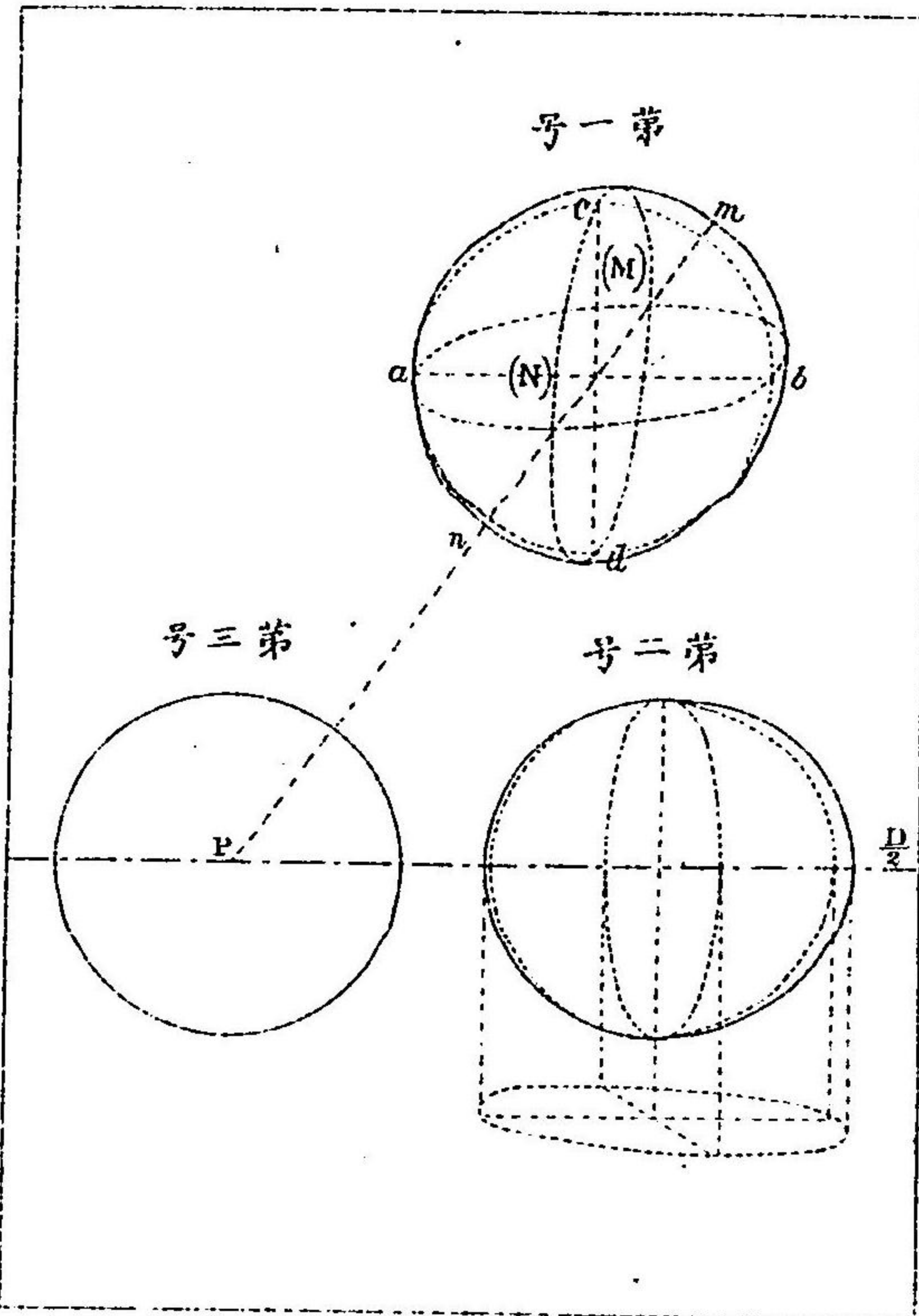

圖九十七第

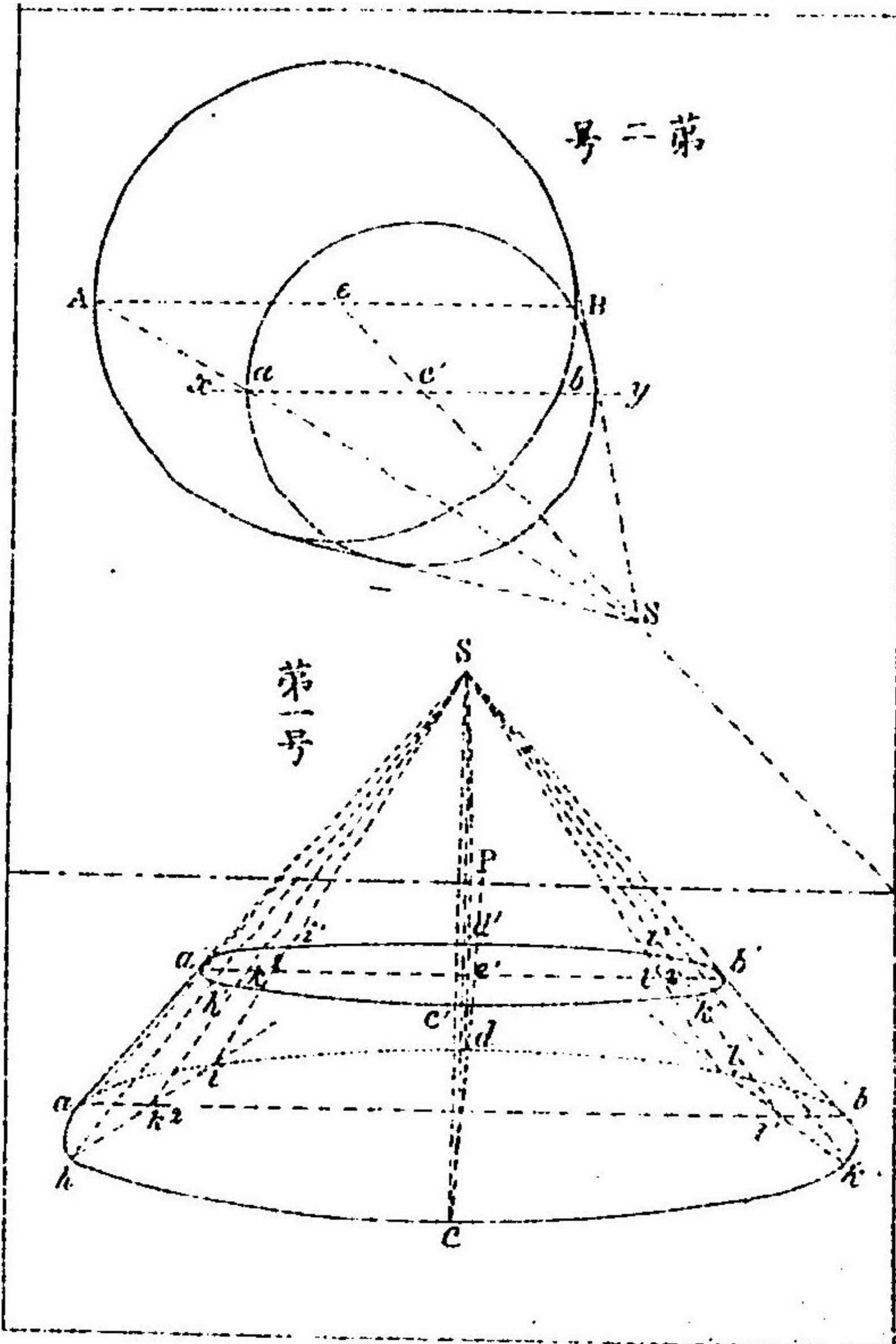

圖二十八第

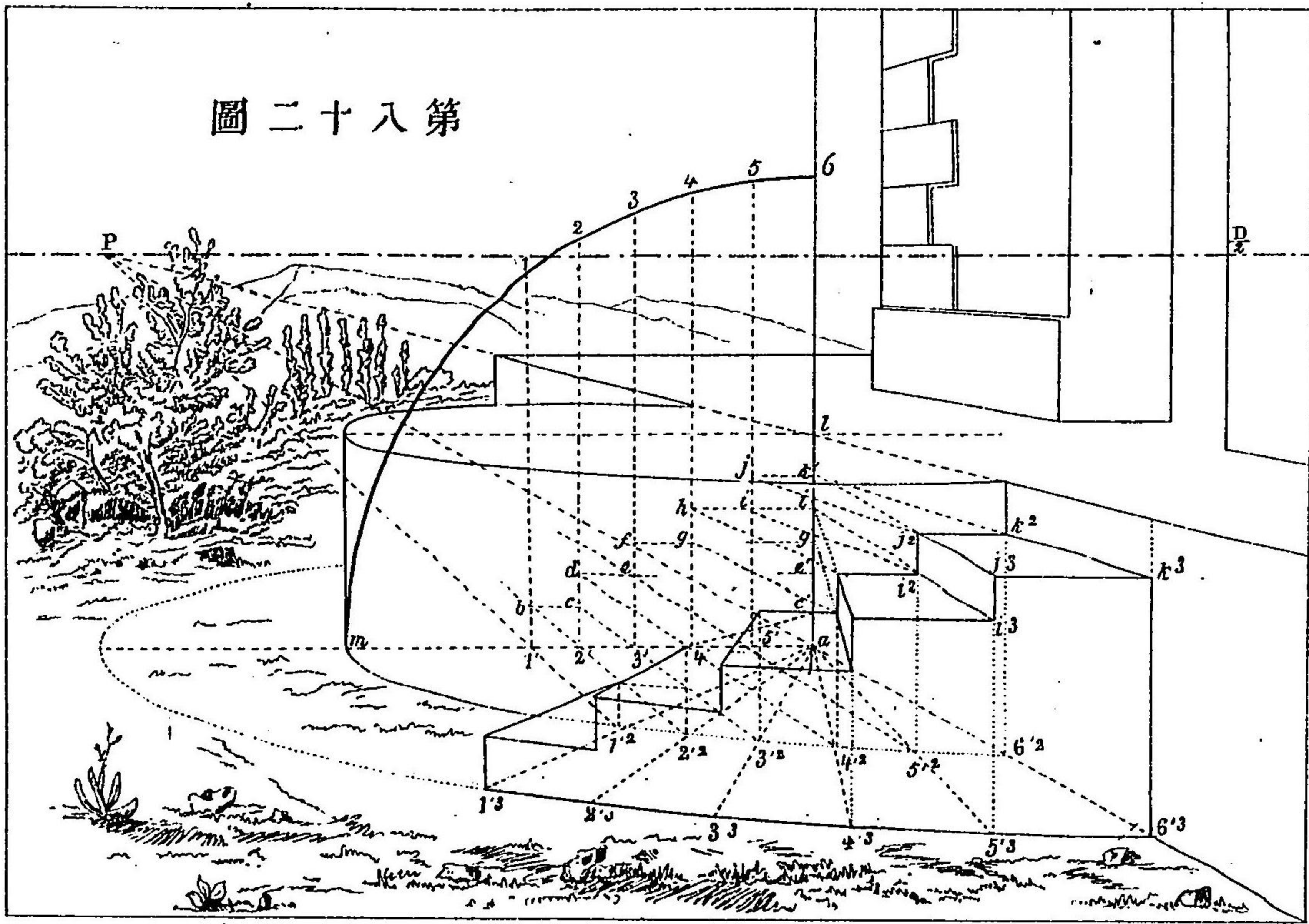

圖一十八第

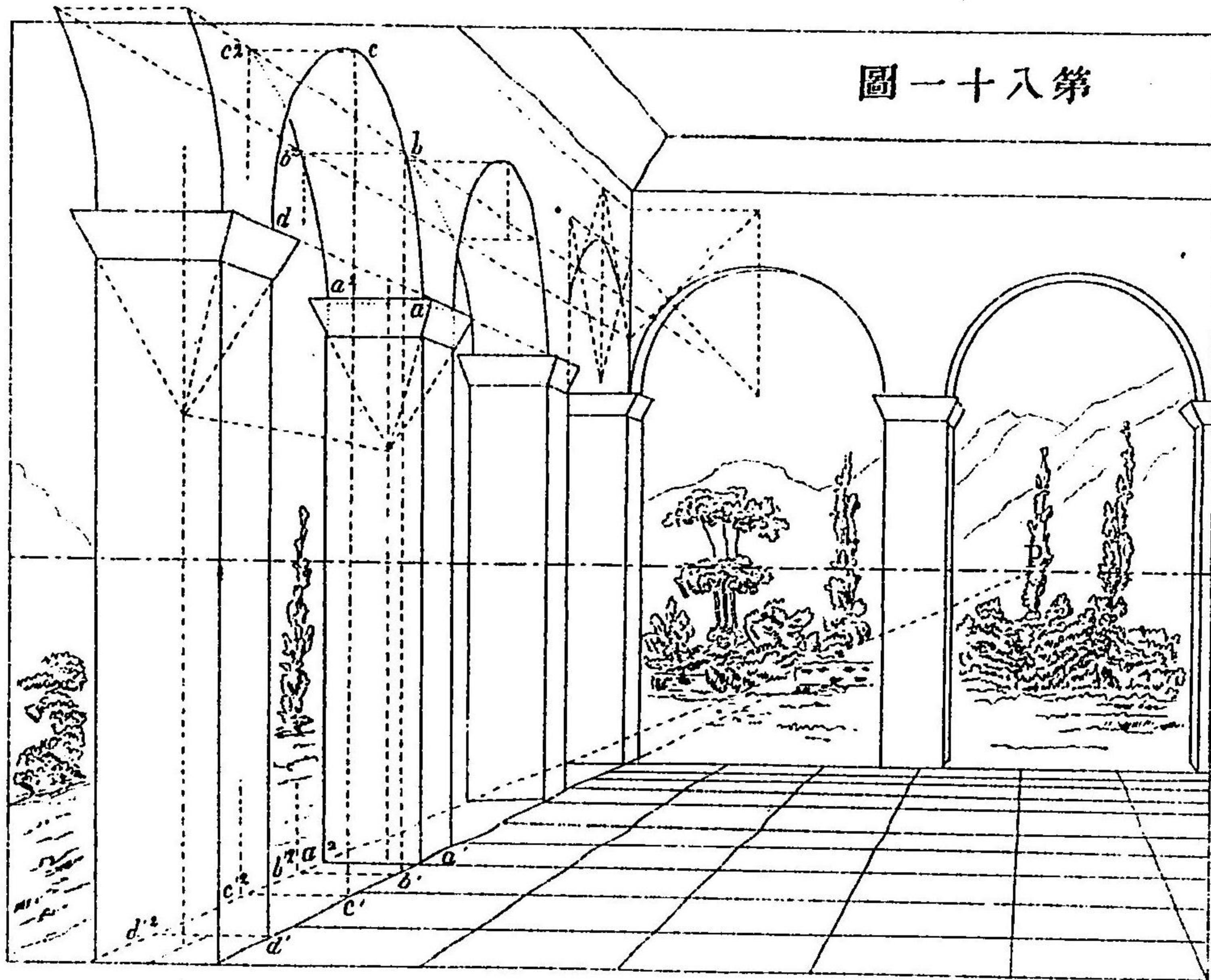

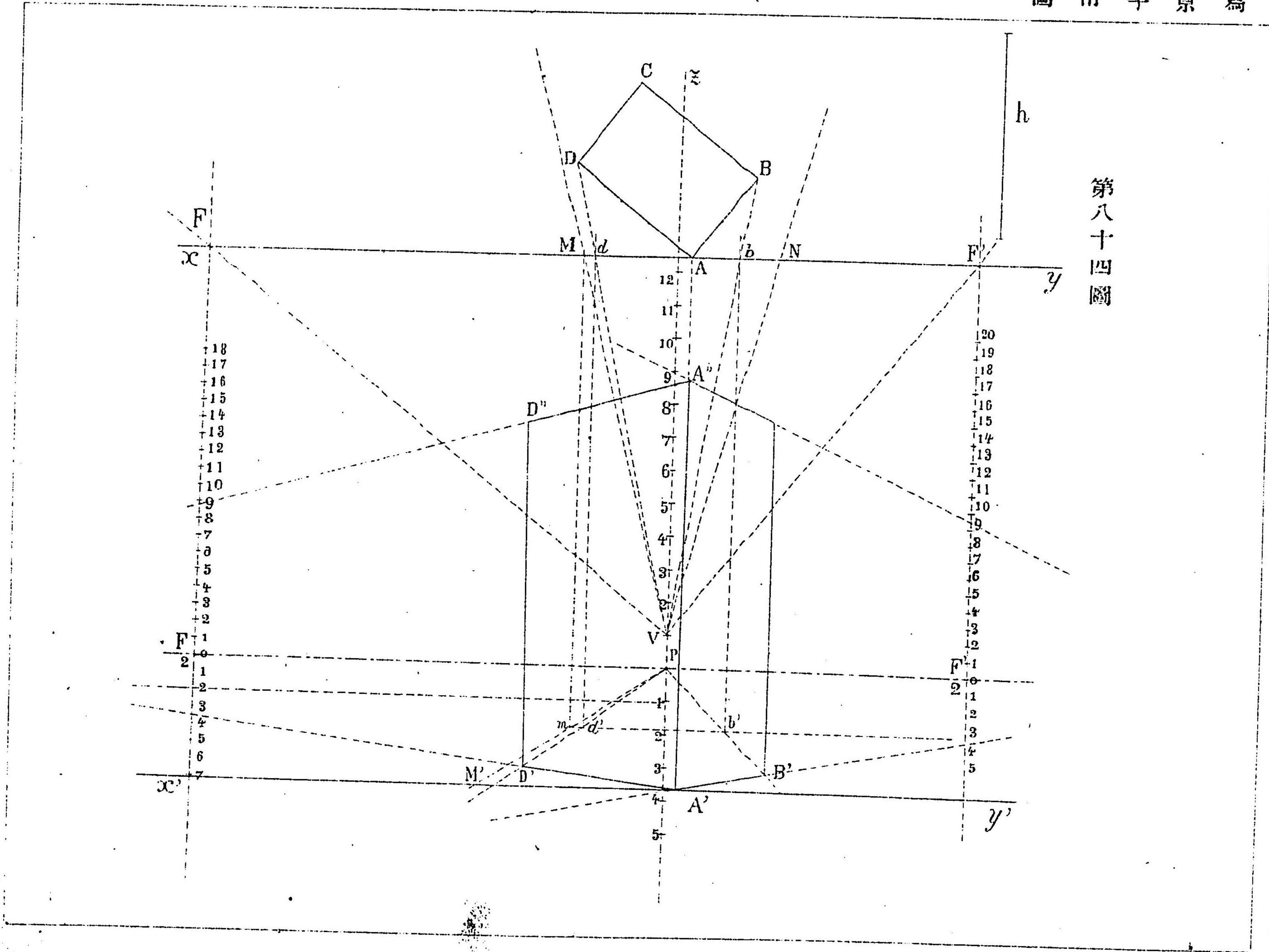

第八十四圖

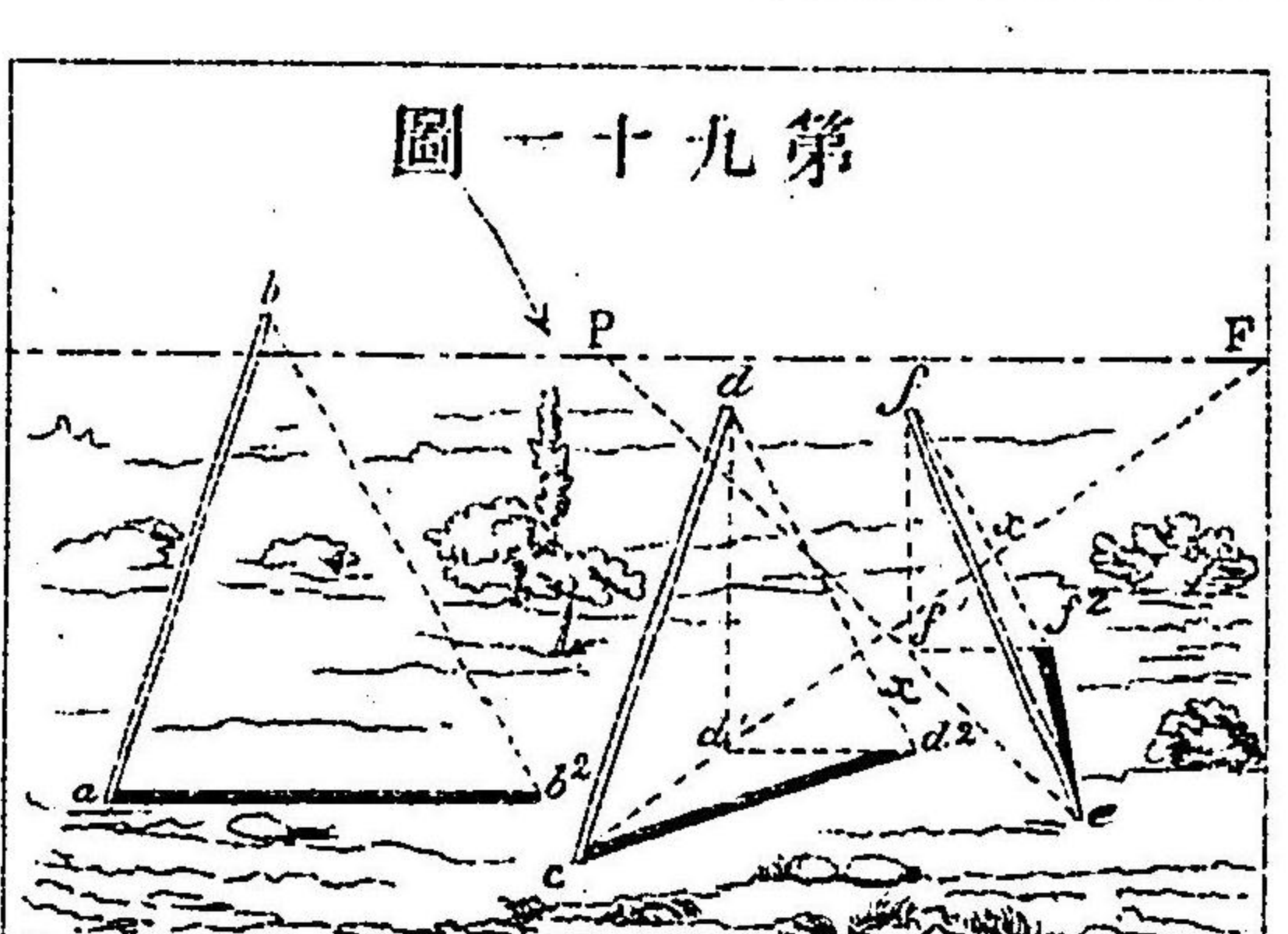
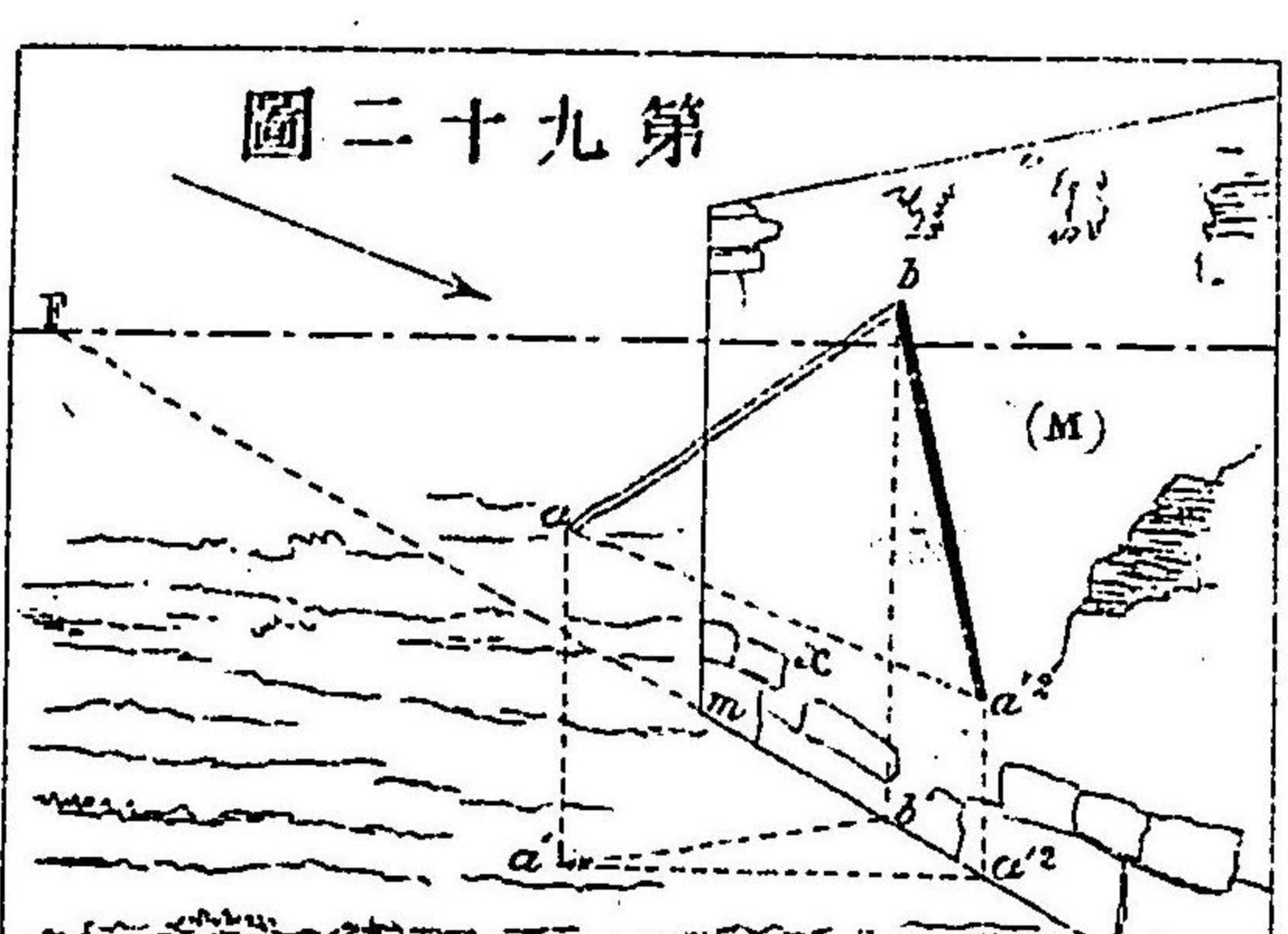
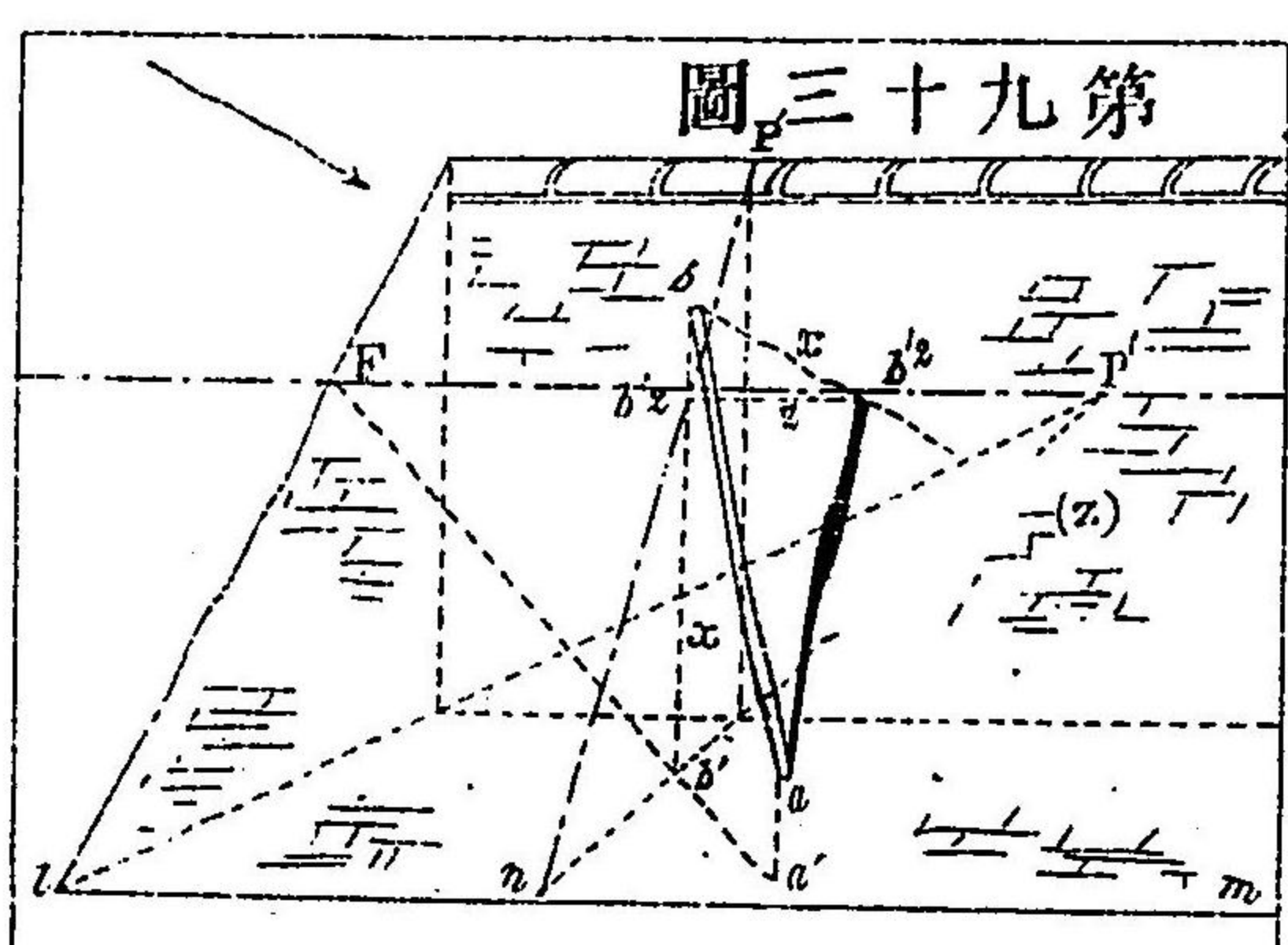
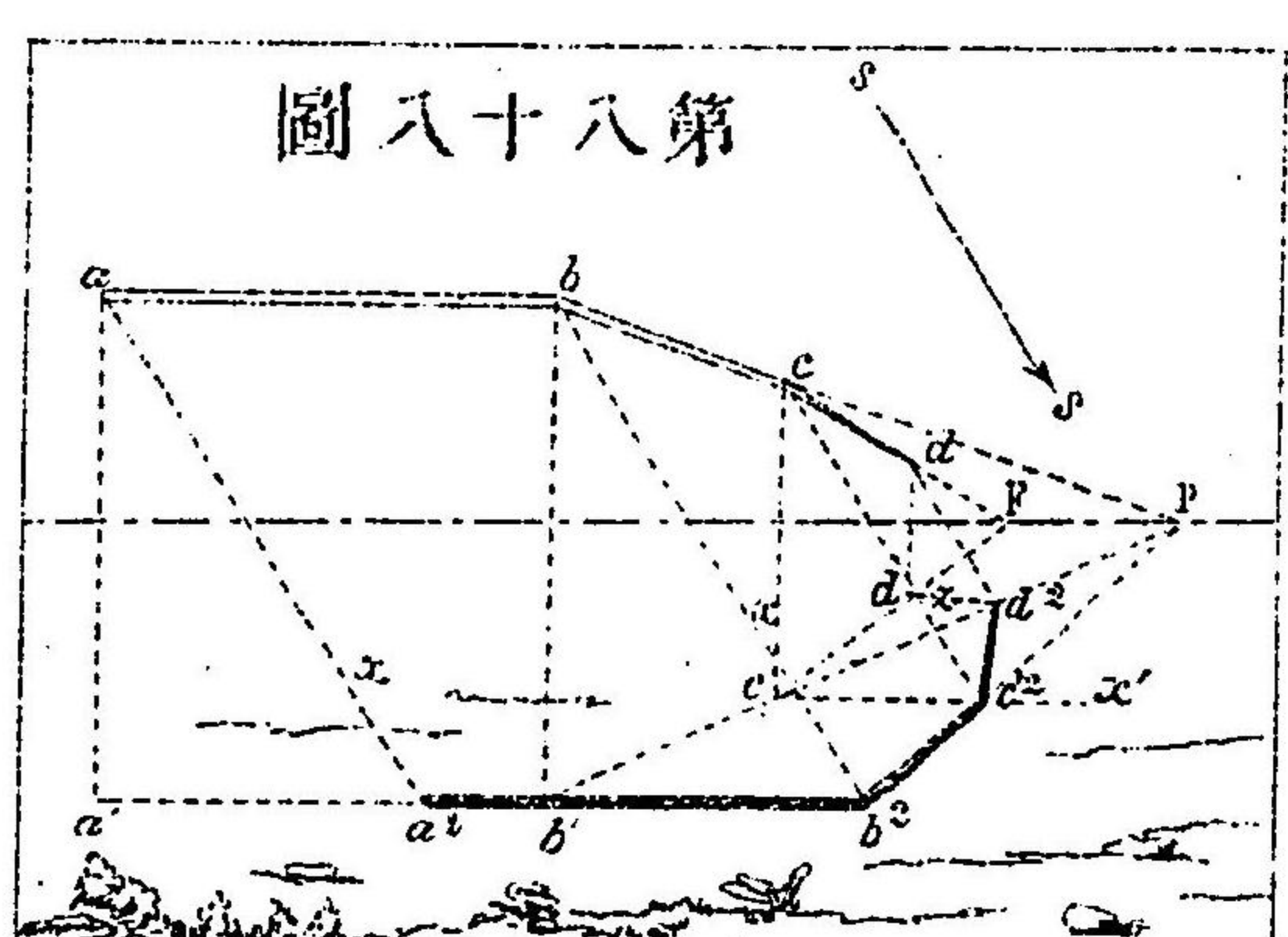
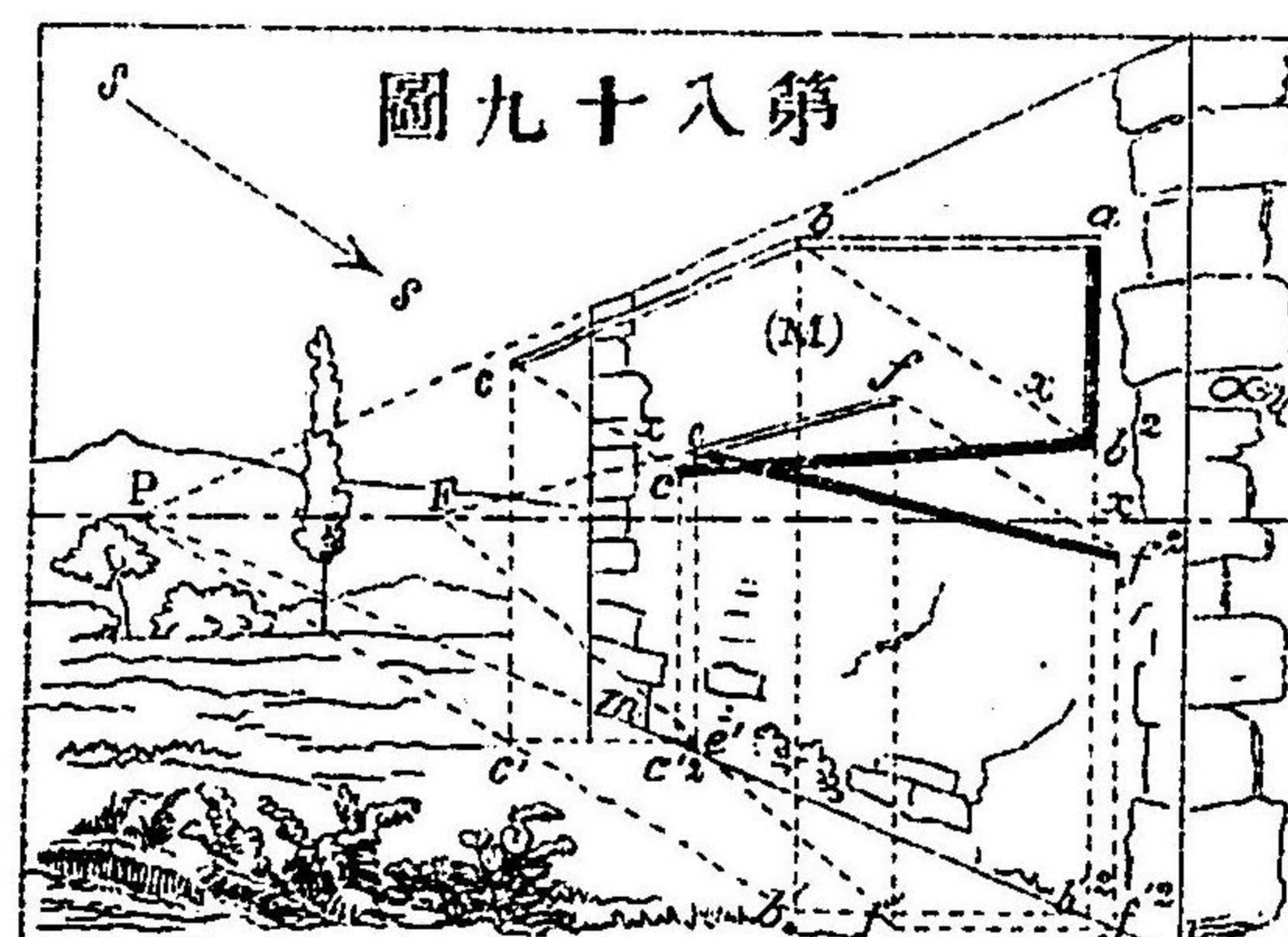
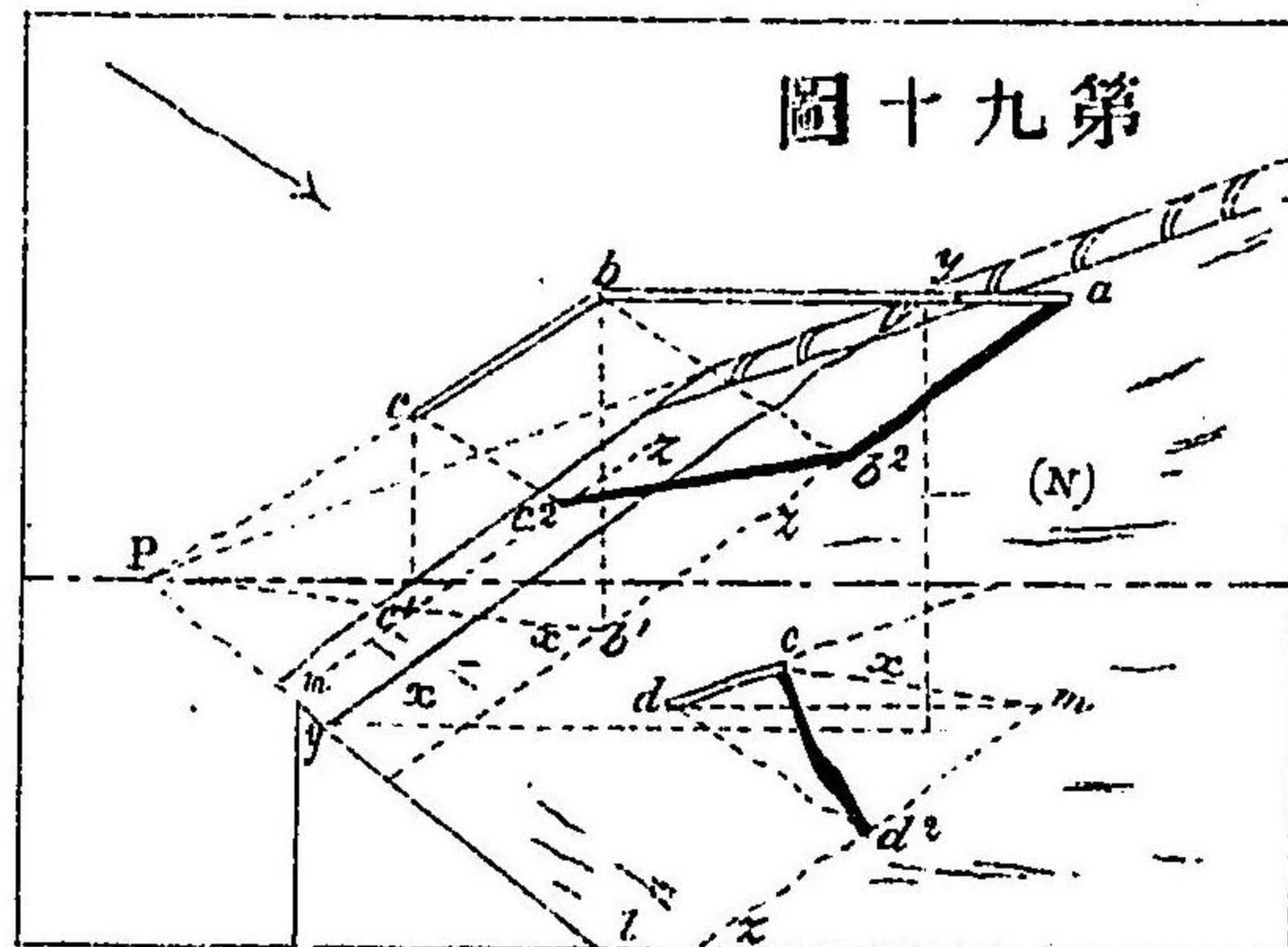
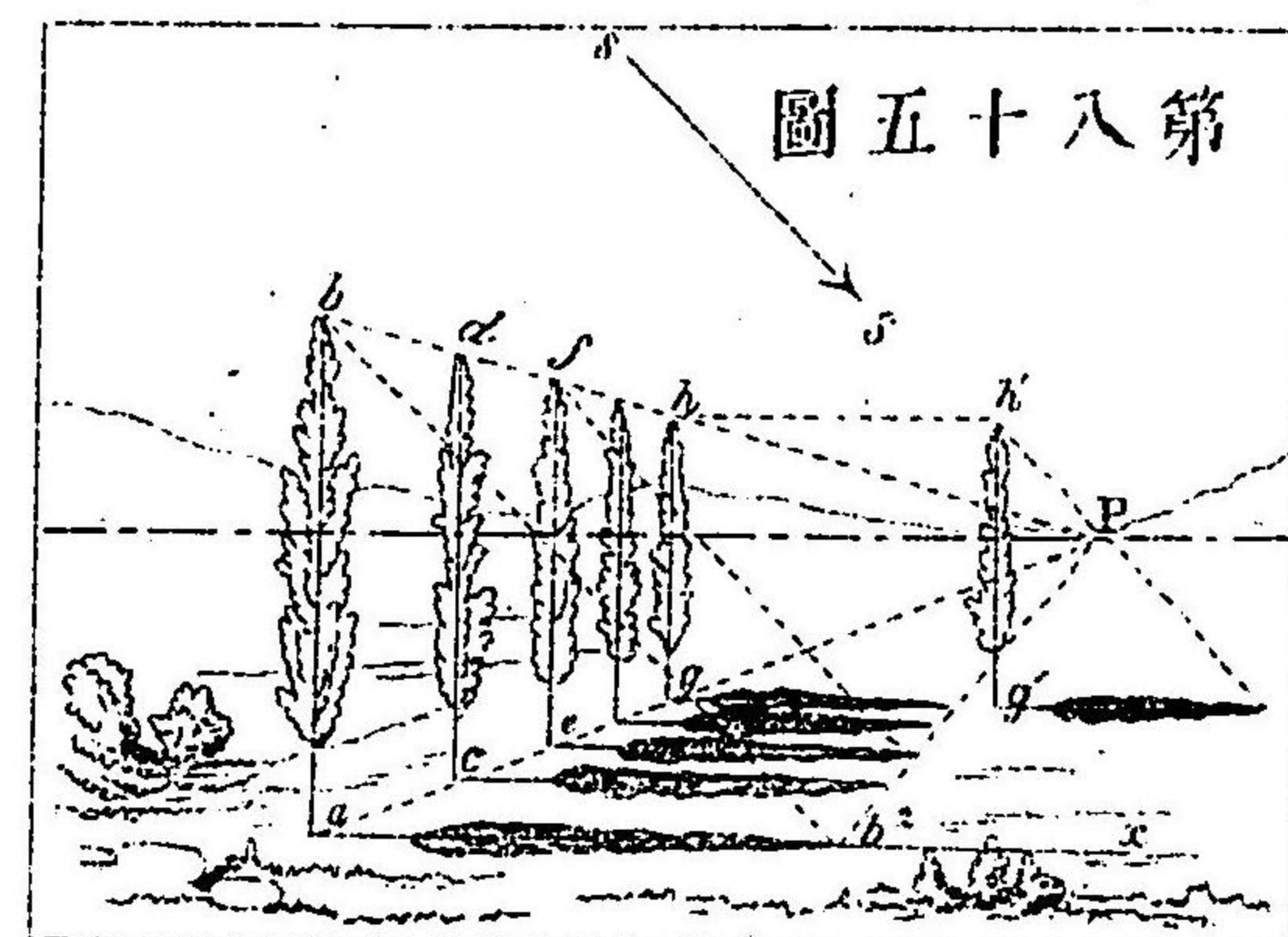
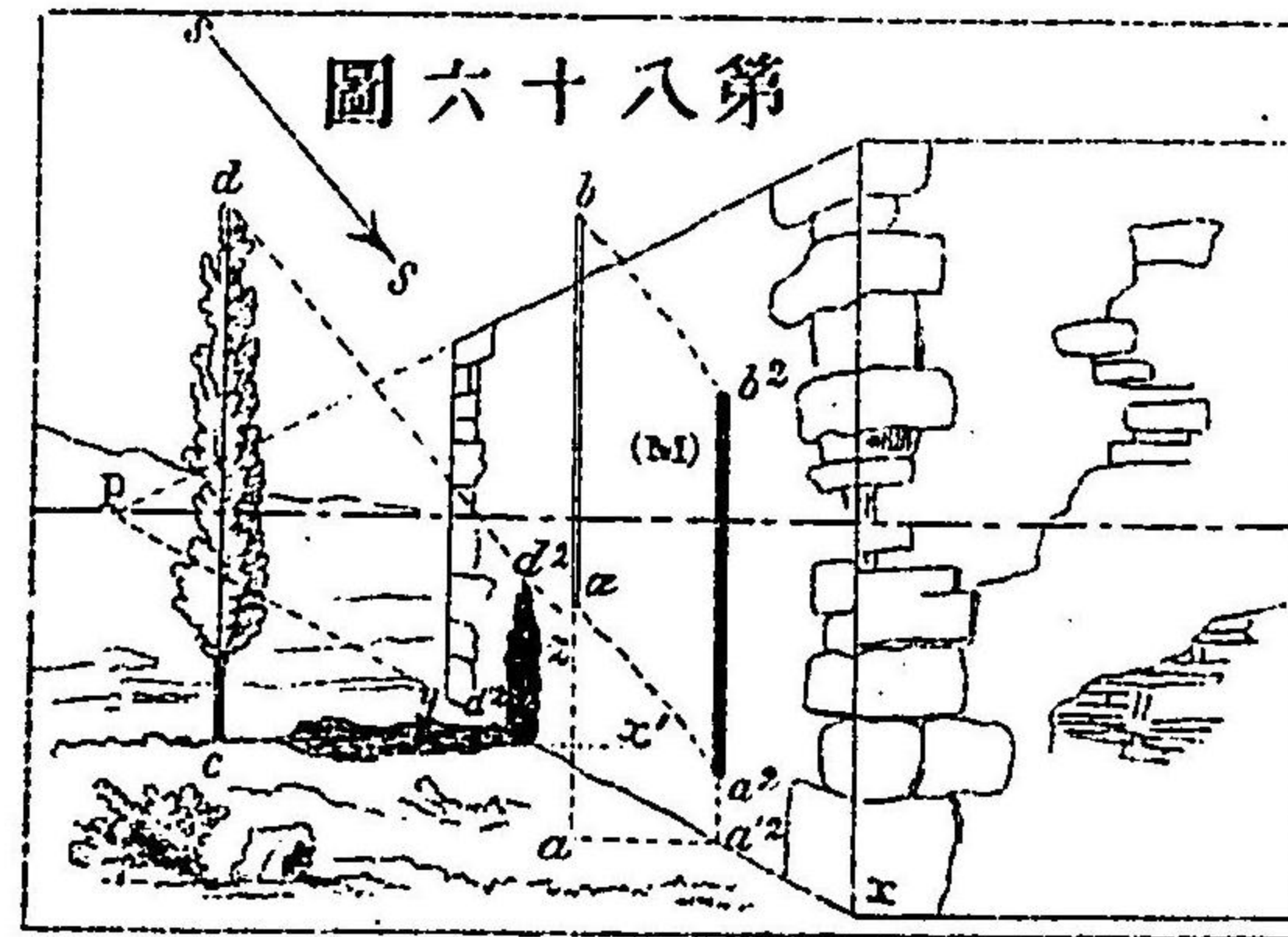
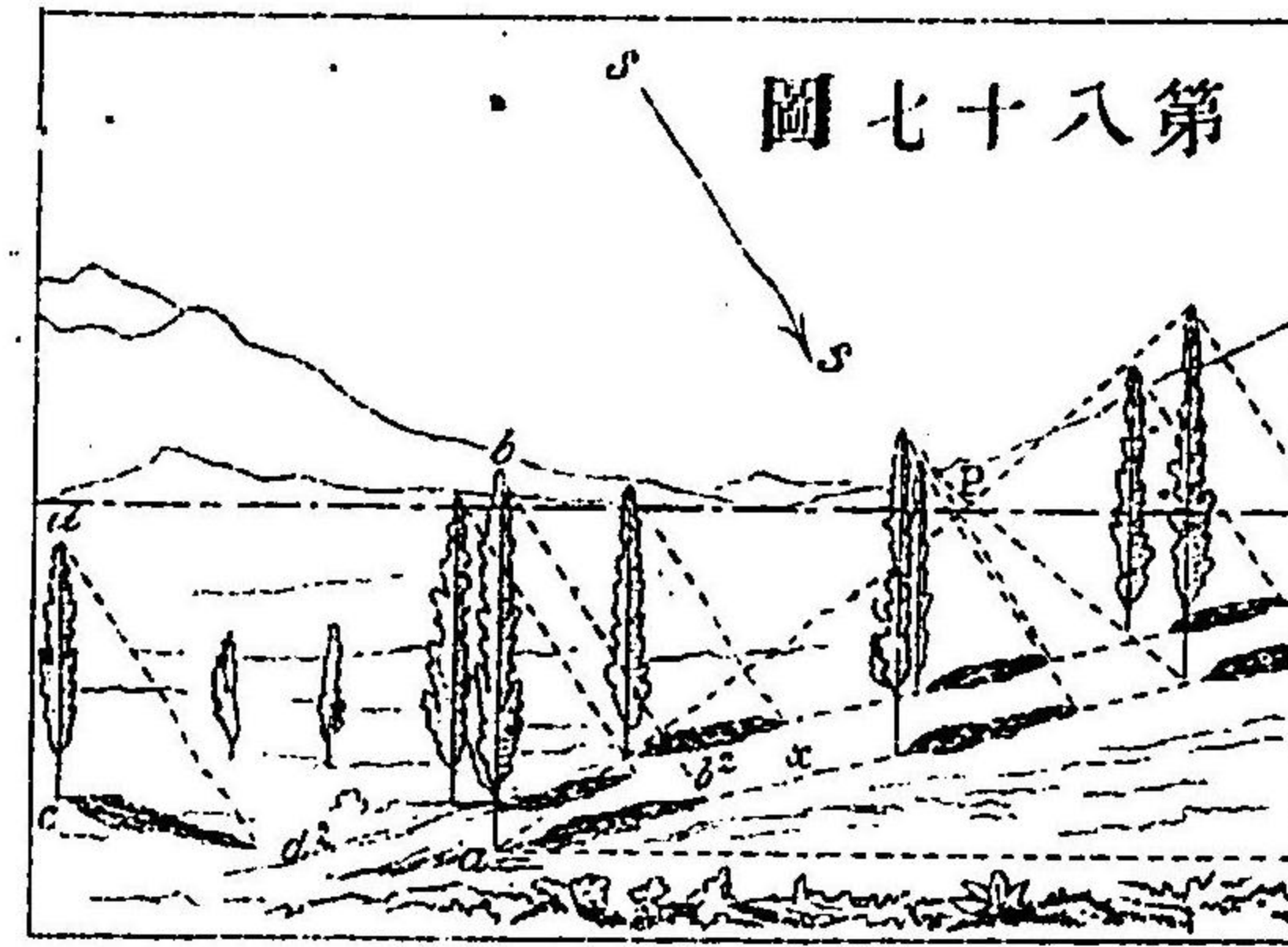

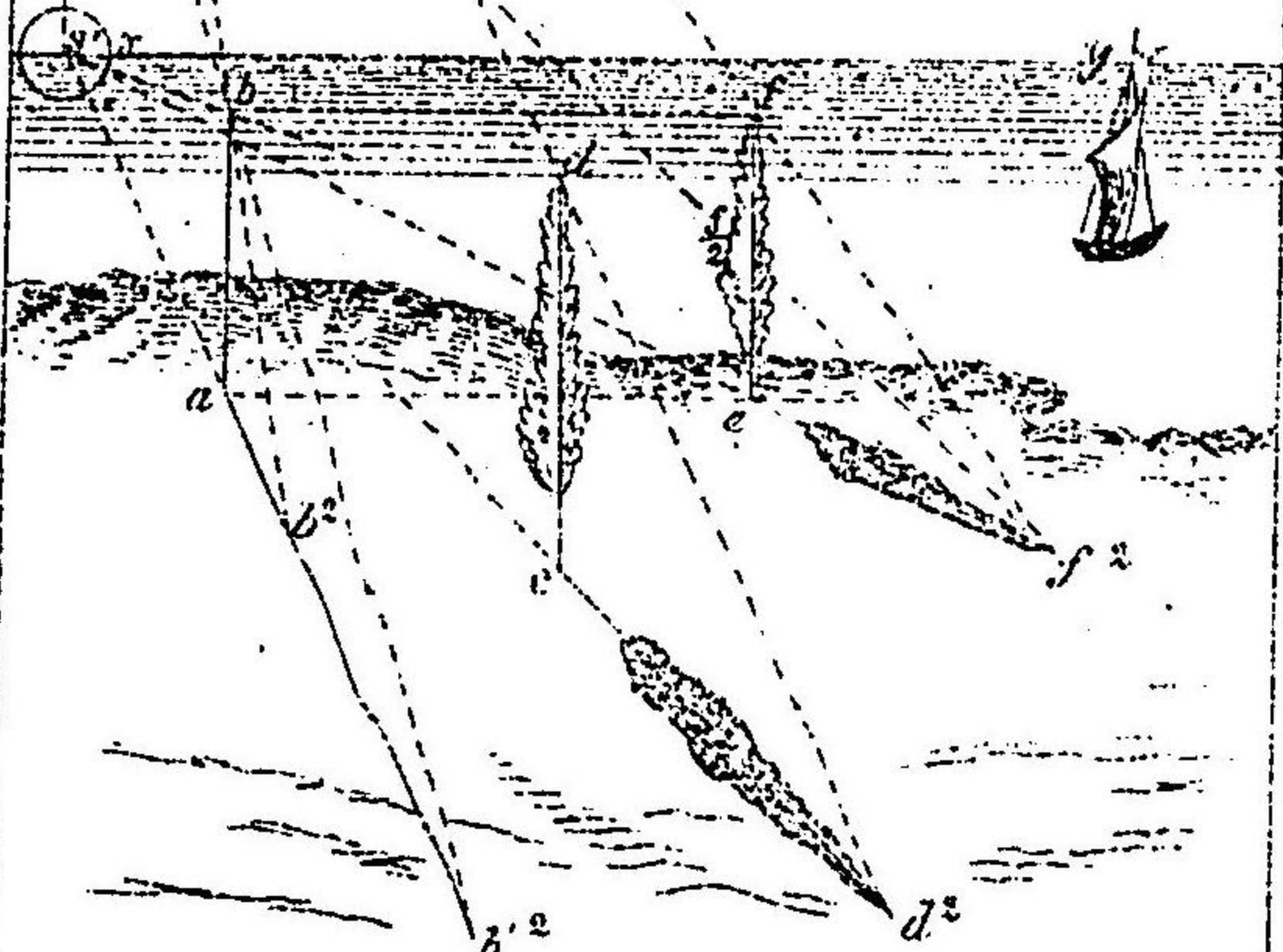
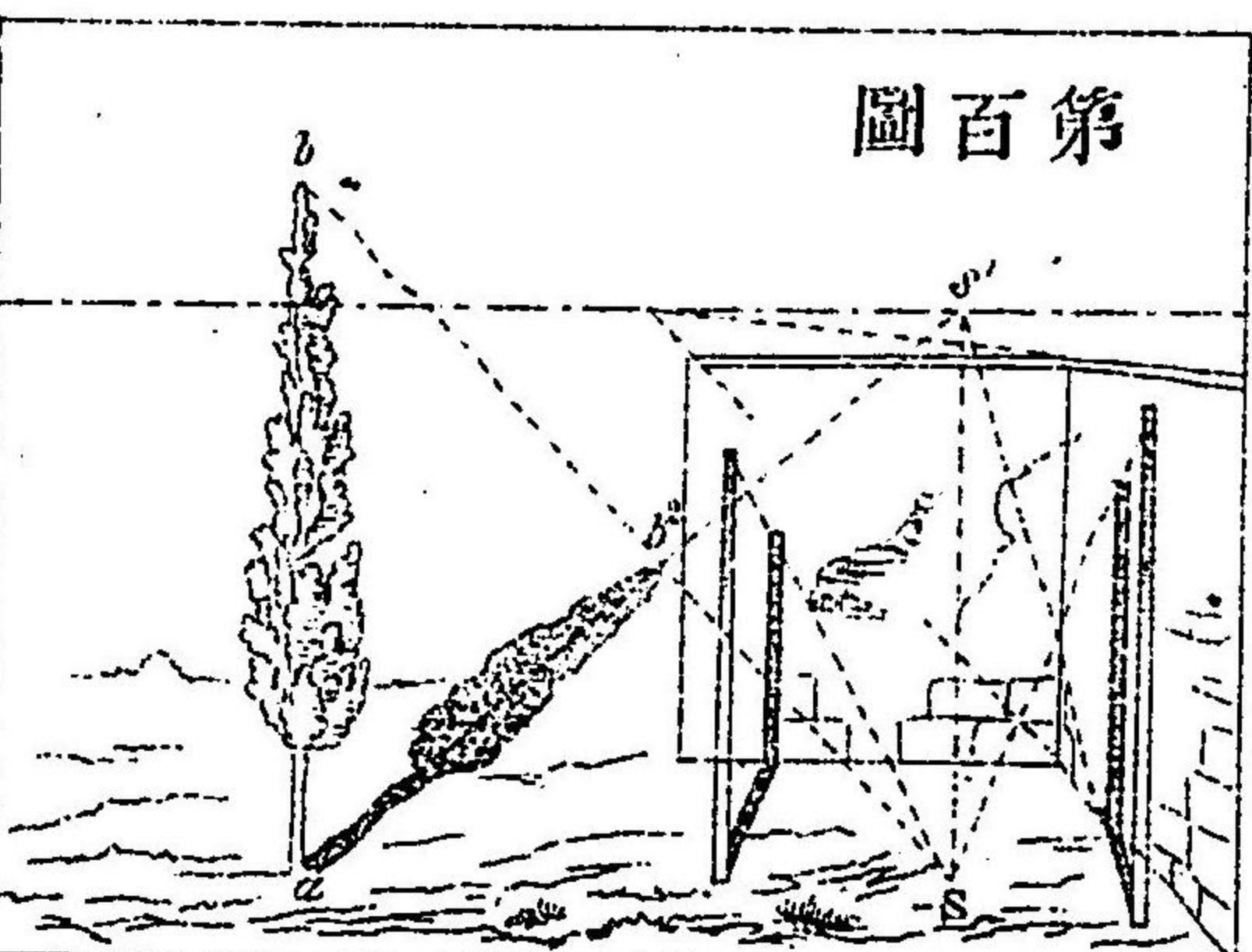
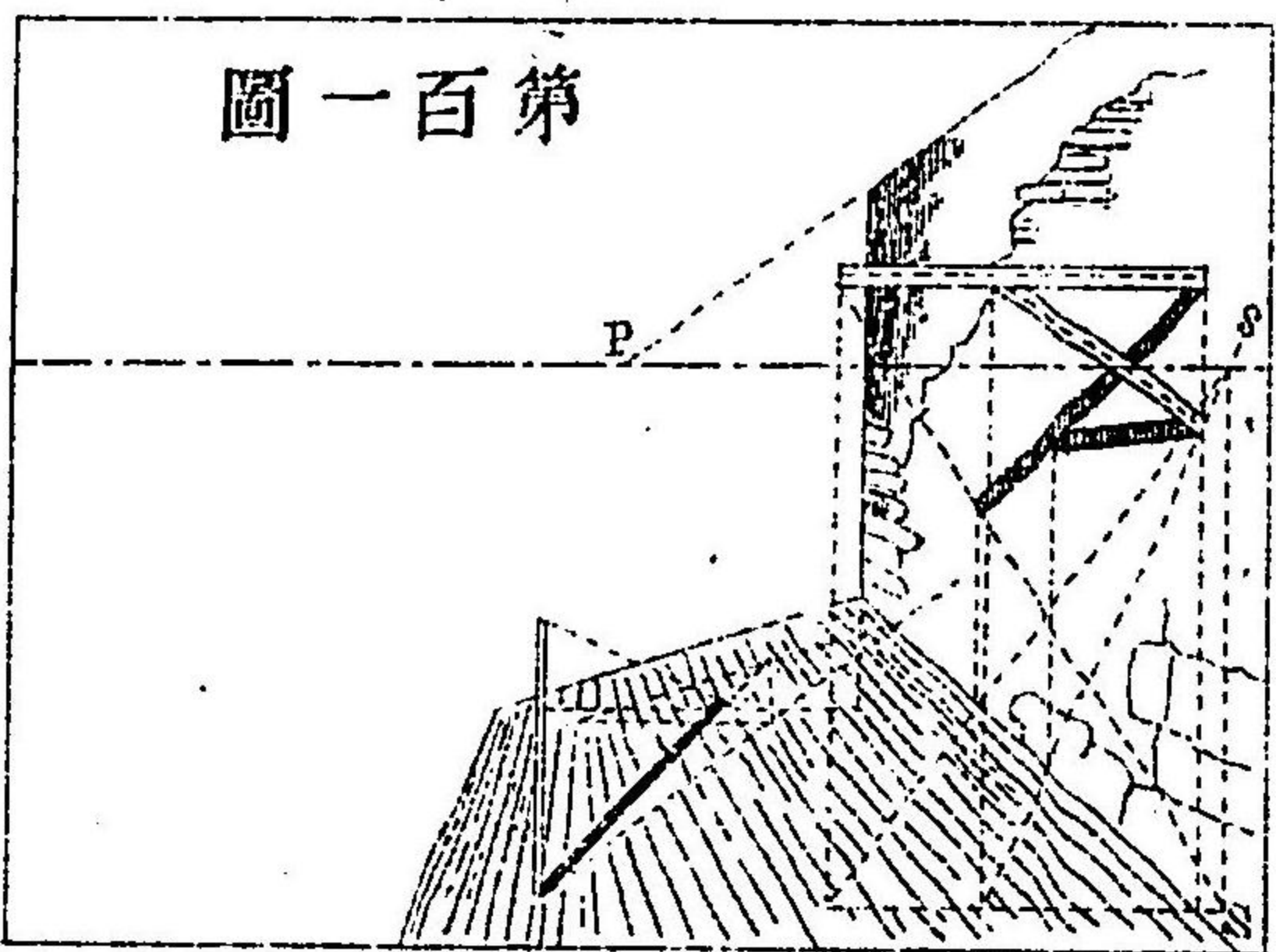
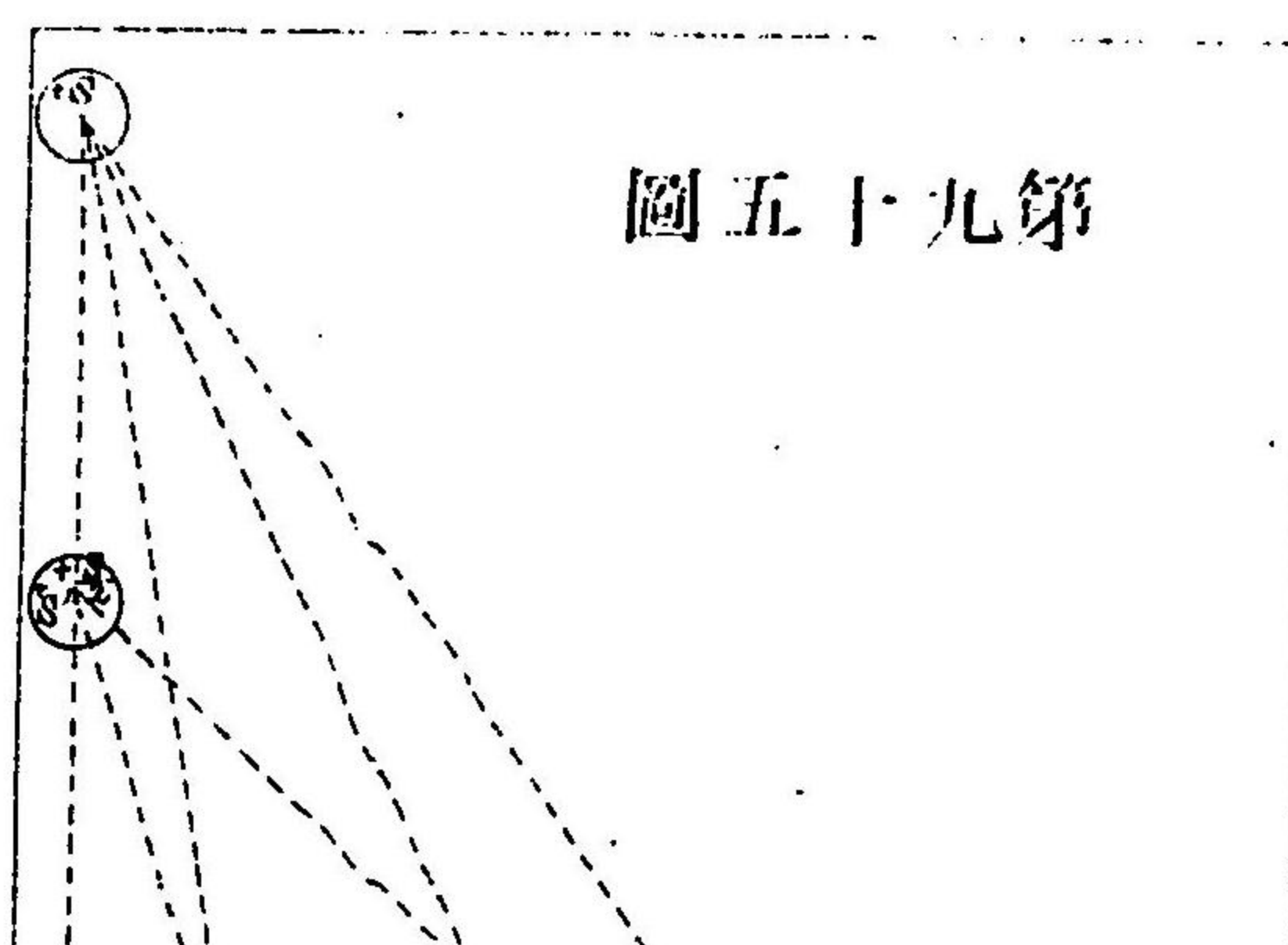
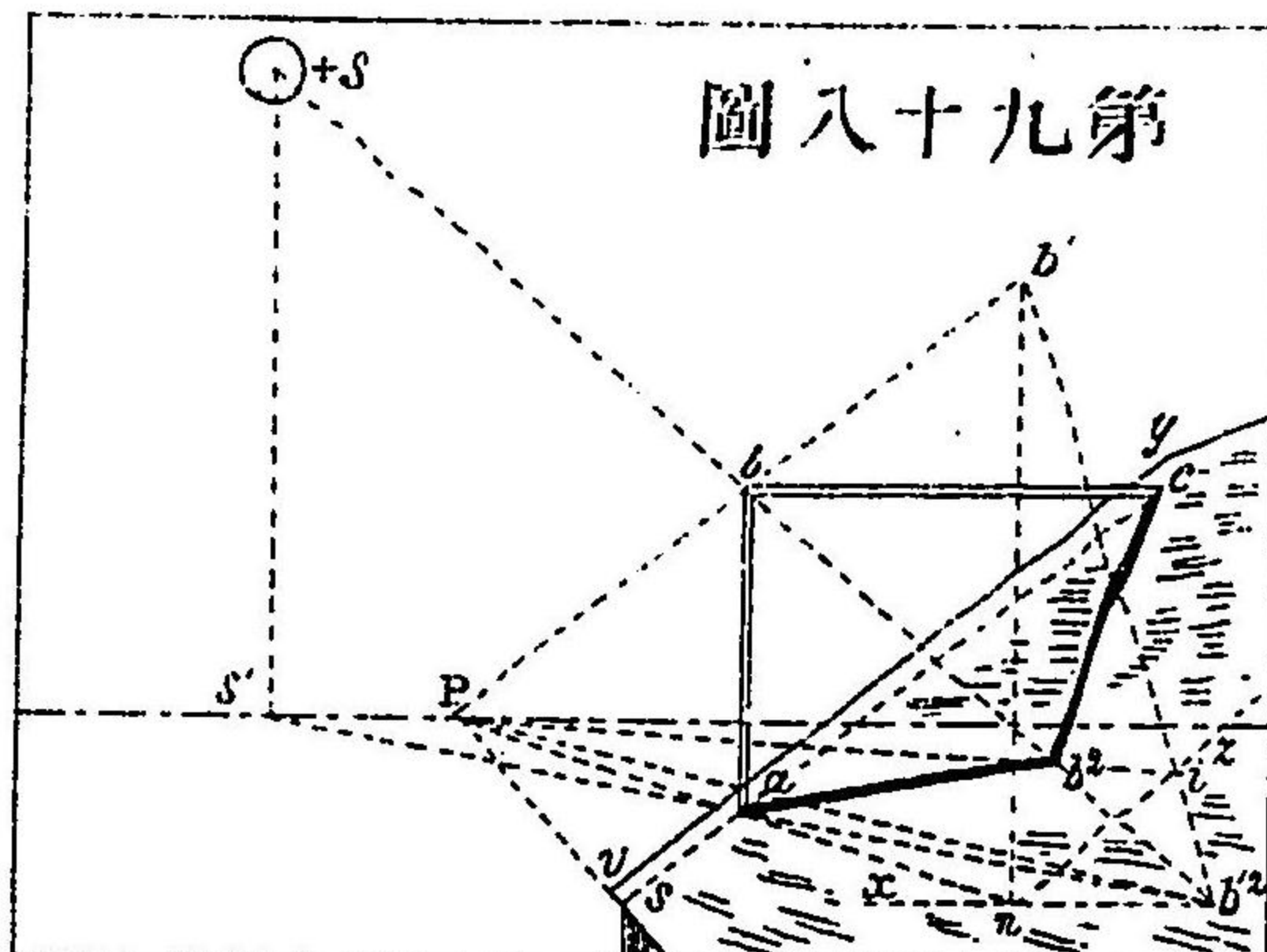
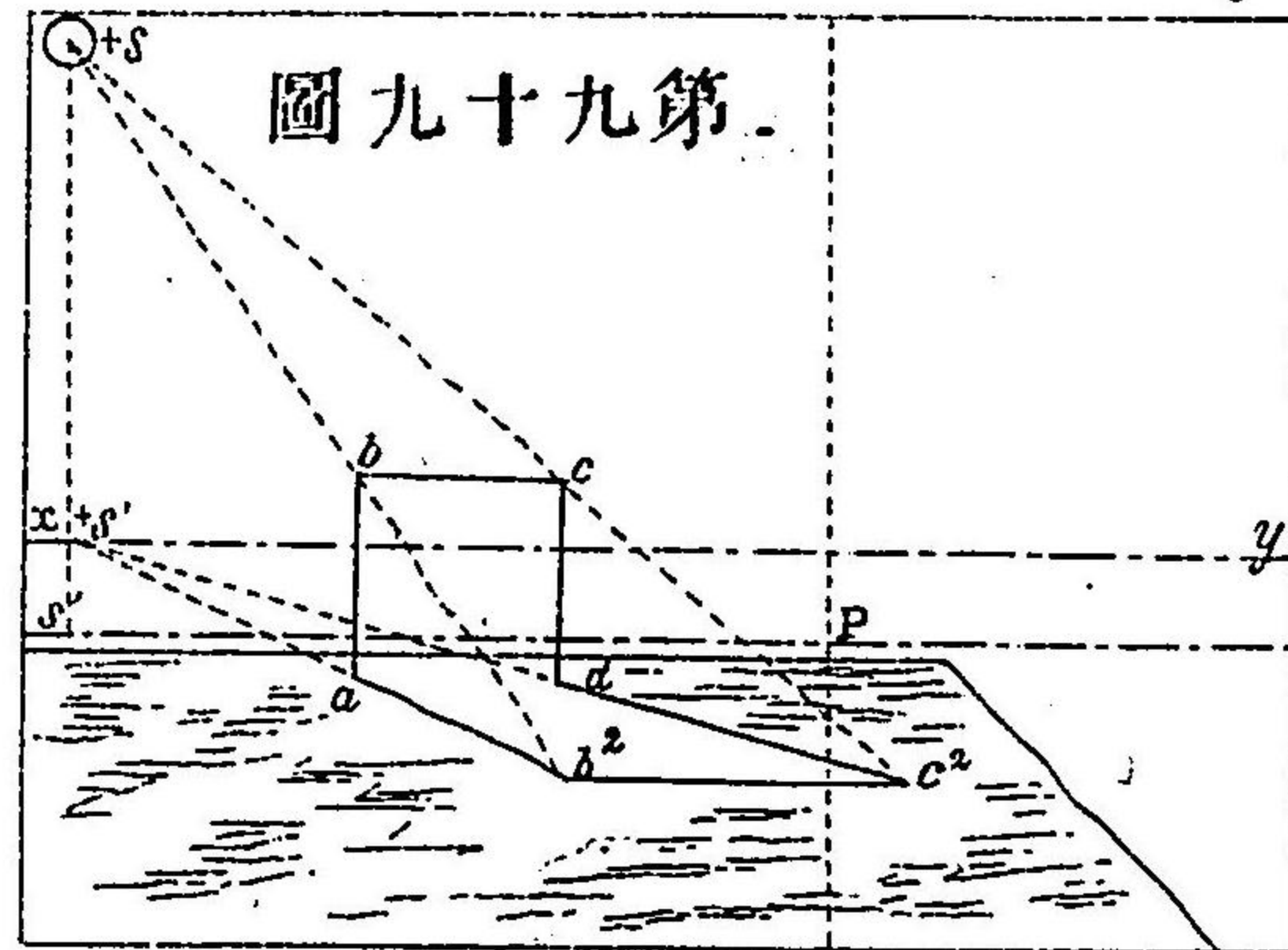
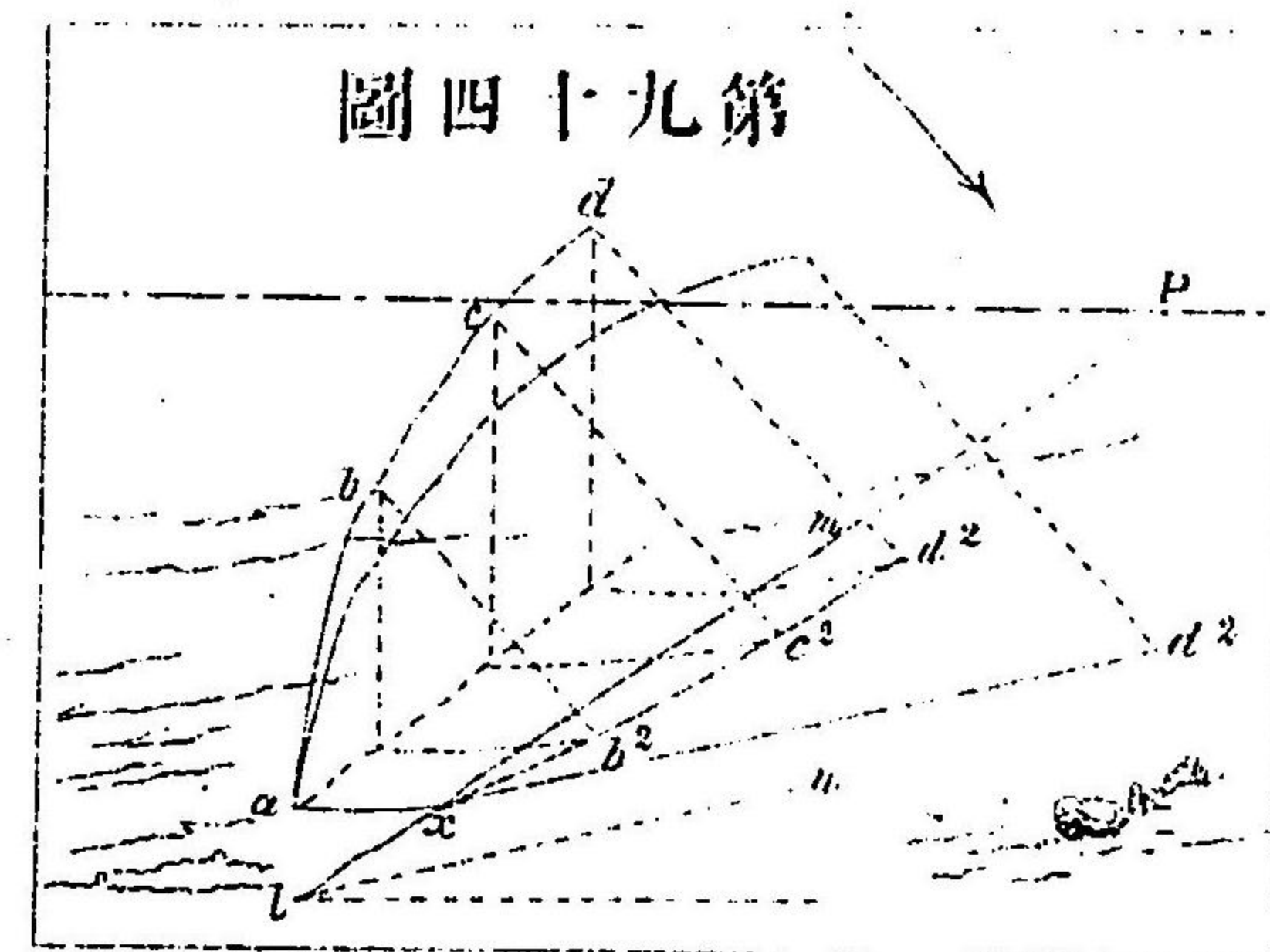
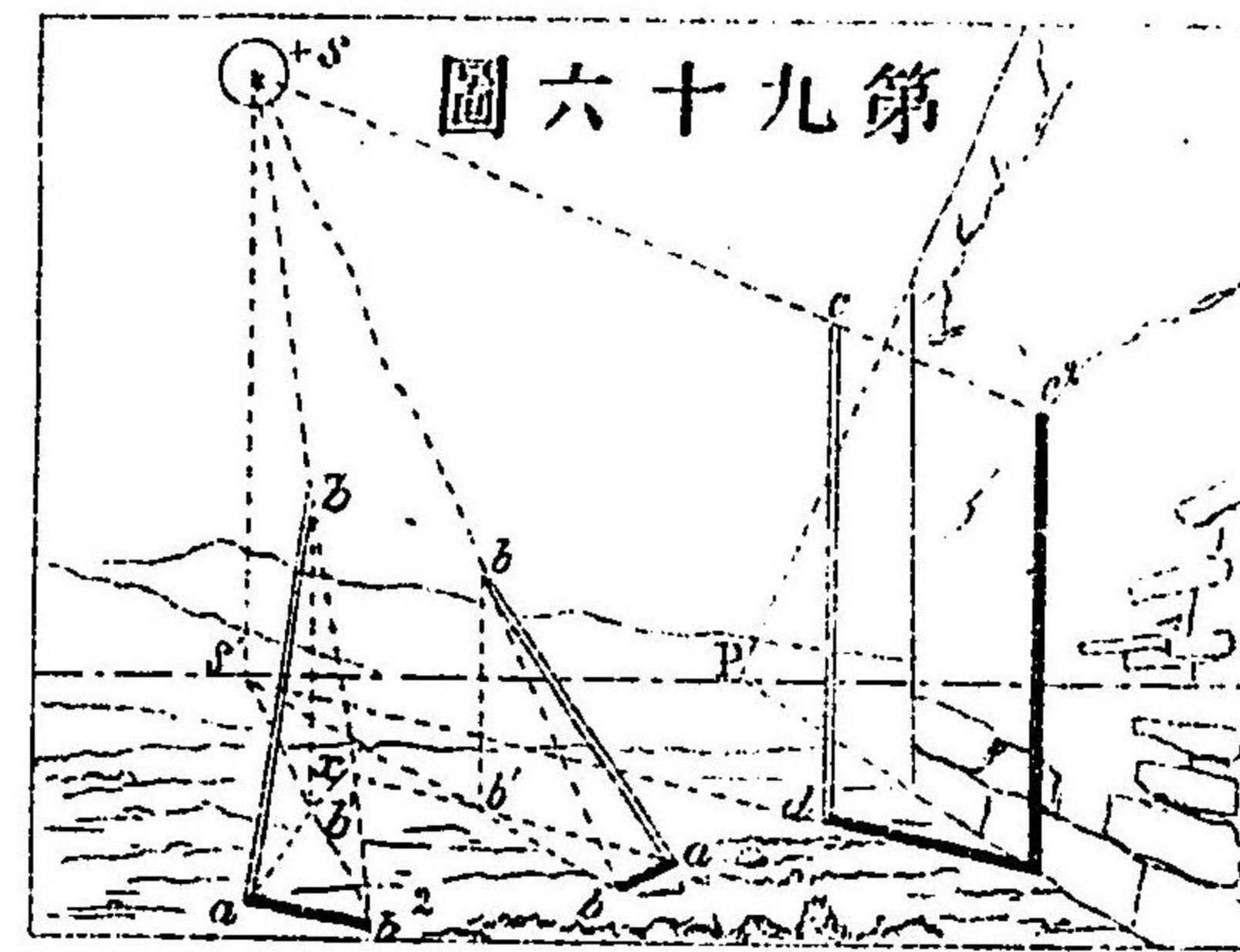
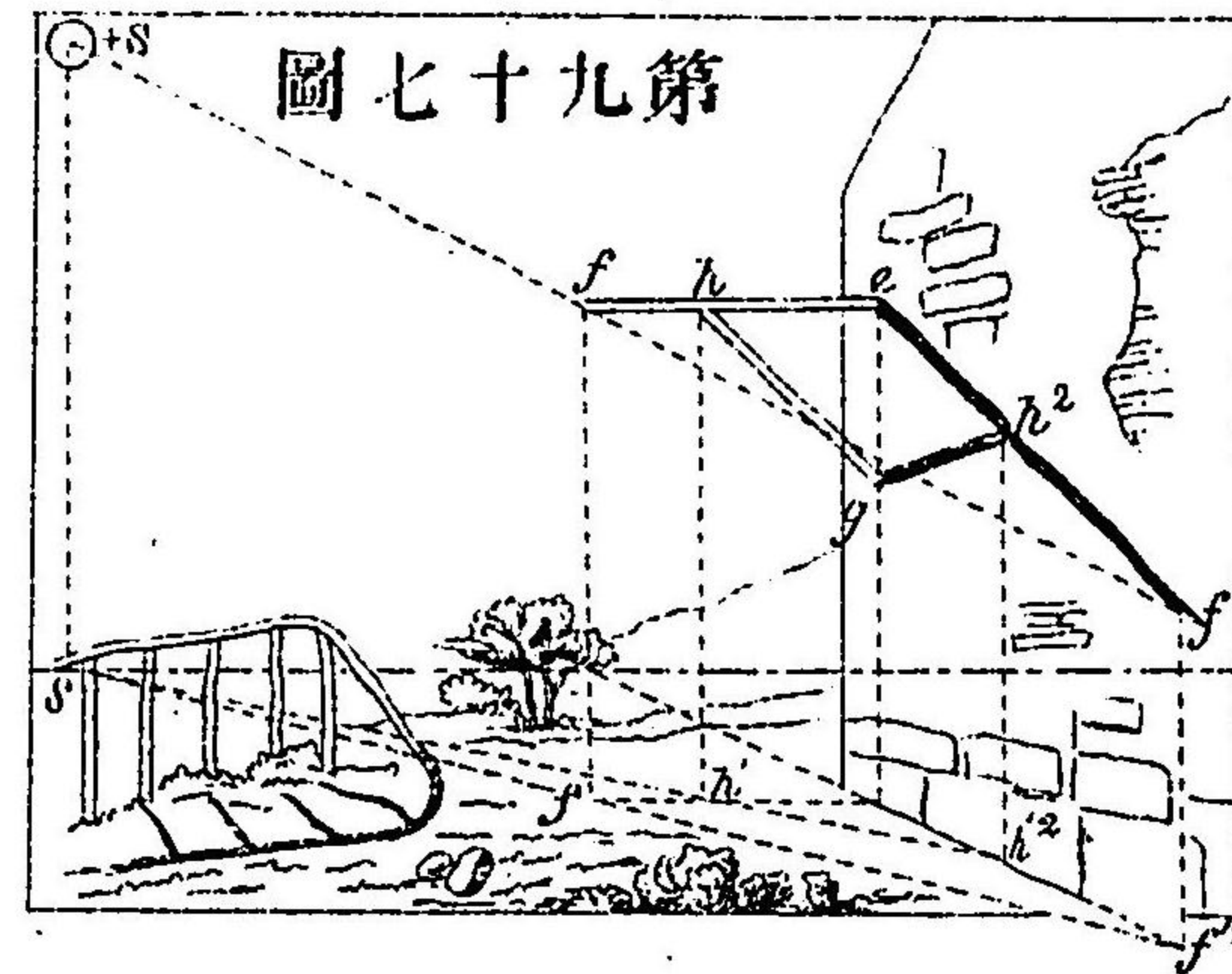

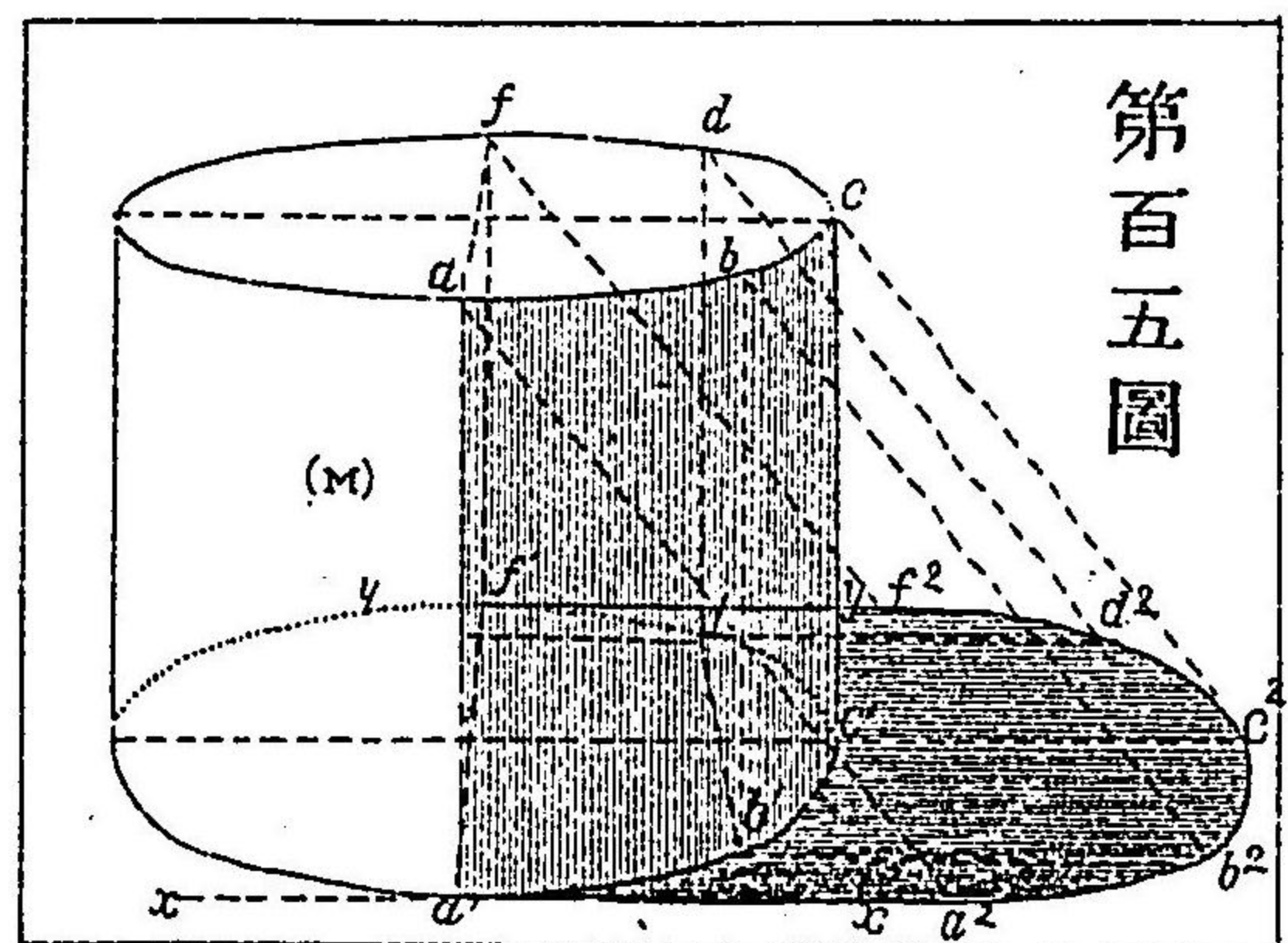
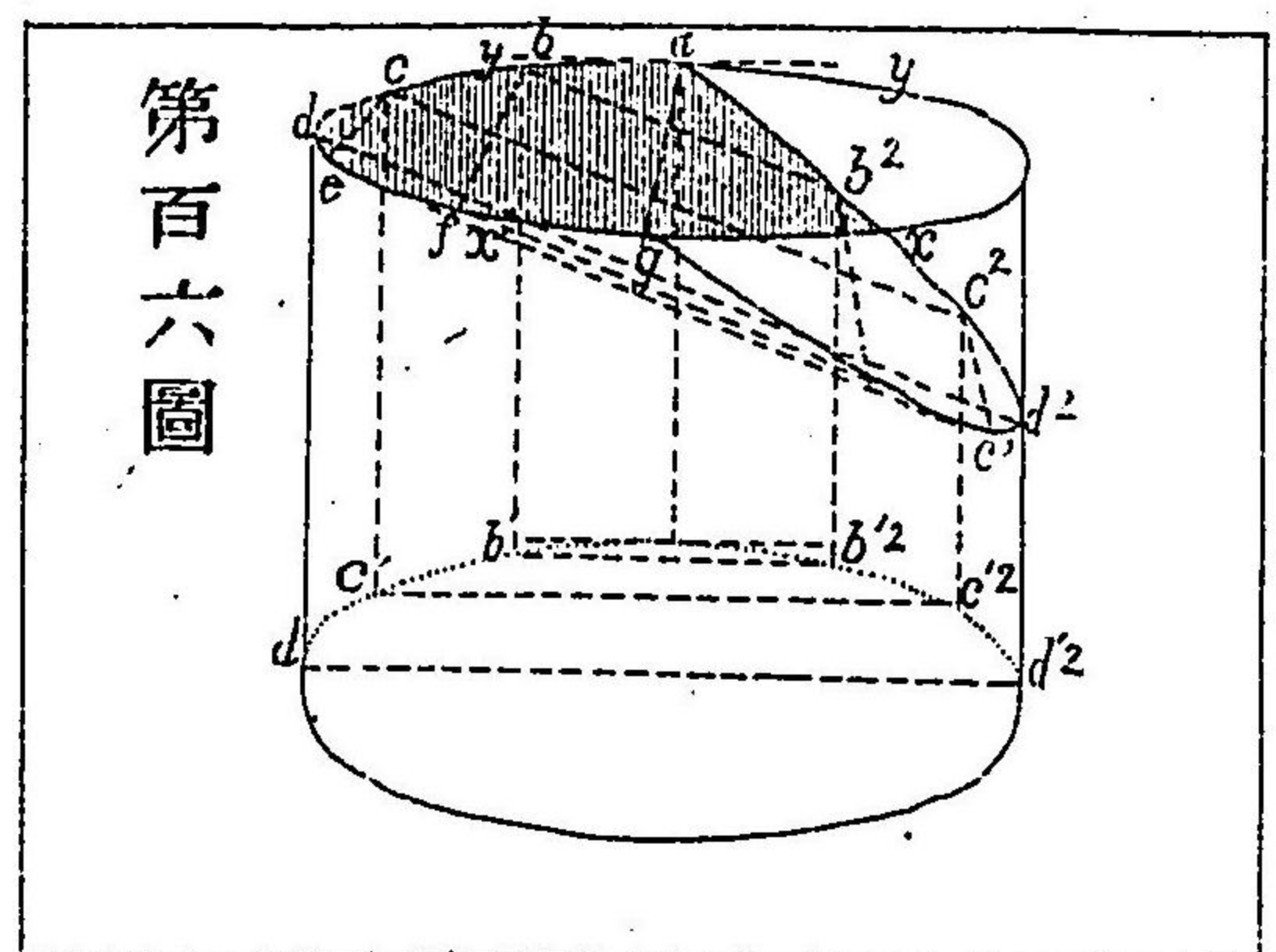
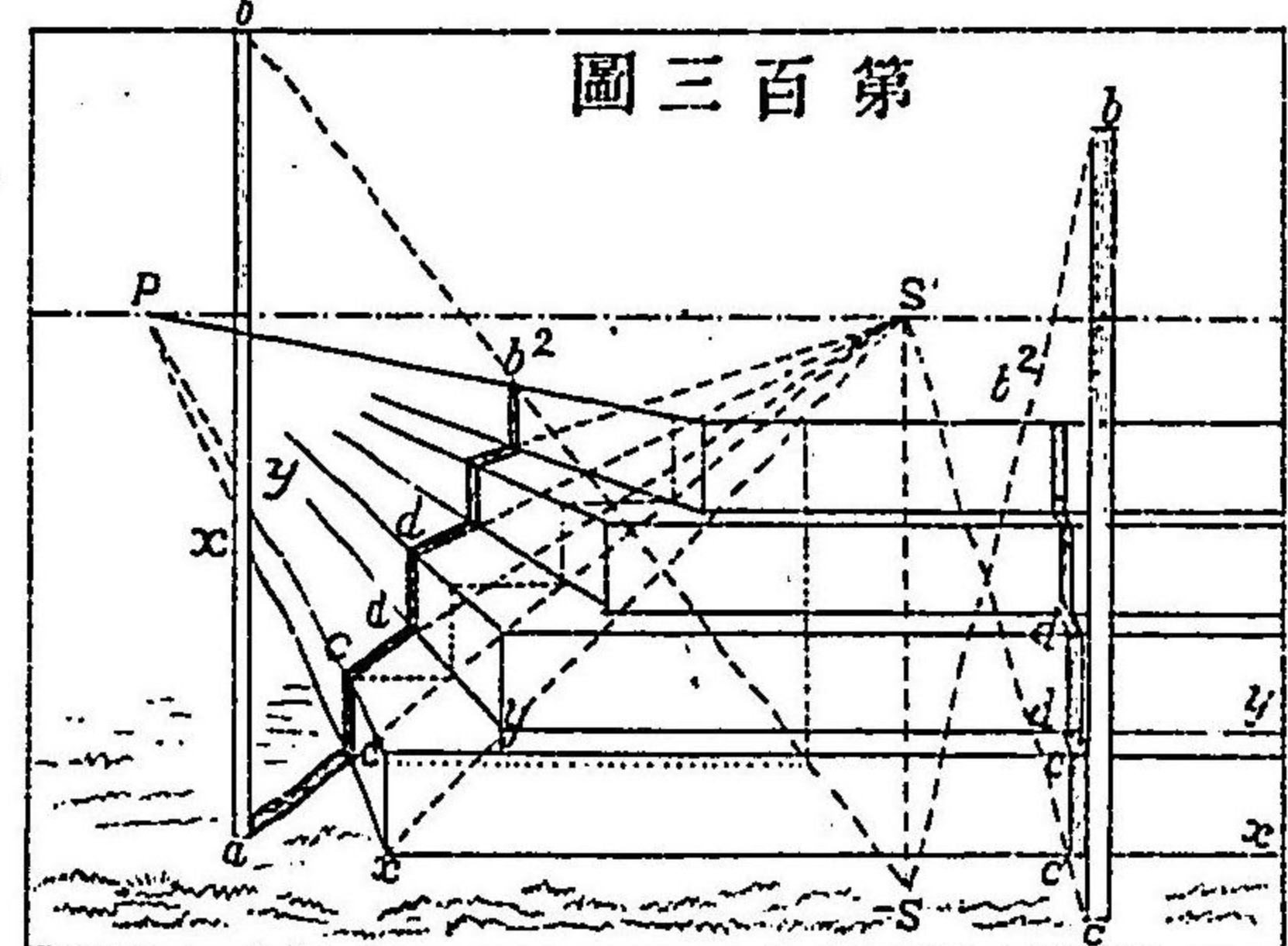
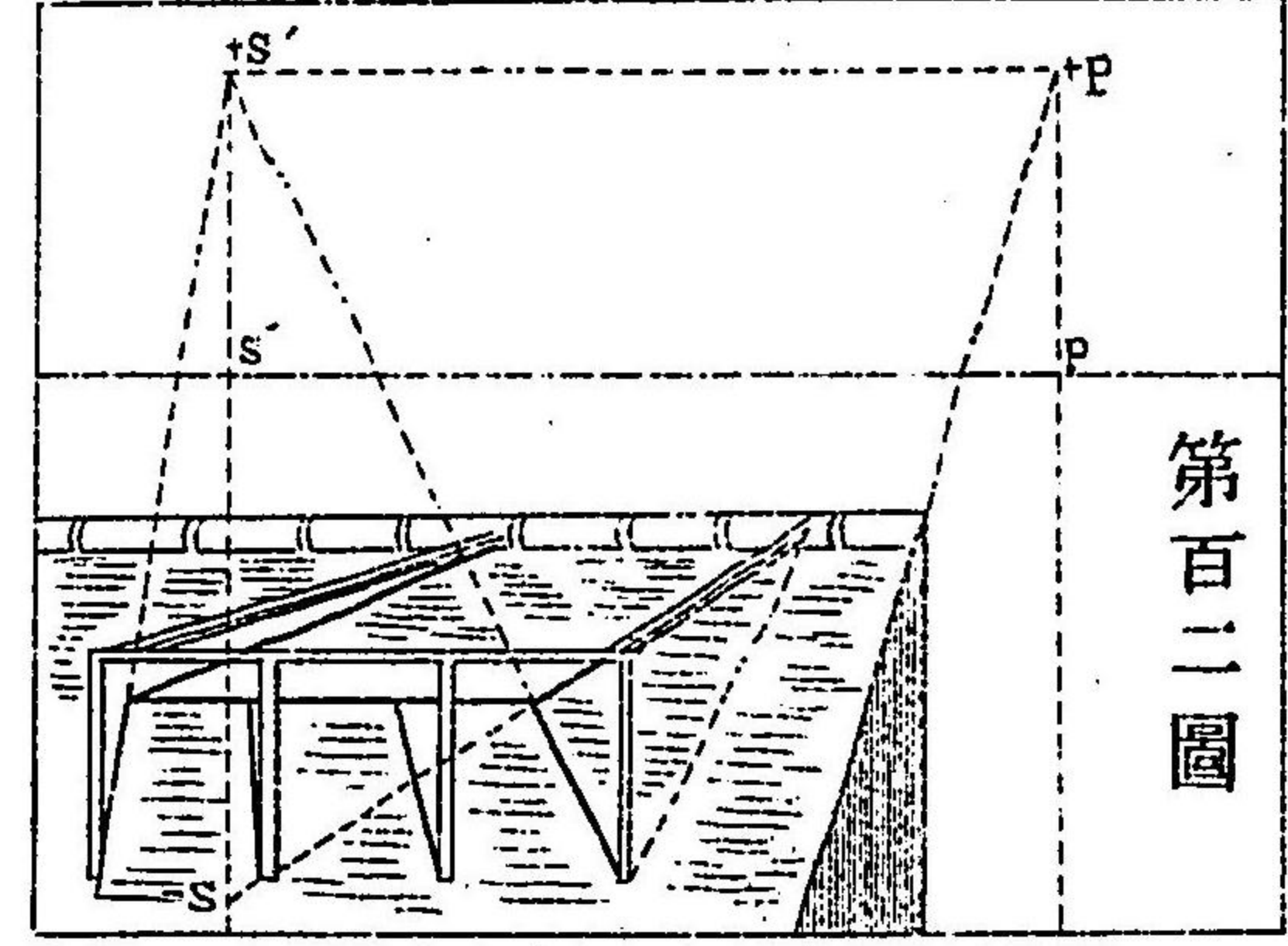
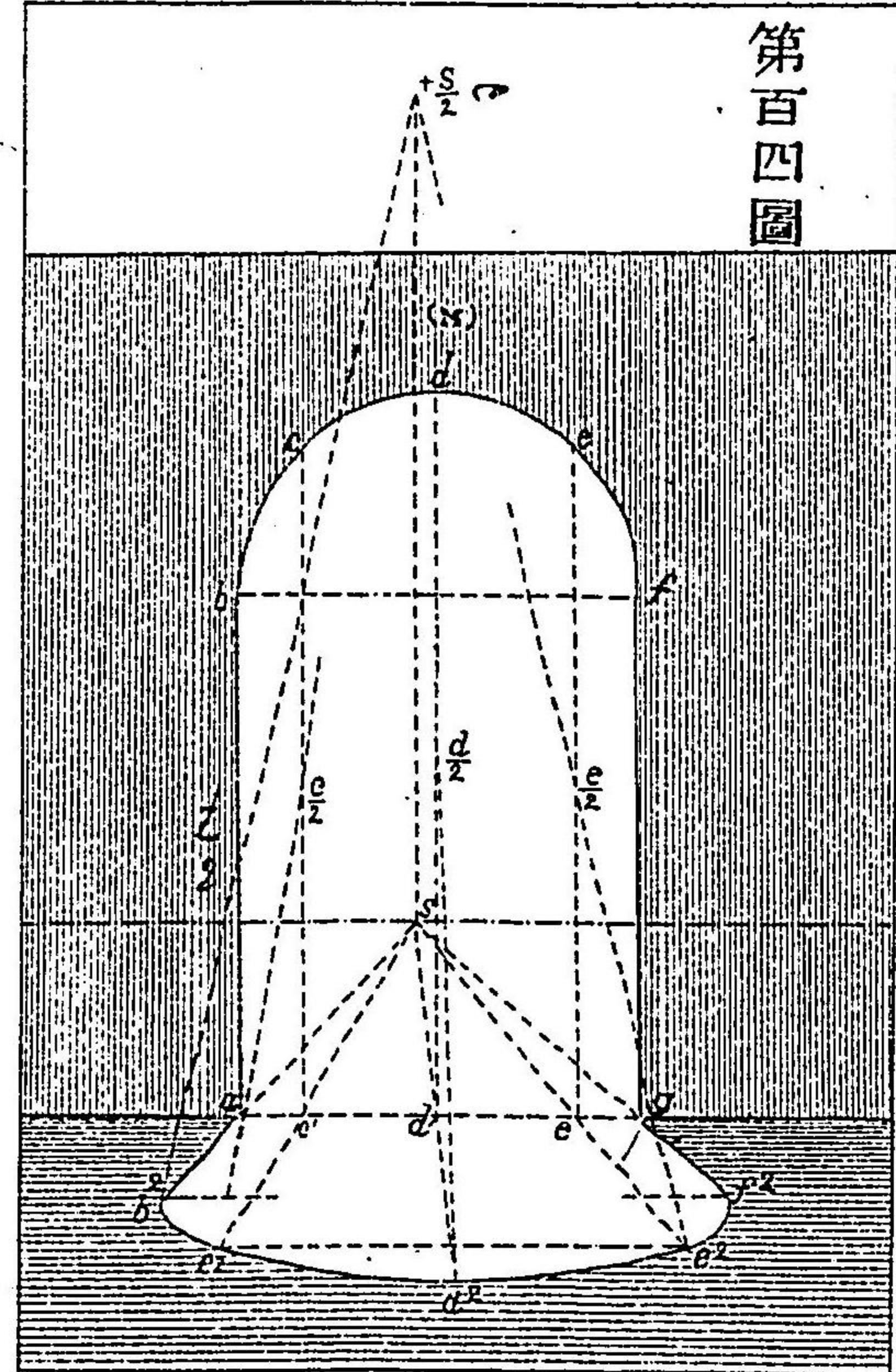
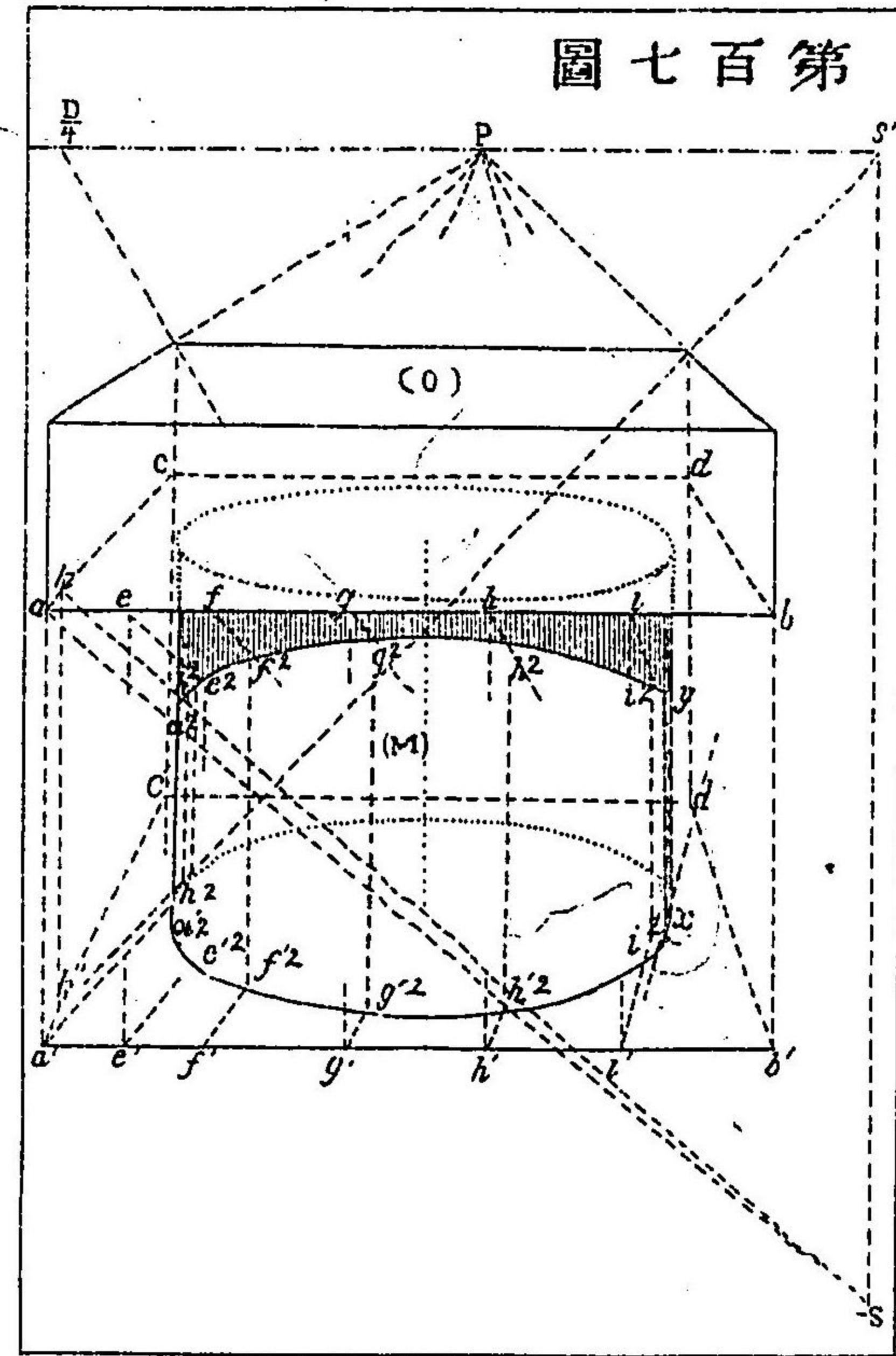

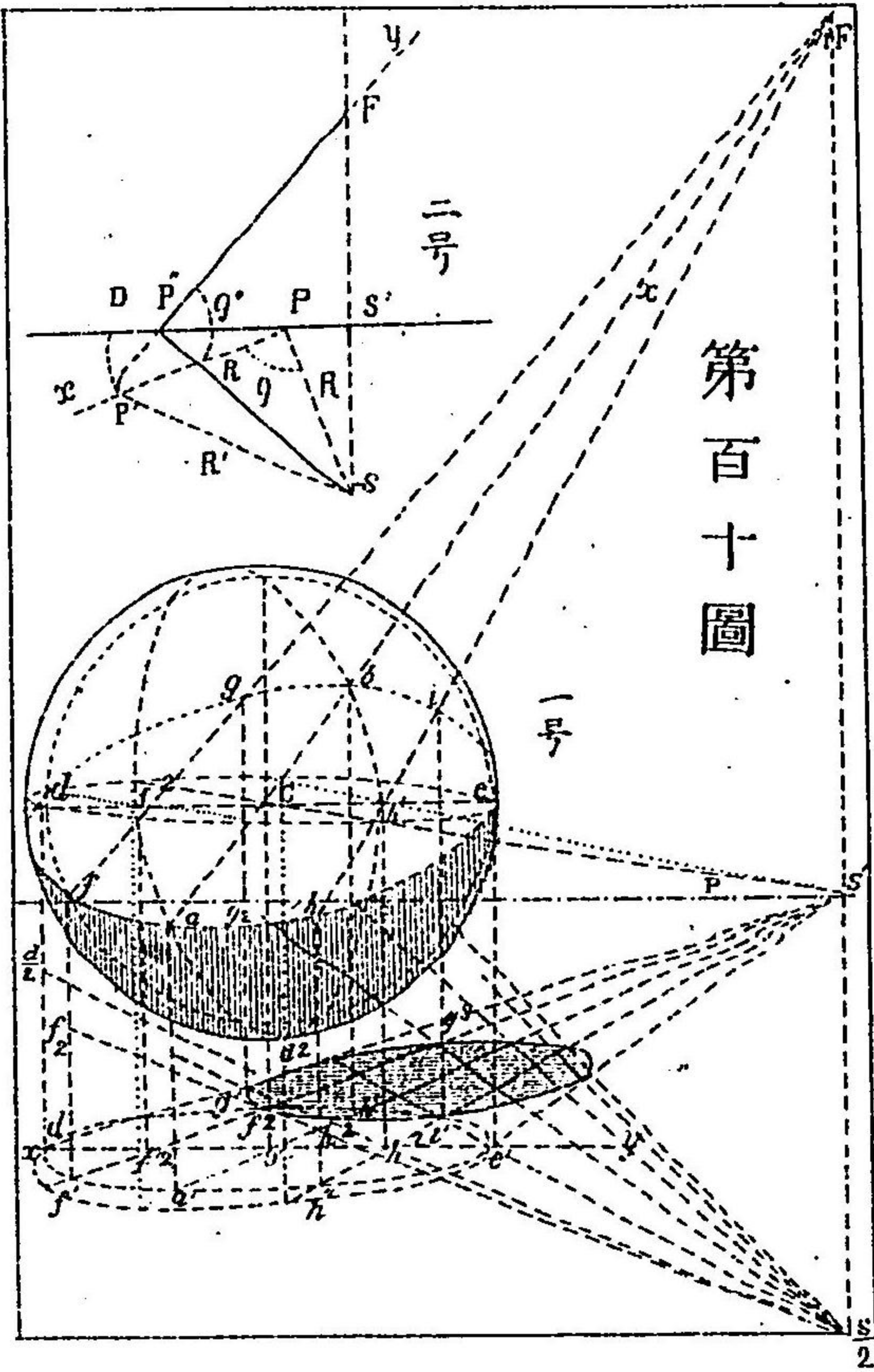

第一百圖

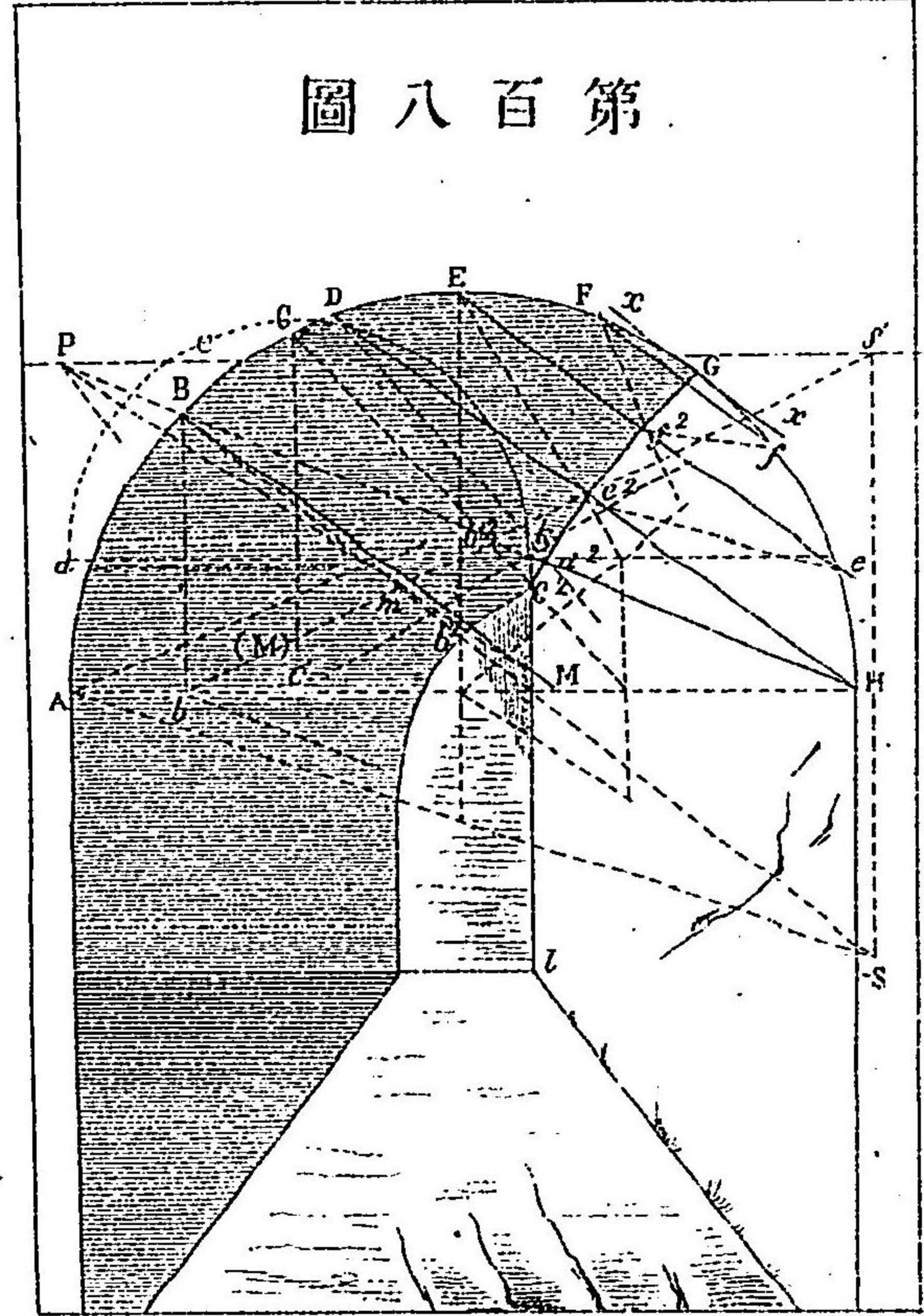

第八百圖

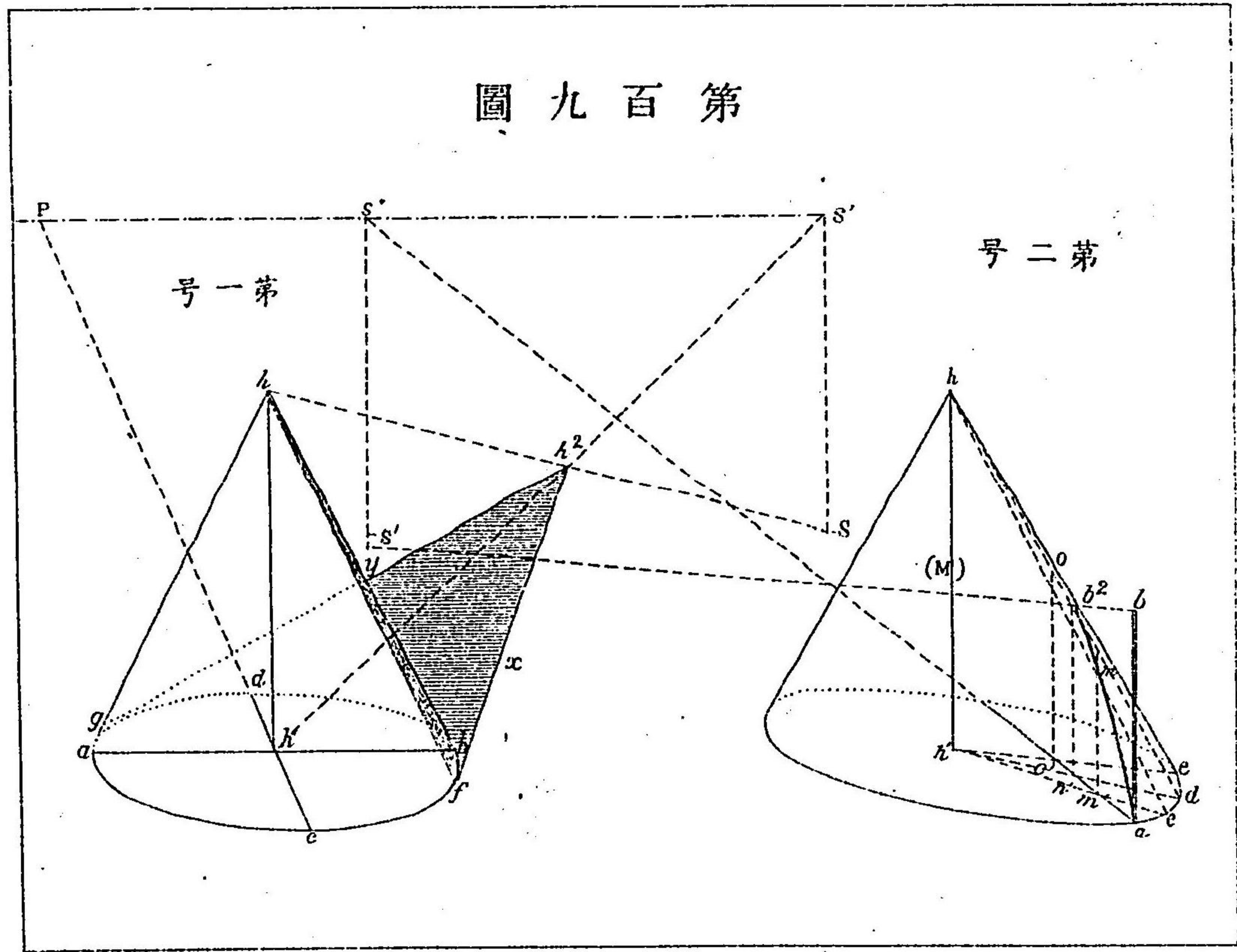

第九百圖

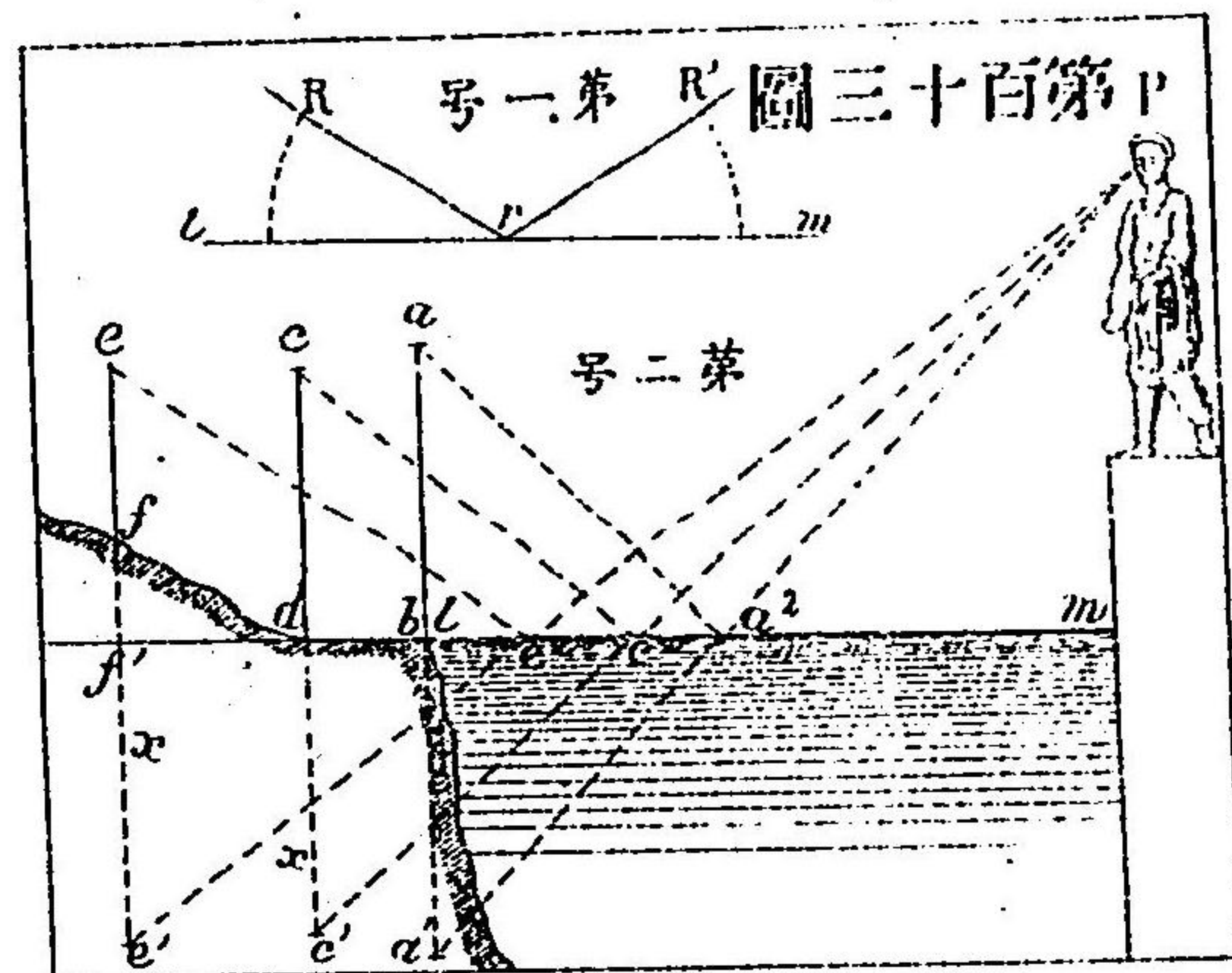
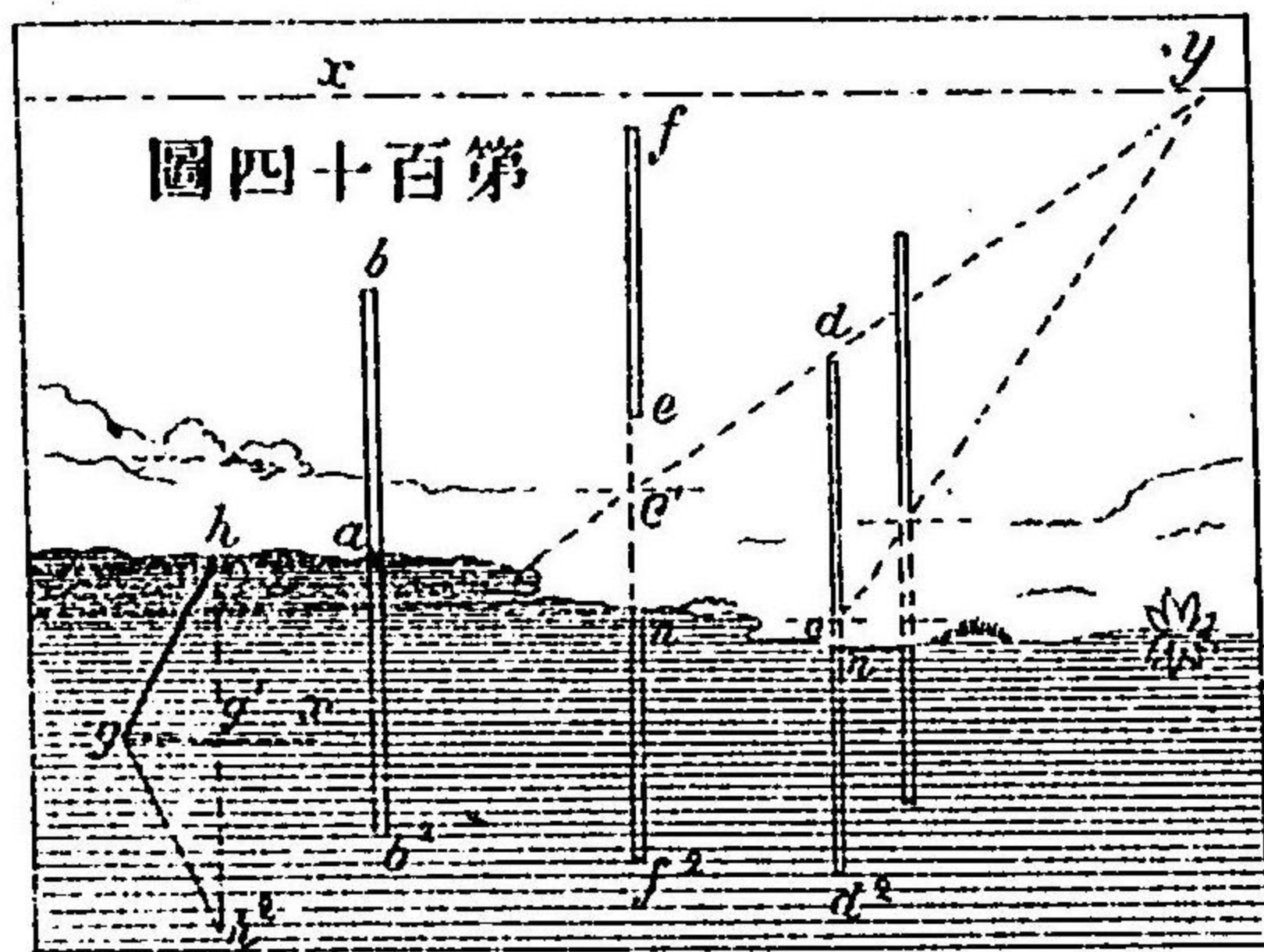
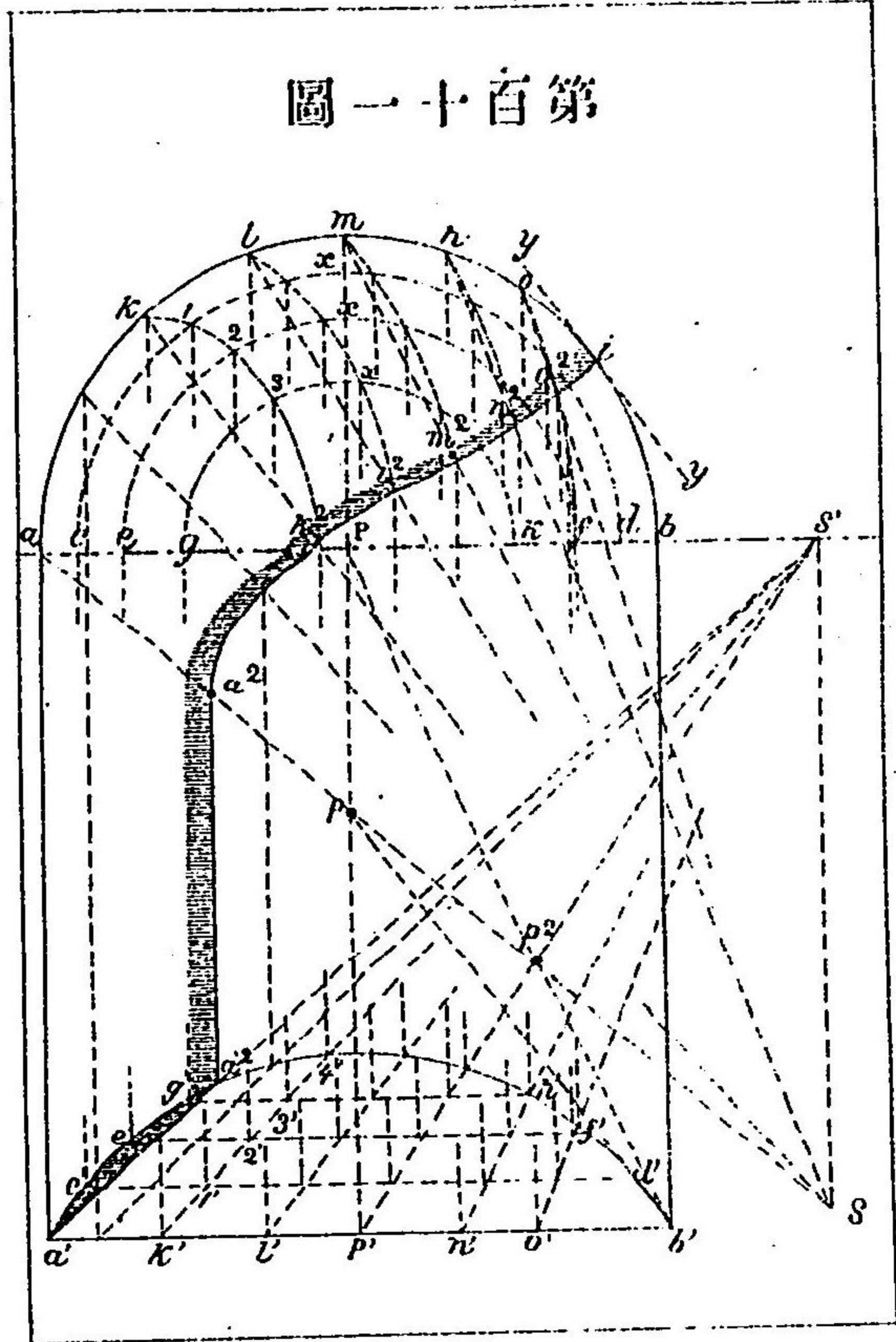
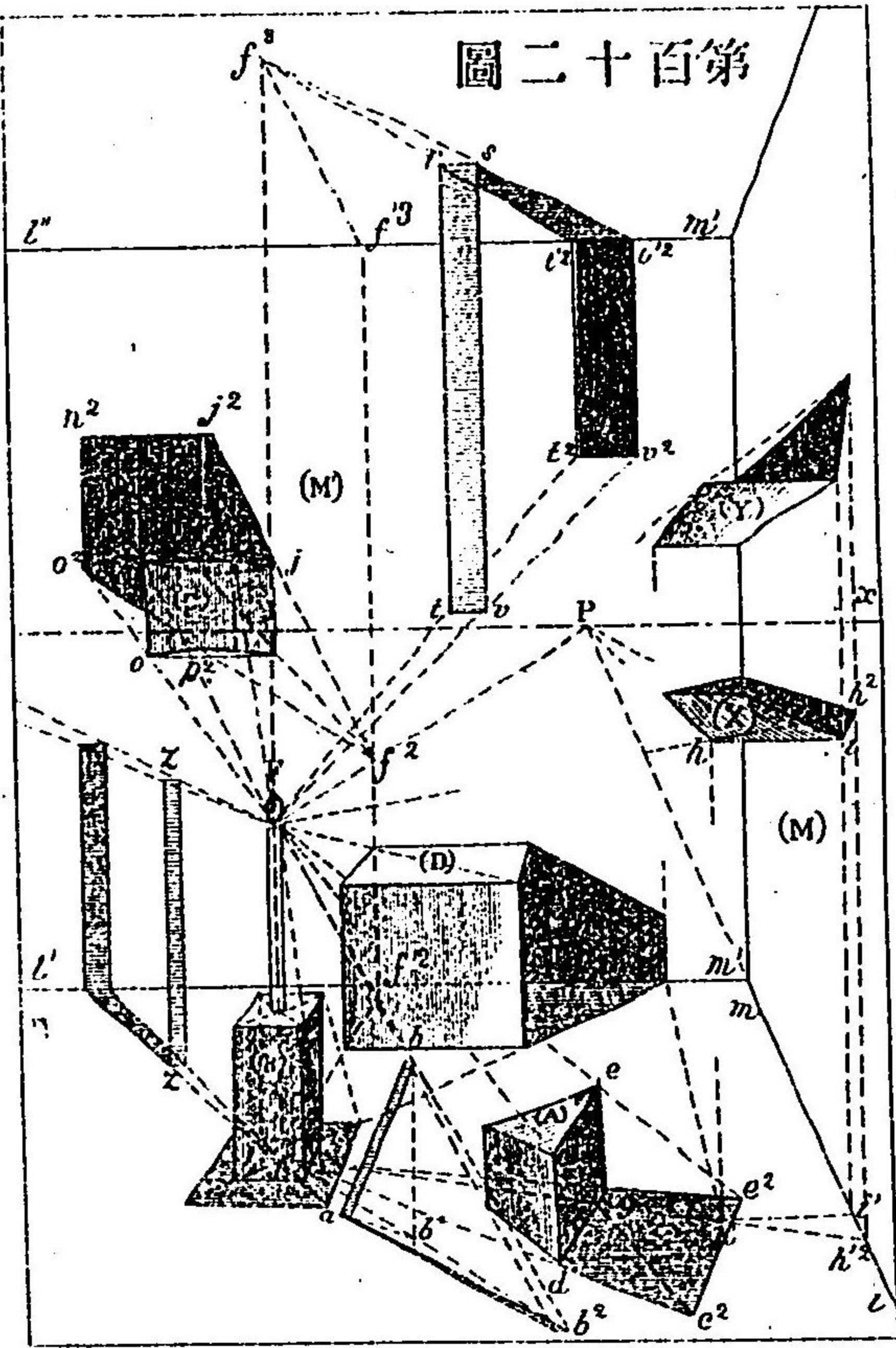

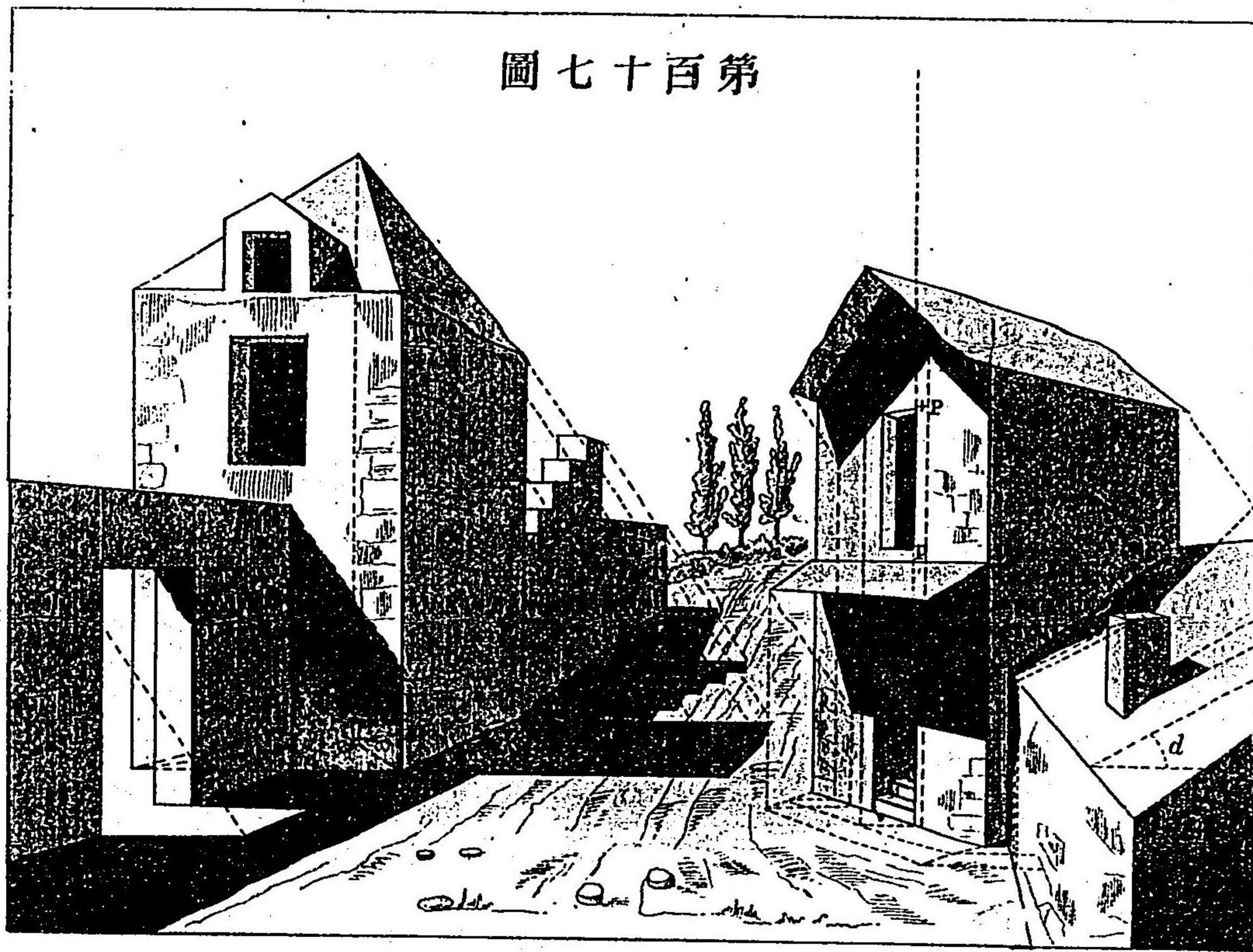
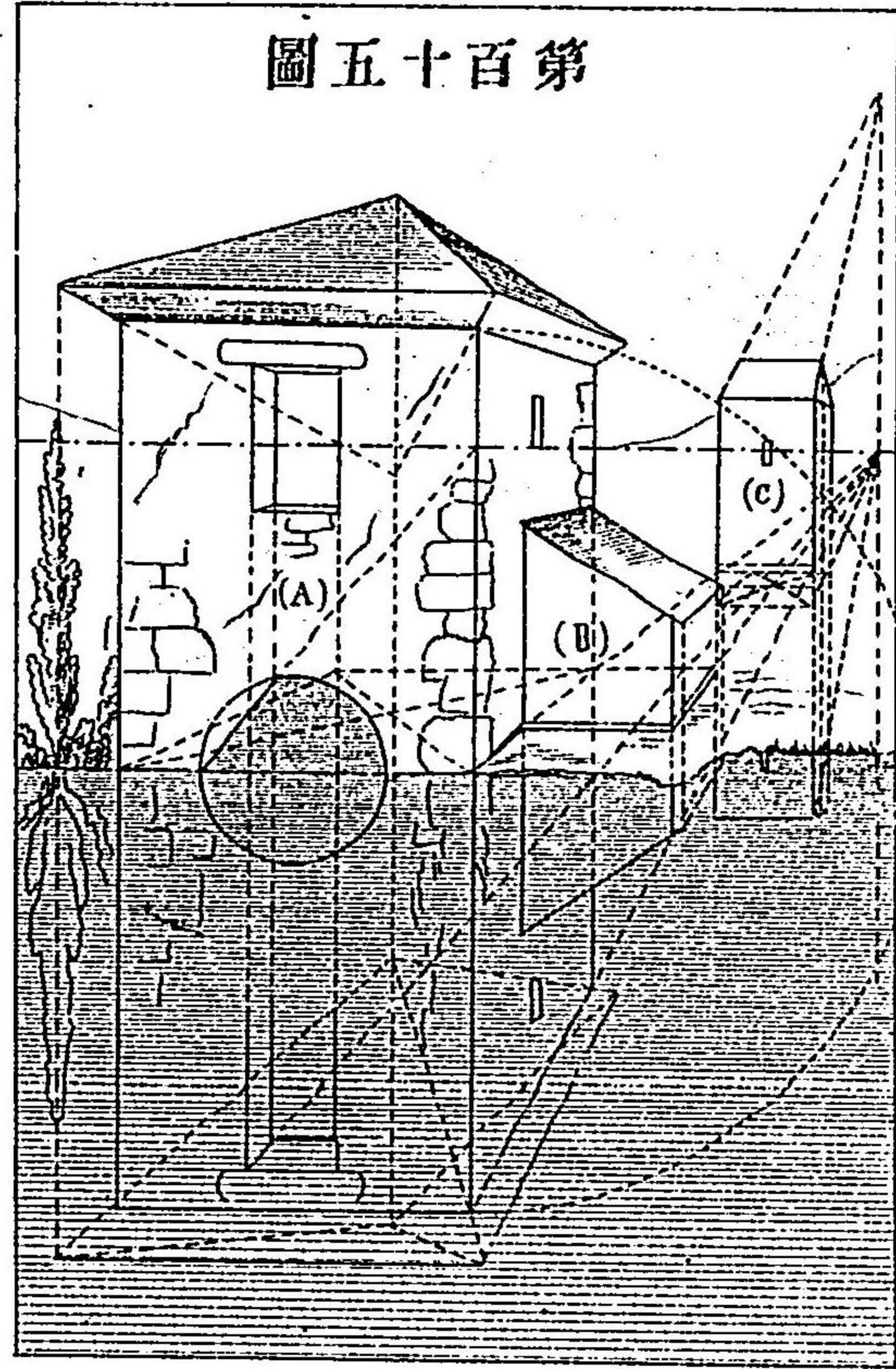
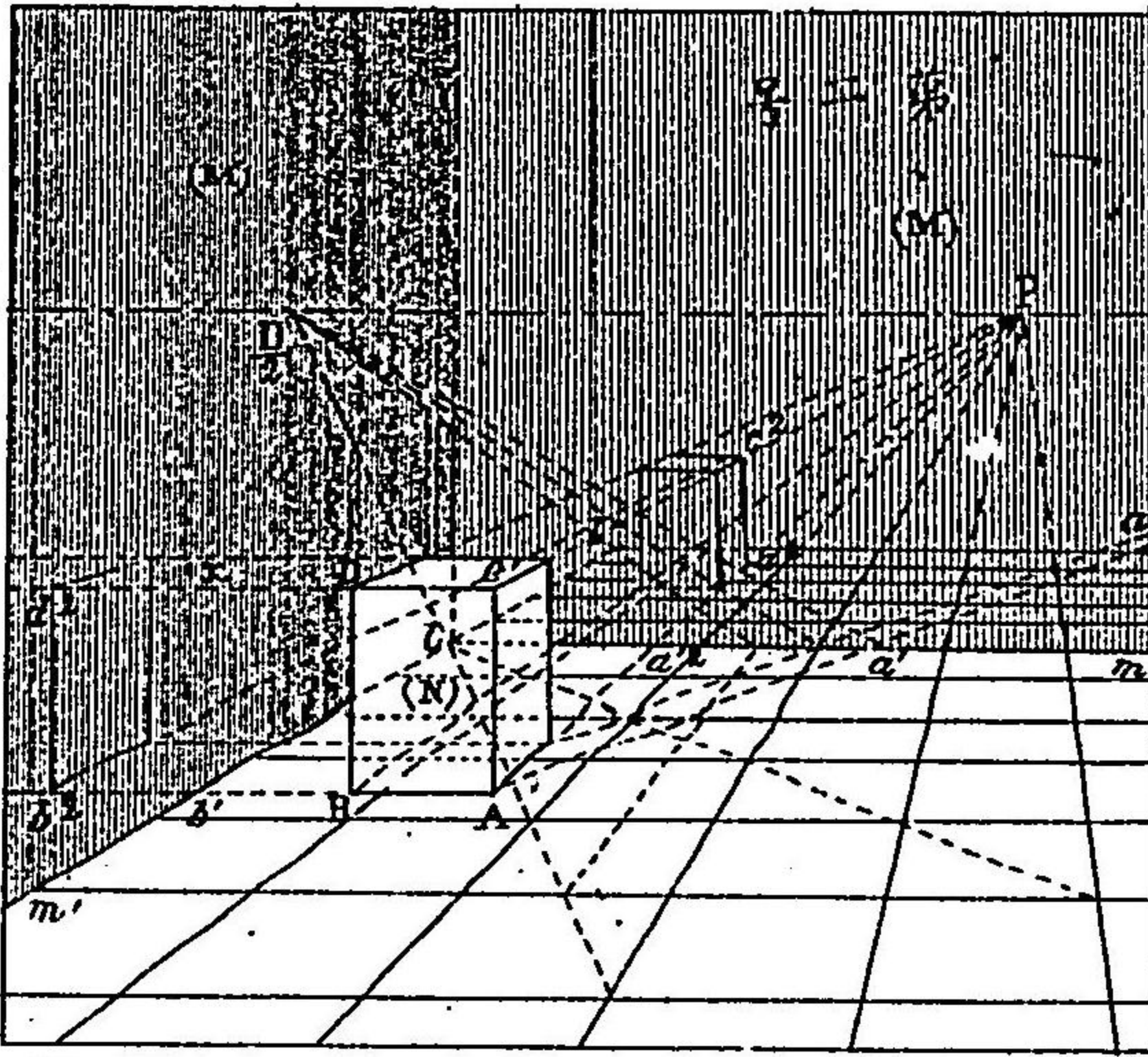
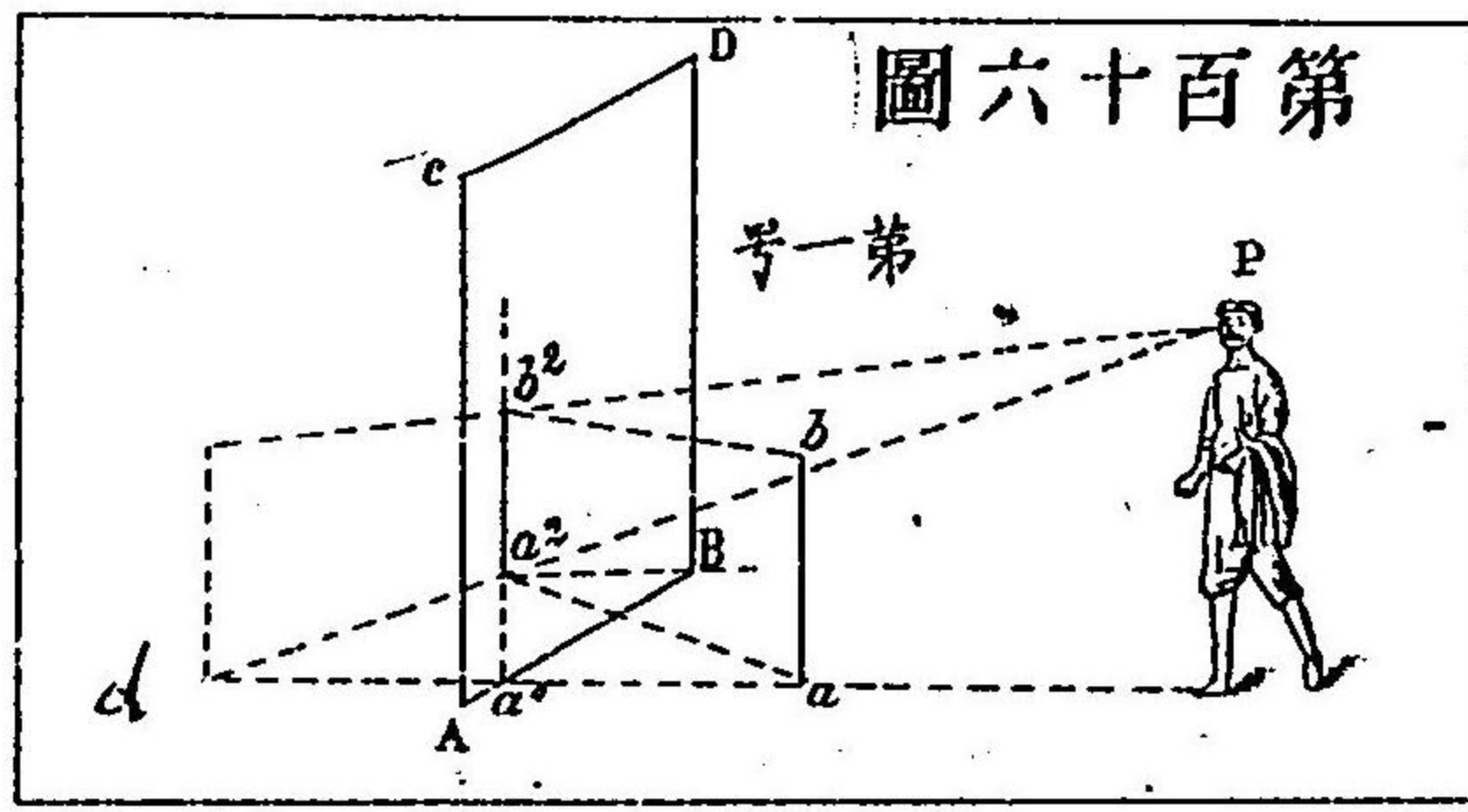

圖八十百第

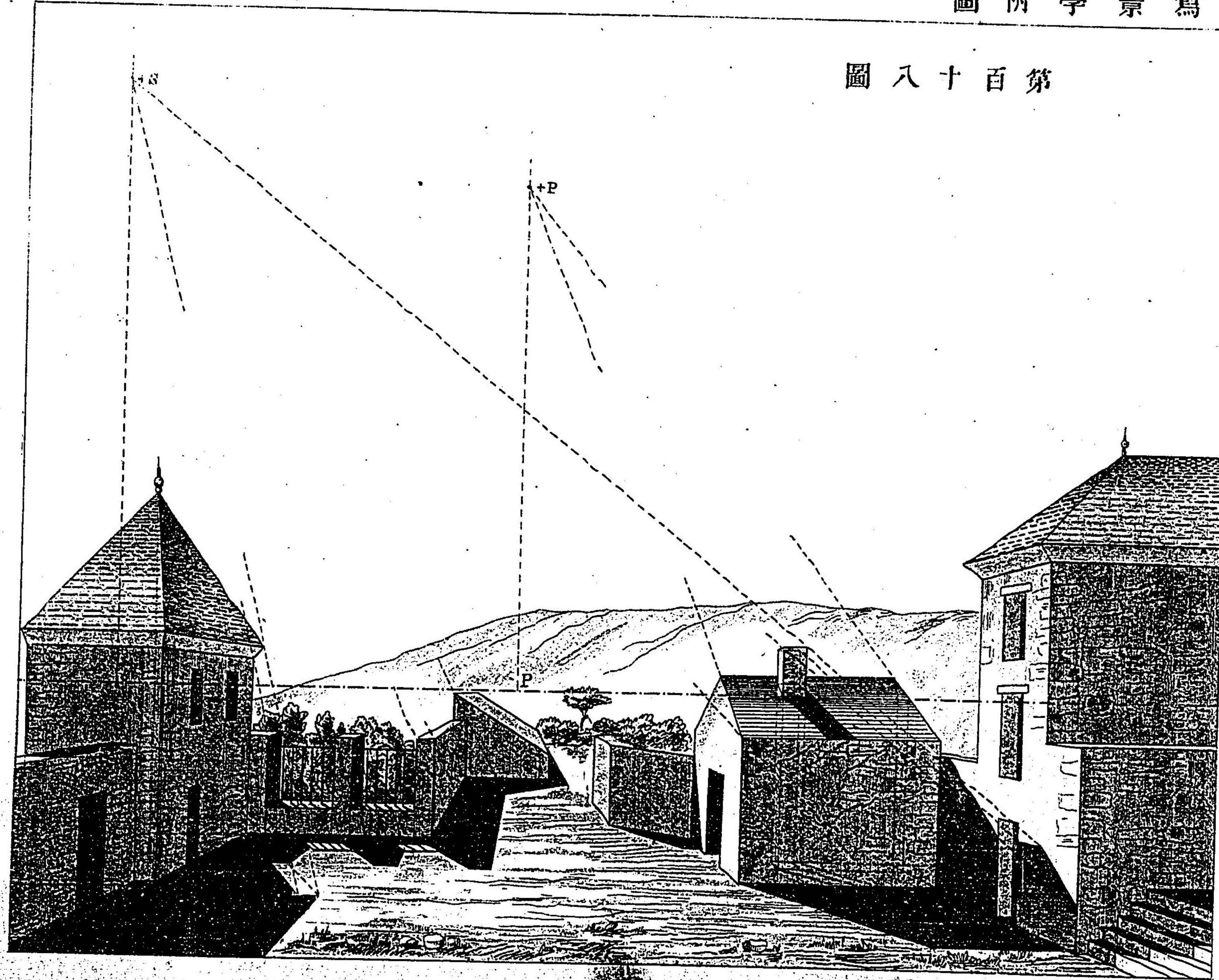

27/2/40

明治十七年十一月六日版權免許
同 十八年四月 出版



纂輯人

岡山縣士族
石丸三七郎
東京小石川厩高田老松町三番地

出版人

東京府士族
原亮三郎
東京日本橋區本町三丁目拾七番地

大坂唐物町四丁目

大賣捌

金港堂原亮三郎支店
岐阜韮屋町 兵庫港町

賣捌

金港堂支店
各府縣下代理大賣捌所

28

129

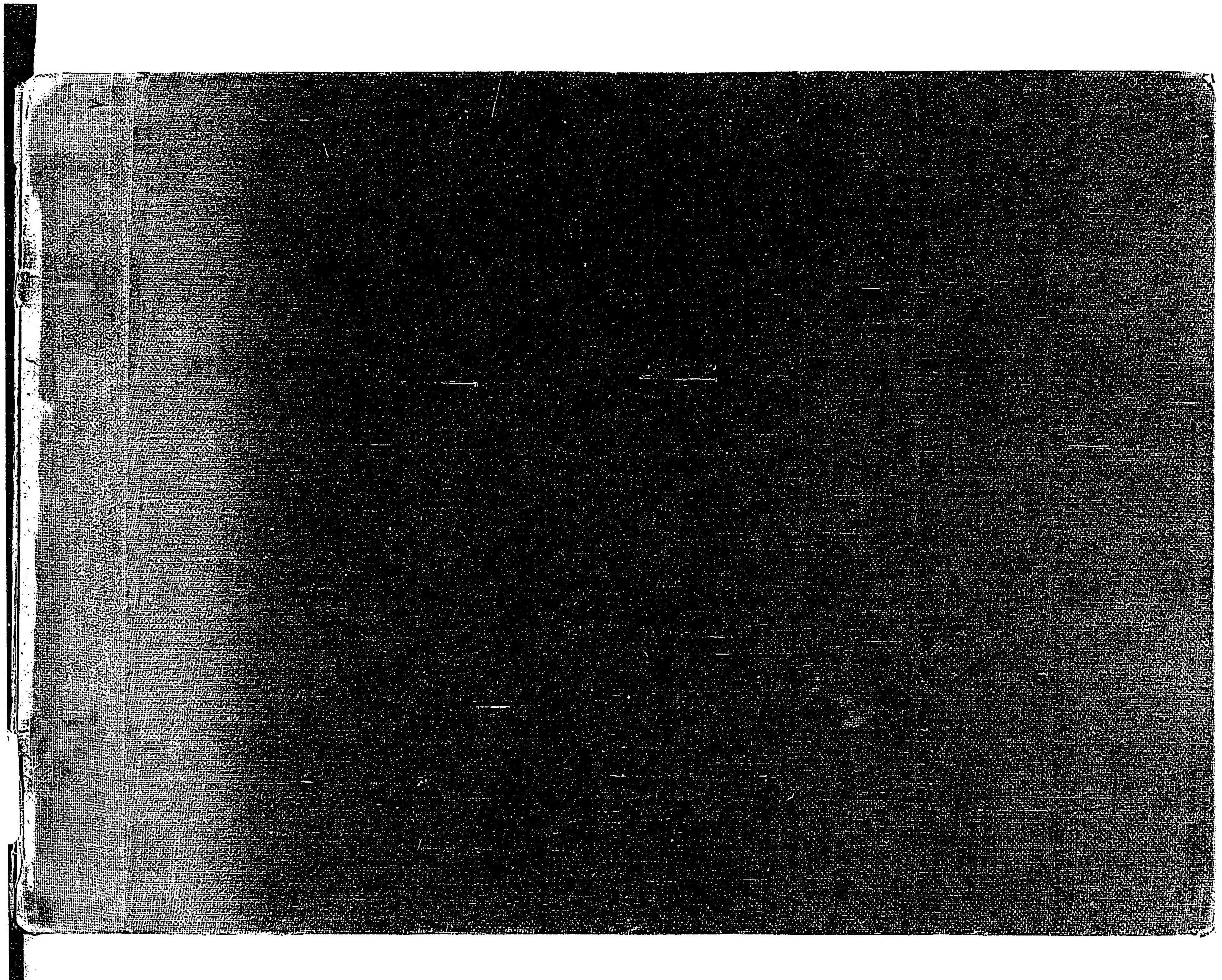

28
129

28
29-129

